



EVO/EVO+ VISIAN Implantable Collamer[®] Lens (EVO ICL[™]) for Myopia

For the correction/reduction of moderate to high myopia

AND

EVO/EVO+ VISIAN TORIC Implantable Collamer[®] Lens (EVO TICL[™]) for Myopia

For the correction/reduction of moderate to high myopic astigmatism

STAAR Surgical Company operates in compliance with the Medical Device Directive 93/42/EEC and ISO 13485

DIRECTIONS FOR USE

Manufactured and Distributed by

STAAR Surgical Company
1911 Walker Avenue
Monrovia, CA 91016
USA

Tel: (800) 352-7842
Fax: (800) 952-4923

CAUTION: U.S. (Federal) law restricts this device to sale by or on the order of a physician.

PRODUCT INFORMATION

Please review this product information completely before performing your initial clinical procedure. All physicians must complete the STAAR Surgical Visian ICL or Visian TICL lens Physician Certification Program prior to use.

DEVICE DESCRIPTION

The EVO ICL and EVO TICL lens (Implantable Collamer[®] Lens) is an intraocular implant manufactured from Collamer[®], a proprietary hydroxyethyl methacrylate (HEMA)/porcine collagen containing biocompatible polymer material. The EVO ICL lens contains a UV absorber made from a UV absorbing material. The lens features a plate-haptic design with a central convex/concave optical zone and a 0.36 mm diameter central port; the lens incorporates a forward vault to minimize contact of the ICL with the central anterior capsule.

While the parent devices (non-EVO/non-central port Visian MICL lens and Visian TICL lens) require preoperative peripheral iridotomies (PIs) to facilitate aqueous flow, the EVO/EVO+ ICL lenses include a central port that allows the flow of aqueous humor through the lens, thus eliminating the need for PIs prior to implantation.

The EVO ICL lens features an optic diameter that varies with the dioptric power; the smallest optic diameter being 4.9mm and the largest 6.1mm. The EVO ICL lens is capable of being folded and inserted into the posterior chamber through an incision of 3.5mm or less. The EVO ICL lens is intended to be placed entirely within the posterior chamber directly behind the iris and in front of the anterior capsule of the human crystalline lens. When correctly positioned, the EVO ICL lens functions as a refractive element to optically reduce moderate to high myopia with or without astigmatism.

Table 1: EVO ICL Models

Brand Name	Model Name	Spherical Power (D)	Overall Diameter (mm)	Optic Diameter (mm)	Haptic Design
EVO	VICMO12.1	-3.0 to -16.0	12.1	4.9 to 5.8	Flat, plate
EVO	VICMO12.6	-3.0 to -16.0	12.6	4.9 to 5.8	Flat, plate
EVO	VICMO13.2	-3.0 to -16.0	13.2	4.9 to 5.8	Flat, plate
EVO	VICMO13.7	-3.0 to -16.0	13.7	4.9 to 5.8	Flat, plate
EVO+	VICM5 12.1	-3.0 to -16.0	12.1	5.0 to 6.1	Flat, plate
EVO+	VICM5 12.6	-3.0 to -16.0	12.6	5.0 to 6.1	Flat, plate
EVO+	VICM5 13.2	-3.0 to -16.0	13.2	5.0 to 6.1	Flat, plate
EVO+	VICM5 13.7	-3.0 to -16.0	13.7	5.0 to 6.1	Flat, plate

Table 2: EVO TICL Models

Brand Name	Model Name	Spherical Equivalent (D)	Cylindrical Power (D)	Overall Diameter (mm)	Optic Diameter (mm)	Haptic Design
EVO	VTICMO12.1	-3.0 to -16.0	+1.0 to +4.0	12.1	4.9 to 5.8	Flat, plate
EVO	VTICMO12.6	-3.0 to -16.0	+1.0 to +4.0	12.6	4.9 to 5.8	Flat, plate
EVO	VTICMO13.2	-3.0 to -16.0	+1.0 to +4.0	13.2	4.9 to 5.8	Flat, plate
EVO	VTICMO13.7	-3.0 to -16.0	+1.0 to +4.0	13.7	4.9 to 5.8	Flat, plate
EVO+	VTICM5_12.1	-3.0 to -16.0	+1.0 to +4.0	12.1	5.0 to 6.1	Flat, plate
EVO+	VTICM5_12.6	-3.0 to -16.0	+1.0 to +4.0	12.6	5.0 to 6.1	Flat, plate
EVO+	VTICM5_13.2	-3.0 to -16.0	+1.0 to +4.0	13.2	5.0 to 6.1	Flat, plate
EVO+	VTICM5_13.7	-3.0 to -16.0	+1.0 to +4.0	13.7	5.0 to 6.1	Flat, plate

Figure 1: Collamer® ICL UV/Visible Spectrum

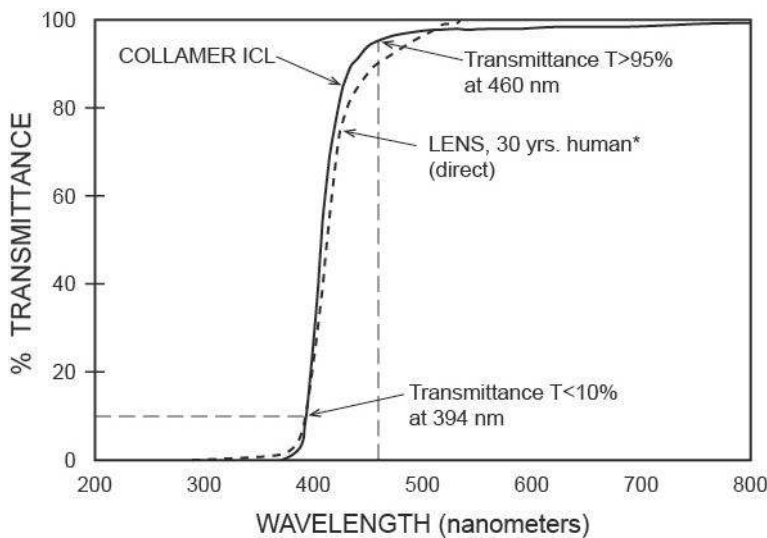

*Artigas J. M., Felipe A., Navea A., et al. Spectral Transmission of the Human Crystalline Lens in Adult and Elderly Persons: Color and Total Transmission of Visible Light. Investigative Ophthalmology & Visual Science. 2012;53 (7):4076-4084.

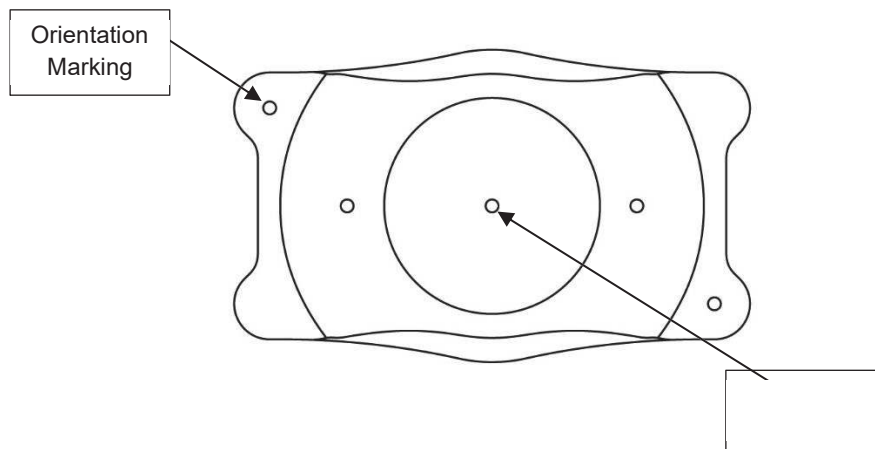

Figure 2: EVO/EVO+ ICL Lens Diagram

The ICL lens has orientation markings on the footplates to ensure the lens is implanted right side up. When correctly oriented the orientation markings will be on the leading right/trailing left footplates.

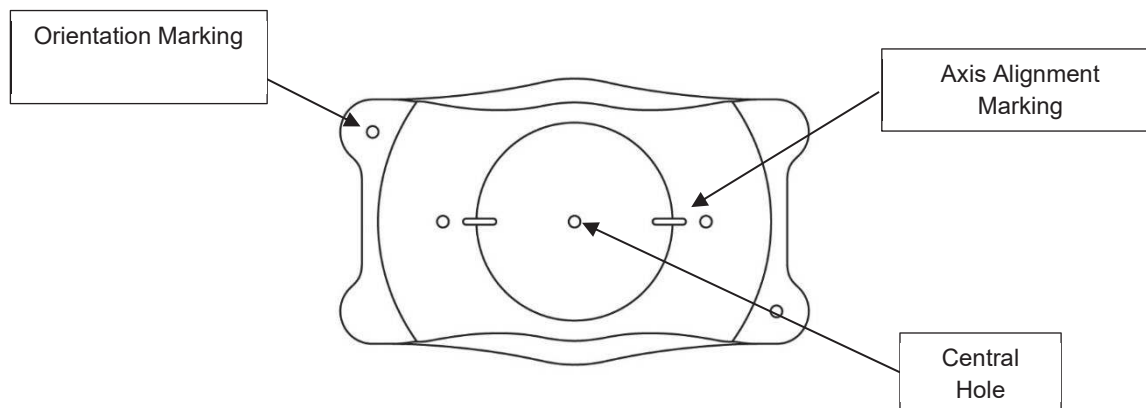

Figure 3: EVO/EVO+ TICL Lens Diagram

The EVO TICL lens (**Figure 3**) is labeled using a plus cylinder axis format. The lenses are labeled to the nearest degree and as such lenses of any axis between 1° to 180° may be held in inventory. The EVO TICL lens is designed to be rotated up to 22.5° clockwise or counterclockwise in order to align the lens axis at the preoperative plus cylinder axis. The lens has two axis alignment markings, one on each side of the optic, these are to aid with the alignment of the lens. The markings indicate the meridian from which the cylinder axis is measured and do not indicate the cylinder axis of the lens.

The EVO TICL lens has orientation markings on the footplates to ensure the lens is implanted right side up. When correctly oriented the orientation markings will be on the leading right/trailing left footplates.

The sphere component of the EVO TICL lens label indicates the spherical power and not the spherical equivalent power.

INDICATIONS

The EVO ICL lens is indicated for use in patients 21-45 years of age:

1. for the correction of myopia with spherical equivalent ranging from -3.0 D to \leq -15.0 D with less than or equal to 2.5 D of astigmatism at the spectacle plane;
2. for the reduction of myopia with spherical equivalent ranging from greater than -15.0 D to -20.0 D with less than or equal to 2.5 D of astigmatism at the spectacle plane;
3. with an anterior chamber depth (ACD) of 3.00 mm or greater, when measured from the corneal endothelium to the anterior surface of the crystalline lens, and a stable refractive history (within 0.5 D for 1 year prior to implantation).
4. The ICL lens is intended for placement in the posterior chamber (ciliary sulcus) of the phakic eye.

The EVO TICL lens is indicated for use in patients 21-45 years of age:

1. for the correction of myopic astigmatism with spherical equivalent ranging from -3.0 D to \leq -15.0 D (in the spectacle plane) with cylinder (spectacle plane) of 1.0 D to 4.0 D.
2. for the reduction of myopic astigmatism with spherical equivalent ranging from greater than -15.0 D to -20.0 D (in the spectacle plane) with cylinder (spectacle plane) 1.0 D to 4.0 D.
3. with an anterior chamber depth (ACD) of 3.00 mm or greater, when measured from the corneal endothelium to the anterior surface of the crystalline lens and a stable refractive history (within 0.5 D for both spherical equivalent and cylinder for 1 year prior to implantation).
4. The TICL lens is intended for placement in the posterior chamber (ciliary sulcus) of the phakic eye.

MODE OF ACTION

The ICL lens functions as a refractive element to optically reduce moderate to high myopia with or without astigmatism.

CONTRAINDICATIONS

The EVO ICL family of lenses is contraindicated in patients

1. with a true ACD of $<3.00\text{mm}^*$;
2. with anterior chamber angle less than Grade III as determined by gonioscopic examination;
3. who are pregnant or nursing;
4. less than 21 years of age;
5. who have moderate to severe glaucoma;
6. who do not meet the minimum endothelial cell density (ECD).

Table 3: Minimum Endothelial Cell Density for Age and True ACD*

Age	Minimum ECD ACD \geq 3.0mm	Minimum ECD ACD \geq 3.2mm	Minimum ECD ACD \geq 3.5mm
21-25	3875 cells/mm ²	3800 cells/mm ²	3250 cells/mm ²
26-30	3425 cells/mm ²	3375 cells/mm ²	2900 cells/mm ²
31-35	3025 cells/mm ²	2975 cells/mm ²	2625 cells/mm ²
36-40	2675 cells/mm ²	2625 cells/mm ²	2350 cells/mm ²
41-45	2350 cells/mm ²	2325 cells/mm ²	2100 cells/mm ²
>45	2075 cells/mm ²	2050 cells/mm ²	1900 cells/mm ²

*The true ACD is defined as the distance from the apex of the **posterior** corneal surface to the apex of the anterior crystalline lens surface. Many measuring devices provide an ACD measurement defined as the distance from the apex of the **anterior** corneal surface to the apex of the anterior crystalline lens surface. If the surgeon is using an instrument that measures from the anterior corneal surface, the thickness of the cornea must be subtracted to get the true ACD.

Table 3 indicates the minimum ECD per age group at time of implantation for three different ACD ranges. This data was developed as part of the STAAR ICL lens for Myopia Clinical Study (with the non-central port parent model ICL). This table was developed using rates of 2.47%, 2.44% and 2.15% (the upper 90% confidence interval of the average cell loss for eyes with the specified ACD) for the \geq 3.0mm, \geq 3.2mm, and \geq 3.5mm groups, respectively. It sets minimum ECD criteria as functions of age that should result in at least 1000 cells/mm² at 75 years of age. Specular microscopy should be performed preoperatively and ECD should be monitored postoperatively at intervals dictated by the physician's medical judgment.

WARNINGS

Note: All of these Warnings are applicable to the EVO ICL and EVO TICL

1. Some subjects in the STAAR ICL lens for Myopia Clinical Study (with the non-central port parent model ICL) demonstrated endothelial cell loss >30% (range, 30.9% to 42.6%) at 5-7 years postoperatively. The long term effects (beyond 5 – 7 years) on the corneal endothelium have not been established. Patients should be advised about the potential risk of corneal edema, possibly requiring corneal transplantation. Patients' ECD should be monitored periodically as long as they remain implanted with the ICL lens.
2. Secondary to implantation of the ICL lens, patients have increased risk of development of cataract, including visually significant cataract that continues to increase with each year. The physician should monitor the patient for cataract periodically. The long term risk of visually significant cataract and related secondary surgery may be higher in older patients and those with higher myopia. The long-term rate (beyond 5-7 years) of cataract formation secondary to implantation, removal and/or replacement of the ICL lens is unknown.
3. Implantation of the ICL lens is associated with an elevated risk of early postoperative increase in intraocular pressure (IOP). With the EVO ICL this is usually associated with incomplete removal of the OVD, but could also be caused by angle closure (associated with pupillary block and/or excessive ICL vault) that requires secondary surgical intervention. The risk of increased IOP due to incomplete removal of OVD can be mitigated by following the recommended OVD removal technique described briefly below (Intraoperative Information) and more fully in the ICL Physician Certification Program. IOP should be initially checked 1 – 6 hours postoperatively, so that increased IOP can receive treatment as quickly as possible. The long-term risks of glaucoma, peripheral anterior synechiae and pigment dispersion are not well established.
4. Do not attempt to resterilize or repackage the ICL lens.
5. Do not autoclave the ICL lens. Do not expose to temperature greater than 40°C. Do not freeze. If temperature requirements are not met, return the ICL lens to STAAR Surgical.
6. The iridocorneal angle distance may decrease after implantation of the ICL lens. Iridocorneal angle should be assessed 1 week after implantation and monitored if the angle is extremely narrow.
7. A patient with mesopic pupil size that is greater than the optic diameter of the ICL lens may experience symptoms of glare and/or halos. Patients should be advised about this potential risk prior to ICL lens implantation.
8. Complete removal of viscoelastic from the eye after completion of the surgical procedure is essential. STAAR Surgical recommends a low molecular weight 2% hydroxypropyl methylcellulose or dispersive, low viscosity ophthalmic viscosurgical device (OVD). Do not use short chain sodium hyaluronate acids (viscoelastics) due to increased risk of cataract formation related to trapped viscoelastic.

NOTE: The only viscoelastic used with the ICL lens during the clinical trial was a low molecular weight 2% hydroxypropyl methylcellulose preparation.

PRECAUTIONS

Prior to surgery, the surgeon must provide prospective patients with a copy of the patient information booklet for this product and inform these patients of the possible benefits and complications associated with the use of this device.

Note: All of these Precautions are applicable to the EVO ICL and EVO TICL

- Patients with higher degrees of myopia and/or myopic astigmatism experience lower efficacy and higher rates of adverse events (AEs) and complications.
- Inadequate flushing of the viscoelastic from the eye may lead to IOP spikes. IOP should be checked 1-6 hours postoperatively.
- The effectiveness of ultraviolet (UV) absorbing intraocular lenses (IOLs) in reducing the incidence of retinal disorders has not been established.
- The relationship between the ICL lens and retinal detachment is undetermined.
- If a method of power calculation different from that used in the ICL lens clinical study (i.e., lens power calculated by STAAR Surgical using STAAR's proprietary software) is used, the effectiveness of the ICL lens for myopia with or without astigmatism may not be consistent with the results reported in the ICL lens clinical study results section.
- The accuracy of ultra-sound based measurement of axial length in an eye with an ICL lens is unknown. Axial length measurements based upon partial coherence laser interferometry appear to not be significantly affected

by implantation of the ICL lens. See section on “Post-Approval Study of the Effect of the Visian ICL Lens on Axial Length Measurement.”

- In the TICL lens clinical study, surgeons were instructed to create one or two side port incisions, 60 - 90° away from the main incision, which should always be made at the horizontal temporal position. A 3.2mm clear corneal tunnel incision was constructed parallel to the iris plane, with a tunnel length of 1.5 to 1.75mm. If the surgeon uses a method of incision which is different from that used in the TICL lens clinical study, the postoperative astigmatic results may not be consistent with the results reported for the TICL lens clinical study, and the same precaution applies to implantation of EVO ICL and EVO TICL lenses. A temporal clear corneal tunnel incision of 3.5mm or less constructed parallel to the iris plane, with a tunnel length of 1.5 to 1.75mm, is recommended for implantation of EVO ICL and EVO TICL lenses.

The safety and effectiveness of the ICL lens for the correction of moderate to high myopia has **NOT** been established in patients with

1. greater than 20.0 D of myopia;
2. greater than 2.5 D of astigmatism for the EVO ICL lens, or
3. astigmatism less than 1.0D and greater than 4.0D for the EVO TICL lens;
4. unstable or worsening myopia;
5. a diagnosis of ocular hypertension or glaucoma;
6. pseudoexfoliation;
7. pigment dispersion;
8. history or clinical signs of iritis/uveitis;
9. insulin-dependent diabetes or diabetic retinopathy;
10. history of previous ocular surgery;
11. progressive sight-threatening disease other than myopia;
12. serious (life-threatening) non-ophthalmic disease.

ADVERSE EVENTS

A list of adverse events associated with the EVO ICL and EVO TICL is provided below. Additionally, the location for specific adverse event data from the EVO ICL /EVO TICL, TICL PMA and Myopia ICL (MICL) clinical studies is provided. For some events, the greatest detail is provided in the section that includes the adverse event data from the MICL clinical studies (pre-approval study and extended follow-up post-approval study with the non-central port parent model ICL).

Table 4: Adverse Events

Adverse Event	For more information please refer to:
Implantation of the EVO ICL can be associated with insufficient EVO ICL vaulting over the crystalline lens, which can lead to anterior subcapsular opacities or clinically significant cataracts	EVO/EVO+ VISIAN ICL LENS PMA CLINICAL TRIAL AND RESULTS: Adverse Events and Complications TICL DFU: PMA CLINICAL TRIAL AND RESULTS: Adverse Events and Complications MICL DFU: ADDITIONAL CLINICAL DATA: Lens Opacity and Visually Significant Cataract Formation
Implantation of the EVO ICL can be associated with excessive EVO ICL vaulting, which can cause a narrowing of the anterior chamber angle, possible pupillary block, increased intraocular pressure and glaucoma	EVO/EVO+ VISIAN ICL PMA CLINICAL TRIAL AND RESULTS: Adverse Events and Complications TICL PMA CLINICAL TRIAL AND RESULTS: Adverse Events and Complications MICL ADDITIONAL CLINICAL DATA: <ul style="list-style-type: none"> • Adverse Events • Surgical Reinterventions • Intraocular Pressure
Implantation of the EVO ICL is associated with an increased rate of	EVO/EVO+ VISIAN ICL PMA CLINICAL TRIAL AND RESULTS: Adverse Events and Complications

Adverse Event	For more information please refer to:
chronic corneal endothelial cell loss, which may, over a period of time, lead to corneal edema and possibly the need for a corneal transplant	<p>TICL DFU CLINICAL TRIAL AND RESULTS: Adverse Events and Complications</p> <p>MICL ADDITIONAL CLINICAL DATA:</p> <ul style="list-style-type: none"> • Adverse Events • Endothelial Cell Density
EVO ICL may move out of its appropriate position	<p>EVO/EVO+ VISIAN ICL PMA CLINICAL TRIAL AND RESULTS: Adverse Events and Complications</p> <p>TICL PMA CLINICAL TRIAL AND RESULTS: Visian TICL Related Additional Surgery</p> <p>MICL ADDITIONAL CLINICAL DATA: Surgical Reintervention</p>
There may be a need for secondary surgery for EVO ICL removal, replacement, or repositioning	<p>EVO/EVO+ VISIAN ICL PMA CLINICAL TRIAL AND RESULTS: Adverse Events and Complications</p> <p>TICL PMA CLINICAL TRIAL AND RESULTS: Visian TICL Related Additional Surgery</p> <p>MICL ADDITIONAL CLINICAL DATA: Surgical Reintervention</p>
There may be a need for other types of secondary surgical intervention to treat some adverse events	<p>EVO/EVO+ VISIAN ICL PMA CLINICAL TRIAL AND RESULTS: Adverse Events and Complications</p> <p>TICL PMA CLINICAL TRIAL AND RESULTS: Adverse Events and Complications</p> <p>MICL ADDITIONAL CLINICAL DATA: Surgical Reintervention</p>
There may be a loss of best spectacle-corrected visual acuity	<p>EVO/EVO+ VISIAN ICL PMA CLINICAL TRIAL AND RESULTS: Adverse Events and Complications</p> <p>TICL PMA CLINICAL TRIAL AND RESULTS: Adverse Events and Complications</p> <p>MICL ADDITIONAL CLINICAL DATA: Best Corrected Distance Visual Acuity (CDVA) Loss</p>
Implantation of the EVO ICL may cause an increase in refractive astigmatism	<p>EVO/EVO+ VISIAN ICL PMA CLINICAL TRIAL AND RESULTS: Adverse Events and Complications</p> <p>TICL PMA CLINICAL TRIAL AND RESULTS: Refractive Cylinder (Target Variance) Distribution</p>
The EVO ICL may be associated with pigment dispersion and iris transillumination defects	<p>EVO/EVO+ VISIAN ICL PMA CLINICAL TRIAL AND RESULTS: Adverse Events and Complications</p> <p>MICL ADDITIONAL CLINICAL DATA: Slit Lamp Findings</p>
As with implantation of other types of intraocular lenses, potential adverse events can include, but are not limited to infection (endophthalmitis), hypopyon, corneal endothelial damage, IOL dislocation, cystoid macular edema, corneal edema, pupillary block, iritis, retinal detachment, retinal tear, transient or persistent glaucoma, vitritis, iris prolapse, secondary surgical intervention and increased visual	<p>EVO/EVO+ VISIAN ICL PMA CLINICAL TRIAL AND RESULTS: Adverse Events and Complications</p> <p>TICL PMA CLINICAL TRIAL AND RESULTS: Adverse Events and Complications</p> <p>TICL PMA CLINICAL TRIAL AND RESULTS: Optical Visual Symptoms</p> <p>TICL PMA CLINICAL TRIAL AND RESULTS: Subjective Symptoms Stratified by Optic Diameter</p> <p>MICL ADDITIONAL CLINICAL DATA: Surgical Reintervention</p>

Adverse Event	For more information please refer to:
symptoms related to the optical characteristics of the IOL including halos, glare and/or double vision	
Secondary surgical interventions may include, but are not limited to lens repositioning, lens replacement, vitreous aspiration, iridotomy/iridectomy for pupillary block, wound leak repair, retinal detachment repair and corneal transplantation	<p>EVO/EVO+ VISIAN ICL PMA CLINICAL TRIAL AND RESULTS: Adverse Events and Complications</p> <p>TICL PMA CLINICAL TRIAL AND RESULTS: Visian TICL Related Additional Surgery</p> <p>MICL ADDITIONAL CLINICAL DATA: Surgical Reintervention</p> <p>MICL ADDITIONAL CLINICAL DATA: Other Complications</p>

CLINICAL TRIALS AND RESULTS

Data from a clinical study of the EVO/EVO+ ICL lens and data from prior clinical studies of the parent Visian MICL lens and Visian TICL lens are included to support the safety and effectiveness of the EVO/EVO+ ICL lens. These include the following:

A clinical study of the EVO/EVO+ ICL lens demonstrating the safety and effectiveness of the modification of the previously approved Visian TICL and Visian MICL lenses by the addition of the central port.

A clinical study of the Visian TICL lens, demonstrating the safety and effectiveness of the modification of the previously approved Visian MICL lens model by the addition of a toric optic.

Clinical studies of the parent Visian MICL lens including the primary safety and effectiveness study and three post-approval studies: (1) extended follow-up of the pre-approval cohort to further characterize safety; (2) a new enrollment patient survey study to collect safety information from patients, and; (3) a post-approval study to assess the effect of the ICL lens on axial length measurement.

The EVO/EVO+ Visian ICL lens was evaluated in a prospective nonrandomized clinical study in 629 eyes of 327 subjects. The parent Visian TICL lens was evaluated in a prospective nonrandomized clinical study of 210 eyes of 124 subjects. The parent Visian MICL lens was evaluated in a prospective nonrandomized study of 526 eyes of 294 subjects and three post-approval studies: (1) extended follow-up of the pre-approval cohort to further characterize safety; (2) a new enrollment patient survey study to collect safety information from patients, and; (3) a post-approval study to assess the effect of the ICL lens on axial length measurement.

EVO/EVO+ VISIAN ICL PMA CLINICAL TRIAL AND RESULTS

This section includes clinical data on the EVO/EVO+ ICL lenses from a U.S. clinical study of these lenses.

PMA CLINICAL TRIAL AND RESULTS – EVO/EVO+ VISIAN ICL LENS FOR MYOPIA and MYOPIA WITH ASTIGMATISM

The EVO and EVO+ sphere and toric Visian ICL lenses have been evaluated through 6 months postoperative in a prospective nonrandomized single arm, three year study enrolling 629 eyes of 327 subjects. The primary analysis for the study was to occur after a minimum of 300 primary eyes completed the Month 6 Visit. Subject follow-up will continue through 3 years to obtain long-term data on clinical performance. The purpose of the study is to evaluate the safety, and to collect supportive data concerning the effectiveness of the EVO/EVO+ sphere and toric Visian ICL lenses. Study subjects with moderate-to high myopia ranging from -3.00 to -20.00 D spherical equivalent (SE) in the spectacle plane or moderate to high myopic astigmatism with SE ranging from -3.00 to -20.00 D (in the spectacle plane) and cylinder ranging from 1.00 D to 4.00 D of cylinder (in the spectacle plane), with preoperative best spectacle corrected visual acuity (CDVA) of 20/40 or better and no pre-existing progressive sight-threatening ocular disorders other than pathological refractive error were eligible for the study.

The primary study (safety) endpoints were evaluated in primary (first eye treated) eyes only:

- Incidence of peripheral iridotomy (PI) required to treat elevated IOP caused by mechanical pupillary block through Month 6 Visit.
- Distribution of percent ECD losses and the percent of eyes that had ECD <1500 cells/mm² and ECD < 1000 cells/mm² through Month 6 visit (no prespecified performance target).
- Incidence of AEs through Month 6 Visit (no prespecified performance target).

Secondary (safety) endpoints were evaluated in all eyes (primary and fellow eyes) and have no prespecified performance targets:

- Incidence of PI required to treat elevated IOP caused by mechanical pupillary block through Month 6 Visit
- Distribution of percent ECD losses and the percent of eyes that had ECD <1500 cells/mm² and ECD <1000 cells/mm² through Month 6 Visit
- Incidence of AEs through Month 6 Visit

Effectiveness endpoints for this study have no prespecified performance targets:

- MRSE within ± 0.50 D and ± 1.00 D of target at Month 6 Visit
- UDVA of 20/40 or better at Month 6 Visit (for those eyes with CDVA 20/20 or better at Preoperative/Screening Visit)
- CDVA through Year 3 Visit (Day 1050 – 1170)

Demographics of the Study Cohort are presented in Table 5.

Table 5: Demographics

Demographics	Subjects (N=327) n (%)
Gender	
Male	114 (34.9)
Female	213 (65.1)
Race	
Caucasian	274 (83.8)
African American/Black	11 (3.4)
Asian	38 (11.6)
Native Hawaiian or Other Pacific Islander	3 (0.9)
American Indian or Alaska Native	1 (0.3)
Ethnicity	
Hispanic or Latino	34 (10.4)
Not Hispanic or Latino	293 (89.6)
Age (years)	
Mean (SD)	35.6 (5.1)
Median	36.0
Min, Max	22, 45

*Percentage calculated as (n/N)*100.

Accountability

A total of 327 patients (327 primary and 302 fellow eyes, 629 total eyes) were enrolled and underwent EVO ICL implantation in this study. One subject was discontinued from the study following lens explantation due to complaint of glare and halos. The interim analysis for PMA P030016/S035 included 303 primary eyes and 266 fellow eyes (569 total eyes) that completed the Month 6 visit. An update of safety data was submitted after all remaining treated eyes completed the Month 6 visit. Therefore, the safety data provided below includes all implanted eyes. Effectiveness data were not updated after all eyes completed the Month 6 visit; effectiveness data presented in this document are

based on the 303 primary eyes (569 total eyes) that completed the Month 6 visit included in the interim analysis. Subject follow-up will continue through 3 years to obtain long-term data on clinical performance.

Table 6 provides accountability for primary eyes and **Table 7** provides accountability for all eyes treated in the study.

Table 6: Accountability – Primary Eyes

Eye Status	Total #	Op Visit (Day 0) n (%)	Postop V1 (Day 1) n (%)	Postop V2 (Day 5-9) n (%)	Postop V3 (Day 21-35) n (%)	Postop V4 (Day 70-98) n (%)	Postop V5 (Day 147-182) n (%)	Postop V6 (Day 330-420) n (%)
All eyes treated (N)	327							
Available for analysis		327 (100.0)	327 (100.0)	325 (99.4)	325 (99.4)	324 (99.1)	321 (98.2)	42 (12.8)
Missing eye/data								
Discontinued		0 (0.0)	0 (0.0)	0 (0.0)	0 (0.0)	1 (0.3)	1 (0.3)	1 (0.3)
Missing at scheduled visit but seen earlier/later ¹		0 (0.0)	0 (0.0)	0 (0.0)	9 (2.8)	2 (0.6)	7 (2.1)	1 (0.3)
Missing but accounted for ²		0 (0.0)	0 (0.0)	2 (0.6)	2 (0.6)	1 (0.3)	3 (0.9)	12 (3.7)
Lost to follow-up		0 (0.0)	0 (0.0)	0 (0.0)	0 (0.0)	1 (0.3)	2 (0.6)	2 (0.6)
Active ³		0 (0.0)	0 (0.0)	0 (0.0)	0 (0.0)	0 (0.0)	0 (0.0)	270 (82.6)
% Accountability ⁴		327/327 (100.0)	327/327 (100.0)	325/327 (99.4)	325/327 (99.4)	324/326 (99.4)	321/326 (98.5)	42/56 (75.0)

¹ Missing at scheduled visit but seen earlier/later: represents the total number of eyes that were seen outside the time window associated with the visit.

² Missing but accounted for: represents the total number of eyes that missed the visit but have not been discontinued/lost to follow-up.

³ Active: represents the total number of eyes that have not reached the time associated with the visit. The investigation at the visit is considered complete when the number of active eyes is zero.

⁴ % Accountability = [Available for Analysis/(Treated-Discontinued-Active)].

The denominator for percentages is the number of treated eyes. Percentage calculated as (n/N)*100.

Table 7: Accountability – All Eyes

Eye Status	Total #	Op Visit (Day 0) n (%)	Postop V1 (Day 1) n (%)	Postop V2 (Day 5-9) n (%)	Postop V3 (Day 21-35) n (%)	Postop V4 (Day 70-98) n (%)	Postop V5 (Day 147-182) n (%)	Postop V6 (Day 330-420) n (%)
All eyes treated (N)	629							
Available for analysis		629 (100.0)	628 (99.8)	624 (99.2)	626 (99.5)	624 (99.2)	619 (98.4)	81 (12.9)
Missing eye/data								
Discontinued		0 (0.0)	0 (0.0)	0 (0.0)	0 (0.0)	1 (0.2)	1 (0.2)	1 (0.2)
Missing at scheduled visit but seen earlier/later ¹		0 (0.0)	0 (0.0)	1 (0.2)	16 (2.5)	2 (0.3)	13 (2.1)	1 (0.2)
Missing but accounted for ²		0 (0.0)	1 (0.2)	5 (0.8)	3 (0.5)	2 (0.3)	5 (0.8)	0 (0.0)
Lost to follow-up		0 (0.0)	0 (0.0)	0 (0.0)	0 (0.0)	2 (0.3)	4 (0.6)	4 (0.6)
Active ³		0 (0.0)	0 (0.0)	0 (0.0)	0 (0.0)	0 (0.0)	0 (0.0)	543 (86.3)
% Accountability ⁴		629/629 (100.0)	628/629 (99.8)	624/629 (99.2)	626/629 (99.5)	624/628 (99.4)	619/628 (98.6)	81/85 (95.3)

¹ Missing at scheduled visit but seen earlier/later: represents the total number of eyes that were seen outside the time window associated with the visit.

² Missing but accounted for: represents the total number of eyes that missed the visit but have not been discontinued/lost to follow-up.

³ Active: represents the total number of eyes that have not reached the time associated with the visit. The investigation at the visit is considered complete when the number of active eyes is zero.

⁴ % Accountability = [Available for Analysis/(Treated-Discontinued-Active)].

The denominator for percentages is the number of treated eyes. Percentage calculated as (n/N)*100.

Safety Outcomes

Incidence of Peripheral Iridotomy (PI) Required to Treat Elevated IOP Caused by Mechanical Pupillary Block

No primary eyes (0/327, 0.0%) and no fellow eyes (0/302, 0.0%) experienced pupillary block, and no PIs were performed through Month 6.

Table 8: Incidence of PI Required to Treat Elevated IOP Caused by Mechanical Pupillary Block

	Primary Eyes (N=327)		All Eyes (N=629)	
	No. Primary Eyes	n (%*)	No. Events	All Eyes n (%*)
Required PI to treat elevated IOP through Month 6	0	(0.0%)	0	0 (0.0%)

*Percentage calculated as (n/N)*100

ECD Losses through Month 6

No instances of ECD <1500 or <1000 cells/mm² through Month 6 have been reported in this study, as shown in Table 9. Mean ECD loss (SD) from baseline was 2.4% (4.3%) in primary eyes and 2.3% (4.0%) for all eyes at Month 6. The range of change in ECD from baseline was +6.3% to -46.7%, with 97.3% (602/619) of all eyes experiencing ≤10% ECD loss from preoperative values. Three eyes of 3 subjects (3/619, 0.5%) have reported ECD loss > 30% which was related to the surgical procedure.

Table 9: ECD Change from Baseline Through Month 6

Parameter	Primary Eyes (N=321*)		All Eyes (N=619*)	
	Value	95% CI	Value	95% CI
% ECD Change from Baseline				
N - Missing	319	-	614	-
Mean (SD)	-2.4 (4.3)	-2.860, -1.922	-2.26 (4.01)	-2.576, -1.941
Median	-1.8	-	-1.68	-
Min, Max	-46.7, 6.3		-46.7, 6.3	
Distribution of % ECD Change from Baseline	n (%)	95% CI	n (%)	95% CI
Gain > 5%	2 (0.6)	0.08, 2.23	2 (0.3)	0.04, 1.16
Gain ≥ 2% to ≤ 5%	9 (2.8)	1.29, 5.26	22 (3.6)	2.24, 5.33
Gain < 2% to Loss < 2%	161 (50.2)	44.55, 55.76	320 (51.7)	47.68, 55.70
Loss ≥ 2% to ≤ 5%	101 (31.5)	26.42, 36.85	190 (30.7)	27.08, 34.49
Loss > 5% to ≤ 10%	41 (12.8)	9.32, 16.93	68 (11.0)	8.63, 13.72
Loss > 10% to ≤ 20%	3 (0.9)	0.19, 2.71	8 (1.3)	0.56, 2.53
Loss > 20% to ≤ 30%	0 (0.0)	0.00, 1.14	1 (0.2)	0.00, 0.90
Loss > 30%	2 (0.6)	0.08, 2.23	3 (0.5)	0.10, 1.41
Missing	2	-	5	-
ECD less than 1500 (n, %)	0 (0.0)	0.00, 1.14	0 (0.0)	0.00, 0.59
ECD less than 1000 (n, %)	0 (0.0)	0.00, 1.14	0 (0.0)	0.00, 0.59

*N is the number of eyes present at both the Preoperative and Month 6 Visits
Percentage calculated as (n/N)*100.

Adverse Events

All ocular AEs (only eyes implanted with study lenses) and all serious AEs (both ocular and nonocular) were to be reported in this study. Non-serious non-ocular AEs were not reported.

Experience with intraocular surgery and the implantation of IOLs has shown that some events can be considered normal or expected after these procedures. Early, low grade anterior chamber cell/flare, corneal edema, and increase in IOP can often be considered normal or expected after phakic IOL surgery and were not to be reported as AEs if they occurred prior to 1 week postoperatively and if they met the following criteria:

- AC cells or flare of ≤ grade 2 (using the SUN criteria) that require no change in standard postoperative medication regimen

- Corneal edema of \leq grade 2 that does not reduce CDVA to 20/40 or worse and does not require any change in standard postoperative medication regimen
- Increased IOP that is <10 mmHg above baseline or is <25 mmHg and requires no change in standard postoperative medication regimen or any other special treatment
- Loss of CDVA ≥ 10 letters up to 1 week postoperatively

All other untoward events that occur during the study, and all events that have sequelae were to be reported as AEs, regardless of when they occur.

Adverse Events – EVO/EVO+ Clinical Trial

A total of 203 ocular AEs were reported for 25.8% (162/629) of all implanted eyes (Table 10).

Ocular AEs reported in the EVO ICL PMA study through the update of safety data that was submitted after all eyes completed the Month 6 visit are provided in Table 10a. Details on the ocular AEs that were categorized as serious are provided in Table 10b. The incidence of cumulative and persistent ocular AEs identified in the ISO 11979-7:2018 historical grid for Primary (n=327) and All (n=629) eyes are presented in Table 11. The results of AE analyses based on the consensus definitions as set forth by American Academy of Ophthalmology's (AAO) Task Force (Masket et al, 2017) are provided in Table 12.

The most frequent AE observed in the EVO/EVO+ clinical trial was increased IOP caused by retained OVD (19.9%, 125/629), steroid response (2.4%, 15/629) or secondary surgical intervention (0.5%, 3/629). Increased IOP is discussed in more detail in the next section.

Three eyes (3/629, 0.5%) of 3 subjects reported ECD losses of $> 30\%$ from baseline at the 6 Month visit that was related to the surgical procedure. No instances of ECD less than 1500 or 1000 cells/mm² through Month 6 have been reported for any eye in this study.

No anterior subcapsular opacities or anterior subcapsular cataracts have been reported in this clinical trial. There has been a single report of a nuclear sclerotic cataract (0.16%, 1/629).

Three eyes of 2 subjects experienced retinal events, for an overall incidence of 0.5% (3/629). Surgical intervention (4 SSI of retinal laser in 2 eyes of 1 subject and pars plana vitrectomy in 2 eyes of 2 subjects) was performed to treat each of these events.

Two eyes (2/629, 0.3%) of 2 subjects experienced anterior chamber angle narrowing that required secondary surgical intervention (SSI). Both of these events resolved following an initial repositioning of the lens and subsequent lens exchange. Neither event was associated with increased IOP. One subject complained of halo and glare in 1 eye (1/629, 0.2%) which resolved following explantation of the lens, and 1 subject complained of blurred vision related to residual astigmatism in 1 eye (1/629, 0.2%) which resolved following rotational repositioning of the toric lens.

No significant persistent loss of CDVA greater than or equal to 2 lines (10 letters) was reported in this study; only one eye (1/629, 0.2%) experienced a transient loss of 2 lines (10 letters), which resolved by the next study visit.

Table 10a: Cumulative Ocular Adverse Events

Cumulative Ocular AEs	Primary Eyes (N=327)		All Eyes (N=629)	
	Eyes ¹ n (%) ²	Events n	Eyes ¹ n (%) ²	Events n
Eyes experienced any ocular AE	90 (27.5)	108	162 (25.8)	203
Intraocular pressure increased ³	75 (22.9)	77	136 (21.6)	143
Anterior chamber cell/flare ⁴	7 (2.1)	7	11 (1.7)	11
Corneal epithelial defect	3 (0.9)	3	6 (1.0)	6
Narrow anterior chamber angle ⁵	2 (0.6)	3	2 (0.3)	3
Corneal endothelial cell loss ⁶	2 (0.6)	2	4 (0.6)	4

Cumulative Ocular AEs	Primary Eyes (N=327)		All Eyes (N=629)	
	Eyes ¹ n (%) ²	Events n	Eyes ¹ n (%) ²	Events n
Dry eye	2 (0.6)	2	4 (0.6)	4
Intraocular lens exchange	2 (0.6)	2	2 (0.3)	2
Intraocular lens repositioning	2 (0.6)	2	3 (0.5)	3
Retinal surgery	1 (0.3)	1	3 (0.5)	7
Retinal detachment ⁷	1 (0.3)	1	3 (0.5)	3
Glaucoma	1 (0.3)	1	2 (0.3)	2
Contact dermatitis	1 (0.3)	1	2 (0.3)	2
Intraocular lens removal	1 (0.3)	1	1 (0.2)	1
Cataract nuclear	1 (0.3)	1	1 (0.2)	1
Glare/Halo ⁸	1 (0.3)	1	1 (0.2)	1
Hordeolum	1 (0.3)	1	1 (0.2)	1
Iris incarceration	1 (0.3)	1	1 (0.2)	1
Visual acuity reduced ⁹	1 (0.3)	1	1 (0.2)	1
Retinal tear	0 (0.0)	0	1 (0.2)	2
Vitreous detachment	0 (0.0)	0	2 (0.3)	2
Astigmatism ¹⁰	0 (0.0)	0	1 (0.2)	1
Eye discharge	0 (0.0)	0	1 (0.2)	1
Punctate keratitis	0 (0.0)	0	1 (0.2)	1

¹Percentage calculated as (n/N)*100.

²Only the first incidence of an event is counted for any given eye.

³IOP \geq 10 mmHg above baseline to a minimum of 25 mmHg or that required a change in the standard postoperative medication regimen or other special treatment was reported as an AE.

⁴Anterior chamber cell/flare was reported as an AE if it met criteria for chronic anterior uveitis or was greater than grade 2 at Visit 2 (Day 5 – 9) or later.

⁵Only those cases in which the investigator observed a reduction in anterior chamber angle and believed that a Secondary Surgical Intervention (SSI) was necessary. See Table 13 for more information on gonioscopic evaluation.

⁶Cases of endothelial cell loss that were counted as AEs included only cases of loss >30%. Refer to ECD Losses Through Month 6 section for additional information.

⁷Refer to Table 43 for additional information (rates of retinal detachment in original FDA study of the MCL).

⁸Only glare/halo leading to lens explantation was reported as an AE.

⁹Loss of CDVA \geq 10 letters at any time point > 1 week postoperatively was reported as an AE. Refer to Other Safety Outcomes section and Visual Acuity section for more detail on loss of CDVA.

¹⁰Residual astigmatism requiring second surgery of lens rotational repositioning.

Table 10b: Ocular SAEs – All Eyes

Cumulative Ocular SAEs	All Eyes (N=629)	
	Eyes ¹ n (% [*])	Events n
Eye experienced any ocular SAE	7 (1.1)	22
Eye disorders		
Glare/Halo	1 (0.2)	1
Narrow anterior chamber angle	2 (0.3)	3
Retinal detachment	3 (0.5)	3
Retinal tear	1 (0.2)	2
Surgical Reinterventions		
Intraocular lens exchange	2 (0.3)	2
Intraocular lens removal	1 (0.2)	1
Intraocular lens repositioning	3 (0.5)	3
Retinal surgery	3 (0.5)	7

¹Only the first incidence of an event is counted for any given eye.

^{*}Percentage calculated as (n/N)*100.

Table 11a: Cumulative and Persistent Ocular AEs¹

Adverse Event	Primary Eyes ²	All Eyes
Cumulative	N=327	N=629
	n, %³	n, %³
Cystoid Macular Edema	0, 0%	0, 0%
Hypopyon	0, 0%	0, 0%
Endophthalmitis	0, 0%	0, 0%
IOL Dislocation	0, 0%	0, 0%
Pupillary Block	0, 0%	0, 0%
Retinal Detachment ⁴	1, 0.3%	3, 0.5%
Secondary Surgical Intervention	6, 1.8%	9, 2.8%
Persistent⁵	N=321	N=619
	n, %³	n, %³
Corneal Stroma Edema	0, 0%	0, 0%
Cystoid Macular Edema	0, 0%	0, 0%
Iritis	0, 0%	0, 0%
Raised IOP Requiring Treatment	0, 0%	0, 0%

¹Refer to Table B.2 in ISO 11979-7 2018: Ophthalmic implants - Intraocular lenses Part 7: Clinical investigations for AE categories included in table.

²Only the first incidence of an event is counted for any given eye.

³Percentage calculated as (n/N)*100.

⁴Comparison should be made to literature for retinal detachment rates for high myopia. Retinal detachment rates increase with increasing myopia.

Refer to Table 43 for additional information (rates of retinal detachment in original FDA study of the MICL).

⁵Persistent events are those that are present at the Month 6 visit. N is the number of eyes available at the Month 6 Visit (321 primary eyes and 619 total eyes).

Table 11b: Secondary Surgical Reinterventions

Surgical Reinterventions	All Eyes (N=629)	
	Eyes ¹ n (%) ²	Events n
Intraocular lens exchange	2 (0.3)	2
Intraocular lens removal	1 (0.2)	1
Intraocular lens repositioning	3 (0.5)	3
Retinal surgery	3 (0.5)	7

¹Only the first incidence of an event is counted for any given eye.

²Percentage calculated as (n/N)*100.

Table 12: Supportive Characterization of Ocular Adverse Events based on a Modified Version of AAO Consensus¹

Adverse Event	Primary Eyes	All Eyes
	N=327	N=629
	n, % ²	n, % ²
Chronic Anterior Uveitis	0, 0%	0, 0%
Clinically Significant Cystoid Macular Edema ≥ 1 month	0, 0%	0, 0%
Corneal Edema ≥ 1 week	0, 0%	0, 0%
Endophthalmitis	0, 0%	0, 0%
Mechanical Pupillary Block	0, 0%	0, 0%
Increased IOP	75, 22.9%	136, 21.6%
Retinal Detachment	1, 0.3%	3, 0.5%
Toxic anterior segment syndrome	0, 0%	0, 0%
Hypopyon	0, 0%	0, 0%
IOL Dislocation	0, 0%	0, 0%
Secondary IOL intervention - Exchange	2, 0.6%	2, 0.3%
Secondary IOL intervention - Removal	1, 0.3%	1, 0.2%
Secondary IOL intervention - Reposition	2, 0.6%	3, 0.5%

¹ Masket S, Rorer E, Stark W, Holladay J, MacRae S, Tarver ME, Glasser A, Calogero D, Hilmantel G, Nguyen T, Eydelman M. Special Report: The American Academy of Ophthalmology Task Force Consensus Statement on Adverse Events with Intraocular Lenses. *Ophthalmology*. 2017;124: 142-144.

² Percentage calculated as (n/N)*100.

- *Increased Intraocular Pressure*

Increased IOP was the most frequently reported AE in the study through at least Month 6. No instances of increased IOP were attributed by investigators to pupillary block, anterior chamber angle narrowing, pigment dispersion or intraocular inflammation. No prophylactic IOP lowering medications were allowed during the study. These AEs commonly occurred either at PO visit 0 (1 – 6 hours) due to retained OVD or 6 to 31 days postoperative due to steroid response. An increase in IOP with onset 1 – 6 hours postoperatively was reported for 19.9% (125/629) of treated eyes. These AEs, related to incomplete removal of the dispersive OVD at the end of the surgical procedure, were managed either without treatment or with aqueous tap and/or ocular hypotensive medication and all resolved without sequelae by the first postoperative day. Table 13 provides the distribution of maximum IOP in these cases, and Table 14 provides the numbers of eyes treated with aqueous tap and/or medication.

Table 13: Maximum IOP Among Incidences of Elevated IOP with Onset on Day 0

Adverse Event - Elevated IOP	Primary Eyes (N=327)	All Eyes (N=629)
	n (%) ¹	n (%) ¹
Number of elevated IOP events	67 (20.5)	125 (19.9)
Maximum IOP (mmHg)		
< 30	17 (5.2)	40 (6.4)
≥ 30	50 (15.3)	85 (13.5)
≥ 40	23 (7.0)	38 (6.0)
≥ 50	13 (4.0)	24 (3.8)
≥ 60	6 (1.8)	11 (1.7)
≥ 70	0 (0.0)	1 (1.6)

¹Percentage calculated as (n/N)*100.

Table 14: Elevated IOP Requiring Treatment with Onset on Day 0 (All Treated Eyes)

Number of elevated IOP events requiring treatment	Primary Eyes (N=55)	All Eyes (N=97)
	n (%) ¹	n (%) ¹
Events treated with concomitant medication(s)	53 (96.4)	94 (96.9)
Events treated with paracentesis/ AC tap*	39 (70.9)	70 (72.2)

¹Percentage calculated as (n/N)*100.

Note: "paracentesis/AC tap" refers to burping the existing corneal incision to release aqueous; in no case was a needle paracentesis performed.

Investigators were previously certified ICL surgeons (through required training) and had experience implanting the U.S.-approved Visian ICLs. The OVD used in the study was hydroxypropylmethylcellulose 2% (HPMC), the OVD recommended by STAAR, and training and labeling pointed out the importance of thorough removal of the OVD to reduce the risk of postoperative increases in IOP. Investigators provided responses to a questionnaire regarding their surgical techniques of OVD removal, including the thoroughness of removal and the volume of balanced salt solution (BSS) used for irrigation. Comparison of the questionnaire responses with the incidence of elevated IOP at the 1 – 6 hour postoperative visit demonstrated that the 2 surgeons who practiced the least thorough methods of OVD removal and used the least volume of BSS for irrigation accounted for all of the events of increased IOP ≥ 40 mmHg, and the 4 surgeons who practiced the least thorough methods of OVD removal accounted for 84.0% (105/125) of events of elevated IOP but only 38% of enrolled eyes. Conversely, the 7 surgeons reporting the most thorough methods of OVD removal accounted for 55% of enrolled eyes but only 13.6% (17/125) of events of elevated IOP. These results support that the thoroughness of OVD removal is related to the incidence of elevated IOP at the 1 – 6 hour postoperative visit.

An additional 15 events (15/629, 2.4%) of increased IOP with onset from 6 to 31 days postoperative were related to the use of a topical corticosteroid and resolved with continued steroid taper and/or topical ocular hypotensive medication. Increased IOP as a result of secondary surgical intervention was reported for an additional three eyes (3/629, 0.5%). None of these events was attributed by investigators to the EVO/EVO+ lens, nor was any event attributed by investigators to either blockage of the flow of aqueous through the central port or narrowing of the anterior chamber angle.

Other Safety Outcomes

Note: For other safety outcomes (Gonioscopy, Loss of CDVA from baseline, and Vault), N is 569 eyes at the Month 6 Visit as these data are based on the treated eyes available for the interim analysis, prior to the safety update.

- *Gonioscopy*

Table 15 provides the results of gonioscopy at baseline and Month 6. A total of 60 eyes (60/569, 10.5%) demonstrated a narrower angle at Month 6 than at the preoperative visit.

Table 15: Gonioscopy by Visit in All Eyes (Safety Population)

	Preoperative Visit (N=629) n (%) ¹	Month 6 Visit (N=569) n (%) ¹
Gonioscopy		
Angle grade		
0	0 (0.0)	0 (0.0)
1	0 (0.0)	2 (0.4)
2	0 (0.0)	9 (1.6)
3	66 (10.5)	87 (15.3)
4	563 (89.5)	469 (82.4)
Missing	0	2
Pigmentation grade		
0	497 (79.0)	430 (75.6)
1	102 (16.2)	110 (19.3)
2	13 (2.1)	11 (1.9)
3	17 (2.7)	16 (2.8)
4	0 (0.0)	0 (0.0)
Missing	0	2
Peripheral anterior synechiae		
Absent	628 (99.8)	566 (99.5)
Present (specify clock hours)	1 (0.2)	1 (0.2)
0.5–2.0	1 (0.2)	1 (0.2)
2.5–4.0	0 (0.0)	0 (0.0)
4.5–6.0	0 (0.0)	0 (0.0)
6.5–8.0	0 (0.0)	0 (0.0)
8.5–10.0	0 (0.0)	0 (0.0)
10.5–12.0	0 (0.0)	0 (0.0)
Missing	0	2

¹Percentage calculated as (n/N)*100.

- *Loss of CDVA from Baseline*

No significant persistent loss of CDVA ≥ 2 lines (10 letters) was reported in this study; only 1 eye experienced a transient loss of 2 lines at Week 1, which resolved by the next visit. Overall, 91.7% (522/569) of all eyes reported unchanged or increased CDVA at Month 6 compared with the preoperative visit.

- *Vault*

Table 16 provides the number and percent of eyes with vault measurements <250 microns and >900 microns, as well as mean vault and quartiles for vault at the Month 6 visit. The preoperative factors

showing the greatest correlation to achieved vault were crystalline lens rise above the ATA (angle to angle) plane and lens diameter (**Figure 4** and **Figure 5**). Crystalline lens rise is the distance between the crystalline lens's anterior pole and the horizontal plane joining the opposite iridocorneal recesses.

Table 16: Lens Vault at Month 6 Visit (Interim Analysis)

Parameter	Primary Eyes	All Eyes
Number of eyes with vault measurement (N)	301	566
Number (%) of eyes measured with vault < 250 μ	33 (11.0)	69 (12.2)
Number (%) of eyes measured with vault > 900 μ	16 (5.3)	30 (5.3)
Mean vault (μ)	503.2	496.8
0 th percentile for measured vault (μ)	10.0	10.0
25 th percentile for measured vault (μ)	350.0	346.0
50 th percentile for measured vault (μ)	475.0	470.0
75 th percentile for measured vault (μ)	637.0	634.0
100 th percentile for measured vault (μ)	1240.0	1240.0

¹Percentage calculated as (n/N)*100

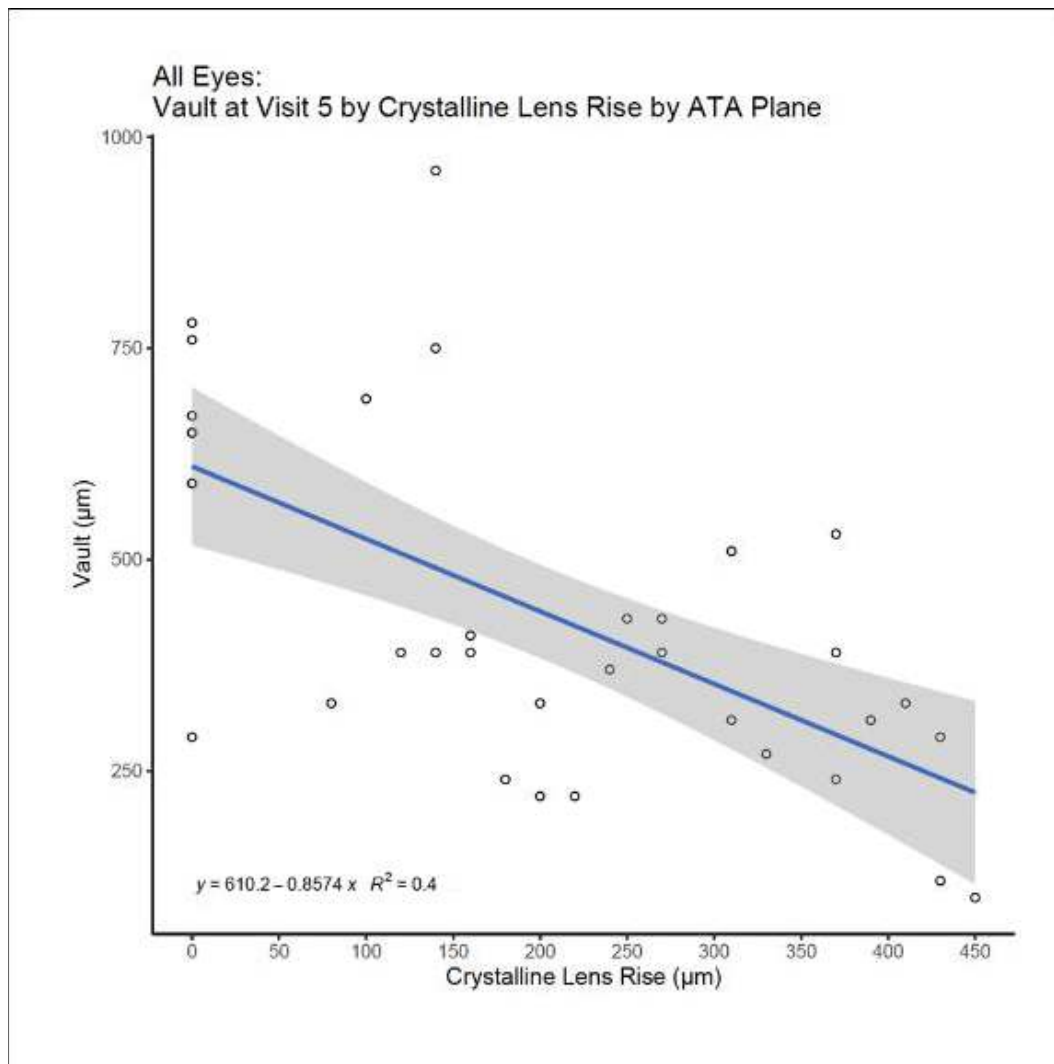

Figure 4: Vault at Month 6 by Crystalline Lens Rise

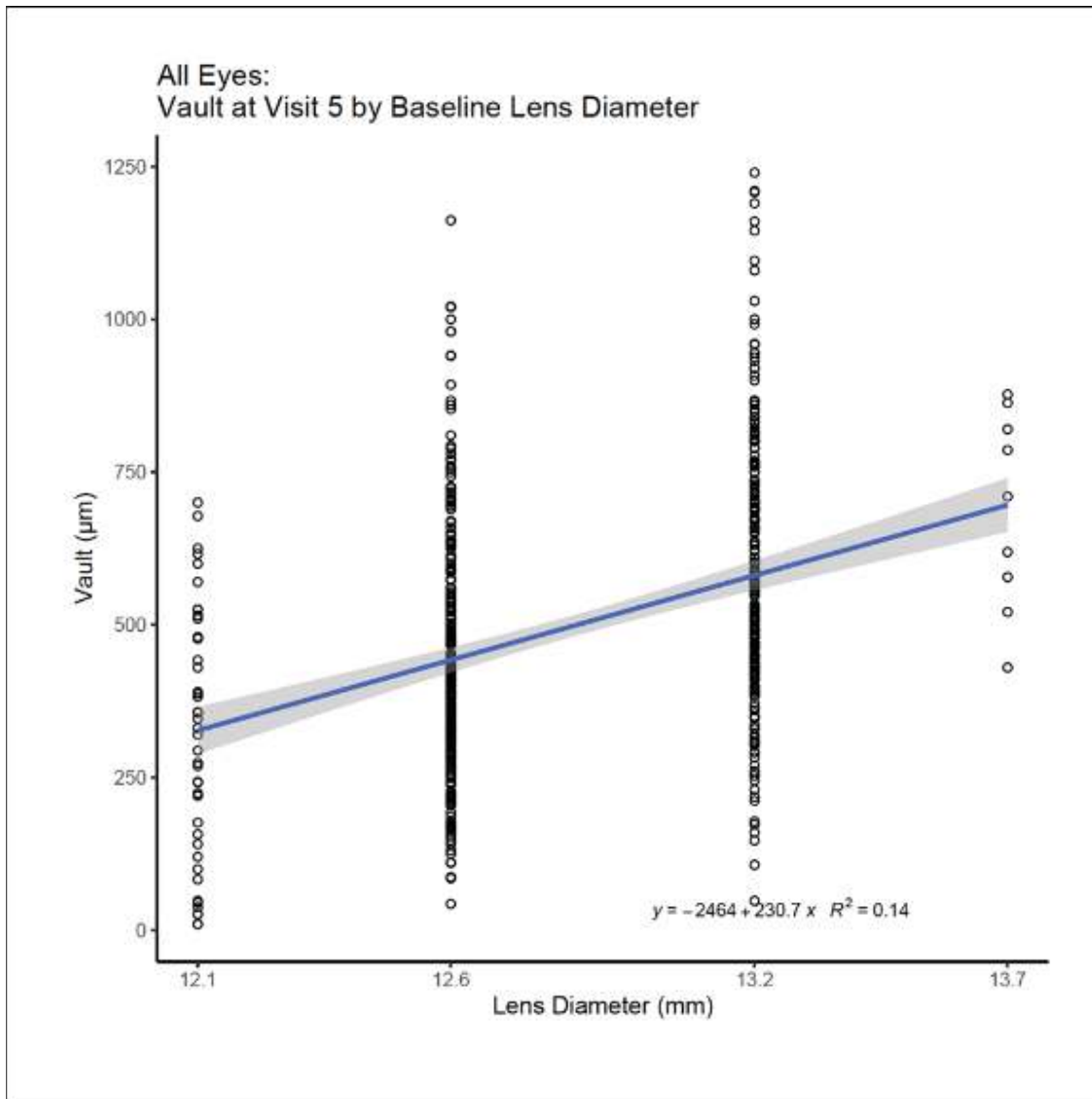

Figure 5: Vault at Month 6 by Lens Diameter

Effectiveness Outcomes

Accuracy of Refractive Outcome

MRSE by visit is provided in Table 17. As shown in Table 18, 89.4% (271/303) and 98.3% (298/303) primary eyes and 90.5% (563/569) and 98.9% (563/569) of all eyes achieved MRSE within ± 0.5 D and ± 1.0 D from target at the 6 month examination, respectively.

Table 17: MRSE by Visit

MRSE (D)	PreOp	Month 1	Month 3	Month 6
Primary Eyes				
N	327	325	324	303
Mean (SD)	-7.63 (2.80)	-0.11 (0.29)	-0.05 (0.31)	-0.09 (0.38)
Median	-7.38	-0.120	0.000	0.000
Min, Max	-15.62, -3.00	-1.25, 1.00	-1.62, 1.12	-3.88, 1.12

Missing	0	0	0	0
All Eyes				
N	629	626	624	569
Mean (SD)	-7.62 (2.76)	-0.11 (0.30)	-0.03 (0.31)	-0.08 (0.34)
Median	-7.38	-0.120	0.000	0.000
Min, Max	-15.62, -3.00	-1.25, 1.00	-1.62, 1.12	-3.88, 1.12
Missing	0	0	0	0

Table 18: MRSE Within $\pm 0.50D$ and $\pm 1.00D$ of Target at Month 6

	Primary Eyes (N=303)		All Eyes (N=569)	
	n	Proportion (95% CI)	n	Proportion (95% CI)
$\pm 0.50D$	271	0.894 (0.8542 - 0.9266)	515	0.905 (0.8780 - 0.9279)
$\pm 1.0D$	298	0.983 (0.9619 - 0.9946)	563	0.989 (0.9772 - 0.9961)

Visual Acuity

The 6 Month postoperative results provided in Table 19 and Tables 20a and 20b demonstrate that the EVO/EVO+ Visian ICL lens provides accurate refractive correction and levels of uncorrected distance visual acuity (UDVA) consistent with the non-central port MICL and TICL parent lenses.

Table 19: UDVA at 6 Months
(Where emmetropia was the goal ($\pm 0.50D$) and Preoperative Best Corrected Visual Acuity (CDVA) was 20/20 or better)

All Eyes	
N (463)	n, % ¹
20/20 or better	371, 80.1%
20/40 or better	460, 99.4%

¹Percentage calculated as (n/N)*100.

Table 20a: Best Corrected Distance Visual Acuity (CDVA) at 6 Months
(Eyes with Preoperative CDVA 20/20 or better)

6 Months	
N (463)	n, % ¹
20/20 or better	458, 98.9%
20/40 or better	463, 100%

¹Percentage calculated as (n/N)*100.

Table 20b: Best Corrected Distance Visual Acuity (CDVA) at 6 Months
(All Eyes)

6 Months	
N (619)	n, % ¹
20/20 or better	599, 96.8%
20/40 or better	619, 100%

¹Percentage calculated as (n/N)*100.

TORIC ICL LENS CLINICAL TRIAL AND RESULTS

The Visian TICL lens was evaluated in a prospective nonrandomized study of 210 eyes of 124 subjects, 194 eyes of which were followed for 12 months. Study Cohort demographics are as follows:

Table 21: Demographics – Visian TICL Study

N=124 (Subjects)

Age	
Mean (SD)	35.0 (6.8) yrs
Range	21 to 45 yrs
Race	
	n, %¹
Caucasian	102, 82.3%
Hispanic	10, 8.1%
Black	6, 4.8%
Other	6, 4.8%
Gender	
Female	69, 55.6%
Male	55, 44.4%

¹Percentage calculated as $(n/N)*100$.

Adverse Events and Complications

A total of 210 eyes of 124 subjects were evaluated in the clinical trial of the Visian TICL lens. Anterior subcapsular opacities, not all clinically significant, were observed postoperatively in six eyes (6/210, 2.9%). Two of these 6 cases (2/210, 1.0%) had a clinically significant cataract. The remaining 4 cases were asymptomatic with 20/16 or better CDVA and 20/25 or better UCVA at their last reported visit. There were no cases of greater than trace nuclear color, nuclear opalescence, cortical or posterior subcapsular changes preoperatively or at any postoperative visit.

A total of 3 eyes (3/210, 1.4%) reported a loss of ≥ 2 lines of CDVA between the preoperative and 12 month visit. A loss of > 2 lines of CDVA (20/25 to 20/50) occurred at the 12 month visit in one eye (1/210, 0.5%) due to anterior subcapsular cataract. There was no information regarding treatment or resolution at the time of study closure. A loss of 2 lines of CDVA was reported in two eyes (2/210, 1.0%). In one eye, the preoperative CDVA was 20/12.5 and at the 12 month visit the CDVA was 20/20. There were no lens opacities noted at any visit and the patient consistently rated her satisfaction with the procedure as very satisfied. The other eye was amblyopic with preoperative CDVA of 20/40 and postoperative CDVA of 20/60 at both the 6 and 12 month visits. This patient was subsequently seen 5 months after the 12 month visit and CDVA was within 1 line of preoperative CDVA. No eyes (0%) had CDVA worse than 20/40 (if preoperative CDVA 20/20 or better) between 1 and 12 months postoperative.

Corneal edema and iritis were not reported after the 1 week visit. There was 1 case (1/210, 0.5%) with a retinal detachment. One eye (1/210, 0.5%) had increased IOP at one day postoperative, which was related to a pupillary block and resolved with an additional Nd:YAG iridotomy. IOP at the one day follow up visit after Nd:YAG iridotomy was 12 mmHg, At the final 12 month post op visit, the BCVA was 20/25 and IOP was 14mmHg. One eye (1/210, 0.5%) experienced an IOP > 25 mmHg at 6 months postoperative, which dropped to 17mmHg at 12 months. Two eyes (2/210, 1.0%) of two subjects experienced an increase of > 10 mmHg over preoperative IOP during the 12 month follow-up period. These eyes experienced IOP increases from 8 mmHg to 21 mmHg and from 10 mmHg to 22 mmHg. No treatment was reported in any of these cases. No cases of endophthalmitis, corneal ulcer, ocular hypertension, corneal haze/edema (after 1 week), or corneal melting were reported during the study. The 8 cases (8/210, 3.8%) of surgical intervention all had improvement/no change in CDVA or no significant loss in CDVA (1 line in 1 case) at the last follow-up visit.

Incidence of key AEs/complications are provided in Table 22. For a benchmark, they are compared with the ISO historical rate for posterior chamber IOLs for aphakia, implanted in the capsular bag (from ISO 11979-7). Surgical reinterventions occurred in 3.8% (8/210) of eyes. Details concerning the types of surgical reinterventions are provided in Table 23.

Table 22: Incidence of Key Adverse Events and/or Complications – Visian TICL Study

Adverse Event	Cumulative N=210 Eyes	ISO ¹ Historical Rate	Persistent (12 Months)	ISO Historical Rate
	n/210, %*	%	n/194, %'	%
Endophthalmitis	0, 0%	0.1%	0, 0%	---
Hyphema ⁴	0, 0%	---	0, 0%	---
Hypopyon	0, 0%	0.3%	0, 0%	---
IOL Dislocation	0, 0%	0.1%	0, 0%	---
Cystoid Macular Edema	0, 0%	3.0%	0, 0%	0.5%
Raised IOP Requiring Treatment ⁴	1, 0.5%	---	0, 0%	0.4%
Pupillary Block	1, 0.5%	0.1%	0, 0%	---
Retinal Detachment ²	1, 0.5%	0.3%	0, 0%	---

Adverse Event	Cumulative N=210 Eyes	ISO ¹ Historical Rate	Persistent (12 Months)	ISO Historical Rate
Surgical Reintervention ³	8, 3.8%	0.8%	0, 0%	---
CDVA loss \geq 2 lines ⁴	3, 1.5%	---	3, 1.5%	---
Corneal Edema ⁴ (after 1 week)	0, 0%	---	0, 0%	0.3%
Iritis ⁴ (after 1 week)	0, 0%	---	0, 0%	0.3%
Anisocoria ⁴	1, 0.5%	---	0, 0%	---

¹ ISO-11979-7: Ophthalmic implants— Intraocular Lenses Part 7: Clinical Investigations

² Comparison should be made to literature for retinal detachment rates for high myopia. Retinal detachment rates increase with increasing myopia. The risk of retinal detachment within one year of implantation of this device is 0.5%.

The risk of retinal detachment for high myopes following implantation with the Visian MICTL lens[†] is more than 10 times the risk without surgery, i.e., greater than 10 fold the background rate of retinal detachment for high myopes (>-3D) 5.0% in myopes >-6D and 0.8% to 7.5% in pseudophakic eyes with high axial myopia.

[†] Visian MICTL Clinical Trial

³ Refer to table below for details on Surgical Reinterventions.

⁴ There is no ISO historical rate for cumulative hyphema, raised IOP requiring treatment, iritis (after 1 week), CDVA loss \geq 2 lines, corneal edema (after 1 week) and anisocoria.

*Percentage calculated as (n/N)*100.

Table 23: Visian TICL Lens Related Additional Surgery

	n/210*	% ¹
TICL Lens Repositioning	1	0.5%
Visian TICL Lens Replacement (too long)	1	0.5%
Visian TICL Lens Removal (no ICL lens or IOL replacement)	3	1.4%
YAG Iridotomy**	3	1.4%
TOTAL	8	3.8%

*Total Eye Cohort (N = 210)

¹Percentage calculated as (n/N)*100.

**Three cases (3/210, 1.4%) underwent an additional iridotomy. One of these was performed on the day of surgery because the surgeon felt the previous YAG procedure was inadequate. The IOP was 14 mmHg or less at all postoperative visits. The second case had an additional YAG iridotomy performed at 5 days postoperative to deepen the anterior chamber which was successful. This case was not associated with an increase in IOP. In the third case, the procedure was performed at 1 day postoperative to enlarge the preoperative iridotomy which was occluded by retained viscoelastic material, resulting in elevated IOP. Subsequent to the YAG procedure, the IOP returned to normal and stayed normal for the remainder of the follow-up.

Anterior subcapsular opacities, not all clinically significant, were observed postoperatively in six eyes (6/210, 2.9%). Two of these six eyes (2/210, 1.0%) had clinically significant cataracts. The remaining 4 subjects were asymptomatic with 20/16 or better CDVA and 20/25 or better UDVA at their last reported visit.

Decrease in Refractive Myopia and Cylinder

Reduction in refractive myopia and cylinder (manifest refraction spherical equivalent [MRSE] and cylinder) were the primary efficacy outcomes for the study. Table 24 and Table 26 provide MRSE and cylinder over time, and Table 25 and Table 27 provide a comparison between preoperative and 12 month MRSE and cylinder for the consistent cohort. The mean MRSE improved from -9.34D preoperative to 0.03D at the 12 month follow-up visit. There was a highly significant ($p < 0.001$) 1.43D mean decrease in cylinder from preoperative to 12 months postoperative (paired t-test).

Table 24: MRSE by Visit – Visian TICL Study

	Preop	1 Week	1 Month	3 Months	6 Months	12 Months
N (eyes)	210	205	200	191	182	194
Mean (D)	-9.38	0.02	0.13	0.13	0.11	0.03
SD	2.67	0.45	0.43	0.39	0.49	0.46
Range (D)	-19.50 to -2.38	-1.50 to 1.38	-1.63 to 1.75	-1.25 to 1.25	-1.75 to 2.63	-2.25 to ±1.00

Table 25: MRSE - Preoperative vs. 12 Months (consistent cohort) – Visian TICL Study

	Preop	12 Months
N (eyes)	194	194
Mean (D)	-9.34	0.03
SD	2.63	0.46
Range (D)	-19.50 to -2.38	-2.25 to ±1.00

Table 26: Manifest Refraction Cylinder by Visit

Spherical Equivalent	Preop	1 Week	1 Month	3 Months	6 Months	12 Months
N (eyes)	210	205	200	191	182	194
Mean (D)	1.95	0.50	0.50	0.52	0.45	0.52
SD	0.84	0.54	0.49	0.49	0.45	0.48
Range (D)	1.00 to 4.00	0.00 to 3.00	0.00 to 3.00	0.00 to 3.00	0.00 to 2.00	0.00 to 3.00

Table 27: Manifest Refraction Cylinder: Preoperative vs. 12 Months (consistent cohort) – Visian TICL Study

	Preop	12 Months
N (eyes)	194	194
Mean (D)	1.95	0.52
SD	0.85	0.48
Range (D)	1.00 to 4.00	0.00 to 3.00

Visual Acuity

The visual acuities at 6 and 12 months are described in Table 28 -Table 30.

Table 28: UDVA (Eyes with Preoperative CDVA 20/20 or Better) – Visian TICL Study

	Preoperative N=173 Eyes	6 Months N=155 Eyes	12 Months N=159 Eyes
UDVA	n/173, % ¹	n/155, % ¹	n/159, % ¹
20/12.5 or better	0, 0%	41, 26.5%	40, 25.2%
20/16 or better	0, 0%	117, 75.5%	101, 63.5%
20/20 or better	0, 0%	140, 90.3%	142, 89.3%
20/40 or better	0, 0%	155, 100%	159, 100%
20/50 or worse	173, 100%	0, 0.0%	0, 0.0%

	Preoperative N=173 Eyes	6 Months N=155 Eyes	12 Months N=159 Eyes
20/200 or worse	173, 100%	0, 0.0%	0, 0.0%

¹Percentage calculated as (n/N)*100.

Table 29: CDVA (Eyes with Preoperative CDVA 20/20 or better) – Visian TICL Study

	6 Months N=155 Eyes	12 Months N=159 Eyes
CDVA	n/155, %¹	n/159, %¹
20/12.5 or better	71, 45.8%	72, 45.3%
20/16 or better	141, 91.0%	143, 89.9%
20/20 or better	155, 100%	159, 100%
20/25 or better	155, 100%	159, 100%
20/40 or better	155, 100%	159, 100%

¹Percentage calculated as (n/N)*100.

Table 30: Comparison of Preoperative CDVA to 12 Month Postoperative UDVA – Visian TICL Study

	Preop CDVA N=193 Eyes	12 Month UDVA N=193 Eyes
	n/N, %¹	n/N, %¹
20/12.5 or better	7, 3.6%	40, 20.7%
20/16 or better	79, 40.9%	104, 53.9%
20/20 or better	159, 82.4%	158, 81.9%
20/25 or better	181, 93.8%	175, 90.7%
20/32 or better	190, 98.4%	180, 93.3%
20/40 or better	193, 100.0%	184, 95.3%
20/80 or better	193, 100.0%	191, 99.0%
20/200 or better	193, 100.0%	193, 100.0%
Worse than 20/200	0, 0%	0, 0%

¹Percentage calculated as (n/N)*100.

Predictability of Refraction

The MRSE of the refraction was predictable with 97.4% (189/194) of eyes achieving within ± 1.0 D from target at the 12 month examination.

Table 31: Accuracy of MRSE to Target – Visian TICL Study

N=194 Eyes	
n/194, % ¹	
Within ± 0.50D	149, 76.8%
Within ± 1.0D	189, 97.4%

¹Percentage calculated as (n/N)*100.

The manifest cylinder was predictable with 92.3% (179/194) of eyes achieving within ± 1.0D from target at the 12 month examination.

Table 32: Accuracy of Manifest Cylinder to Target (at the corneal plane) – Visian TICL Study

12 Months N=194 Eyes	
n/194, % ¹	
Within ± 0.50D	134, 69.1%
Within ± 1.0D	179, 92.3%

¹Percentage calculated as (n/N)*100.

The effect of a temporal corneal incision on corneal toricity was analyzed. On average, implantation of the TICL lens contributes less than 0.5D of "with-the-rule" astigmatism to the net corneal toricity.

Stability

MRSE was stable with 99.4% (176/177) of eyes achieving less than or equal to ±1.0D of shift between 6 and 12 months after surgery.

Table 33: MRSE Change between Visits – Visian TICL Study

Change	1 Month to 3 Months N=184 Eyes	3 Months to 6 Months N=172 Eyes	6 Months to 12 Months N=177 Eyes
	n/184, % ¹	n/172, % ¹	n/177, % ¹
Within ± 0.25D	136, 73.9%	129, 75.0%	139, 78.5%
Within ± 0.50D	169, 91.8%	159, 92.4%	167, 94.4%
Within ± 1.0D	184, 100%	170, 98.8%	176, 99.4%
> 1.0D	0, 0%	2, 1.2%	1, 0.6%
Mean Change	0.010	-0.009	0.081
SD	0.311	0.330	0.360
95% CI of the Mean	-0.04 to 0.05	-0.06 to 0.04	0.03 to 0.13

¹Percentage calculated as (n/N)*100.

Manifest cylinder was stable with 97.2% (172/177) -98.8% (165/167) of eyes achieving less than or equal to ±1.0D of shift between 6 to 12 months after surgery, depending on analysis method.

Table 34: Manifest Cylinder Change Between Visits – Visian TICL Study

Analysis Group	Exam Interval	N (Eyes)	Within ± 0.5D n/N, % ¹	Within ± 1.0D n/N, % ¹	Mean Change for Interval [95% Confidence Interval]
Vector Stability	1 to 3 Months	184	143/184, 77.7%	179/184, 97.3%	0.26D [0.23 to 0.3]
	3 to 6 Months	172	145/172, 84.3%	167/172, 97.1%	0.23D [0.19 to 0.26]
	6 to 12 Months	177	141/177, 79.7%	172/177, 97.2%	0.26D [0.22 to 0.29]
Vector Stability Consistent cohort	1 to 3 Months		130/167, 77.8%	162/167, 97.0%	0.26D [0.23 to 0.3]
	3 to 6 Months	167	140/167, 83.8%	162/167, 97.0%	0.23D [0.19 to 0.27]
	6 to 12 Months		134/167, 80.2%	163/167, 97.6%	0.24D [0.21 to 0.28]
Stability of Absolute Cylinder	1 to 3 Months	184	154/184, 83.7%	181/184, 98.4%	0.00D [-0.05 to 0.05]
	3 to 6 Months	172	153/172, 89.0%	170/172, 98.8%	-0.03D [-0.08 to 0.01]
	6 to 12 Months	177	151/177, 85.3%	174/177, 98.3%	0.04D [0 to 0.09]
Stability of Absolute Cylinder Consistent Cohort	1 to 3 Months		140/167, 83.8%	164/167, 98.2%	0.00D [-0.05 to 0.05]
	3 to 6 Months	167	148/167, 88.6%	165/167, 98.8%	-0.03D [-0.08 to 0.01]
	6 to 12 Months		143/167, 85.6%	165/167, 98.8%	0.03D [-0.02 to 0.07]

¹Percentage calculated as (n/N)*100.

Study investigators were asked to examine the patient at the slit lamp and estimate the orientation of the long axis of the Visian TICL lens based upon the alignment markings or haptic edges if visible. The lens orientation was then recorded in clock hours. For instance, if the lens was oriented exactly horizontally it would be recorded as at either 3:00 or 9:00 (clock hour position). Rotation was evaluated based upon the change in clock hour orientation of the Visian TICL lens postoperatively. A change of a half clock hour would represent 15 degrees of rotation and a change of a quarter clock hour would represent 7.5 degrees of rotation.

Table 35: Rotation of the TICL Lens Between Visits (from direct observation of TICL Lens)

	1 Day – 1 Week	1 Week – 1 Month	1 Month – 3 Months	3 Months – 6 Months	6 Months – 12 Months
N (Eyes)	121	155	148	136	140
Rotation	n/121, % ¹	n/155, % ¹	n/148, % ¹	n/136, % ¹	n/140, % ¹
≤ 5°	118, 97.5%	148, 95.5%	141, 95.3%	133, 97.8%	132, 94.3%
≤ 10°	121, 100%	155, 100%	147, 99.3%	135, 99.3%	137, 97.9%

¹Percentage calculated as (n/N)*100.

Optical Visual Symptoms

A standardized subjective patient questionnaire was administered across all investigative sites to all subjects in the Visian TICL Lens Study Cohort preoperatively and after ICL lens implantation. Study subjects' subjective assessments of ocular symptoms of glare, halos, double vision, night vision and night driving difficulties were evaluated for each eye at the preoperative and at the 3 and 12 month postoperative follow-up visits. Subjects were asked to grade the level of the specific ocular symptom in one of five categories: Absent, Mild, Moderate, Marked or Severe.

Table 36: Eyes with Symptoms Worse at 12 Months compared to Preoperative – Visian TICL Study

Visual Symptom	Worse at 12 Months than Preoperative n/N, % ¹
Glare	28/185, 15.1%
Halos	33/185, 17.8%
Double Vision	3/185, 1.6%
Night Vision	22/184, 11.9%
Night Driving Difficulties	24/182, 13.2%

¹Percentage calculated as (n/N)*100.

Note: The questionnaire and methodology used to evaluate these subjective symptoms were not considered by the FDA to be validated.

Additional Clinical Outcomes - Visian TICL Study

Table 37 provides predictability of intended refraction (within ± 0.50D and ± 1.0D) for all eyes and by the level of preoperative refraction.

Table 37: Accuracy of MRSE vs. Intended Target* by Preoperative MRSE – Visian TICL Study

Lens Group	Exam Interval	N	Within ± 0.50D n/N, % ¹	Within ± 1.0D n/N, % ¹	Within ± 2.0D n/N, % ¹
	1 Week	201	149/201, 74.1%	194/201, 96.5%	201/201, 100%
	1 Month	198	155/198, 78.3%	189/198, 95.5%	198/198, 100%
Study Cohort	3 Months	190	142/190, 74.7%	185/190, 97.4%	190/190, 100%
	6 Months	181	122/181, 67.4%	174/181, 96.1%	180/181, 99.4%
	12 Months	194	149/194, 76.8%	189/194, 97.4%	194/194, 100%
≤ -7D Cohort	12 Months	33	28/33, 84.8%	33/33, 100%	33/33, 100%
> -7 to -10D Cohort	12 Months	93	76/93, 81.7%	92/93, 98.9%	93/93, 100%
> -10D to -15D Cohort	12 Months	62	42/62, 67.7%	59/62, 95.2%	62/62, 100%
> -15D Cohort	12 Months	6	3/6, 50.0%	5/6, 83.3%	6/6, 100%

* All Study Cohort Eyes

¹Percentage calculated as (n/N)*100.

Table 38: Accuracy of Manifest Cylinder vs. Intended Target By Visit – Visian TICL Study

Lens Group ¹	Exam Interval	N (Eyes)	Within 0.25 D n/N ² , % ³	Within 0.50 D n/N ² , % ³	Within 1.00 D n/N ² , % ³	Within 2.00 D n/N ² , % ³
Study Cohort	Preop	210	0/210, 0%	0/210, 0%	43/210, 20.5%	134/210, 63.8%
	1 Week	205	92/201, 45.8%	128/201, 63.7%	184/201, 91.5%	198/201, 98.5%
	1 Month	200	84/198, 42.4%	128/198, 64.6%	180/198, 90.9%	197/198, 99.5%
	3 Months	191	77/190, 40.5%	123/190, 64.7%	174/190, 91.6%	186/190, 97.9%
	6 Months	182	87/181, 48.1%	128/181, 70.7%	167/181, 92.3%	181/181, 100%
	12 Months	194	78/194, 40.2%	127/194, 65.5%	177/194, 91.2%	193/194, 99.5%

¹ All Study Cohort Eyes

²Eyes with non-missing data

³Percentage calculated as (n/N)*100.

Table 39: Percent Reduction of Absolute (non-vector) Cylinder Attempted 'vs' Achieved at the Spectacle Plane – Visian TICL Study

Preoperative Cylinder	N=194* Eyes	Percent Reduction of Absolute Cylinder		
		Mean	Range	[% CI]
ALL	n/194, %	77.8	-62.7 to 151.9	[73.9 to 81.6]
> 0.5D to ≤ 1.0D	39, 20.1%	75.1	-26.4 to 125.2	[65.4 to 84.8]
> 1.0D to ≤ 2.0D	86, 44.3%	71.4	-62.7 to 137.3	[64.9 to 77.9]
> 2.0D to ≤ 3.0D	45, 23.2%	87.1	44.8 to 151.9	[82.2 to 91.9]
> 3.0D to ≤ 4.0D	24, 12.4%	87.6	29.0 to 125.6	[80.3 to 95]

* All Study Cohort Eyes

Percentage calculated as (n/N)*100.

Table 40 shows the UDVA by the level of preoperative refraction for all eyes implanted that had a CDVA of 20/20 or better preoperatively.

Table 40: UDVA* Over Time and by Preoperative MRSE – Visian TICL Study

MRSE Group	Exam Interval	N Eyes	20/20 or Better n/N, % ¹	20/40 or Better n/N, % ¹
	1 Week	171	131/171, 76.6%	170/171, 99.4%
	1 Month	166	139/166, 83.7%	164/166, 98.8%
Study Cohort	3 Months	161	140/161, 87.0%	161/161, 100%
	6 Months	155	140/155, 90.3%	155/155, 100%
	12 Months	159	142/159, 89.3%	155/155, 100%
≤ -7D	12 Months	33	31/33, 93.9%	32/33, 97.0%
> -7D to -10D	12 Months	93	78/93, 83.9%	91/93, 97.8%
> -10D to -15D	12Months	61	47/61, 77.0%	59/61, 96.7%
> -15D	12Months	6	2/6, 33.3%	2/6, 33.3%

*In eyes with preoperative CDVA of 20/20 or better

¹Percentage calculated as (n/N)*100.

Subjective Quality of Vision

A standardized subjective patient questionnaire was administered across all investigative sites to all subjects in the Visian TICL Lens Study preoperatively and after ICL lens implantation. Study subject's subjective assessments of their quality of vision were evaluated for each eye at the preoperative and at the 3 and 12 month postoperative follow-up visits. Subjects were asked to rate their level of quality of vision in one of five categories: Excellent, Very Good, Good, Poor or Very Poor.

Table 41: Subjective Quality of Vision (All Eyes) – Visian TICL Study

Quality of Vision Grading	Preoperative N=210	12 Months N=184
	n/210, % ¹	n/184, % ¹
Excellent /Very Good	135/210, 64.3%	174/184, 94.6%
Good	53/210, 25.2%	10/184, 5.4%
Poor/Very Poor	22/210, 10.5%	0/184, 0%

¹Percentage calculated as (n/N)*100.

Note: The questionnaire and methodology used to evaluate these subjective symptoms were not considered by the FDA to be validated.

PMA CLINICAL TRIAL AND RESULTS - VISIAN ICL LENS FOR MYOPIA

The Visian ICL lens was evaluated in a prospective nonrandomized study of 526 eyes of 294 subjects, 470 of which were followed for 1 year and 369 followed for 3 years. Demographics for the Study Cohort are presented in the following table:

Table 42: Demographics – Visian ICL Study

N=526 Eyes (294 Subjects)

Age	
Average	36.55 ±5.8 years
Range	22 to 45 years
Race	
N (294)	n,% ¹
Black	6, 2.0%
Caucasian	249, 84.7%
Hispanic	23, 7.8%
Other	16, 5.4%
Gender	
Female	178, 60.5%
Male	116, 39.5%

¹Percentage calculated as (n/N)*100.

In the study, surgeons supplied the following parameters to STAAR: manifest refraction – sphere, cylinder, axis; back vertex distance in millimeters; ACD in millimeters (posterior surface of the cornea to the anterior surface of the crystalline lens); and corneal thickness in millimeters. STAAR calculated the appropriate ICL lens power using proprietary software.

Adverse Events

A total of 526 eyes of 294 subjects were evaluated in the clinical trial to determine the safety of the Visian ICL lens. Anterior subcapsular opacities, not all clinically significant, were observed postoperatively in 14/526 eyes (2.7%). An increase in postoperative cylinder >2 D at 3 years from surgery was present in 0.4% (2/256) of eyes. Loss of best corrected visual acuity (CDVA) >2 lines occurred in 4/526 eyes (0.8%) and a 2 line loss in 6/526 eyes (1.2%).

The AEs/complications experienced during the clinical study of the Visian ICL lens (between 1 and 36 months) included 3 retinal detachments (3/526, 0.6%), 2 cases of glaucoma (2/526, 0.4%), clinically significant cataract (2 anterior (2/526, 0.4%); 5 nuclear (5/526, 1%)), 1 case of elevated IOP >25 mmHg / >10mmHg change from baseline at last visit (1/526, 0.2%), 1 macular hemorrhage (1/526, 0.2%) and 1 subretinal hemorrhage (1/526, 0.2%).

There were 20 cases of raised IOP requiring secondary surgical intervention in the early postoperative time period. Of these, 17 eyes were treated with YAG laser iridotomy for pupillary block, and 3 eyes were treated with repeat irrigation and aspiration for removal of retained viscoelastic. There were 16 cases of secondary surgical intervention for ICL lens removal, replacement, or repositioning. In addition, most patients experienced some degree of endothelial cell loss after ICL lens implantation.

Incidence of AEs/complications (compared with the FDA Grid for cataract extraction and posterior chamber IOL implantation) and incidence of surgical reinterventions are shown in Table 43 and Table 44.

Table 43: Adverse Events – Visian ICL Study

Adverse Event	Cumulative %* (n/N)	FDA Grid %	Persistent (36 Mo) %* (n/N)	FDA Grid %
Endophthalmitis	0% (0/526)	0.1%	0% (0/526)	---
HypHEMA	0% (0/526)	2.2%	0% (0/526)	---
Hypopyon	0% (0/526)	0.3%	0% (0/526)	---
IOL Dislocation	0% (0/526)	0.1%	0% (0/526)	---
Cystoid Macular Edema	0% (0/526)	3.0%	0% (0/526)	0.5%
Pupillary Block	3.2% (17/526)	0.1%	0% (0/526)	---
Retinal Detachment ¹	0.6% (3/526)	0.3%	0% (0/526)	---
Surgical Reintervention ²	6.8% (36/526)	0.8%	0% (0/526)	---
Corneal Edema (after 1 week)	0% (0/526)	---	0% (0/526)	0.3%
Iritis ³ (after 1 week)	0% (0/526)	---	0% (0/526)	0.3%
Surgical Treatments Not Monitored in FDA Grid				
Refractive Procedures	3.9% (20/526)	---	---	---
Iris Prolapse Repair	0.2% (1/526)	---	0% (0/526)	---

*Study percentage calculated as (n/N)*100.

¹Comparison should be made to literature for retinal detachment rates for high myopia. Retinal detachment rates increase with increasing myopia. The risk of retinal detachment within one year of implantation of this device is 0.2%. The risk of retinal detachment for high myopes following implantation is more than 10 times the risk without surgery, i.e., greater than 10 fold the background rate of retinal detachment for high myopes (>-3D) 5.0% in myopes >-6D and 0.8% to 7.5% in pseudophakic eyes with high axial myopia.

Ogawa A, Tanaka, M. *The relationship between refractive errors and retinal detachment*, Jpn J Ophthalmol 32;310:1988.

Dellone-Larkin G, Dellona CA. *Retinal detachment*. Available at: <http://www.emedicine.com/emerg/topic504.htm>

Jacobi F, Hessemer V. *Pseudophakic retinal detachment in high axial myopia*. J Cat Ref Surg 23; 1095:1997. Refractive procedures include: AK and LASIK

² Refer to table below for details on Surgical Reinterventions.

³There is no FDA Grid Rate for cumulative iritis.

Surgical reinterventions (see Table 44 below) were not shown to have an impact on efficacy. Surgical reinterventions occurred in 6.8% (36/526) of cases.

Table 44: Visian ICL Lens Related Additional Surgery

	n	% ¹
Visian ICL Lens Repositioning	4	0.8%
Visian ICL Lens Replacement, then Removal	1	0.2%
Visian ICL Lens Replacement	8	1.5%
Visian ICL Lens Removal	3	0.6%
Raised IOP Requiring Surgery	20	3.8%
TOTAL	36	6.8%

¹ Total Study Cohort (N = 526)

¹Percentage calculated as (n/N)*100.

Refer to the Section “POST-APPROVAL CONTINUATION OF THE VISIAN ICL LENS CLINICAL STUDY” for a detailed discussion of AEs and complications that occurred in the PMA study cohort from day of surgery throughout the long-term post-approval phase of the study.

Visual Acuity

The postoperative results demonstrated that the Visian ICL lens can provide full correction for high myopia up to -15D and only partial correction up to -20D. The visual acuities at 12 and 36 months are described in the following tables:

**Table 45: UDVA – Visian ICL Study
(Where emmetropia was the goal ($\pm 0.50D$) and Preoperative CDVA was 20/20 or better)**

N	12 Months	36 Months
	n, % ¹	n, % ¹
20/20 or better	157, 65.4%	112, 59.3%
20/40 or better	232, 96.7%	179, 94.7%
20/80 or better	239, 99.6%	187, 98.9%
Worse than 20/80	1, 0.4%	2, 1.1%

¹Percentage calculated as (n/N)*100.

**Table 46: CDVA – Visian ICL Study
(Eyes with Preoperative CDVA 20/20 or better)**

N	12 Months	36 Months
	n, % ¹	n, % ¹
20/20 or better	307, 95.6%	244, 96.4%
20/25 or better	320, 99.7%	253, 100%
20/40 or better	321, 100%	253, 100%

¹Percentage calculated as (n/N)*100.

Predictability of Refraction

The refraction was predictable with 91.6% (417/455) of subjects achieving $\pm 1.0D$ from target at the 12 month examination.

Table 47: Spherical Equivalent (Target Variance) Distribution – Visian ICL Study

N	12 Months	36 Months
	n, % ¹	n, % ¹
$\pm 0.50D$	314, 69%	248, 68.3%
$\pm 1.0D$	417, 91.6%	325, 89.5%

¹Percentage calculated as (n/N)*100.

Stability

The refraction was stable with 97.6% (329/337) of eyes achieving less than or equal to $\pm 1.0D$ of shift at 36 months.

Table 48: MRSE Change between Visits – Visian ICL Study

N	6-12 Months	12- 24 Months	24-36 Months
	n, % ¹	n, % ¹	n, % ¹
$\pm 0.25D$	320, 75.5%	317, 76.8%	253, 75.1%
$\pm 0.5D$	386, 91.0%	371, 89.8%	304, 90.2%
$\pm 1.0D$	414, 97.6%	403, 97.6%	329, 97.6%
>1.0D	10, 2.4%	10, 2.4%	8, 2.4%

¹Percentage calculated as (n/N)*100.

Optical Visual Symptoms

Table 49 reports the subjective optical visual symptoms reported by subjects during this clinical study after Visian ICL lens implantation compared to before the Visian ICL surgery:

Table 49: Subjective Symptoms – Visian ICL Study

Symptom	Improved/No Change at 36 Months
n/N (% ¹)	
Glare	317/351 (90.4%)
Halos	310/350 (88.5%)
Double Vision	345/351 (98.3%)
Night Vision	308/350 (88.0%)
Night Driving Difficulties	301/335 (89.8%)

¹Percentage calculated as (n/N)*100.

Additional Clinical Outcomes

Table 50 provides predictability of intended refraction ($\pm 0.50D$ and $\pm 1.0D$) for all eyes and by the level of preoperative refraction.

Table 50: MRSE vs. Intended Target¹ by Preoperative MRSE – Visian ICL Study

Lens Group	Exam Interval	N	$\pm 0.5D$	$\pm 1.0D$	$\pm 2.0D$
			n, % ¹	n, % ¹	n, % ¹
Study Cohort	1 Week	501	324, 64.7%	438, 87.4%	487, 97.2%
	1 Month	506	344, 68.0%	445, 87.9%	495, 97.8%
	3 Months	485	310, 63.9%	430, 88.7%	475, 97.9%
	6 Months	479	320, 66.8%	426, 88.9%	470, 98.1%
	12 Months	455	308, 67.7%	411, 90.3%	447, 98.2%
	24 Months	443	293, 66.1%	399, 90.1%	434, 98.0%
	36 Months	363	245, 67.5%	320, 88.2%	356, 98.1%
New Calculation Method ³	36 Months	363	254, 70.0%	324, 89.3%	357, 98.3%
$\leq -7D$ Cohort	36 Months	72	61, 84.7%	70, 97.2%	72, 100%
New Calculation Method ³	36 Months	72	62, 86.1%	70, 97.2%	72, 100%
$> -7D$ to $-10D$ Cohort ²	36 Months	131	93, 71.0%	122, 93.1%	131, 100%
New Calculation Method ³	36 Months	131	92, 70.2%	121, 92.4%	131, 100%
$> -10D$ to $-15D$ Cohort	36 Months	130	84, 64.6%	112, 86.2%	128, 98.5%
New Calculation Method ³	36 Months	130	91, 70.0%	115, 88.5%	129, 99.2%
$> -15D$ Cohort	36 Months	30	7, 23.3%	16, 53.3%	25, 83.3%
New Calculation Method ³	36 Months	30	9, 30.0%	18, 60.0%	25, 83.3%

¹All Study Cohort Eyes

²Note % lower with new Power Calculation Method

³The new calculation method was used to correct for a change in power labeling to allow standard phakic IOL power formulas to be used without modification. It is a theoretical calculation only.

Percentage calculated as (n/N)*100.

Table 51 shows the UDVA for all eyes and by the level of preoperative refraction for all eyes implanted that were targeted for emmetropia and had a CDVA of 20/20 or better preoperatively.

Table 51: UDVA¹ by Preoperative MRSE – Visian ICL Study

Lens Group	Exam Interval	n	20/20 or Better	20/40 or Better
			n, % ¹	n, % ¹
Study Cohort	1 Week	259	129, 49.8%	238, 91.9%
	1 Month	262	148, 56.5%	249, 95.0%

Lens Group	Exam Interval	n	20/20 or Better	20/40 or Better
	3 Months	251	160, 63.7%	242, 96.4%
	6 Months	248	171, 60.9%	242, 96.4%
	12 Months	240	171, 65.4%	232, 96.7%
	24 Months	228	136, 59.6%	213, 93.4%
	36 Months	189	112, 59.3%	179, 94.7%
≤-7D	36 Months	58	42, 72.4%	57, 98.3%
>-7D to -10D	36 Months	83	52, 62.7%	77, 92.8%
>-10D to -15D	36 Months	48	18, 37.5%	45, 93.8%
>-15D	36 Months	0	NA% ²	NA% ²

¹ Eyes with preoperative CDVA 20/20 or better and emmetropia targeted correction

² No Eyes >-15D group with this preoperative status

Percentage calculated as (n/N)*100.

Table 52: Subjective Quality of Vision – Visian ICL Study (All Eyes)

Quality of Vision Grading	Preoperative	36 Months
	N(524)	N(346)
	n (% ¹)	n (% ¹)
Very Good/Excellent	288 (55.0%)	267 (77.0%)
Poor/Very Poor	61 (11.6%)	20 (5.8%)

¹Percentage calculated as (n/N)*100.

Subjective Symptoms Stratified by Optic Diameter

Subjective symptoms reported by subjects were stratified into 4 groups based on the optic diameter: 4.9mm, 5.2mm, 5.5mm and 5.8mm. Glare was absent/mild in 82.4% (75/91) of subjects in the 4.9mm, 90.3% (65/72) in the 5.2mm, 91.8% (45/49) in the 5.5mm and 89.9% (125/139) in the 5.8mm groups. Marked/severe glare occurred in 3.3% (3/91) of eyes with the 4.9mm, 2.8% (2/72) with the 5.2mm, 4.1% (2/49) with the 5.5mm and 1.4% (2/139) with the 5.8mm optic at 36 months postoperatively.

The smaller the optic diameter, the greater the incidence of halos. Halos were absent/mild in 80.2% (73/91) of subjects in the 4.9mm, 87.3% (62/71) in the 5.2mm, 89.8% (44/49) in the 5.5mm and 87.8% (122/139) in the 5.8mm. Marked/severe halo was dependent upon the Visian ICL lens optic diameter and was 9.9% (9/91) with the 4.9mm, 2.8% (2/71) with the 5.2mm, 4.1% (2/49) with the 5.5mm and 1.4% (2/139) with the 5.8mm.

Double vision was absent in all eyes with the 5.8mm optic diameter. Double vision was reported as absent in 95.6% (87/91) of the subjects with the 4.9mm, 98.6% (71/72) with the 5.2mm, and 98.0% (48/49) with the 5.5mm at 36 months. The incidence of marked/severe night driving difficulties negatively correlated with the optic diameter. Marked/ severe night driving difficulties was reported in 16.7% (15/90) of eyes in the 4.9mm group compared to 0% (0/135) with the 5.8mm. Night driving difficulties were absent / mild in 71.1% (64/90) of eyes using the 4.9mm, 83.8% (57/68) with the 5.2mm, 85.4% (41/48) with the 5.5mm, and 91.9% (124/135) with the 5.8mm.

A similar trend between the subjective symptom and the 36-month follow-up shows a negative correlation between the incidence/severity of night vision difficulties and the optic diameter. No cases of marked/severe night vision difficulties occurred with the 5.8mm. Subjective night vision difficulties 36 months after Visian ICL lens insertion were absent/mild in 73.6% (67/91) of eyes with 4.9mm, 84.7% (61/72) with the 5.2mm, 83.7% (41/49) with the 5.5mm, and 90.6% (126/139) with the 5.8mm.

POST-APPROVAL CONTINUATION OF THE PMA CLINICAL TRIAL

As a condition of approval, STAAR Surgical was required to follow subjects of the original PMA study cohort through 60 months (5 years) after lens implantation with the specific objective of collecting long-term data on endothelial cell loss and on AEs/complications.

Study Objective

The objective of this post-approval study was to collect new long-term data on endothelial cell loss and on AEs/complications in order to assess long-term safety of the lens. Only data on these safety parameters are updated in this section.

Study Design

This post-approval study consisted of the extended follow-up of the original PMA study cohort. It was a single-arm study with follow-up visits scheduled at 48 and 60 months (4 and 5 years) post-implantation.

Total Number of Enrolled Study Sites and Subjects

Of the 526 eyes (294 subjects) enrolled at 14 sites in the United States in the original PMA study, 335 eyes of 192 subjects were seen at 60 months (5 years) or later, as shown in Table 53. However, since this post-approval study was initiated a number of years after the first implants of the Visian ICL lens in the original PMA study, some subjects were more than 60 months postoperative at the time of initiation of the post-approval study. These subjects were seen for a final visit and are included in the "≥ 60 Months" columns.

Table 53: Accountability – Post-Approval Continuation of Visian ICL Study

Accountability <i>(all implanted eyes, N=526)</i>		12 Months	24 Months	36 Months	48 Months	60 Months	≥ 60 Months
Available for Analysis		472	459	384	248	225	335
Discontinued (ICL Lens Removals) ¹		0	1	5	5	10	11
Missed Visit/CRF not Received		40	44	84	192	176	NA
Missing		0	0	0	1	4	NA
Lost to Follow-up		14	22	53	80	111	180
% Accountability²		89.7%	87.4%	73.7%	47.7%	43.9%	65.6%

¹Cumulative total number of eyes discontinued is 11

²%Accountability is equal to (Available for analysis)/(All Implanted Eyes-Discontinued-Missing)

Adverse Events and Complications

The incidence of AEs, complications and surgical reinterventions reported from time of surgery through the end of the post-approval study period (≥60 months), are shown in Table 54 through Table 56.

Table 54: Adverse Events Through ≥60 months – Post-Approval Continuation of Visian ICL Study

Adverse Event¹	Cumulative n/526 (%)	≤ 12 Mo n/526 (%)	>12-24 Mo n/462 (%)	>24-36 Mo n/426 (%)	>36-48 Mo n/276 (%)	>48-60 Mo n/346 (%)	≥60 Mo n/348 (%)
Endophthalmitis	0, (0.0%)	0, (0.0%)	0, (0.0%)	0, (0.0%)	0, (0.0%)	0, (0.0%)	0, (0.0%)
Hyphema	0, (0.0%)	0, (0.0%)	0, (0.0%)	0, (0.0%)	0, (0.0%)	0, (0.0%)	0, (0.0%)
Hypopyon	0, (0.0%)	0, (0.0%)	0, (0.0%)	0, (0.0%)	0, (0.0%)	0, (0.0%)	0, (0.0%)
IOL Dislocation	0, (0.0%)	0, (0.0%)	0, (0.0%)	0, (0.0%)	0, (0.0%)	0, (0.0%)	0, (0.0%)
Cystoid Macular Edema	0, (0.0%)	0, (0.0%)	0, (0.0%)	0, (0.0%)	0, (0.0%)	0, (0.0%)	0, (0.0%)
Pupillary Block	17, (3.2%)	17, (3.2%)	0, (0.0%)	0, (0.0%)	0, (0.0%)	0, (0.0%)	0, (0.0%)
Retinal Detachment	3, (0.6%)	1, (0.2%)	1, (0.2%)	1, (0.2%)	0, (0.0%)	0, (0.0%)	0, (0.0%)
Surgical Reintervention ²	43, (8.2%)	28, (5.3%)	4, (0.9%)	4, (0.9%)	2, (0.7%)	4, (1.2%)	1, (0.3%)
Corneal Edema (after 1 week)	0, (0.0%)	0, (0.0%)	0, (0.0%)	0, (0.0%)	0, (0.0%)	0, (0.0%)	0, (0.0%)
Iritis (after 1 week)	0, (0.0%)	0, (0.0%)	0, (0.0%)	0, (0.0%)	0, (0.0%)	0, (0.0%)	0, (0.0%)
Iris Prolapse Repair	1, (0.2%)	1, (0.2%)	0, (0.0%)	0, (0.0%)	0, (0.0%)	0, (0.0%)	0, (0.0%)

¹ Loss of VA, cataract development, raised IOP requiring pharmacologic intervention, endothelial cell loss and other unclassified complications are not included in the table but are discussed in the sections below.

² Refer to section below for details on Surgical Reinterventions.

³Percentage calculated as (n/N)*100.

Surgical Reinterventions

A total of 43/526 eyes (8.2%) underwent surgical reintervention during the study (Table 55). Of these, 23/526 (4.4%) eyes had repositioning (4 eyes), removal (10 eyes) or replacement (8 eyes) of the ICL lens, and 1 eye had ICL lens replacement and then removal. Each case of ICL lens removal during the study was performed in conjunction with cataract surgery. An additional 20/526 eyes (3.8%) underwent repeat YAG iridotomy or additional irrigation/aspiration during the early postoperative time period. Of these, 17 eyes were treated with YAG laser iridotomy for pupillary block, and 3 eyes were treated with repeat irrigation and aspiration for removal of retained viscoelastic.

Table 55: ICL Lens Related Additional Surgery Through ≥ 60 months – Post-Approval Continuation of Visian ICL Study

ICL Lens Related Additional Surgery	Cumulative n/526 (%)	≤ 12 Mo n/526 (%)	>12-24 Mo n/462 (%)	>24-36 Mo n/426 (%)	>36-48 Mo n/276 (%)	>48-60 Mo n/346 (%)	≥ 60 Mo n/348 (%)
ICL Lens Repositioning	4 (0.8%)	4 (0.8%)	0 (0.0%)	0 (0.0%)	0 (0.0%)	0 (0.0%)	0 (0.0%)
ICL Lens Replacement, then Removal	1 (0.2%)	0 (0.0%)	0 (0.0%)	1 (0.2%)	0 (0.0%)	0 (0.0%)	0 (0.0%)
ICL Lens Replacement	8 (1.5%)	4 (0.8%)	2 (0.4%)	2 (0.4%)	0 (0.0%)	0 (0.0%)	0 (0.0%)
ICL Lens Removal	10 (1.9%)	0 (0.0%)	2 (0.4%)	1 (0.2%)	2 (0.7%)	4 (1.2%)	1 (0.3%)
Raised IOP Requiring Surgery ¹	20 (3.8%)	20 (3.8%)	0 (0.0%)	0 (0.0%)	0 (0.0%)	0 (0.0%)	0 (0.0%)
TOTAL	43 (8.2%)	28 (5.3%)	4 (0.9%)	4 (0.8%)	2 (0.7%)	4 (1.2%)	1 (0.3%)

¹ Refer to section on IOP for details.

²Percentage calculated as (n/N)*100.

Refractive Procedures

A total of 22/526 eyes (4.2%) underwent refractive procedures during the study; this consisted of 17/526 LASIK (3.2%) procedures and 5/526 Arcuate Keratotomy (AK) (1.0%) procedures, as seen in Table 56.

Table 56: Refractive Procedures Through ≥ 60 months – Post-Approval Continuation of Visian ICL Study

Refractive Procedure	≤ 12 Mo n/N (%)	>12-24 Mo n/N (%)	>24-36 Mo n/N (%)	>36-48 Mo n/N (%)	>48-60 Mo n/N (%)	≥ 60 mo n/N (%)	Total n/N (%)
LASIK	15/526 (2.9%)	1/524 (0.2%)	0/448 (0.0%)	0/256 (0.0%)	0/231 (0.0%)	1/117 (0.9%)	17/526 (3.2%)
AK	3/526 (0.6%)	2/524 (0.4%)	0/448 (0.0%)	0/256 (0.0%)	0/231 (0.0%)	0/117 (0.0%)	5/526 (1.0%)

¹Percentage calculated as (n/N)*100.

Best Corrected Visual Acuity (CDVA) Loss

Eighteen eyes of 16 subjects reported a significant vision loss of ≥ 2 lines in CDVA between 12 months and ≥ 60 months. Reasons for significant vision loss included cataract development (9 eyes), myopic degeneration (1 eye), retinal detachment (1 eye) and unknown etiology was reported for 4 eyes. For 3 eyes, decrease in CDVA was transient without intervention.

At the final study visit (which ranged from 18 to 62 months), 11 of these 18 eyes reported an improvement in CDVA of 2 to 10 lines compared to preoperative CDVA, attributed to cataract surgery, refractive surgery or reversal of transient

vision loss. In the remaining 7 eyes, vision loss of ≥ 2 lines was persistent at the final study visit (which ranged from 36 to 60 months).

The number of eyes reporting a decrease in either 2 lines or > 2 lines is reported in Table 57.

Table 57: CDVA Loss Through ≥ 60 months – Post-Approval Continuation of Visian ICL Study

Decrease in CDVA	12 Mo n/N (%) ¹	24 Mo n/N (%) ¹	36 Mo n/N (%) ¹	48 Mo n/N (%) ¹	60 Mo n/N (%) ¹	≥ 60 Mo n/N (%) ¹
Decrease >2 Lines	1/469 (0.2%)	2/456 (0.4%)	3/384 (0.8%)	1/242 (0.4%)	1/222 (0.4%)	2/331 (0.6%)
Decrease =2 Lines	2/469 (0.4%)	3/456 (0.6%)	1/384 (0.3%)	1/242 (0.4%)	2/222 (0.8%)	2/331 (0.6%)

¹Percentage calculated as (n/N)*100.

Lens Opacity and Visually Significant Cataract Formation

Table 58 provides the type of cataracts of grade trace or greater that developed over time for the PMA Study cohort. The long-term incidence of anterior subcapsular opacity secondary to implantation of the Visian ICL lens has been studied in 526 eyes of 294 subjects followed for up to 7.5 years, with 334 eyes available for analysis at 5 or more years. A total of 31 eyes developed an anterior subcapsular opacity.

Table 58: Cataract Through ≥ 60 months – Post-Approval Continuation of Visian ICL Study

Cataract Type	Preop n/N (%) ¹	<12 Mo n/N (%) ¹	12 Mo n/N (%) ¹	24 Mo n/N (%) ¹	36 Mo n/N (%) ¹	48 Mo n/N (%) ¹	60 Mo n/N (%) ¹	≥ 60 Mo n/N (%) ¹	Cumulative Number of Eyes
Nuclear	4/526 (0.8%)	4/526 (0.8%)	2/472 (0.4%)	1/457 (0.2%)	3/381 (0.8%)	0/245 (0.0%)	0/225 (0.0%)	3/334 (0.9%)	13
Cortical	2/526 (0.4%)	2/526 (0.4%)	0/472 (0.0%)	1/457 (0.2%)	4/380 (1.1%)	1/245 (0.4%)	0/225 (0.0%)	0/334 (0.0%)	8
Posterior Subcapsular	0/526 (0.0%)	0/526 (0.0%)	0/472 (0.0%)	0/457 (0.0%)	2/381 (0.5%)	0/245 (0.0%)	0/225 (0.0%)	2/334 (0.6%)	4
Anterior Subcapsular	0/526 (0.0%)	8/526 (1.5%)	3/472 (0.6%)	4/457 (0.9%)	2/381 (0.5%)	8/245 (3.3%)	2/225 (0.9%)	4/335 (1.2%)	31
Total Number of Eyes*	6	13	3	5	8	9	2	5	45

¹Percentage calculated as (n/N)*100.

*Final row may not sum to number of nuclear, cortical or subcapsular cataracts, as some eyes had multiple types of cataracts.

Visually significant cataracts of all types, involving a vision loss of ≥ 2 lines in CDVA, were reported in 9/526 eyes (1.7%) through the extended follow-up study period: 1 anterior subcapsular cataract (ASC) at 18 months, 3 ASC at 48 months and 1 surgically induced ASC which was reported to have a 2 line loss of CDVA at 24 months after ICL lens implantation; 1 nuclear cataract (NC) at 12 months, 1 at 30 months, 2 at 36 months.

Per eye, the risks of developing any anterior subcapsular opacity, developing a visually significant anterior subcapsular opacity, or of having cataract surgery for any type of cataract were calculated using Kaplan-Meier analyses. As provided in Table 59, these risks were 6.1%, 1.2% and 3.1% at 60 months and 12.4%, 1.2% and 3.1% at 84 months, respectively.

Table 59: Lens Opacification Risk Analysis – Post-Approval Continuation of Visian ICL Study

	≤12 Mo	>12 -24 Mo	>24-36 Mo	>36-48 Mo	>48-60 Mo	≥60 Mo
Any Anterior Subcapsular Opacity (ASC)						
Number at risk at period start	526	499	477	441	366	251
Events during period	9	4	3	4	7	4
Survival estimate at period end	98.3%	97.5%	96.9%	95.9%	93.9%	87.6%
1-survial estimate (risk)	1.7%	2.5%	3.2%	4.1%	6.1%	12.4%
Visually Significant ASC						
Number at risk at period start	526	507	487	450	379	261
Events during period	1	1	0	0	3	0
Survival estimate at period end	99.8%	99.6%	99.6%	99.6%	98.8%	98.8%
1-survial estimate (risk)	0.2%	0.4%	0.4%	0.4%	1.2%	1.2%
Cataract Surgery for Any Type of Cataract						
Number at risk at period start	526	505	484	448	376	258
Events during period	3	3	2	3	3	0
Survival estimate at period end	99.4%	98.8%	98.4%	97.7%	96.9%	96.9%
1-survial estimate (risk)	0.6%	1.2%	1.6%	2.3%	3.1%	3.1%

Intraocular Pressure (IOP)

a) Changes in IOP from Baseline

Postoperatively, IOP >25mmHg or an increase of >10mmHg over preoperative was reported in 14/526 eyes (2.7%) of the Visian ICL Lens PMA cohort through ≥ 60 months.

Table 60: Changes in IOP from Baseline Through ≥60 months – Post-Approval Continuation of Visian ICL Study

IOP (mmHg)	Preop n/N (% ¹)	1 D n/N (% ¹)	14 D n/N (% ¹)	1 Mo n/N (% ¹)	3 Mo n/N (% ¹)	6 Mo n/N (% ¹)	12 Mo n/N (% ¹)	24 Mo n/N (% ¹)	36 Mo n/N (% ¹)	48 Mo n/N (% ¹)	60 Mo n/N (% ¹)	≥60 Mo n/N (% ¹)
> 10 mmHg over Baseline	NA	23/526 (4.4%)	20/526 (3.8%)	12/524 (2.3%)	2/522 (0.4%)	0/511 (0%)	2/501 (0.4%)	2/469 (0.4%)	1/410 (0.2%)	2/348 (0.6%)	6/262 (2.3%)	4/263 (0.4%)
> 25mm Hg	0/526 (0%)	23/526 (4.4%)	16/526 (3.0%)	11/524 (2.1%)	2/522 (0.4%)	0/511 (0%)	2/501 (0.4%)	2/469 (0.4%)	1/410 (0.2%)	3/348 (0.9%)	7/262 (2.7%)	4/263 (0.4%)

¹Percentage calculated as (n/N)*100.

b) Raised IOP Requiring Surgery

A total of 20/526 eyes (3.8%) experienced raised IOP requiring intervention. An additional YAG iridotomy was performed on 17 of the eyes for pupillary block and 3 eyes had repeat irrigation and aspiration at 1 day postoperative to remove retained viscoelastic. All of these events occurred in the early postoperative period, most frequently at 1 to 2 days postoperative.

c) Raised IOP Requiring Pharmacologic Intervention

A total of 7 eyes of 4 subjects in the PMA cohort developed glaucoma during the clinical trial. Open angle glaucoma was diagnosed for 4 eyes (2 subjects) and the remaining 3 eyes of 2 subjects the type of glaucoma was not specified. None of these eyes required secondary surgical intervention for treatment of IOP during the study.

Upon gonioscopic examination, no anterior synechiae, transillumination defects, or abnormal angle depth was observed in any of these 7 eyes. However, abnormal pigmentation was observed in 6 eyes, with 2 eyes of a

single subject diagnosed with open angle glaucoma and possible secondary pigment dispersion at 6 years postoperatively.

Table 61: Glaucoma – Post-Approval Continuation of Visian ICL Study

<u>No. of Eyes</u>	<u>Type of Glaucoma</u>	<u>Onset</u>	<u>Abnormal Pigmentation</u>	<u>Anterior Synechiae</u>	<u>Transillumination Defects</u>	<u>Angle Depth</u>
1 (1 subject)	Unspecified	62 Mo	None	None	None	Normal
2 (1 subject)	Unspecified	5 Mo, 12 Mo	Yes	None	None	Normal
2 (1 subject)	Open Angle	37 Mo, 53 Mo	Yes	None	None	Normal
2 (1 subject)	Open Angle, possibly 2° pigment dispersion	71 Mo, 73 Mo	Yes	None	None	Normal

Gonioscopic Findings

In the post-approval study, investigators were asked to perform gonioscopy at the 48 Month (Form 9) and/or > 60 Month (Form 10) study visits. Specifically, investigators were to report on the absence or presence of peripheral anterior synechiae, the absence or presence of abnormal pigment suggestive of pigment dispersion and normal or abnormal angle depth.

Table 62: Gonioscopic Findings – Post-Approval Continuation of Visian ICL Study

<u>Finding</u>	<u>48 Month (Form 9)</u>			<u>≥ 60 Months (Form 10)</u>		
	<u>Absent</u>	<u>Present</u>	<u>Total*</u>	<u>Absent</u>	<u>Present</u>	<u>Total*</u>
	<u>%¹ (n)</u>	<u>%¹ (n)</u>		<u>%¹ (n)</u>	<u>%¹ (n)</u>	
Peripheral Anterior Synechiae	99.05% (104)	0.95% (1)	105	99.66% (293)	0.34% (1)	294
Abnormal Pigment Suggestive of Pigmentary Dispersion	95.28% (101)	4.72% (5)	106	94.00% (282)	6.00% (18)	300
	<u>Normal</u>	<u>Abnormal</u>	<u>Total</u>	<u>Normal</u>	<u>Abnormal</u>	<u>Total</u>
Angle Depth	99.05% (104)	0.95% (1)	105	100% (298)	0.00% (0)	298

*Total number of eyes with gonioscopy was performed at that visit. (N)

¹Percentage calculated as (n/N)*100.

Other Findings

At the 48 month visit, no “other findings” were reported. At the ≥ 60 month visit, there were a total of 24 comments reported under “other findings”. They were: “Heavy Pigment” (n = 8); “Moderate Pigment” (n = 8); “Light Pigment” (n = 4); “Transillumination defects” (n = 2) and “Myopic Degeneration and Pigment Changes in Macula” (n = 2).

Slit Lamp Findings

Table 63 summarizes the incidence of pigment on cornea, pigment on ICL lens and transillumination defects that occurred at different time points reported throughout the study follow-up period:

Table 63: Slit Lamp Findings – Post-Approval Continuation of Visian ICL Study

Finding/Onset	<12 Mo	12 Mo	24 Mo	36 Mo	48 Mo	≥ 60 Mo
	% ¹ (n/N)	% ¹ (n/N)	% ¹ (n/N)	% ¹ (n/N)	% ¹ (n/N)	% ¹ (n/N)
Pigment on cornea	0.0% (0/526)	0.0% (0/472)	0.0% (0/459)	0.0% (0/384)	0.0% (0/248)	1.2% (4/335)
Pigment on ICL lens	2.5% (13/526)	0.4% (2/472)	2.0% (9/459)	1.8% (7/384)	2.0% (5/248)	5.1% (17/335)
Transillumination defects	0.6% (3/526)	0.0% (0/472)	0.2% (1/459)	0.3% (1/384)	0.4% (1/248)	0.9% (3/335)

¹Percentage calculated as (n/N)*100.

Endothelial Cell Density (ECD)

Specular microscopy was performed on a subgroup of the original PMA study cohort with data available through ≥60 months postoperatively. A central reading center was used to minimize the inherent variability associated with endothelial cell counts.

Table 64 provides detail on the number of readable specular microscopy images captured at each time point in the study.

Table 64: Specular Microscopy – Post-Approval Continuation of Visian ICL Study

	Preop	3 Mo	12 Mo	24 Mo	36 Mo	48 Mo	60 Mo	72 Mo	84 Mo
Total Cohort (N)	526		472	459	384	248	225	86	44
Eyes with readable ECD n (% ¹)	192 (36.5%)	209	246 (52.1%)	220 (47.9%)	174 (45.3%)	146 (58.9%)	113 (50.2%)	37 (43.0%)	27 (61.4%)
Eyes with both Preop and Postop readable ECD n (% ¹)	NA	162	175 (37.1%)	151 (32.9%)	132 (34.4%)	109 (44.0%)	85 (37.8%)	15 (17.4%)	19 (43.2%)

¹Percentage calculated as (n/N)*100.

The analysis of ECD over time was conducted on eyes with both pre and postoperative ECD counts. Mean ECD results from clinical trial subjects are shown in Table 65.

Table 65: ECD Analysis Through ≥60 months – Post-Approval Continuation of Visian ICL Study

Visit	Mean	SD	90% Confidence Limits
Preop	2657	290	2622 to 2692
3 Mo	2570	340	2532 to 2609
12 Mo	2548	349	2511 to 2584
24 Mo	2479	357	2439 to 2518
36 Mo	2454	348	2411 to 2498
48 Mo	2396	367	2346 to 2447
≥60 Mo	2298	354	2252 to 2345

During the PMA trial and subsequent long-term follow-up of the PMA cohort, 13 eyes of 10 subjects (11.5% 13/113 of those available for evaluation ≥ 60 months after surgery) reported significant endothelial cell loss (> 30% loss of central ECD). Of these 13 eyes, 3 eyes of 3 subjects experienced this level of endothelial cell loss (30.8 – 45.6%) between baseline and the first 12 months of follow-up, and it was presumed to be the result of surgery; the remaining

10 eyes of 7 subjects had this level of endothelial cell loss (30.9 – 42.6%) at the final study visit (≥ 60 months, between 5.0 and 6.7 years).

Table 66: ECD loss from Preoperative Values – Post-Approval Continuation of Visian ICL Study

ECD loss from Preop (%)	12 Mo	36 Mo	≥ 60 Mo
	N=175	N=132	N=115
	n (%) ¹	n (%) ¹	n (%) ¹
≥10%	22 (12.6%)	44 (33.3%)	77 (67.0%)
≥15%	8 (4.6%)	22 (16.7%)	50 (43.5%)
≥20%	4 (2.3%)	12 (9.1%)	30 (26.1%)
≥30%	3 (1.7%)	2 (1.5%)	13 (11.3%)

¹Percentage calculated as (n/N)*100.

The available data from the clinical study demonstrate a mean percentage change from baseline to 60 months of 12.3% (SD 9.4%), based on subjects with data at both baseline and ≥ 60 months.

Table 67 provides the mean, standard deviation, median, interquartile range, and range of percent change in ECD. These data represent changes in ECD between:

- The preoperative visit and the 12 month visit (for all eyes with ECD data at both visits);
- The 1 year visit to the 3 year visit (for all eyes with ECD data at both visits); and
- The 3 year visit to the final visit at 5 years or later (for all eyes with ECD data at both visits)

Table 67: Change in ECD over Time – Post-Approval Continuation of Visian ICL Study

Endothelial Cell Density	For all eyes with ECD data at both visits:		
	Preoperative Visit to 12 month visit	1 year visit to 3 year visit	3 year visit to Final Visit at 5 years or later
N (ECD observations with data at both visits)	175	150	108
Mean (SD) % Change in ECD	-3.19 (7.59)	-5.04 (8.09)	-6.74 (5.15)
Median % Change in ECD	-2.45	-4.27	-6.24
Interquartile Range % Change in ECD (Q1 to Q3)	0.97 to -2.45	-1.41 to -4.27	-3.04 to -9.93
Range (Min, Max) % Change in ECD	16.22,-42.94	11.62, -23.15	4.27, -22.52

The following table provides the predicted percent endothelial cell loss, by year, for a hypothetical patient with preoperative ECD equal to the mean level in the clinical study. For this hypothetical patient, there is 90% confidence that the endothelial cell loss will be between the lower and upper prediction interval bounds at each point in time. The entries in this table are calculated assuming a bi-exponential loss in ECD, i.e., a rapid initial phase of cell loss in the early postoperative period related to surgical trauma, followed by a slow, chronic phase of cell loss thereafter. Rates of predicted long term loss are derived from clinical data collected through 5 to 7 years postoperatively. The calculated chronic rate of loss from this post-approval data is approximately 1.8% per year.

Table 68: Predicted Percent Endothelial Cell Loss

Time from procedure	Predicted Percent Cell Loss	90% prediction interval*	
		Lower	Upper
3 months	1%	-20%	23%
1 year	4%	-18%	25%
2 years	5%	-16%	27%
3 years	8%	-14%	29%
4 years	9%	-12%	31%
5 years	11%	-10%	33%

10 years	20%	-2%	42%
15 years	28%	6%	50%
20 years	35%	13%	57%
25 years	42%	19%	64%
30 years	47%	25%	70%
35 years	53%	30%	75%
40 years	57%	35%	80%
45 years	62%	39%	84%
50 years	66%	43%	88%
55 years	69%	46%	92%

*Note: Positive values represent levels of % ECD loss; negative values represent levels of % ECD gain.

Other Complications

No cases of endophthalmitis, hyphema, hypopyon, cystoid macular edema or corneal ulcer were reported during the study. Corneal haze, corneal edema or iritis were not reported after the 1 week visit. One case each of iris prolapse (1/526, 0.2%), macular hemorrhage (1/526, 0.2%) and subretinal hemorrhage (1/526, 0.2%) were reported at 1 day, 1 week and 3 months postoperative, respectively. Retinal detachment was reported in 3 eyes (3/526, 0.6%) at 4, 22 and 31 months after Visian ICL lens implantation.

A case of anisocoria (unequal pupil size) has been reported for a subject implanted with an ICL lens in another clinical trial.

Study Strengths and Limitations

This post-approval study uses the original IDE study cohort, following patients who had already completed 36 months of follow-up; therefore, long-term data (60-months or later) is available sooner as opposed to a new-enrollment study. Additionally, this is the only post-approval sub-study that collected ECD data. However, the 60 month follow-up rate of 65.3% (335/515) is less than optimal. Biases could have been introduced into the study results because of the loss to follow-up, which could limit the generalizability of the study results.

POST-APPROVAL STUDY OF THE EFFECT OF THE VISIAN ICL LENS ON AXIAL LENGTH MEASUREMENT

The Visian ICL lens was evaluated in a prospective, non-randomized study of 30 eyes of 30 subjects to assess the effect of the lens on the measurement of the eye's axial length, and to determine whether the ICL lens affects this measurement. Study inclusion criteria were:

- Moderate to high myopia (-3D to -20D measured as spherical equivalent of the manifest refraction) scheduled to undergo implantation of the commercially available Myopic Visian ICL lens.
- Subject meets all of the Indications for Use criteria for the commercially available Myopic Visian ICL lens.
- Ability to be measured with the IOL Master Axial Length measurement device.
- Willingness to comply with the sub-study preoperative and postoperative visit requirements.

There were no study exclusion criteria.

The subjects underwent implantation of the commercially available Visian ICL lens. The axial length was measured preoperatively and between one week and one month postoperatively. All axial length measurements were obtained using a Carl Zeiss IOL Master, a non-contact partial coherence laser interferometer. The difference in the pre and postoperative axial length was calculated individually for each eye.

Of the 30 subjects, 11 were male, 19 female, 29 Caucasian and 1 Asian. The ICL lens power of the lens implanted averaged -10.68D (range -3.50D to -16.00D). The preoperative axial length averaged 27.28mm (range 23.69mm to 34.32mm) and the postoperative axial length averaged 27.28mm (range 23.72mm to 34.51mm). The average difference in preoperative and postoperative axial lengths is -0.02mm (range -0.23mm to + 0.19mm).

The correlation coefficient was calculated based on a regression analysis on the pre and postoperative data. The results of the analysis show that the variance preoperative is statistically equivalent to the variance postoperative at

95% confidence. The average difference of -0.02mm in axial length measurement pre and postoperative would change IOL power prediction by 0.05D, which is well below the measurement of error of IOL power manufacturers.

The data in this study suggests that the ICL lens has a negligible influence on axial length measurements for IOL power calculations, when measurements are based on partial coherence laser interferometry. The accuracy of ultrasound-based measurement of axial length is unknown.

Study strengths include its representative sample (no exclusion criteria) and relevance to clinical questions surrounding axial measurement. Study limitations include its applicability only to laser interferometry-based measurement and not to ultrasound measurement of axial length, and the use of only 2 investigational sites.

POST APPROVAL ADVERSE EVENT STUDY - VISIAN ICL LENS FOR MYOPIA

A survey study was conducted in the US after Visian ICL lens for Myopia was approved by the FDA. The goal of this study was to collect safety information from patients who had ICL surgery in the general population. All patients who consented to participate were asked to complete surveys at scheduled times up to 5 years after their Visian MICL surgery. The surveys asked patients to report any complications or additional eye surgeries because of the MICL lens.

Description of the Study Patient Group:

- 2999 eyes of 1547 patients implanted with the Visian MICL lens participated;
- Most patients were white (Caucasian) and over half of the patients were female;
- Patients ranged from 17 to 77 years of age at time of surgery.

The surveys asked for information about the following adverse events:

- Problems with endothelial cells;
- Cataract formation;
- Medical treatment for inflammation inside the eye;
- Medical treatment for intraocular pressure and damage to the optic nerve caused by glaucoma;
- Surgery because of retinal detachment;
- Surgery to remove, replace or reposition the Visian ICL lens;
- Other complications in the eye.

The cumulative incidence per eye for each of the events assessed in the survey in addition to the cumulative incidence of the same events from the MICL Lens PMA clinical study for comparison are presented in **Table 69**.

Table 69: MICL Cumulative AEs – Post-Approval AE Study, Comparison to PMA Clinical Study

	Survey Questionnaire	PMA Study
	60 months - Cumulative % ¹ , (n/N)	≥ 60 months - Cumulative % ¹ , (n/N)
1-Corneal problems	0.3%, (5/2999)	0%, (0/526) Corneal Edema (after 1 week)
2-Cataract development	5.1%, (154/2999)	8.6%, (45/526)
3-Treated intraocular inflammation	0.5%, (14/2999)	0.0%, (0/526)
4-Treated IOP or glaucoma	1.6%, (47/2999)	1.3%, (7/526)
5-Retinal Detachment Surgery	0.4%, (13/2999)	0.6%, (3/526)
6-Remove, replace or reposition ICL lens	4.2%, (126/2999)	4.3%, (23/526)

¹Percentage calculated as (n/N)*100.

The MICL Lens PMA clinical study only enrolled subjects ≤ 45 years of age. A comparison of the cumulative incidence of the events between the PMA Clinical Study and the survey questions for patients ≤ 45 years of age at the time of ICL surgery are provided in Table 70.

Table 70: Cumulative AEs, Comparison to MICL PMA Clinical Study (Ages ≤ 45 yrs old at time of Surgery)

	Survey Questionnaire	PMA Study
	60 months - Cumulative % ¹ , (n/N)	≥ 60 months - Cumulative % ¹ , (n/N)
1-Corneal problems	0.0%, (0/2527)	0%, (0/526) Corneal Edema (after 1 week)
2-Cataract development	3.0%, (75/2527)	8.6%, (45/526)
3-Treated intraocular inflammation	0.5%, (13/2527)	0.0%, (0/526)
4-Treated IOP or glaucoma	1.5%, (38/2527)	1.3%, (7/526)
5-Retinal Detachment Surgery	0.3%, (7/2527)	0.6%, (3/526)
6-Remove, replace or reposition ICL lens	2.9%, (74/2527)	4.3%, (23/526)

¹Percentage calculated as (n/N)*100.

Glare was reported for 2.8% (85/2999) and halos were reported for 5.2% (156/2999) of all implanted eyes in the survey study. The cumulative per eye incidence of glare and halo at 36 months after surgery from the survey questionnaire was compared to the PMA clinical study data on worsening of glare and halo at 36 months compared to baseline. The comparison between the studies is made for patients ≤ 45 years of age at the time of ICL surgery and is provided in Table 71.

Table 71: Cumulative reports of Glare and Halos at 36 Months, Comparison to PMA Study, (Ages ≤ 45 yrs old at time of Surgery)

	Survey Questionnaire	PMA Study
	% ¹ , (n/N)	% ¹ , (n/N)
Glare	2.6%, (66/2527)	9.6%, (34/351)
Halos	5.6%, (142/2527)	11.5%, (40/350)

¹Percentage calculated as (n/N)*100.

Overall, patient responses to surveys provided similar information to what was found in the FDA safety and effectiveness clinical study of 526 eyes of 294 patients. This study included patients over 45 years of age. This age group was not included in the FDA safety and effectiveness study of the Visian ICL lens. These older patients reported a higher rate of cataracts and need for a second surgery than patients who were 45 or younger at the time of initial Visian ICL surgery.

INSTRUCTIONS FOR USE

CAUTION

Implantation of an EVO ICL lens should only be attempted by a surgeon who is highly skilled in the required surgical technique and has completed the EVO ICL Certification Program.

CAUTION

Do not use ICL lens if package has been opened or damaged. The sterility of the lens may be compromised.

ICL Lens Handling Precautions

1. Choice of the proper ICL lens size should be carefully considered prior to surgery.
2. Check the label of the ICL lens package for proper lens model and power.
3. Open the package to verify the dioptric power of the lens.
4. Handle the ICL lens by the haptic portion. Do not grasp the optic with forceps as this could potentially lead to damage to the smooth anterior and posterior optical surfaces.
5. Never touch the center of the optic with instruments once the ICL lens is placed inside the eye. Inadvertent pressure through the optic could potentially damage the central crystalline lens resulting in a lens opacity.
6. STAAR Surgical recommends using only the LIOLI-24 and MicroSTAAR® Injector systems (Models MSI-TF and MSI-PF with SFC-45 Cartridge), to insert the ICL lens in the folded state.
7. The ICL lens should be carefully examined in the operating room prior to implantation.
8. The ICL lens should not be exposed to any solutions other than the normally used intraocular irrigating solutions (e.g., isotonic saline, BSS, viscoelastic, etc.)
9. Keep the ICL lens moist. It is recommended that the ICL lens be held in sterile BSS solution prior to implantation.
10. The ICL lens should be handled carefully. No attempt should be made to reshape or cut any portion of the lens. Do not apply undue pressure to the ICL lens optical portion with a sharp object since this could perforate the optic.
11. The intended location of the ICL lens is behind the iris within the posterior chamber and in front of the anterior capsule of the crystalline lens.
12. The TICL lens is manufactured so that rotation of no more than 22.5 degrees (2/3 clock hours) is necessary.
13. It is recommended that the surgeon not rotate the TICL lens more than 22.5 degrees from horizontal.
14. Complete irrigation and aspiration of viscoelastic from the eye after completion of the surgical procedure is essential. Viscoelastic products that may be difficult to aspirate should not be used.

NOTE

The long term effects of phakic IOL implantation have not been determined. Physicians should continue to monitor implant patients postoperatively on a regular basis.

SURGICAL PRECAUTIONS/INFORMATION

Preoperative Information

Preoperative ECD Measurements

An ECD measurement should be performed preoperatively to determine if candidates meet the minimum ECD requirements based upon age and true ACD. The true ACD is defined as the distance from the apex of the **posterior** corneal surface to the apex of the anterior crystalline lens surface. Many measuring devices provide an ACD measurement defined as the distance from the apex of the **anterior** corneal surface to the apex of the anterior crystalline lens surface. If the surgeon is using an instrument that measures from the anterior corneal surface, the thickness of the cornea must be subtracted to get the true ACD.

ICL Lens Length Determination

During the original US PMA clinical study, sizing of the ICL myopic lenses (12.1mm to 13.7mm) was determined by the horizontal white-to-white and the ACD measurements (true ACD, defined as the distance from the apex of the posterior corneal surface to the apex of the anterior crystalline lens surface). For eyes with ACD measurements of ≤ 3.5 mm, the lens size was calculated by adding 1.1mm to the horizontal white-to-white measurement. Eyes exhibiting an ACD greater than 3.5mm required the addition of up to 1.6mm to the white- to-white measurement, up to a maximum length of 13.7mm. Calculated lens sizes between the available lens diameters (in 0.5mm steps) were generally rounded down if the ACD was ≤ 3.5 mm and rounded up if the ACD was >3.5 mm.

Analyses of all of the collected clinical data resulted in slightly modified recommendations for sizing of the ICL lens as compared to those used in the clinical trial. A table of recommended ICL lens lengths based upon white-to-white and ACD measurements is given below.

Table of Recommended ICL Lens Overall Diameter by White to White and ACD Measurements

White-to-White (mm)	True ACD (mm)		
	All	≤3.5	>3.5
<10.5	Not Recommended	—	—
10.5-10.6	—	Not Recommended	12.1
10.7-11.0	12.1	—	—
11.1	—	12.1	12.6
11.2-11.4	12.6	—	—
11.5-11.6	—	12.6	13.2
11.7-12.1	13.2	—	—
12.2	—	13.2	13.7
12.3-12.9	13.7	—	—
≥13	Not Recommended	—	—

White-to-White Measurements

The white-to-white measurement is an indirect measurement and does not correlate with sulcus-to-sulcus measurements. Newer advancements in the direct measurement of the ciliary sulcus such as ultrasonic biomicroscopy (UBM) should be considered as alternative methods for the determination of the desired ICL lens overall diameter. At present there is no large series study demonstrating the effectiveness of UBM in ICL lens sizing.

Learning Curve/Individual Surgeon Variability Issues

A learning curve and individual surgeon variability was seen in the clinical trial in terms of early anterior subcapsular lens opacities, removals and reinsertions of the ICL lens at the time of surgery, and ICL lens replacements due to sizing.

Refraction:

A cycloplegic refraction is recommended to confirm the accuracy of the manifest refraction.

ICL Lens Power Calculation

Implantation of the ICL lens requires that a preoperative determination of the dioptric power of the implanted lens be calculated. Achievement of emmetropia is not necessarily a desirable postoperative goal and factors such as visual status of the fellow eye and patient lifestyle should be considered when determining the lens power to be used.

In order to achieve refractive results similar to those found in the PMA study, ICL lens power and size calculation should be performed using the STAAR ICL Calculation Software. (www.ocos.STAAR.com).

The ICL calculator will recommend a range of spherical powers along with their expected postoperative values (i.e. residual sphere); or a cylinder power and a range of spherical powers along with their expected postoperative values (i.e. residual sphere, cylinder, axis and spherical equivalent). Selection of lens power is based on the treatment plan of the surgeon for a given eye.

In all cases it is recommended the ICL lens be implanted horizontally in the eye through a temporal incision.

TICL Lens Implantation Orientation

As part of the implantation procedure, the TICL lens may need to be rotated up to 22.5 degrees clockwise or counterclockwise from the 0°-180° meridian in order to align the lens axis at the preoperative plus cylinder axis. The surgeon should mark the horizontal axis (0°-180°) of the eye at the slit lamp prior to surgery. These horizontal axis marks will be used as reference points to mark the desired orientation of the lens under the operating microscope, using a suitable corneal axis marking device. For example, if the preoperative plus cylinder axis is at 136° and the lens selected has the cylinder axis at 115°, the lens will need to be rotated 21° counterclockwise from the temporal meridian in eye. In this case the desired axis marked on the cornea would be 21° counterclockwise from the 0°-180° meridian. The online ordering software for the TICL lens is designed to generate an Implantation Orientation Diagram (IOD) to guide the surgeon in determining the amount and direction of rotation for the specific lens selected. See example below:

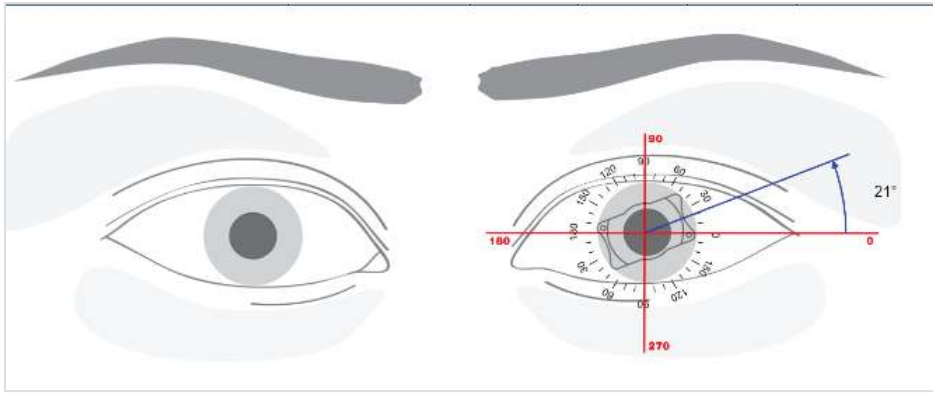

Intraoperative Information

Preparation of the lens for use

CAUTION

Perform the following steps in a sterile field.

- Inspect the lens vial. Ensure that it is not damaged.
- While keeping the vial in a vertical position, remove the aluminum seal and remove the cap.
- Carefully remove the lens from the vial.
- Examine the lens carefully under the microscope for damage or particulate matter.

CAUTION

Do not allow the ICL lens to dry after removal from the glass vial.

Delivery System

STAAR Surgical recommends using only the LIOLI-24 and MICROSTAAR® Injectors, Model MSI-TF or MSI-PF with SFC – 45 Cartridge. For detailed loading instructions, see information provided with the MSI injection system, or with the lens for the LIOLI-24 delivery system.

CAUTION

The ICL lens should be injected within 1-2 minutes after loading. Viscoelastic materials tend to lose their lubricity if exposed to air too long.

Viscoelastic Usage

Complete removal of viscoelastic from the eye after completion of the surgical procedure is essential. Irrigation for a minimum of one minute with at least 10 – 20 cc of solution is recommended. STAAR Surgical recommends a low molecular weight 2% hydroxypropyl methylcellulose (HPMC) or dispersive, low viscosity ophthalmic viscosurgical device. Do not use short chain sodium hyaluronate acids (viscoelastics) due to increased risk of cataract formation related to trapped viscoelastic.

Inadequate flushing of the viscoelastic from the eye may lead to IOP spikes. IOP should be checked 1 - 6 hours postoperatively so that elevated IOP may be treated in a timely manner.

Postoperative Information

Postoperative ICL Lens Vault

Lens vault (the distance between the anterior surface of the crystalline lens and the posterior surface of the ICL lens) should be assessed 24 hours postoperatively at a slit lamp. Although the postoperative vault of the ICL lens is intended to be approximately equal to the central corneal thickness, we believe that the optimal vault should be between 50% and 150% of central corneal thickness, this being equivalent to a range of 250 to 900 microns. However, in the absence of symptoms, lens vault outside of this range may not necessarily require exchange or removal.

ICL Lens Removal

It is recommended that the ICL lens be removed in cases where the vault is insufficient and the patient exhibits early anterior subcapsular cataract. Removal of the ICL lens may be necessary in cases where the vault is excessive causing narrowing of the anterior chamber angle, thus decreasing aqueous flow. ICL lens removal may also be necessary for other reasons on an individual basis. The risks involved in ICL lens replacement have not been studied and are unknown.

Axial Length Measurement Correction for Intraocular Lens (IOL) Power Calculation

The accuracy of ultra-sound based measurement of axial length in an eye with an ICL lens is unknown. Axial length measurements based upon partial coherence laser interferometry appear to not be significantly affected by implantation of the ICL lens. See section on "Post-Approval Study of the Effect of the Visian ICL on Axial Length Measurement."

NOTE

More detailed information regarding the recommended Surgical Technique is provided in conjunction with STAAR's ICL Physician Certification Program.

MRI Safety Information

The EVO ICL lens is MR Safe.

SURGICAL PROCEDURE

All physicians must complete the STAAR Surgical ICL (ICL) Physician Certification Program prior to using the ICL lens in a clinical setting.

PATIENT REGISTRATION

Each patient who receives an ICL lens must be registered with STAAR Surgical at the time of lens implantation. Registration is accomplished by completing the Implant Registration Card that is enclosed in the lens package and mailing it to STAAR Surgical. Patient registration is essential to STAAR Surgical's long term patient follow-up program and will assist STAAR Surgical in responding to Adverse Reaction Reports and/or potentially sight-threatening complications. An Implant Identification Card is supplied in the unit package. This card should be given to the patient with instructions to keep it as a permanent record of the implant and to show the card to any eye care practitioner seen in the future.

REPORTING

Adverse Reactions and/or potentially sight-threatening complications that may reasonably be regarded as lens related and that were not previously expected in nature, severity or degree of incidence should be diligently reported to STAAR Surgical immediately at:

USA Phone: (800) 352-7842
Fax: (800) 952-4923

This information is being requested from all surgeons in order to document potential long-term effects of ICL lens implantation, especially in younger patients. Physicians must report these events in order to aid in identifying emerging or potential problems with the ICL lens.

HOW SUPPLIED

Each ICL lens is provided sterile and non-pyrogenic in sealed vials within a sterile thermoform tray placed in a box with labels and product information. The tray and vial containing the ICL lens are sterilized with steam and should be opened only under sterile conditions.

EXPIRATION DATE

The expiration date on the device package and unit box is the sterility expiration date. If the tray seal and vial seal are not punctured or damaged, sterility is assured until the expiration date indicated on the package label. This device should not be used past the indicated sterility expiration date.

RETURN POLICY FOR STAAR ICL Lenses

Contact STAAR Surgical. The ICL lens should be returned dry. Do not attempt to rehydrate.

LENS SPECIFIC RECOMMENDATION

The physician must use the STAAR recommended Injector and Cartridge delivery system for implanting the ICL lens in the folded state.

WARRANTY AND LIMITATION OF LIABILITY

STAAR Surgical Company warrants that reasonable care was taken in making this product. STAAR Surgical Company shall not be responsible for any incidental or consequential loss, damage, or expense which arises directly or indirectly from the use of this product. Any liability shall be limited to the replacement of any STAAR ICL lens which is returned to and found to be defective by STAAR Surgical Company.

This warranty is in lieu of and excludes all other warranties not expressly set forth herein, whether expressed or implied by operation of law or otherwise, including but not limited to, any implied merchantability or fitness for use.







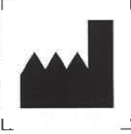

STORAGE

Store the ICL lens at room/ambient temperature.

WARNING

Do not autoclave the ICL lens. Do not expose to temperature greater than 40 °C. Do not freeze. If temperature requirements are not met, return the ICL lens to STAAR Surgical.

SYMBOLS GLOSSARY

<i>Symbol*</i>	Reference Number and Title	Explanatory Text
	5.1.1 Manufacturer	Medical device manufacturer
	5.1.3 Date of Manufacture	Date of manufacture
	5.1.4 Use-by-date	Use by (YYYY-MM-DD)
	5.1.7 Serial Number	Serial number
	5.2.1 Sterile	Sterile
	5.2.5 Sterilized using steam	Sterilized using steam.
	5.2.6 Do not re-sterilize	Medical device is not to be re-sterilized
	5.4.2 Do not re-use	Do not reuse
	5.2.8 Do not use if package is damaged	Do not use if the product sterile barrier system or its package is compromised.



5.4.3 Consult instructions for use	Consult electronic instructions for use
------------------------------------	---



5.4.4 Caution	Consult the instructions for use for important cautionary information
---------------	---

* ISO 15223-1 Medical devices – Symbols to be used with medical device labels, labelling and information to be supplied – Part 1: General requirements.