

Table of Contents

Title 51 PUBLIC HEALTH—SANITARY CODE

Part I. General Provisions

Chapter 1. General	1
§101. Definitions [formerly paragraph 1:001].....	1
§103. Severability [formerly paragraph 1:006]	2
§105. Administrative Enforcement Procedures [formerly paragraph 1:007-1].....	2
§107. Delivery of the Notice of Violation [formerly paragraph 1:007-2]	2
§109. Service of Orders, Notices, and Other Documents	3
§111. Reinspection and Compliance Order [formerly paragraph 1:007-5].....	3
§113. Suspension/Revocation/Civil Fines or Penalties [formerly paragraph 1:007-21]	4
§115. Emergency Situations [formerly paragraph 1:007-21]	5
§117. Employee Health.....	5
§119. Plans and Permits.....	6
§120. Duty of Permit, Certificate, or License Applicant or Holder to provide the State Health Officer with both a Valid, Current Mailing and E-Mail Address.....	6
§121. Effective Date of Code [formerly paragraph 1:011].....	6
§123. Exemptions from Code [formerly paragraph 1:011]	6
§124. Variances from Code	7
§125. Alternate Administrative Enforcement Procedures [formerly 1:007-24].....	7

Part II. The Control of Diseases

Chapter 1. Disease Reporting Requirements	9
§101. Definitions [formally paragraph 2:001].....	9
§103. Public Notice of Reportable Diseases [formerly paragraph 2:002]	10
§105. Reportable Diseases and Conditions [formerly paragraph 2:003].....	10
§107. Laboratory and Healthcare Facility Reporting Requirements (Formerly §113).....	13
§109. Reports by Emergency Departments (Formerly §105.A.5).....	15
§111. Reports by Hospitals.....	15
§113. Reports Required of Parents, Schools and Day Care Centers (Formerly §111).....	15
§115. Investigations [formerly paragraph 2:009]	15
§117. Disease Control Measures Including Isolation/Quarantine [formerly paragraph 2:011]	16
§119. Duty of Custodians of Medical Records [formerly paragraph 2:012]	16
§121. Special Tuberculosis Control Measures [formerly paragraph 2:014-1 and Appendix A].....	16
§123. Ventilation Requirements for Housing TB Patients in Hospitals and Nursing Homes [formerly paragraph 2:014-2]	20
Chapter 3. Testing of Newborn Infants.....	21
§301. Measures to Prevent Ophthalmia Neonatorum at Time of Birth of an Infant [formerly paragraph 2:020].....	21
Chapter 5. Health Examinations for Employees, Volunteers and Patients at Certain Medical Facilities	21
§501. Employee Health [formerly paragraph 2:021].....	21
§503. Mandatory Tuberculosis Testing	21
§505. Required Medical Examinations of All Persons Admitted to Nursing Homes and Residential Facilities [formerly paragraph 2:026]	22

Table of Contents

Chapter 7. Public Health Immunization Requirements..... 23
 §701. Immunization Schedule [formerly paragraph 2:025]..... 23
 §703. Mandatory Immunization Reporting 23
Chapter 9. Prevention and Control of Yellow Fever..... 24
 §901. Definitions [formerly paragraph 2:029]..... 24
 §903. Background and Legal Authority [formerly paragraph 2:030]..... 24
 §905. Yellow Fever Regulations [formerly paragraph 2:031]..... 24
 §907. Application Procedures [formerly paragraph 2:032] 25

Part III. The Control of Rabies and Other Zoonotic Diseases

Chapter 1. Anti-Rabies Vaccination Requirements for Dogs and Cats 27
 §101. Definitions [formerly paragraph 3:001]..... 27
 §103. Mandatory Vaccinations of Dogs, Cats, and Ferrets [formerly paragraph 3:002] 27
 §105. Human Exposure to Domestic Animal Bites [formerly paragraph 3:003] 27
 §107. Domestic Animals Bitten by Rabid Animals [formerly paragraph 3:004]..... 28
 §109. Animals Suspected of Being Infected with Rabies [formerly Paragraph 3:006]..... 28
 §111. Confinement or Quarantine of Animals [formerly paragraph 3:007]..... 28
Chapter 3. Other Zoonotic Diseases..... 28
 §301. Definition 28
 §303. Prohibition on Importation/Sale of Prairie Dogs 29

Part IV. Lead Poisoning Control

Chapter 1. Lead Contamination 31
 §101. Definitions [formerly paragraph 4:001]..... 31
 §103. Health Hazard Condition [formerly paragraph 4:002] 31
 §105. Day Care Facilities [formerly paragraph 4:003]..... 31
 §107. Inspection of Premises [formerly paragraph 4:004] 32
 §109. Required Control Measures [formerly paragraph 4:006] 32
 §111. Verified Abatement [formerly paragraph 4:007]..... 32

Part V. Disease Vector Control

Chapter 1. Mosquito Control..... 33
 §101. Definitions [formerly paragraph 5:001]..... 33
 §103. General Mosquito Control Regulations [formerly paragraph 5:002] 33
 §105. Approval of Community Abatement Plans [formerly paragraph 5:025] 34
Chapter 3. Rodent Control 34
 §301. Definitions [formerly paragraph 5:026]..... 34
 §303. General Rodent Control Regulations [formerly paragraphs 5:027]..... 34
 §305. Regulations for Rodent-Proofing of Existing Buildings [formerly paragraphs 5:031] 34
 §307. Regulations for Rodent-Proofing New Buildings [formerly paragraphs 5:041] 35
 §309. Rodent Control Regulations for Curb or Farmer's Markets [formerly paragraph 5:044]..... 36
 §311. Regulations to Control Rodents from Floating Vessels [formerly paragraphs 5:045] 36
 §313. Approval of Plans to Abate Community Rodent Problems [formerly paragraph 5:049] 36
Chapter 5. Control of Domestic Flies and Other Arthropods of Public Health Importance 36
 §501. Definitions [formerly paragraph 5:050]..... 36
 §503. Refuse Regulations [formerly paragraph 5:051] 36

Part VI. Manufacturing, Processing, Packing and Holding of Food, Drugs and Cosmetics

Chapter 1.	General Regulations, Definitions, Permits, Registration, Machinery, Equipment and Utensils, Premises and Buildings, Temperature Control.....	39
§101.	Definitions [formerly paragraph 6:001].....	39
§103.	Permits [formerly paragraph 6:002]	40
§105.	Registration of Foods, Drugs, Cosmetics and Prophylactic Devices [formerly paragraph 6:008-1]	41
§107.	Prohibited Equipment; Exception [formerly paragraph 6:009-1].....	41
§109.	Lighting/Ventilation, Plans Submission, Construction and Materials; Insect and Rodent Control; Sanitary Facilities [formerly paragraph 6:010]	41
§111.	Premises—Drainage, Litter and Waste or Refuse, Weeds and Grass [formerly paragraph 6:019].....	42
§113.	Water Supply—Ample Supply, Not Cross-Connected, Drinking Fountains [formerly paragraph 6:022].....	42
§115.	Machinery, Equipment and Utensils [formerly paragraph 6:024]	43
§117.	Containers [formerly paragraph 6:026]	43
§119.	Bottle Washers [formerly paragraph 6:029]	43
§121.	By-Products and Waste Material [formerly paragraph 6:033]	43
§123.	Temperature Control [formerly paragraph 6:038]	44
§125.	Food Processing Plan.....	44
§127.	Food Recall Plan.....	44
§129.	Laboratory Test Reporting Requirements and Additional Test Mandate.....	45
Chapter 3.	Current Good Manufacturing Practices in Manufacturing, Processing, Packing or Holding Human Food	45
§301.	General Provisions; Code of Federal Regulations [formerly paragraph 6:039]	45
§303.	Definitions [formerly paragraph 6:040].....	45
§305.	Requirements Affecting Employees; Personnel [formerly paragraph 6:041]	45
§307.	Education and Training [formerly paragraph 6:051]	46
§309.	Supervision of Personnel [formerly paragraph 6:052]	46
§311.	Plants and Grounds [formerly paragraph 6:053]	46
§313.	Plant Construction and Design [formerly paragraph 6:057].....	46
§315.	Sanitary Facilities and Controls [formerly paragraph 6:063]	47
§317.	Plumbing [formerly paragraph 6:066]	47
§319.	Toilet Facilities [formerly paragraph 6:068]	47
§321.	Hand Washing Facilities [formerly paragraph 6:069]	47
§323.	Rubbish and Offal Disposal [formerly paragraph 6:070]	47
§325.	Sanitary Operations—General Maintenance [formerly paragraph 6:071]	48
§327.	Animal, Vermin and Pest Control [formerly paragraph 6:072].....	48
§329.	Sanitation of Equipment and Utensils [formerly paragraph 6:073].....	48
§331.	Storage and Handling of Equipment and Utensils [formerly paragraph 6:074]	48
§333.	Equipment and Procedures—General [formerly paragraph 6:075]	48
§335.	Use of Polychlorinated Biphenyls (PCB) in Food Plants [formerly paragraph 6:076]	49
§337.	Management and Abatement of PCB within Food Plants [formerly paragraph 6:077]	49
§339.	Toxicity of PCB Replacement Fluids [formerly paragraph 6:078]	49
Chapter 5.	Bakeries and Manufacturing Confectioneries	49
§501.	Definitions [formerly paragraph 6:080].....	49
§503.	Required Permits [formerly paragraph 6:081].....	50
§505.	Building Construction Requirements [formerly paragraph 6:082].....	50

Table of Contents

§507.	Equipment [formerly paragraph 6:084]	50
§509.	General Provisions; Time/Temperature Controls for Preparation of Fresh Custard and Cream Fillings [formerly paragraph 6:085]	51
§511.	Premises [formerly paragraph 6:101]	52
Chapter 7.	Food Storage Warehouse and Food Salvaging Operations	52
§701.	Definitions [formerly paragraph 6:110]	52
§703.	Permits [formerly paragraph 6:111]	52
§705.	Building Construction [formerly paragraph 6:112]	52
§707.	Premises [formerly paragraph 6:117]	52
§709.	Water Supply [formerly paragraph 6:120]	53
§711.	Employee Health [formerly paragraph 6:122]	53
§713.	Operational Requirements [formerly paragraph 6:123]	53
§715.	Salvaged Food Package Labeling Requirements [formerly paragraph 6:129]	53
§717.	Salvaged Food Bulk Placard Requirements [formerly paragraph 6:130]	53
§719.	Salvaged Food Labeling Responsibility [formerly paragraph 6:131]	53
Chapter 9.	Processing and Bottling of Bottled Drinking Water	54
§901.	Definitions [formerly paragraph 6:132]	54
§903.	Bottled Drinking Water Permits [formerly paragraph 6:132-1]	54
§905.	Bottled Water for Emergencies [formerly paragraph 6:132-2]	54
§907.	Water Bottling Plant Construction and Design [formerly paragraph 6:133-1]	55
§909.	Product and Operation Water Supplies; Sanitary Facilities [formerly paragraph 6:134]	55
§911.	Cleaning and Sanitizing [formerly paragraph 6:135-1]	55
§913.	Suitability of Equipment and Procedures [formerly paragraph 6:136-1(1)]	56
§915.	Product Water Treatment Process [formerly paragraph 6:137-1(A)]	56
§917.	Treatment Process of Product Water for Emergencies [formerly paragraph 6:137-1(B)]	56
§919.	Multi-Service Containers [formerly paragraph 6:137-2(1)]	56
§921.	Cleaning and Sanitizing Solutions [formerly paragraph 6:137-3]	57
§923.	Sanitizing Operations [formerly paragraph 6:137-4]	57
§925.	Production Code; Unit Package [formerly paragraph 6:137-5]	57
§927.	Filling, Capping, or Sealing; Container Testing Requirements [formerly paragraph 6:137-6]	57
§929.	Product Testing Requirements [formerly paragraph 6:137-7]	57
§931.	Record Retention [formerly paragraph 6:137-8]	58
Chapter 11.	Soft Drink Manufacturing	58
§1101.	Definitions [formerly paragraph 6:138]	58
§1103.	Location and Use of Building [formerly paragraph 6:139]	58
§1105.	Plans Review [formerly paragraph 6:140]	58
§1107.	Walls and Ceilings [formerly paragraph 6:141]	58
§1109.	Lighting and Ventilation [formerly paragraph 6:142]	58
§1111.	Insect, Pest and Vermin Control [formerly paragraph 6:143]	59
§1113.	Syrup Room Requirements [formerly paragraph 6:144]	59
§1115.	Potable Water Supply; Not Cross Connected to Product Water Used for Bottling [formerly paragraph 6:145]	59
§1117.	Toilet and Lavatory Facilities [formerly paragraph 6:146]	59
§1119.	Multi-Use Container Washing and Handling [formerly paragraph 6:147]	59
§1121.	Conveyors and Cases [formerly paragraph 6:148]	59
§1123.	Syrup Making and Mixing Equipment [formerly paragraph 6:149]	59
§1125.	Water Treatment Equipment [formerly paragraph 6:150]	59
§1127.	Miscellaneous Testing Equipment [formerly paragraph 6:151]	60
§1129.	Good Manufacturing Practices; Processes and Controls [formerly paragraph 6:152]	60

Table of Contents

§1131.	Plant Layout [formerly paragraph 6:153]	60
§1133.	Bottle Washing; Mechanical Cleaning and Sterilizing; Hand Washing of Bottles Prohibited [formerly paragraph 6:154]	60
§1135.	Preparation of Syrups [formerly paragraph 6:155]	60
§1137.	Filling and Crowning [formerly paragraph 6:156]	60
§1139.	Storage of Crowns [formerly paragraph 6:157]	60
§1141.	Preparation and Storage of Colors [formerly paragraph 6:158]	60
§1143.	Finished Product Storage [formerly paragraph 6:159]	61
§1145.	Refuse and Rubbish [formerly paragraph 6:160]	61
§1147.	Cleaning and Sanitizing of Apparatus [formerly paragraph 6:161]	61
§1149.	Water [formerly paragraph 6:162]	61
§1151.	Prohibited Preservatives [formerly paragraph 6:163]	61
§1153.	Allowable Acids and Flavors; Prohibited Mineral Acids [formerly paragraph 6:164]	61
§1155.	Colors Additives [formerly paragraph 6:165]	61
§1157.	Employee Health [formerly paragraph 6:166]	61
Chapter 13.	Cold Storage and Ice Plants	61
§1301.	Definitions [formerly paragraph 6:167]	61
§1303.	Plans Review [formerly paragraph 6:168]	62
§1305.	Building Construction: Ice Plants, Cold Storage Plants or Cold Storage Rooms [formerly paragraph 6:169]	62
§1307.	Potable Water Supply [formerly paragraph 6:170]	62
§1309.	Cross Connections [formerly paragraph 6:171]	62
§1311.	Sewage Disposal [formerly paragraph 6:172]	62
§1313.	Toilet and Lavatory Facilities [formerly paragraph 6:173]	62
§1315.	Air Blowers [formerly paragraph 6:174]	62
§1317.	Outside Entrances [formerly paragraph 6:175]	62
§1319.	Permits [formerly paragraph 6:176]	62
§1321.	Employee Health [formerly paragraph 6:177]	63
§1323.	Spitting [formerly paragraph 6:178]	63
§1325.	Cleanliness [formerly paragraph 6:179]	63
§1327.	Storage of Meats and Foods [formerly paragraph 6:181]	63
§1329.	Ice Removal from Cans [formerly paragraph 6:182]	63
§1331.	Transportation, Distribution and Storage of Ice [formerly paragraph 6:183]	63
§1333.	Grinding, Crushing and Packaging of Ice [formerly paragraph 6:185]	63
§1335.	Records [formerly paragraph 6:186]	63
§1337.	Unwholesome Food [formerly paragraph 6:187]	64
§1339.	Reserved	64
§1341.	Sale of Cold Storage Goods; Prohibited "Fresh" Food Claims [formerly paragraph 6:189]	64
§1343.	Transfer of Cold Storage Goods; Prohibited Return to Cold Storage [formerly paragraph 6:190]	64
Chapter 15.	Current Good Manufacturing Practices in the Manufacture of Drugs	64
§1501.	Definitions [formerly paragraph 6:191]	64
§1503.	Permits [formerly paragraph 6:192]	65
§1505.	Public Display of Permits [formerly part of paragraph 6:192]	65
§1507.	Permit Exemptions [formerly paragraph 6:193]	65
§1509.	Examination, Condemnation and Destruction of Unwholesome or Adulterated Drugs [formerly paragraph 6:194]	65
§1511.	Personnel [formerly paragraph 6:195]	65
§1513.	Building Construction [formerly paragraph 6:197]	65

Table of Contents

§1515.	Building Requirements [formerly paragraph 6:198-1]	66
§1517.	Equipment [formerly paragraph 6:199]	66
§1519.	Product Production and Quality Control [formerly paragraph 6:200]	67
§1521.	Components [formerly paragraph 6:202]	67
§1523.	Product Containers and Their Components [formerly paragraph 6:203]	68
§1525.	Laboratory Controls [formerly paragraph 6:204]	68
§1527.	Stability [formerly paragraph 6:206]	69
§1529.	Expiration Dating [formerly paragraph 6:207]	69
§1531.	Packaging and Labeling [formerly paragraph 6:208]	70
§1533.	Records and Reports [formerly paragraph 6:209-1]	70
§1535.	Distribution Records [formerly paragraph 6:209-3]	71
§1537.	Complaint Files [formerly paragraph 6:210]	71
Chapter 17.	Drug Distributors, Drug Wholesalers and Drug Storage Warehouses	71
§1701.	Definitions [formerly paragraph 6:211]	71
§1703.	Permits [formerly paragraph 6:212]	71
§1705.	Buildings [formerly paragraph 6:213]	71
§1707.	Premises [formerly paragraph 6:218]	72
§1709.	Water Supply [formerly paragraph 6:220]	72
§1711.	Records [formerly paragraph 6:221]	72

Part VII. Dairy Products Regulations

Chapter 1.	Milk and Dairy Products	73
§101.	Definitions	73
§103.	Local Ordinances	87
§105.	Severability Clause	87
§107.	Standard of Identity	87
Subchapter A.	Required Permits	88
§109.	Permits	88
§111.	Permits Required for Imported Milk, Milk Products and Frozen Desserts	88
§113.	Requirements for Imported Dairy Products	89
Subchapter B.	Records	89
§115.	Milk Records	89
§117.	Falsification of Records	89
Subchapter C.	Registration and Labeling	89
§119.	Registration	89
§121.	Labeling	89
Chapter 3.	Sampling, Examination, Inspections, Grading, Enforcement Procedures and Standards of Dairy Products Including Frozen Desserts	90
§301.	General Requirements	90
Subchapter A.	Sampling and Examination of Dairy Products Including Frozen Desserts	92
§303.	Delivery of Samples	92
§305.	Samples and Examinations	92
§307.	The Official Sampling of Dairy Plant Environments and Dairy Products Including Frozen Desserts	92
§309.	Laboratory Examination of Dairy Products Including Frozen Desserts and Tests for Environmental Pathogens	93
Subchapter B.	Inspections/Audits	94
§311.	Frequency of Inspections/Audits	94
§313.	Pasteurization Equipment Tests, Examinations and Sealing	95

Table of Contents

§315.	Milk Sanitation Rating/HACCP Listing Audit	96
§317.	Posting Inspection Reports	96
§319.	Field Supervision	96
Subchapter C.	Grading, Enforcement Procedures and Standards.....	97
§321.	Grading	97
§323.	Grades of Milk and Milk Products to be Sold	97
§325.	Procedure in Emergency	97
§327.	Continuous Grading	97
Subchapter D.	Degrading or Suspension of Permit	98
§329.	Degrading or Suspension of Permit Based upon Physical Violations	98
§331.	Notification of Laboratory Analyses	98
§333.	Degrading or Suspension of Permit or Removal of Product from the Market Based upon Laboratory Analyses	98
§335.	Suspension of Permit Based on Laboratory Analyses - Adulteration or Contamination with Pathogenic Microorganisms of Human Significance	99
§337.	Suspension of Permit for Reasons Other than Laboratory Analyses.....	99
§339.	Seizure and Condemnation of Milk, Dairy Products, Ingredients of Milk and Ingredients of Dairy Products	99
Subchapter E.	Regrading and Reinstatement of Permit	99
§341.	Application for Regrading, Reinstatement of Permit and Permission to Resume Sale of Product	99
§343.	Regrading or Reinstatement of Permit when Degrade or Suspension was Based on Laboratory Analyses	100
§345.	Regrading and Reinstatement of Permit when Degrade or Suspension was Based on Physical Violations	100
§347.	Reinstatement of Permit when Suspension was Based upon Adulteration of Product or Contamination of Pasteurized Product or Cheeses with Pathogenic Microorganisms of Human Significance.....	100
Subchapter F.	Standards and Specification for Grades of Milk and Milk Products	101
§349.	Grade A Raw Milk for Pasteurization	101
§351.	Grade A Raw Milk for Pasteurization (Certified for Interstate Milk Shipment).....	101
§353.	Manufacturing Grade Raw Milk for Pasteurization/Milk for Manufacturing Purpose/Grade B Raw Milk for Pasteurization.....	101
§355.	Grade A Pasteurized, Ultra-pasteurized and Aseptically Processed Milk and Milk Products, Bulk Shipped Grade A Pasteurized or Ultra-pasteurized Milk and Milk Products and Pasteurized Filled Milk and Filled Milk Products	102
§357.	Grade A Bulk Shipped, Heat-Treated Milk and Milk Products	102
§359.	Grade A Aseptically Processed Milk and Milk Products/Ultra High Temperature (UHT)..	102
§361.	Grade A Pasteurized, Ultra-pasteurized and Aseptically Processed Milk and Milk Products Certified for Interstate Shipment	103
§363.	Grade B Pasteurized Milk and Milk Products	103
Chapter 5.	Requirements for Grade A Dairy Farms	103
§501.	Approval of Plans	103
Subchapter A.	Health of Dairy Animals	103
§503.	Health of Dairy Animals.....	103
Subchapter B.	Construction and Maintenance of Grade A Dairy Farm Facilities	104
§505.	Surroundings of Dairy Barns	104
§507.	Cow Yard.....	104
§509.	Manure, Sewage and Liquid Waste Disposal	104
§511.	Dairy Barn Required.....	105

Table of Contents

§513.	Milking Barn or Parlor Cleanliness	105
§515.	Lighting.....	105
§517.	Ventilation	105
§519.	Floors	105
§521.	Walls and Ceilings	105
§523.	Milk House or Room	105
§525.	Reclaimed Water _{df}	106
§527.	Toilets	107
§529.	Construction of Containers and Equipment.....	107
§531.	Sanitary Piping.....	108
Subchapter C.	Sanitation	108
§533.	Cleaning of Containers and Equipment	108
§535.	Sanitizing Treatment of Containers and Equipment.....	108
§537.	Storage	108
§539.	Handling.....	108
§541.	Milk Stools, Surcingles, and Anti-Kickers	108
§543.	Flanks, Udders and Teats.....	108
§545.	Handling of Milk with Abnormalities	108
§547.	Protection from Contamination	109
§549.	Cooling.....	109
§551.	Cow Feed	109
§553.	Insect and Rodent Control	109
§555.	Personal Cleanliness	109
§557.	Clarifiers in the Milk House	109
§559.	Drug and Chemical Control.....	110
Chapter 7.	Sampling, Hauling and Transporting of Milk	110
§701.	Milk Tank Trucks	110
§703.	Sealing and Protection of Milk Tank Trucks.....	112
§705.	Manifest for Bulk Milk Tank Trucks.....	112
§707.	Bulk Milk Tank Truck Operator/Sampler	113
Chapter 9.	General Requirements for Dairy Plants.....	115
§901.	General Requirements.....	115
§903.	Approval of Plans	115
Subchapter A.	Milk, Milk Products and Non Milk Derived Ingredients Receiving.....	115
§905.	Raw Milk Receiving	115
§907.	Dairy Plant Receivers/Samplers	116
§909.	Receiving and Handling of Milk Derived and Non-Dairy Ingredients	117
Subchapter B.	Dairy Plant Construction, Sanitation and Operation.....	118
§911.	Immediate Surroundings.....	118
§913.	Floors	118
§915.	Walls and Ceilings	118
§917.	Doors and Windows.....	118
§919.	Light and Ventilation	118
§921.	Separate Rooms	118
§923.	Toilet Facilities	119
§925.	Water Supply	119
§927.	Hand-washing Facilities	120
§929.	Protection from Contamination	120
§931.	Reclaim or Rework Operations.....	121
§933.	Dairy Plant Cleanliness.....	122

Table of Contents

§935.	Sanitary Piping.....	122
§937.	Construction and Repair of Containers and Equipment	122
§939.	Thermometers	122
§941.	Pasteurization, Ultra-pasteurization and Aseptic Processing	123
§943.	Cleaning and Sanitization of Containers and Equipment	123
§945.	Storage of Cleaned Containers and Equipment	124
§947.	Storage of Single-service Containers, Utensils and Materials.....	124
§949.	Packing, Bottling and Wrapping.....	124
§951.	Capping.....	124
§953.	Delivery Containers	124
§955.	Cooling of Dairy Products	125
§957.	Use of Overflow, Leaked, Spilled or Mishandled Dairy Products	127
§959.	Sale of Reconstituted or Recombined Milk or Milk Products and Reconstituted or Recombined Anomalous (Substitute) Milk or Milk Products	128
§961.	Use of Inhibitors	128
§963.	Denaturing of Milk or Dairy Products.....	128
§965.	Dipping or Transferring Dairy Products.....	128
§967.	Apparatus, Containers, Equipment and Utensils	128
§969.	Personnel Health.....	128
§971.	Notification of Disease	129
§973.	Procedure when Infection Suspected.....	129
§975.	Personal Cleanliness	130
§977.	Allergen and Sensitivity Producing Ingredient.....	130
§979.	Storage of Bottled or Packaged Milk and Dairy Products.....	130
§981.	Sale of Warm Milk	130
§983.	Cleaning of Containers	130
§985.	Rat Proofing.....	131
§987.	Waste Disposal	131
§989.	Vehicles	131
Chapter 11.	Dairy Plant Hazard Analysis Critical Control Point (HACCP) Systems	131
§1101.	Hazard Analysis Critical Control Point (HACCP) Systems.....	131
§1103.	General Requirements.....	132
§1105.	Pre-requisite Programs (PPs).....	134
§1107.	Hazard Analysis.....	134
§1109.	HACCP Plan.....	135
§1111.	Corrective Actions	136
§1113.	Verification and Validation	136
§1115.	Records	137
§1117.	Training and Standardization.....	138
§1119.	Audit of Dairy Plants that Operate under the HACCP Systems Defined in this Part.....	138
Chapter 13.	Receiving Stations	139
§1301.	Receiving Station Requirements.....	139
Chapter 15.	Transfer Stations.....	140
§1501.	Transfer Station Requirements	140
Chapter 17.	Finished Dairy Products Depots and Transfer Points.....	141
§1701.	Approval of Plans	141
§1703.	Basic Requirements for Finished Dairy Product Depots	141
§1705.	Basic Requirements for Finished Dairy Product Transfer Points.....	142

Table of Contents

Chapter 19. Milk Tank Truck Cleaning Facilities	143
§1901. Approval of Plans	143
§1903. Basic Requirements for Milk Tank Truck Cleaning Facilities	143
§1905. Supplemental Requirements for Milk Tank Truck Cleaning Facilities	143
Chapter 21. Dairy Products Condensing, Dairy Products Concentrating, Dairy Products Drying or Dry Dairy Products Blending Plants	144
§2101. Approval of Plans	144
§2103. Basic Requirements for Condensed, Concentrated, Dry and Blended Dry Dairy Products and Dairy Plants that Condense, Concentrate, Dry or Blend Dry Dairy Products	144
Subchapter A. Supplemental Requirements for Dairy Plants that Condense, Concentrate, Dry or Blend Dry Dairy Products	145
§2105. General Requirements.....	145
§2107. Cleaning and Sanitizing of Containers and Equipment	146
§2109. Packaging and Container Filling.....	147
§2111. Container Closure, Sealing and Storage	147
§2113. Cooling of Milk, Milk Products, Whey, Whey Products, and Condensed Dairy Products ..	147
§2115. Separate Rooms	148
§2117. Reclaimed Water _{dp}	149
§2119. Air for Dairy Product Drying Equipment and Air under Pressure-Direct Contact with Milk and Dairy Products or Milk and Dairy Product Contact Surfaces	152
§2121. Supplemental Labeling Requirements for Condensed, Concentrated, Dry or Blend Dry Dairy Products	153
SubChapter B. Specifications for Grade A Condensed and Dry Dairy Products and Blended Dry Dairy Products	154
§2123. Grade A Condensed Milk and Condensed Milk Products	154
§2125. Grade A Nonfat Dry Milk.....	154
§2127. Grade A Whey for Condensing or Concentrating	154
§2129. Grade A Pasteurized Condensed Whey	155
§2131. Grade A Dry Whey or Dry Whey Products	155
§2133. Grade A Dry Buttermilk and Dry Buttermilk Products	155
§2135. Other Grade A Condensed, Concentrated or Dry Dairy Products	155
§2137. Blended Dry Dairy Products.....	155
Subchapter C. Specifications for Extra Grade and Standard Grade Dry Dairy Products.....	156
§2139. Extra Grade and Standard Grade Dry Dairy Products	156
§2141. Bacteriological Requirements for Extra Grade Dry Dairy Products	156
§2143. Bacteriological Requirements for Standard Grade Dry Dairy Products.....	157
Chapter 23. Butter Plants	157
§2301. Approval of Plans	157
§2303. Basic Requirements for Dairy Plants that Manufacture, Process or Package Butter and Butter Related Products	157
Subchapter A. Supplemental Requirements for Butter Plants.....	159
§2305. General Information.....	159
§2307. Construction of Utensils and Equipment	159
§2309. Cream for the Manufacture of Butter and Butter Related Products	159
§2311. Composition and Wholesomeness of Ingredients Used in the Manufacture of Butter and Butter Related Products	159
§2313. Examination of Butter and Butter Related Products.....	159
§2315. Standards of Identity for Butter	160
§2317. Bacteriological Requirements.....	160

Table of Contents

§2319.	Seizure and Condemnation of Butter and Butter Related Products	160
§2321.	Containers	160
§2323.	Printing and Packaging of Butter and Butter Related Products	160
Chapter 25.	Cheese Manufacturing Plants	160
§2501.	Approval of Plans	160
§2503.	Basic Requirements for Cheese Manufacturing Plants.....	160
Subchapter A.	Supplemental Requirements for Cheese Manufacturing Plants.....	162
§2505.	General Information.....	162
§2507.	Additional Requirements for Cheese Manufacturing Plants that Manufacture, Process, Package, Cut or Slice Ripened or Aged Cheese and Cheese Related Products.....	163
§2509.	Additional Requirements for Pasteurized Process Cheese Manufacturing Plants.....	165
§2511.	Additional Requirements for Cheese Manufacturing Plants that Manufacture, Process or Package Unripened Cheese	166
§2513.	Additional Requirements for Cheese Manufacturing Plants that Manufacture or Process Unripened Cheese or Cheese Related Products from Milk or Milk Products that were Pasteurized, Ultra-pasteurized or Aseptically Processed at Other Plants without Repasteurization	167
Chapter 27.	Frozen Desserts	168
§2701.	Approval of Plans	168
§2703.	Basic Requirements for Frozen Dessert Manufacturing Plants	168
Subchapter A.	Supplemental Requirements for Dairy Plants that Manufacture Frozen Desserts.....	169
§2705.	General Information.....	169
§2707.	Additional Requirements for Frozen Dessert Manufacturing Plants that Have Been Authorized by the State Health Officer to Freeze or Partially Freeze and Package Frozen Desserts Made from Frozen Dessert Mixes that were Pasteurized, Ultra-pasteurized or Aseptically Processed at Another Plant.....	172
Subchapter B.	Frozen Dessert Retail Requirements.....	172
§2709.	Counter Freezers [formerly paragraph 8:013]	172
§2711.	Mobile Frozen Dessert Units [formerly paragraph 8:021]	172
§2713.	Depots for Mobile Frozen Dessert Units [formerly paragraph 8:022]	173
Chapter 29.	Standards for the Fabrication of Single Service Containers and Closures for Milk and Milk Products Including Fabricating Plants Producing Component Parts, Films and Closures	173
§2901.	General Requirements.....	173
§2903.	Approval of Plans	174
§2905.	Bacterial Standards and Examination of Single Service Containers and Closures	174
§2907.	Single Service Milk Container or Closure Manufacturing Plant Standards	174

Part IX. Marine and Fresh Water Animal Food Products

Chapter 1.	Shellfish Growing Areas	179
§101.	Definitions [formerly paragraph 9:001].....	179
§103.	Harvesting and/or Sales Shellfish—In Open Status [formerly paragraph 9:002-1]	182
§105.	Sanitary Surveys of Growing Areas—Satisfactory Compliance [formerly paragraph 9:002-2]	182
§107.	Classification of Growing Areas—Satisfactory Compliance [formerly paragraph 9:002-3]	183
§109.	Approved Areas—Satisfactory Compliance [formerly paragraph 9:002-4].....	183
§111.	Conditionally Approved Areas—Satisfactory Compliance [formerly paragraph 9:002-5]..	183
§113.	Restricted Area—Satisfactory Compliance [formerly paragraph 9:002-6].....	184
§115.	Prohibited Areas—Satisfactory Compliance [formerly paragraph 9:002-7].....	185

Table of Contents

§117.	Control of Areas Due to Marine Biotoxins—Satisfactory Compliance [formerly paragraph 9:002-8]	185
§119.	Procedures for Receipt of Shellfish Growing Water Samples [formerly paragraph 9:002-9]	186
§121.	Preparation for Laboratory Analysis of Shellfish Growing Waters [formerly paragraph 9:002-10]	186
§123.	Procedure for the Analysis of Shellfish Growing Waters [formerly paragraph 9:002-11] .	187
§125.	Determination of Results, Records and Data Reporting [formerly paragraph 9:002-12]....	188
§127.	Qualification for Laboratories Conducting Analysis of Shellfish Growing Waters for the Louisiana Molluscan Shellfish Program [formerly paragraph 9:002-13].....	188
§129.	Qualification for Personnel Conducting Analysis of Shellfish Growing Waters [formerly paragraph 9:002-14]	190
§131.	Qualifications, Requirements for Laboratory Evaluation Officer for the State of Louisiana [formerly Paragraph 9:002-15]	190
§133.	Requirements for Laboratory Certification [formerly paragraph 9:002-16]	191
§135.	Fees for Services [formerly paragraph 9:002-17].....	192
§137.	References [formerly paragraph 9:002-18].....	192
§139.	Records of Shellfish Purchases and Sales [formerly paragraph 9:003].....	192
§141.	Relaying of Shellfish [formerly paragraph 9:004].....	193
§143.	Performance Bond Required [formerly paragraph 9:004-1].....	193
§145.	Permit Required for Relaying [formerly paragraph 9:004-2].....	194
§147.	Surveillance Officer's Daily Trip Report [formerly paragraph 9:004-3].....	194
§149.	Enforcement Provisions [formerly paragraph 9:004-4].....	194
Chapter 3.	Preparation and Handling of Seafood for Market	195
§301.	Water Storage of Shellfish [formerly paragraph 9:005]	195
§303.	Construction and Cleanliness of Shellfish Boats [formerly paragraph 9:006]	195
§305.	Sewage Disposal on Shellfish Boats [formerly paragraph 9:007]	195
§307.	Sewage Disposal near Shellfish Areas [formerly paragraph 9:008].....	195
§309.	Contamination of Shell-Stock Prohibited [formerly paragraph 9:009]	196
§311.	Permits to Operate Seafood Establishments [formerly paragraph 9:010]	196
§313.	Plant Construction [formerly paragraph 9:011].....	196
§315.	Seafood Plant Equipment [formerly paragraph 9:022].....	197
§317.	Seafood Plant Operation [formerly paragraph 9:027 and 9:027-1]	197
§319.	Seafood (Except Shell-Stock) Shipping Requirements [formerly paragraph 9:042]	201
§321.	Shipping Shell-Stock Requirements [formerly paragraph 9:047]	202
§323.	Tags [formerly paragraph 9:051].....	202
§325.	Penalties Relative to Shellstock Container Tagging [formerly paragraph 9:051-2].....	203
§327.	Refrigeration of Shellstock Oysters, Clams and Mussels [formerly paragraph 9:052]	203
§329.	Refrigeration Requirements for Shellstock Harvested for Raw Consumption during the Months of January through December [formerly paragraph 9:052-1]	204
§330.	Refrigeration Requirements for Shellstock Harvested during the months of May through October for Raw Consumption only by Persons Located Within the State of Louisiana.....	205
§331.	Refrigeration Requirements for Shellstock Harvested for Shucking or Post-Harvest Processing by a Certified Dealer during the Months of January through December [formerly paragraph 9:052-2]	205
§333.	General Provisions [formerly paragraph 9:052-3].....	206
§335.	Penalties Relative to Shell-Stock Refrigeration [formerly paragraph 9:052-4].....	208
§337.	Checking on Condition of Molluscan Shellfish in Growing Waters Closed by the State Health Officer [formerly paragraph 9:053]	208

Table of Contents

§341.	Permits [formerly paragraph 9:053-2]	208
§343.	Permit Enforcement [formerly paragraph 9:053-3]	209
§345.	Harvester-Dealer Time/Temperature Log Sheet [formerly Table I]	209
§347.	FDA Laboratory Evaluation Forms [formerly Appendix A].....	209
Chapter 5.	Molluscan Shellfish Aquaculture	209
§501.	General.....	209
§503.	Exceptions.....	210
§505.	Seed Production in Water Classified as Prohibited or Unclassified.....	210
§507.	Aquaculture That Attracts Birds or Mammals.....	210
§509.	Land Based Aquaculture.....	211

Part X. Game Bird and Small Animal Slaughter and Processing

Chapter 1.	Required Permits	213
§101.	Definitions [formerly paragraph 10:001].....	213
§103.	Permits; Regulated and Exempted Facilities [formerly paragraph 10:002]	213
§105.	Applications for Permits [formerly paragraph 10:004]	213
§107.	Labeling Requirements [formerly paragraph 10:006]	214
§109.	Registration of Meat Products Offered for Sale [formerly paragraph 10:007].....	214
§111.	Required Records [formerly paragraph 10:013].....	214
§113.	Building Requirements [formerly paragraph 10:016]	214
§115.	Required Sanitary Facilities [formerly paragraph 10:024]	215
§117.	Equipment and Utensils [formerly paragraph 10:028-1].....	215
§119.	Employee Health Provisions [formerly paragraph 10:038].....	217
§121.	Dogs or Cats Prohibited on Premises [formerly paragraph 10:039].....	217
§123.	Offal Prohibited on Premises [formerly paragraph 10:040]	217
§125.	Storage of Hides or Pelts on Premises [formerly paragraph 10:041]	217
§127.	Plant Wastes [formerly paragraph 10:042].....	217
Chapter 3.	Nutria Program	217
§301.	Nutria Inspection Program [formerly paragraph 10:043].....	217
§303.	Nutria for Human Consumption [formerly paragraph 10:044]	217
§305.	Labeling Requirements [formerly paragraph 10:045]	218
§307.	Provisions Applicable to Nutria [formerly paragraph 10:047].....	218

Part XI. Animals and Animal Diseases; Rendering of Animals

Chapter 1.	General	219
§101.	Definitions [formerly paragraph 11:001].....	219
§103.	Inspection of Premises Used to Hold Animals or Fowls [formerly paragraph 11:002]	219
§105.	Sanitary Disposal of Dead Animals or Fowl [formerly paragraph 11:003]	219
Chapter 3.	Rendering Plants.....	219
§301.	Required Health Permit for Rendering Plant [formerly paragraph 11:004]	219
§303.	Sanitary Hauling Dead Animals or Offal [formerly paragraph 11:009].....	219
§305.	Prohibited Activities [formerly paragraph 11:011]	220
§307.	Label and Tagging Requirements [formerly paragraph 11:012]	220

Part XII. Water Supplies

Chapter 1.	General	221
§101.	Definitions [formerly paragraph 12:001].....	221
§103.	General Requirements for a Potable Water Supply [formerly paragraph 12:002-1].....	224

Table of Contents

§105.	Permit Requirements for a Potable Water Supply [formerly paragraph 12:002-2]	224
§107.	Provision for Grandfather Systems [formerly paragraph 12-002-3]	225
§109.	Requirements for Sources of a Potable Water Supply [formerly paragraph 12-002-4]	225
Subchapter A. Submission of Plans		225
§111.	General Requirements	225
§113.	Engineer’s Report	226
§115.	Plans	227
§117.	Specifications	228
§119.	Design Criteria	228
§121.	Revisions to Approved Plans	229
§123.	Additional Information Required	229
Subchapter B. General Design		229
§125.	Design Basis	229
§127.	Plant Layout	229
§129.	Building Layout	229
§131.	Location of Structures	229
§133.	Electrical and Controls	229
§135.	Standby Power	230
§137.	Laboratory Facilities	230
§139.	Monitoring Equipment	231
§141.	Sample Taps	231
§143.	Facility Water Supply	231
§145.	Wall Castings	231
§147.	Meters	231
§149.	Piping Color Code	231
§151.	Disinfection	232
§153.	Operation and Maintenance Manual	232
§155.	Operator Instruction	232
§157.	Safety	232
§159.	Security	232
§161.	Flood Protection	233
§163.	Design; Other Considerations	233
Subchapter C. Source Development		233
§165.	General Requirements	233
§167.	Surface Water	233
§169.	Groundwater	235
Subchapter D. Treatment		240
§171.	General Requirements	240
§173.	Microscreening	240
§175.	Clarification Design	241
§177.	Filtration Design	243
§179.	Disinfection	249
§181.	Softening	254
§183.	Anion Exchange Treatment	255
§185.	Aeration	256
§187.	Iron and Manganese Control	258
§189.	Stabilization	259
§191.	Taste and Odor Control	259

Table of Contents

Chapter 2. Public Water System Construction, Operation and Maintenance	260
Subchapter A. Chemical Application	260
§201. General Requirements.....	260
§203. Feed Equipment	260
§205. Chemicals.....	263
§207. Operator Safety	263
§209. Specific Chemicals	263
Subchapter B. Pumping Facilities	267
§211. General.....	267
§213. Site Protection.....	267
§215. Pumping Stations	267
§217. Pumps.....	268
§219. Booster Pumps	268
§221. Automatic and Remote Controlled Stations	268
§223. Appurtenances	268
Subchapter C. Finished Water Storage	269
§225. General.....	269
§227. Treatment Plant Storage.....	272
§229. Hydropneumatic Tank Systems	272
§231. Distribution System Storage	272
Subchapter D. Distribution System Piping and Appurtenances	273
§233. General.....	273
§235. Materials	273
§237. Distribution System Design	274
§239. Valves	274
§241. Hydrants.....	274
§243. Air Relief Valves	274
§245. Installation of Water Mains	274
§247. Separation Distances from Contamination Sources.....	275
§249. Surface Water Crossings.....	275
§251. Interconnections.....	275
§253. Water Services and Plumbing.....	276
§255. Water Loading Stations	276
Subchapter F. Waste Residuals	276
§257. General.....	276
§259. Sanitary Waste	277
§261. Brine Wastes	277
§263. Precipitative Softening Sludge.....	277
§265. Alum Sludge	278
§267. “Red Water” Waste.....	278
§269. Waste Filter Wash Water	279
§271. Radioactive Materials	279
§273. Arsenic Waste Residuals	280
§275. Other Approved Methods of Handling Waste	280
§277. Standards Reference Table	280
§279. Organization Reference Table	280
Chapter 3. Water Quality Standards.....	281
§301. Mandatory Water Quality Standards for Public Water Systems	281
§302. Relationship with this Part.....	281
§303. Variances and/or Exemptions [formerly paragraph 12:002-6].....	281

Table of Contents

§305.	Reserved.....	281
§307.	Responsibility of Owner [formerly paragraph 12:003-1]	281
§309.	Plant Supervision and Control [formerly paragraph 12:003-2]	281
§311.	Records [formerly paragraph 12:003-2]	281
§313.	Reserved.....	282
§315.	Security [formerly paragraph 12:003-5]	282
§317.	Water Systems Which Fluoridate/Plan to Fluoridate	282
§319.	Significant Deficiencies Identified in Sanitary Surveys	282
§321.	Reporting Changes or NPDWR Violations in Public Water Supplies [formerly paragraph 12:005].....	283
§323.	Filtration [formerly paragraph 12:006].....	283
§325.	Treatment Chemicals and Components [formerly paragraph 12:007]	283
§327.	Ground Water Supplies [formerly paragraph 12:008-1].....	284
§329.	Construction and Installation of Pumps [formerly paragraph 12:009-1].....	285
§331.	Well Abandonment [formerly paragraph 12:010]	286
§333.	Reservoir Sanitation [formerly paragraph 12:011-1].....	286
§335.	Distribution [formerly paragraph 12:012-1]	286
§337.	Storage [formerly paragraph 12:013-1]	287
§339.	Protection of Suction Pipes [formerly paragraph 12:014-1].....	287
§341.	Separation of Water Mains and Sewer Mains [formerly paragraph 12:015].....	287
§343.	Cross Connections [formerly paragraph 12:016-1]	287
§344.	Protection of Water Supply/Containment Practices	288
§345.	Connection with Unsafe Water Sources Forbidden [formerly paragraph 12:017].....	288
§346.	Installer, Repairer, Tester and Maintainer Qualifications for Backflow Prevention Devices and Methods.....	288
§347.	Connections to Public Water Supply [formerly paragraph 12:018]	289
§349.	Protection during Construction [formerly paragraph 12:019]	289
§351.	Disinfection of Potable Water Supply Systems [formerly paragraph 12:020-1].....	289
§353.	Disinfection of New Water Supplies [formerly paragraph 12:020-2]	289
§355.	Mandatory Disinfection [formerly paragraph 12:021-1]	289
§357.	Minimum Disinfection Residuals [formerly paragraph 12:021-2]	290
§358.	Treatment Technique Requirement	290
§359.	Other Methods of Disinfection [formerly paragraph 12:021-3]	290
§361.	Implementation of Disinfection Requirements.....	290
§363.	Revocation of Variances [formerly paragraph 12:021-5].....	290
§365.	Batch Disinfection [formerly paragraph 12:021-6]	291
§367.	Disinfectant Residual Monitoring and Record Keeping [formerly paragraph 12:021-7].....	291
§369.	Water Shall Be Provided [formerly paragraph 12:022-1]	292
§371.	Public Drinking Fountains [formerly paragraph 12:023-1].....	292
§373.	Potable Water Loading Stations [formerly paragraph 12:024].....	292
§375.	Issuance of Emergency Boil Notices [formerly paragraph 12:025]	292
§377.	Adoption by Reference [formerly paragraph 12:026]	292
Chapter 4.	Community Water System Accountability Rule	293
§401.	Statement of Purpose	293
§403.	General Provisions.....	293
§405.	Letter Grade Schedule	293
§407.	Calculation of Letter Grade and Score	294
§409.	Financial Sustainability Requirements	294
§411.	Reporting Requirements	295

Table of Contents

Chapter 5.	Civil Penalty Assessment Rule [formerly appendix A]	295
§501.	Statement of Purpose [formerly section 1.1 of paragraph I of appendix A].....	295
§503.	General Provisions [formerly section 2.1 of paragraph II of appendix A]	295
§505.	Calculation of Daily Penalties [formerly section 3.1 of paragraph III of appendix A]	296
§507.	Payment of Penalty/Ability to Request Mitigation of Penalty and/or Adjudicatory Hearing.....	297
§509.	Court Appeals [formerly section 5.1 of paragraph V of appendix A]	298
Chapter 7.	Accompanying Guidelines to the Civil Penalty Assessment Rule [formerly Appendix B]...	298
§701.	Statement of Purpose [formerly section 1.1 of paragraph I of appendix B].....	298
§703.	Seriousness of Violation [formerly section 2.1 of paragraph II of appendix B]	298
§705.	Culpability of the Owner and/or Operator [formerly section 3.1 of paragraph III of appendix B]	298
§707.	Classification of Violations [formerly section 4.1 of paragraph IV of appendix B]	299
§709.	Mitigation Guidance [formerly section 5.1 of paragraph V of appendix B]	300
Chapter 9.	Louisiana Total Coliform Rule [formerly Appendix C].....	300
§901.	Federal Regulations Adopted by Reference [formerly the preamble paragraph opening Appendix C].....	300
§903.	Coliform Routine Compliance Monitoring [formerly Coliform Routine Compliance Monitoring of Appendix C]	300
§905.	Coliform Repeat Compliance Monitoring [formerly Coliform Repeat Monitoring of Appendix C]	301
§907.	Analytical and Reporting Requirements.....	301
§909.	Invalidation of Total Coliform Results [formerly Invalidation of Total Coliform Results of Appendix C].....	302
§911.	Treatment Technique Triggers and Maximum Contaminant Level [formerly Total Coliform MCL of Appendix C]	302
§912.	Assessment Requirements	302
§913.	Public Notification [formerly Public Notification of Appendix C].....	302
Chapter 11.	Surface Water Treatment Rule	302
Subchapter A.	General Requirements and Definitions	302
§1101.	General Requirements.....	302
§1102.	Relationship with this Part.....	303
§1103.	Definition of Terms	303
§1105.	Analytical Requirements.....	305
§1107.	Calibration/Validation of Turbidimeters.....	306
§1109.	Calibration _{dra} /Validation of Disinfectant Residual Analyzers	307
§1110.	Calibration _{pH} /Validation of pH Meters.....	308
§1111.	Calibration _{temp} /Validation of Temperature Measuring Devices	308
§1112.	Cleaning of Analytical Instrumentation.....	308
Subchapter B.	Treatment Technique Requirements and Performance Standards	309
§1113.	Treatment Technique Requirements	309
§1115.	Filtration Performance Standards	309
§1117.	Non-Filtering Systems	310
§1119.	Disinfection Performance Standards	312
§1121.	Design Standards	312
Subchapter C.	Monitoring Requirements	313
§1123.	Filtration Monitoring	313
§1125.	Disinfection Monitoring	314
§1127.	Disinfection Profiling	315
§1129.	Disinfection Practice Changes	315

Table of Contents

Subchapter D. Operation.....	316
§1131. Operating Criteria	316
Subchapter E. Reporting.....	316
§1133. DHH Notification	316
§1135. Monthly Report.....	317
§1137. Disinfection Profiling Report.....	319
Subchapter F. Public Notification	319
§1139. Consumer Notification.....	319
Subchapter G. Filter Backwash Recycling	320
§1141. Recycling Provisions	320
Chapter 12. Ground Water Rule.....	321
§1201. General.....	321
Chapter 13. Disinfectants and Disinfection Byproducts Rule	321
Subchapter A. General	321
§1301. General.....	321
Subchapter B. Disinfection Byproduct (DBP) Precursor Control	321
§1303. Applicability	321
§1305. Monthly TOC Monitoring/Reporting	321
§1307. Quarterly TOC Report	322
§1309. Step 2 Bench-Scale (Jar) or Pilot-Scale Testing.....	322
§1311. Alternative Compliance Criteria.....	323
§1313. Amendment to the Step 1 Required Removal of TOC Matrix Table under 40 CFR 141.135(b)(2) to Clarify ACC #1	324
§1315. Analytical Requirements for TOC, DOC, and UV ₂₅₄	324
Subchapter C. Chlorite/Chlorine Dioxide.....	324
§1317. Monthly Reporting Required	324
Subchapter D. Monitoring Plans.....	324
§1319. Monitoring Plan Required	324
Chapter 15. Approved Chemical Laboratories/Drinking Water	325
Subchapter A. Definitions and General Requirements	325
§1501. Definitions of Terms	325
§1503. General Requirements.....	325
§1505. Staffing, Equipment, Quality Control and Records.....	326
Subchapter B. Procedures to Become an Approved Chemical Laboratory/Drinking Water	326
§1507. Application and Approval.....	326
Subchapter C. Consequences of Non-Compliance.....	326
§1509. Public Notification.....	326
Chapter 17. Lead and Copper Rule	327
§1701. General.....	327
§1703. Certification of Sampling Sites for Compliance Monitoring.....	327
Chapter 19. Public Notification Rule	327
§1901. General.....	327
§1903. Public Notification [Formerly §313]	328
§1905. Tier 1 Public Notice	328
§1907. Tier 2 Public Notice	329
§1909. Tier 3 Public Notice	329
§1911. Public Notice for Certain Violations of Specific Drinking Water Rules.....	329

Part XIII. Sewage Disposal

Chapter 1. General [formerly Chapter 13 Subpart A].....	331
§101. Definitions [formerly paragraph 13:001].....	331
Chapter 3. General Requirements for Sewerage Disposal [formerly Chapter 13 Subpart B].....	332
§301. Plumbing Fixtures [formerly paragraph 13:002].....	332
§303. Responsible Parties [formerly paragraph 13:003]	332
§305. Discharges [formerly paragraph 13:004-1].....	332
§307. Installation [formerly paragraph 13:004-2]	332
§308. Outfall Paths	332
§309. Previous Permits [formerly paragraph 13:005]	333
Chapter 5. Community Sewerage Systems [formerly Chapter 13 Subpart C].....	333
§501. Permits [formerly paragraph 13:006]	333
§503. Plans [formerly paragraph 13:007]	333
§505. Operation and Maintenance [formerly paragraph 13:008-1].....	333
§507. Records [formerly paragraph 13:009].....	333
§509. Land Application [formerly paragraph 13:010].....	333
§511. General Requirements [formerly paragraph 13:011-1]	334
Chapter 7. Individual Sewerage Systems [formerly Chapter 13 Subpart D]	335
Subchapter A. General Requirements.....	335
§701. Permits [formerly paragraph 13:012-1]	335
§703. Plans [formerly paragraph 13:013-1].....	335
§705. Installation of Individual Sewerage Systems [formerly paragraph 13:014-1].....	336
§707. Maintenance and Operation [formerly paragraph 13:015]	336
§709. Septic Tank Systems [formerly paragraph 13:016]	336
§711. Individual Mechanical Plants [formerly 13:017-1]	336
§713. Other Individual Sewerage Systems [formerly paragraph 13:018-1].....	336
Subchapter B. Design and Construction Regulations [formerly Chapter 13 Appendix A].....	337
§715. Septic Tanks [formerly Section I of Appendix A].....	337
§717. Septic Tank Effluent [formerly Section II of Appendix A].....	338
§719. Absorption Trenches [formerly Section III of Appendix A]	338
§721. Oxidation Ponds [formerly Section IV of Appendix A].....	340
§723. Sand Filter [formerly Section V of Appendix A]	341
§725. Mechanical Waste Water Treatment Plants [formerly Section VI of Appendix A]	342
§727. Sanitary Pit Privy [formerly Section VII of Appendix A].....	345
§729. Pumping Stations [formerly Section VIII of Appendix A].....	345
§731. Effluent Reduction System Requirements for Treated Wastewater [formerly Section IX of Appendix A].....	346
§733. Effluent Reduction Options [formerly Section IX of Appendix A]	347
Subchapter C. Licensing Procedures for Installers and Manufacturers of Individual Sewerage Systems [formerly Chapter 13 Subpart F].....	349
§735. General Procedures [formerly paragraph 13:022-1].....	349
§737. Installer/Maintenance Provider Qualifications	350
§739. Sub-Manufacturer Qualifications [formerly paragraph 13:023-2]	350
§741. Manufacturer Qualifications [formerly paragraph 13:023-3].....	351
Chapter 9. Sewage Hauling.....	351
§901. General Requirements [formerly paragraph 13:019-1]	351
Chapter 11. Non-Waterborne Systems.....	351
§1101. General Requirements [formerly paragraph 13:020-1]	351

Table of Contents

Chapter 13. Special Applications [formerly Chapter 13 Subpart E]..... 352
 §1301. General Requirements [formerly paragraph 13:021]..... 352
Chapter 15. Sewage Loading Criteria [formerly Chapter 13 Appendix B] 353
 §1501. General Requirements..... 353

Part XIV. Plumbing

Chapter 1. Administration..... 373
Subchapter A. General..... 373
 §101. Title and Adoption of Louisiana State Plumbing Code (LSPC)
 [formerly paragraph 14:001]..... 373
 §103. Availability [formerly paragraph 14:002]..... 373
 §105. Effective Date and Edition [formerly paragraph 14:003]..... 373
Subchapter B. Purpose and Scope 373
 §107. Purpose [formerly paragraph 14:004]..... 373
 §109. Code Remedial..... 373
 §111. Scope..... 374
 §113. Existing Buildings..... 374
 §115. Special Historic Buildings 374
Subchapter C. Powers and Duties of the Plumbing Official 374
 §117. Authority..... 374
 §119. Right of Entry 375
 §121. Enforcement..... 375
 §123. Revocation of Permits or Approvals..... 375
 §125. Unsafe Installations..... 375
 §127. Requirements Not Covered By Code..... 375
 §129. Alternate Materials and Methods of Construction..... 375
 §131. Permits 375
 §133. Tests 376
 §135. Variances 376
 §137. Violations and Penalties..... 376
 §139. Severability 376
Chapter 2. Definitions 376
Subchapter A. General..... 376
 §201. General..... 376
Subchapter B. Definition of Terms..... 376
 §203. Definition of Terms 376
Chapter 3. General Regulations 385
 §301. General..... 385
 §303. Materials 387
 §305. Protection of Pipes 390
 §307. Trenching, Excavation, and Backfill 391
 §309. Structural Safety 391
 §311. Fittings 391
 §313. Types of Joints 392
 §315. Use of Joints..... 393
 §317. Anchors, Hangers and Supports..... 393
 §319. Tests 394
 §321. Additional General Provisions..... 395

Table of Contents

Chapter 4.	Plumbing Fixtures	395
§401.	General.....	395
§403.	Installation	395
§405.	Location of Fixtures.....	396
§407.	Materials and Performance Standards	396
§409.	Water Conservation	397
§411.	Minimum Plumbing Fixtures.....	397
§413.	Fixture Outlets	405
§415.	Fixture Types	405
§417.	Additional Provisions for Plumbing Fixtures	410
Chapter 5.	Water Heaters	410
§501.	General.....	410
§503.	Standards.....	410
§505.	Minimum Capacities for Residential Water Heaters	410
§507.	Prohibited Installations	411
§509.	Connections	411
§511.	Safety Devices	411
§513.	Solar Water Heating Systems	412
Chapter 6.	Water Supply and Distribution.....	416
§601.	General.....	416
§603.	Materials	416
§605.	Quality of Water Supply	417
§607.	Identification of Nonpotable Water	417
§609.	Protection of Potable Water Supply.....	418
§611.	Sizing of Water Distribution System	424
§613.	Water Service Pipe and Fittings.....	426
§615.	Water Pumping and Storage Equipment.....	427
§617.	Water Supply Control	427
§619.	Water Distribution Pipe, Tubing and Fittings.....	428
§621.	Joints	429
§623.	Safety Devices	430
§625.	Miscellaneous	431
§627.	Water Treatment Units.....	431
§629.	Additional Water Supply and Distribution Provisions	431
Chapter 7.	Sanitary Drainage	432
§701.	General.....	432
§703.	Materials	432
§705.	Building Sewer	433
§707.	Drainage Piping Installation	435
§709.	Joints	435
§711.	Use of Joints.....	435
§713.	Connections between Drainage Piping and Fixtures	436
§715.	Prohibited Joints and Connections.....	436
§717.	Cleanouts	436
§719.	Size of Cleanouts	437
§721.	Cleanout Clearances	437
§723.	Fixture Units	437
§725.	Drainage System Sizing.....	440
§727.	Offsets in Drainage Piping in Buildings of Five Stories or More	441
§729.	Waste Stacks Serving Kitchen Sinks	441

Table of Contents

§731.	Sumps and Ejectors.....	441
§733.	Repairs to Drainage System via Re-route.....	442
§735.	Additional Provisions for Sanitary Drainage.....	442
Chapter 8.	Indirect and Special Wastes.....	442
§801.	General.....	442
§803.	Material and Size	443
§805.	Indirect Waste Methods	443
§807.	Indirect Waste Connections	443
§809.	Limitations	444
§811.	Additional Provisions for Indirect and Special Wastes	444
Chapter 9.	Vents.....	444
§901.	General.....	444
§903.	Materials	444
§905.	Vent Stacks	445
§907.	Vent Terminals	445
§909.	Vent Grades _(S) and Connections	445
§911.	Bar and Fountain Sink Traps	446
§913.	Fixture Vents.....	446
§915.	Common Vent.....	447
§917.	Vents for Fixture Trap below Trap Weir/Fixtures Entering at Different Levels.....	448
§919.	Wet Venting.....	448
§921.	Stack Venting.....	449
§923.	Individual Fixture Reventing	450
§925.	Battery Venting.....	451
§927.	Pneumatic Ejectors	452
§929.	Yoke Vents—Stacks of More Than 10 Branch Intervals	452
§931.	Offset Vents	452
§933.	Main Vents to Connect at Base.....	452
§935.	Vent Headers.....	453
§937.	Size and Length of Vents.....	453
§939.	Additional Provisions	454
§941.	Additional Information	454
Chapter 10.	Traps	454
§1001.	General.....	454
§1003.	Type and Size of Traps and Fixture Drains	455
§1005.	Interceptors and Separators.....	456
Chapter 11.	Storm Drainage.....	466
§1101.	General.....	466
§1103.	Materials	466
§1105.	Specifications.....	466
§1107.	Conductors and Connections	467
§1109.	Roof Drains.....	467
§1111.	Size of Leaders and Storm Drains	467
§1113.	Secondary (Emergency) Roof Drains	468
§1115.	Values for Continuous Flow	468
§1117.	Additional Information for Storm Drainage	468
Chapter 12.	Alternate Designed Plumbing Systems	469
§1201.	General.....	469

Table of Contents

§1203.	Requirements for Approval	469
§1205.	Tests	469
§1207.	Third Party Notification	470
Chapter 13.	Medical Facilities Plumbing Systems [formerly Appendix G—Medical Facilities Plumbing Systems]	470
§1301.	General	470
§1303.	Fixtures	471
§1305.	Drainage and Venting	472
§1307.	Water Supply	474
§1309.	Medical Gas and Medical Vacuum Systems	475
Chapter 14.	Reference Standards	475
§1401.	Scope	475
§1403.	Referenced Standards	475
§1405.	Organizations	480
Chapter 15.	Travel Trailers and Travel Trailer Parks [formerly Appendix B—Travel Trailers and Travel Trailer Parks]	482
§1501.	General	482
§1503.	Definitions	482
§1505.	General Regulations	483
§1507.	Plans and Specifications	483
§1509.	Service Buildings	484
§1511.	Materials	484
§1513.	General Regulations	484
§1515.	Park Drainage System	484
§1517.	Water Distribution System	485
§1519.	Travel Trailer Connections	485
§1521.	Maintenance	485
§1523.	Individual Travel Trailers	485
Chapter 16.	Mobile/Manufactured Homes and Mobile/Manufactured Home Parks [formerly Appendix C—Mobile/ Manufactured Homes and Mobile/Manufactured Home Parks]	487
§1601.	Purpose, Application and Scope	487
§1603.	Definitions	487
§1605.	General Regulations	487
§1607.	Plans and Specifications	487
§1609.	Materials	487
§1611.	General Regulations	488
§1613.	Park Drainage System	488
§1615.	Water Supply and Distribution Systems	488
§1617.	Mobile/Manufactured Home Connections	489
§1619.	Service Buildings	489
§1621.	Maintenance	489
§1623.	Individual Mobile/Manufactured Homes	489
Chapter 17.	Sewerage System Regulations [formerly Appendix E—Private Sewage Disposal]	490
§1701.	General	490
Chapter 18.	Appendices	490
§1801.	Scope	490
§1803.	Appendix A—Roof Drain Sizing Method	490

Table of Contents

§1805. Appendix B—Sizing of Water Piping System [formerly Appendix F—Sizing of Water Piping System]..... 492

§1807. Appendix C—Illustrations [formerly Appendix J—Illustrations]..... 499

§1809. Appendix D—Vacuum Drainage Systems [formerly Appendix K—Vacuum Drainage Systems]..... 508

§1811. Appendix E—Alternate Designed Plumbing Systems [formerly Appendix L—Alternate Designed Plumbing Systems]..... 509

§1813. Metric Conversions..... 517

Part XV. Hotels, Lodging Houses, Boarding Houses

Chapter 1. General 519

§101. Definitions [formerly paragraph 15:001]..... 519

§103. Permits [formerly paragraph 15:002-1] 519

§105. Plans and Specifications [formerly paragraph 15:003]..... 519

§107. Water Supply [formerly paragraph 15:004]..... 519

§109. Drinking Utensils [formerly paragraph 15:007] 519

§111. Linen Requirements [formerly paragraph 15:010] 520

§113. Eating and Beverage Facilities [formerly paragraph 15:011]..... 520

§115. Swimming Facilities [formerly paragraph 15:012] 520

§117. Sewage Disposal [formerly paragraph 15:013] 520

§119. Garbage Disposal [formerly paragraph 15:014] 520

§121. Employee Health [formerly paragraph 15:015]..... 520

§123. Dampness and Noxious Odors Prohibited [formerly paragraph 15:016] 520

§125. Ice Requirements [formerly paragraph 15:017]..... 520

§127. Pest Control [formerly paragraph 15:018]..... 520

§129. Ventilation Requirements [formerly paragraph 15:019] 520

§131. Illumination Requirements [formerly paragraph 15:020]..... 521

§133. Responsibility of the Proprietor [formerly paragraph 15:021-1]..... 521

Part XVI. Campsites

Chapter 1. General 523

§101. Definitions [formerly paragraph 16:001]..... 523

Chapter 3. Plans Review 524

§301. New Construction or Major Alterations [formerly paragraph 16:002]..... 524

Chapter 5. Permits and Inspections 524

§501. Requirements for Permits [formerly paragraph 16:004]..... 524

§503. Authority to Enter and Inspect Campsites [formerly paragraph 16:008] 525

Chapter 7. Location, Access, Water Supply and Swimming Facilities 525

§701. Location and Access [formerly paragraph 16:009] 525

§703. Water Supply [formerly paragraph 16:010]..... 525

§705. Swimming Facilities [formerly paragraph 16:011] 525

Chapter 9. Sleeping, Area, Grounds, Facilities and Maintenance of Campsites 525

§901. Campsite Requirements [formerly paragraph 16:012] 525

Chapter 11. Sanitary Toilet and Bathing Facilities at Campsites..... 526

§1101. Requirements for Toilets and Bathing Houses at Campsites [formerly paragraph 16:025]..... 526

Chapter 13. General Sanitary Requirements 526

§1301. Housekeeping [formerly paragraph 16:034]..... 526

§1303. Garbage and Refuse [formerly paragraph 16: 037] 527

Table of Contents

§1305. Disease Control [formerly paragraph 16:038] 527
§1307. Insects and Rodents [formerly paragraph 16:039]..... 527
§1309. Other Animals [formerly paragraph 16:040] 527

Part XVII. Public Buildings, Schools, and Other Institutions

Chapter 1. General Requirements for Public Buildings 528
 §101. Definitions 528
 §103. Lighting, Heating, and Ventilation Requirements for Public Buildings
 [Formerly §101] 528
 §105. Plans and Specifications [Formerly §103] 528
 §107. Drinking Water Provisions [Formerly §103] 529
 §109. Plumbing and Sewage Disposal Requirements [Formerly §107] 529
 §111. Housekeeping Requirements [Formerly §109] 529
Chapter 3. Special Sanitary Requirements for Schools and Other Institutions 529
 §301. Toilet Rooms in Schools and Other Institutions [formerly paragraph 17:021] 529
 §303. School Lunchrooms and Concession Stands [formerly paragraph 17:022] 530
 §305. Space and Lighting Requirements for Classrooms [formerly paragraph 17:025] 530
 §307. Outdoor Play Areas 531
Chapter 5. Health Requirements for Schools 531
 §501. Employee Health and Student Health [formerly paragraph 17:028] 531

Part XVIII. Jails, Prisons and Other Institutions of Detention or Incarceration

Chapter 1. General Requirements 533
 §101. Construction Requirements 533
 §103. Operations and Maintenance [formerly 18:017] 534
Chapter 3. Health Requirements for Incarceration 534
 §301. Inmate Health 534

Part XIX. Hospitals, Ambulatory Surgical Centers, Renal Dialysis Centers

Chapter 1. General Requirements 535
 §101. Definitions [formerly paragraph 19:001] 535
 §103. Construction Requirements [formerly paragraph 19:002] 535
Chapter 3. Operations and Maintenance 536
 §301. General [formerly paragraph 19:003] 536
 §303. Laundry [formerly paragraph 19:013] 536
 §305. Plumbing, Sewage, Garbage, and Waste [formerly paragraph 19:015] 537
 §307. Patient Areas [formerly paragraph 19:019] 537
 §309. Laboratory [formerly paragraph 19:024] 537
 §311. Radiation Controls [formerly paragraph 19:027] 537
 §313. Operating Rooms, Delivery Rooms, Intensive Care Units, Recovery, Nursery and
 Emergency Rooms [formerly paragraph 19:029] 538
 §315. Nursery [formerly paragraph 19:036] 538
 §317. Respiratory/Physical Therapy Rooms [formerly paragraph 19:040] 538
 §319. Morgue [formerly paragraph 19:041] 538
Chapter 5. General Standards 539
 §501. Space and Bed Standards [formerly paragraph 19:043] 539

Part XX. Nursing Homes

Chapter 1.	General Sanitary Provisions for Nursing Homes	541
§101.	Definitions [formerly paragraph 20:001].....	541
§103.	Advance Approval of New Construction or Major Alteration of Existing Nursing Homes is Mandatory [formerly paragraph 20:002]	541
§105.	Heating, Cooling, and Ventilating Systems [formerly paragraph 20:003]	541
§107.	Building Conditions [formerly paragraph 20:004]	541
§109.	Bedding Requirements [formerly paragraph 20:009].....	542
§111.	Bathroom Requirements [formerly paragraph 20:010-1]	542
§113.	Nurses' Station [formerly paragraph 20:011].....	542
§115.	Sanitary Provisions for Food [formerly paragraph 20:012].....	542
§117.	Water Supply [formerly paragraph 20:013].....	542
§119.	Sewage and Waste Disposal [formerly paragraph 20:014]	542
§121.	Plumbing [formerly paragraph 20:015]	542
§123.	Employee and Patient Health Provisions [formerly paragraph 20:016]	542

Part XXI. Day Care Centers and Residential Facilities

Chapter 1.	General Requirements	543
§101.	Definitions [formerly paragraph 21:001].....	543
§103.	Plans and Specifications [formerly paragraph 21:002].....	543
§105.	General [formerly paragraph 21:002-1].....	543
Chapter 3.	Child Day Care Centers.....	545
§301.	General Standards [formerly paragraph 21:010]	545
§303.	Diaper Changing Areas [formerly paragraph 21:019]	547
Chapter 5.	Outdoor Play Areas	547
§501.	General Standards [formerly paragraph 21:020]	547
Chapter 7.	Swimming Pools.....	548
§701.	General Standards [formerly paragraph 21:021]	548

Part XXIII. Retail Food Establishments

Chapter 1.	Definitions	549
§101.	Definitions [formerly paragraph 23:001].....	549
Chapter 3.	General Requirements	554
§301.	Effective Date of Part	554
§303.	Interpretation [formerly paragraph 23:002].....	554
§305.	Food Safety Certification [formerly paragraph 23:002-2].....	554
§307.	Submission of Plans [formerly paragraph 23:003]	555
§309.	Preoperational Inspection [formerly paragraph 23:004].....	555
§311.	Hazard Analysis Critical Control Point (HACCP) [formerly paragraph 22:02-4]	556
Chapter 5.	Permits	556
§501.	General [formerly paragraph 23:125].....	556
§503.	To Obtain a Permit from the State Health Officer [formerly paragraph 23:126-1, 23:126-2, 23:126-3]	556
Chapter 7.	Employee Health	556
§701.	General [formerly paragraph 23:031]	556
Chapter 9.	Personal Cleanliness and Hygienic Practices	557
§901.	Handwashing [formerly paragraph 23:032].....	557
§903.	Fingernails [formerly paragraph 22:06-2]	557
§905.	Jewelry [formerly paragraph 22:06-3].....	557

Table of Contents

§907.	Outer Clothing [formerly paragraph 22:06-4]	557
§909.	Hand Sanitizers	557
§911.	Tasting, Eating and Drinking [formerly paragraph 23:034-1]	557
§913.	Using Tobacco [formerly paragraph 23:034-2]	557
§915.	Hair Restraints [formerly paragraph 23:033-2]	558
§917.	Food Contamination [formerly paragraph 22:07-4]	558
§919.	Handling [formerly paragraph 22:07-5]	558
Chapter 11.	Food Supplies	558
§1101.	General [formerly paragraph 22:08-1]	558
§1103.	Source [formerly paragraph 22:08-2]	558
§1105.	Package [formerly paragraph 22:08-3]	558
§1107.	Labeling [formerly paragraph 22:08-4]	558
§1109.	Raw Shellfish Consumer Information Message [formerly paragraph 22:08-5.1]	558
§1111.	Exemption to Raw Shellfish Consumer Information Message [formerly paragraph 22:08-5.2]	559
§1113.	Hermetically Sealed Containers [formerly paragraph 22:08-6]	559
§1115.	Milk [formerly paragraph 22:08-7]	559
§1117.	Seafood [formerly paragraph 22:08-8]	559
§1119.	Eggs [formerly paragraph 22:08-9]	559
§1121.	Poultry and Meats [formerly paragraph 22:08-10]	560
§1123.	Game Animals [formerly paragraph 22:08-11]	560
Chapter 13.	Temperature	560
§1301.	Temperature Control [formerly paragraph 22:09-1]	560
§1303.	Exceptions [formerly paragraph 22:09-2]	560
§1305.	Cooking/Reheating [formerly paragraph 22:09-3]	560
§1307.	Hot Holding Temperatures [formerly paragraph 22:09-4]	561
§1309.	Cold Holding Temperatures [formerly paragraph 22:09-5]	561
§1311.	Cooling [formerly paragraph 22:09-6]	561
§1313.	Frozen Food [formerly paragraph 22:09-7]	561
§1315.	Thawing [formerly paragraph 22:09-8]	561
§1317.	Time as a Public Health Control [formerly paragraph 22:09-9]	562
§1319.	Parasite Destruction by Freezing	562
§1321.	Temperature Measuring Devices (Thermometers) [formerly paragraph 22:09-10]	562
Chapter 15.	Food Storage	562
§1501.	Protected [formerly paragraph 22:10-1]	562
§1503.	Storage [formerly paragraph 22:10-2]	563
§1505.	Packaged Food [formerly paragraph 22:10-3]	563
§1507.	Date Marking	563
Chapter 17.	Food Preparation	563
§1701.	General [formerly paragraph 22:11-1]	563
§1703.	Hand Contact [formerly paragraph 23:012]	563
§1705.	Cross Contamination [formerly paragraph 22:11-3]	563
§1707.	Reconstituted Dry Milk and Dry Milk Products [formerly paragraph 23:015]	564
§1709.	Molluscan Shellfish [formerly paragraph 22:11-2]	564
Chapter 19.	Food Display and Service	564
§1901.	General [formerly paragraph 22:12-1]	564
§1903.	Bulk Foods [formerly paragraph 22:12-2]	564
§1905.	Condiments [formerly paragraph 22:12-3]	564

Table of Contents

§1907.	Ice [formerly paragraph 22:12-4]	564
§1909.	Reservice [formerly paragraph 22:12-5]	564
§1911.	Special Requirements for Highly Susceptible Populations	565
Chapter 21.	Equipment and Utensils	565
§2101.	General [formerly paragraph 22:13]	565
§2103.	Multi-Use [formerly paragraph 22:13-1]	565
§2105.	Copper [formerly paragraph 22:13-2]	565
§2107.	Galvanized Metal [formerly paragraph 22:13-3]	565
§2109.	Lead [formerly paragraph 22:13-4]:	565
§2111.	Wood [formerly paragraph 22:13-5]	566
§2113.	Non-Food Contact Surfaces [formerly paragraph 22:14]	566
§2115.	Single-Service and Single-Use Articles [formerly paragraph 22:15]	566
§2117.	Gloves, Use Limitations [formerly paragraph 22:16]	566
§2119.	Food Temperature Measuring Devices [formerly paragraph 22:17]	566
Chapter 23.	Requirements for Equipment	567
§2301.	General [formerly paragraph 22:18-1]	567
§2303.	Manual Warewashing, Sink Compartment Requirements [formerly paragraph 22:18-2]	567
§2305.	Warewashing Machines [formerly paragraph 22:18-3]	567
Chapter 25.	Cleaning of Equipment and Utensils	567
§2501.	General [formerly paragraph 22:19-1]	567
§2503.	Frequency of Cleaning [formerly paragraph 22:19-2]	568
§2505.	Cleaning Agents [formerly paragraph 22:19-3]	568
§2507.	Temperature of Wash Solution [formerly paragraph 22:19-4]	568
§2509.	Methods of Cleaning [formerly paragraph 22:19-5]	568
§2511.	Rinsing Procedures [formerly paragraph 22:19-6]	569
§2513.	Sanitization [formerly paragraph 22:19-7]	569
§2515.	Air Drying [formerly paragraph 22:19-8]	570
§2517.	Storage of Clean Equipment and Utensils [formerly paragraph 22:19-9]	570
§2519.	In-Use and Between-Use Utensil Storage [formerly paragraph 22:19-10]	570
Chapter 27.	Water Supply	570
§2701.	General [formerly paragraph 22:20-1]	570
§2703.	Pressure [formerly paragraph 22:20-2]	570
§2705.	Hot Water [formerly paragraph 22:20-3]	571
§2707.	Steam [formerly paragraph 22:20-4]	571
§2709.	Bottled Water [formerly paragraph 22:20-5]	571
Chapter 29.	Sewage	571
§2901.	General [formerly paragraph 22:21-1]	571
Chapter 31.	Plumbing	571
§3101.	General [formerly paragraph 22:22-1]	571
§3103.	Cross-Connection [formerly paragraph 22:22-2]	571
§3105.	Backflow [formerly paragraph 22:22-3]	571
§3107.	Non-Potable Water System [formerly paragraph 22:22-4]	571
§3109.	Lavatory Facilities [formerly paragraph 22:22-5]	572
§3111.	Toilet Facilities [formerly paragraph 22:22-6]	572
§3113.	Grease Traps [formerly paragraph 22:22-7]	572
§3115.	Garbage Grinders [formerly paragraph 22:22-8]	572
§3117.	Utility or Service Sink [formerly paragraph 22:22-9]	572
Chapter 33.	Garbage, Rubbish and Refuse	573
§3301.	General [formerly paragraph 22:23-1]	573
§3303.	Receptacles for Garbage, Rubbish and Refuse [formerly paragraph 22:23-2]	574

Table of Contents

§3305.	Incineration [formerly paragraph 22:23-3]	574
§3307.	Cleaning and Storage [formerly paragraph 22:23-4]	574
Chapter 35.	Insects and Rodent Control	574
§3501.	General [formerly paragraph 22:24-1]	574
§3503.	Insect Control Devices [formerly paragraph 22:24-2]	574
§3505.	Openings [formerly paragraph 22:24-3]	575
§3507.	Premises [formerly paragraph 22:24-2]	575
Chapter 37.	Physical Facilities	575
§3701.	Floors [formerly paragraph 22:25]	575
§3703.	Walls and Ceilings [formerly paragraph 22:26]	575
§3705.	Lighting Intensity [formerly paragraph 22:27-1]	575
§3707.	Light Shielding [formerly paragraph 22:27-2]	576
§3709.	Mechanical Ventilation [formerly paragraph 22:28-1]	576
§3711.	Hood Ventilation [formerly paragraph 22:28-2]	576
§3713.	Heating, Air Conditioning, Ventilating System Vents [formerly paragraph 22:28-3]	576
Chapter 39.	Poisonous or Toxic Materials	576
§3901.	Labeling [formerly paragraph 22:29-1]	576
§3903.	Storage and Display [formerly paragraph 22:29-2]	576
§3905.	Use [formerly paragraph 22:29-3]	576
Chapter 41.	Miscellaneous	577
§4101.	Prohibitive Acts [formerly paragraph 22:30]	577
§4103.	Distressed Merchandise [formerly paragraph 22:32]	577
§4105.	Dressing Areas, Lockers and Employee Break Areas [formerly paragraph 22:33]	577
§4107.	Linen/Laundry, General [formerly paragraph 22:35-1]	578
§4109.	Linen/Laundry, Frequency of Cleaning [formerly paragraph 22:35-2]	578
§4111.	Wiping Cloths [formerly paragraph 22:35-3]	578
§4113.	Storage of Soiled Linens [formerly paragraph 22:35-4]	578
§4115.	Use of Laundry Facilities [formerly paragraph 22:35-5]	578
§4117.	Living Areas [formerly paragraph 22:36]	578
§4119.	Maintenance Equipment [formerly paragraph 22:37]	578
§4121.	Reduced Oxygen Packaging [formerly paragraph 22:39]	578
§4123.	Smoked Meat Preparation, Not Fully Cooked [formerly paragraph 22:40-1]	579
§4125.	Smoked Meat Preparation, Fully Cooked [formerly paragraph 22:40-2]	579
§4127.	Open Air Markets	579
§4129.	Itinerant Food Establishments, Itinerant Retail Food Stores/Markets Permit [formerly paragraph 22:34-1]	579
§4131.	Itinerant Food Establishments, Itinerant Food Stores/Markets Plans [formerly paragraph 22:34-2]	580
Chapter 43.	Inspections and Enforcement	580
§4301.	Inspections, Frequency [formerly paragraph 22:42-1]	580
§4303.	Inspections, Access [formerly paragraph 22:42-2]	580
§4305.	Inspections, Records [formerly paragraph 22:42-3]	580
§4307.	Inspections, Reports [formerly paragraph 22:42-4]	580
§4309.	Enforcement, General [formerly paragraph 22:43-2]	580
§4311.	Enforcement, Critical Violations [formerly paragraph 22:43-2]	580
§4313.	Enforcement, Noncritical Violations [formerly paragraph 22: 43-3]	580
§4315.	Enforcement, Adulterated Food [formerly paragraph 22:43-4]	580
Chapter 45.	Mobile Food Establishments, Mobile Retail Food Stores/Markets and Pushcarts [formerly paragraph 22:34-3]	581
§4501.	Interior of Vehicles	581

Table of Contents

§4503.	Packaged Food Products [formerly paragraph 22:34-4].....	581
§4505.	Produce [formerly paragraph 22:34-5]	581
§4507.	General [formerly paragraph 23:117-1].....	581
§4509.	Plans Submission [formerly paragraph 22:34-2].....	581
§4511.	Permit [formerly paragraph 23:125].....	581
§4513.	Issuance of Permits [formerly paragraph 23:126-1].....	581
§4515.	Restricted Operations [formerly paragraph 22:34-6].....	582
§4517.	Single-Service Articles [formerly paragraph 23:119]	582
§4519.	Water System [formerly paragraph 23:120]	582
§4521.	Waste Retention [formerly paragraph 23:121]	582
§4523.	Base of Operations/Commissary [formerly paragraphs 23:122, 23:123, and 23:124]	582
§4525.	Mobile Frozen Dessert Units	583
§4527.	Depots for Mobile Frozen Dessert Units	583
Chapter 47.	Temporary Food Service	583
§4701.	General [formerly paragraph 23A:002]	583
§4703.	Permits [formerly paragraph 23A:003].....	583
§4705.	Written Application [formerly 23A:003-1]	583
§4707.	Ice/Wet Storage [formerly paragraph 23A:004].....	584
§4709.	Equipment [formerly paragraph 23A:004-1].....	584
§4711.	Food Source and Protection [formerly paragraph 23A:005-1].....	584
§4713.	Personal Hygiene [formerly paragraph 23A:007]	584
§4715.	Food Stand/Booth Construction [formerly paragraph 23A:008].....	584
§4717.	Floors [formerly paragraph 23X:008-3]	585
§4719.	Barbecue Places [formerly paragraph 23A:008-4]	585
§4721.	Seafood Boils [formerly paragraph 23A:008-5].....	585
§4723.	Exception [formerly paragraph 23A:008-6]	585
§4725.	Sanitizing of Utensils and Equipment [formerly paragraph 23A:009].....	585
§4727.	Water [formerly paragraph 23A:010].....	585
§4729.	Sewage (Toilets and Waste) [formerly paragraph 23A:011].....	585
§4731.	Hand Washing [formerly paragraph 23A:012].....	585
§4733.	Refuse (Garbage and Trash) [formerly paragraph 23A:013].....	586
§4735.	Miscellaneous [formerly paragraph 23A:014-1 and 23A:014-2]	586
§4737.	Vector Control [formerly paragraph 23A:014-2]	586
§4739.	Inspections/Violations/Closure [formerly paragraph 23A:015]	586

Part XXIV. Swimming Pools and Natural or Semi-Artificial Swimming or Bathing Places

Chapter 1.	General Requirements	587
§101.	Authority [formerly paragraph 24:029]	587
§103.	Definitions [formerly Subpart A paragraph 24:001]	587
Chapter 3.	Design Requirements for Swimming Pools [formerly Subpart B].....	588
§301.	Materials of Constructions [formerly paragraph 24:004].....	588
§303.	Dimensional Design [formerly paragraph 24:005].....	588
§305.	Walls [formerly paragraph 24:005-1].....	589
§307.	Floor Slopes [formerly paragraph 24:005-2].....	589
§309.	Traditional Radius Requirements [formerly paragraph 24:005-3]	589
§311.	Water Depth [formerly paragraph 24:005-4].....	589
§313.	Diving Boards [formerly paragraph 24:005-5]:.....	589
§315.	Turnover [formerly paragraph 24:005-6]	590
§317.	Drawings and Diagrams [formerly paragraph 24:006].....	590

Table of Contents

§319.	Maximum User Load [formerly paragraph 24:007]	592
§321.	Wading Pools [formerly paragraph 24:008]	593
§323.	Decks and Deck Equipment [formerly paragraph 24:009]	593
§325.	Entry/Exit [formerly paragraph 24:010]	594
§327.	Pool Stairs [formerly paragraph 24:011]	594
§329.	Pool Ladders [formerly paragraph 24:012]	594
§331.	Pool Appurtenances [formerly paragraph 24:013]	594
Chapter 5.	Circulation Systems [formerly Subpart C]	595
§501.	Design Requirements [formerly paragraph 24:013-3]	595
§503.	Water Velocity [formerly paragraph 24:013-4]	595
§505.	Filters [formerly paragraph 24:013-5]	595
§507.	Pumps and Motors [formerly paragraph 24:013-6]	595
§509.	Return Inlets and Suction Outlets [formerly paragraph 24:013-7]	596
§511.	Inlets and Outlets [formerly paragraph 24:013-8]	596
§513.	Suction Outlet [formerly paragraph 24:013-9]	596
§515.	Surface Skimmer Systems [formerly paragraph 24:013-10]	596
§517.	Heaters [formerly paragraph 24:013-12]	597
Chapter 7.	General Standards	597
§701.	Depth Markers [formerly paragraph 24:013-13]	597
§703.	Lifesaving Equipment [formerly paragraph 24:013-14]	597
§705.	Barriers [formerly paragraph 24:013-15]	597
§707.	Interconnections [formerly paragraph 24:014]	598
§709.	Water Supply [formerly paragraph 24:015]	598
§711.	Waste Water Disposal [formerly paragraph 24:016]	598
§713.	Electrical Requirements [formerly paragraph 24:013-11]	598
§715.	Lighting [formerly paragraph 24:022]	598
§717.	Ventilation [formerly paragraph 24:023]	599
§719.	Visitors Gallery [formerly paragraph 24:024]	599
§721.	Dressing Rooms [formerly paragraph 24:025]	599
§723.	Plumbing Fixtures [formerly paragraph 24:026]	599
§725.	Experimental and Innovative Processes and Equipment [formerly paragraph 24:027]	599
§727.	Abandoned Pools [formerly paragraph 24:028]	600
§729.	Food Service for Class A and B Public Pools [formerly paragraph 24:032]	600
§731.	Operation and Maintenance [formerly paragraph 24:033]	600
§733.	Emergency Equipment [formerly paragraph 24:034]	600
Chapter 9.	Disinfection and Bacteriological Quality	600
§901.	Disinfectant Equipment and Chemical Feeders [formerly paragraph 24:017]	600
§903.	Disinfection [formerly paragraph 24:018]	601
§905.	Chemical and Physical Quality of Swimming Pool Water [formerly paragraph 24:019]	601
§907.	Cleanliness [formerly paragraph 24:020]	601
§909.	Bacterial Quality [formerly paragraph 24:021]	601

Part XXV. Mass Gatherings

Chapter 1.	General Requirements	603
§101.	Definitions [formerly paragraph 25:001]	603
§103.	Permits [formerly paragraph 25:002]	603
§105.	Access [formerly paragraph 25:006]	603
§107.	Grounds [formerly paragraph 25:007]	603
§109.	Size [formerly paragraph 25:010]	604
§111.	Lighting [formerly paragraph 25:011]	604

Table of Contents

§113.	Parking Space [formerly paragraph 25:012-1]	604
§115.	Water [formerly paragraph 25:014]	604
§117.	Sanitary Facilities [formerly paragraph 25:015]	604
Chapter 3.	Construction and Design Requirements	604
§301.	Buildings [formerly paragraph 25:018]	604
§303.	Water Facilities [formerly paragraph 25:019]	605
§305.	Disposal Systems [formerly paragraph 25:021]	605
Chapter 5.	Operations and Maintenance	605
§501.	Refuse [formerly paragraph 25:023]	605
§503.	Vector Control [formerly paragraph 25:027-1]	605
§505.	Medical and Emergencies [formerly paragraph 25:028]	605
§507.	Food Service [formerly paragraph 25:033]	605

Part XXVI. Burial, Transportation, Disinterment or Other Disposition of Dead Human Bodies

Chapter 1.	General Requirements	607
§101.	Permits [formerly paragraph 26:001-1]	607
§103.	Embalming [formerly paragraph 26:003-1]	607
§105.	Construction and Alterations of Funeral Establishments [formerly paragraph 26:004]	607
§107.	Transportation [formerly paragraph 26:005-1]	608
§109.	Burial [formerly paragraph 26:006]	608

Part XXVII. Management of Refuse, Infectious Waste, Medical Waste, and Potentially Infectious Biomedical Waste

Chapter 1.	Refuse Management [formerly Chapter XXVII Part 1]	609
§101.	Definitions [formerly paragraph 27:001]	609
§103.	Accumulation and Collection of Refuse [formerly paragraph 27:002]	609
§105.	Swine Feeding [formerly paragraph 27:006]	609
§107.	Disposal of Carcasses [formerly paragraph 27:007]	609
§109.	Stable Refuse [formerly paragraph 27:008]	610
Chapter 3.	Management of Infectious Waste, Medical Waste and Potentially Infectious Biomedical Waste [formerly Chapter XXVII Part 2]	610
§301.	Definitions [formerly paragraph 27:020]	610
§303.	Requirements for Large Health Care and Medical Facility Generators of Potentially Infectious Biomedical Waste [formerly paragraph 27:021]	611
§305.	Transportation of Potentially Infectious Biomedical Waste [formerly paragraph 27:021-9]	612
§307.	Disposal of Potentially Infectious Biomedical Wastes [formerly paragraph 27:021-10]	612
§309.	Contingency Plans [formerly paragraph 27:021-11]	612
Chapter 5.	Requirements for Small Health Care and Medical Facilities, Household and Other Small Quantity Generators of Potentially Infectious Medical Waste [formerly paragraph 27:022]	612
§501.	General Provisions [formerly paragraph 27:022-1]	612
§503.	Home-Generated Sharps	613
Chapter 7.	Transportation	613
§701.	Requirements for Transporters of Potentially Infectious Biomedical Waste [formerly paragraph 27:023]	613
Chapter 9.	Storage	614
§901.	Storage of Potentially Infectious Biomedical Waste [formerly paragraph 27:024]	614

Table of Contents

Chapter 11. Treatment..... 614
 §1101. Treatment of Potentially Infectious Biomedical Waste [formerly paragraph 27:025] 614
Chapter 13. Disposal 615
 §1301. Disposal of Potentially Infectious Biomedical Waste [formerly paragraph 27:026]..... 615
Chapter 15. Treatment Facilities 615
 §1501. General Provisions [formerly paragraph 27:027] 615
Chapter 17. Enforcement [formerly paragraph 27:028]..... 616
 §1701. General Provisions..... 616

Part XXVIII. Commercial Body Art

Chapter 1. Commercial Body Art Regulation..... 617
 §101. Definitions [formerly paragraph 28:001]..... 617
 §103. Facility Standards [formerly paragraph 28:002]..... 618
 §105. Required Equipment [formerly paragraph 28:003] 619
 §107. Practice Standards; Restrictions [formerly paragraph 28:004]..... 620
 §109. Operator Training [formerly paragraph 28:005]..... 621
 §111. Hand Washing and Protective Gloves [formerly paragraph 28:006] 621
 §113. Preparation and Aftercare of Treatment Area on Clients [formerly paragraph 28:007]..... 621
 §115. Cleaning Methods Prior to Sterilization [formerly paragraph 28:008]..... 621
 §117. Instrument Sterilization Standards [formerly paragraph 28:009] 622
 §119. Approved Sterilization Modes [formerly paragraph 28:010] 622
 §121. Waste Receptacles [formerly paragraph 28:011]..... 622
 §123. Linens [formerly paragraph 28:012]..... 622
 §125. Clean Instruments and Products Storage [formerly paragraph 28:013] 622
 §127. Chemical Storage [formerly paragraph 28:014] 623
 §129. Handling Disposable Materials [formerly paragraph 28:015]..... 623
 §131. Tattoo and Permanent Cosmetic Procedures; Preparation and Aftercare
 [formerly paragraph 28:016]..... 623
 §133. Body Piercing Procedures [formerly paragraph 28:017]..... 624
Chapter 3. Registration [formerly paragraph 28:018]..... 624
 §301. Procedures [formerly paragraph 28:018-1]..... 624
 §303. Registration Application Form [formerly paragraph 28:019]..... 625
 §305. Registration Fees [formerly paragraph 28:020]..... 625
 §307. Issuance of Certificate of Registration [formerly paragraph 28:021]..... 625
 §309. Renewal of Certificate of Registration [formerly paragraph 28:022]..... 625
 §311. Temporary Commercial Body Art Facility/Operator Registration
 [formerly paragraph 28:023]..... 626
 §313. Temporary Commercial Body Art Facility/Operator Registration Requirements
 [formerly paragraph 28:024]..... 626
 §315. Report of Changes [formerly paragraph 28:025]..... 627
 §317. Transfer of Registrations [formerly paragraph 28:026]..... 627
Chapter 5. Enforcement [formerly paragraph 28:027]..... 627
 §501. General Provisions [formerly paragraph 28:027-1]..... 627
 §503. Suspension or Revocation of Approval [formerly paragraph 28:029] 627
 §505. Injunctive Relief [formerly paragraph 28:030]..... 627
 §507. Severability [formerly paragraph 28:031] 627
Chapter 7. Facility Inspections [formerly paragraph 28:028]..... 628
 §701. General Provisions [formerly paragraph 28:028-1]..... 628

Part XXIX. Medical Marijuana

Chapter 1. General Requirements	629
§101. Definitions	629
Chapter 3. Authority; Preemption	629
§301. Authority	629
Chapter 5. Licensure and Permitting.....	629
§501. Licensure of Authorized Entities	629
§503. Permitting.....	629
§505. Application Process	630
Chapter 7. Inspections and Operational Requirements	630
§701. Inspections	630
§703. Product and Site Security.....	631
§705. Louisiana Medical Marijuana Tracking System	631
§707. Inventory Control.....	631
§709. Toxic Chemical Use and Storage.....	631
§711. Transportation of Medical Marijuana	632
§713. Sampling Requirements	632
§715. Basic Facility Requirements	633
Chapter 9. Approved Laboratories for Testing Medical Marijuana.....	634
§901. General Requirements.....	634
§903. Application Process	634
§905. Exemptions	634
§907. Records	634

Title 51
PUBLIC HEALTH—SANITARY CODE
Part I. General Provisions

Chapter 1. General

§101. Definitions

[formerly paragraph 1:001]

A. Words not defined in any Part or Chapter of the code shall have their common usage and meaning as stated in the *Merriam-Webster's Collegiate Dictionary-Tenth Edition*, as revised, and other similarly accepted reference texts. When the same word or term is defined in more than one Part or Chapter of the code, the definition contained within the particular Part or Chapter in which the word is contained shall be given preference as it pertains to that Part or Chapter. When a word or term is not defined in a Part or Chapter of the code but is cross-referenced to another Part or Chapter, it shall have the definition contained in the Part or Chapter to which it is cross-referenced.

B. Unless otherwise specifically provided herein, the following words and terms used in this Chapter are defined for the purposes thereof as follows.

Code—state Sanitary Code.

Compliance Order—a written notice issued by the state health officer and the secretary of the department, which documents violation(s) of the code and references the provision(s) of the code violated, to the owner, manager, lessee or their agent, of an establishment, facility or property, and specifies a time frame for compliance. The compliance order shall be issued after violation(s) have been documented in an inspection and the same violation(s) continue and are documented in a reinspection. The compliance order shall inform the aggrieved party of the possible penalties for failure to comply with the compliance order and the right of the aggrieved party to an administrative appeal to the Division of Administrative Law. Nothing herein shall be interpreted to prohibit the state health officer and the secretary of the department to issue a written notice documenting violation(s) of the code, referencing the provision(s) of the code violated and specifying a time frame for compliance to such other persons as they deem necessary to aid in the enforcement of the provisions of the code, including orders modifying, suspending, or revoking permits, variances, or exemptions, and orders requiring persons to comply with a rule, regulation, schedule or other requirement of the state health officer.

CFR—Code of Federal Regulations.

Department—the Louisiana Department of Health.

EPA—United States Environmental Protection Agency.

FDA—United States Food and Drug Administration.

Emergency Situation—any situation or condition which warrants immediate enforcement measures more expedient than normal administrative violation control and abatement procedures due to its perceived imminent or potential danger to the public health.

Hazard—a biological, chemical, or physical property that may cause an unacceptable consumer health risk.

Imminent Health Hazard—an emergency situation that is a significant threat or danger to health that is considered to exist when there is evidence sufficient to show that a product, practice, circumstance, or event creates a situation that requires immediate correction or cessation of operation to prevent injury or serious illness.

Law—applicable local, state, and federal statutes, regulations, and ordinances.

LSPC—Louisiana State Plumbing Code, i.e., Part XIV (Plumbing) of this Code (LAC 51:XIV).

Notice of Violation—a written notice issued to the owner, manager, lessee or their agent of an establishment, facility or property which documents the nature of the violation(s) of the code, including a reference to the provision(s) of the code which have been violated, which were observed during an inspection or investigation by a representative of the state health officer. This term shall also include a written notice issued to such other persons as may be deemed necessary who have violated or have been alleged to violate the provisions of this code when such notice documents the nature of the violation(s) of the code, including a reference to the provision(s) of the code which have been violated, all of which were observed or discovered either during an inspection or investigation by a representative of the state health officer.

Person—any natural person, individual, partnership, corporation, limited liability company, association, governmental subdivision, receiver, tutor, curator, executor, administrator, fiduciary, or representative of another person, or public or private organization of any character.

Secretary—executive head and chief administrative officer of the department who has been appointed by the governor with the consent of the senate in accord with R.S. 40:253. This term shall also include any acting secretary of the department and the secretary/acting secretary's duly authorized representative(s).

Shall—mandatory requirements.

Should or *May*—recommended or advisory procedures or equipment.

State Health Officer—the individual designated as “state health officer” pursuant to R.S. 40:2 and, except for the

purpose of issuing variances, those individuals authorized to act on behalf thereof pursuant to R.S. 40:4 and 40:5. For the purpose of issuing variances, the term shall include any individual the state health officer has personally and specifically designated to issue variances on his/her behalf.

State Sanitary Code—rules, regulations, and provisions promulgated by the state health officer which covers matters within his jurisdiction in accord with the authority granted under R.S. 36:258(B), R.S.40:4(A), and R.S. 40:5. Such rules, regulations, and provisions are housed in Title 51 of the *Louisiana Administrative Code (LAC)*, i.e., LAC 51.

Substantial Renovation—

a.i. alterations or repairs made within a 12 month period, costing in excess of 50 percent of the then physical value of the existing building; or

ii. alterations or repairs made within a 12 month period, costing in excess of \$15,000; or

iii. alterations or repairs made involving a change in "occupancy classification" or use of the property;

b. the physical value of the building in Clause a.i of this Paragraph may be established by an appraisal not more than three years old, provided that said appraisal was performed by a certified appraiser or by the tax assessor in the parish where the building is located;

c. the cost of alterations or repairs in Clause a.ii or a.iii of this Paragraph may be established by:

i. an estimate signed by a licensed architect or a licensed general contractor; or

ii. by copies of receipts for the actual costs;

d. the text contained in Subparagraphs a.i-c.ii continues to apply when any particular portion of this code calls for an additional requirement to the term substantial renovation (e.g., see LAC 51:XIV.411.A.1).

Violation—a transgression of a Section, Subsection, Paragraph, Subparagraph, Clause, Subclause, or any other divisions thereof of the code. Violations are classified into four classes corresponding to the severity of the violation:

Class A Violation—violations that create a condition or occurrence, which may result in death or serious harm to the public. Class A civil fines shall be \$100 per day per violation.

Class B Violation—violations related to permitting, submitting of plans, or training requirements. Class B civil fines shall be \$75 per day per violation.

Class C Violation—violations that create a condition or occurrence, which creates a potential for harm by indirectly threatening the health and/or safety of the public or creates a nuisance to the public. Class C civil fines shall be \$50 per day per violation.

Class D Violation—violations related to administrative, ministerial, and other reporting requirements

that do not directly threaten the health or safety of the public. Class D civil fines shall be \$25 per day per violation.

Violator—primarily, any person who has been issued a Notice of Imposition of penalty for noncompliance with any provision of a compliance order. Generally, this term shall also include persons who have been issued a Notice of Violation wherein such person(s) is alleged to have violated one or more provisions of the state sanitary code.

AUTHORITY NOTE: Promulgated in accordance with R.S. 40:4 and R.S. 40:5(A)(3)(7)(17)(19)(20)(21).

HISTORICAL NOTE: Promulgated by the Department of Health and Hospitals, Office of Public Health, LR 27:1693, (October 2001), repromulgated LR 28:1209 (June 2002), amended LR 28:2528 (December 2002), LR 34:652 (April 2008), LR 38:2375 (September 2012), LR 38:2790 (November 2012), amended by the Department of Health, Office of Public Health, LR 44:783 (April 2018).

§103. Severability

[formerly paragraph 1:006]

A. If any provision of this code, or the application of such provision to any person or circumstance, shall be held invalid, the remainder of this code, or the application of such provision to persons or circumstances other than those as to which it is held invalid, shall not be affected thereby.

AUTHORITY NOTE: Promulgated in accordance with R.S. 40:4.

HISTORICAL NOTE: Promulgated by the Department of Health and Hospitals, Office of Public Health, LR 27:1693, (October 2001), amended LR 28:1210 (June 2002).

§105. Administrative Enforcement Procedures

[formerly paragraph 1:007-1]

A. The proper documentation of violations is an essential part of the enforcement process. When an establishment is inspected and violations of the code are found, they shall be noted either on a notice of violation(s) form or letter. The sanitarian, engineer or other representative of the state health officer shall describe with particularity the nature of the violation(s), including a reference to the provision(s) of the code which have been violated. A specific date shall be set for correction and the violator shall be warned of the penalties that could ensue in the event of noncompliance.

AUTHORITY NOTE: Promulgated in accordance with R.S. 40:4 and R.S. 40:5(3)(7)(17)(19)(20)(21).

HISTORICAL NOTE: Promulgated by the Department of Health and Hospitals, Office of Public Health, LR 27:1693, (October 2001), amended LR 28:1210 (June 2002), LR 34:652 (April 2008).

§107. Delivery of the Notice of Violation

[formerly paragraph 1:007-2]

A. In those cases in which the state health officer or his/her representative determines that a violation has occurred and a decision is made to issue a notice of violation, the notice of violation form or letter which list the violation(s) shall:

1. be left with the operator, owner, manager, lessee or their agent, or person in charge of the establishment, facility, or property at the time of such inspection or monitoring;

2. be hand-delivered or mailed to the person in charge of the establishment, facility, or property as soon as a determination is made that there is/are violation(s); or

3. be left with, hand-delivered, or mailed to any other person deemed to have violated the state sanitary code.

B. Any notice of violation which has been left with the operator, owner, manager, lessee or their agent, or person in charge of the establishment, facility, or property at the time of inspection or monitoring shall have the date that the notice of violation was left with such person recorded on the notice of violation form or letter.

C. Any notice of violation which is hand-delivered shall have the date of delivery recorded on the notice of violation form or letter or shall have the date of delivery of the notice of violation recorded on a service of process form.

D. Any notice of violation which is issued by mailing shall be sent by United States Postal Service, via certified mail-return receipt requested, registered mail-return receipt requested, or express mail-return receipt requested.

AUTHORITY NOTE: Promulgated in accordance with R.S. 40:4 and R.S. 40:5(3)(7)(17)(19)(20)(21).

HISTORICAL NOTE: Promulgated by the Department of Health and Hospitals, Office of Public Health, LR 27:1694 (October 2001), repromulgated LR 28:1210 (June 2002), amended LR 28:2529 (December 2002), LR 34:652 (April 2008).

§109. Service of Orders, Notices, and Other Documents

A. Whenever any provision of law or of this Code requires or authorizes service of a letter, notice, order, or other document to be made upon a person, then, in addition to any other method authorized by this code for such service, the following shall constitute good and valid service for all purposes related to this Code:

1. service made in any manner authorized by the *Louisiana Code of Civil Procedure* or the *Louisiana Revised Statutes* of 1950;

2. service made by U.S. Postal Service certified mail, return receipt requested, addressed to the registered agent of the person as indicated in the records of the Secretary of State;

3. service made by U.S. Postal Service certified mail, return receipt requested, addressed to the person at his/her dwelling house or usual place of abode;

4. service made by U.S. Postal Service certified mail, return receipt requested, addressed to the last mailing address provided in writing to the department by the person; or

5. for a person holding a permit, certificate, or license issued by the department:

a. service made by U.S. Postal Service certified mail, return receipt requested, addressed to the mailing address provided to the department in accordance with §120 of this Part; or

b. service by e-mail sent to the e-mail address provided to the department in accordance with §120 of this Part, even if returned as undeliverable. A document served by e-mail must be in printable document format (PDF) and may be either attached, in which case the entire e-mail with the attachment cannot exceed 20 megabytes (MB), or linked within the body of the e-mail to a file sharing site from which it can be viewed or downloaded.

B. Whenever service by certified mail is authorized by this Section or any other provision of the Code, if a certified mail receipt shows that service has been refused or unclaimed, then service shall nevertheless be deemed complete and valid if the department, within 15 days of receiving the certified mail receipt so marked, sends by regular mail a copy of the letter, notice, order, or other document to the person at the address to which the certified mailing was sent. Service by such regular mail shall be deemed complete 7 days after mailing.

C. A certified mailing sent in accordance with Paragraphs A.2, A.3, A.4, or Subparagraph A.5.a of this Section shall be deemed good and valid service if a signed receipt is returned to the department, regardless of whether the person to whom the mailing was addressed personally signed the return receipt.

AUTHORITY NOTE: Promulgated in accordance with R.S. 40:4 and 40:5(A)(3)(7)(17)(19)(20)(21).

HISTORICAL NOTE: Promulgated by the Department of Health, Office of Public Health, LR 44:783 (April 2018).

§111. Reinspection and Compliance Order [formerly paragraph 1:007-5]

A. If reinspection discloses that the violation(s) specified in the notice of violation has not been remedied, the state health officer or his/her representative may issue a compliance order requiring correction of the violation(s) after said compliance order is served, or take whatever action is authorized by law to remedy the violation(s). Compliance orders may be issued by the state health officer to any such persons as he deems necessary to aid in the enforcement of the provisions of the code, including orders modifying, suspending, rescinding or revoking permits, variances, or exemptions, and orders requiring persons to comply with a rule, regulation, schedule, or other requirement of the state health officer. An order may also require remedial actions to be taken to prevent harm to public safety, health, or welfare.

B. Compliance orders shall be served by United States Postal Service, via certified mail-return receipt requested, registered mail-return receipt requested, or express mail-return receipt requested, or hand-delivered. Any compliance order which is hand-delivered shall have the date of delivery recorded on the compliance order or shall have the date of delivery of the compliance order recorded on a service of process form.

C. Any compliance order issued under this Section shall:

1. be signed by the state health officer and the secretary and shall be effective upon issuance unless a later date is specified therein;

2. state with reasonable specificity the nature of the violation;

3. state a time limit for compliance;

4. state that in the event of non-compliance, a civil fine may be assessed and/or an existing license or permit issued by the department may be suspended or revoked;

5. state that the order shall become final and not subject to further review 20 days after the order has been served to the respondent, unless the respondent files a written request for an administrative hearing with the state health officer within that 20 day period; and

6. be subject to appeal procedures set forth by state law.

D. If timely received, the state health officer shall forward any request for an administrative hearing to the Division of Administrative Law (DAL). In accord with R.S. 49:991 et seq., hearings shall be held by an Administrative Law Judge (ALJ) employed by the DAL.

E. Upon finding that an emergency exists which requires that immediate action be taken, the state health officer shall issue such emergency compliance orders as are necessary, which shall be effective immediately upon issuance, and any request for hearing shall not suspend the implementation of the action ordered. In any case wherein the state health officer determines that an emergency compliance order is required to be issued, the prior issuance of a notice of violation shall not be necessary.

AUTHORITY NOTE: Promulgated in accordance with R.S. 40:4 and R.S. 40:5(3)(7)(17)(19)(20)(21).

HISTORICAL NOTE: Promulgated by the Department of Health and Hospitals, Office of Public Health, LR 27:1694 (October 2001), repromulgated LR 28:1210 (June 2002), amended LR 28:2529 (December 2002), LR 34:653 (April 2008).

§113. Suspension/Revocation/Civil Fines or Penalties [formerly paragraph 1:007-21]

A. Pursuant to the provisions of R.S. 40:4, R.S. 40:5 and R.S. 40:6, the state health officer acting through the Office of Public Health, for violation(s) of a compliance order may:

1. suspend or revoke an existing license or permit;

2. seek injunctive relief as provided for in R.S. 40:4 and in 40:6; and/or

3. impose a civil fine:

a. these civil fines shall not exceed \$10,000 per violator per calendar year applicable to each specific establishment, facility, or property that the violator owns, manages, operates or leases. The schedule of civil fines by class of violations shall be as follows:

i. class A. Violations that create a condition or occurrence, which may result in death or serious harm to the public. These violations include, but are not limited to: cooking, holding or storing potentially hazardous food at

improper temperatures; failure to follow schedule process in low acid canned foods or acidified food production; poor personal hygienic practices; failure to sanitize or sterilize equipment, utensils or returnable, multi-use containers; no water; unapproved water source; cross contamination of water; inadequate disinfection of water before bottling; sewage back up; sewage discharge on to the ground; sewage contamination of drinking water; failure to comply with human drug current good manufacturing practices (CGMP); inadequate labeling of foods or drugs regarding life threatening ingredients or information; failure to provide consumer advisories; non-compliant UV lamps or termination control switch on tanning equipment; the inadequate handling and disposal of potentially infectious biomedical wastes; failure to obtain food safety certification in accordance with §305 of Part XXIII; etc. Class A civil fines shall be \$100 per day per violation;

ii. class B. Violations related to permitting, submitting of plans, or training requirements. These violations include, but are not limited to: failure to submit plans or to obtain or hold: a permit to operate; a commercial body art certification; tanning equipment operator training; day care training; a license to install, maintain, or pump out sewage systems; etc. Class B civil fines shall be \$75 per day per violation;

iii. class C. Violations that create a condition or occurrence, which creates a potential for harm by indirectly threatening the health and/or safety of the public or creates a nuisance to the public. These violations include, but are not limited to, failure to: properly label food; properly protect food; properly store clean equipment; provide self-closing restroom doors; provide adequate lighting; provide hair restraints; provide soap and towels at hand-washing lavatories; clean floors, walls, ceilings and non-food contact surfaces; properly dispose of garbage; maintain onsite sewage systems; provide electrical power to onsite sewage systems; etc. Class C civil fines shall be \$50 per day per violation;

iv. class D. Violations related to administrative, ministerial, and other reporting requirements that do not directly threaten the health or safety of the public. These violations include, but are not limited to, failure to: retain oyster tags; provide hazard analysis critical control plans (HACCP); maintain HACCP records; provide consumer information; provide written recall procedures; maintain lot tracking records; turn in onsite sewage system maintenance records or certification of installation; register product labels; etc. Class D civil fines shall be \$25 per day per violation;

b. the duration of noncompliance with a provision of the compliance order shall be determined as follows:

i. an investigation shall be conducted by staff for the purpose of determining compliance/noncompliance within five working days after the deadline date(s) specified in the compliance order. If non-compliance still exists, staff will provide a copy of the post-order investigation report to the person in charge and daily penalty assessments shall

begin to accrue immediately from the date that non-compliance was determined in the post-order investigation report;

ii. the daily penalties shall accrue until such time as the agency has been notified in writing by the person in charge that compliance has been achieved and such compliance verified by agency staff, or upon reaching the maximum penalty cap of \$10,000 per violator per calendar year. Upon written notification by the person in charge of compliance, an investigation to verify compliance shall be made within five working days of receipt of such notification;

iii. upon verification by investigation that compliance has been achieved, the penalties will cease to accrue on the date of receipt of notification by the person in charge;

c. the secretary of the Department of Health and Hospitals, upon the recommendation of the state health officer, may exercise his discretion and mitigate these civil fines or in lieu of a civil fine, require the violator or an employee designee to attend training seminars in the area of the violator's operations in cases where he is satisfied the violator has abated the violation and demonstrated a sincere intent to prevent future violations;

d. at the discretion of the state health officer, notice(s) imposing penalty assessments may be issued subsequent to either initial or continued noncompliance with any provision of the compliance order. Notice(s) imposing penalty assessments shall be served by United States Postal Service, via certified mail-return receipt requested, registered mail-return receipt requested, or express mail-return receipt requested, or hand delivered. Within the notice imposing penalty assessment, the state health officer will inform the person in charge of the ability to apply for mitigation of penalties imposed and of the opportunity to petition for administrative appeal within 20 days after said notice is served, according to the provisions of R.S. 49:992 of the Administrative Procedure Act;

e. once a penalty assessment is imposed, it shall become due and payable 20 calendar days after receipt of notice imposing the penalty unless a written application for mitigation is received by the state health officer within 20 calendar days after said notice is served or a petition for administrative appeal relative to contesting the imposition of the penalty assessment is filed with the Division of Administrative Law, P.O. Box 44033, Baton Rouge, LA 70804-4033 within 20 calendar days after said notice is served;

f. the department may institute all necessary civil action to collect fines imposed;

g. this Section shall not be construed to limit in any way the state health officer's authority to issue emergency orders pursuant to the authority granted in R.S. 40:4 and §115 of this Part;

h. the provisions of Paragraph 3 and Subparagraph a shall not apply to floating camps, including but not limited

to houseboats which are classified as vessels by the United States Coast Guard in accordance with R.S. 40:6 as amended by Act 516 of the 2001 Regular Legislative Session;

4. may (in cases involving pollution of streams, rivers, lakes, bayous, or ditches which are located in public rights of way outside Lake Pontchartrain, Toledo Bend Reservoir or the Sabine River, their drainage basins or associated waterways):

a. suspend or revoke the existing license or permit; and/or

b. issue a civil compliance order and impose a fine of \$100 per day up to a maximum of \$10,000 in cases where establishments operate without a license or permit or continue to operate after revocation or suspension of their license or permit;

5. may (in cases involving pollution of Lake Pontchartrain, Toledo Bend Reservoir, the Sabine River, their drainage basins, or associated waterways and pursuant to the provisions of R.S. 40:1152 and 40:1153):

a. issue a civil compliance order and/or suspend or revoke the existing license or permit; and/or

b. impose a fine of \$100 per day up to a maximum of \$10,000 in cases where establishments operate without a license or permit, or continue to operate after revocation or suspension of their license or permit.

AUTHORITY NOTE: Promulgated in accordance with R.S. 40:4.

HISTORICAL NOTE: Promulgated by the Department of Health and Hospitals, Office of Public Health, LR 27:1694 (October 2001), repromulgated LR 28:1210 (June 2002), amended LR 28:2529 (December 2002), LR 41:148 (January 2015).

§115. Emergency Situations **[formerly paragraph 1:007-21]**

A. The state health officer may issue emergency orders pursuant to the authority granted in R.S. 40:4.

AUTHORITY NOTE: Promulgated in accordance with R.S. 40:4.

HISTORICAL NOTE: Promulgated by the Department of Health and Hospitals, Office of Public Health, LR 27:1694, (October 2001), amended LR 28:1210 (June 2002).

§117. Employee Health

A. [formerly paragraph 1:008-1] No person known to be a case or carrier of a communicable disease, as defined in Part II, §101, in an infectious stage which can be transmitted through water, milk or other food materials, shall be employed as a food handler or permitted to work in any capacity in a manufacturing, processing or packing plant; in a food, drug or cosmetic plant; in any bakery or manufacturing confectionery; in a food salvaging or repackaging area; in syrup rooms, mixing areas, filling rooms, in an artificial ice or cold storage plant, or in the delivery or distribution of ice; in a dairy farm, transfer station, receiving station or milk plant; in a marine or fresh water animal food product establishment; in a game and or small animal slaughterhouse or meat packing plant; in a

water treatment plant; in a hotel, lodging house, or boarding house, in a school, day care center, residential facility (as defined in Part XXI) in any capacity which might bring him into contact with other employees or pupils; in a retail food store/market; or in a food establishment; except where there is no reasonable possibility of disease transmission by such person.

B. [formerly paragraph 1:008-2] Any individual suspected of being a case or carrier of a communicable disease, as defined in Part II, §101, or who is a contact of or has been exposed to a communicable disease which can be transmitted through water, milk or other food or beverage materials shall submit to an examination by a licensed physician and/or to the collection of appropriate specimens as may be necessary or desirable in ascertaining the infectious status of the individual. Any such person who refuses to submit to such an examination or specimen collection shall not be permitted to work in the types of establishments listed in §117.A until he submits to such examination.

C. [formerly paragraph 1:008-3] Routine examinations and collections of specimens shall not be required.

AUTHORITY NOTE: Promulgated in accordance with R.S. 40:4.

HISTORICAL NOTE: Promulgated by the Department of Health and Hospitals, Office of Public Health, LR 27:1694, (October 2001), amended LR 28:1210 (June 2002).

§119. Plans and Permits

A. [formerly paragraph 1:009-1] Certain activities require submission of plans to the state health officer, who must approve the plans and issue a permit prior to the initiation of the activity. This includes but is not limited to the operation, construction or renovation of facilities. For details, see the appropriate Parts of this Code.

B. [formerly paragraph 1:009-2] In those instances in which such activities, for which submission of plans prior to initiation of the activity is required, are found to exist, and no such submittal of plans has been made, the state health officer shall, upon submittal of the required plans and determination of compliance of such activity with this code, offer no objection to the existence of such activity. This shall not be construed to limit in any way the state health officer's authority to suspend, rescind, revoke, or reissue such position of no objection, just as with any other approval or permit, as per §119.C of this Part. The burden of proof of compliance shall be on the applicant.

C. [formerly paragraph 1:010] The state health officer can suspend, rescind, revoke, and reissue permits or approvals, or issue new permits or approvals as provided in this code. The addresses to which requests shall be submitted are set forth in the appropriate Parts of this code.

1. [formerly 1:010-1] If any permit requiring a fee is paid for by a check that is returned for insufficient funds, closed account, stop payment, or for any other reason, the permit holder must reimburse the appropriate agency within 30 days of notification that their check has been returned. Failure to comply with this Paragraph shall be sufficient

grounds for the suspension, rescission, or revocation of said permit.

AUTHORITY NOTE: Promulgated in accordance with R.S. 40:4 and R.S. 40:5(3)(7)(17)(19)(20)(21).

HISTORICAL NOTE: Promulgated by the Department of Health and Hospitals, Office of Public Health, LR 27:1695, (October 2001), amended LR 28:1211 (June 2002), LR 34:653 (April 2008).

§120. Duty of Permit, Certificate, or License Applicant or Holder to provide the State Health Officer with both a Valid, Current Mailing and E-Mail Address

A. No permit, certificate, or license required by this code shall be issued by the state health officer or the Louisiana Department of Health, Office of Public Health (LDH-OPH) unless the applicant provides both a valid, current mailing and e-mail address at which the applicant can receive correspondence and official notices from LDH-OPH.

B. A holder of a permit, certificate, or license issued pursuant to this code by the state health officer or the LDH-OPH, regardless of whether such holder was the original applicant thereof, must notify LDH-OPH of any change in the mailing or e-mail address by one of the following means:

1. written notice via U.S. mail addressed to:

ATTN: Change of Address Notification
LDH-OPH State Health Officer
Louisiana Department of Health
P.O. Box 4489
Baton Rouge, LA 70821-4489; or

2. e-mail with a subject line that reads "Change of Address Notification" sent to any e-mail address expressly designated for change of address purposes on the OPH portion of the LDH's website.

C. Any notification received by LDH-OPH of such change in mailing address or e-mail address shall not be deemed complete until such applicant or holder receives acknowledgement thereof from LDH-OPH via e-mail or U.S. mail.

AUTHORITY NOTE: Promulgated in accordance with R.S. 40:4 and 5.

HISTORICAL NOTE: Promulgated by the Department of Health, Office of Public Health, LR 44:783 (April 2018).

§121. Effective Date of Code [formerly paragraph 1:011]

A. The provisions of this code shall have effect from the date of publication hereof as a rule in the *Louisiana Register*, except as hereinafter otherwise specifically provided.

AUTHORITY NOTE: Promulgated in accordance with R.S. 40:4.

HISTORICAL NOTE: Promulgated by the Department of Health and Hospitals, Office of Public Health, LR 27:1695, (October 2001), amended LR 28:1211 (June 2002).

§123. Exemptions from Code [formerly paragraph 1:011]

A. When the construction of buildings and facilities was approved by the state health officer pursuant to sanitary code

requirements then in effect, upgrading of such buildings and facilities shall not be required except where:

1. substantial renovation of such buildings or facilities is undertaken; or

2. where the ownership thereof or the business located therein changes subsequent to the effective date of the Sanitary Code; or

a. The text, or a portion thereof, contained in Paragraph A.2 does not apply when any particular provision of this code allows an exception to such requirement (e.g., see LAC 51:XIV.411.A.1.a and LAC 51:XXIII.301.A.3 - relative to a real property ownership change only). The non-applicable text, or a portion thereof, of Paragraph A.2 is limited to what is allowed under the specific exception thereto. The wording of this Subparagraph shall not be deemed to supercede the need to upgrade when:

i. Paragraph A.1 is applicable (i.e., substantial renovation is undertaken);

ii. the business located therein changes (i.e., the occupancy classification changes) under Paragraph A.2; or

iii. Paragraph A.3 is applicable (i.e., a serious health threat exists).

3. where a serious health threat exists, unless otherwise specifically provided hereinafter.

AUTHORITY NOTE: Promulgated in accordance with R.S. 40:4 and R.S. 40:5.

HISTORICAL NOTE: Promulgated by the Department of Health and Hospitals, Office of Public Health, LR 27:1695,

(October 2001), amended LR 28:1211 (June 2002), LR 38:2790 (November 2012).

§124. Variances from Code

A. The state health officer has the authority and discretion to issue a written variance concerning the application of any provision of the code in any particular case when, in his/her opinion based upon the extenuating circumstances presented, it is determined that the health and safety of the public will not be jeopardized.

AUTHORITY NOTE: Promulgated in accordance with R.S. 40:4 and R.S. 40:5(3)(17).

HISTORICAL NOTE: Promulgated by the Department of Health and Hospitals, Office of Public Health, LR 38:2375 (September 2012).

**§125. Alternate Administrative Enforcement Procedures
[formerly 1:007-24]**

A. When the state health officer chooses to utilize the administrative order/civil penalty authority granted within R.S. 40:5.9 relative to violations applicable to public water systems, the regulations which implement the enforcement provisions of this law are embodied within Chapters 5 and 7 of Part XII of the code.

AUTHORITY NOTE: Promulgated in accordance with R.S. 40:4, R.S. 40:5.9, and R.S. 40:5(3)(7)(17)(19)(20)(21).

HISTORICAL NOTE: Promulgated by the Department of Health and Hospitals, Office of Public Health, LR 34:654 (April 2008).

Title 51
PUBLIC HEALTH—SANITARY CODE
Part II. The Control of Diseases

Chapter 1. Disease Reporting Requirements

§101. Definitions
[formally paragraph 2:001]

A. Unless otherwise specifically provided herein, the following words and terms used in this Part and all other Parts which are adopted or may be adopted, are defined for the purposes thereof as follows.

Carbon Monoxide—carbon monoxide (CO) is a colorless, odorless, poisonous gas produced through incomplete combustion of carbon-based fuels, including gasoline, oil, and wood.

Carrier—a person, who without apparent symptoms of a communicable disease, harbors the specific infectious agent and may serve as a source of infection. The carrier state may occur with infections unapparent throughout their course, and also as a feature of incubation period, convalescence, and post-convalescence of a clinically recognizable disease.

Case—a particular instance of disease.

Case of Arsenic Exposure—any medical condition/visit resulting from arsenic exposure as determined from the exposure history or patient statement and/or injury resulting from inhalation, ingestion, dermal exposure or ocular contact with arsenic. Laboratory test results for arsenic: includes results of arsenic tests (blood, urine, or tissue samples), regardless of test result.

Case of Cadmium Exposure—any medical condition/visit resulting from cadmium exposure as determined from the exposure history or patient statement and/or injury resulting from inhalation, ingestion, dermal exposure or ocular contact with cadmium. Laboratory test results for cadmium: includes results of cadmium tests (blood, urine, or tissue samples), regardless of test result.

Case of Carbon Monoxide Exposure—any medical condition/visit resulting from carbon monoxide exposure as determined from the exposure history or patient statement and/or injury resulting from inhalation contact with carbon monoxide. Laboratory test results for carbon monoxide includes results of carboxyhemoglobin tests (blood samples), regardless of test result.

Case of Lead Exposure—any medical condition/visit resulting from lead exposure as determined from the exposure history or patient statement and/or injury resulting from inhalation, ingestion, dermal exposure or ocular contact with lead. Laboratory test results for lead: includes results of lead tests (blood, urine, or tissue samples), regardless of test result.

Case of Mercury Exposure—any medical condition/visit resulting from mercury exposure as determined from the exposure history or patient statement and/or injury resulting from inhalation, ingestion, dermal exposure or ocular contact with mercury. Laboratory test results for mercury: includes results of mercury tests (blood, urine, or tissue samples), regardless of test result.

Case of Perinatal Exposure to Human Immunodeficiency Virus (HIV)—any instance of a live birth to a woman in whom HIV infection was present prior to the birth (indicated by maternal or neonatal HIV testing). Laboratory test results for perinatal exposure to HIV include results of HIV-related tests for any child 0 to 6 years of age, regardless of test result.

Case of Perinatal Exposure to Treponema Pallidum—any instance of a live birth or stillbirth to a woman in whom syphilis infection was present prior to the birth (indicated by maternal or neonatal syphilis testing).

Case of Pesticide-Related Illness and Injury—any medical condition/visit resulting from pesticide exposure as determined from the exposure history or patient statement and/or acute, subacute, or chronic illness or injury resulting from inhalation, ingestion, dermal exposure or ocular contact with a pesticide. Laboratory test results for pesticide-related illness and injury includes results of cholinesterase tests (plasma and red blood cell), regardless of test results, for which the purpose of the test was possible pesticide exposure; and tests of pesticides or metabolites in blood, urine, or tissue samples, regardless of test results.

Communicable Disease—an illness due to a specific infectious agent or its toxic products, which arises through transmission of that agent or its products from a reservoir to susceptible host, either directly as from an infected person or animals, or indirectly through the agency of an intermediate plant or animal host, a vector or the inanimate environment.

Contact—any person who has been in such association with an infected person or animal or with a contaminated environment as to have had opportunity to acquire the infection.

Day Care Center—this term as defined in Part XXI.101.A of this code.

Isolation—the separation for the period of communicability of infected persons from other persons, in such places and under such conditions as will prevent the direct or indirect conveyance of the infectious agent from infected persons to persons who are susceptible or who may spread the agent to others.

Louisiana Immunization Network (“LINKS”)—the official Louisiana immunization information registry system, authorized by R.S. 40:31.13 and maintained by the Louisiana Department of Health, Office of Public Health (LDH-OPH).

Pesticide—any pesticide defined in the Louisiana Pesticide Law (Louisiana Revised Statutes Title 3, Chapter 20, 1999) as now stated and as may be amended in the future. Pesticides include but are not limited to insecticides, herbicides, rodenticides, repellants, fungicides, and wood treatment products.

Quarantine—the limitation of freedom of movement of such well persons or domestic animals as have been exposed to a communicable disease for a period of time equal to the longest usual incubation period of the disease, in such manner as to prevent effective contact with those not so exposed.

NOTE: In connection with the control of communicable diseases, the term *quarantine* is frequently used interchangeably with the term *isolation* as defined above in this Paragraph. At times, the two terms may be used together, as in an *isolation/quarantine order* pursuant to R.S. 40:4(A)(13), and further pursuant to §§117-121 in the body of this Part in this code pertaining to the Control of Diseases.

Reportable Disease—any disease or condition for which an official report is required by the state health officer.

AUTHORITY NOTE: The first source of authority for promulgation of the sanitary code is in R.S. 36:258(B), with more particular provisions found in Chapters 1 and 4 of Title 40 of the Louisiana Revised Statutes. This Part is promulgated in accordance with the specific provisions of R.S. 40:4(A)(2) and R.S. 40:5(1)(2) and (10).

HISTORICAL NOTE: Promulgated by the Department of Health and Hospitals, Office of Public Health, LR 28:1212 (June 2002), amended LR 32:1050 (June 2006), LR 34:2173 (October 2008), repromulgated LR 34:2582 (December 2008), LR 36:1014 (May 2010), amended by the Department of Health, Office of Public Health, amended LR 45:667 (May 2019), LR 46:589 (April 2020).

§103. Public Notice of Reportable Diseases [formerly paragraph 2:002]

A. Those diseases to be reportable will be publicly declared by the state health officer and when any disease is so declared to be a reportable disease, the regulation herein provided shall apply thereto. The state health officer may, at his discretion, from time to time, by public notice, add to or delete from the list of reportable diseases. When a disease is added to the list, the regulations herein pertaining to the reporting of disease shall apply to said disease.

AUTHORITY NOTE: Promulgated in accordance with the provisions of R.S. 40:4(A)(2) and R.S. 40:5(10).

HISTORICAL NOTE: Promulgated by the Department of Health and Hospitals, Office of Public Health, LR 28:1212 (June 2002).

§105. Reportable Diseases and Conditions [formerly paragraph 2:003]

A. It is hereby made the duty of every physician practicing medicine in the state of Louisiana to report to the

state health officer, according to the requirements of this Section and utilizing the appropriate method(s) of reporting required under Subsection E of this Section, any case or suspected case of reportable disease or condition which he or she is attending, or has examined, or for which such physician has prescribed. The report shall be made promptly at the time the physician first visits, examines or prescribes for the patient, and such report shall state the name, age, sex, race, usual residence, place where the patient is to be found, the nature of the disease or condition and the date of onset, and the pregnancy status of the patient (if the pregnancy status is known and if it is clinically relevant to the disease or condition being reported). Reports of occupational disease/injury shall state contact information of the reporting person as well as the patient’s name, contact information, age (or date of birth), sex, race/ethnicity, usual residence, occupation, employer information, the nature of the disease or injury, and the date of diagnosis.

B. Any physician, whether Louisiana resident or non-resident, engaged in the practice of medicine at any federal installation or on any vessel, train or other common carrier, which enters any port, station or place in the state of Louisiana, is required to report as specified in Subsection A of this Section.

C. It shall be the duty of every osteopath, coroner, medical examiner, dentist, homeopath, infection control practitioner, laboratory director, medical records director, nurse, nurse midwife, nurse practitioner, pharmacist, physician assistant, podiatrist, poison control center, social worker, veterinarian, and any other health care professional to report a positive laboratory result or a confirmed or suspected case of any reportable disease or condition as required by this Section utilizing the appropriate method(s) of reporting required under Subsection E of this Section in which he or she has examined or evaluated, or for which he or she is attending or has knowledge. In the absence of a health care professional responsible for reporting as stated in the prior sentence (or a physician as referenced in Subsections A and B of this Section), it shall be the duty of the director, chief administrative officer, or other person in charge of any facility, program, or other entity that requires or conducts testing for reportable diseases or conditions, to report a positive laboratory result or a confirmed or suspected case of any reportable disease or condition as required by this Section utilizing the appropriate method(s) of reporting required under Subsection E of this Section.

D. The following diseases or conditions are hereby declared reportable with reporting requirements by class.

1. Class A Diseases or Conditions which Shall Require Reporting within 24 Hours

a. Class A diseases or conditions include diseases or conditions of major public health concern because of the severity of the disease or condition and the potential for epidemic spread. Class A diseases or conditions shall be reported to the Office of Public Health by telephone (or in another electronic format acceptable to the Office of Public Health) immediately upon recognition that a case, a

suspected case, or a positive laboratory result is known. In addition, all cases of rare or exotic communicable diseases, unexplained death, unusual clusters of disease and all outbreaks shall be reported. Any class A disease or condition, rare or exotic communicable disease, unexplained death, or unusual cluster of disease and any disease outbreak, shall be reported to the Office of Public Health as soon as possible but no later than 24 hours from recognition that a case, a suspected case, a positive laboratory result, an unexplained death, an unusual cluster of disease, or a disease outbreak is known. The following diseases or conditions shall be classified as class A for reporting requirements:

- i. *Acinetobacter* spp., carbapenem-resistant;
- ii. acute flaccid paralysis, including acute flaccid myelitis;
- iii. amoeba (free living) infection (including *Acanthamoeba*, *Naegleria*, *Balamuthia* and others);
- iv. anthrax;
- v. avian or novel strain influenza A (initial detection);
- vi. botulism;
- vii. brucellosis;
- viii. *Candida auris*, as well as common misidentifications of *C. auris* (e.g., *C. haemulonii*, *C. duobushaemulonii*, *C. famata*, *C. sake*, *C. lusitanae*, *C. parapsilosis*, *C. catenulata*, *C. guilliermondii*, and *Rhodotorula glutinis*);
- ix. cholera;
- x. *Clostridium perfringens* food-borne illness;
- xi. Coronavirus Disease 2019 (COVID-19)/Infections with SARS-CoV-2;
- xii. diphtheria;
- xiii. Enterobacteriaceae, carbapenem-resistant;
- xiv. fish or shellfish poisoning (domoic acid poisoning, neurotoxic shellfish poisoning, ciguatera, paralytic shellfish poisoning, scombroid);
- xv. food-borne illness;
- xvi. glanders (*Burkholderia mallei*);
- xvii. *Haemophilus influenzae* (invasive infection);
- xviii. influenza-associated mortality;
- xix. measles (rubeola, imported or indigenous);
- xx. melioidosis (*Burkholderia pseudomallei*);
- xxi. *Neisseria meningitidis* (invasive infection);
- xxii. outbreaks of any infectious diseases;
- xxiii. pertussis;
- xxiv. plague (*Yersinia pestis*);
- xxv. poliomyelitis (paralytic and non-paralytic);

- xxvi. *Pseudomonas aeruginosa*, carbapenem-resistant;
- xxvii. Q fever (*Coxiella burnettii*);
- xxviii. rabies (animal and human);
- xxiv. ricin poisoning;
- xxx. rubella (congenital syndrome);
- xxxi. rubella (German measles);
- xxxii. SARS (SARS-CoV-1 infection);
- xxxiii. *Staphylococcus aureus*, vancomycin intermediate or resistant (VISA.VRSA);
- xxxiv. staphylococcal enterotoxin B (SEB) pulmonary poisoning;
- xxxv. smallpox;
- xxxvi. tularemia (*Francisella tularensis*);
- xxxvii. viral hemorrhagic fever (Ebola, Lassa, Marburg, Crimean Congo, etc.); and
- xxxviii. yellow fever.

2. Class B Diseases or Conditions which Shall Require Reporting within One Business Day

a. Class B diseases or conditions include diseases or conditions of public health concern needing timely response because of potential for epidemic spread. The following class B diseases or conditions shall be reported to the Office of Public Health by the end of the next business day after the existence of a case, a suspected case, or a positive laboratory result is known:

- i. anaplasmosis;
- ii. arthropod-borne viral infections (including West Nile, Dengue, St. Louis, California, Eastern Equine, Western Equine, Chikungunya, Usutu, Zika, and others);
- iii. aseptic meningitis;
- iv. babesiosis;
- v. Chagas disease;
- vi. chancroid;
- vii. cryptosporidiosis;
- viii. cyclosporiasis;
- ix. *Escherichia coli*, Shiga-toxin producing (STEC), including *E. coli* O157:H7;
- x. granuloma inguinale;
- xi. hantavirus (infection or pulmonary syndrome);
- xii. hemolytic-uremic syndrome;
- xiii. hepatitis A (acute illness);
- xiv. hepatitis B (acute illness and carriage in pregnancy);
- xv. hepatitis B (perinatal infection);

PUBLIC HEALTH—SANITARY CODE

- xvi. hepatitis C (acute illness);
- xvii. hepatitis C (perinatal infection);
- xviii. hepatitis E;
- xix. herpes (neonatal);
- xx. human immunodeficiency virus [(HIV), infection in pregnancy]^{2,6};
- xxi. human immunodeficiency virus [(HIV), perinatal exposure]^{2,6};
- xxii. legionellosis;
- xxiii. listeriosis;
- xxiv. malaria;
- xxv. mumps;
- xxvi. salmonellosis
- xxvii. shigellosis;
- xxviii. syphilis¹
- xxix. syphilis [(*Treponema pallidum*), infection in pregnancy]^{1,6}
- xxx. syphilis [(*Treponema pallidum*), perinatal exposure]^{1,6};
- xxxi. tetanus;
- xxxii. tuberculosis³ due to *Mycobacterium tuberculosis*, *bovis* or *africanum*;
- xxxiii. typhoid fever;
- xxxiv. *Vibrio* infections (other than cholera); and
- xxxv. Zika virus-associated birth defects.

3. Class C Diseases or Conditions which Shall Require Reporting within Five Business Days

a. Class C diseases or conditions shall include diseases or conditions of significant public health concern. The following class C diseases or conditions shall be reported to the Office of Public Health within five business days after the existence of a case, suspected case, or a positive laboratory result is known:

- i. acquired immune deficiency syndrome (AIDS)²;
- ii. aspergillosis;
- iii. blastomycosis;
- iv. campylobacteriosis;
- v. chlamydial infection¹;
- vi. coccidioidomycosis;
- vii. cryptococcosis (*Cryptococcus neoformans* and *C. gattii*);
- viii. ehrlichiosis (human granulocytic, human monocytic, *Ehrlichia chaffeensis* and *ewingii*);

- ix. *Enterococcus*, vancomycin resistant [(VRE), invasive disease];
- x. giardiasis;
- xi. gonorrhea¹ (genital, oral, ophthalmic, pelvic inflammatory disease, rectal);
- xii. Guillain-Barré syndrome;
- xiii. Hansen's disease (leprosy);
- xiv. hepatitis C (infection, other than as in Class B)²;
- xv. histoplasmosis;
- xvi. human immunodeficiency virus [(HIV) infection, other than as in class B]²;
- xvii. human T lymphocyte virus (HTLV I and II) infection;
- xviii. leptospirosis;
- xix. Lyme disease;
- xx. lymphogranuloma venereum¹;
- xxi. meningitis, eosinophilic (including those due to *Angiostrongylus* infection);
- xxii. Nipah virus infection;
- xxiii. non-gonococcal urethritis;
- xxiv. nontuberculous mycobacteria;
- xxv. ophthalmia neonatorum;
- xxvi. psittacosis;
- xxvii. spotted fever rickettsioses [*Rickettsia* species including Rocky Mountain spotted fever (RMSF)];
- xxviii. staphylococcal toxic shock syndrome;
- xxix. *Staphylococcus aureus*, methicillin/oxacillin-resistant [(MRSA), invasive infection];
- xxx. streptococcal disease, group A (invasive disease);
- xxxi. streptococcal disease, group B (invasive disease);
- xxxii. streptococcal toxic shock syndrome;
- xxxiii. *Streptococcus pneumoniae* invasive disease;
- xxxiv. transmissible spongiform encephalopathies (Creutzfeldt-Jakob disease and variants);
- xxxv. trichinosis;
- xxxvi. varicella (chickenpox); and;
- xxxvii. yersiniosis.

4. Class D Special Reportable Diseases or Conditions Shall Require Reporting within Five Business Days

a. Class D diseases or conditions shall include diseases or conditions of significant public health concern.

The following class D diseases or conditions shall be reported to the Office of Public Health within five business days after the existence of a case, suspected case, or a positive laboratory result is known:

- i. cancer;
- ii. carbon monoxide exposure and/or poisoning⁵;
- iii. complications of abortion;
- iv. congenital hypothyroidism⁴;
- v. galactosemia;
- vi. heavy metal (arsenic, cadmium, mercury) exposure and/or poisoning (all ages)⁵;
- vii. hemophilia;
- viii. lead exposure and/or poisoning (all ages)⁵;
- ix. pesticide-related illness or injury (all ages)⁵;
- x. phenylketonuria⁴;
- xi. pneumoconiosis (asbestosis, berylliosis, silicosis, byssinosis, etc.)⁵;
- xii. radiation exposure, over normal limits⁵;
- xiii. Reye's syndrome;
- xiv. severe traumatic head injury;
- xv. severe undernutrition (severe anemia, failure to thrive);
- xvi. sickle-cell disease (newborns);
- xvii. spinal cord injury; and
- xviii. sudden infant death syndrome (SIDS).

5. Class E Reportable Occupational Diseases or Conditions Shall Require Reporting within 10 Business Days⁵

a. Class E diseases or conditions shall include any occupationally-related diseases or conditions of significant public health concern. This includes cases where the work environment is suspected to be the cause of an illness or injury or cases where the work environment is thought to be the cause of an illness exacerbation. Class E diseases or conditions shall be reported to the Office of Public Health, Section of Environmental Epidemiology and Toxicology, Occupational Health and Injury Surveillance Program, within 10 business days after existence of the case, suspected case, or positive test result is known.

E. Case reports not requiring special reporting instructions (see below) can be reported by mail or facsimile [(504) 568-8290 (fax)] on confidential disease report forms, or by phone [call (800) 256-2748 for forms and instructions] or in an electronic format acceptable to the Office of Public Health. When selecting a method of notification, the person or entity submitting a report shall be respectful of the time limitations for the report to be received by the Office of Public Health in accordance with the particular time limitations specified under classes A-D above.

1. ¹Report on STD-43 Form. Report cases of syphilis with active lesions by telephone, within one business day, to (504) 568-7474.

2. ²Report to the Louisiana STD/HIV Program. Visit www.hiv.dhh.louisiana.gov or call (504) 568-7474 for regional contact information.

3. ³Report on CDC72.5 (f.5.2431) card.

4. ⁴Report to the Louisiana Genetic Diseases Program and Louisiana Childhood Lead Poisoning Prevention Programs, www.genetics.dhh.louisiana.gov, or facsimile [(504) 568-8253 (fax)], or call (504) 568-8254 or (800) 242-3112.

5. ⁵Report to the Section of Environmental Epidemiology and Toxicology, Occupational Health and Injury Surveillance Program, www.seet.dhh.louisiana.gov or call (504) 568-8150, toll free at (888) 293-7020, or by fax at (504) 568-8149.

6. ⁶Report to the Louisiana STD/HIV Program on HIV/Syphilis during Pregnancy Reporting Form. Visit www.hiv.ldh.louisiana.gov or by phone at (504) 568-7474.

AUTHORITY NOTE: Promulgated in accordance with the provisions of R.S. 40:4(A)(2) and R.S. 40:5(2)(10)(11).

HISTORICAL NOTE: Promulgated by the Department of Health and Hospitals, Office of Public Health, LR 28:1212 (June 2002), amended LR 32:1050 (June 2006), LR 34:2173 (October 2008), repromulgated LR 34:2582 (December 2008), LR 36:1014 (May 2010), repromulgated LR 36:1253 (June 2010), amended LR 39:1053 (April 2013), LR 41:2653 (December 2015), amended by the Department of Health, Office of Public Health, amended LR 45:667 (May 2019), LR 47:51 (January 2021).

§107. Laboratory and Healthcare Facility Reporting Requirements (Formerly §113)

A. The director of every laboratory and the director of an applicable healthcare facility whether public, private, hospital or other, within or out of the state shall report to the state health officer the results of all tests that are in any way clinically relevant, suggestive or indicative of an individual having active disease, past or present exposure to, past or present contact with and/or past or present association with any of the disease/conditions listed in LAC 51 (Public Health—Sanitary Code), Part II, Chapter 1, §105. The results of the tests to be reported to the state health officer do not have to be conducted for diagnostic reasons, nor do the results have to be diagnostic or confirmatory. The report shall be received in a timely manner consistent with the requirements of the diseases/conditions by class for the diseases/conditions described in §105 of this Chapter and shall state the name, date of birth, sex, race, usual residence, pregnancy status of the individual (if the pregnancy status is known and if it is clinically relevant to the disease or condition being reported), specimen identification code/ID and test results of the tested individual as well as the name of the physician or person submitting the specimen. Contact information for the laboratory or an applicable healthcare facility performing the test(s) shall be provided. Laboratories or an applicable healthcare facility shall not defer their

public health reporting responsibilities to any other authorities within the institutions they serve. In addition, laboratories or an applicable healthcare facility performing tests on specimens received from other laboratories or an applicable healthcare facility shall report to the state health officer all results as prescribed above plus the contact information for the facility/laboratory or an applicable healthcare facility where the specimen originated. Moreover, no considerations, evaluations or concerns, regarding any test technology or test result by institutions and/or organizations whether federal, state or otherwise (e.g., FDA, CMS-CLIA, etc.) which may be overseeing, approving, evaluating or licensing laboratory testing, shall represent an *a priori* rationale for withholding laboratory reports from the state health officer.

B. All laboratory facilities shall, in addition to reporting tests indicative of conditions found in §105, report positive or suggestive results for additional conditions of public health interest. The following findings shall be reported as detected by laboratory facilities:

1. adenoviruses;
2. coronaviruses;
3. enteroviruses;
4. hepatitis B (carriage, other than in pregnancy);
5. hepatitis C (past or present infection), including genotype where available;
6. human metapneumovirus;
7. parainfluenza viruses;
8. respiratory syncytial virus; and
9. rhinoviruses.

C. A reference culture or culture-independent diagnostic test (CIDT) specimen is required to be sent to the Office of Public Health laboratory, or a specialized laboratory as indicated below, for the following microorganisms within five business days of the final identification of the microorganism:

1. *Acinetobacter* spp., pan-resistant; consult with the OPH's Infectious Disease Epidemiology for submission to the CDC's Antibiotic Resistance Laboratory Network (ARLN);
2. *Bacillus anthracis* (confirmed or suspected);
3. *Bordetella pertussis*;
4. *Brucella* spp.
5. *Burkholderia mallei*;
6. *Burkholderia pseudomallei*;
7. *Campylobacter* spp.;
8. *Candida auris* submitted to the CDC's ARLN; consult with the OPH's Infectious Disease Epidemiology for common misidentifications of *C. auris* (e.g., *C. haemulonii*, *C. duobushaemulonii*, *C. famata*, *C. sake*, *C. lusitaniae*, *C.*

parapsilosis, *C. catenulata*, *C. guilliermondii*, and *Rhodotorula glutinis*);

9. *Corynebacterium diphtheriae*;
10. *E. coli* O157:H7 or *E. coli* Shiga toxin producing;
11. Enterobacteriaceae, carbapenem-resistant (excluding *Klebsiella pneumoniae*, *K. oxytoca*, *E. coli*, and *Enterobacter* spp.); consult with OPH's Infectious Disease Epidemiology for submission to the CDC ARLN;
12. *Francisella* spp.;
13. *Klebsiella pneumoniae*, *K. oxytoca*, *E. coli*, and *Enterobacter* spp., carbapenem-resistant;
14. *Listeria* spp.;
15. *Mycobacterium tuberculosis*, *bovis* or *africanum*;
16. *Plesiomonas* spp.;
17. *Pseudomonas aeruginosa*, carbapenem-resistant;
18. *Salmonella* spp.;
19. *Shigella* spp.;
20. *Vibrio* spp.;
21. *Yersinia enterocolitica*; and
22. *Yersinia pestis*.

D. A reference culture or culture-independent diagnostic test (CIDT) specimen is required to be sent to the Office of Public Health laboratory for the following microorganisms if the original culture was from a sterile site (e.g., blood, spinal fluid, other internal fluid, tissue, etc.). Such reference culture shall be sent to the Office of Public Health laboratory within five business days of the final identification of the microorganism:

1. *Haemophilus influenzae* type b or untyped;
2. *Neisseria meningitidis*; and
3. *Streptococcus pneumoniae*.

E. Laboratory reports shall not be construed by the Office of Public Health as diagnosis. In the case of private patients, follow-up of laboratory reports shall be through the physician(s) submitting the specimen(s).

F. Electronic reporting by a laboratory/facility shall include any results, negative or positive, for all components of testing indicative of the following conditions:

1. Coronavirus Disease 2019 (COVID-19)/Infections with SARS-CoV-2;
2. hepatitis C virus;
3. human immunodeficiency virus (HIV), including nucleotide sequences; and
4. syphilis.

G. Laboratories and applicable healthcare facilities are encouraged to report results electronically using Health Level Seven (HL7)-compliant message structure and

appropriate standard Logical Observation Identifiers Names and Codes (LOINC) terminology designating the test(s) performed.

AUTHORITY NOTE: Promulgated in accordance with the provisions of R.S. 40:4(A)(2) and R.S. 40:5(2)(10)(11).

HISTORICAL NOTE: Promulgated by the Department of Health and Hospitals, Office of Public Health, LR 28:1214 (June 2002), amended LR 32:1052 (June 2006), LR 39:1054 (April 2013), LR 41:2655 (December 2015), amended by Department of Health, Office of Public Health, LR 45:669 (May 2019), LR 47:52 (January 2021).

§109. Reports by Emergency Departments (Formerly §105.A.5)

A. Syndromic Surveillance: Reportable Conditions seen at Emergency Departments of Acute Care Hospitals which Shall Require Reporting Electronically within One Business Day of the Visit

1. Emergency department reporting shall include all conditions seen at emergency departments of acute care hospitals. The text content of the chief complaint for the visit or an international classification of disease code shall be reported to the Office of Public Health within one business day of the visit by electronic means as specified by the Office of Public Health.

AUTHORITY NOTE: Promulgated in accordance with the provisions of R.S. 40:4(A)(2) and R.S. 40:5(2)(10)(11).

HISTORICAL NOTE: Promulgated by the Department of Health and Hospitals, Office of Public Health, LR 28:1213 (June 2002), amended LR 32:1051 (June 2006), LR 36:1015 (May 2010), LR 41:2656 (December 2015).

§111. Reports by Hospitals

A. It shall be the duty of all hospitals producing antibiograms detailing the antibiotic sensitivities and resistances of microorganisms in their facility to provide a report annually of antibiogram results to the state health officer.

AUTHORITY NOTE: Promulgated in accordance with the provisions of R.S. 40:4(A)(2) and R.S. 40:5(2)(10)(11).

HISTORICAL NOTE: Promulgated by the Department of Health and Hospitals, Office of Public Health, LR 41:2656 (December 2015).

§113. Reports Required of Parents, Schools and Day Care Centers (Formerly §111)

A. It shall be the duty of every parent, guardian, householder, attendant or other person in charge, principal of a public or private school, operator of a day care center or residential facility (public or private) to report a case of reportable disease in his household or school to the state health officer [as required by Subsection 105.C of this Chapter utilizing the appropriate method(s) of reporting required under Subsection 105.E of this Chapter], when he or she knows or reasonably believes that the disease is one which legally must be reported, except when he or she knows or reasonably believes that a physician, presumed to have already reported the case, is in attendance.

AUTHORITY NOTE: Promulgated in accordance with the provisions of R.S. 40:4(A)(2) and R.S. 40:5(2)(10)(11).

HISTORICAL NOTE: Promulgated by the Department of Health and Hospitals, Office of Public Health, LR 28:1213 (June 2002), amended LR 36:1015 (May 2010), LR 41:2656 (December 2015).

§115. Investigations [formerly paragraph 2:009]

A. The state health officer may immediately upon receiving notification of any communicable disease or reportable condition, investigate as the circumstances may require for the purpose of verification of the diagnosis, to ascertain the source of the causative agent, to disclose unreported cases and to reveal susceptible contacts if such information is required to prevent a serious health threat to the community. The decision of the state health officer as to the diagnosis shall be final, for administrative purposes.

B. [formerly paragraph 2:010] The state health officer is hereby empowered and it is made his or her duty whenever a case of communicable disease occurs, to obtain laboratory specimens of body tissues, fluids or discharges and of materials directly or indirectly associated with the case as may be necessary or desirable in confirmation of the diagnosis or for ascertaining the source of the infection, recency of onset, strain of organism, and/or medication resistance, when acceptable laboratory and medical reports are not available. Whenever laboratory tests are required for the release of cases or carriers or suspected cases or carriers, the state health officer shall be satisfied that a sufficient number of specimens are examined, that the specimens are authentic and are examined in an acceptable laboratory.

C. [formerly paragraph 2:013] No person shall interfere with or prevent the entrance to or examination of any house, building, trailer, camp, train, airplane, bus, steamship, or other water craft, or any abode, by the state health officer where a case of communicable disease is either suspected or reported to exist.

D. [formerly paragraph 2:009-1] The state health officer shall make a good faith effort to notify individuals who are spouses and/or sexual contacts to persons with Human Immunodeficiency Virus (HIV) infection of their exposure, offer them counseling about their risk of infection, and offer them testing for HIV infection. In performing this activity, the state health officer or his/her designee shall initially contact the primary medical provider of the person who has HIV infection, if such medical provider can be identified, and ask if the infected person or the medical provider intends to conduct this notification. If neither the infected person nor the medical provider intends to notify spouses or sexual partners of the exposure, the state health officer or his/her designee shall attempt to interview the infected person directly to identify these partners for counseling and testing. Notification of partners shall be conducted in such a manner as to maintain the confidentiality of the infected person.

AUTHORITY NOTE: Promulgated in accordance with the provisions of R.S. 40:4(A)(2) and R.S. 40:5(10).

HISTORICAL NOTE: Promulgated by the Department of Health and Hospitals, Office of Public Health, LR 28:1214 (June 2002), amended LR 32:1052 (June 2006), LR 36:1016 (May 2010).

§117. Disease Control Measures Including Isolation/Quarantine [formerly paragraph 2:011]

A. Individuals suspected of being cases or carriers of a communicable disease, or who have been exposed to a communicable disease, and who in the opinion of the state health officer may cause serious threat to public health, shall either submit to examination by a physician and to the collection of appropriate specimens as may be necessary or desirable in ascertaining the infectious status of the individual, or be placed in isolation or under quarantine as long as his or her status remains undetermined. Specimens collected in compliance with this Section shall be examined either by a state laboratory free of charge or by a laboratory approved by the state health officer at the individual's own expense.

B. [formerly paragraph 2:014] It shall be the duty of the state health officer or his or her duly authorized representative to promptly institute necessary control measures whenever a case of communicable disease occurs.

C. [formerly paragraph 2:015] The state health officer or his or her duly authorized representative is hereby empowered and it is made his or her duty, whenever a case of communicable disease occurs in any household or place, and it is in his or her opinion, necessary or advisable that persons residing therein shall be kept from contact with the public, to declare the house, building, apartment, room, or place where the case occurs, a place of quarantine, and to require that only persons so authorized by the state health officer shall leave or enter said quarantined place during the period of quarantine.

D. [formerly paragraph 2:016] Whenever a disease of international or interstate epidemic significance occurs in any community within or outside the state of Louisiana, the state health officer shall, if in his or her opinion, it is necessary, proclaim and institute a quarantine of the locality in which the said disease prevails and shall formulate and publish rules and regulations to carry out such quarantine effectively; which rules and regulations shall have the same force and authority as this code and shall remain in force until rescinded by proclamation of the state health officer.

E. [formerly paragraph 2:017] It is a violation of this code for any person to enter or leave any quarantined area in the state of Louisiana, or to enter from any quarantined area without the state of Louisiana except by permission of the state health officer.

F. [formerly paragraph 2:018] No person shall interfere with, conceal, mutilate or tear down any notices or placard placed on any house, building, or premises by the state health officer. Such placards shall be removed only on authority of the state health officer.

G. [formerly paragraph 2:019] Whenever in the judgment of the state health officer, it is necessary to protect

the public health against a serious health hazard, the state health officer may take complete charge of any case of communicable disease occurring therein and may carry on such measures to prevent its spread as he or she may believe necessary and as are provided for by this Code.

H. If expedited partner therapy is chosen as an alternative by the before mentioned physician, advanced practice registered nurse or physician assistant, the patient with a case of gonorrhea or chlamydia will be given a written document that the patient agrees to give to his or her sexual contact. The document will contain, but will not be limited to the following information.

1. The sexual contact should be examined and treated by a physician, advanced practice registered nurse or physician assistant, if at all possible.

2. The medicine or prescription for medicine given to the sexual contact by the patient should not be taken by the contact if the contact has a history of allergy to the antibiotic or to the pharmaceutical class of antibiotic in which case the sexual contact should be examined and treated by a physician, advanced practice registered nurse or physician assistant and offered another type of antibiotic treatment.

3. The medicine or prescription for medicine given to the sexual contact by the patient should not be taken by the contact if the contact is pregnant, in which case the sexual contact should be examined by a prenatal care health care provider.

4. Additionally, any pharmacist licensed to practice pharmacy in this state may recognize a prescription authorized by this section as valid, notwithstanding any other provision of law or administrative rule to the contrary.

AUTHORITY NOTE: Promulgated in accordance with the provisions of R.S. 40:4(A)(2) and R.S. 40:5.

HISTORICAL NOTE: Promulgated by the Department of Health and Hospitals, Office of Public Health, LR 28:1214 (June 2002), amended LR 35:249 (February 2009).

§119. Duty of Custodians of Medical Records [formerly paragraph 2:012]

A. Custodians of medical records on patients known or suspected of being cases or carriers of a communicable disease, shall make such records available for review by the state health officer.

AUTHORITY NOTE: Promulgated in accordance with the provisions of R.S. 40:4(A)(2) and R.S. 40:5(10).

HISTORICAL NOTE: Promulgated by the Department of Health and Hospitals, Office of Public Health, LR 28:1215 (June 2002).

§121. Special Tuberculosis Control Measures [formerly paragraph 2:014-1 and Appendix A]

A. Louisiana is changing its method of treating tuberculosis due to recent recommendations of the federal Centers for Disease Control and Prevention as set forth in its Morbidity and Mortality Weekly Report, Volume 42, Issue RR-7, dated May 21, 1993. These new and revised recommendations have become necessary because the majority of tuberculosis patients on daily self-administered

medications do not comply with a full course of therapy which leads to drug resistance and secondary spread of the disease.

B. This Section contains a step-wise approach for encouraging compliance with treatment and for managing the non-compliant patient. The steps in the process begin with a voluntary patient compliance agreement, meant to spell out the time and place of directly-observed therapy negotiated between the healthcare provider and the patient and to inform the patient of the possible consequences of non-compliance with the course of therapy.

C. If the patient does not comply with the terms of this agreement, a quarantine order for directly-observed therapy follows. This order from the state health officer or his designee reinforces the need for compliance with therapy.

D. If the patient continues to be uncooperative, the state health officer or his designee may issue a formal quarantine order for hospitalization. This assigns the patient to a specific hospital facility for care of tuberculosis as an inpatient, with detailed warning of the consequences of non-compliance with therapy. It is to be noted that the patient must agree to be transported to the selected hospital facility, and to further comply with the quarantine order to remain in the hospital until his/her condition improves, and the patient may be discharged and placed under a new quarantine order for continued directly observed therapy treatment, as needed, outside of the hospital facility's restrictive environment.

E. In certain cases, where the OPH disease intervention specialist and supervisor anticipate that a given uncooperative patient will refuse to be voluntarily transported to a hospital facility under a formal quarantine order for hospitalization, the state health officer may authorize and instruct the OPH disease intervention specialist supervisor or other appropriate OPH official, to fill out a request for a court order for hospitalization, and present it to the district attorney in the parish wherein the patient is known to be situated. (In rare instances, the district attorney may see that criminal charges for violation(s) of the quarantine order for directly observed therapy are filed at this point, instead of the OPH requested civil court order).

F. It is hoped that in most instances of initial non-compliance with the required treatment, an uncooperative patient will agree to be transported to a specific hospital facility for inpatient care under a formal quarantine order issued by the state health officer or his designee, without court intervention.

G. In the event a patient under a formal quarantine order for hospital care becomes uncooperative within the hospital facility's restrictive environment, or a patient continues to be non-compliant with therapy after isolation/quarantine by a civil court order, the hospital facility or state health officer may seek to have criminal charges filed pursuant to R.S. 40:6.B, and upon conviction, the patient may be sentenced to the hospital unit of a state prison and placed in the custody of the Department of Corrections.

H. This Section contains suggested forms with instructions for the steps prior to the filing of criminal charges.

I. Louisiana is following the recommendations of the federal Centers for Disease Control and Prevention by placing all tuberculosis patients initially under a voluntary program of "Directly Observed Therapy" pursuant to a "Patient Compliance Agreement" signed by the patient. A sample "Patient Compliance Agreement" form follows:

J. Tuberculosis Control Sample Form 1

VOLUNTARY PATIENT COMPLIANCE AGREEMENT

Plan of therapy for _____
Full Name

Date of birth _____ Social Security # _____

Whose residence is _____

Parish _____ Date this regimen begins _____

For the Patient: NOTE: All statements are to be read to patient
(or patient may read).

1. You are being treated for suspected tuberculosis; therefore, it is essential that you take your medication.
2. To avoid long-term isolation or quarantine, you will be expected to follow your drug therapy schedule. No dose of medication is to be missed.
3. State law requires that the Office of Public Health assist you in controlling your disease. The only way to cure your disease is by regular use of drug therapy.
4. The following therapy schedule requires that you report to _____ on _____, at _____ o'clock to receive your medications under supervision. The staff will work with you in arranging special schedules for your therapy as necessary. You will be expected to call and report any difficulties in keeping your appointments.
5. Failure to comply with these guidelines may result in quarantine, involuntary confinement to a hospital or possible criminal charges for violations of quarantine.

(If patient states any barriers to compliance, list them here.)

I agree that I understand the above therapy schedule and will make every effort to comply with the full course of my therapy.

Patient's Signature _____

Date _____
Public Health Nurse or Disease Inter. Spec.

Copy received by patient _____
Patient Initials

SCHEDULE CHANGES

New schedule _____

Medical Reason/Other _____

Patient Signature _____ Date _____

Signature Public Health Nurse or Disease Intervention Specialist

Copy to patient _____
Patient Initials

K. In the event a particular tuberculosis patient fails to cooperate, as evidenced (for example) by failing to voluntarily appear timely at the place that was agreed upon in the patient compliance agreement to take the required drugs, or otherwise interrupts and/or stops taking the anti-tuberculosis medication as prescribed, it may become

PUBLIC HEALTH—SANITARY CODE

necessary to issue a formal public health isolation or quarantine order to "Directly Observed Therapy" (DOT) means drugs taken in the presence of a designated health care provider at a specified place. In such cases, the patient is fully informed that a violation of the terms of the isolation or quarantine order to DOT may result in orders issued by the state health officer or his designee or agent, or by an order from a Louisiana court of competent jurisdiction, to a more restrictive environment for the management of uncooperative tuberculosis patients. A sample of a public health isolation or quarantine order to DOT follows:

L. TB Control Form 2 is a sample letter to hand deliver a quarantine order for directly observed therapy.

Date _____

_____, LA 70 __

RE: Quarantine Order for Directly Observed Therapy

Dear _____:

This is to inform you that you are under quarantine to prevent the spread of your tuberculosis infection. The circumstances necessitating the specific terms of your quarantine are as follows:

- 1. You have been diagnosed as having active pulmonary tuberculosis, which could be spread to others when you cough.
2. You were diagnosed with pulmonary tuberculosis in _____, and had a positive sputum smear and culture for M. tuberculosis, which showed sensitivity to _____.
3. You have failed voluntary Directly Observed Therapy, as evidenced by _____.

In order to protect the public from further unwarranted exposure to your infection, you are required to fully comply with these terms of your quarantine:

- 1. You will be placed on mandatory Directly Observed Therapy by the regional chest clinician in _____. This regimen will require medications administered at the _____ Parish Health Unit. This therapy will continue until the state health officer determines that you are no longer likely to transmit your infection to others and have completed an adequate therapy regimen.
2. You will comply and cooperate fully with the treatment regimen prescribed for you.
3. Failure to comply with mandatory Directly Observed Therapy on an outpatient basis may require subsequent legal action. Failure for the purposes of this quarantine is defined as missing one or more doses of therapy during one month. This order will remain in force until the order is revoked or revised by the authority of the state health officer.

In view of the risk to the public health which would result from failure to keep your tuberculosis infection under control, any violation of the specified terms of your quarantine may force us to bring immediate action against you in court.

Please signify your intention to comply with the terms of this order by signing the Statement of Intention which is attached. Return the statement to me through the officer who delivers it to you.

I sincerely hope that you will have a rapid and uneventful recovery and that your tuberculosis can be classed as inactive before very long.

_____, M.D.
State Health Officer

M. Tuberculosis Control Form 3 is an attachment to Form 2 to be hand delivered to the patient.

STATEMENT OF INTENTION TO COMPLY

I, _____, have read the terms of my quarantine for control of tuberculosis, or have had them read to me. I have had a chance to ask questions about the terms of my quarantine and am satisfied that I understand them. For my own protection and the protection of the public, I agree to comply fully with the specified terms of my quarantine.

(Signature) Date
WITNESSES: (Signature) (Signature)
(Print Name) (Print Name)

cc:
State Health Officer

EXECUTIVE OFFICER, ADMINISTRATION
DHH OFFICE OF PUBLIC HEALTH
TUBERCULOSIS CONTROL SECTION
DHH OFFICE OF PUBLIC HEALTH
BUREAU OF LEGAL SERVICES
DEPARTMENT OF HEALTH AND HOSPITALS
REGION __DIS SUPERVISOR 1
DHH OFFICE OF PUBLIC HEALTH
_____ PARISH HEALTH UNIT
DISTRICT ATTORNEY _____ PARISH
SHERIFF, _____ PARISH

N. A tuberculosis patient with a diagnosis of active tuberculosis who fails to comply with a public health isolation or quarantine order to directly observed therapy may be ordered to a more restrictive environment for the management of uncooperative tuberculosis patients, or by requesting a Louisiana court of competent jurisdiction for the issuance of an order placing the patient in a more restrictive environment. A sample of the state health officer's isolation or quarantine order to a more restrictive environment follows, along with a sample request for a court order.

O. TB Control Form 4 is a sample quarantine order (by the state health officer) for hospitalization

SAMPLE QUARANTINE ORDER FOR HOSPITALIZATION

Date _____

_____, LA 70 __

RE: Quarantine Order for Directly Observed Therapy

Dear _____:

This is to inform you that you are under quarantine to prevent the spread of your tuberculosis infection. The circumstances necessitating the specific terms of your quarantine are as follows:

- 1. You have been diagnosed as having active pulmonary tuberculosis, which could be spread to others when you cough.
2. You were diagnosed with pulmonary tuberculosis on _____, and had a positive sputum smear and culture for M. tuberculosis, which showed resistance to _____.
3. You failed to comply with your prescribed therapy and failed mandatory Directly Observed Therapy under quarantine, as evidenced by _____.

In order to protect the public from further unwarranted exposure to your infection, you are required to fully comply with these terms of your quarantine for hospitalization:

1. You have been placed on treatment for tuberculosis and will remain hospitalized with subsequent transfer to Villa Feliciana Chronic Disease Hospital and Rehabilitation Center.
2. You will comply and cooperate fully with the treatment regimen prescribed for you.
3. Failure to comply with this order for you to remain hospitalized may result in CRIMINAL CHARGES filed against you and a warrant for your arrest. The CRIMINAL CHARGE would be a violation of your Tuberculosis Quarantine Order, R.S. 40:6.B. Upon trial, if convicted of this charge, you may be sentenced to the hospital unit of a state prison operated by the Department of Corrections. Please be guided accordingly.

This formal quarantine order will remain in force until the order is revoked or revised by the state health officer.

In view of the risk to the public health which would result from failure to keep your tuberculosis infection under control, any violation of the specified terms of your quarantine will force us to bring immediate action against you in court.

Please signify your intention to comply with terms of this order by signing the Statement of Intention which is attached. Return the Statement to me through the officer who delivers it to you.

I sincerely hope that you will have a rapid and uneventful recovery and that your tuberculosis can be classed as inactive before very long.

_____, M.D.
State Health Officer

P. TB Control Form 5 is a statement of intention to comply with the state health officer's quarantine order for hospitalization.

STATEMENT OF INTENTION TO COMPLY

I, _____, have read the terms of my quarantine for control of tuberculosis, or have had them read to me. I have had a chance to ask questions about the terms of my quarantine and am satisfied that I understand them. For my own protection and the protection of the public, I agree to comply fully with the specified terms of my quarantine. I also expressly understand that if I violate the terms of this quarantine order, I may be charged with a CRIME and can be SENTENCED TO PRISON.
(Signature) (Date)

(Signature) Date

WITNESSES: _____
(Signature) (Signature)

(Print Name) (Print Name)

cc:
state health officer

EXECUTIVE OFFICER, ADMINISTRATION
DHH OFFICE OF PUBLIC HEALTH

TUBERCULOSIS CONTROL SECTION
DHH OFFICE OF PUBLIC HEALTH

BUREAU OF LEGAL SERVICES
DEPARTMENT OF HEALTH AND HOSPITALS

REGION II DIS SUPERVISOR
DHH OFFICE OF PUBLIC HEALTH
DISTRICT ATTORNEY _____ PARISH

SHERIFF, _____ PARISH

L S U UNIT, EARL K. LONG HOSPITAL

_____ PARISH HEALTH UNIT

Q. The following "format" may be used by the district attorney when the state health officer or his designee or agent requests help in handling an uncooperative person known to have active, infectious tuberculosis. The district attorney may substitute any "format" of his/her preference, however. The general intent here is to provide the OPH disease intervention specialist supervisors (who will be the state health officer's designee in most cases) with an instrument to complete and submit to the district attorney when a particular TB patient shows no intent to cooperate. The "format" of the instrument itself may have to be altered so as to present the facts of a particular case accurately.

R. Tuberculosis Control Form 6

SAMPLE REQUEST FOR A COURT ORDER FOR HOSPITALIZATION

IN RE: 1 _____
NO. 2 _____
_____ 3 JUDICIAL DISTRICT COURT PARISH OF _____ 4
FILED: _____ 5 _____ 6

DEPUTY

REQUEST FOR AN EMERGENCY PUBLIC HEALTH ORDER TO ISOLATE/QUARANTINE A TUBERCULOSIS PATIENT TO PROTECT THE PUBLIC HEALTH AND THE PATIENT

ON THE MOTION OF _____, 7

a Disease Intervention Specialist Supervisor employed by the Office of Public Health of the Department of Health and Hospitals of the State of Louisiana and duly designated to act in these premises by the state health officer, appearing herein through the undersigned Assistant District Attorney, and moves pursuant to the provisions of LSA-R.S. 40:3, 40:4A(13), 40:4B(4), 40:5(1), 40:6.C and 40:17, and further pursuant to Sections 117- 119.F of Chapter 1 of Part II of the state sanitary code, and respectfully suggests to the Court that:

I. _____, 1 to the best of my knowledge and belief is an imminent danger and/or threat to the health and/or lives of individuals in this parish and state and is now in need of immediate medical examination and treatment in a restricted environment in order to protect the individuals of this parish and state as well as the subject individual person from physical harm and/or from spreading active and infectious tuberculosis.

II. _____ 1 is known to be located at _____, 8 and has been encouraged to voluntarily submit to necessary medical examination and to seek and receive necessary treatment, but is unwilling and uncooperative in these regards.

III. Mover has contacted _____, 9 concerning the danger and/or imminent threat posed by the subject individual, _____ 1, and is informed that _____ 9 is prepared to receive the patient and provide housing in a restrictive environment allowing immediate examination and care for tuberculosis and the said facility is further prepared to provide any necessary anti-tuberculosis medication.

IV. Mover asserts that the imminent danger and/or threat to the public health is based on mover's knowledge that _____ 1 is infected with active, infectious tuberculosis as evidenced by _____

PUBLIC HEALTH—SANITARY CODE

_____, 10
WHEREFORE, mover prays that an emergency public health order be issued to locate, detain and transport _____ 1 to _____ 9 without delay.

Respectfully submitted,
_____, 16
Assistant District Attorney
_____, 3 Judicial District

S. TB Control Form 6 (continued)

AFFIDAVIT

STATE OF LOUISIANA
PARISH OF _____ 4

BEFORE ME, the undersigned authority, personally came and appeared _____, 7 who, being first duly sworn, deposed: That _____ 11 is the Disease Intervention Specialist Supervisor employed by the Office of Public Health of the Department of Health and Hospitals in the regional area including _____, 4 and _____ 11 is the mover in the above and foregoing motion, and that all of the allegations of fact made therein are true and correct to the best of mover's knowledge, information and belief.

_____, 12

SWORN TO AND SUBSCRIBED BEFORE ME
THIS _____ 13 DAY OF _____, 14 20____, 15
_____, 16

NOTARY PUBLIC

T. TB Control Form 6 (continued)

ORDER

IT IS ORDERED, ADJUDGED AND DECREED that _____ 1 be detained and placed in the protective custody of a law enforcement officer and transported to the 9 for such medical examinations, testing and treatment for active and infectious tuberculosis and be detained at that facility until the existing imminent danger and/or threat to the public health has subsided.

IT IS FURTHER ORDERED that any law enforcement officer may execute this order by detaining and transporting _____ 1 to the designated treatment facility named above without delay.

JUDGEMENT read, rendered and signed this _____ day of , 20____ , at _____ o'clock , at , Louisiana.

JUDGE

JUDICIAL DISTRICT COURT
PARISH OF _____

U. TB Control Form 6 Instructions

SUBSTITUTE FOR NUMBERS IN ABOVE FORM

1. Name of the person in need of treatment.
2. Court personnel will complete this item.
3. District Attorney's office will complete this item.
4. District Attorney's office will complete this item.
5. Court personnel will complete this item.
6. Court personnel will complete this item.
7. Insert the name of the Disease Intervention Specialist Supervisor who is submitting the matter to the District Attorney's office.
8. Insert the person in need of treatment's complete address (which may be in care of a relative's address, or even a "halfway house" or possibly the person may be a patient in a hospital refusing treatment and demanding discharge. Just try to insert sufficient information to enable the deputy

sheriff or other law enforcement officer to find and take the party into protective custody, etc.)

9. Insert the name of the physician or administrator and the name and address of the designated TB treatment facility.

10. Here it will be necessary for a concise statement of the problem presented by the TB patient whose condition is diagnosed as active and infectious TB.

11. Insert "he" or "she."

12. The Disease Intervention Specialist Supervisor must sign his or her name exactly as it appears in the form above, and this should be done in the presence of a Notary, who may also be the Assistant District Attorney who will handle the case in court.

13-16 will be completed by the District Attorney's office.

V. A tuberculosis patient who has been ordered to be isolated or quarantined to a more restrictive environment than directly observed therapy and who fails to comply with the express terms and provisions of the isolation/quarantine order to a more restrictive environment issued by the state health officer or his designee, or by the orders of a Louisiana court of competent jurisdiction, shall be considered as having violated the provisions of the state sanitary code and be subject to criminal prosecution pursuant to R.S. 40:6.B, and if so charged and convicted, further subject to being sentenced to the hospital unit of a state prison operated by the Department of Corrections, and to remain so confined so long as the prisoner's tuberculosis condition is active, in order to assure the public is protected from unwarranted exposure to the disease.

AUTHORITY NOTE: Promulgated in accordance with the provisions of R.S. 40:4(A)(2)(c)(vii)(aa)-(cc), R.S. 40:5(1) and R.S. 40:1161.

HISTORICAL NOTE: Promulgated by the Department of Health and Hospitals, Office of Public Health, LR 28:1215 (June 2002).

§123. Ventilation Requirements for Housing TB Patients in Hospitals and Nursing Homes [formerly paragraph 2:014-2]

A. Persons with tuberculosis in a communicable state or suspected of having tuberculosis in a communicable state who are cared for in hospitals and nursing homes shall be cared for in rooms with negative air pressure and either:

1. at least six changes of room air per hour accomplished by exhaust ventilation; or
2. equivalent circulation and treatment by ultraviolet light treatment, "air scrubber," or equivalent. If the patient is not in a room with proper ventilation and is unable or unwilling to cover his/her cough, then exposed persons shall wear proper masks, which filter all particles larger than one micron, in order to prevent the spread of infectious respiratory droplets.

B. [formerly paragraph 2:014-3] Rooms used for aerosolized pentamidine treatments or for aerosol treatments designed to induce sputum shall have negative air pressure and at least six changes of room air per hour accomplished by exhaust ventilation.

AUTHORITY NOTE: Promulgated in accordance with the provisions of R.S. 40:4(A)(2)(c)(ii),(iii) and R.S. 40:5.

HISTORICAL NOTE: Promulgated by the Department of Health and Hospitals, Office of Public Health, LR 28:1219 (June 2002).

Chapter 3. Testing of Newborn Infants

§301. Measures to Prevent Ophthalmia Neonatorum at Time of Birth of an Infant [formerly paragraph 2:020]

A. It shall be the duty of the attending physician, midwife, nurse or other person in attendance on a parturient person to use prophylactic measures at the time of delivery to prevent ophthalmia neonatorum, such as the instillation into both eyes of the newborn a 1 percent solution of nitrate of silver, a 1/2 percent erythromycin ophthalmic ointment or drops, a 1 percent tetracycline ophthalmic ointment or drops, all in single dose or single use containers, or an equally efficient agent, as determined by the state health officer. This duty is waived if the newborn has no evidence of ophthalmia neonatorum and the mother of the newborn states in writing that she objects to the application of such prophylactic agent on religious ground.

AUTHORITY NOTE: Promulgated in accordance with the provisions of R.S. 40:4(A)(2), R.S. 40:5 and R.S. 40:1102-1106.

HISTORICAL NOTE: Promulgated by the Department of Health and Hospitals, Office of Public Health, LR 28:1219 (June 2002).

Chapter 5. Health Examinations for Employees, Volunteers and Patients at Certain Medical Facilities

§501. Employee Health [formerly paragraph 2:021]

A. The requirements of Part I, Chapter 1, §117 shall be met.

AUTHORITY NOTE: Promulgated in accordance with the provisions of R.S. 40:4, and R.S. 40:5.

HISTORICAL NOTE: Promulgated by the Department of Health and Hospitals, Office of Public Health, LR 28:1219 (June 2002).

§503. Mandatory Tuberculosis Testing

A. [formerly paragraph 2:022] All persons, including employees, students or volunteers, having no history of latent tuberculosis infection or tuberculosis disease, prior to or at the time of employment, beginning clinical rotations in the healthcare profession, or volunteering at any hospital or nursing home (as defined in Parts XIX and XX of the Sanitary Code, respectively, herein, and including intermediate care facilities for the developmentally disabled) requiring licensing by the Louisiana Department of Health or at any Louisiana Department of Health, Office of Public Health (LDH-OPH) parish health unit or an LDH-OPH out-patient health care facility, whose duties include direct patient care, shall be free of tuberculosis in a communicable state as evidenced by either:

1. a negative purified protein derivative skin test for tuberculosis, 5 tuberculin unit strength, given by the Mantoux method or a blood assay for *Mycobacterium*

tuberculosis approved by the United States Food and Drug Administration;

2. a normal chest X-ray, if the skin test or a blood assay for *Mycobacterium tuberculosis* approved by the United States Food and Drug Administration is positive; or

3. a statement from a licensed physician certifying that the individual is non-infectious if the X-ray is other than normal. The individual shall not be denied access to work solely on the basis of being infected with tuberculosis, provided the infection is not communicable.

B. [formerly paragraph 2:023] Any employee, student or volunteer at any medical or 24-hour residential facility requiring licensing by the Louisiana Department of Health or at any LDH-OPH parish health unit or an LDH-OPH out-patient health care facility who has a positive purified protein derivative skin test for tuberculosis, 5 tuberculin unit strength, given by the Mantoux method, or a positive blood assay for *Mycobacterium tuberculosis* approved by the United States Food and Drug Administration; or a chest X-ray other than normal, in order to remain employed, remain in clinical rotations, or continue work as a volunteer, shall complete an adequate course of medical treatment for tuberculosis as prescribed by a Louisiana licensed physician, or shall present a signed statement from a Louisiana licensed physician stating that medical treatment for tuberculosis is not indicated.

C. [formerly paragraph 2:024] All persons with a history of latent tuberculosis infection or tuberculosis disease prior to or at the time of employment, including employment as a student in clinical rotations, or volunteering at any medical or 24-hour residential facility requiring licensing by the LDH, at any hospital or nursing home (as defined in Parts XIX and XX of the Sanitary Code, respectively, herein, and including intermediate care facilities for the developmentally disabled) requiring licensing by the LDH, at any LDH-OPH parish health unit, or at any LDH-OPH out-patient health care facility, whose duties include direct patient care, must present a statement from a Louisiana licensed physician that he or she has been satisfactorily treated for tuberculosis and is non-infectious or, for persons with a history of untreated latent tuberculosis infection, a statement that he or she is non-infectious.

1. Further, for persons with a history of untreated latent tuberculosis infection an annual symptom screen shall be done, including, but not limited to, the following questions.

a. Do you have a productive cough that has lasted at least 3 weeks? (Yes or No)

b. Are you coughing up blood (hemoptysis)? (Yes or No)

c. Have you had unexplained weight loss recently? (Yes or No)

d. Have you had fever, chills, or night sweats for 3 or more days? (Yes or No)

2. Any employee, student, or volunteer with a history of untreated latent tuberculosis infection giving a positive response to any one of the questions under Paragraph 1 of this Subsection shall be referred to a physician for medical evaluation as soon as possible.

3. All initial screening test results and all follow-up screening test results shall be kept in each employee's, student's, or volunteer's health record or facility's personnel record.

D. Annually, but no sooner than 6 months since last receiving tuberculosis educational information (more fully described at the end of this sentence) or symptom screening, all employees, students in the healthcare professions, or volunteers at any medical or 24-hour residential facility requiring licensing by LDH or at any hospital or nursing home (as defined in Parts XIX and XX of the Sanitary Code, respectively, herein, and including intermediate care facilities for the developmentally disabled) requiring licensing by the LDH or at any LDH-OPH parish health unit or and LDH-OPH out-patient health care facility shall receive, at a minimum, educational information explaining the health concerns, signs, symptoms, and risks of tuberculosis.

E. [formerly paragraph 2:033] All persons with acquired immunodeficiency syndrome (AIDS) or known to be infected with the human immunodeficiency virus (HIV), in the process of receiving medical treatment related to such condition, shall be screened for tuberculosis, with screening to include a chest X-ray. Sputum smear and culture shall be done if the chest X-ray is abnormal or if the patient exhibits symptoms of tuberculosis disease. Screening for tuberculosis shall be repeated as medically indicated.

AUTHORITY NOTE: Promulgated in accordance with the provisions of R.S. 40:4(A)(2) and R.S. 40:5.

HISTORICAL NOTE: Promulgated by the Department of Health and Hospitals, Office of Public Health, LR 28:1220 (June 2002), amended LR 32:98 (January 2006), LR 33:93 (January 2007), LR 37:598 (February 2011), LR 40:1942 (October 2014), amended by the Department of Health, Office of Public Health, LR 47:744 (June 2021).

§505. Required Medical Examinations of All Persons Admitted to Nursing Homes and Residential Facilities [formerly paragraph 2:026]

A. Any person (adult or child) admitted to any nursing home or other residential facility shall have a complete history and physical examination, including symptoms and signs of pulmonary tuberculosis, by a licensed physician within 30 days prior to or up to 72 hours after admission, except that any resident/patient who has complied with this provision shall be exempt from re-examination if transferred to another residential facility provided the record of examination is transferred to the new facility. This examination shall include laboratory tests as indicated by the history and physical examination. A United States Food and Drug Administration approved screening test for tuberculosis, *i.e.*, a purified protein derivative skin test for tuberculosis, 5 tuberculin unit strength, given by the

Mantoux method or a blood assay for *Mycobacterium tuberculosis* shall be given to all residents/patients. A chest X-ray shall be given to all residents/patients whose screening test for tuberculosis is positive, or who have signs and/or symptoms of tuberculosis no more than 30 days prior to admission to any nursing home or other residential facility. If the skin test or a blood assay for *Mycobacterium tuberculosis* is not done prior to admission, it may be done within 72 hours after admission and interpreted at the appropriate time. A repeat skin test or a blood assay for *Mycobacterium tuberculosis* is not required if the resident/patient has a chest X-ray with no abnormalities indicative of tuberculosis and has had a negative skin test or a blood assay for *Mycobacterium tuberculosis* approved by the United States Food and Drug Administration, documented within 1 year of admission or if the resident/patient has a previously documented positive skin test or a positive result of a blood assay for *Mycobacterium tuberculosis* and had a chest X-ray with no abnormalities indicative of tuberculosis. A record of the admission history, physical examination, purified protein derivative skin test for tuberculosis, 5 tuberculin unit strength, given by the Mantoux method, or a blood assay for *Mycobacterium tuberculosis* approved by the United States Food and Drug Administration, chest X-ray, and any other laboratory tests shall be a part of the permanent record of each resident/patient. No resident/patient with evidence of active tuberculosis shall be admitted unless the examining physician states that the resident/patient is on an effective drug regimen, is responding to treatment, and presents no imminent danger to other residents/patients or employees, or unless the facility has been specifically approved by the LDH-OPH to house residents/patients with active tuberculosis. The approval by the LDH-OPH will include the provision that the nursing home or residential facility has a designated isolation (negative pressure) room.

B. [formerly paragraph 2:026-1] Any resident/patient who is a case or an asymptomatic carrier of a communicable disease which may pose a serious risk to other residents/patients or employees shall not be admitted except under the supervision of the state health officer or his agent.

C. [formerly paragraph 2:027] When a suspicious case or carrier of a communicable disease poses a serious public health risk, appropriate measures shall be taken to prevent the disease from spreading to other residents/patients.

D. [formerly paragraph 2:028] Any child under 18 years of age in any residential facility in the state shall have an annual examination by a licensed physician to determine the child's physical condition, mental condition and the presence of any indication of hereditary or other constitutional disease. Any deformity or abnormal condition found upon examination shall be entered by the physician on the medical record of the child.

AUTHORITY NOTE: Promulgated in accordance with the provisions of R.S. 40:4(A)(2) and R.S. 40:5.

HISTORICAL NOTE: Promulgated by the Department of Health and Hospitals, Office of Public Health, LR 28:1220 (June 2002), amended LR 33:94 (January 2007), LR 38:2928 (November

2012), amended by the Department of Health, Office of Public Health, LR 47:744 (June 2021).

Chapter 7. Public Health Immunization Requirements

§701. Immunization Schedule [formerly paragraph 2:025]

A. The Office of Public Health (OPH) will determine the Louisiana immunization schedule, with appropriate immunizations for age using the current immunization schedule from the Advisory Committee for Immunization Practice (ACIP) of the United States Public Health Service (USPHS). Compliance for school and day care center entry will be based on the individual having received an appropriate number of immunizations for his/her age of the following types:

1. vaccines which contain tetanus and diphtheria toxoids, including Diphtheria and Tetanus (DT), Diphtheria/Tetanus/Acellular Pertussis (DTaP), Tetanus and Diphtheria (Tdap), Tetanus Toxoid (TT) or combinations which include these components;
2. polio vaccine, including Inactivated Polio Vaccine (IPV), or combinations which include this component;
3. vaccines which contain measles antigen, including Measles, Mumps, and Rubella (MMR) and combinations which include these components;
4. vaccines which contain hepatitis antigen, including Hepatitis B (HepB), Hepatitis A (HepA), and combinations which include these components;
5. vaccines which contain varicella antigen, including varicella and combinations which include this component.
6. vaccines which contain meningococcal antigen and combinations which include this component.

B. A one-month period will be allowed from the time the immunization is due until it is considered overdue. Medical, religious, and philosophic exemptions will be allowed for compliance with regulations concerning day care attendees and school enterers. Only medical and religious exemptions will be allowed for compliance with regulations concerning public assistance recipients. A copy of the current Office of Public Health immunization schedule can be obtained by writing to the Immunization Program, Office of Public Health, 1450 Poydras Street, Suite 1938, New Orleans, LA 70112 or by telephone (504)568-2600.

C. [formerly paragraph 2:025-1] Any person 18 years or under, admitted to any elementary and secondary school, kindergarten, college, university, proprietary school, vocational school, licensed day care center or residential facility shall have verification that the person has had all appropriate immunizations for age of the person according to the Louisiana immunization schedule unless presenting a written statement from a physician stating that the procedure is contraindicated for medical reasons, or a written dissent from parents. The operator of any elementary and secondary school, kindergarten, college, university, proprietary school,

licensed day care center or residential facility shall report to the state health officer through the health unit of the parish or municipality where such facility is located any case or suspected case of reportable disease. Health records, including immunization records, shall be made available during normal operating hours for inspection when requested by the state health officer. When an outbreak of a communicable disease occurs in an elementary and secondary school, kindergarten, college, university, proprietary school, vocational school, licensed day care center or residential facility, the operator of said facility shall comply with outbreak control procedures as directed by the state health officer.

D. [formerly paragraph 2:025-2] On or before October 1 of each year, the operator of each elementary and secondary school, kindergarten, college, university, proprietary school, vocational school, licensed day care center or residential facility enrolling or housing any person 18 years or under, inclusive but not limited to these listed facilities shall submit a preliminary immunization status report of all persons 18 years or under enrolled or housed as of that date. This compliance report shall be submitted utilizing the official Louisiana Immunization Network (“LINKS”) and shall include identifying information for each person 18 years or under, and for each dose of vaccine received since birth. Any person 18 years or under exempt from the immunization requirement shall also be identified, and the reason for exemption given on the report. After review of the report(s) by the state health officer or his or her designee, the elementary and secondary school, kindergarten, college, university, proprietary school, vocational school, licensed day care center or residential facility operator shall notify, on or before December 31 of each year, the parent or guardian of all enrolled or housed persons 18 years or under who are not compliant of the immunization requirements of §701.A and C of this Part.

AUTHORITY NOTE: Promulgated in accordance with the provisions of R.S. 40:4(A)(2), R.S. 40:5(A) and R.S. 40:31.15. Also see R.S. 17:170, R.S. 22:1030, and R.S. 44:17.

HISTORICAL NOTE: Promulgated by the Department of Health and Hospitals, Office of Public Health, LR 28:1221 (June 2002), amended LR 38:1252 (May 2012), amended by the Department of Health, Office of Public Health, LR 45:670 (May 2019), amended LR 46:590 (April 2020), amended by the Department of Health, Office of Public Health, LR 47:1877 (December 2021), LR 48:2295 (September 2022).

§703. Mandatory Immunization Reporting

A. All immunization providers in the state of Louisiana shall be licensed or credentialed by their respective boards (to administer vaccines) and shall register and enroll in the Louisiana Immunization Network (“LINKS”).

B. All licensed or credentialed immunization providers shall comply with the rules and regulations outlined in the LINKS site enrollment agreement.

C. All licensed and credentialed immunization providers in Louisiana shall report all immunizations administered, regardless of patient age, and update patient demographics at

each patient encounter to LINKS within one week of vaccine administration to the patient.

D. Boards that license healthcare providers authorized to administer vaccines shall provide an updated listing of all such authorized providers every calendar year to the OPH's immunization program. The updated listings shall be received by the OPH's immunization program no later than January 31 annually.

E. All providers licensed/credentialed to administered vaccines shall report all specified immunizations, antivirals, and other medications administered for all ages (within seven days of administration) to the LINKS system in preparation for or in response to a declared public health disaster or emergency event.

F. When reporting to the LINKS system, several pieces of information will be needed including; site and individual user demographic information; and consent to privacy and confidentiality compliance.

G. All of the information reported under Subsection F of this Section may be found on the LDH-OPH Immunization Program webpage identified as "https://lalinks.org/linksweb/LINKS_ENROLL.html". All licensed or credentialed immunization providers shall comply with the rules, regulations and policies outlined within the LINKS information system.

AUTHORITY NOTE: Promulgated in accordance with the provisions of R.S. 40:4(A)(2), R.S. 40:5(A) and R.S. 40:31.15. Also see R.S. 17:170, R.S. 22:1030 and R.S. 44:17.

HISTORICAL NOTE: Promulgated by the Department of Health, Office of Public Health, LR 46:590 (April 2020).

Chapter 9. Prevention and Control of Yellow Fever

§901. Definitions [formerly paragraph 2:029]

A. Unless otherwise specifically provided herein, the following words and terms used in this Chapter and all other Chapters which are adopted or may be adopted, are defined for the purposes thereof as follow.

Official Center—any nonfederal medical facility consisting of either a state, parish or municipal public health or a private clinic under full-time supervision of a physician licensed by the Louisiana Board of Medical Examiners.

Vaccination—the injection of immunizations required for international travel administered by approved centers medical personnel to an individual.

AUTHORITY NOTE: Promulgated in accordance with the provisions of R.S. 40:4(A)(2) and R.S. 40:5(12), and further in full cooperation with the U. S. Public Health Service requirements for international travel.

HISTORICAL NOTE: Promulgated by the Department of Health and Hospitals, Office of Public Health, LR 28:1221 (June 2002).

§903. Background and Legal Authority [formerly paragraph 2:030]

A. The International Health Regulations (IHR), Chapter II, Article 66, World Health Organization (WHO), to which the United States is signatory, require the health administration of each nation to designate centers where international travelers may be vaccinated against yellow fever. In this nation, the United States Public Health Service (USPHS) has this responsibility under Executive Order of the President. The vaccine must be approved by WHO, and the traveler's International Certificate of Vaccination or Revaccination against Yellow Fever must be properly validated.

B. [formerly paragraph 2:030-1] Since September 1, 1977, the USPHS has delegated to the State and Territorial Health Departments the responsibility of designating and supervising non-federal Yellow Fever Vaccination Centers within their respective jurisdictions. Criteria for categories of facilities to be designated are determined by the State and Territorial Health Departments. State and Territorial Health Departments issue and control the uniform stamps which may be used to validate International Certificates of Vaccination or Revaccination against Yellow Fever.

AUTHORITY NOTE: Promulgated in accordance with the provisions of R.S. 40:4 (A)(2) and R.S. 40:5 and further in full cooperation with the U. S. Public Health Service requirements for international travel.

HISTORICAL NOTE: Promulgated by the Department of Health and Hospitals, Office of Public Health, LR 28:1221 (June 2002).

§905. Yellow Fever Regulations [formerly paragraph 2:031]

A. The following is a list of regulations of the Louisiana Department of Health and Hospitals, developed by the Office of Public Health, in conjunction with the USPHS Centers for Disease Control, Quarantine Division for non-federal facilities given the responsibility for administering and validating International Certificates of Vaccination or Revaccination against Yellow Fever.

1. [formerly paragraph 2:031-1] Any facility designated as a Yellow Fever Vaccination Center and issued a uniform stamp to validate International Certification of Vaccination against yellow fever shall be either a state, parish or municipal public health or a private medical clinic under full time supervision of a physician licensed by the Louisiana Board of Medical Examiners. The supervising physician must be fully knowledgeable of the procedures necessary for issuing a valid document. Written instructions with illustrations are included in Health Information for International Travel issued annually as a supplement to the Morbidity and Mortality Weekly Report of the Centers for Disease Control. Possession of a current book is mandatory for all approved centers.

2. [formerly paragraph 2:031-2] The uniform stamp:

a. is the property of the Office of Public Health and must be returned upon request via registered mail within 30 days of notification of cancellation;

b. is to be used to validate only those certificates issued by the approved non-federal medical facility;

c. should be kept in a safe place when not in use and must not be loaned or reproduced.

3. [formerly paragraph 2:031-3] Loss or theft of a uniform stamp must be reported immediately to the Office of Public Health which in turn shall report to the Division of Quarantine, Center for Prevention Services, Centers for Disease Control, Atlanta, Georgia 30333.

4. [formerly paragraph 2:031-4] Approval of and continued possession of the uniform stamp will be based on justified need and maintenance of policies compatible with the Office of Public Health guidelines. Reevaluations will be conducted semi-annually.

5. [formerly paragraph 2:031-5] Improperly prepared certificates bearing the uniform stamp as reported by the CDC Division of Quarantine at ports of entry will be further investigated by personnel of the Office of Public Health.

6. [formerly paragraph 2:031-6] The Office of Public Health shall maintain a listing of uniform stamps with corresponding identification codes. A duplicate listing shall be filed with the CDC Division of Quarantine.

7. "The Center must maintain adequate refrigeration to assure that the yellow fever vaccine will be kept in a refrigerated state with temperatures as recommended by the vaccine manufacturer and included in the storage recommendations of the vaccine package insert. Once the vaccine has been removed from refrigeration and reconstituted, it must be administered within 60 minutes. Any remaining unrefrigerated and unused vaccine must be destroyed."

8. [formerly paragraph 2:031-8] When a supervising physician named on the application is no longer associated with an approved center, the Office of Public Health shall be notified. Application procedures as stated below must be completed by the new replacement supervising physician.

9. [formerly paragraph 2:031-9] Approved centers are required to keep records of persons whose International Certificates of Vaccination or Revaccination against Yellow Fever are validated and to submit periodic (six months) reports covering operations to the Office of Public Health. All designated centers are required to report adverse reactions to yellow fever vaccine of sufficient severity to require medical attention.

a. Adverse reactions or other complications occurring within 30 days of the receipt of the vaccine shall be reported:

i. neurologic reactions—meningitis, encephalitis, polyneuropathy, guillain-barre syndrome, paralysis;

ii. allergic reactions—urticaria, asthma, angioneurotic edema, erythema multiforme, anaphylaxis, other;

iii. other post vaccination complications—acute febrile illness with headache, malaise, Barthralgia, or jaundice.

10. [formerly paragraph 2:031-10] International Certificates of Vaccination must conform to International Health Regulations, Chapter III, Article 79, World Health Organization.

11. [formerly paragraph 2:031-11] The approved center shall develop, implement and maintain a procedure for handling emergencies due to severe vaccine reactions such as anaphylaxis, including the maintenance of necessary supplies and medicine to provide life support until patient can be transferred safely to an acute care facility.

12. [formerly paragraph 2:031-12] The state health officer may order additional procedures to ensure compliance with the provision of these regulations and reserves the authority to enforce any regulation not so specified in this rule that is considered to be medically significant in the operation of such clinics.

13. [formerly paragraph 2:031-13] The supervising physician is responsible for his or her practices regarding administration of immunizations.

14. [formerly paragraph 2:031-14] Proper infectious waste handling and disposal shall be done in accordance with the Louisiana Sanitary Code, Part XXVII.

AUTHORITY NOTE: Promulgated in accordance with the provisions of R.S. 40:4(A)(2) and R.S. 40:5. and further in full cooperation with the United States Public Health Service requirements for international travel.

HISTORICAL NOTE: Promulgated by the Department of Health and Hospitals, Office of Public Health, LR 28:1221 (June 2002), amended LR 34:444 (March 2008).

Editor's Note: The address, telephone and website listed in §907.A have changed to:

Office of Public Health
Yellow Fever Vaccination Center Certification Program
P.O. Box 60630
New Orleans, LA 70160
Telephone: (504) 568-5048
<http://www.ddh.louisiana.gov/offices/?IS=292>

§907. Application Procedures
[formerly paragraph 2:032]

A. To request designation as an approved Yellow Fever Center call or write to the Office of Public Health, Epidemiology Section, P.O. Box 60630, New Orleans, LA 70160 (504-568-5005) and request an application form. After receipt of a completed application form, OPH personnel will conduct an on-site inspection of the clinic facilities utilizing an instrument developed by the Office of Public Health for this purpose. A report will then be forwarded along with the completed application to the state health officer for approval/disapproval. If approved, the designated center, the Division of Quarantine, Centers for Disease Control, and the vaccine manufacturer shall be notified in writing. The uniform stamp is then issued using the supervising physician's state medical license number for identification. Any facility whose request for approval is denied may appeal the denial after conditions which resulted

PUBLIC HEALTH—SANITARY CODE

in a denial of approval have been verifiably modified to bring the center into conformity with established regulations. The facility has 30 days after receipt of the denial in which to appeal in writing to the state health officer, Office of Public Health, P.O. Box 60630, New Orleans, LA 70160.

AUTHORITY NOTE: Promulgated in accordance with the provisions of R.S. 40:4(A)(2) and R.S. 40:5. and further in full cooperation with the U.S. Public Health Service requirements for international travel.

HISTORICAL NOTE: Promulgated by the Department of Health and Hospitals, Office of Public Health, LR 28:1222 (June 2002).

Title 51

PUBLIC HEALTH—SANITARY CODE

Part III. The Control of Rabies and Other Zoonotic Diseases

Chapter 1. Anti-Rabies Vaccination Requirements for Dogs and Cats

§101. Definitions

[formerly paragraph 3:001]

A. Unless otherwise specifically provided herein, the following words and terms used in this Part of the Sanitary Code and all other Parts which are adopted or may be adopted are defined for the purposes thereof as follows.

Local Health Authority—any parish or municipal health officer, department or other agency charged with the responsibility of preserving the public health.

Owner—any person who keeps in his care or who harbors or has custody of a dog or other animal.

Prairie Dogs—[formerly paragraph 3:009] any burrowing rodents of the genus *Cynomys*. Prairie dogs can harbor monkeypox. Prairie dogs are also known to be a host for fleas, which carry the causative agent of Plague, the bacteria *Yersinia pestis*. These fleas have the potential to infect other wild animals, as well as domestic animals and humans. Prairie dogs are not indigenous to Louisiana.

Vaccination—the injection, by a licensed veterinarian, of an animal using anti-rabies vaccine approved by the state health officer.

Wild Animal—any animal species wherein the majority of its members are not maintained by humans for recreational, commercial food production, agricultural, research, or industrial purposes. Other than possibly endangered species, the majority of the members of such a species live primarily in a natural or non-domestic environment. Wolves, wolf hybrids, and feline species other than *Felis felis*/domestic cat hybrids, in circumstances involving rabies vaccination or rabies exposure, will be regarded as wild animals.

Zoonotic disease—a disease in humans caused by an infectious agent transmitted from animals to humans. Zoonotic diseases include, but are not limited to, anthrax (caused by *Bacillus anthracis*) and plague (caused by *Yersinia pestis*).

AUTHORITY NOTE: The first source of authority for promulgation of the sanitary code is in R.S. 36:258(B), with more particular provisions throughout Chapters 1 and 4 of Title 40 of the Louisiana Revised Statutes. This Part is promulgated in accordance with the provisions of R.S. 40:5(2), (3) and (10) together with the specific provisions of R.S. 40:4A(2)(a) and R.S. 40:1277.

HISTORICAL NOTE: Promulgated by the Department of Health and Hospitals, Office of Public Health, LR 28:1223 (June 2002), amended LR 33:650 (April 2007).

§103. Mandatory Vaccinations of Dogs, Cats, and Ferrets

[formerly paragraph 3:002]

A. No person shall own, keep or have in his custody a dog, cat, or ferret over 3 months of age that has not been vaccinated against rabies by a licensed veterinarian. Every owner of a dog, cat, or ferret shall cause said animal to be vaccinated initially with a series of two vaccinations, the first to be administered at 3 months of age, the second to be administered one year after the initial vaccination. Dogs, cats, or ferrets initially vaccinated later than 3 months of age shall also be administered a series of two vaccines, the second vaccine to be given one year after the initial vaccination. Thereafter, the interval between revaccinations shall conform to the *Compendium of Animal Rabies Prevention and Control*, 2016 Edition, Part II, Section B and Appendix 1: Rabies Vaccines Licensed and Marketed in the United States, 2016, which is published by the National Association of State Public Health Veterinarians, Inc. Vaccine licensing and labeling, including duration of immunity, is authorized by the Center for Veterinary Biotechnology at the United States Department of Agriculture (USDA), Animal and Plant Health Inspection Service (APHIS) and those decisions are based on testing conducted by the vaccine manufacturer. The results of testing are presented to USDA during the registration process.

AUTHORITY NOTE: Promulgated in accordance with the provisions of R.S. 40:4(A)(2)(a), R.S. 40:5(A) (2)(10)(11) and R.S. 40:1269.3.

HISTORICAL NOTE: Promulgated by the Department of Health and Hospitals, Office of Public Health, LR 28:1223 (June 2002), amended LR 33:650 (April 2007), LR 41:2657 (December 2015), amended by the Department of Health, Office of Public Health, LR:45:670 (May 2019).

§105. Human Exposure to Domestic Animal Bites [formerly paragraph 3:003]

A. When any dog, cat, or ferret bites a human being, said animal shall be confined (as described in §111) for a minimum of 10 days following the bite, or said animal shall be killed and the head submitted immediately to a laboratory of the Louisiana Department of Health for examination for rabies. During the observation period a rabies vaccine should not be administered to the animal to avoid confusing signs of rabies with possible side effects of vaccine administration. Any dog, cat, or ferret that develops any signs during the 10 day observation period shall be reported immediately to the local health authority and, provided such signs are compatible with rabies as determined by a licensed veterinarian or the official state public health veterinarian, the animal shall be killed and the head submitted to a

laboratory of the Louisiana Department of Health for examination.

AUTHORITY NOTE: Promulgated in accordance with the provisions of R.S. 40:4A(2)(a), and R.S. 40:1269.3.

HISTORICAL NOTE: Promulgated by the Department of Health and Hospitals, Office of Public Health, LR 28:1223 (June 2002), amended LR 33:650 (April 2007), amended by the Department of Health, Office of Public Health, LR:45:671 (May 2019).

**§107. Domestic Animals Bitten by Rabid Animals
[formerly paragraph 3:004]**

A. When bitten by a rabid animal, unvaccinated dogs, cats, or ferrets shall be destroyed immediately unless the owner is unwilling to have this done, in which case, the unvaccinated animal shall be confined (as described in §111) for four months for dogs and cats and six months for ferrets being released. A rabies vaccine shall be administered at the time of entry into quarantine (confinement) to bring the animal up to current rabies vaccination status. Administration of the vaccine shall be done as soon as possible. It is recommended that the period from exposure to vaccination not exceed 96 hours. If vaccination is delayed the official state public health veterinarian may consider increasing the quarantine period for dogs and cats from four to six months. Dogs, cats, or ferrets that are currently vaccinated shall be re-vaccinated immediately and confined (as described in §111) for 45 days.

1. Overdue dogs and cats. Dogs and cats that are overdue for a booster vaccination and that have appropriate documentation of having received a USDA-licensed rabies vaccine at least once previously shall immediately receive a booster vaccination and shall be kept under the owner's control and observed for 45 days. Dogs and cats that are overdue for a booster and without appropriate documentation of having received a USDA-licensed rabies vaccine at least once previously shall be:

a. treated as unvaccinated, immediately given a booster vaccination and placed in strict quarantine; or

b. the official state public health veterinarian may consider use of prospective serological monitoring (PSM) of the animal to document prior vaccination by providing evidence of an anamnestic response to booster vaccination. If the official state public health veterinarian authorizes PSM, the animal shall be strictly quarantined while PSM is performed. If the official state public health veterinarian confirms that PSM provides evidence of an anamnestic response, the period of strict quarantine may be ended, and the animal may be kept under the owner's control and observed for 45 days. If there is inadequate evidence of an anamnestic response, the animal is considered to have never been vaccinated and shall be placed in strict quarantine for 4 to 6 months.

2. Overdue ferrets. Ferrets that are overdue for a booster shall be considered unvaccinated and shall be immediately vaccinated for rabies and strictly quarantined for 6 months.

B. All species of livestock exposed to a rabid animal and currently vaccinated with a vaccine approved for that species by the United States Department of Agriculture should be re-vaccinated immediately and observed for 45 days. Unvaccinated livestock should be slaughtered immediately.

C. Other mammals, including wild animals, exposed to a rabid animal should be euthanized immediately.

D. Animals maintained in a United States Department of Agriculture licensed research facility or accredited zoological parks will be evaluated on a case by case basis by the official state public health veterinarian.

AUTHORITY NOTE: Promulgated in accordance with the provisions of R.S. 40:4(A)(2)(a), and R.S. 40:1269.3.

HISTORICAL NOTE: Promulgated by the Department of Health and Hospitals, Office of Public Health, LR 28:1223 (June 2002), amended LR 33:651 (April 2007), amended by the Department of Health, Office of Public Health, LR:45:671 (May 2019).

**§109. Animals Suspected of Being
Infected with Rabies
[formerly Paragraph 3:006]**

A. Any animal other than a dog, cat, or ferret that bites a human being, or any animal that is suspected of being infected with rabies (whether or not it has bitten anyone), may be required by the state health officer or official state public health veterinarian, for the protection of the public health, to be killed and the head of such animal examined for rabies free of charge by a laboratory of the Louisiana Department of Health and Hospitals.

AUTHORITY NOTE: Promulgated in accordance with the provisions of R.S. 40:4A(2)(a), and R.S. 40:1277.

HISTORICAL NOTE: Promulgated by the Department of Health and Hospitals, Office of Public Health, LR 28:1223 (June 2002), amended LR 33:651 (April 2007).

**§111. Confinement or Quarantine of Animals
[formerly paragraph 3:007]**

A. Where confinement is required under the provisions of this Code, the owner, veterinarian, animal shelter or other custodian of the animal shall confine said animal in a cage or in another manner such that the animal cannot contact any person or other animal. Tethering is not permitted.

AUTHORITY NOTE: Promulgated in accordance with the provisions of R.S. 40:4A(2)(a), and R.S. 40:1277.

HISTORICAL NOTE: Promulgated by the Department of Health and Hospitals, Office of Public Health, LR 28:1224 (June 2002), amended LR 33:651 (April 2007), amended by the Department of Health, Office of Public Health, LR:45:671 (May 2019).

Chapter 3. Other Zoonotic Diseases

Editor's Note: Renumbered and rearranged pursuant to the authority of R.S. 49:983 to make it clear that prairie dogs have nothing to do with rabies control (per request of LDHH-OHP).

§301. Definition

Prairie Dogs—[formerly Paragraph 3:009] any burrowing rodents of the genus *Cynomys*. *Prairie dogs* can harbor the hantavirus. *Prairie dogs* are also known to be a host for

fleas, which carry the causative agent of Bubonic Plague, the bacteria *Yersinia pestis*. These fleas have the potential to infect other wild animals, as well as domestic animals and humans. *Prairie dogs* are not indigenous to Louisiana.

AUTHORITY NOTE: Promulgated in accordance with R.S. 40:4(A)(9) and R.S. 40:5(2)(3)(17).

HISTORICAL NOTE: Promulgated by the Department of Health and Hospitals, Office of Public Health, LR 29:1098 (July 2003).

§303. Prohibition on Importation/Sale of Prairie Dogs

A. [formerly paragraph 3:010] The importation and/or sale of prairie dogs in Louisiana is prohibited.

B. [formerly paragraph 3:011] This Section shall not apply to zoos approved by the American Association of Zoological Parks and Aquariums.

AUTHORITY NOTE: Promulgated in accordance with R.S. 40:4(A)(9) and R.S. 40:5(2)(3)(17).

HISTORICAL NOTE: Promulgated by the Department of Health and Hospitals, Office of Public Health, LR 29:1098 (July 2003), amended LR 33:651 (April 2007).

Title 51
PUBLIC HEALTH—SANITARY CODE
Part IV. Lead Poisoning Control

Chapter 1. Lead Contamination

§101. Definitions
[formerly paragraph 4:001]

A. Unless otherwise specifically provided herein, the following words and terms used in this Part of the sanitary code and all other Parts which are adopted or may be adopted, are defined for the purposes thereof as follows.

Abate—to remove, isolate, cover with permanently affixed lead-free covering incapable of being readily chewed through, pierced, torn or removed, or to otherwise make inaccessible to children or other persons, sources of lead contamination. Painting over lead-based paint with non-lead paint shall not constitute abatement; however, liquid encapsulant formulated and warranted by the manufacturer for such purpose may be used. Contaminated soil may be covered with uncontaminated topsoil or vegetation, if approved by the state health officer.

Chewable Surface—shall include, but not be limited to, such surfaces as window sills, window frames, door frames, handrails, toys, furniture, and other appurtenances offering a biting surface to a child or other person.

Child—as used in this Part shall mean a child under six years of age.

Dwelling—a building or structure occupied or designed or intended to be occupied as a place of human habitation and use, and construed to include any accessory building or structure belonging thereto or usually enjoined therewith.

Dwelling Unit—any room or group of rooms or other interior area of a dwelling designed or used for human habitation.

Exposed Surface—all surfaces of a premises which are readily accessible to any person. Such surfaces include structural components, walls, and siding from floor or ground level to a vertical distance of at least 5 feet. Any area subject to contamination from flaking, peeling or chalking lead based materials is also considered an exposed surface.

Lead Contamination—shall include: paint or similar coating material, putty, plaster or other composition material, on a exposed surface or chewable surface, which contains 0.5 percent lead by weight as determined by laboratory analysis or 1.0 milligram per square centimeter of surface area as measured by X-ray fluorescence or equivalent method; drinking water, dust, or soil which contains a level of lead which, in the judgment of the state health officer, is sufficient to be a source of lead poisoning to children or other persons; any object or material which, in the judgment of the state health officer, can be a source of lead ingestion or inhalation.

Lead Poisoning—a blood lead level hazardous to health as established by the state health officer.

Occupant—any person living, sleeping, cooking, eating in or having actual possession of a dwelling or dwelling unit.

Operator—any person who has charge, care or control of a building or part thereof in which dwelling units are let.

Other Person—as used in this Part shall mean a person, other than a child under six years of age, deemed by the state health officer to be at risk of lead poisoning because of mental state, physiological condition, or behavioral traits.

Owner—a holder of any legal or equitable estate in the premises, whether alone or jointly with others, and whether in possession or not.

Premises—a lot, plot or parcel of land or part thereof including all facilities and improvements thereon.

Surface—the outermost layer of the superficial area of a premises.

AUTHORITY NOTE: The first source of authority for promulgation of the sanitary code is in R.S. 36:258 (B), with more particular provisions found in Chapters 1 and 4 of Title 40. This Part is promulgated in accordance with provisions of R.S. 40:4 and 5. In particular, see the specific provisions in R.S. 40:1299.20, et seq.

HISTORICAL NOTE: Promulgated by the Department of Health and Hospitals, Office of Public Health, LR 28:1224 (June 2002).

§103. Health Hazard Condition
[formerly paragraph 4:002]

A. Lead contamination shall be considered a health hazard to children or other persons, if said lead contamination exists in or about a dwelling, dwelling unit, household, or other premises which, in the judgment of the state health officer, children or other persons visit with such frequency or duration as to create significant risk of lead poisoning.

AUTHORITY NOTE: Promulgated in accordance with the provisions of R.S. 40:4 and 5. In particular, see R.S. 40:1299.20, et seq.

HISTORICAL NOTE: Promulgated by the Department of Health and Hospitals, Office of Public Health, LR 28:1224 (June 2002).

§105. Day Care Facilities
[formerly paragraph 4:003]

A. All day care facilities or institutions in which children or other persons commonly reside or are cared for shall be maintained free of lead contamination.

AUTHORITY NOTE: Promulgated in accordance with the provisions of R.S. 40:4 and 5. In particular, see R.S. 40:1299.20 et seq.

HISTORICAL NOTE: Promulgated by the Department of Health and Hospitals, Office of Public Health, LR 28:1224 (June 2002).

§107. Inspection of Premises
[formerly paragraph 4:004]

A. When the state health officer is informed of a case of lead poisoning, he shall cause to have inspected the dwelling in which the person with lead poisoning resides, or has recently resided, if the occupants of such dwelling consent, after reasonable notice, to such inspection. The state health officer may, as he deems necessary, cause to have inspected other residences or premises which the person with lead poisoning frequents.

B. [formerly paragraph 4:005] The purpose of such inspection shall be to identify possible sources of lead poisoning. The inspection may include: *in situ* testing with an X-ray fluorescence analyzer or other method approved by the state health officer; collection of paint, dust, soil, and water samples for laboratory analysis; visual inspection for objects which may contain lead; and interviews with the person with lead poisoning or others with knowledge of the person's behavior and habits.

AUTHORITY NOTE: Promulgated in accordance with the provisions of R.S. 40:4 and 5. In particular, see R.S. 40:1299.20 et seq.

HISTORICAL NOTE: Promulgated by the Department of Health and Hospitals, Office of Public Health, LR 28:1225 (June 2002).

§109. Required Control Measures
[formerly paragraph 4:006]

A. When lead contamination is found in a dwelling, the following actions shall be taken.

1. [formerly paragraph 4:006-1] The inspection findings shall be reported in writing immediately to the parent or guardian, owner and/or operator of the building, all affected tenants, the person having medical management of the lead poisoning case, and the state health officer. Additionally, any findings as to behavior or habits of the person with lead poisoning which might be causative of lead poisoning shall be reported to the person having medical management.

2. [formerly paragraph 4:006-2] The parent or guardian of the person with lead poisoning and the owner and/or operator of the building shall be notified that such that such person and other children should immediately be protected from the lead hazard, either by removal from the dwelling, isolation of the contamination, or other method approved by the state health officer, until the hazard is abated.

3. [formerly paragraph 4:006-3] A notice shall be prominently posted on the main entrance of the dwelling that the premises contains levels of lead hazardous to children and other persons and that such persons should not occupy the building until the hazard has been abated.

a. Such notice may not be removed until the state health officer determines that the hazard has been abated.

b. Unauthorized intentional removal of the notice shall subject the offender to a fine of \$500 as provided in R.S.40:1299.24(C).

4. [formerly paragraph 4:006-4] The state health officer shall strongly encourage the examination of all children and other persons residing, or who have recently resided in the dwelling.

5. [formerly paragraph 4:006-5] If, within 30 days of notification of the existence of lead contamination, the parent or guardian and/or the owner or operator of the building have not taken adequate measures to protect the person with lead poisoning and children and other persons from the lead hazard, they shall be invited to attend a conference at the local health unit or other site designated by the state health officer. Invitees shall be given at least 10 days advance notice of the conference; shorter notice may be given if mutually agreeable. Present at the conference shall be: the inspector or other Office of Public Health representative familiar with the inspection results, the person having medical management of the poisoning case or other person familiar with the case, and if possible, a social worker.

6. [formerly paragraph 4:006-6] The purpose of the conference shall be to inform the invitees of the hazard to the person with lead poisoning, and to children and other persons, the necessity for protecting such persons from the lead hazard, and to develop a plan of action to accomplish such. Such plan should include removal of the persons at risk, abatement of the hazard, or other steps approved by the state health officer. A written or electronic record of the conference shall be kept. At the conclusion of the conference, the invitees shall be requested to sign a statement that they understand the hazard to the child, and that they agree to accomplish the plan of action by a mutually agreed upon date. Such statement shall be made part of the conference record.

7. [formerly paragraph 4:006-7] If, at any time, the state health officer determines that a child with lead poisoning and other children in the family are at risk and are likely to remain so without intervention beyond that outlined above, he shall notify the appropriate child protection agency and/or other agency of the particulars of the case.

AUTHORITY NOTE: Promulgated in accordance with the provisions of R.S. 40:4 and 5. In particular, see R.S. 40:1299.20 et seq.

HISTORICAL NOTE: Promulgated by the Department of Health and Hospitals, Office of Public Health, LR 28:1225 (June 2002).

§111. Verified Abatement
[formerly paragraph 4:007]

A. Lead contamination identified as a result of the aforementioned inspection shall not be considered abated until verified by a reinspection authorized by the state health officer.

AUTHORITY NOTE: Promulgated in accordance with the provisions of R.S. 40:4 and 5. In particular, see R.S. 40:1299.20 et seq.

HISTORICAL NOTE: Promulgated by the Department of Health and Hospitals, Office of Public Health, LR 28:1225 (June 2002).

Title 51
PUBLIC HEALTH—SANITARY CODE
Part V. Disease Vector Control

Chapter 1. Mosquito Control

§101. Definitions
[formerly paragraph 5:001]

A. Unless otherwise specifically provided herein, the following words and terms used in this Part of the sanitary code and all other Parts which are adopted or may be adopted, are defined for the purposes thereof as follows.

Community—any incorporated area, or in the case of unincorporated areas, either of the following:

- a. a settlement consisting of 25 or more residences within a circle having a 0.5 mile diameter; or
- b. a settlement consisting of 25 or more residences per mile of highway frontage.

Control Measures—any measures approved by the state health officer which are used in the prevention or control of mosquito-borne diseases. These measures include source reduction, application of pesticides, naturalistic (biological) control, exclusion of mosquitoes, and integrated pest management.

Exclusion—exclusion of mosquitoes includes measures of protection against mosquitoes such as screening of openings in dwellings to prevent entry of adult mosquitoes and screening of stored water to prevent egg-laying by mosquitoes and the use of protective clothing and mosquito repellents.

Impounded—any body of water formed by the construction or excavation of a basin or the obstruction of surface water run-off in such a manner as to cause the collection of a body of water which could not have formed under natural conditions. Such impounded waters of less than 2 acres of water surface, are not included in this definition, except that in the event an outbreak of disease known or suspected to be transmissible by mosquitoes occurs in the vicinity of such a pond, the state health officer may require that it be subject to the same regulations as larger bodies of impounded water.

Integrated Pest Management—integrated pest management as applied to mosquito prevention and control includes a combination of procedures such as exclusion, naturalistic control, source reduction, and the application of pesticides.

Naturalistic—naturalistic control involves the use of predators, pathogens (diseases), and other natural antagonists of mosquitoes.

AUTHORITY NOTE: The first source of authority for promulgation of the sanitary code is in R.S. 36:258(B), with more particular provisions found in Chapters 1 and 4 of Title 40. This

Part is promulgated in accordance with R.S. 40:4 and R.S. 40:5. In particular, see R.S. 40:4(A)(9).

HISTORICAL NOTE: Promulgated by the Department of Health and Hospitals, Office of Public Health, LR 28:1226 (June 2002).

§103. General Mosquito Control Regulations
[formerly paragraph 5:002]

A. Water in man-made containers or man-made basins within 1 mile (1.61 km) of communities shall not be permitted to produce mosquitoes. Tanks and other containers used for storage of water shall have all openings larger than 1/18 of an inch (0.14 cm) screened with wire mesh not less than 18 strands to the inch each way (7 strands to the centimeter). Standing water in fountains, basins, and urns in parks, cemeteries, and residential and commercial sites, and water in ponds, pools, borrow pits, ditches, or other depressions or excavations must be maintained free from debris, flottage, and emergent vegetation and stocked with mosquito larvae-eating fish or treated at suitable intervals with federal and state approved larvicide if mosquito production becomes imminent.

B. [formerly paragraph 5:003] In the event of an outbreak or imminent outbreak of mosquito-borne disease, the state health officer, may, in addition to the regulations promulgated elsewhere in this Part, require mosquito prevention or abatement measures applied to less usual sources of mosquito production as considered necessary.

C. [formerly paragraph 5:004] All persons suspected of having a mosquito-borne infection shall be protected from the bites of mosquitoes unless, and until, the infection is found not to be due to mosquito-borne infection; and if found to be mosquito-borne, protection shall be continued until the infective stage has passed, as determined by the state health officer.

D. [formerly paragraph 5:005] It shall be unlawful for any person to create, or cause to be created, conditions favorable for producing mosquitoes by impounding of water unless provision has been made for control measures.

E. [formerly paragraph 5:006] In the event of an outbreak or imminent outbreak of mosquito-borne disease, the state health officer may require that any person proposing to impound water, raise the level of existing impounded water, or re-impound water in areas where previous impoundage has been discontinued for one or more seasons, prior to the institution of any construction activities, shall make written application to the state health officer and receive therefrom a written permit for impoundage construction.

AUTHORITY NOTE: Promulgated in accordance with R.S. 40:4 and R.S. 40:5. In particular, see R.S. 40:4(A)(9).

HISTORICAL NOTE: Promulgated by the Department of Health and Hospitals, Office of Public Health, LR 28:1226 (June 2002).

§105. Approval of Community Abatement Plans
[formerly paragraph 5:025]

A. No person shall conduct operations designed to abate community mosquito problems until plans for such operations have been approved by the state health officer, and a written approval has been secured therefrom. The state health officer will, upon request, provide an applicant with guidelines for the preparation of an operational plan for mosquito control.

AUTHORITY NOTE: Promulgated in accordance with R.S. 40:4 and R.S. 40:5. In particular, see R.S. 40:4(A)(9).

HISTORICAL NOTE: Promulgated by the Department of Health and Hospitals, Office of Public Health, LR 28:1226 (June 2002).

Chapter 3. Rodent Control

§301. Definitions
[formerly paragraph 5:026]

A. Unless otherwise specifically provided herein, the following words and terms used in this Part of the sanitary code and all other Parts which are adopted or may be adopted, are defined for the purposes thereof as follows.

Business Building—any structure which is used in any way for the monetary profit of the occupant or in which persons are employed, or any building the principal use of which is storage.

Dense Concrete—whenever concrete is mentioned in these regulations, it shall be taken to mean dense concrete composed of not less than one part by volume of Portland cement to six parts of aggregate consisting of sand mixed in proper proportions with gravel, crushed rock, or crushed slag.

Impervious Material—this term shall include glass, non-corrosive steel or iron, non-corrosive metal screen, dense concrete, or other material which may be approved by the Department of Health and Human Resources.

Rat-Proofing—the act of rendering a building impenetrable to rodents.

Rodent—the term *rodent* is considered to include all gnawing animals of the order Rodentia such as rats, mice, ground squirrels, etc.

AUTHORITY NOTE: Promulgated in accordance with R.S. 40:4 and R.S. 40:5. In particular, see R.S. 40:4(A)(9).

HISTORICAL NOTE: Promulgated by the Department of Health and Hospitals, Office of Public Health, LR 28:1227 (June 2002).

§303. General Rodent Control Regulations
[formerly paragraphs 5:027]

A. No person shall own, keep, maintain, occupy, or otherwise use any room, warehouse, grain elevator, or other building for the storage, handling, processing, or dispensing of food or food products, or for the quartering of any animal

or fowl, without carrying out measures which will prevent the entrance of rodents into, or the harboring of rodents under, or within the walls of such room, warehouse, grain elevator, or other building.

B. [formerly paragraph 5:028] Every building, place, and premises shall be kept and maintained by the owner or occupant in a clean and sanitary condition, and free from rodents.

C. [formerly paragraph 5:029] No rubbish, garbage, or other waste shall be dumped, left, or be permitted to accumulate or to remain in any building, place, or premises in such a manner that the same will, or may, afford food harborage, or a breeding place for rodents. All lumber, boxes, barrels, loose iron, and similar material stored in such places shall be placed on supports elevated not less than 18" (46 cm) above the ground or floor, with a clean intervening space beneath.

D. [formerly paragraph 5:030] Garbage storage shall conform to requirements of Part XXVII of this Code.

AUTHORITY NOTE: Promulgated in accordance with R.S. 40:4 and R.S. 40:5. In particular, see R.S. 40:4(A)(9).

HISTORICAL NOTE: Promulgated by the Department of Health and Hospitals, Office of Public Health, LR 28:1227 (June 2002).

§305. Regulations for Rodent-Proofing
of Existing Buildings
[formerly paragraphs 5:031]

A. No person shall reconstruct any building or structure, or repair or remodel any building or structure to the extent of 50 percent of the value of the structure, unless the same shall be made rodent-proof by the proper use of impervious material. Provided, that only such repairs or remodeling as affects or may affect the rodent-proof condition of the building or structure shall be considered subject to the provisions of this regulation.

B. [formerly paragraph 5:032] When rodent-borne diseases have been declared by the state health officer to be prevalent in a community, no alteration or repairs to existing structure to the extent of 50 percent of the value of the structure shall be undertaken without a permit from the state health officer.

C. [formerly paragraph 5:033] All foundation wall ventilator openings shall be covered for their entire height and width with perforated sheet metal plates of a thickness of not less than 14 gauge, or with expanded sheet metal of a thickness not less than 18 gauge, or with wire cloth of 19 gauge or heavier, or with cast iron grilles or gratings. The openings therein shall not exceed 1/2 inch (1.3 cm) in least dimension.

D. [formerly paragraph 5:034] All foundation and exterior wall openings, except those used as doors or windows or for purposes of ventilation and light, such as openings due to deteriorated walls or broken masonry or concrete, shall be protected against the ingress of rodents by closing such openings with cement mortar, concrete, or masonry.

E. [formerly paragraph 5:035] All exposed edges of the lower 10 inches of wooden doors, door sills, and jambs serving as rear or side entrances into business buildings, and other doors accessible to rodents, shall be protected against the gnawing of rodents by covering said doors, door sills, and jambs with solid sheet metal of not less than 24 gauge thickness. All doors on which metal flashing has been applied shall be properly hinged to ensure free swinging. When closed, doors shall fit snugly so that the maximum clearance between any door and the door jamb and sill shall not be greater than 3/8 inch (0.96 cm).

F. [formerly paragraph 5:036] All windows and other openings for the purpose of lighting or ventilating located in the side or rear of exterior walls and within 2 feet of the existing ground level immediately below such openings shall be covered for their entire height and width, including frame, with wire cloth of 19 gauge or heavier, having a mesh not larger than 1/2 inch (1.3 cm). All windows and exterior walls not covered in the above Paragraph, which are accessible to rodents by way of exposed pipes, wires, conduits and other appurtenances, shall be covered with wire cloth of 19 gauge or heavier, having a mesh not larger than 1/2 inch (1.3 cm); or, in lieu of wire cloth covering, said pipes, wires, conduits or other appurtenances shall be blocked from rodent usage by installing solid sheet metal guards of 24 gauge, or heavier. Said guards shall be fitted snugly around pipes, wires, conduits or other appurtenances. In addition, they shall be fastened securely to the exterior wall and shall extend a minimum distance of 12 inches (30.7 cm) beyond and on either side of said pipe, wire, conduit, or appurtenance. This regulation shall not apply in the case of windows which cannot be opened and whose function is solely for the purpose of admitting light.

1. [formerly paragraph 5:037-1] Light wells with windows in exterior walls, which are located below the outside ground level, shall be protected from the ingress of rodents by the following methods.

a. [formerly paragraph 5:037-2] Cast iron or steel grilles or gratings, with openings not to exceed 1/2 inch (1.3 cm) in least dimension shall be installed over light wells.

b. [formerly paragraph 5:037-3] Expanded metal of 18 gauge, or heavier, having openings not greater than 1/2 inch (1.3 cm) in least dimension, 16 gauge, or heavier, wire cloth of 1/2 inch (1.3 cm) mesh shall be used to completely cover existing metal light well grilles where such existing grilles are broken or are otherwise defective or which have openings larger than 1/2 inch (1.3 cm) in least dimension and shall be securely attached to the existing grille.

G. [formerly paragraph 5:038-1] Any business building constructed on piers and having wooden floor sills less than 12 inches (30.7 cm) above the surface of the ground shall have the intervening space between floor sill and ground protected against the ingress of rodents by installing a solid masonry, concrete or solid sheet metal curtain wall of 24 gauge, or heavier, around the entire perimeter of the building, and extending said curtain wall to a depth of not

less than 24 inches (61.4 cm) below the surface of the ground level, and fastening securely to the exterior wall of the building.

H. [formerly paragraph 5:038-2] In lieu of the installation of curtain walls, any ground floor of wood construction may be replaced with concrete of not less than 3 inches (7.7 cm) thickness, with the exterior walls protected to a height of 24 inches above the concrete floor with masonry, concrete, or solid sheet metal of 24 gauge, or heavier. Exterior wall protection shall be securely tied into the concrete floor at all points.

I. [formerly paragraph 5:039] Any building constructed on piers, and having wooden floor sills greater than 12 inches (30.7 cm) above the ground level, shall have the intervening space between floor sill and ground protected against the ingress of rodents by installing curtain walls in accordance with the Paragraph above, or protecting said building against the ingress of rodents by installing solid sheet metal collars of 24 gauge or heavier snugly around each pipe, cable, wire, conduit, or other utility service passing through wooden ground flooring. The overall diameter of any such metal collar shall be not less than 8 inches (20.5 cm) larger than the diameter of the pipe, cable, wire, conduit, or other utility service, and said collar shall be securely fastened to the wooden floor. All other openings in wooden ground floors through which rodents may gain access into double walls or the interior of a building, such as openings which may exist in floors at double walls above floor sills, shall be closed with 24 gauge or heavier solid sheet metal, or 16 gauge or heavier wire cloth of 1/2 inch (1.3 cm) mesh, or with dense concrete.

J. [formerly paragraph 5:040] Any necessary opening in an exterior wall, not heretofore enumerated, shall be effectively protected against the passage of rodents in a manner satisfactory to the Department of Health and Human Resources.

AUTHORITY NOTE: Promulgated in accordance with R.S. 40:4 and R.S. 40:5. In particular, see R.S. 40:4(A)(9).

HISTORICAL NOTE: Promulgated by the Department of Health and Hospitals, Office of Public Health, LR 28:1227 (June 2002).

§307. Regulations for Rodent-Proofing New Buildings [formerly paragraphs 5:041]

A. The footing and foundation walls of any new business building shall be of dense concrete or masonry, and shall extend around the entire perimeter of the business building and to a depth of not less than 24 inches (61.4 cm) below the surface of the finished ground.

B. [formerly paragraph 5:042] Basement and cellar floors of new business buildings shall be constructed of dense concrete having a thickness of not less than 3 inches (7.7 cm) and shall be continuous over the entire floor area. The concrete shall be tightly sealed to the exterior footing and foundation walls.

C. [formerly paragraph 5:043] Ventilators, windows, doors, and miscellaneous openings shall be treated in the same manner as for existing business buildings, and especially in accordance with Subsections 305.C-J.

AUTHORITY NOTE: Promulgated in accordance with R.S. 40:4 and R.S. 40:5. In particular, see R.S. 40:4(A)(9).

HISTORICAL NOTE: Promulgated by the Department of Health and Hospitals, Office of Public Health, LR 28:1228 (June 2002).

§309. Rodent Control Regulations for Curb or Farmer's Markets [formerly paragraph 5:044]

A. Curb or farmers' markets, in which fruits or vegetables are exposed and offered for sale on racks, stands, platforms, or in vehicles outside of business buildings which may be a part of curb or farmers' markets shall conform to relevant provisions of these regulations.

AUTHORITY NOTE: Promulgated in accordance with R.S. 40:4 and R.S. 40:5. In particular, see R.S. 40:4(A)(9).

HISTORICAL NOTE: Promulgated by the Department of Health and Hospitals, Office of Public Health, LR 28:1228 (June 2002).

§311. Regulations to Control Rodents from Floating Vessels [formerly paragraphs 5:045]

A. Any floating vessel docking or landing in any port or place in the state of Louisiana where bubonic plague exists, and any vessel coming from a plague infested locality shall, while lying at a dock or landing in the state of Louisiana, be fended off at least 4 feet (1.23 m) at all times while at such dock or landing.

B. [formerly paragraph 5:046] No gangplank, ladder, skid or other device or structure whereby rodents may find egress from the vessel to a dock or landing shall be allowed to extend from any vessel to such dock or landing except at times when such gang plank, etc., is actually in use, the same to be removed when not actually in use, and in all instances to be removed at night, unless the vessel is actually in the process of discharging or loading cargo or passengers during the night.

C. [formerly paragraph 5:047] All docks and wharves shall be equipped with fender logs, not less than 24 inches (61.4 cm) in diameter at the smallest part, or other approved means of maintaining a clear distance of at least 24 inches (61.4 cm) between the side of the vessel and the wharf.

D. [formerly paragraph 5:048] Each spar and each chain, hawser, rope or line of any kind extending from any vessel, steamboat, or other water craft to said dock or wharf, shall be equipped with and have properly and securely attached thereto a rodent shield or guard of a design and in a manner approved by the state health officer.

AUTHORITY NOTE: Promulgated in accordance with R.S. 40:4 and R.S. 40:5. In particular, see R.S. 40:4(A)(9).

HISTORICAL NOTE: Promulgated by the Department of Health and Hospitals, Office of Public Health, LR 28:1228 (June 2002).

§313. Approval of Plans to Abate Community Rodent Problems [formerly paragraph 5:049]

A. No person shall conduct operations designed to abate community rodent problems until plans for such operations have been approved by the state health officer, and a written

approval has been secured therefrom. The state health officer will, upon request, provide an applicant with guidelines for the preparation of an operational plan for rodent control.

AUTHORITY NOTE: Promulgated in accordance with R.S. 40:4 and R.S. 40:5. In particular, see R.S. 40:4(A)(9).

HISTORICAL NOTE: Promulgated by the Department of Health and Hospitals, Office of Public Health, LR 28:1229 (June 2002).

Chapter 5. Control of Domestic Flies and Other Arthropods of Public Health Importance

§501. Definitions [formerly paragraph 5:050]

A. Unless specifically provided herein, the following words and terms used in this Chapter of the sanitary code and all other Chapters which are adopted or may be adopted are defined for the purpose thereof as follows.

Arthropod—a member of the phylum Arthropoda including, but not limited to, insects, ticks, mites, spiders, and scorpions.

Breeding Medium—any warm, moist, organic material which will support the development of domestic flies.

Domestic Flies—insects of the order Diptera including the families Muscidae (houseflies and related species), Sarcophagidae (flesh flies), and Calliphoridae (blowflies and bottle flies).

Public Health Importance—an arthropod is considered to be of public health importance if it transmits disease organisms or occurs in numbers sufficient to cause significant annoyance to humans.

AUTHORITY NOTE: Promulgated in accordance with R.S. 40:4 and R.S. 40:5. In particular, see R.S. 40:4(A)(9).

HISTORICAL NOTE: Promulgated by the Department of Health and Hospitals, Office of Public Health, LR 28:1229 (June 2002).

§503. Refuse Regulations [formerly paragraph 5:051]

A. All refuse shall be managed in accordance with the provisions in Part XXVII of this Code so as not to promote the breeding of flies and other arthropods of public health importance.

B. [formerly paragraph 5:053] The storage, retention, processing, or otherwise accumulation of material not ordinarily considered waste, (such as, but not limited to, fermentation vats, animal by products, and silage) but which can serve as a fly breeding medium shall not be permitted unless effective means to prevent such breeding are provided. The absence of domestic fly breeding in such material shall be deemed indicative of effective prevention.

C. [formerly paragraph 5:054] No owner or lessee of any public or private property nor any agent of such owner or lessee shall create, or allow to be created, upon the property or premises, conditions favorable for the development of arthropods of public health importance.

D. [formerly paragraph 5:055] When, in the opinion of the state health officer, there exist man-made conditions favorable for the development of domestic flies or other arthropods of public health importance upon any property or premises, he shall notify the owner, lessee or agent in writing of his findings, specifying a reasonable time in which these conditions are to be corrected. If said conditions are not corrected within the specified time, the owner, lessee

or agent shall be considered in violation of this code and subject to the prescribed penalties.

AUTHORITY NOTE: Promulgated in accordance with R.S. 40:4 and R.S. 40:5. In particular, see R.S. 40:4 (A)(9).

HISTORICAL NOTE: Promulgated by the Department of Health and Hospitals, Office of Public Health, LR 28:1229 (June 2002).

Title 51
PUBLIC HEALTH—SANITARY CODE
Part VI. Manufacturing, Processing, Packing
and Holding of Food, Drugs and Cosmetics

**Chapter 1. General Regulations,
Definitions, Permits, Registration,
Machinery, Equipment and
Utensils, Premises and Buildings,
Temperature Control**

§101. Definitions
[formerly paragraph 6:001]

A. Unless otherwise specifically provided herein, the following words and terms used in this Chapter of the *Sanitary Code*, and all other Chapters which are adopted or may be adopted, are defined for the purposes thereof as follows.

Adulterated Foods, Filth, and Contamination—are defined in R.S. 40:607.

Advertisement—includes all representations of fact or opinion disseminated to the public in any manner or by any means other than by the labeling.

Bakery—any establishment operating to manufacture any bread or bread products, pies, cakes, cookies, crackers, doughnuts, or other similar products.

CCP—see *Critical Control Point*.

Confirmed Positive Test Result—any result obtained from a laboratory test of an ingredient, equipment, container, or finished product that indicates the presence of an adulterant, as defined by R.S. 40:607 et seq., in excess of any tolerance specified in state or federal law or regulations.

Control—to manage the conditions of an operation to maintain compliance with established criteria, *control* also means that correct procedures are being followed and criteria are being met.

Control Measure—any action or activity that can be used to prevent, eliminate, or reduce a significant *hazard* that is managed as a *critical control point*.

Control Point—any step at which biological, chemical or physical factors can be controlled.

Corrective Action—procedures followed when a *deviation* occurs.

Cosmetic—includes all substances and preparations intended for cleansing, altering the appearance of, or promoting the attractiveness of a person. The term includes soaps only when medicinal or curative qualities are claimed by the use thereof.

Critical Control Point (CCP)—a step at which *control* can be applied and is essential to prevent or eliminate a *food, drug, or cosmetic safety hazard* or reduce it to an acceptable level.

Critical Limit—the value(s) to which a biological, chemical or physical parameter must be controlled at a *CCP* to prevent, eliminate or reduce to an acceptable level the occurrence of a *food, drug, or cosmetic safety hazard*.

Db a—the actual or juridical person whose name and address appear on the label of a product as the responsible party for said product.

Deviation—a failure to meet a *critical limit*.

Device—includes all substances and preparations intended for use in diagnosis, treatment or prevention of disease in man or beast, or intended to affect the structure of any function of the body.

Drug—includes all substances and preparations recognized in the official compendium, as herein defined. It includes all substances and preparations intended for use in the diagnosis, treatment or prevention of disease in man or beast, and all substances and preparations, other than food and cosmetics, intended to affect the structure or any function of the body.

Factory—any establishment operating to manufacture, process, can, bottle, pack, or hold any food, drug or cosmetic unless covered by other specific provisions of this state sanitary code.

Food—includes all substances and preparations used for, or entering into the composition of food, drink, confectionery, chewing gum, condiment, for consumption by humans or other animals and includes water and alcoholic beverages.

Food Processing Plant—a commercial operation that manufactures *food* for human consumption and does not provide *food* directly to a consumer from that location. Such term shall not include a commercial operation that produces raw agricultural commodities and whose end product remains a raw agricultural product.

GMP—see *good manufacturing practices*.

Good Manufacturing Practices—practices, methods, and controls used in the manufacturing, processing, packing or holding of *foods, drugs or cosmetics* that comply with the requirements in this Part and for *foods*, with 21 CFR 110.10, 110.19, 110.20, 110.35, 110.37, 110.40, 110.80, and 110.93, to assure that *foods, drugs or cosmetics* for human

consumption or use are safe and have been prepared, packed and held under sanitary conditions.

HAACP—see *hazard analysis critical control point*.

HAACP Plan—the written document which is based upon the principles of *HACCP* and which delineates the procedures to be followed.

HACCP System—the implemented *HACCP plan* and *pre-requisite programs* including any other applicable requirements.

Hazard—a biological, chemical, radiological or physical agent that is reasonably likely to cause illness or injury in the absence of its *control*.

Hazard Analysis Critical Control Point (HAACP)—a systematic approach to the identification, evaluation and control of significant *food, drug, or cosmetic safety hazards*.

Label—the principal display or displays of written, printed or graphic matter upon any food, drug device, or cosmetic, or the immediate container, thereof, or upon the outside container or wrapper, if any, of the retail package of any food, drug, device or cosmetic.

Labeling—includes all labels and other written, printed and graphic matter in any form whatsoever, accompanying any food, drug, device or cosmetic.

LSPC—Louisiana State Plumbing Code, i.e., Part XIV (Plumbing) of this Code (LAC 51:XIV).

Manufacturing Confectionary—any establishment operating to manufacture any candy, either plain, chocolate or chocolate coated, mixed with nuts, fruits, or other fillers, covered with chocolate or other coatings and shaped, molded or formed in various shapes.

Medical Opinion—the opinion, within their respective fields, of the practitioners of any branch of the medical profession, the practice of which is licensed by law in this state.

Monitor—to conduct a planned sequence of observations or measurements to assess whether a *CCP* is under control or to assess the conditions and practices of all required *Pre-Requisite Programs (PPs)* and to produce an accurate record for future use in *verification*.

Offal—waste parts, especially of a butchered animal, including but not limited to bones, cartilage, fatty tissue and gristle.

Out-of-State Soft Drink—those items meeting the definition of *soft drink* in §1101.A of this Part and bearing a dba statement whose address is outside of the state of Louisiana.

Patent or Proprietary Medicine—trademarks, registered or unregistered, consisting of word or words, device, symbol, brand or logo which serves to designate the source or origin of the drug or drug product.

Plant—the building or buildings or plants thereof, used for or in connection with the manufacturing, processing, packaging, labeling, or holding of food products.

PP—see *Pre-Requisite Program*.

Pre-Requisite Program (PP)—procedures, including *good manufacturing practices*, that address operational conditions providing the foundation for the *HACCP system*.

Product Category—classification of products subject to registration into one of five groups: milk and dairy products (M), seafood products (S), other foods and beverages (F), drugs (D), cosmetics (C), or prophylactics (P). These categories are exclusive of items defined as *out-of-state soft drinks*.

Sanitize—adequate treatment of surfaces by a process that will destroy vegetative cells of pathogenic bacteria and will substantially reduce other microorganisms. Such treatment shall not adversely affect products and shall be safe and non-toxic.

Scientific Opinion—the opinion, within their respective fields, of competent pharmacologists, physiologists or toxicologists. [R.S. 40:602 (12)]

State Health Officer—the legally appointed or acting State Health Officer of the Department of Health and Hospitals having jurisdiction over the entire state of Louisiana, and includes his/her duly authorized representative in accordance with R.S. 40:4 and 40:5.

Validation—the element of *verification* focused on collecting and evaluating scientific and technical information to determine whether the *HACCP plan*, when properly implemented, will effectively control the *hazards*.

Verification—those activities, other than *monitoring*, that determine the validity of the *HACCP plan* and that the system is operating according to the plan.

AUTHORITY NOTE: The first source of authority for promulgation of the sanitary code is in R.S. 36:258(B), with more particular provisions found in Chapters 1 and 4 of Title 40 of the *Louisiana Revised Statutes*. This Part is promulgated in accordance with R.S. 40:4(A)(1)(a) and R.S. 40:5(2)(3)(5)(8)(15)(17)(19)(21). Also see R.S. 40:601 et seq.

HISTORICAL NOTE: Promulgated by the Department of Health and Hospitals, Office of Public Health, LR 28:1230 (June 2002), amended LR 36:2283 (October 2010), amended LR 38:2791 (November 2012), amended LR 40:1943 (October 2014).

§103. Permits **[formerly paragraph 6:002]**

A. No person shall manufacture, process, pack, or hold food within the state of Louisiana without a valid permit to operate, issued by the state health officer.

B. [formerly paragraph 6:003] A permit shall be issued upon receipt of an application which shall be made on a form provided for that purpose by the state health officer; provided that no permit shall be issued until an inspection has been made of the factory and it has been found to be operating in compliance with the provisions of these regulations. The permit fee for a person operating as soft drink manufacturers shall be assessed a permit fee established by R.S. 40:713.

C. [formerly paragraph 6:004] Any permit to operate, issued by the state health officer, may be suspended or revoked if the establishment is found to be operating

contrary to these regulations. The operation of such an establishment without a valid permit, or the continued operation after a permit has been revoked or suspended, shall constitute a violation of this code. Each day of noncompliance constitutes a separate violation.

D. [formerly paragraph 6:005] Permits to operate shall expire 12 months from the date of issue but may be renewed without inspection (if previous inspection within six months has shown them to be in compliance), on or before the expiration date; provided that any establishment shall be subject to inspection by the state health officer at any reasonable time during working hours.

E. [formerly paragraph 6:006] Permits shall be issued only to the person or persons responsible for the operations of the factory and shall not be transferable.

F. [formerly paragraph 6:007] No permit shall be issued to any individual to process in any way any filthy or contaminated food product to remove evidence of filth or contamination from the food in an attempt to recondition such material for human consumption; except where the process has been approved by the state health officer.

AUTHORITY NOTE: Promulgated in accordance with the provisions of R.S. 40:4(A)(1)(a). Also see R.S. 40:601 et seq.

HISTORICAL NOTE: Promulgated by the Department of Health and Hospitals, Office of Public Health, LR 28:1231 (June 2002).

§105. Registration of Foods, Drugs, Cosmetics and Prophylactic Devices
[formerly paragraph 6:008-1]

A. Registration Provisions. In accordance with the provisions of R.S. 40:627, all processed foods, proprietary or patent medicines, prophylactic devices and cosmetics, in package form, must be registered annually with the Louisiana Food and Drug Unit of the OPH/DHH. Application for registration may be accomplished by using the appropriate form supplied by the Food and Drug Unit.

B. [formerly paragraph 6:008-2] Application for Registration, Firm Name. Application for registration shall be made in the name of the firm appearing on the labels.

C. [formerly paragraph 6:008-3] Safety and Efficacy. Products containing new ingredients cannot be registered unless the application for registration includes sufficient evidence to prove that they have been properly tested and found to be safe and effective for use.

D. [formerly paragraph 6:008-4] Seizure. Foods, drugs, prophylactic devices and cosmetics not meeting the provisions of R.S. 40:601 et seq., shall be seized.

E. [formerly paragraph 6:008-5] Penalty. All firms shall apply for annual registration of their products. These certificates of registration expire 12 months from the date of issuance. Any applications received in the Food and Drug Control Unit Office more than 45 days after expiration of the previous certificate shall be assessed a late registration fee as stipulated in R.S. 40:627(D).

F. Product registration fees shall be assessed according to the following schedule:

1. for out-of-state soft drinks, according to the provisions of R.S. 40:716;

2. for all other products subject to registration requirements, a per product per dba per product category fee, up to the maximum allowed for under R.S. 40:628(B) per dba per product category.

G. For registration renewals, the provisions of Subsection F will be effective beginning with registrations having an expiration date of June 30, 2016.

AUTHORITY NOTE: Promulgated in accordance with R.S. 40:4(A)(1)(a), R.S. 40:5(2)(3)(5)(8)(15)(17)(19)(21), R.S. 40:628 and R.S. 40:716.

HISTORICAL NOTE: Promulgated by the Department of Health and Hospitals, Office of Public Health, LR 28:1231 (June 2002), amended LR 40:1943 (October 2014).

§107. Prohibited Equipment; Exception
[formerly paragraph 6:009-1]

A. The presence in a factory of any article of equipment, designed for processing filthy or contaminated foods in any way, whereby evidence of filth or contamination can be removed in whole or in part, is prohibited, except where such equipment is to be used in preparing such filthy or contaminated food for use in animal or stock feeds; or for other uses whereby the filthy or contaminated food cannot be diverted to use for human consumption; or where the process has been approved by the state health officer.

B. [formerly paragraph 6:009-2] When any such article of equipment is found in any food handling establishment or factory, except as provided above, it shall be prima facie evidence of intent to violate the State Food, Drug and Cosmetic Law (R.S. 40:601 et seq.), and there shall be affixed thereto, by the state health officer, a tag stating that such article is in violation of these regulations and the owner or operator of said equipment shall have it immediately removed from the establishment.

C. [formerly paragraph 6:009-3] No equipment so tagged shall again be used in connection with any food for human consumption, nor shall said tag be removed by any one other than the state health officer and then only after the article of equipment has been rendered unfit for further use, as evidenced by its dismantling.

AUTHORITY NOTE: Promulgated in accordance with the provisions of R.S. 40:4(A)(1)(a). Also see R.S. 40:601 et seq.

HISTORICAL NOTE: Promulgated by the Department of Health and Hospitals, Office of Public Health, LR 28:1232 (June 2002).

§109. Lighting/Ventilation, Plans Submission, Construction and Materials; Insect and Rodent Control; Sanitary Facilities
[formerly paragraph 6:010]

A. All factory buildings shall be well lighted with not less than 40 foot-candles on all working surfaces, and shall be well ventilated. In accordance with LAC 51:XIV.405.A.1.b, toilet rooms shall be provided with mechanical exhaust ventilation.

B. [formerly part of paragraph 6:011] Plans for new establishments shall be submitted to the state health officer for review and approval before construction.

C. [formerly part of paragraph 6:011] The manufacturing, processing, canning, bottling, packing or storage of any food intended for sale or distribution to the general public is prohibited in private residences or in buildings having direct openings to private residences.

D. [formerly paragraph 6:012] All floors, walls, ceilings, tables, and other fixtures shall be maintained in such a condition that they may be readily made clean and sanitary. This condition may be met by tables constructed entirely of either stainless steel or aluminum, and walls and ceilings constructed of marine plywood covered with a high solids epoxy paint. Fixtures and equipment meeting National Sanitation Foundation standards are also acceptable under this provision. If not in such condition they shall be promptly repaired and replaced. The floors of all rooms used for manufacturing shall be watertight and where there is necessity for drainage, shall have sufficient pitch to insure drainage. Floors may be constructed of cement or tile laid cement, or of any other materials impermeable to water. Portable or loose floor gratings shall be provided around blanchers, washers and other places where overflow is unavoidable.

E. [formerly paragraph 6:013] Walls, ceilings and other overhead coverings shall be tight and smooth; parts thereof not finished in tile, glazed, or other similar material shall be kept well painted with a light colored paint so that they may be easily cleaned whenever they become soiled or dirty.

F. [formerly paragraph 6:014] Windows, window ledges or any other places where dirt and dust may accumulate shall be kept clean.

G. [formerly paragraph 6:015] All fixtures, utensils or other apparatus used in the manufacture, handling or storing of foods shall be of material approved by the state health officer as to be easily cleanable and shall be kept clean.

H. [formerly paragraph 6:016] Factories shall be free of flies, rats, mice and other vermin. All insecticides or pesticides used in any room where foods are processed, prepared, packed or stored shall be of a type accepted by the state health officer. Insecticides shall be used and applied according to label directions on each container as required by the United States Environmental Protection Agency (or its successor) and the Louisiana Department of Agriculture.

I. [formerly paragraph 6:017] Every factory shall be provided with toilet and hand washing facilities as required by LAC 51:XIV.411, entitled "Minimum Plumbing Fixtures." Handwashing facilities shall be located convenient to all restrooms and food processing areas. Facilities shall be equipped with hot and cold water under pressure, delivered through a mixer faucet. Soap and sanitary towels or air dryer shall be provided at each lavatory.

J. [formerly paragraph 6:018] Every factory using brine or syrup shall be equipped with a room known as a syrup or

brine room in which all syrups or brines shall be mixed or compounded. Such syrup or brine room shall be separated from the other rooms of the factory and shall be well lighted, ventilated, and protected against insects and vermin.

AUTHORITY NOTE: Promulgated in accordance with provisions of R.S. 40:4(A)(1)(a). Also see 40:601 et seq.

HISTORICAL NOTE: Promulgated by the Department of Health and Hospitals, Office of Public Health, LR 28:1232 (June 2002), amended LR 38:2791 (November 2012).

§111. Premises—Drainage, Litter and Waste or Refuse, Weeds and Grass [formerly paragraph 6:019]

A. All grounds on which factories, warehouses and other buildings or structures used in connection with any food manufacturing plant are located, shall be properly graded to provide a natural drainage, thus preventing accumulation of stagnant water and other material.

B. [formerly paragraph 6:020] No litter, wastes or refuse shall be allowed to accumulate in or around the building or yards. Garbage and trash shall be removed from the premises as often as necessary, but not less than twice weekly so that it will not accumulate and provide a breeding and harborage area for rodents and insects.

C. [formerly paragraph 6:021] Weeds and grass surrounding and on plant grounds shall not exceed 6 inches in height. Ornamental shrubbery shall be trimmed and maintained so as not to foster harborage and breeding of rodents, insects or other vermin. Dusts of premises shall not exceed the following limits.

Fibrosis Producing and Nuisance Dusts	
Dusts	Particles per Cubic Foot of Atmosphere
Silica (SiO ₂)(Product of particles per cubic foot times per cent free silica, expressed as a decimal, not to exceed 5,000,000).	5,000,000 to 100,000,000
Compounds containing silicon (Si) such as talc, emery, and Carborundum.	50,000,000
Nuisance Dusts	100,000,000
No asbestos dust is acceptable.	

AUTHORITY NOTE: Promulgated in accordance with the provisions of R.S. 40:4(A)(1)(a). Also see R.S. 40:601 et seq.

HISTORICAL NOTE: Promulgated by the Department of Health and Hospitals, Office of Public Health, LR 28:1233 (June 2002).

§113. Water Supply—Ample Supply, Not Cross-Connected, Drinking Fountains [formerly paragraph 6:022]

A. An ample supply of potable water under pressure shall be provided on the premises for drinking, cleansing, washing or other purposes. Such water supply shall not be cross connected to any other supply. Water supply lines connected to plant equipment such as picking tables, bottle or can washers, cookers, retorts, or other utensils shall have the water lines properly installed or protected to prevent contamination of the water supply through back-siphonage or backflow.

B. [formerly paragraph 6:023] Drinking fountains shall be provided as required by LAC 51:XIV.411, entitled "Minimum Plumbing Fixtures." Drinking fountains shall meet the specifications as described in LAC 51:XIV.415.C or obtain approval of the state health officer.

AUTHORITY NOTE: Promulgated in accordance with provisions of R.S. 40:4(A)(1)(a). Also see 40:601 et seq.

HISTORICAL NOTE: Promulgated by the Department of Health and Hospitals, Office of Public Health, LR 28:1233 (June 2002), amended LR 38:2791 (November 2012).

§115. Machinery, Equipment and Utensils
[formerly paragraph 6:024]

A. All machinery, equipment, and utensils shall be so arranged as to be easily accessible for cleaning and shall be kept clean.

B. [formerly paragraph 6:025] An ample supply of steam, water, sanitizing agent, hoses, or other equipment necessary for proper cleaning of equipment shall be available. Hose ends or nozzles shall not be allowed to lie or rest on the floor but shall be hung or racked when not in use so as to be protected at all times from contamination. Faucets threaded for hoses shall be provided with vacuum breakers to prevent back-siphonage.

AUTHORITY NOTE: Promulgated in accordance with the provisions of R.S. 40:4(A)(1)(a). Also see R.S. 40:601 et seq.

HISTORICAL NOTE: Promulgated by the Department of Health and Hospitals, Office of Public Health, LR 28:1233 (June 2002).

§117. Containers
[formerly paragraph 6:026]

A. Containers to be filled with beverage shall be stored in tight containers on shelving so as to prevent contamination by dust, rodents, birds, insects or other vermin.

B. [formerly paragraph 6:027] Lofts or other storage areas in which containers are stored shall be kept free from accumulations of waste paper or other litter.

C. [formerly paragraph 6:028] Only non-toxic containers and closures shall be used. (Glass, high-density polyethylene, and polypropylene containers are examples which meet this requirement.) All containers and closures shall be sampled and inspected to ascertain that they are free from contamination. At least once each three months, a bacteriological swab and/or rinse count should be made from at least four containers and closures selected just prior to filling and sealing. No more than one of the four samples may exceed more than one bacteria per milliliter of capacity or one colony per square centimeter of surface area. All samples shall be free of coliform organisms. Tests shall be performed either by qualified plant personnel or a competent commercial laboratory.

AUTHORITY NOTE: Promulgated in accordance with the provisions of R.S. 40:4(A)(1)(a). Also see R.S. 40:601 et seq.

HISTORICAL NOTE: Promulgated by the Department of Health and Hospitals, Office of Public Health, LR 28:1233 (June 2002).

§119. Bottle Washers
[formerly paragraph 6:029]

A. Mechanical bottle washers shall be provided for sterilization of multi-use containers. Bottle washers shall sterilize containers as required by the State Second Hand Containers Law (R.S. 40:681 et seq.), and the regulations promulgated thereunder.

B. [formerly paragraph 6:030] Can washers and feeder lines shall be so arranged as to prevent the waste water from dripping on employees or dripping back into the cleaned cans or those filled with food products. Can washers with overhead devices shall be located in areas that are not designated employee work areas.

C. [formerly paragraph 6:031] If secondhand bottles or other containers are used, they shall be cleaned and sterilized in compliance with R.S. 40:681.

D. [formerly paragraph 6:032] Employee Health: The requirements of Part I, §117 and Part II, §§501-503.C shall be met.

AUTHORITY NOTE: Promulgated in accordance with the provisions of R.S. 40:4(A)(1)(a). Also see R.S. 40:601 et seq.

HISTORICAL NOTE: Promulgated by the Department of Health and Hospitals, Office of Public Health, LR 28:1233 (June 2002).

§121. By-Products and Waste Material
[formerly paragraph 6:033]

A. By-products to be used for ensilage should be put in silos, but if stacked in the open at the factory, a foundation of concrete or other impervious material shall be provided to prevent soil pollution.

B. [formerly paragraph 6:034] Drainage must be provided to take care of ensilage juices. Drains shall be of size and construction as specified in Table 725.A.1, "Building Drains and Sewers," of the LSPC.

C. [formerly paragraph 6:035] Cribbing shall be provided for all open stacks of refuse to ensure retention of the material on the foundation.

D. [formerly paragraph 6:036] All waste material such as waste peas, trimmings from vegetables and other waste products shall be separated from the waste or wash water and conveyed to silo or stacked or removed from the premises daily.

E. [formerly paragraph 6:037] Covered gutters or drains that can be easily cleaned and kept in efficient operating condition shall be provided within the building for collecting and conducting waste or wash water to a dump or drainage pit, which shall be provided with a suitable screen or separator for removing all coarse waste material from the water.

AUTHORITY NOTE: Promulgated in accordance with provisions of R.S. 40:4(A)(1)(a). Also see 40:601 et seq.

HISTORICAL NOTE: Promulgated by the Department of Health and Hospitals, Office of Public Health, LR 28:1234 (June 2002), amended LR 38:2791 (November 2012).

§123. Temperature Control
[formerly paragraph 6:038]

A. Foods requiring temperature control shall be held below 45°F or above 145°F, or in the case of frozen food, shall be held at or below 0°F.

AUTHORITY NOTE: Promulgated in accordance with the provisions of R.S. 40:4(A)(1)(a). Also see R.S. 40:601 et seq.

HISTORICAL NOTE: Promulgated by the Department of Health and Hospitals, Office of Public Health, LR 28:1234 (June 2002).

§125. Food Processing Plan

A. This Section shall become effective on January 1, 2011.

B. All food processing plants operating within the state of Louisiana shall maintain on-site a written food processing plan that shall be available for review upon request by the state health officer.

C. The food processing plan shall include, at a minimum, the following information:

1. a list of processing steps used to manufacture products, including potential biological, chemical, radiological or physical hazards that may be inherent to or introduced to the product at each step;

2. a description of preventative controls used in each step to control listed hazards;

3. a description of monitoring methods used to verify efficacy of preventative controls;

4. records of any corrective actions taken as a result of such monitoring; and

5. records of any amendments to the plan as a result of corrective actions.

D. Any food processing plant that currently holds and maintains a HACCP plan meeting the requirements of United States Department of Agriculture or Food and Drug Administration regulations shall be considered to be in compliance with this Section.

E. Any person or firm operating a food processing plant that violates the provisions of this Section shall be subject to a civil fine of not more than \$500.

AUTHORITY NOTE: Promulgated in accordance with R.S. 40:4(A)(1)(a), R.S. 40:5(2)(3)(5)(8)(15)(17)(19)(21) and R.S. 40:652.

HISTORICAL NOTE: Promulgated by the Department of Health and Hospitals, Office of Public Health, LR 36:2284 (October 2010).

§127. Food Recall Plan

A. This Section shall become effective on January 1, 2011.

B. General. All food processing plants operating within the state of Louisiana shall maintain a written food recall plan that shall be available for review upon request by the state health officer. The owners and operators shall amend

their written food recall plan with any recommendations deemed necessary by the state health officer to make such plan effective for food safety concerns.

C. Notification. The food recall plan shall include, at a minimum, the provision for notification of representatives of the Food and Drug Unit of the Office of Public Health of the Department of Health and Hospitals. In addition, for any products subject to recall that may have been involved in interstate commerce, the food recall plan shall have additional provisions to notify the Food and Drug Administration. Notification shall include, at a minimum, the following information:

1. the identity of the product(s) under recall, including name and lot number or batch code;

2. the reason for the recall;

3. the date and means of discovery of the reason for the recall;

4. total amount of product and amount estimated to be in distribution;

5. list of consignees that have or may have received affected product;

6. contact information for a responsible person at the firm who will oversee the recall; and

7. proposed strategy for conducting the recall.

D. Suppliers and Consignees. The food processing plant shall maintain a current list of suppliers and consignees for all ingredients and finished goods used in the manufacturing or distribution of the firm's products. Such list(s) shall be available for review by the state health officer.

E. Communication with the Public. The food recall plan shall include the proposed mode(s) of public communication including, as necessary, telephone, letter, website, and media outlet (newspaper, television, radio, and/or other sources) notifications.

F. Level(s) of Recall. The food recall plan shall include a method or procedure for evaluating whether the recall needs to be conducted at the wholesale, retail, or consumer levels, or if some combination is appropriate.

G. Effectiveness Checks. The food recall plan shall include provisions for conducting effectiveness checks, at the appropriate level(s) as determined necessary in Subsection F of this Section, by means of telephone interviews, site visits, or other effective means of communication.

H. Post Recall Evaluation. The food recall plan shall require a re-evaluation of all elements of the recall plan after a recall has been conducted to correct deficiencies or enhance overall effectiveness.

I. Nothing in this Section shall prevent the state health officer from exercising his authority to protect the public from adulterated or misbranded products by seizure and/or destruction of defective products in accordance with R.S. 40:632 and §105.D of this Chapter.

J. Any person or firm operating a food processing plant that violates the provisions of this Section shall be subject to a civil fine of not more than \$500.

AUTHORITY NOTE: Promulgated in accordance with R.S. 40: 4(A)(1)(a), R.S. 40:5(2)(3)(5)(8)(15)(17)(19)(21) and R.S. 40: 653.

HISTORICAL NOTE: Promulgated by the Department of Health and Hospitals, Office of Public Health, LR 36:2284 (October 2010).

§129. Laboratory Test Reporting Requirements and Additional Test Mandate

A. When a person or firm operating a food processing plant in the state of Louisiana receives information from an in-house or external laboratory analyzing samples or specimens of finished foods or finished ingredients which indicates a confirmed positive test result signifying that the food or ingredient may be adulterated (in accordance with the definitions provided in R.S. 40:607, et seq.) or may otherwise constitute an imminent health hazard, the person or firm shall report this confirmed positive test result to representatives of the Food and Drug Unit of the Office of Public Health of the Department of Health and Hospitals within 24 hours of obtaining such information.

B. The state health officer may, based upon a demonstration of probable cause by the Department of Health and Hospitals indicating that a food processing plant is producing food which may be adulterated (in accordance with the definitions provided in R.S. 40:607 et seq.) or in such a manner as to cause an imminent health hazard, order the food processing plant to submit samples to a laboratory specified by the department for testing at the food processing facility's expense. A copy of the written or electronic results of such testing, including a reference to test methods used, shall be furnished by the food processing plant or by the laboratory to the department as soon as a confirmed test result (either positive or negative) is available but no later than 24 hours of obtaining such information.

C. Any person or firm operating a food processing plant that violates the provisions of this Section shall be subject to a civil fine of not more than \$1,000.

AUTHORITY NOTE: Promulgated in accordance with R.S. 40: 4(A)(1)(a), R.S. 40:5(2)(3)(5)(8)(15)(17)(19)(21) and R.S. 40: 654.

HISTORICAL NOTE: Promulgated by the Department of Health and Hospitals, Office of Public Health, LR 36:2284 (October 2010).

Chapter 3. Current Good Manufacturing Practices in Manufacturing, Processing, Packing or Holding Human Food

§301. General Provisions; Code of Federal Regulations [formerly paragraph 6:039]

A. The Criteria in 21 CFR 117 Subpart A, Subpart B and Subpart F (Code of Federal Regulations) shall apply in determining whether the facilities, methods, practices, and controls used in the manufacturing, processing, packing or

holding of food are in conformance with or are operated or administered in conformity with good manufacturing practices to assure that food for human consumption is safe and has been prepared, packed and held under sanitary conditions.

B. In accordance with R.S. 3:1468, facilities producing industrial hemp-derived cannabidiol products intended for human consumption will be inspected under the provisions of this Chapter.

AUTHORITY NOTE: Promulgated in accordance with the provisions of R.S. 40:4(A)(1)(a). Also see R.S. 40:601 et seq., and R.S. 3:1482(J).

HISTORICAL NOTE: Promulgated by the Department of Health and Hospitals, Office of Public Health, LR 28:1234 (June 2002), amended by the Department of Health, Office of Public Health, LR 46:360 (March 2020).

§303. Definitions [formerly paragraph 6:040]

A. Unless otherwise specifically provided herein, the following words and terms used in this Part of the sanitary code and all other Parts which are adopted or may be adopted, are defined for the purposes thereof as follows.

Adequate—shall be explained in each case in which it is used.

Plant—see Chapter 1, §101 of this Part.

Sanitize—see Chapter 1, §101 of this Part.

AUTHORITY NOTE: Promulgated in accordance with the provisions of R.S. 40:4(A)(1)(a). Also see R.S. 40:601 et seq.

HISTORICAL NOTE: Promulgated by the Department of Health and Hospitals, Office of Public Health, LR 28:1234 (June 2002).

§305. Requirements Affecting Employees; Personnel [formerly paragraph 6:041]

A. The plant management shall take all reasonable measures and precautions to assure the following.

B. [formerly paragraph 6:042] Disease Control. Employees shall meet the requirements of Part I, §117 of this Code.

C. [formerly paragraph 6:043] Cleanliness. All persons, while working in direct contact with food preparation, food ingredients, or surfaces coming into contact therewith shall comply with the following Paragraphs in this Section.

1. [formerly paragraph 6:044] Wear clean outer garments, maintain personal cleanliness, and conform to hygienic practices (as defined in the following regulations) while on duty, to the extent necessary to prevent contamination of food products.

2. [formerly paragraph 6:045] Thoroughly wash their hands and the exposed portions of their arms with soap and warm water before starting work, during work as often as is necessary to keep them clean, and after smoking, eating, drinking, or using the toilet. Employees shall keep their fingernails clean and trimmed.

3. [formerly paragraph 6:046] Remove all insecure jewelry and, during periods where food is manipulated by

hand, remove from hands any jewelry that cannot be adequately sanitized.

4. [formerly paragraph 6:047] If gloves are used in food handling, maintain them in an intact, clean and sanitary condition. Smooth impermeable gloves can be used in such operations as sandwich preparation or other indirect food contact. Leather or cloth type gloves shall not be used in direct food contact.

5. [formerly paragraph 6:048] Wear hair nets, headbands, caps, or other effective hair restraints.

6. [formerly paragraph 6:049] No store clothing or other personal belongings, eat food or drink beverages, or use tobacco in any form in areas where food or food ingredients are exposed or in areas used for washing equipment or utensils.

7. [formerly paragraph 6:050] Take any other necessary precautions to prevent contamination of foods with microorganisms or foreign substances including, but not limited to, perspiration, hair, cosmetics, tobacco, chemicals, and medications.

AUTHORITY NOTE: Promulgated in accordance with the provisions of R.S. 40:4(A)(1)(a). Also see R.S. 40:601 et seq.

HISTORICAL NOTE: Promulgated by the Department of Health and Hospitals, Office of Public Health, LR 28:1234 (June 2002).

§307. Education and Training **[formerly paragraph 6:051]**

A. Personnel responsible for identifying sanitation failures or food contamination should have a background of education or experience, or a combination thereof, to provide a level of competency necessary for production of clean and safe food. Food handlers and supervisors should receive appropriate training in proper food handling techniques and food protection principles and should be cognizant to the danger of poor personal hygiene and insanitary practices.

AUTHORITY NOTE: Promulgated in accordance with the provisions of R.S. 40:4(A)(1)(a). Also see R.S. 40:601 et seq.

HISTORICAL NOTE: Promulgated by the Department of Health and Hospitals, Office of Public Health, LR 28:1235 (June 2002).

§309. Supervision of Personnel **[formerly paragraph 6:052]**

A. Responsibility for assuring compliance by all personnel with all requirements of this Part shall be clearly assigned to competent supervisory personnel.

AUTHORITY NOTE: Promulgated in accordance with the provisions of R.S. 40:4(A)(1)(a). Also see R.S. 40:601 et seq.

HISTORICAL NOTE: Promulgated by the Department of Health and Hospitals, Office of Public Health, LR 28:1235 (June 2002).

§311. Plants and Grounds **[formerly paragraph 6:053]**

A. The grounds about a food plant under the control of the operator shall be free from conditions which may result

in the contamination of food including, but not limited to, the following Paragraphs in this Section.

1. [formerly paragraph 6:054] Improperly stored equipment, litter, waste, refuse, and uncut weeds or grass within the immediate vicinity of the plant buildings or structures that may constitute an attractant, breeding place, or harborage for rodents, insects, and other pests. For example, unused equipment shall not be stored in the yard; grass shall not be allowed to grow over 6 inches in height; garbage, refuse, litter, waste, etc., cannot be stored in uncovered containers or in bags.

2. [formerly paragraph 6:055] Excessively dusty roads, yards, or parking lots that may constitute a source of contamination in areas where food is exposed.

3. [formerly paragraph 6:056] Inadequately drained areas that may contribute contamination to food products through seepage or food-borne filth and by providing a breeding place for insects or microorganisms.

a. If the plant grounds are bordered by grounds not under the operator's control of the kind described in §311.A.1-3 of this Chapter, care must be exercised in the plant by inspection, extermination, or other means to effect exclusion of pests, dirt, and other filth that may be a source of food contamination.

AUTHORITY NOTE: Promulgated in accordance with the provisions of R.S. 40:4(A)(1)(a). Also see R.S. 40:601 et seq.

HISTORICAL NOTE: Promulgated by the Department of Health and Hospitals, Office of Public Health, LR 28:1235 (June 2002).

§313. Plant Construction and Design **[formerly paragraph 6:057]**

A. Plant buildings and structures shall be suitable in size, construction, and design to facilitate maintenance and sanitary operations for food-processing purposes. The plant and facilities shall comply with the following paragraphs.

1. [formerly paragraph 6:058] Provide sufficient space for such placement of equipment and storage of materials as is necessary for sanitary operations and production of safe food. Floors, walls, and ceilings in the plant shall be of such construction as to be readily cleanable and shall be kept clean and in good repair. Fixtures, ducts, and pipes that drip or produce condensate may contaminate foods, raw materials or food-contact surfaces, and shall not be suspended over working areas. Aisles or working spaces between equipment and walls shall be unobstructed and of sufficient width to permit employees to perform their duties without contamination of food or food contact surfaces with clothing or personal contact.

2. [formerly paragraph 6:059] Provide separation by partition, location, or other effective means for those operations which may cause contamination of food products with undesirable microorganisms, chemicals, filth or other extraneous material.

3. [formerly paragraph 6:060] Provide at least 40 foot-candles of lighting to hand washing areas, dressing and locker rooms, and toilet rooms and to all areas where

food or food ingredients are examined, processed, or stored and where equipment and utensils are cleaned. Light bulbs, fixtures, skylights, or other glass suspended over exposed food in any step of preparation shall be of the safety type or otherwise protected to prevent food contamination in case of breakage.

4. [formerly paragraph 6:061] Provide adequate ventilation or control equipment to minimize odors and noxious fumes or vapors (including steam) in areas where they may contaminate food. Such ventilation or control equipment shall not create conditions that may contribute to food contamination by airborne contaminants.

5. [formerly paragraph 6:062] Provide, where necessary, effective screening or other protection against birds, animals, and vermin (including, but not limited to, insects and rodents).

AUTHORITY NOTE: Promulgated in accordance with the provisions of R.S. 40:4(A)(1)(a). Also see R.S. 40:601 et seq.

HISTORICAL NOTE: Promulgated by the Department of Health and Hospitals, Office of Public Health, LR 28:1235 (June 2002).

§315. Sanitary Facilities and Controls **[formerly paragraph 6:063]**

A. Each plant shall be equipped with adequate sanitary facilities and accommodations including, but not limited to, the following Paragraphs in this Section.

1. [formerly paragraph 6:064] Water Supply. The water supply shall be sufficient for the operations intended and shall be derived from a potable source. Any water that contacts foods or food contact surfaces shall be safe and of sanitary quality. Running water at a suitable temperature and under pressure as needed shall be provided in all areas where the processing of food, the cleaning of equipment, utensils, or containers, or employee sanitary facilities require.

2. [formerly paragraph 6:065] Sewage Disposal. Sewage disposal shall be made into a sewerage system or by other means approved by the state health officer.

AUTHORITY NOTE: Promulgated in accordance with the provisions of R.S. 40:4(A)(1)(a). Also see R.S. 40:601 et seq.

HISTORICAL NOTE: Promulgated by the Department of Health and Hospitals, Office of Public Health, LR 28:1235 (June 2002).

§317. Plumbing **[formerly paragraph 6:066]**

A. Plumbing shall be of size and design and installed and maintained according to Part XIV of this Code.

B. [formerly paragraph 6:067] Plumbing shall also meet the following requirements:

1. [formerly paragraph 6:067-1] carry sufficient quantities of water to required locations throughout the plant;

2. [formerly paragraph 6:067-2] properly convey sewage and liquid disposable water from the plant;

3. [formerly paragraph 6:067-3] not constitute a source of contamination to foods, food products or ingredients, water supplies, equipment, or utensils or create an insanitary condition;

4. [formerly paragraph 6:067-4] provide adequate floor drainage in all areas where floors are subject to flooding-type cleaning or where normal operations release discharge water or other liquid waste on the floor.

AUTHORITY NOTE: Promulgated in accordance with the provisions of R.S. 40:4(A)(1)(a). Also see R.S. 40:601 et seq.

HISTORICAL NOTE: Promulgated by the Department of Health and Hospitals, Office of Public Health, LR 28:1236 (June 2002).

§319. Toilet Facilities **[formerly paragraph 6:068]**

A. Each plant shall provide its employees with toilet and associated hand washing facilities within the plant according to requirements of LAC 51:XIV.411 and each toilet shall be furnished with toilet tissue. The facilities shall be maintained in a sanitary condition and kept in good repair at all times. Doors to toilet rooms shall be self-closing and shall not open directly into areas where food is exposed to airborne contamination except where alternate means have been taken to prevent such contamination (such as double doors, positive air flow systems, etc.). Signs shall be posted directing employees to wash their hands with cleaning soap or detergents after using the toilet.

AUTHORITY NOTE: Promulgated in accordance with the provisions of R.S. 40:4(A)(1)(a). Also see 40:601 et seq.

HISTORICAL NOTE: Promulgated by the Department of Health and Hospitals, Office of Public Health, LR 28:1236 (June 2002), amended LR 38:2791 (November 2012).

§321. Hand Washing Facilities **[formerly paragraph 6:069]**

A. Facilities for hand washing and, where appropriate, sanitizing solution shall be provided at each location in the plant where good sanitary practices require employees to wash or sanitize and dry their hands, and at least in areas where foods are handled. Numbers of lavatories shall be provided as required in LAC 51:XIV.411. Such facilities shall be furnished with running water at a suitable temperature for hand washing, effective hand cleaning and sanitizing preparations, sanitary towel service or suitable drying devices, and, where appropriate, easily cleanable waste receptacles.

AUTHORITY NOTE: Promulgated in accordance with the provisions of R.S. 40:4(A)(1)(a). Also see R.S. 40:601 et seq.

HISTORICAL NOTE: Promulgated by the Department of Health and Hospitals, Office of Public Health, LR 28:1236 (June 2002), amended LR 38:2791 (November 2012).

§323. Rubbish and Offal Disposal **[formerly paragraph 6:070]**

A. Rubbish and any offal shall be so conveyed, stored, and disposed of as to minimize the development of odor, prevent waste from becoming an attractant and harborage or breeding place for vermin, and prevent contamination of

food, food contact surfaces, ground surfaces, and water supplies.

AUTHORITY NOTE: Promulgated in accordance with the provisions of R.S. 40:4(A)(1)(a). Also see R.S. 40:601 et seq.

HISTORICAL NOTE: Promulgated by the Department of Health and Hospitals, Office of Public Health, LR 28:1236 (June 2002).

§325. Sanitary Operations—General Maintenance
[formerly paragraph 6:071]

A. All buildings, fixtures, and other physical facilities of the plant shall be kept in good repair and shall be maintained in a sanitary condition.

B. [formerly a part of paragraph 6:071] Cleaning operations shall be conducted in such a manner as to minimize the danger of contamination of food and food-contact surfaces. (For example, floors shall be sprinkled to hold down dust prior to sweeping operations.)

C. [formerly a part of Paragraph 6:071] Detergents, sanitizers, and other supplies employed in cleaning and sanitizing procedures shall be free of significant microbiological contamination and shall be safe and effective for their intended uses. Only such toxic materials as are required to maintain sanitary conditions, for use in laboratory testing procedures, for plant and equipment maintenance and operation, or in manufacturing or processing operations shall be used or stored in the plant. These materials shall be identified and used only in such manner and under conditions as will be safe for their intended uses.

AUTHORITY NOTE: Promulgated in accordance with the provisions of R.S. 40:4(A)(1)(a). Also see R.S. 40:601 et seq.

HISTORICAL NOTE: Promulgated by the Department of Health and Hospitals, Office of Public Health, LR 28:1236 (June 2002).

§327. Animal, Vermin and Pest Control
[formerly paragraph 6:072]

A. No animals or birds, other than those essential as raw material, shall be allowed in any area of a food plant. Measures shall be taken to exclude pests from the processing areas and to protect against the contamination of foods in or on the premises by animals, birds, and vermin (including, but not limited to, rodents and insects). The use of insecticides or rodenticides is permitted only under such precautions and restrictions as will prevent the contamination of food or packaging materials with illegal residues. Insecticides and rodenticides shall be used and applied according to label directions on each container as required by the United States Environmental Protection Agency or its successor.

AUTHORITY NOTE: Promulgated in accordance with the provisions of R.S. 40:4(A)(1)(a). Also see R.S. 40:601 et seq.

HISTORICAL NOTE: Promulgated by the Department of Health and Hospitals, Office of Public Health, LR 28:1236 (June 2002).

§329. Sanitation of Equipment and Utensils
[formerly paragraph 6:073]

A. All utensils and food contact surfaces of equipment shall be cleaned as frequently as necessary to prevent contamination of food and food products. Non-food contact surfaces of equipment used in the operation of food plants shall be cleaned as frequently as necessary to minimize accumulation of dust, dirt, food particles, and other debris. Single-service articles (such as utensils intended for one-time use, paper cups, paper towels, etc.) shall be stored in appropriate containers and handled, dispensed, used and disposed of in a manner that prevents contamination of food or food contact surfaces. Where necessary to prevent the introduction of undesirable microbiological organisms into food products, all utensils and product contact surfaces of equipment used in the plant shall be cleaned and sanitized prior to such use and following any interruption during which such utensils and contact surfaces may have become contaminated.

B. [formerly a part of paragraph 6:073] Where such equipment and utensils are used in continuous production operation, the contact surfaces of such equipment and utensils shall be cleaned and sanitized on a predetermined schedule using effective methods for cleaning and sanitizing. Sanitizing agents shall be effective and safe under conditions of use. Any facility, procedure, machine, or device may be acceptable for cleaning and sanitizing equipment utensils if it is established that such facility, procedure, machine, or device will routinely render equipment and utensils clean and provide adequate sanitizing treatment.

AUTHORITY NOTE: Promulgated in accordance with the provisions of R.S. 40:4(A)(1)(a). Also see R.S. 40:601 et seq.

HISTORICAL NOTE: Promulgated by the Department of Health and Hospitals, Office of Public Health, LR 28:1237 (June 2002).

§331. Storage and Handling of
Equipment and Utensils
[formerly paragraph 6:074]

A. Storage and handling of cleaned portable equipment and utensils with product contact surfaces should be stored in such a location and manner that product contact surfaces are protected from splash, dust, and other contamination.

AUTHORITY NOTE: Promulgated in accordance with the provisions of R.S. 40:4(A)(1)(a). Also see R.S. 40:601 et seq.

HISTORICAL NOTE: Promulgated by the Department of Health and Hospitals, Office of Public Health, LR 28:1237 (June 2002).

§333. Equipment and Procedures—General
[formerly paragraph 6:075]

- A. All plant equipment and utensils shall be:
1. suitable for their intended use;
 2. so designed and of such material and workmanship as to be easily cleanable; and
 3. properly maintained.

B. The design, construction, and use of such equipment and utensils shall preclude the adulteration of food with

lubricants, fuel, metal fragments, contaminated water, or any other contaminants. All equipment shall be so installed and maintained as to facilitate the cleaning of the equipment and of all adjacent spaces.

AUTHORITY NOTE: Promulgated in accordance with the provisions of R.S. 40:4(A)(1)(a). Also see R.S. 40:601 et seq.

HISTORICAL NOTE: Promulgated by the Department of Health and Hospitals, Office of Public Health, LR 28:1237 (June 2002).

§335. Use of Polychlorinated Biphenyls (PCB) in Food Plants
[formerly paragraph 6:076]

A. Polychlorinated biphenyls (PCB's) represent a class of toxic industrial chemicals manufactured and sold under a variety of trade names, including: Aroclor (United States); Phenoclor (France); Colohen (Germany); and Kanaclor (Japan). PCB's are highly stable, heat resistant, and nonflammable chemicals. Industrial uses of PCB's include, or did include in the past, their use as electrical transformer and capacitor fluids, heat transfer fluids, hydraulic fluids, and plasticizers, and in formulations of lubricants, coatings, and inks. Their unique physical and chemical properties, and widespread, uncontrolled industrial applications, have caused PCB's to be a persistent and ubiquitous contaminant in the environment which may cause the contamination of certain foods. In addition, incidents have occurred in which PCB's have directly contaminated animal feeds as a result of industrial accidents (leakage or spillage of PCB's fluids from plant equipment). These accidents in turn cause the contamination of food intended for human consumption (meat, milk, and eggs).

B. Since PCB's are toxic chemicals, the PCB contamination of food as a result of these accidents represents a hazard to human health. It is therefore necessary to place certain restrictions on the industrial uses of PCB's in the production, handling, and storage of food.

1. [formerly a part of paragraph 6:076] New equipment, utensils, and machinery for handling or processing food in or around a food plant shall not contain PCB's so as to preclude accidental PCB contamination of food.

AUTHORITY NOTE: Promulgated in accordance with the provisions of R.S. 40:4(A)(1)(a). Also see R.S. 40:601 et seq.

HISTORICAL NOTE: Promulgated by the Department of Health and Hospitals, Office of Public Health, LR 28:1237 (June 2002).

§337. Management and Abatement of PCB within Food Plants
[formerly paragraph 6:077]

A. The management of food plants shall meet the following requirements:

1. [formerly paragraph 6:077-1] have the heat exchange fluid used in existing equipment or machinery for handling of processing food sampled and tested to determine whether it contains PCB's, or verify the absence of PCB's in such formulations by other appropriate means. Any such

fluid formulated with PCB's shall be replaced with a heat exchange fluid that does not contain PCB's;

2. [formerly paragraph 6:077-2] eliminate from the food plant any PCB contact surfaces of equipment or utensils and any PCB containing lubricants for equipment or machinery that is used for handling or processing foods;

3. [formerly paragraph 6:077-3] eliminate from the food plant any other PCB containing materials wherever such materials could cause food to become contaminated with PCB's either as a result of use of or as a result of accident, breakage, or other mishap.

AUTHORITY NOTE: Promulgated in accordance with the provisions of R.S. 40:4 (A) (1) (a). Also see R.S. 40:601 et seq.

HISTORICAL NOTE: Promulgated by the Department of Health and Hospitals, Office of Public Health, LR 28:1237 (June 2002).

§339. Toxicity of PCB Replacement Fluids
[formerly paragraph 6:078]

A. The toxicity and other characteristics of fluids selected as PCB replacements shall be adequately determined so that the least potentially hazardous replacement is used. In making this determination with respect to a given fluid, consideration should be given to: (a) its toxicity; (b) the maximum quantity that could be spilled onto a given quantity of food before it would be noticed, taking into account its color and odor; (c) possible signaling devices in the equipment to indicate a loss of fluid, etc; and (d) its environmental stability and tendency to survive and be concentrated through the food chain. The judgment as to whether a replacement fluid is sufficiently nonhazardous is to be made on an individual installation and operation basis.

1. [formerly paragraph 6:079] For the purposes of this Section, the provisions do not apply to electrical transformers and condensers containing PCB's in sealed containers.

AUTHORITY NOTE: Promulgated in accordance with the provisions of R.S. 40:4(A)(1)(a). Also see R.S. 40:601 et seq.

HISTORICAL NOTE: Promulgated by the Department of Health and Hospitals, Office of Public Health, LR 28:1238 (June 2002).

Chapter 5. Bakeries and Manufacturing Confectioneries

§501. Definitions
[formerly paragraph 6:080]

A. Unless otherwise specifically provided herein, the following words and terms used in this Part of the sanitary code and all other Parts which are adopted or may be adopted, are defined for the purposes thereof as follows.

Bakery—see Chapter 1, §101 of this Part of this Code.

Manufacturing Confectionery—see Chapter 1, §101 of this Part of this Code.

AUTHORITY NOTE: Promulgated in accordance with the provisions of R.S. 40:4(A)(1)(a). Also see R.S. 40:601 et seq.

HISTORICAL NOTE: Promulgated by the Department of Health and Hospitals, Office of Public Health, LR 28:1238 (June 2002).

§503. Required Permits
[formerly paragraph 6:081]

A. Bakeries and manufacturing confectioneries shall have a permit from the state health officer, in accordance with the provisions of Chapter 1, §103 of this Part of this Code.

AUTHORITY NOTE: Promulgated in accordance with the provisions of R.S. 40:4(A)(1)(a). Also see R.S. 40:601 et seq.

HISTORICAL NOTE: Promulgated by the Department of Health and Hospitals, Office of Public Health, LR 28:1238 (June 2002).

§505. Building Construction Requirements
[formerly paragraph 6:082]

A. Any building used or maintained as a bakery or manufacturing confectionery shall comply with the following requirements in this Section.

1. [formerly paragraph 6:083] Adequate plans and specifications for new establishments shall be submitted to the state health officer for approval before construction. Plans for establishments to sell only at retail shall be submitted to the local health unit.

2. [formerly paragraph 6:083-1] Floors shall be constructed with concrete, tile, glazed brick or other impervious materials sloped to drain quickly and effectively so that they may be easily cleaned. All drains shall be trapped.

3. [formerly paragraph 6:083-2] Walls and ceilings shall be smooth, tight, impervious and light colored and shall be kept clean.

4. [formerly paragraph 6:083-3] All outside openings shall be protected against flies and other vermin.

5. [formerly paragraph 6:083-4] Any bakery or manufacturing confectionery maintaining or operating a retail salesroom in connection therewith, shall provide a separate room for such retail operations and only personnel engaged in the manufacture, baking, cooking, molding or otherwise preparing bakery or confectionery products shall be permitted in the processing area except on permission from the management; provided, any duly authorized representative of the state health officer shall have access during reasonable working hours to make inspections and to collect samples for examination to determine whether the products sampled are adulterated, misbranded or otherwise manufactured, packed, prepared or held in violation of the sanitary code, or of the State Food, Drug and Cosmetic Law (R.S. 40:601 et seq.).

6. [formerly paragraph 6:083.5] All rooms shall be well lighted, either naturally and/or artificially, and shall be well ventilated. A minimum of 40 foot-candles shall be provided for all work surfaces. When necessary to prevent accumulations of smoke, fumes heat or odors, forced draft ventilation shall be provided.

7. [formerly paragraph 6:083-6] A supply of potable water shall be available. Running hot and cold water delivered through a mixer faucet shall be required in amounts sufficient to give an abundance of water for all cleaning operations in and about the establishment. No cross-connection between the potable water supply and any unapproved water supply or any sewage disposal system shall be permitted.

8. [formerly paragraph 6:083-7] The building shall be constructed so as to exclude rats, mice, roaches or other vermin. Domestic pets shall be excluded in any part of the establishment.

9. [formerly paragraph 6:083-8] A locker room, separate from the food preparation rooms, shall be provided for employees.

10. [formerly paragraph 6:083-9] Storage space separate from preparation and manufacturing areas shall be provided for all raw ingredients, packing boxes or other goods to be used in the manufacture, storage, packing or preparation of any food product. Storage space shall be rodent and vermin proof and so constructed and maintained as to permit easy fumigation, fogging, crack and crevice treatment and other established methods of pest control.

AUTHORITY NOTE: Promulgated in accordance with the provisions of R.S. 40:4(A)(1)(a). Also see R.S. 40:601 et seq.

HISTORICAL NOTE: Promulgated by the Department of Health and Hospitals, Office of Public Health, LR 28:1238 (June 2002).

§507. Equipment
[formerly paragraph 6:084]

A. All equipment used or connected in any way with the manufacture, baking, cooking or other processing, handling, packing or storing of any bakery or confectionery product shall comply with the following:

1. [formerly paragraph 6:084-1] be maintained in a clean and sanitary manner, be free from cracks and wherever possible, be of non-corroding, metal or other smooth, impervious material giving an easily cleanable surface. Stationary or not readily movable equipment shall be so installed as to provide for easy cleaning;

2. [formerly paragraph 6:084.2] refrigeration shall be provided so that all perishable food products used in the manufacturer processing of any kind connected with the production, distribution or sale of bakery or confectionery products shall be maintained at a temperature not to exceed 45°F;

3. [formerly paragraph 6:084-3] adequate show or display cases shall be provided so that no bakery or confectionery product shall be openly exposed;

4. [formerly paragraph 6:084-4] sinks, adequate in size to clean the largest piece of movable equipment, and sufficient in number for washing, rinsing and sanitizing of utensils used in and around the establishment shall be provided. Sinks shall be of three compartment construction;

5. [formerly paragraph 6:084-5] equipment too large to permit washing in the sinks shall be cleaned in a manner approved by the state health officer;

6. [formerly paragraph 6:084-6] all barrels, boxes, tubs, pails, kneading troughs, machines, racks, pans or other receptacles used for holding materials from which bakery or confectionery products are manufactured shall be kept clean and sanitary and shall be so constructed as to be easily cleanable;

7. [formerly paragraph 6:084-7] all food contact surfaces shall be cleaned and sanitized after each day's production.

AUTHORITY NOTE: Promulgated in accordance with the provisions of R.S. 40:4(A)(1)(a). Also see R.S. 40:601 et seq.

HISTORICAL NOTE: Promulgated by the Department of Health and Hospitals, Office of Public Health, LR 28:1239 (June 2002).

§509. General Provisions; Time/Temperature Controls for Preparation of Fresh Custard and Cream Fillings
[formerly paragraph 6:085]

A. Supplies used in the manufacture of bakery and confectionery products shall be stored outside of the preparation areas or rooms. flour, sugar and other similar products shall be protected from dampness and vermin. All ingredients shall be stored on racks or shelves at least 6 inches off the floor, and so arranged as to permit cleaning around and under the containers. No spoiled, rancid or unwholesome ingredients of any type shall be used in the manufacture of any bakery or confectionery product, nor shall such material be permitted to remain in such a manufacturing plant.

B. [formerly paragraph 6:086] No box, paper, trash, furniture or other article not used in the preparation of any bakery or confectionery product shall be allowed in food preparation rooms, nor shall an accumulation of boxes, rubbish, trash or waste be permitted about the establishment, nor shall any slops of waste matter be thrown or emptied on the ground about the premises. Garbage shall be kept in water tight receptacles with tightly fitting lids. Garbage and trash shall be removed from the premises as often as necessary so that it will not accumulate and provide a breeding and harborage area for rodents and insects.

C. [formerly paragraph 6:087] Every bakery or manufacturing confectionery shall provide toilet facilities for employees as required by LAC 51:XIV.411. All toilet rooms shall have at least 20 foot-candles of lighting and, in accordance with LAC 51:XIV.405.A.1.b, mechanical exhaust ventilation. Toilet rooms shall be kept clean and in good repair.

D. [formerly paragraph 6:088] Lavatory (hand washing) facilities shall be provided in all restrooms in accordance with LAC 51:XIV.411 and an additional lavatory/lavatories shall be conveniently located in each of the food processing and handling areas. Facilities shall be equipped with hot and cold water under pressure, delivered through a mixer faucet.

Soap and sanitary towels or air dryer shall be provided at each lavatory.

E. [formerly paragraph 6:089] All employees of any bakery or manufacturing confectionery shall comply with §§305-309 of Chapter 3 of this Part.

F. [formerly paragraph 6:090] No bed or cot shall be permitted in any bakery or manufacturing confectionery, nor shall any living quarters open directly into the preparation rooms of such establishments.

G. [formerly paragraph 6:091] No bakery or confectionery product shall be delivered to any retailer by placing such products in a box or other receptacle located outside of the retail establishment, unless this receptacle has been approved by the state health officer.

H. [formerly paragraph 6:092] Only pasteurized milk or milk products shall be used in the preparation of custard and cream-filled bakery products.

I. [formerly paragraph 6:093] All custard or cream-filled mixtures shall be cooked, the temperature and time of heating of the mix, to be as a minimum, the equivalent of a temperature of 145°F for a period of not less than 30 minutes.

J. [formerly paragraph 6:094] Upon completion of the cooking of the mix, it shall be immediately transferred into previously sanitized containers, properly covered and chilled as rapidly as possible to 45°F or below and maintained at such a temperature until used.

K. [formerly paragraph 6:095] The apparatus and food contact surfaces used in adding any custard or cream filling to a bakery product shall be of impervious material and shall be thoroughly cleaned and sanitized after each use, in a manner approved by the state health officer. No cloth filled bags shall be used.

L. [formerly paragraph 6:096] Employees engaged in the preparation of custard or cream-filled bakery products shall not touch the custard or cream filling with their hands after it has been cooked.

M. [formerly paragraph 6:097] No pastry containing a custard or cream filling shall be displayed in any window or show case except those that are refrigerated or chilled to a temperature of 45°F, or below.

N. [formerly paragraph 6:098] Pastries containing custard or cream filling shall not be sold or delivered from vehicles, except where such vehicles are equipped with a refrigerated compartment where the temperature is maintained at 45°F or below; provided, however, that such pastries may be delivered from manufacturers to retail dealers or consumers by special trip without refrigeration when it is possible to complete such delivery within two hours elapsed time.

O. [formerly paragraph 6:099] All bakery products in package form shall be labeled in compliance with the State Food, Drug and Cosmetic Law, as provided for in R.S. 40:608.

P. [formerly paragraph 6:100] Transportation of any bread, pastry or confectionery product for subsequent display or sale is prohibited unless said bread, pastry or confectionery product is wrapped or packaged in such a manner as to protect the product from contamination by dust, dirt, flies and other extraneous material.

AUTHORITY NOTE: Promulgated in accordance with provisions of R.S. 40:4(A)(1)(a). Also see 40:601 et seq.

HISTORICAL NOTE: Promulgated by the Department of Health and Hospitals, Office of Public Health, LR 28:1239 (June 2002), amended LR 38:2792 (November 2012).

§511. Premises
[formerly paragraph 6:101]

A. Building premises, shipping and receiving areas, etc., shall be kept clean, orderly and free of debris, trash and high weeds.

B. [formerly paragraph 6:102] The ground area outside the shipping and receiving doors and other passageways shall be paved and sloped to allow for proper drainage.

C. [formerly paragraph 6:103] The ground area for storage of covered trash cans and/or compactor type trash containers shall be paved and sloped for adequate drainage. A conveniently located hose bib shall be provided for washdown of this area.

AUTHORITY NOTE: Promulgated in accordance with the provisions of R.S. 40:4(A)(1)(a). Also see R.S. 40:601 et seq.

HISTORICAL NOTE: Promulgated by the Department of Health and Hospitals, Office of Public Health, LR 28:1240 (June 2002).

Chapter 7. Food Storage Warehouse and Food Salvaging Operations

§701. Definitions
[formerly paragraph 6:110]

A. Unless otherwise specifically provided herein, the following words and terms used in this Part of the sanitary code, and all other Parts which are adopted or may be adopted, are defined for the purposes thereof as follows.

Food Storage Warehouse—as used in these regulations shall mean any establishment that stores, delivers, receives or ships a food product for further distribution.

Salvager—as used in these regulations shall mean any person or firm that stores, receives, ships or delivers food products for the purpose of salvaging them by means of sorting, repacking or any other means after said products have been misbranded and/or adulterated or damaged as described in the Louisiana Food, Drug and Cosmetic Law (R.S. 40:601 et seq.).

AUTHORITY NOTE: Promulgated in accordance with the provisions of R.S. 40:4(A)(1)(a). Also see R.S. 40:601 et seq.

HISTORICAL NOTE: Promulgated by the Department of Health and Hospitals, Office of Public Health, LR 28:1240 (June 2002).

§703. Permits
[formerly paragraph 6:111]

A. Food storage warehouses and food salvaging operations shall obtain permits from the state health officer, in accordance with the provisions of §103 of Chapter 1 of this Part.

AUTHORITY NOTE: Promulgated in accordance with the provisions of R.S. 40:4(A)(1)(a). Also see R.S. 40:601 et seq.

HISTORICAL NOTE: Promulgated by the Department of Health and Hospitals, Office of Public Health, LR 28:1240 (June 2002).

§705. Building Construction
[formerly paragraph 6:112]

A. The storage and/or salvaging of any food intended for sale or distribution to the general public is prohibited in private residences or in buildings having direct opening to private residences. All establishment buildings shall be well lighted and ventilated.

B. [formerly paragraph 6:113] Floors, walls and ceilings shall be constructed in accordance with §313 of Chapter 3 of this Part so as to be easily cleanable.

C. [formerly paragraph 6:114] All insecticides or pesticides used in any room where foods packaged, repackaged, stored or salvaged shall be approved by the state health officer. All insecticides and pesticides shall be used and applied according to label directions specified as required by the United States Environmental Protection Agency or its successor.

D. [formerly paragraph 6:115] Every warehouse and salvaging operation shall be provided with toilet and hand washing facilities for employees as required by LAC 51:XIV.411, titled "Minimum Plumbing Fixtures". Hand washing facilities shall be located convenient to all toilet facilities. Facilities shall be equipped with hot and cold water under pressure, delivered through a mixer faucet. Soap and sanitary towels or air dryer shall be provided at each lavatory. These facilities shall be kept clean. Toilet room doors shall be self-closing.

E. [formerly paragraph 6:116] Buildings shall be constructed and maintained to prevent access to rodents, insects (e.g., roaches), birds and other vermin.

AUTHORITY NOTE: Promulgated in accordance with provisions of R.S. 40:4(A)(1)(a). Also see 40:601 et seq.

HISTORICAL NOTE: Promulgated by the Department of Health and Hospitals, Office of Public Health, LR 28:1240 (June 2002), amended LR 38:2792 (November 2012).

§707. Premises
[formerly paragraph 6:117]

A. All grounds on which warehouses and other buildings or structures used in connection with any food storage and/or salvaging are located shall be graded to provide natural drainage, thus preventing accumulation of stagnant water and other material.

B. [formerly paragraph 6:118] No litter, waste or refuse shall be allowed to accumulate in or around the buildings or

yards. Waste shall be removed daily or disposed of promptly and in a manner approved by the state health officer. Ground areas designated for waste storage shall be paved, sloped for drainage and be provided with washdown facilities.

C. [formerly paragraph 6:119] Weeds and grass shall be kept cut to eliminate rodent and vermin harborage. Mud and dust shall be controlled on the premises.

AUTHORITY NOTE: Promulgated in accordance with the provisions of R.S. 40:4(A)(1)(a). Also see R.S. 40:601 et seq.

HISTORICAL NOTE: Promulgated by the Department of Health and Hospitals, Office of Public Health, LR 28:1240 (June 2002).

§709. Water Supply
[formerly paragraph 6:120]

A. The potable water supply shall meet requirements of Chapter 6, entitled "Water Supply and Distribution," of the LSPC. Such water supply shall not be cross-connected to any other supply.

B. [formerly paragraph 6:121] Drinking fountains shall be provided as required by LAC 51:XIV.411, entitled "Minimum Plumbing Fixtures." Drinking fountains shall meet specifications as described in Part XVII, §107.B of this Code and meet with the approval of the state health officer.

AUTHORITY NOTE: Promulgated in accordance with provisions of R.S. 40:4(A)(1)(a). Also see 40:601 et seq.

HISTORICAL NOTE: Promulgated by the Department of Health and Hospitals, Office of Public Health, LR 28:1240 (June 2002), amended LR 38:2792 (November 2012).

§711. Employee Health
[formerly paragraph 6:122]

A. The requirements of Part I, §117, Part II, §§501-503.C and Part VI, §§305-309 shall be met.

AUTHORITY NOTE: Promulgated in accordance with the provisions of R.S. 40:4(A)(1)(a). Also see R.S. 40:601 et seq.

HISTORICAL NOTE: Promulgated by the Department of Health and Hospitals, Office of Public Health, LR 28:1241 (June 2002).

§713. Operational Requirements
[formerly paragraph 6:123]

A. [formerly paragraph 6:124] It shall be the responsibility of management to develop and maintain in employees an interest of "good housekeeping" and encourage personal cleanliness.

B. [formerly paragraph 6:125] All incoming foods shall be examined for defilement, infestation or damage. A morgue area shall be provided for the placement of damaged commodities. Defiled or infested commodities shall be disposed of immediately.

C. [formerly paragraph 6:126] Foods shall be stored at least 18" from walls or other obstructions to permit inspection and cleaning. Foods shall also be stored at least 6 inches above the floor level. Pallets and shelving shall be kept clean.

D. [formerly paragraph 6:127] Stock shall be rotated on a "first in, first out" basis.

E. [formerly paragraph 6:128] Hazardous chemicals shall not be used or stored near foods.

AUTHORITY NOTE: Promulgated in accordance with the provisions of R.S. 40:4(A)(1)(a). Also see R.S. 40:601 et seq.

HISTORICAL NOTE: Promulgated by the Department of Health and Hospitals, Office of Public Health, LR 28:1241 (June 2002).

§715. Salvaged Food Package Labeling Requirements
[formerly paragraph 6:129]

A. The label of any food that has been salvaged as defined in §701 of this Part of this Code, shall comply with the requirements of R.S. 40:608 and the following provisions.

1. [formerly paragraph 6:129-1] The term *salvaged* shall appear on the principal display panel in the case of any food packaged in a firm container (box, carton or can) and either on the principal display panel or upon a firmly attached tag in the case of any food packaged in a soft container (bag or sack). The "principal display panel" is that panel of a product label bearing the product name and quantity of contents statement. The labeling requirements shall only apply to the individual immediate container in which the food is packaged for retail or institutional sale and shall only apply to the food containers actually requiring salvage activities. The term *salvaged* shall be conspicuous and of easily legible bold face print or type in distinct contrast to other matter on the label.

2. [formerly paragraph 6:129-2] In the event the salvager is other than an agent for the original manufacturer, packer, or distributor, the name and business address of the salvager shall appear in the manner and location prescribed in §715.A.1 of this Part and shall include the city, state and zip code.

AUTHORITY NOTE: Promulgated in accordance with the provisions of R.S. 40:4(A)(1)(a). Also see R.S. 40:601 et seq.

HISTORICAL NOTE: Promulgated by the Department of Health and Hospitals, Office of Public Health, LR 28:1241 (June 2002).

§717. Salvaged Food Bulk Placard Requirements
[formerly paragraph 6:130]

A. If in bulk display form for wholesale or retail sale (rather than package form), any food that has been salvaged, shall be conspicuously and prominently displayed immediately adjacent to such bulk display. Such placard shall be in easily legible bold face print or type of such color contrast that it may be easily read and shall contain the statements required by §715 of this Part of this Code.

AUTHORITY NOTE: Promulgated in accordance with the provisions of R.S. 40:4(A)(1)(a). Also see R.S. 40:601 et seq.

HISTORICAL NOTE: Promulgated by the Department of Health and Hospitals, Office of Public Health, LR 28:1241 (June 2002).

§719. Salvaged Food Labeling Responsibility
[formerly paragraph 6:131]

A. The responsibility for the salvage labeling required by §§715-717 of this Part shall be that of:

1. [formerly paragraph 6:131-1] the person selling or offering to sell such food at wholesale or retail (if in bulk display form);

2. [formerly paragraph 6:131-2] the person selling or offering to sell at retail or for institutional use (if salvaged within the state of Louisiana); or

3. [formerly paragraph 6:131-3] the first person selling or offering to sell such food at wholesale or retail within the state of Louisiana (if salvaged outside of the state of Louisiana).

AUTHORITY NOTE: Promulgated in accordance with the provisions of R.S. 40:4(A)(1)(a). Also see R.S. 40:601 et seq.

HISTORICAL NOTE: Promulgated by the Department of Health and Hospitals, Office of Public Health, LR 28:1241 (June 2002).

Chapter 9. Processing and Bottling of Bottled Drinking Water

§901. Definitions [formerly paragraph 6:132]

A. Unless otherwise specifically provided herein, the following words and terms used in this Part of the sanitary code, and all other Parts which are adopted or may be adopted, are defined for the purposes thereof as follows.

Approved Source—when used in reference to a plant's product water or operations water means that the source of the water and the water therefrom, whether it be from a spring, artesian well, drilled well, municipal water supply, or any other source, shall have been inspected and the water sampled, analyzed and found to be of a safe and sanitary quality by the state health officer in accordance with the applicable laws and regulations of the government agency or agencies having jurisdiction. The presence, in the plant, of current certificates or notifications of approval from the government agency or agencies having jurisdiction shall constitute approval of the source and the water supply.

Bottled Water—water that is intended for human consumption and that is sealed in bottles or other containers with no added ingredients except that it may optionally contain safe and suitable antimicrobial agents. Fluoride may be optionally added within the limitations established in 21 CFR §165.110(b)(4)(ii). Bottled water may be used as an ingredient in beverages (e.g., diluted juices, flavored bottled waters). It does not include those food ingredients that are declared in ingredient labeling as "water," "carbonated water," "disinfected water," "filtered water," "seltzer water," "soda water," "sparkling water," and "tonic water." The processing and bottling of bottled water shall comply with regulations specified in this Section of this Chapter.

Lot—a collection of primary containers or unit packages of any same size, type, and style produced under conditions as nearly uniform as possible and designated by a common container code or marking.

Multi-Service-Containers—containers intended for use more than one time.

Nontoxic Materials—materials for product water contact surfaces utilized in the transporting, processing, storing, and packaging of bottled drinking water, which are free of substances which may render the water injurious to health or which may adversely affect the flavor, color, odor, or bacteriological quality of the water.

Operations Water—water which is delivered under pressure to a plant for container washing, hand washing, plant and equipment cleanup and for other sanitary purposes.

Primary Container—the immediate container in which the product water is packaged.

Product Water—processed water used by a plant for bottled drinking water.

Shipping Case—a container in which one or more primary containers of the product are held.

Single-Service-Container—a container intended for one time usage only.

Unit Package—a standard commercial package of bottled drinking water, which may consist of one or more containers.

AUTHORITY NOTE: Promulgated in accordance with the provisions of R.S. 40:4(A)(1)(a). Also see R.S. 40:601 et seq.

HISTORICAL NOTE: Promulgated by the Department of Health and Hospitals, Office of Public Health, LR 28:1241 (June 2002).

§903. Bottled Drinking Water Permits [formerly paragraph 6:132-1]

A. Processors and bottlers of bottled drinking water shall obtain permits from the state health officer, in accordance with the provisions of Chapter 1 of this Part.

AUTHORITY NOTE: Promulgated in accordance with the provisions of R.S. 40:4(A)(1)(a). Also see R.S. 40:601 et seq.

HISTORICAL NOTE: Promulgated by the Department of Health and Hospitals, Office of Public Health, LR 28:1242 (June 2002).

§905. Bottled Water for Emergencies [formerly paragraph 6:132-2]

A. Bottled water processed and packaged strictly for the purpose of providing a source of potable drinking water in anticipation of, or during, an emergency such as the aftermath of disasters from severe storms, hurricanes, floods, etc., shall comply with the provisions of this Section of this Chapter unless otherwise specified.

B. [formerly paragraph 6:132-3] Bottled water for emergencies from outside of state. Bottlers, processors, distributors, or dealers of bottled water processed and packaged outside of this state strictly for the purpose of providing a source of potable drinking water in anticipation of, or during, an emergency such as the aftermath of disasters from severe storms, hurricanes, floods, etc., shall show evidence to the state health officer, or his/her duly authorized representative, of compliance with the requirements for processing, packing, and distribution of

bottled water in that state, county, or local authority having jurisdiction.

AUTHORITY NOTE: Promulgated in accordance with the provisions of R.S. 40:4(A)(1)(a). Also see R.S. 40:601 et seq.

HISTORICAL NOTE: Promulgated by the Department of Health and Hospitals, Office of Public Health, LR 28:1242 (June 2002).

§907. Water Bottling Plant Construction and Design
[formerly paragraph 6:133-1]

A. The bottling room shall be separated from other plant operations or storage areas by tight walls, ceilings, and self-closing doors to protect against contamination. Conveyor openings shall not exceed the size required to permit passage of containers.

B. [formerly paragraph 6:133-2] If processing operations are conducted in other than a sealed system under pressure, protection shall be provided to preclude contamination of the water and the system.

C. [formerly paragraph 6:133-3] Ventilation shall be provided in accordance with §313.A.4 of this Part and shall minimize condensation in processing rooms, bottling rooms, and container washing and sanitizing areas.

D. [formerly paragraph 6:133-4] The washing and sanitizing of containers for bottled drinking water shall be performed in an enclosed room. The washing and sanitizing operation shall be positioned within the room so as to minimize any possible post-sanitizing contamination of the containers before they enter the bottling room.

E. [formerly paragraph 6:133-5] Rooms in which product water is handled, processed, or held or in which containers, utensils, or equipment are washed or held shall not open directly into any room for domestic household purposes.

AUTHORITY NOTE: Promulgated in accordance with the provisions of R.S. 40:4(A)(1)(a). Also see R.S. 40:601 et seq.

HISTORICAL NOTE: Promulgated by the Department of Health and Hospitals, Office of Public Health, LR 28:1242 (June 2002).

§909. Product and Operation Water Supplies; Sanitary Facilities
[formerly paragraph 6:134]

A. Each plant shall provide sanitary facilities including, but not limited to, the following.

1. [formerly paragraph 6:134-1] Product Water and Operations Water

a. [formerly paragraph 6:134-1 (1)] Product Water. The product water supply shall be from an approved source and comply with Chapter 9 of this Part entitled "Processing and Bottling of Bottled Drinking Water."

b. [formerly paragraph 6:134-1 (2)] Operations Water. If different from the product water supply, the operations water supply shall be obtained from an approved source properly located, protected, and operated and shall be easily accessible, adequate, and of a safe, sanitary quality which shall be in conformance at all times with the

applicable laws and regulations of the government agency or agencies having jurisdiction.

c. [formerly paragraph 6:134-1 (3)] Product Water and Operations Water from Approved Sources

i. Water samples shall be taken from approved sources by the plant at a minimum frequency of twice each year with an interval between samples of not less than five months nor more than seven months to assure that the supply is in conformance with the applicable standards, laws, and regulations of the government agency or agencies having jurisdiction. The sampling and analysis shall be by plant personnel trained in sampling and analysis of water samples. Records of both government agency approval of the water source and the sampling and analysis performed by the plant shall be maintained on file at the plant.

ii. Test and sample methods shall be approved by government agency or agencies having jurisdiction over the approval of the water source, and shall be consistent with the minimum requirements set forth in Part XII of this Code.

iii. Analysis of the samples may be performed for the plant by commercial laboratories.

2. [formerly paragraph 6:134-2] Air under Pressure. Whenever air under pressure is directed at product water or a product water contact surface, it shall be free of oil, dust, rust, excessive moisture, and extraneous materials; shall not affect the bacteriological quality of the water; and shall not adversely affect the flavor, color, or odor of the water.

3. [formerly paragraph 6:134-3] Locker and Lunchrooms. When employee locker and lunchrooms are provided, they shall be separate from plant operations and storage areas and shall be equipped with self-closing doors. The rooms shall be maintained in a clean and sanitary condition and refuse containers shall be provided. Packaging or wrapping material or other processing supplies shall not be stored in locker or lunchrooms.

AUTHORITY NOTE: Promulgated in accordance with the provisions of R.S. 40:4(A)(1)(a). Also see R.S. 40:601 et seq.

HISTORICAL NOTE: Promulgated by the Department of Health and Hospitals, Office of Public Health, LR 28:1242 (June 2002).

§911. Cleaning and Sanitizing
[formerly paragraph 6:135-1]

A. The product water contact surfaces of all multi-service containers, utensils, pipes, and equipment used in the transportation, processing, handling, and storage of product water shall be cleaned and sanitized. All product water contact surfaces shall be inspected by plant personnel as often as necessary to maintain the sanitary condition of such surfaces and to assure they are kept free of scale, evidence of oxidation, and other residue. The presence of any unsanitary condition, scale, residue, or oxidation shall be immediately remedied by cleaning and sanitizing of that product water contact surface prior to use.

1. [formerly paragraph 6:135-2] After sanitizing all multi-service containers, utensils, and disassembled piping and equipment shall be transported and stored in such a

manner as to assure drainage and shall be protected from contamination.

2. [formerly paragraph 6:135-3] Single-service containers and caps or seals shall be purchased and stored in sanitary closures and kept clean therein in a clean, dry place until used. Prior to use they shall be examined, and as necessary, washed, rinsed, and sanitized and shall be handled in a sanitary manner.

3. [formerly paragraph 6:135-4] Filling, capping, closing, sealing and packaging of containers shall be done in a sanitary manner so as to preclude contamination of the bottled drinking water. For example, hand filling and capping of containers shall be prohibited. Mechanical equipment shall be provided for this purpose.

AUTHORITY NOTE: Promulgated in accordance with the provisions of R.S. 40:4(A)(1)(a). Also see R.S. 40:601 et seq.

HISTORICAL NOTE: Promulgated by the Department of Health and Hospitals, Office of Public Health, LR 28:1243 (June 2002).

§913. Suitability of Equipment and Procedures
[formerly paragraph 6:136-1(1)]

A. All plant equipment and utensils shall be suitable for their intended use. This includes all collection and storage tanks, piping, fittings, connections, bottle washers, fillers, cappers, and other equipment which may be used to store, handle, process, package, or transport product water.

B. [formerly paragraph 6:136-1 (2)] All product water contact surfaces shall be constructed of nontoxic and nonabsorbent material which can be cleaned and sanitized and is in compliance with Chapter 11 of this Part—Soft Drink Manufacturing.

C. [formerly paragraph 6:136-2] Design. Storage tanks shall be of the type that can be closed to exclude all foreign matter and shall be vented.

AUTHORITY NOTE: Promulgated in accordance with the provisions of R.S. 40:4(A)(1)(a). Also see R.S. 40:601 et seq.

HISTORICAL NOTE: Promulgated by the Department of Health and Hospitals, Office of Public Health, LR 28:1243 (June 2002).

§915. Product Water Treatment Process
[formerly paragraph 6:137-1(A)]

A. All treatment of product water by distillation, ion-exchanging filtration, ultraviolet treatment, reverse osmosis, carbonation, mineral addition, or any other process shall be effective in accomplishing its intended purpose and in accordance with R.S. 40:607(3) of the State Food, Drug and Cosmetic Law. All such processes shall be performed in and by equipment and with substances which will not adulterate the bottled product. A record of the type and date of physical inspections of such equipment, conditions found, and performance and effectiveness of such equipment, shall be maintained by the plant. Product water samples shall be taken after processing and prior to bottling by the plant and analyzed as often as is necessary to assure uniformity and effectiveness of the processes performed by the plant. The

methods of analysis shall be those approved by the government agency or agencies having jurisdiction.

AUTHORITY NOTE: Promulgated in accordance with the provisions of R.S. 40:4(A)(1)(a). Also see R.S. 40:601 et seq.

HISTORICAL NOTE: Promulgated by the Department of Health and Hospitals, Office of Public Health, LR 28:1243 (June 2002).

§917. Treatment Process of Product
Water for Emergencies
[formerly paragraph 6:137-1(B)]

A. Product water intended for bottling for use during emergencies shall contain a minimum of 0.2 ppm free chlorine residual prior to bottling or, shall be treated as specified in §915 of this Chapter.

AUTHORITY NOTE: Promulgated in accordance with the provisions of R.S. 40:4(A)(1)(a). Also see R.S. 40:601 et seq.

HISTORICAL NOTE: Promulgated by the Department of Health and Hospitals, Office of Public Health, LR 28:1244 (June 2002).

§919. Multi-Service Containers
[formerly paragraph 6:137-2(1)]

A. Multi-service primary containers shall be cleaned, sanitized, and inspected just prior to being filled, capped, and sealed. Containers found to be unsanitary or defective by the inspection shall be reprocessed or discarded. All multi-service primary containers shall be washed, rinsed, and sanitized by mechanical washers or by any other method giving sanitary results. Mechanical washers shall be inspected as often as is necessary to assure dependable performance. Records of physical maintenance, inspections and conditions found, and performance of the mechanical washer shall be maintained by the plant.

B. [formerly paragraph 6:137-2(2)] Multi-service shipping cases shall be maintained in such condition as to assure they will not contaminate the primary container or the product water. Dry or wet cleaning procedures shall be performed as often as necessary to maintain the cases in a sanitary condition.

C. [formerly paragraph 6:137-2(3)] Bottled water that is processed and packaged exclusively for emergency use shall include the following labeling information in addition to any other required labeling information.

1. [formerly paragraph 6:137-2(3)(a)] Bottled water for emergencies may be named "Bottled Water" or "Drinking Water" followed immediately by "for Emergency Use Only, Not for Re-Sale."

2. [formerly paragraph 6:137-2(3)(b)] Each unit container shall include a "Use by date" with the date not to exceed 60 days from the date of bottling.

3. [formerly paragraph 6:137-2(3)(c)] The information required in §919.C.1-2 shall be of the same print size and style.

AUTHORITY NOTE: Promulgated in accordance with the provisions of R.S. 40:4(A)(1)(a). Also see R.S. 40:601 et seq.

HISTORICAL NOTE: Promulgated by the Department of Health and Hospitals, Office of Public Health, LR 28:1244 (June 2002).

§921. Cleaning and Sanitizing Solutions
[formerly paragraph 6:137-3]

A. Cleaning and sanitizing solutions utilized by the plant shall be sampled and tested by the plant as often as is necessary to assure dependable performance in the cleaning and sanitizing operations. Records of these tests shall be maintained by the plant.

AUTHORITY NOTE: Promulgated in accordance with the provisions of R.S. 40:4(A)(1)(a). Also see R.S. 40:601 et seq.

HISTORICAL NOTE: Promulgated by the Department of Health and Hospitals, Office of Public Health, LR 28:1244 (June 2002).

§923. Sanitizing Operations
[formerly paragraph 6:137-4]

A. All product water contact surfaces shall be sanitized by chemical means, circulation of live steam or hot water. The plant should maintain a record of the intensity of the sanitizing agent and the time duration that the agent was in contact with the surface being sanitized. The following times and intensity shall be considered a minimum:

1. [formerly paragraph 6:137-4(1)] live steam in enclosed system: at least 170°F for at least 15 minutes or at least 200°F for at least five minutes;

2. [formerly paragraph 6:137-4(2)] hot water in enclosed system: At least 170°F for at least 15 minutes or at least 200°F for at least five minutes;

3. [formerly paragraph 6:137-4(3)] chemical sanitizers shall be equivalent in bactericidal action to a two-minute exposure of 50 parts per million of available chlorine at or above 57°F when used as an immersion or circulating solution. Chemical sanitizers applied as a spray or fog shall have as a minimum 100 parts per million of available chlorine at or above 57°F or its equivalent in bactericidal action;

4. [formerly paragraph 6:137-4 (4)] 0.1 part per million ozone water solution in an enclosed system for at least five minutes;

5. [formerly paragraph 6:137-4 (5)] when containers are sanitized using a substance other than one provided for in 21 CFR 178.1010 of the Code of Federal Regulations, such substance shall be removed from the surface of the container by a rinsing procedure. The final rinse, prior to filling the container with product water, shall be performed with a disinfected water rinse free of pathogenic bacteria or by an additional sanitizing procedure equivalent in bactericidal action to that required in §923.A.3.

AUTHORITY NOTE: Promulgated in accordance with the provisions of R.S. 40:4(A)(1)(a). Also see R.S. 40:601 et seq.

HISTORICAL NOTE: Promulgated by the Department of Health and Hospitals, Office of Public Health, LR 28:1244 (June 2002).

§925. Production Code; Unit Package
[formerly paragraph 6:137-5]

A. Each unit package from a batch or segment of a continuous production run of bottled drinking water shall be identified by a production code. The production code shall identify a particular batch or segment of a continuous production run and the day produced. The plant shall record and maintain information as to the kind of product, volume produced, date produced, lot code use, and the distribution of the finished product to wholesale and retail outlets.

AUTHORITY NOTE: Promulgated in accordance with the provisions of R.S. 40:4(A)(1)(a). Also see R.S. 40:601 et seq.

HISTORICAL NOTE: Promulgated by the Department of Health and Hospitals, Office of Public Health, LR 28:1244 (June 2002).

§927. Filling, Capping, or Sealing; Container Testing Requirements
[formerly paragraph 6:137-6]

A. During the process of filling, capping or sealing either single-service or multi-service containers, the performance of the filler, capper or sealer shall be monitored and the filled containers, visually or electronically inspected to assure they are sound, properly capped or sealed, and coded and labeled. Containers which are not satisfactory shall be reprocessed or rejected. Only nontoxic containers and closures shall be used. All containers and closures shall be sampled and inspected to ascertain that they are free from contamination. At least once each three months, a bacteriological swab and/or rinse count should be made from at least four containers and closures selected just prior to filling and sealing. No more than one of the four samples may exceed more than one bacteria per milliliter of capacity or one colony per square centimeter of surface area. All samples shall be free of coliform organisms. The procedure and apparatus for these bacteriological tests shall be in conformance with those recognized by the government agency or agencies having jurisdiction. Tests shall be performed either by plant personnel trained in sampling and analysis of water samples or by a commercial laboratory.

AUTHORITY NOTE: Promulgated in accordance with the provisions of R.S. 40:4(A)(1)(a). Also see R.S. 40:601 et seq.

HISTORICAL NOTE: Promulgated by the Department of Health and Hospitals, Office of Public Health, LR 28:1244 (June 2002).

§929. Product Testing Requirements
[formerly paragraph 6:137-7]

A. To assure that the plant's production of bottled drinking water is in compliance with the State Food Drug and Cosmetic Law (R.S. 40:601 et seq.) and this code, the plant shall:

1. [formerly paragraph 6:137-7 (1)] for bacteriological purposes take and analyze at least once a week a sample from a batch or segment of a continuous production run for each type of bottled drinking water produced during a day's production. The samples shall consist of primary containers of product or unit packages of product;

2. [formerly paragraph 6:137-7 (2)] for chemical, physical, and radiological purposes, take and analyze at least semi-annually a representative sampling from a batch or segment of a continuous production run for each type of bottled drinking water produced during a day's production. The representative sample shall consist of primary containers of product or unit packages of product;

3. [formerly paragraph 6:137-7 (3)] analyze such samples by methods approved by the government agency or agencies having jurisdiction. The plant shall maintain records of date of sampling, type of product sampled, production code, and results of the analysis.

AUTHORITY NOTE: Promulgated in accordance with the provisions of R.S. 40:4(A)(1)(a). Also see R.S. 40:601 et seq.

HISTORICAL NOTE: Promulgated by the Department of Health and Hospitals, Office of Public Health, LR 28:1245 (June 2002).

§931. Record Retention
[formerly paragraph 6:137-8]

A. All records required by 21 CFR 129.1, 21 CFR 129.20, 21 CFR 129.35, 21 CFR 129.37, 21 CFR 129.40, and 21 CFR 129.80 of the Code of Federal Regulations shall be maintained at the plant for not less than two years. Plants shall also retain, on file at the plant, current certificates or notifications of approval issued by the state health officer and other government agencies, (if any) approving the plant's source and supply of product water and operations water. All required documents shall be available for official review at reasonable times.

AUTHORITY NOTE: Promulgated in accordance with the provisions of R.S. 40:4(A)(1)(a). Also see R.S. 40:601 et seq.

HISTORICAL NOTE: Promulgated by the Department of Health and Hospitals, Office of Public Health, LR 28:1245 (June 2002).

Chapter 11. Soft Drink Manufacturing

§1101. Definitions
[formerly paragraph 6:138]

A. The definitions and interpretations contained in the State Food, Drug and Cosmetic Law (R.S. 40:601 et seq.) are applicable to the following words and terms. Unless otherwise specifically provided herein, the following words and terms used in this Part of the sanitary code, and all other Parts which are adopted or may be adopted, are defined for the purposes thereof as follows.

Adequate—that which is needed to accomplish the intended purpose in keeping with good public health practice.

Plant—the building or buildings or part thereof, used for or in connection with the manufacturing, processing, labeling or holding of human food.

Sanitize—see §101 of Chapter 1 of this Part.

Soft Drink—the class of non-alcoholic beverages usually, but not necessarily, made by absorbing carbon dioxide in potable water. The amount of carbon dioxide used is not less than that which will be absorbed by the beverage

at a pressure of one atmosphere and at a temperature of 60°F. It either contains no alcohol or only such alcohol, not in excess of 0.5 percent by weight of the finished beverage as is contributed by the flavoring ingredient used. Soft drinks may contain any safe and suitable optional ingredients, including natural and artificial flavors as provided for in the food additives statutes—21 USC 409 and/or the Code of Federal Regulations 21 CFR 170.

AUTHORITY NOTE: Promulgated in accordance with the provisions of R.S. 40:4(A)(1)(a). Also see R.S. 40:601 et seq.

HISTORICAL NOTE: Promulgated by the Department of Health and Hospitals, Office of Public Health, LR 28:1245 (June 2002).

§1103. Location and Use of Building
[formerly paragraph 6:139]

A. The building, or portion thereof, employed for the manufacture of soft drinks shall be used for no other purpose, and shall be so located as to be protected from objectionable surroundings, such as hazardous waste dumps, dusty conditions, rodent harborage areas, sanitary landfills, poorly drained areas, etc.

AUTHORITY NOTE: Promulgated in accordance with the provisions of R.S. 40:4(A)(1)(a). Also see R.S. 40:601 et seq.

HISTORICAL NOTE: Promulgated by the Department of Health and Hospitals, Office of Public Health, LR 28:1245 (June 2002).

§1105. Plans Review
[formerly paragraph 6:140]

A. Plans for new establishments shall be submitted to the state health officer for approval before construction.

AUTHORITY NOTE: Promulgated in accordance with the provisions of R.S. 40:4(A)(1)(a). Also see R.S. 40:601 et seq.

HISTORICAL NOTE: Promulgated by the Department of Health and Hospitals, Office of Public Health, LR 28:1245 (June 2002).

§1107. Walls and Ceilings
[formerly paragraph 6:141]

A. Walls and ceilings in the syrup and bottling rooms shall be of hard, sound materials with smooth, easily cleaned surfaces of a light color.

AUTHORITY NOTE: Promulgated in accordance with the provisions of R.S. 40:4(A)(1)(a). Also see R.S. 40:601 et seq.

HISTORICAL NOTE: Promulgated by the Department of Health and Hospitals, Office of Public Health, LR 28:1246 (June 2002).

§1109. Lighting and Ventilation
[formerly paragraph 6:142]

A. All rooms shall be lighted to a minimum standard of 40 foot-candles.

B. Good and sufficient ventilation to insure a healthful and as nearly as practicable, a comfortable atmosphere shall be provided and maintained, by natural or mechanical means at all times during working hours. When the amount of atmospheric contaminants exceeds the limits fixed hereunder, exhaust ventilation shall be provided to reduce

the amount of atmospheric contaminants to within the limits fixed.

AUTHORITY NOTE: Promulgated in accordance with the provisions of R.S. 40:4(A)(1)(a). Also see R.S. 40:601 et seq.

HISTORICAL NOTE: Promulgated by the Department of Health and Hospitals, Office of Public Health, LR 28:1246 (June 2002).

§1111. Insect, Pest and Vermin Control
[formerly paragraph 6:143]

A. All openings to the outer air shall be screened or otherwise protected where necessary against entrance of insects and vermin. The syrup room shall be especially protected against insects and vermin.

AUTHORITY NOTE: Promulgated in accordance with the provisions of R.S. 40:4(A)(1)(a). Also see R.S. 40:601 et seq.

HISTORICAL NOTE: Promulgated by the Department of Health and Hospitals, Office of Public Health, LR 28:1246 (June 2002).

§1113. Syrup Room Requirements
[formerly paragraph 6:144]

A. The syrup room shall be completely enclosed, well ventilated and lighted. Sinks shall be provided and shall have hot and cold running water delivered through a mixer faucet. Syrup rooms shall be protected against vermin, flies, dirt and dust and constructed as to be easily cleaned and sanitized.

AUTHORITY NOTE: Promulgated in accordance with the provisions of R.S. 40:4 (A) (1) (a). Also see R.S. 40:601 et seq.

HISTORICAL NOTE: Promulgated by the Department of Health and Hospitals, Office of Public Health, LR 28:1246 (June 2002).

§1115. Potable Water Supply; Not Cross Connected to Product Water Used for Bottling
[formerly paragraph 6:145]

A. Running water of potable quality shall be easily accessible to all parts of the plant. Provision shall be made for prompt removal and proper disposal of waste water and sewage. If a separate water supply is used for any purpose in the plant, there shall be no connection between that supply and the potable supply used for manufacturing.

AUTHORITY NOTE: Promulgated in accordance with the provisions of R.S. 40:4(A)(1)(a). Also see R.S. 40:601 et seq.

HISTORICAL NOTE: Promulgated by the Department of Health and Hospitals, Office of Public Health, LR 28:1246 (June 2002).

§1117. Toilet and Lavatory Facilities
[formerly paragraph 6:146]

A. Toilet and lavatory facilities shall be provided as required in LAC 51:XIV.411, and shall be maintained in a clean and sanitary condition. Toilet and washroom fixtures shall be so constructed and so operated as to prevent backflow or back-siphonage as defined in LAC 51:XIV.203.A and LAC 51:XIV.609.G.2, from such fixtures into the water supply. Toilet rooms shall have no direct connection with rooms used for manufacturing or bottling and shall have self-closing doors. Additional

lavatory/lavatories shall be conveniently located in the syrup room and other food processing and handling areas. Facilities shall be equipped with hot and cold water under pressure, delivered through a mixer faucet. Soap and sanitary towels or air dryer shall be provided at each lavatory.

AUTHORITY NOTE: Promulgated in accordance with the provisions of R.S. 40:4(A)(1)(a). Also see 40:601 et seq.

HISTORICAL NOTE: Promulgated by the Department of Health and Hospitals, Office of Public Health, LR 28:1246 (June 2002), amended LR 38:2792 (November 2012).

§1119. Multi-Use Container Washing and Handling
[formerly paragraph 6:147]

A. Every plant manufacturing bottled beverages shall be equipped with suitable mechanical bottle washing apparatus and with approved machines for carbonation, filling and crowning so that these operations can be performed as to prevent any part of the operator or his clothing from coming in contact with those surfaces of the bottles which come in contact with the beverage. Bottle washing machines shall be so constructed and operated as to prevent back-siphonage, or return-flow, into the water supply lines.

AUTHORITY NOTE: Promulgated in accordance with the provisions of R.S. 40:4(A)(1)(a). Also see R.S. 40:601 et seq.

HISTORICAL NOTE: Promulgated by the Department of Health and Hospitals, Office of Public Health, LR 28:1246 (June 2002).

§1121. Conveyors and Cases
[formerly paragraph 6:148]

A. Conveyors and cases shall be maintained in a clean and sanitary condition.

AUTHORITY NOTE: Promulgated in accordance with the provisions of R.S. 40:4(A)(1)(a). Also see R.S. 40:601 et seq.

HISTORICAL NOTE: Promulgated by the Department of Health and Hospitals, Office of Public Health, LR 28:1246 (June 2002).

§1123. Syrup Making and Mixing Equipment
[formerly paragraph 6:149]

A. All vats, jars, mixing and storage tanks, pipe lines, filters and other apparatus employed in the preparation of syrups, shall be of sanitary construction and lined with materials resistant to the action of syrup ingredients.

AUTHORITY NOTE: Promulgated in accordance with the provisions of R.S. 40:4(A)(1)(a). Also see R.S. 40:601 et seq.

HISTORICAL NOTE: Promulgated by the Department of Health and Hospitals, Office of Public Health, LR 28:1246 (June 2002).

§1125. Water Treatment Equipment
[formerly paragraph 6:150]

A. Electrical or chemical coagulation devices and filters employed for clarification of water shall be of types approved by the state health officer, shall not be operated beyond their rated capacity and shall be maintained in a clean and sanitary condition at all times.

AUTHORITY NOTE: Promulgated in accordance with the provisions of R.S. 40:4(A)(1)(a). Also see R.S. 40:601 et seq.

HISTORICAL NOTE: Promulgated by the Department of Health and Hospitals, Office of Public Health, LR 28:1246 (June 2002).

§1127. Miscellaneous Testing Equipment
[formerly paragraph 6:151]

A. Every plant manufacturing bottled carbonated beverages shall be provided with thermometers, acid and sugar hydrometers, gas volume testers, and apparatus for ascertaining the alkalinity and causticity of the soaker solution employed in bottle washing.

AUTHORITY NOTE: Promulgated in accordance with the provisions of R.S. 40:4(A)(1)(a). Also see R.S. 40:601 et seq.

HISTORICAL NOTE: Promulgated by the Department of Health and Hospitals, Office of Public Health, LR 28:1247 (June 2002).

§1129. Good Manufacturing Practices; Processes and Controls
[formerly paragraph 6:152]

A. All operations in the receiving, inspection, transporting, packing, segregating, preparing, processing and storing of food shall be conducted in accordance with good sanitation principles. Overall sanitation of the plant shall be under the supervision of an individual assigned responsibility for this function. All precautions shall be taken to assure that production procedures do not contribute contamination such as filth, harmful chemicals, undesirable microorganisms or any other objectionable material to the processed product. Examples of production procedures which contribute to contamination are poorly maintained bottle washers, lack of sanitizing equipment and poor employee sanitary practices. Quality control records shall be maintained on all tests and analyses done on processed products.

AUTHORITY NOTE: Promulgated in accordance with the provisions of R.S. 40:4(A)(1)(a). Also see R.S. 40:601 et seq.

HISTORICAL NOTE: Promulgated by the Department of Health and Hospitals, Office of Public Health, LR 28:1247 (June 2002).

§1131. Plant Layout
[formerly paragraph 6:153]

A. Where practicable, the operations of bottle washing and filling, compounding and mixing of syrups, and shipping, shall be performed in separate rooms. Where this is not feasible, the various operations shall be located in the available space in such a manner so that operations do not interfere with one another, and do not lead to product contamination.

AUTHORITY NOTE: Promulgated in accordance with the provisions of R.S. 40:4(A)(1)(a). Also see R.S. 40:601 et seq.

HISTORICAL NOTE: Promulgated by the Department of Health and Hospitals, Office of Public Health, LR 28:1247 (June 2002).

§1133. Bottle Washing; Mechanical Cleaning and Sterilizing; Hand Washing of Bottles Prohibited
[formerly paragraph 6:154]

A. Hand bottle washing, except as a preliminary to subsequent mechanical washing, is prohibited. All bottles

shall be thoroughly cleaned and sterilized, according to the provisions of state law governing containers (R.S. 40:681 et seq.), immediately before filling, by means of an automatic mechanical washing machine.

AUTHORITY NOTE: Promulgated in accordance with the provisions of R.S. 40:4(A)(1)(a). Also see R.S. 40:601 et seq.

HISTORICAL NOTE: Promulgated by the Department of Health and Hospitals, Office of Public Health, LR 28:1247 (June 2002).

§1135. Preparation of Syrups
[formerly paragraph 6:155]

A. Syrups shall be prepared in a clean manner, and every precaution shall be taken against contamination or absorption of deleterious substances (such as, but not limited to, mold, yeast, bacteria, insects, cleaning agent residues, toxic substances such as caustic soda, pesticide residues, etc.), during preparation and subsequent storage.

AUTHORITY NOTE: Promulgated in accordance with the provisions of R.S. 40:4(A)(1)(a). Also see R.S. 40:601 et seq.

HISTORICAL NOTE: Promulgated by the Department of Health and Hospitals, Office of Public Health, LR 28:1247 (June 2002).

§1137. Filling and Crowning
[formerly paragraph 6:156]

A. Manual filling or crowning is prohibited. Bottles shall be filled and capped with automatic machinery, and the operator or his clothes shall not come in contact with any portion of the bottle or machinery which might result in contamination of the product.

AUTHORITY NOTE: Promulgated in accordance with the provisions of R.S. 40:4(A)(1)(a). Also see R.S. 40:601 et seq.

HISTORICAL NOTE: Promulgated by the Department of Health and Hospitals, Office of Public Health, LR 28:1247 (June 2002).

§1139. Storage of Crowns
[formerly paragraph 6:157]

A. Crowns shall be stored in dust proof containers.

AUTHORITY NOTE: Promulgated in accordance with the provisions of R.S. 40:4(A)(1)(a). Also see R.S. 40:601 et seq.

HISTORICAL NOTE: Promulgated by the Department of Health and Hospitals, Office of Public Health, LR 28:1247 (June 2002).

§1141. Preparation and Storage of Colors
[formerly paragraph 6:158]

A. All non-alcoholic colors shall be prepared in small batches, sterilized immediately before use and stored so as protected against dust.

AUTHORITY NOTE: Promulgated in accordance with the provisions of R.S. 40:4(A)(1)(a). Also see R.S. 40:601 et seq.

HISTORICAL NOTE: Promulgated by the Department of Health and Hospitals, Office of Public Health, LR 28:1247 (June 2002).

§1143. Finished Product Storage
[formerly paragraph 6:159]

A. The finished products shall be stored in such a manner as not to interfere with the sanitation of the bottling room.

AUTHORITY NOTE: Promulgated in accordance with the provisions of R.S. 40:4(A)(1)(a). Also see R.S. 40:601 et seq.

HISTORICAL NOTE: Promulgated by the Department of Health and Hospitals, Office of Public Health, LR 28:1247 (June 2002).

§1145. Refuse and Rubbish
[formerly paragraph 6:160]

A. Bottle cases shall be kept free of broken bottles, garbage, litter or other materials which may harbor insects or rodents and other refuse.

AUTHORITY NOTE: Promulgated in accordance with the provisions of R.S. 40:4(A)(1)(a). Also see R.S. 40:601 et seq.

HISTORICAL NOTE: Promulgated by the Department of Health and Hospitals, Office of Public Health, LR 28:1247 (June 2002).

§1147. Cleaning and Sanitizing of Apparatus
[formerly paragraph 6:161]

A. All pipe lines, apparatus and containers employed in the manufacturing processes shall be thoroughly washed, cleaned and sanitized at four-hour intervals, so as to be maintained at all times in a clean and sanitary condition. Steam, hot water, chlorine or other equally efficient agents are permissible for sanitizing.

AUTHORITY NOTE: Promulgated in accordance with the provisions of R.S. 40:4(A)(1)(a). Also see R.S. 40:601 et seq.

HISTORICAL NOTE: Promulgated by the Department of Health and Hospitals, Office of Public Health, LR 28:1248 (June 2002).

§1149. Water
[formerly paragraph 6:162]

A. The water employed in the manufacture of beverages and for rinsing bottles or other containers shall be free from substances deleterious to health and shall conform to the regulations of this Code and to the standards for potable water.

AUTHORITY NOTE: Promulgated in accordance with the provisions of R.S. 40:4(A)(1)(a). Also see R.S. 40:601 et seq.

HISTORICAL NOTE: Promulgated by the Department of Health and Hospitals, Office of Public Health, LR 28:1248 (June 2002).

§1151. Prohibited Preservatives
[formerly paragraph 6:163]

A. No antiseptic, disinfectant or preservative prohibited by federal or state food and drug or health laws (21 CFR I et seq.; R.S. 40:601 et seq.), shall be used in beverages.

AUTHORITY NOTE: Promulgated in accordance with the provisions of R.S. 40:4(A)(1)(a). Also see R.S. 40:601 et seq.

HISTORICAL NOTE: Promulgated by the Department of Health and Hospitals, Office of Public Health, LR 28:1248 (June 2002).

§1153. Allowable Acids and Flavors;
Prohibited Mineral Acids
[formerly paragraph 6:164]

A. Citric, tartaric or other edible organic acids, and their salts, may be used. Mineral acids, other than phosphoric acid or its salts, are prohibited in carbonated beverages. Acids and flavors shall be stored in covered containers, properly labeled, and protected against contamination.

AUTHORITY NOTE: Promulgated in accordance with the provisions of R.S. 40:4(A)(1)(a). Also see R.S. 40:601 et seq.

HISTORICAL NOTE: Promulgated by the Department of Health and Hospitals, Office of Public Health, LR 28:1248 (June 2002).

§1155. Colors Additives
[formerly paragraph 6:165]

A. Only caramel, U. S. certified coal tar, or approved vegetable colors as described in the food additive statutes—21 USC 409 or 21 CFR 170 shall be used.

AUTHORITY NOTE: Promulgated in accordance with the provisions of R.S. 40:4(A)(1)(a). Also see R.S. 40:601 et seq.

HISTORICAL NOTE: Promulgated by the Department of Health and Hospitals, Office of Public Health, LR 28:1248 (June 2002).

§1157. Employee Health
[formerly paragraph 6:166]

A. The requirements of Part I, §117, Part II, §§501 and 503 and Part VI, §§305-309 shall be met.

AUTHORITY NOTE: Promulgated in accordance with the provisions of R.S. 40:4(A)(1)(a). Also see R.S. 40:601 et seq.

HISTORICAL NOTE: Promulgated by the Department of Health and Hospitals, Office of Public Health, LR 28:1248 (June 2002).

Chapter 13. Cold Storage and Ice Plants

§1301. Definitions
[formerly paragraph 6:167]

A. Unless otherwise specifically provided herein, the following words and terms used in this Part of the sanitary code, and all other Parts which are adopted or may be adopted, are defined for the purposes thereof as follows.

Cold Storage Plants or *Cold Storage Rooms*—places artificially cooled by refrigerating machinery or ice, or other means in which articles of food are stored at a temperature of 45°F or lower; provided, however, that frozen food lockers for the convenience of individuals who rent such lockers for the storage of privately owned foods not intended for sale are not included.

Cross Connection—a physical connection through which a supply of potable water could be contaminated or polluted and/or a connection between a supervised potable water supply and an unsupervised supply of unknown potability.

Ice Plant—any building, or group of buildings, used or maintained for the manufacture of ice.

Personnel—any person who may in any manner come in contact with artificial ice during its manufacture, storage or distribution or with foods in cold storage.

Proprietor—any person, firm, corporation or governmental agency owning or operating an artificial ice or cold storage plant.

AUTHORITY NOTE: Promulgated in accordance with the provisions of R.S. 40:4(A)(1)(a). Also see R.S. 40:601 et seq.

HISTORICAL NOTE: Promulgated by the Department of Health and Hospitals, Office of Public Health, LR 28:1248 (June 2002).

§1303. Plans Review
[formerly paragraph 6:168]

A. Plans for the construction of new ice plants and cold storage plants and rooms, or for major changes in existing plants, shall be submitted to the state health officer for approval. Construction, or improvements, shall not begin before approval of the state health officer is obtained.

AUTHORITY NOTE: Promulgated in accordance with the provisions of R.S. 40:4(A)(1)(a). Also see R.S. 40:601 et seq.

HISTORICAL NOTE: Promulgated by the Department of Health and Hospitals, Office of Public Health, LR 28:1248 (June 2002).

§1305. Building Construction: Ice Plants, Cold Storage Plants or Cold Storage Rooms
[formerly paragraph 6:169]

A. Storage in any basement, room or receptacle which is subject to sewerage or waste water backflow, or in any place having defective drain pipes or appliances, is prohibited. Floors shall be constructed of tight, sound, smooth material, free from cracks and easily cleanable. The cold storage rooms shall be constructed and maintained to prevent entrance of rodents, in accordance with Part V (Disease Vector Control) of this Code.

B. All cold storage rooms shall be properly lighted by natural or artificial means.

C. No new ice plant shall hereafter be constructed nor shall major alterations be made to existing ice plants without the prior written approval of, and unless in accordance with plans and specifications approved in advance by the state health officer.

AUTHORITY NOTE: Promulgated in accordance with the provisions of R.S. 40:4(A)(1)(a). Also see R.S. 40:601 et seq.

HISTORICAL NOTE: Promulgated by the Department of Health and Hospitals, Office of Public Health, LR 28:1248 (June 2002).

§1307. Potable Water Supply
[formerly paragraph 6:170]

A. The water supply used by an artificial ice plant to make ice shall meet the requirements of Part XII of this Code for safe water supplies.

AUTHORITY NOTE: Promulgated in accordance with the provisions of R.S. 40:4(A)(1)(a). Also see R.S. 40:601 et seq.

HISTORICAL NOTE: Promulgated by the Department of Health and Hospitals, Office of Public Health, LR 28:1249 (June 2002).

§1309. Cross Connections
[formerly paragraph 6:171]

A. Physical connections between a potable water supply and a water of unknown or questionable quality are prohibited.

AUTHORITY NOTE: Promulgated in accordance with the provisions of R.S. 40:4(A)(1)(a). Also see R.S. 40:601 et seq.

HISTORICAL NOTE: Promulgated by the Department of Health and Hospitals, Office of Public Health, LR 28:1249 (June 2002).

§1311. Sewage Disposal
[formerly paragraph 6:172]

A. Sewage disposal facilities shall be provided in compliance with Part XIII of this Code.

AUTHORITY NOTE: Promulgated in accordance with the provisions of R.S. 40:4(A)(1)(a). Also see R.S. 40:601 et seq.

HISTORICAL NOTE: Promulgated by the Department of Health and Hospitals, Office of Public Health, LR 28:1249 (June 2002).

§1313. Toilet and Lavatory Facilities
[formerly paragraph 6:173]

A. Every artificial ice plant and cold storage plant shall be provided with toilet and hand washing facilities for employees as required by LAC 51:XIV.411, titled "Minimum Plumbing Fixtures". Handwashing facilities shall be located conveniently to all toilet facilities. These facilities shall be kept clean. Toilet room doors shall be self-closing.

AUTHORITY NOTE: Promulgated in accordance with provisions of R.S. 40:4(A)(1)(a). Also see 40:601 et seq.

HISTORICAL NOTE: Promulgated by the Department of Health and Hospitals, Office of Public Health, LR 28:1249 (June 2002), amended LR 38:2792 (November 2012).

§1315. Air Blowers
[formerly paragraph 6:174]

A. The air intake of air blowers used at artificial ice plants shall be so located and protected as to ensure the use of a safe and clean air supply.

AUTHORITY NOTE: Promulgated in accordance with the provisions of R.S. 40:4(A)(1)(a). Also see R.S. 40:601 et seq.

HISTORICAL NOTE: Promulgated by the Department of Health and Hospitals, Office of Public Health, LR 28:1249 (June 2002).

§1317. Outside Entrances
[formerly paragraph 6:175]

A. Outside doors shall be self-closing.

AUTHORITY NOTE: Promulgated in accordance with the provisions of R.S. 40:4(A)(1)(a). Also see R.S. 40:601 et seq.

HISTORICAL NOTE: Promulgated by the Department of Health and Hospitals, Office of Public Health, LR 28:1249 (June 2002).

§1319. Permits
[formerly paragraph 6:176]

A. Cold storage and ice plants must obtain permits from the state health officer, in accordance with Part I of this Code.

AUTHORITY NOTE: Promulgated in accordance with the provisions of R.S. 40:4(A)(1)(a). Also see R.S. 40:601 et seq.

HISTORICAL NOTE: Promulgated by the Department of Health and Hospitals, Office of Public Health, LR 28:1249 (June 2002).

§1321. Employee Health
[formerly paragraph 6:177]

A. The requirements of Part I, §117, and Part II, §§501-503.C shall be met.

AUTHORITY NOTE: Promulgated in accordance with the provisions of R.S. 40:4(A)(1)(a). Also see R.S. 40:601 et seq.

HISTORICAL NOTE: Promulgated by the Department of Health and Hospitals, Office of Public Health, LR 28:1249 (June 2002).

§1323. Spitting
[formerly paragraph 6:178]

A. Spitting in the ice plant and cold storage rooms is prohibited.

AUTHORITY NOTE: Promulgated in accordance with the provisions of R.S. 40:4(A)(1)(a). Also see R.S. 40:601 et seq.

HISTORICAL NOTE: Promulgated by the Department of Health and Hospitals, Office of Public Health, LR 28:1249 (June 2002).

§1325. Cleanliness
[formerly paragraph 6:179]

A. Floors of the brine rooms, ice storage and cold storage rooms, toilets and all other appurtenances shall be kept clean. Employees working on brine tanks or in ice storage rooms shall wear rubber boots, which shall be worn in these areas only.

B. [formerly paragraph 6:180] Cold storage plants shall be kept free from rust, growths, molds and slime.

AUTHORITY NOTE: Promulgated in accordance with the provisions of R.S. 40:4(A)(1)(a). Also see R.S. 40:601 et seq.

HISTORICAL NOTE: Promulgated by the Department of Health and Hospitals, Office of Public Health, LR 28:1249 (June 2002).

§1327. Storage of Meats and Foods
[formerly paragraph 6:181]

A. Meats and foods shall not be placed in direct contact with ice, or upon the flooring of cold storage rooms. Bins, racks or other receptacles used for the storage of meats and foods shall be kept in a sanitary condition.

AUTHORITY NOTE: Promulgated in accordance with the provisions of R.S. 40:4(A)(1)(a). Also see R.S. 40:601 et seq.

HISTORICAL NOTE: Promulgated by the Department of Health and Hospitals, Office of Public Health, LR 28:1249 (June 2002).

§1329. Ice Removal from Cans
[formerly paragraph 6:182]

A. Submerging or spraying of ice cans for removal of ice cakes in other than potable water is prohibited.

AUTHORITY NOTE: Promulgated in accordance with the provisions of R.S. 40:4(A)(1)(a). Also see R.S. 40:601 et seq.

HISTORICAL NOTE: Promulgated by the Department of Health and Hospitals, Office of Public Health, LR 28:1249 (June 2002).

§1331. Transportation, Distribution and Storage of Ice
[formerly paragraph 6:183]

A. Ice intended for human or domestic consumption shall not be placed on streets, sidewalks, roads or alleys, or transported through such streets, sidewalks, roads or alleys, unless protected in a sanitary manner.

1. [formerly paragraph 6:184] Trucks and other vehicles from which ice is sold or delivered, and all factories, shops, storerooms, pantries and other places where ice is handled for sale, service or consumption, shall be thoroughly clean and in a sanitary condition, and shall be kept free from all dirt, dust, trash or any other substance or matter which is liable to become mixed with or enter into the ice or anything prepared with ice, so as to contaminate or render it unclean or insanitary.

AUTHORITY NOTE: Promulgated in accordance with the provisions of R.S. 40:4(A)(1)(a). Also see R.S. 40:601 et seq.

HISTORICAL NOTE: Promulgated by the Department of Health and Hospitals, Office of Public Health, LR 28:1250 (June 2002).

§1333. Grinding, Crushing and Packaging of Ice
[formerly paragraph 6:185]

A. Crushed or ground ice intended for human consumption or use shall be crushed or ground and packaged in a sanitary manner so as to prevent contamination by filth, foreign material, dust, insects, rodent filth such as hairs, droppings, etc.

1. [formerly part of paragraph 6:185] The crushing or grinding and packaging of ice on wagons, trucks or other vehicles used to deliver ice to be used for human or domestic consumption is strictly prohibited.

2. [formerly part of paragraph 6:185] Ice intended to be used for human or domestic consumption shall be thoroughly washed before being placed in the crusher or grinder. The facilities for crushing or grinding and packaging of ice shall be located in a satisfactorily enclosed building or structure, and shall be maintained in a sanitary condition so that the ice will be protected from dust, dirt, flies, insects, rust and other contaminating sources during the grinding or crushing and packaging operations.

AUTHORITY NOTE: Promulgated in accordance with the provisions of R.S. 40:4(A)(1)(a). Also see R.S. 40:601 et seq.

HISTORICAL NOTE: Promulgated by the Department of Health and Hospitals, Office of Public Health, LR 28:1250 (June 2002).

§1335. Records
[formerly paragraph 6:186]

A. It shall be the duty of every person, firm or corporation operating a cold storage plant to keep an accurate record of the receipts and withdrawals of all goods stored therein. All goods stored in such an establishment shall be identified by a code or lot number, which number shall be entered in the record book at the time such goods are accepted for cold storage. The state health officer shall

have free access to these records at any reasonable time during working hours.

AUTHORITY NOTE: Promulgated in accordance with the provisions of R.S. 40:4(A)(1)(a). Also see R.S. 40:601 et seq.

HISTORICAL NOTE: Promulgated by the Department of Health and Hospitals, Office of Public Health, LR 28:1250 (June 2002).

§1337. Unwholesome Food
[formerly paragraph 6:187]

A. No article of food shall be placed in cold storage if it shows evidences of decomposition, such as, but not limited to, spoilage, rodent defilement, insect infestations, chemical or pesticide contamination, filth and foreign object contamination, swollen cans, etc., or of other conditions which would make it unfit for food.

AUTHORITY NOTE: Promulgated in accordance with the provisions of R.S. 40:4(A)(1)(a). Also see R.S. 40:601 et seq.

HISTORICAL NOTE: Promulgated by the Department of Health and Hospitals, Office of Public Health, LR 28:1250 (June 2002).

§1339. Reserved.

§1341. Sale of Cold Storage Goods; Prohibited "Fresh" Food Claims
[formerly paragraph 6:189]

A. It shall be a violation of the state sanitary code to sell or offer or expose for sale uncooked articles of food which have been held in cold storage without advising or notifying persons purchasing, or intending to purchase, such articles of food that they have been held in cold storage; and it shall be unlawful to represent or advertise as "fresh," articles of food which have been held in cold storage.

AUTHORITY NOTE: Promulgated in accordance with the provisions of R.S. 40:4(A)(1)(a). Also see R.S. 40:601 et seq.

HISTORICAL NOTE: Promulgated by the Department of Health and Hospitals, Office of Public Health, LR 28:1250 (June 2002).

§1343. Transfer of Cold Storage Goods; Prohibited Return to Cold Storage
[formerly paragraph 6:190]

A. It shall be a violation of the sanitary code to return to cold storage any article of food which has once been released from storage, except that nothing in these regulations shall be construed as preventing the transfer of goods from one cold storage plant to another; provided, such goods are refrigerated at a temperature of 45°F or lower during such transfer; and, provided further, that such transfer is not made for the purpose of evading any provision.

AUTHORITY NOTE: Promulgated in accordance with the provisions of R.S. 40:4(A)(1)(a). Also see R.S. 40:601 et seq.

HISTORICAL NOTE: Promulgated by the Department of Health and Hospitals, Office of Public Health, LR 28:1250 (June 2002).

Chapter 15. Current Good Manufacturing Practices in the Manufacture of Drugs

§1501. Definitions
[formerly paragraph 6:191]

A. Unless otherwise specifically provided herein, the following words and terms used in this Part of the sanitary code, and all other Parts which are adopted or may be adopted, are defined for the purposes thereof as follows.

Active Ingredient—any component which is intended to furnish pharmacological activity or other direct effect in the diagnosis, care, mitigation, treatment or prevention of disease or to affect the structure of any function of the body of man or other animals. The term shall include other components which may undergo chemical change in the manufacture of the drug or be present in the finished product in a modified form intended to furnish the specified activity or effect.

Batch—a specific quantity of a drug that has uniform character and quality within specified limits, and is produced according to a single manufacturing order.

Component—any ingredient intended for use in the manufacture of drugs in dosage form, including those that may appear in the final product.

Factory—see Chapter 1, §101 of this Part.

Inactive Ingredient—any component other than an Active Ingredient present in a drug.

Lot—a batch or any portion of a batch of a drug or, in the case of a drug manufactured in a continuous process, an amount of drug product in a unit of time or quantity in a manner that assures its uniformity and in either case which is identified by a distinctive lot and has uniform character and quality within specified limits.

Lot Numbers or Control Numbers—any distinctive combination of letters or numbers, or both from which the complete history of the manufacture, control, packaging and distribution of a batch or lot of drug can be determined.

Materials Approval Unit—any organizational element having the authority and responsibility to approve or reject components, in processing materials, packaging components and final products.

Strength—

a. the concentration of the drug substance (for example: w/w, w/v or unit dose/volume basis); and/or

b. the potency, that is the therapeutic activity of the drug substance as indicated by appropriate laboratory test or by adequately developed or clinically controlled data expressed (for example: in terms of units by reference to a standard).

AUTHORITY NOTE: Promulgated in accordance with the provisions of R.S. 40:4(A)(1)(a). Also see R.S. 40:601 et seq.

HISTORICAL NOTE: Promulgated by the Department of Health and Hospitals, Office of Public Health, LR 28:1250 (June 2002).

§1503. Permits
[formerly paragraph 6:192]

A. No person shall operate any factory or process or repackage any drug within the state of Louisiana, without first applying for, paying the required fee and obtaining a permit to operate, issued by the state health officer.

AUTHORITY NOTE: Promulgated in accordance with the provisions of R.S. 40:4(A)(1)(a). Also see R.S. 40:601 et seq.

HISTORICAL NOTE: Promulgated by the Department of Health and Hospitals, Office of Public Health, LR 28:1251 (June 2002).

§1505. Public Display of Permits
[formerly part of paragraph 6:192]

A. Every establishment regulated by this Part shall have displayed, at all times, in a place designated by the state health officer, a permit to operate.

AUTHORITY NOTE: Promulgated in accordance with the provisions of R.S. 40:4(A)(1)(a). Also see R.S. 40:601 et seq.

HISTORICAL NOTE: Promulgated by the Department of Health and Hospitals, Office of Public Health, LR 28:1251 (June 2002).

§1507. Permit Exemptions
[formerly paragraph 6:193]

A. The following shall be exempt from the above permit procedures.

1. [formerly paragraph 6:193-1] Pharmacies that are operating under applicable state laws regulating the dispensing of prescription drugs and that do not manufacture, prepare, propagate, compound or process drugs for sale other than in the regular course of the profession of pharmacy including the dispensing and selling of drugs at retail.

2. [formerly paragraph 6:193-2] Hospitals, clinics and public health agencies which maintain establishments in conformance with any applicable state laws regulating the practice of pharmacy and medicine and which are regularly engaged in dispensing prescription drugs, other than human blood products, upon prescription of practitioners, licensed by law to administer such drug for patients under the care of such practitioners in the course of their professional practice; practitioners who are licensed by law to prescribe or administer drugs and who manufacture, prepare, propagate, compound or process drugs solely for use in the course of their professional practice; and manufacturers of harmless inactive ingredients which are excipients, colorings, flavoring, emulsifiers, lubricants, preservatives or solvents that become components of drugs.

AUTHORITY NOTE: Promulgated in accordance with the provisions of R.S. 40:4(A)(1)(a). Also see R.S. 40:601 et seq.

HISTORICAL NOTE: Promulgated by the Department of Health and Hospitals, Office of Public Health, LR 28:1251 (June 2002).

§1509. Examination, Condemnation and Destruction of Unwholesome or Adulterated Drugs
[formerly paragraph 6:194]

A. Samples of drugs and drug components may be taken and submitted to a state approved laboratory by the state health officer for examination as often as he deems necessary for the detection of unwholesomeness or adulteration. The state health officer may condemn and forbid the sale of, or cause to be removed or destroyed, any drug which he deems unwholesome or adulterated.

AUTHORITY NOTE: Promulgated in accordance with the provisions of §258(B) of Title 36, and Chapters 1 and 4 of Title 40 of the Louisiana Revised Statutes of 1950. See in particular, R.S. 40:4(A)(1)(a) and R.S. 40:601 et seq.

HISTORICAL NOTE: Promulgated by the Department of Health and Hospitals, Office of Public Health, LR 28:1251 (June 2002).

§1511. Personnel
[formerly paragraph 6:195]

A. The personnel responsible for directing the manufacture and control of the drug shall be adequate in number, and in education, training and experience, or combination thereof, to assure that the drug has the safety, identity, strength, quality and purity that it purports to possess. All personnel shall have capabilities commensurate with their assigned functions, a thorough understanding of the manufacturing and control functions they perform and adequate information concerning the reason for application of pertinent provisions of this Part to their respective functions.

B. [formerly paragraph 6:196] Any person shown at any time (either by medical examination or supervisory observation) to have an apparent illness or open lesion that may adversely affect the safety or quality of drugs, shall be excluded from direct contact with drug products until the condition is corrected. All employees shall be instructed to report to supervisory personnel any condition that may have an adverse affect on drug products.

AUTHORITY NOTE: Promulgated in accordance with the provisions of §258(B) of Title 36, and Chapters 1 and 4 of Title 40 of the Louisiana Revised Statutes of 1950. See in particular, R.S. 40:4(A)(1)(a) and R.S. 40:601 et seq.

HISTORICAL NOTE: Promulgated by the Department of Health and Hospitals, Office of Public Health, LR 28:1251 (June 2002).

§1513. Building Construction
[formerly paragraph 6:197]

A. Buildings shall be maintained in a clean and orderly manner and shall be of a size and construction to comply with the requirements of §§107-109 of this Part, and of Part XIV (Plumbing) of this code.

AUTHORITY NOTE: Promulgated in accordance with the provisions of §258(B) of Title 36, and Chapters 1 and 4 of Title 40 of the Louisiana Revised Statutes of 1950. See in particular, R.S. 40:4(A)(1)(a) and R.S. 40:601 et seq.

HISTORICAL NOTE: Promulgated by the Department of Health and Hospitals, Office of Public Health, LR 28:1252 (June 2002).

§1515. Building Requirements
[formerly paragraph 6:198-1]

A. [formerly paragraph 6:198-1] Buildings shall provide space for:

1. [formerly paragraph 6:198-1 (1)] orderly placement of equipment and materials to minimize the possibility of contamination;

2. [formerly paragraph 6:198-1 (2)] the receipt, storage and withholding from use of components pending sampling, identification and testing prior to release by the materials approval unit for manufacturing or packaging;

3. [formerly paragraph 6:198-1 (3)] the holding of rejected components prior to distribution to preclude the possibility of their use in manufacturing or packaging procedures for which they are unsuitable;

4. [formerly paragraph 6:198-1 (4)] the storage of components, containers, packing materials and labeling;

5. [formerly paragraph 6:198-1 (5)] any manufacturing and processing operation performed;

6. [formerly paragraph 6:198-1 (6)] any packing or labeling operation;

7. [formerly paragraph 6:198-1 (7)] storage of finished product;

8. [formerly paragraph 6:198-1 (8)] control and production laboratory operations.

B. [formerly paragraph 6:198-2] Provide lighting and ventilation as per §313.A.3 and 4 of this Part, and screening, and when necessary for the intended production or control purposes (for example, the production of sterile products or to prevent antibiotic pollution) provide facilities for positive air pressure, microbiological, dust and temperature controls to:

1. [formerly paragraph 6:198-2 (1)] minimize contamination of products by extraneous adulterants, including cross contamination of one product with dust particles of ingredients arising from the manufacture, storage or handling of another product;

2. [formerly paragraph 6:198-2 (2)] provide for storage of drug components, in-process materials, and finished drugs in conformance with stability information as derived under §1705.A and B of this Code;

3. [formerly paragraph 6:198-2 (3)] minimize dissemination of microorganisms from one area to another;

4. [formerly paragraph 6:198-2 (4)] provide locker facilities for employee clothing and belongings. Provide washing facilities equipped with hot and cold water under pressure, delivered through a mixing faucet. Soap and sanitary towels or air dryer shall be provided at each lavatory.

C. [formerly paragraph 6:198-3] Provide a supply of potable water [LAC 51:XII (Water Supplies)] under conditions of positive pressure in a plumbing system

designed in accord with the LSPC and free of defects that could cause or contribute to contamination of any drug. Drains shall be a minimum of 4 inches, and where connected directly to a sewer, shall be equipped with properly vented fixture traps to prevent sewer gas entry into any occupied space.

D. [formerly paragraph 6:198-4] Provide suitable housing and space for the care of all laboratory animals.

E. [formerly paragraph 6:198-5] Provide for safe and sanitary disposal of sewage, trash and other refuse within and from the building and immediate premises.

AUTHORITY NOTE: Promulgated in accordance with provisions of R.S. 40:4(A)(1)(a). Also see 40:601 et seq.

HISTORICAL NOTE: Promulgated by the Department of Health and Hospitals, Office of Public Health, LR 28:1252 (June 2002), amended LR 38:2792 (November 2012).

§1517. Equipment
[formerly paragraph 6:199]

A. Equipment used for the manufacture, processing, packing, labeling, holding, testing or control of drugs shall be maintained in a clean and orderly manner and shall be of suitable design, size, construction and location to facilitate cleaning, maintenance and operation of its intended purpose. The equipment shall:

1. [formerly paragraph 6:199-1] be constructed so that all surfaces that come into contact with a drug product shall not be reactive, additive or absorptive so as to alter the safety, identity strength, quality or purity of the drug or its components beyond established requirements;

2. [formerly paragraph 6:199-2] be constructed so that any substance required for operation of the equipment, such as lubricant or coolants, do not contact drug products so as to alter the safety, identity, strength, quality or purity of the drug or its components beyond the established requirements;

3. [formerly paragraph 6:199-3] be constructed and installed to facilitate adjustment, disassembly, cleaning and maintenance to assure the reliability of control procedure's uniformity of production and exclusion from the drugs of contamination from previous and current operations that might affect the safety, identity, strength, quality or purity of the drug or its components beyond established requirements;

4. [formerly paragraph 6:199-4] be of suitable type, size and accuracy for any testing, measuring, mixing, weighing or other processing of storage operations. The regulations in this Part permit the use of precision automatic, mechanical or electronic equipment in the production and control of drugs when inspection and checking procedures are used to assure proper performance.

AUTHORITY NOTE: Promulgated in accordance with the provisions of R.S. 40:4(A)(1)(a). Also see R.S. 40:601 et seq.

HISTORICAL NOTE: Promulgated by the Department of Health and Hospitals, Office of Public Health, LR 28:1252 (June 2002).

§1519. Product Production and Quality Control
[formerly paragraph 6:200]

A. Production and control procedures shall include all reasonable precautions including the following to assure that the drugs produced have the safety, identity, quality, strength and purity they purport to possess:

1. [formerly paragraph 6:201-1] each significant step in the process, such as selection, weighing and measuring during the various stages of the processing and determination of the finished yield shall be performed by a competent and responsible individual and checked by a second competent and responsible individual; or if such steps in the processing are controlled by precision automatic, mechanical or electronic equipment, their performance is checked. The written record of the significant steps in the process shall be performed by a person having requisite abilities; such identifications shall be recorded immediately following the completion of such steps;

2. [formerly paragraph 6:201-2] all containers, lines and equipment used during the production of a batch of drugs shall be properly identified at all times to accurately and completely indicate their contents, and when necessary, the stage of processing of the batch;

3. [formerly paragraph 6:201-3] to minimize contamination and prevent mix-ups, equipment, utensils and containers shall be thoroughly cleaned or sanitized and stored and have previous batch identification removed or obliterated between batches at intervals while production operations are continuing;

4. [formerly paragraph 6:201-4] precautions shall be taken to minimize microbiological and other contamination in the production of drugs purporting to be sterile, or which by virtue of their intended use should be free from objectionable microorganisms, such as the known common pathogens and others which might affect stability, color or taste;

5. [formerly paragraph 6:201-5] procedures shall be established to minimize the hazard to any drugs while being manufactured or stored. Such procedures shall meet with the approval of the state health officer;

6. [formerly paragraph 6:201-6] to assure the uniformity and integrity of products, there shall be in-process controls, such as checking the weights and disintegration times of tablets, the adequacy of mixing, the homogeneity of suspensions and the clarity of solutions. In-process sampling shall be done at intervals;

7. [formerly paragraph 6:201-7] representative samples of all dosage form drugs shall be tested to determine their conformance with the specifications of the product before distribution;

8. [formerly paragraph 6:201-8] review and approval of all production and control records, including packing and labeling, shall be made prior to the release for distribution of a batch, and records maintained to show this review. A thorough investigation of the failure of a batch to meet any

of its specifications shall be undertaken whether or not the batch has been distributed. The investigation shall extend to other batches of the same drug and other drugs that may have been associated with a problem found with that batch. A written record of the investigation shall be made and shall include the conclusion and follow-up;

9. [formerly paragraph 6:201-9] returned goods shall be identified as such and held. If the conditions under which returned goods have been held, stored or shipped prior to or during their return, or the condition of the product, its container, carton or labeling as a result of storage or shipping cast doubt on the safety, identity, strength, quality or purity of the drug, the returned goods shall be destroyed or subjected to examination or testing to assure the material meets all original standards or specifications before being returned to stock for warehouse distribution or repacking. If the product is neither destroyed nor returned to store, it may be reprocessed provided the final product meets all of its standards and specifications. Records of returned goods shall be maintained and shall indicate the quantity returned, date and actual disposition of the product. If the reason for returned goods implicates associated batches, an appropriate investigation shall be made in accordance with the requirements of §1519.A.8 of this Part;

10. [formerly paragraph 6:201-10] use of asbestos-containing or other fiber releasing filters:

a. [formerly paragraph 6:201-10 (1)] filter used in the manufacture, process or packing of components of drug products for parenteral injections in humans shall not release fibers into such products. No asbestos-containing or other fiber-releasing filter may be used in the manufacture, process or packaging of such products unless it is not possible to manufacture that drug product or component without the use of such a filter. Filtration, as needed shall be through a non-fiber-releasing filter. This filter shall be defined as a non-asbestos filter that after the pretreatment such as washing or flushing, will not continue to release fibers into the drug product or component that is being filtered. A fiber is defined as any particle with length at least three times greater than its width;

b. [formerly paragraph 6:201-10 (2)] if the use of a fiber-releasing filter is required, an additional non-fiber releasing filter or maximum pore size of 0.22 microns (0.45 microns if the manufacturing conditions so dictate) shall subsequently be used to reduce the content of any asbestos-form particle in the drug product or component.

AUTHORITY NOTE: Promulgated in accordance with the provisions of R.S. 40:4(A)(1)(a). Also see R.S. 40:601 et seq.

HISTORICAL NOTE: Promulgated by the Department of Health and Hospitals, Office of Public Health, LR 28:1252 (June 2002).

§1521. Components

[formerly paragraph 6:202]

A. All components and other materials used in the manufacture, processing and packing of drug products, and materials necessary for building and equipment maintenance, shall upon receipt be stored and handled in a

safe, sanitary and orderly manner to assure safety, purity and strength. Precautions shall be taken to prevent mix-ups and cross-contamination affecting drugs and drug products. Components shall be held from use until they have been identified, sampled and tested for conformance to established specifications and are released by a material approval unit. Controls of components shall include the following.

1. [formerly paragraph 6:202-1] Each container of component shall be examined visually for damage or contamination prior to use, including examination for breakage of seals, when indicated.

2. [formerly paragraph 6:202-2] Samples shall be taken from component containers from each lot and shall be subjected to one or more tests to establish their specific identity.

3. [formerly paragraph 6:202-3] Samples of components liable to contamination with filth, insect infestation or other extraneous contaminants shall be appropriately examined.

4. [formerly paragraph 6:202-4] Samples of components liable to microbiological contamination shall be subjected to microbiological test prior to use. Such components shall not contain microorganisms that are objectionable in view of their intended use.

5. [formerly paragraph 6:202-5] Samples of all components intended for use as active ingredients shall be tested to determine their strength in order to assure conformance with specifications approved by the state health officer.

6. [formerly paragraph 6:202-6] Components which have previously been approved shall be identified and retested as necessary to assure that they continue to meet specifications:

a. [formerly paragraph 6:202-6 (1)] Components which have been approved shall be handled and stored to guard against contamination or being contaminated by other drugs or components.

b. [formerly paragraph 6:202-6 (2)] Components which have been approved shall be rotated in such a manner that the oldest stock is used first.

c. [formerly paragraph 6:202-6 (3)] Rejected components shall be identified and held to preclude their use in manufacturing or processing procedures for which they are unsuitable.

7. [formerly paragraph 6:202-7] Records shall be maintained for at least two years after distribution has been completed, or one year after the drug's expiration date, whichever is longer. Such records shall include:

a. [formerly paragraph 6:202-7 (1)] the identity and quantity of the component, the name of the supplier, the supplier's lot number and the date of receipt;

b. [formerly paragraph 6:202-7 (2)] examinations and tests performed, and rejected components and their disposition;

c. [formerly paragraph 6:202-7 (3)] an individual inventory and record for each component used in each batch of drug manufactured or processed.

8. [formerly paragraph 6:202-8] An identified reserve sample of all active ingredients consisting of at least twice the quantity necessary for all required tests, except those for sterility and determination of pyrogens, shall be retained for at least two years after distribution of the last drug lot incorporating the component has been completed, or one year after the expiration date of this last drug lot, whichever is longer.

AUTHORITY NOTE: Promulgated in accordance with the provisions of R.S. 40:4(A)(1)(a). Also see R.S. 40:601 et seq.

HISTORICAL NOTE: Promulgated by the Department of Health and Hospitals, Office of Public Health, LR 28:1253 (June 2002).

§1523. Product Containers and Their Components [formerly paragraph 6:203]

A. Specifications, test methods, cleaning procedures and when indicated, sterilization procedures shall be used to assure that containers, closures and other component parts of drug packages are suitable for their intended use. Containers for parenteral drugs, drug products or drug components shall be cleansed with water which has been filtered through a non-fiber releasing filter. Product containers and their components shall not be reactive, additive or absorptive so as to alter the safety, strength, identity, quality or purity of the drug or its components beyond the official or established requirements, and shall provide protection against external factors that can cause the deterioration or contamination of the drug.

AUTHORITY NOTE: Promulgated in accordance with the provisions of R.S. 40:4(A)(1)(a). Also see R.S. 40:601 et seq.

HISTORICAL NOTE: Promulgated by the Department of Health and Hospitals, Office of Public Health, LR 28:1254 (June 2002).

§1525. Laboratory Controls [formerly paragraph 6:204]

A. Laboratory controls shall include the establishment of scientifically sound specifications, standards and test procedures to assure that the components, in-processed drugs and finished products conform to standards of identity, strength, quality and purity. Laboratory controls shall include requirements listed in §§1525.A.1-10:

1. [formerly paragraph 6:205-1] the establishment of master records containing specifications for the acceptance of each lot of components, product containers and their components used in drug production and packaging and a description of the sampling and testing procedures used for them. Such records shall also contain provisions for retesting of drug components, product containers and their components which are subject to deterioration;

2. [formerly paragraph 6:205-2] a reserve sample of all active ingredients as required by §1521;

3. [formerly paragraph 6:205-3] the establishment of master records containing specifications and a description of sampling procedures for in-process drug preparations;

4. [formerly paragraph 6:205-4] the establishment of master records containing a description of sampling procedures and appropriate specifications for the finished drug product;

5. [formerly paragraph 6:205-5] provisions for checking the identity and strength of a drug product for all active ingredients and for assuring:

a. [formerly paragraph 6:205-5 (1)] sterility of drugs purported to be sterile; and freedom from objectionable microorganisms (such as the known common pathogens and others which might affect safety, strength and purity) for those drugs which should be so by virtue of their intended use;

b. [formerly paragraph 6:205-5 (2)] the absence of pyrogens for those drugs purporting to be pyrogen-free;

c [formerly paragraph 6:205-5 (3)] minimal contamination of ophthalmic ointment by foreign particles and harsh or abrasive substances;

d. [formerly paragraph 6:205-5 (4)] that the drug release pattern of sustained-release products is tested by laboratory methods to assure conformance to release specifications;

6. [formerly paragraph 6:205-6] provisions for auditing the reliability, accuracy, precision and performance of laboratory instruments and test procedures;

7. [formerly paragraph 6:205-7] an identified reserve sample of the finished product (stored in the same immediate container-closure system in which the drug is marketed) consisting of at least twice the quantity necessary to perform all the necessary tests, except those for sterility and determination of the absence of pyrogens, shall be stored under conditions consistent with product labeling, and shall be retained for at least two years after distribution has been completed or one year after the expiration date, whichever is longer;

8. [formerly paragraph 6:205-8] provisions for retaining complete records of all laboratory data relating to each batch or lot of drug to which they apply. Such records shall be retained for at least two years after distribution has been completed or one year after the drug's expiration date, whichever is longer;

9. [formerly paragraph 6:205-9] provisions that animals shall be maintained and controlled in a manner that assures suitability for their intended use. They shall be identified and records maintained to determine the history of use;

10. [formerly paragraph 6:205-10] provisions that firms which manufacture non-penicillin products (including certifiable antibiotic products) on the same premises or use the same equipment as that used for manufacturing penicillin products, or that operate under any circumstances that may be regarded as conducive to contamination of other drugs by

penicillin, shall test such non-penicillin products. Such products shall not be marketed if intended for use in man and the product is contaminated with an amount of penicillin equivalent to 0.05 units or more of penicillin "G" per maximum single dose recommended in the labeling of a drug intended for oral use.

AUTHORITY NOTE: Promulgated in accordance with the provisions of R.S. 40:4(A)(1)(a). Also see R.S. 40:601 et seq.

HISTORICAL NOTE: Promulgated by the Department of Health and Hospitals, Office of Public Health, LR 28:1254 (June 2002).

§1527. Stability **[formerly paragraph 6:206]**

A. There shall be assurance of the stability of the finished drug products. This stability shall be:

1. [formerly paragraph 6:206-1] determined by reliable, specific test methods;

2. [formerly paragraph 6:206-2] determined on products in the same container closure system in which they are marketed;

3. [formerly paragraph 6:206-3] determined on any dry drug product that is to be reconstituted at the time of dispensing (as directed in its labeling) as well as on the reconstituted product;

4. [formerly paragraph 6:206-4] recorded and maintained in such a manner that the stability data may be utilized in establishing product expiration dates.

AUTHORITY NOTE: Promulgated in accordance with the provisions of R.S. 40:4(A)(1)(a). Also see R.S. 40:601 et seq.

HISTORICAL NOTE: Promulgated by the Department of Health and Hospitals, Office of Public Health, LR 28:1255 (June 2002).

§1529. Expiration Dating **[formerly paragraph 6:207]**

A. To assure that the drug product liable to deterioration meets appropriate standards of identity, strength, quality and purity at the time of use, the label of all such drugs shall have suitable expiration dates which relate to the stability test performed on the product.

1. [formerly paragraph 6:207-1] Expiration dates appearing on the drug product label shall be justified by readily available data from stability studies such as described in §1527.

2. [formerly paragraph 6:207-2] Expiration dates shall be related to storage conditions stated on the labeling wherever the expiration date appears.

3. [formerly paragraph 6:207-3] When the drug is marketed in the dry state for use in preparing a liquid product, the label shall bear expiration date and information for the reconstituted product as well as an expiration date for the product.

AUTHORITY NOTE: Promulgated in accordance with the provisions of R.S. 40:4(A)(1)(a). Also see R.S. 40:601 et seq.

HISTORICAL NOTE: Promulgated by the Department of Health and Hospitals, Office of Public Health, LR 28:1255 (June 2002).

§1531. Packaging and Labeling
[formerly paragraph 6:208]

A. Packaging and labeling operations shall be controlled to assure that only those products that have met the standards and specifications in their master production and control records shall be distributed; to prevent mix-ups between drugs during filling, packaging and labeling operations to assure that correct labels and labeling are employed for the drug and to identify the finished product with a lot or control number that permits determination of the history of the manufacture and control of the batch. An hour, day or shift code is appropriate as a lot or control number for drug products manufactured or processed in continuous production equipment. Packaging and labeling operations shall:

1. [formerly paragraph 6:208-1] be separated (physically or spatially) from operations on other drugs in a manner so as to avoid mix-ups and minimize cross-contamination. Two or more packaging or labeling operations having drugs, containers or labeling similar in appearance shall not be in process simultaneously on adjacent or nearby lines unless these operations are separated physically or spatially;

2. [formerly paragraph 6:208-2] provide for an inspection of the facilities prior to use to assure that all drugs and previously used products and labeling materials have been removed;

3. [formerly paragraph 6:208-3] include the following labeling controls:

a. [formerly paragraph 6:208-3 (1)] the holding of labels and package labeling upon receipt pending review and proofing against an approved final copy to assure that they are accurate regarding identity, and content before release to inventory;

b. [formerly paragraph 6:208-3 (2)] the maintenance and storage of each type of label and package labeling representing different products, strength, dosage forms or quantity of contents in such a manner as to prevent mix-ups and provide identification;

c. [formerly paragraph 6:208-3 (3)] a system for assuring that only current labels and package labeling are retained and that stocks of obsolete package labeling are destroyed;

d. [formerly paragraph 6:208-3 (4)] restriction of access to labels and package labeling to authorized personnel;

e. [formerly paragraph 6:208-3 (5)] avoidance of gang printing of cut labels, cartons or inserts when the labels, cartons or inserts are for different products or different strengths of the same products or are of the same size and have identical or similar format and/or color schemes. If gang printing is employed, packaging and

labeling operation shall provide for added control procedures. These added controls should consider sheet layout, stacking, cutting and handling during and after printing;

4. [formerly paragraph 6:208-4] provide for strict control of the package labeling issued for use with the drug. Such issue shall be carefully checked by a competent individual for identity and conformity to the labeling specified in the batch production. Said individual shall reconcile any discrepancy between the quantity of the drug finished and the quantities of labels issued;

5. [formerly paragraph 6:208-5] provide for examination or laboratory testing of samples of finished product after packaging and labeling to safeguard against any errors in the finished operation and to prevent distribution of any batch until all tests have been met.

AUTHORITY NOTE: Promulgated in accordance with the provisions of R.S. 40:4(A)(1)(a). Also see R.S. 40:601 et seq.

HISTORICAL NOTE: Promulgated by the Department of Health and Hospitals, Office of Public Health, LR 28:1255 (June 2002).

§1533. Records and Reports
[formerly paragraph 6:209-1]

A. To assure uniformity from batch to batch, a master production and control record for each drug product and each batch size of drug product shall be independently checked, reconciled, dated and signed or initialed by a second. The master production and control record shall include:

1. [formerly paragraph 6:209-1 (1)] the name of the product, description of the dosage form and a specimen of the copy of each label and all other labeling associated with the retail or bulk unit, including copies of such labeling signed or initialized and dated by the person or persons responsible for the approval of such labeling;

2. [formerly paragraph 6:209-1 (2)] the name and weight or measure of each active ingredient per dosage unit, or per unit of weight or measure of the finished drug, and statement of the total weight or measure of any dosage unit;

3.a. [formerly paragraph 6:209-1 (3)] a complete list of ingredients designated by names or codes to indicate any special quality characteristic;

b. an accurate statement of the weight or measure of each ingredient, regardless of whether it appears in the finished product. Reasonable variations may be permitted in the amount of components necessary in the preparation in dosage form, provided that provisions for such variations are included in the master production and control record;

c. a statement of theoretical weight or measure at various stages of processing and a statement of theoretical yield;

4. [formerly paragraph 6:209-1 (4)] a description of the containers, closures and packaging and finishing materials;

5. [formerly paragraph 6:209-1 (5)] manufacturing and control instructions, procedures and specifications, special notations and precautions to be followed.

B. The batch production and control record shall be prepared for each batch of drug produced and shall include complete information relating to the production and control of each batch. These records shall be retained for at least two years after the batch distribution is complete or at least one year after the batch expiration date, whichever is longer. These records shall identify the specific labeling and lot or control numbers used on the batch, and shall be readily available during such retention period. The batch record shall include:

1. [formerly paragraph 6:209-2 (1)] an accurate reproduction of the master formula record checked, dated and signed or initialed by a person responsible for the approval of this record;

2. [formerly paragraph 6:209-2 (2)] a record of each step in the manufacturing, processing, packaging, labeling, testing and controlling of the batch, including dates, individual major equipment and lines employed, specific identification of each batch of components used, weights and measures of components and products used in the course of processing, in-process and laboratory control results and identification and checking each significant step in the operation;

3. [formerly paragraph 6: 209-2 (3)] a batch number that identifies all the production and control documents relating to the history of the batch and all lot and control numbers associated with the batch;

4. [formerly paragraph 6:209-2 (4)] a record of any investigation made according to §1533.A.

AUTHORITY NOTE: Promulgated in accordance with the provisions of R.S. 40:4(A)(1)(a). Also see R.S. 40:601 et seq.

HISTORICAL NOTE: Promulgated by the Department of Health and Hospitals, Office of Public Health, LR 28:1256 (June 2002).

§1535. Distribution Records **[formerly paragraph 6:209-3]**

A. Finished goods warehouse control and distribution procedures shall include a system by which the distribution of each lot of drug can be readily determined to facilitate its recall if necessary. Records within the system shall contain the name and address of the consignee, date and quantity shipped and lot or control number of the drug. They shall be kept for two years after the batch has been completed or one year after the expiration of the drugs, whichever is longer.

B. [formerly paragraph 6:209-4] To assure the quality of the product, finished goods warehouse control shall also include a system whereby the oldest stock is distributed first whenever possible.

AUTHORITY NOTE: Promulgated in accordance with the provisions of R.S. 40:4(A)(1)(a). Also see R.S. 40:601 et seq.

HISTORICAL NOTE: Promulgated by the Department of Health and Hospitals, Office of Public Health, LR 28:1256 (June 2002).

§1537. Complaint Files **[formerly paragraph 6:210]**

A. Records shall be maintained of all written and oral complaints regarding each product. An investigation of each complaint shall be made in accordance with Part I of this Code. The record of each investigation shall be maintained for at least two years after the distribution of the drug has been completed or one year after the expiration date, whichever is longer.

AUTHORITY NOTE: Promulgated in accordance with the provisions of R.S. 40:4(A)(1)(a). Also see R.S. 40:601 et seq.

HISTORICAL NOTE: Promulgated by the Department of Health and Hospitals, Office of Public Health, LR 28:1256 (June 2002).

Chapter 17. Drug Distributors, Drug Wholesalers and Drug Storage Warehouses

§1701. Definitions **[formerly paragraph 6:211]**

A. Unless otherwise specifically provided herein, the following words and terms used in this Part of the sanitary code, and all other Parts which are adopted or may be adopted, are defined for the purposes thereof as follows.

Drug Wholesaler or Drug Distributor—any person or establishment that distributes drugs other than to the ultimate consumer.

AUTHORITY NOTE: Promulgated in accordance with the provisions of R.S. 40:4(A)(1)(a). Also see R.S. 40:601 et seq.

HISTORICAL NOTE: Promulgated by the Department of Health and Hospitals, Office of Public Health, LR 28:1257 (June 2002).

§1703. Permits **[formerly paragraph 6:212]**

A. No person shall operate as a drug wholesaler, drug distributor or operate a drug warehouse within the state of Louisiana without first applying for, paying required fee and obtaining a permit to operate issued by the state health officer. Operating without such permit is a violation of this Code.

B. Every establishment regulated by this Part shall have displayed at all times a permit to operate.

AUTHORITY NOTE: Promulgated in accordance with the provisions of R.S. 40:4(A)(1)(a). Also see R.S. 40:601 et seq.

HISTORICAL NOTE: Promulgated by the Department of Health and Hospitals, Office of Public Health, LR 28:1257 (June 2002).

§1705. Buildings **[formerly paragraph 6:213]**

A. All buildings shall be maintained in a clean and orderly manner approved by the state health officer and shall be large enough and constructed and located in a way to facilitate cleaning and maintenance of good storage conditions of drugs and drug products.

B. [formerly paragraph 6:214] All buildings shall be well lighted and ventilated.

C. [formerly paragraph 6:215] All floors, walls, ceilings, tables and other fixtures shall be constructed of such materials that they may be readily cleaned.

D. [formerly paragraph 6:216] All buildings shall be free of flies, rats, mice and other vermin. All insecticides and pesticides used shall be approved by the state health officer.

E. [formerly paragraph 6:217] All buildings shall provide locker facilities for employee clothing and belongings. Provide washing facilities equipped with hot and cold water under pressure, delivered through a mixing faucet. Soap and sanitary towels or air dryer shall be provided at each lavatory.

AUTHORITY NOTE: Promulgated in accordance with the provisions of R.S. 40:4(A)(1)(a). Also see R.S. 40:601 et seq.

HISTORICAL NOTE: Promulgated by the Department of Health and Hospitals, Office of Public Health, LR 28:1257 (June 2002).

§1707. Premises

[formerly paragraph 6:218]

A. All grounds where buildings are located shall be properly graded to provide a natural drainage, thus preventing an accumulation of stagnant water and other material.

B. [formerly paragraph 6:219] No litter, waste or refuse shall be allowed to accumulate in and around the building or

yards. Waste shall be removed and disposed of in an approved manner.

AUTHORITY NOTE: Promulgated in accordance with the provisions of R.S. 40:4(A)(1)(a). Also see R.S. 40:601 et seq.

HISTORICAL NOTE: Promulgated by the Department of Health and Hospitals, Office of Public Health, LR 28:1257 (June 2002).

§1709. Water Supply

[formerly paragraph 6:220]

A. An ample supply of potable water (Part XII) under pressure shall be provided on the premises for drinking, cleaning, washing or other purposes. Such water supply shall not be connected to any other supply.

AUTHORITY NOTE: Promulgated in accordance with the provisions of R.S. 40:4(A)(1)(a). Also see R.S. 40:601 et seq.

HISTORICAL NOTE: Promulgated by the Department of Health and Hospitals, Office of Public Health, LR 28:1257 (June 2002).

§1711. Records

[formerly paragraph 6:221]

A. Readily retrievable records shall be maintained which will show the disposition of all prescription items. Such records shall be retained for two years.

AUTHORITY NOTE: Promulgated in accordance with the provisions of R.S. 40:4(A)(1)(a). Also see R.S. 40:601 et seq.

HISTORICAL NOTE: Promulgated by the Department of Health and Hospitals, Office of Public Health, LR 28:1257 (June 2002).

Title 51
PUBLIC HEALTH—SANITARY CODE
Part VII. Dairy Products Regulations

Chapter 1. Milk and Dairy Products

§101. Definitions

A. Unless otherwise specifically provided herein, the following words and terms used in this Part of the *Sanitary Code*, and all other Parts which are adopted or may be adopted, are defined for the purposes thereof as follows.

3-A Standards—standards for dairy equipment and accepted practices promulgated jointly by the Sanitary Standards Subcommittee of the Dairy Industry Committee, the Committee on Sanitary Procedure of the International Subcommittee of the International Association for Food Protection and the Milk Safety Branch, the U. S. Food and Drug Administration (FDA), Public Health Service (PHS), Center for Food Safety and Applied Nutrition, Department of Health and Human Services. Equipment manufactured in conformity with the 3-A Standards complies with the sanitary design and construction standards of this Part. Copies may be obtained from 3-A Sanitary Standards Incorporated, 6888 Elm Street Suite 2D, McLean, Virginia 22101; (Internet URL address: “<http://www.3-A.org/>”).

Abnormal Milk—any milk or milk product shall be deemed to be abnormal if:

- a. it is visibly changed in color, odor and/or texture from that of normal color, odor and/or texture;
- b. prior to milking of the animal, it is known to be unsuitable for human consumption (such as milk containing colostrum); or
- c. it is unfit for human consumption following treatment of the animal with veterinary products (i.e., antibiotics and other drugs which have withhold requirements) or following treatment or consumption of medicines or insecticides or other toxic compounds not approved for use on dairy animals by the FDA, Environmental Protection Agency (EPA) or the state health officer.

Acidified Milk and Acidified Milk Products, Acidified Filled Milk and Acidified Filled Milk Products, Acidified Anomalous Milk and Acidified Anomalous Milk Products—a milk product obtained by souring milk or milk products, filled milk or filled milk products or anomalous milk or anomalous milk products after pasteurization, ultra-pasteurization or aseptic processing with acetic acid, adipic acid, citric acid, fumaric acid, glucono-delta-lactone, hydrochloric acid, lactic acid, malic acid, phosphoric acid, succinic acid, tartaric acid or other substances, with or without the addition of characterizing microorganisms. Nutritive carbohydrate sweeteners or other sweeteners approved for use by the FDA, flavoring ingredients,

stabilizers or salt may be added. All ingredients shall have been declared to be safe and suitable by the FDA. The acidified products shall contain a titratable acidity of not less than 0.5 percent calculated as lactic acid.

Adulterated Milk, Milk Products, or Dairy Products—any milk, milk products, or dairy products shall be deemed to be adulterated:

- a. if it is defined in these regulations and fails to conform to its definition or if it otherwise fails to conform to its standard of identity;
- b. if it contains any unwholesome substance; or
- c. if [other than in anomalous (substitute) milk and anomalous (substitute) milk products, filled milk and filled milk products, and imitation milk or imitation milk products] any substance has been substituted wholly, or in part, for any substance naturally inherent in the milk, milk product, or dairy product.

Aged Cheese—see ripened or aged cheese.

Air Gap—the unobstructed vertical distance through the free atmosphere of at least twice the diameter of the largest incoming water, dairy product, Clean-In-Place (CIP) solution or other liquid supply pipe, faucet or valve to the flood level rim of the receiving vessel or receptacle, to prevent back siphonage of solutions in the receiving vessel or receptacle. The distance of the air gap is to be measured from the bottom of the inlet supply pipe, faucet or valve to the top of the effective overflow, i.e., flood level rim of the receiving vessel. In no case may the effective air gap be less than one inch (2.54 cm.). Tanks or vats or any other receiving vessel with water inlets below the flood level rim shall comply with the American Society of Mechanical Engineers (ASME) standard A112.1.2 (1991).

Anomalous (Substitute) Milk and Anomalous (Substitute) Milk Products—food that is not in conformity with the definitions and standards of identity contained in this Part or Title 21, Code of Federal Regulations (21 CFR) Part 131 (Milk and Cream), 21 CFR 133.128 (Cottage Cheese) and 21 CFR 133.129 (Dry Curd Cottage Cheese), but is made in semblance of, and resembles a standardized milk or milk product [milk and milk products that are in conformity with the definitions and standards of identity contained in 21 CFR Part 131 (Milk and Cream), 21 CFR 133.128 (Cottage Cheese) and 21 CFR 133.129 (Dry Curd Cottage Cheese)] in physical characteristics, sensory properties, manner in which it is manufactured or processed, functional attributes, propensity to support the growth of pathogenic microorganisms of human significance and being of such nature that it is not nutritionally inferior to, and may be used interchangeably with, the milk or milk product it

resembles. These products are usually packed in containers similar to those in which Grade A milk and milk products are packaged, such as paper cartons, plastic bottles or jugs, pouches, plastic cups, tubs, etc. Anomalous (substitute) milk or anomalous (substitute) milk products are manufactured or processed in whole or in part from milk or milk products. The state health officer may, utilizing the aforesaid criteria, specify that a food is an anomalous (substitute) milk or milk product. Foods that have been retort processed after packaging or which have been dried shall not be included in this definition. Anomalous (substitute) milk and anomalous (substitute) milk products shall conform with the requirements contained in 21 CFR §101.13 (nutrient content claims-general principles). Anomalous (substitute) milk and anomalous (substitute) milk products shall be labeled with a descriptive name which shall be suggestive enough to reveal the basic composition of the product and alleviate any questions regarding the product's identity (some names commonly used are "dairy blend," "dairy beverage," "shakes," "cultured dairy blends," etc.).

a. These products may be reduced fat, lowfat, non fat or flavored. All dairy ingredients used in these products (milk, lower fat milks, condensed, evaporated or concentrated milks, dry milks, whey, protein concentrate, milk protein concentrate, filtered milk, etc.) shall be Grade A. The descriptive name (term) shall not selectively exaggerate the presence of one or more ingredients over all other ingredients present in the product as to be misleading or deceptive. Labels for anomalous (substitute) milk or milk products shall be approved by the state health officer prior to the product being offered for sale in the state. In cases in which there is a difference in performance characteristics that materially limit the use of the product, the label shall include a disclaimer, adjacent to the most prominent claim, informing the consumer of such difference (e.g., "not recommended for melting"). Anomalous (substitute) milk and anomalous (substitute) milk products shall conform to the Grade A bacteriological standards/specifications contained in this Part. Plants that manufacture or process anomalous (substitute) milk or anomalous (substitute) milk products for sale in the state shall conform with the requirements for Grade A dairy plants contained in this Part.

Anomalous (Substitute) Dairy Products—any food that is not in conformity with the standards of identity contained in this Part, 21CFR Part 131, 21 CFR Part 133, 21 CFR Part 135, 21 United States Code (USC) Part 321a, but is made in semblance of and resembles a dairy product that is in conformity with the aforesaid standards of identity in physical characteristics, sensory properties, manner in which it is manufactured or processed, functional attributes, propensity to support the growth of pathogenic microorganisms of human significance and being of such nature that it is not nutritionally inferior to, and may be used interchangeably with, the dairy product it resembles. Anomalous (substitute) dairy products are manufactured in whole or in part from butter, cheese (whether natural or processed), milk, lower fat milks, nonfat (fat free, skim) milk, cream, whey, buttermilk (whether dry, evaporated, concentrated, stabilized or frozen) and any other food which

the state health officer may, utilizing the above criteria, specify that a food is anomalous (substitute) dairy product. Anomalous (substitute) dairy products shall conform with the bacteriological standards/specifications contained in this part, determined by the state health officer to be applicable to such products. Anomalous (substitute) dairy products that have been retort processed after packaging or which have been concentrated, condensed and dried shall be included in this definition. Plants that manufacture or process anomalous (substitute) dairy products shall conform with the requirements for dairy plants contained in this Part, determined by the state health officer to be applicable to such plants.

Approved by the FDA or With the Concurrence of the FDA—the equipment, processes, policies, decisions or any other items referenced are consistent with published requirements, policies, standards and recommendations contained in publications in the Pasteurized Milk Ordinance (PMO), Procedures Governing the State-Public Health Service/Food and Drug Administration Program of the National Conference on Interstate Milk Shipments, Methods of Making Sanitation Ratings of Milk Shippers, Memoranda, etc., acceptable to the FDA Milk Safety Branch (HFS-626) (FDA/CFSAN/OC/DCP/MST) or concurrence has been obtained by the state health officer from the Milk Safety Branch/Team.

Aseptic Processing—the filling of a commercially sterilized, cooled dairy product into presterilized containers, followed by aseptic hermetic sealing with presterilized closure in an atmosphere free of microorganisms in such a manner that conforms with the requirements of 21 Code of Federal Regulations (CFR) 113 and the provisions of §7, Item 16p of the PMO. The product must maintain commercial sterility under normal non-refrigerated conditions.

Audit—an evaluation made by the state health officer of a dairy facility, the operations conducted therein, the facility's Hazard Analysis Critical Control Points (HACCP) plan and records documenting the implementation of the HACCP system, to determine whether or not all food safety hazards, reasonably likely to occur in each product produced or processed by the facility are being effectively controlled on a continual basis and to determine whether or not the plant is in compliance with the requirements contained in this Part. Personnel conducting such audits shall have been trained in accordance with the requirements for such regulatory auditors contained in the PMO, Appendix K, § IV (3).

Automatic Milking Installation (AMI)—an automated milking system, used to milk cows and other hooved mammals, that conforms with the requirements contained in Appendix Q of the PMO.

Bacterial Plate Count, Direct Microscopic Count, Coliform Determinations, Mastitis Tests—the results of laboratory analysis of milk or dairy products samples taken upon separate days, irrespective of the date of grading or regrading. Laboratory tests shall conform to the procedures

in the “*Standard Methods for the Examination of Dairy Products*” (17th Edition, 2004, as amended) American Public Health Association.

Bacteriological Analytical Manual (BAM)—the bacteriological analytical manual found on the FDA/CFSAN (FDA/Center for Food Safety and Applied Nutrition) internet site and is designated the BAM online; (Internet URL address: <http://www.cfsan.fda.gov/~ebam/bam-mm.html#updates>).

Boiled Custard—see *Egg Nog*.

Blended Dry Dairy Products and Dry Blended Dairy Products—products in which the predominant ingredient is a dry dairy product and results from the blending of dry dairy products or the blending of dry dairy products with other safe and suitable dry non-milk derived ingredients approved by the state health officer. These foods may be blended before or after drying.

Broke and Trim—paper and paperboard that have been discarded anywhere in the process of manufacture, such as on paper-making machines in the form of trim. This may also include unprinted trim from the converting process, provided the trim has been handled, treated and transported in a clean, sanitary manner.

BTU—interstate milk shippers bulk tank unit identification number (for groups of dairy farms that pool part or all of their milk produced for sale to a dairy plant).

Bulk Milk Tank Truck Operator/Sampler—a person who collects official samples of raw milk and may transport raw milk from a farm to a milk plant, receiving station or transfer station and has in his/her possession a permit to sample such products issued by a state regulatory agency.

Bulk Milk Pickup Tanker—a milk tank truck and its appurtenances used by a bulk milk tank truck operator/sampler to transport bulk raw milk for pasteurization from dairy farms to a milk plant, receiving station or transfer station.

Butter—the dairy product resulting from the churning of the pasteurized, ultra-pasteurized or aseptically processed milk fat of milk or cream, or both, with or without common salt, with or without additional coloring matter, and containing not less than 80 percent, by weight of milk fat for all tolerances having been allowed. Butter shall be manufactured only in dairy plants that conform to each of the requirements for butter plants contained in Chapter 23 of this Part.

Buttermilk—the fluid dairy product resulting from the manufacture of butter from milk, cream or from the souring, or treatment by a lactic acid or other culture approved by the state health officer, of pasteurized, ultra-pasteurized or aseptically processed milk or lower fat milks. It shall contain not less than 8.25 percent of milk solids-non-fat. It may contain concentrated milk or lower fat milks, dry milk, whey, lactose, lactalbumins, lactoglobulins or modified whey.

Butter Plants—dairy plants that manufacture, process or package butter or butter related products.

Butter Products (Butter Related Products)—dairy products that contain butter as the predominant ingredient. They may contain other safe and suitable ingredients Generally Recognized As Safe (GRAS) by the FDA and the state health officer. The products may contain less than 80 percent by weight of milk fat and may be whipped or otherwise modified in texture. These products shall conform to the bacteriological requirements for butter contained in this Part and shall be manufactured in a dairy plant that conforms to each requirement for butter plants contained in Chapter 23 of this Part.

CFU—colony-forming units.

Certified by the FDA—the person certified has successfully completed the certification process administered by PHS/FDA and possesses a current, valid, certificate of certification issued by the PHS/FDA.

Cheese—the product resulting from the drained curd (coagulated mass) obtained by the coagulation of milk, lower fat milks (whether concentrated, condensed or reconstituted) which may be enriched with milk fat or other derived ingredients GRAS by the FDA. The coagulation may be accomplished by:

a. inoculating with lactic acid and producing microorganisms, with or without rennet and with or without other safe and suitable coagulating enzymes GRAS by the FDA and the state health officer;

b. rennet or other coagulating enzymes that are GRAS; and

c. the addition of lactic acid, citric acid, phosphoric acid, hydrochloric acid, D-glucono-delta-lactone or other coagulating substances that are GRAS. The curd may be modified by cutting, warming, stirring, pressing, draining, molding, ripening, fermenting, blending, seasoning with ingredients that are GRAS, colored with colorings that are GRAS. Functional ingredients that are GRAS may be used. The manner in which cheese is processed, the milk or dairy product from which it is processed, the specific lactic acid producing and in some cases gas forming microorganisms, coagulating enzymes, functional and optional ingredients vary according to the type or variety of cheese or related cheese product. There are numerous types and varieties of cheese, including American Cheese, Asiago Cheese, Blue Cheese, Brick Cheese, Camembert Cheese, Cheddar Cheese, Colby Cheese, Cream Cheese, Edam Cheese, Feta Cheese, Gouda Cheese, Limburger Cheese, Mozzarella Cheese, Muenster Cheese, Neufchatel Cheese, Parmesan Cheese, Process Cheese, Provolone Cheese, Ricotta Cheese, Romano Cheese, Roquefort Cheese, Swiss Cheese and many other types and varieties. Each type and variety of cheese shall conform with the standard of identity for such cheese contained in this Part or the PMO, 21 CFR or 7 CFR. These regulations shall apply to all cheese made from the milk of any hooved mammal, provided that where the milk or part of the milk used in the manufacture of cheese is the milk of

hooved mammals other than cows, the cheese shall be so labeled.

Cheese Manufacturing Plants—dairy plants that manufacture, process, cut, slice or package cheese and cheese related products.

Cheese Products, Cheese Foods (Cheese Related Products)—foods that contain cheese as the predominant ingredient. They may contain other safe and suitable ingredients GRAS by the FDA and the state health officer. These products may be modified in texture, taste and color. These products shall conform to the bacteriological requirements for cheese contained in this Part and shall be manufactured in a dairy plant that conforms to the requirements for cheese manufacturing plants contained in Chapter 25 of this Part.

Clean—surfaces that have had the effective and thorough removal of product and contaminants.

Cleaned-In-Place (CIP)—the procedure by which sanitary pipelines or other pieces of dairy equipment are mechanically cleaned-in-place by circulation of cleaning and sanitizing solutions.

Cleaned-Out-of Place (COP)—the procedure by which pieces of dairy equipment are placed in a vat equipped with a system that cleans by circulation of cleaning and sanitizing solutions.

Cleaning and Sanitizing Tag (Wash Tag)—tag affixed to the outlet valve or in the near vicinity of the outlet valve of the milk tank truck, which verifies proper cleaning and sanitizing.

Closure—a cap, lid, seal, tube, valve, lidding material or other device in or on a container used for the purpose of enclosing or dispensing the contents.

Coatings—any layer or covering which is applied to the product contact surface.

Code of Federal Regulations (CFR)—except as otherwise indicated, the April 1, 2010 edition, as amended, of title 21 (21 CFR, *Food and Drugs*) and the January 1, 2010 edition, as amended, of title 7 (7 CFR, *Agriculture*) of the document, so titled and published by the United States Office of the Federal Register, National Archives and Records Administration.

Component Part—any item that by itself, does not perform any function, but when assembled with one or more component parts or closures, becomes a part of the single service container or closure. These may include, but are not limited to, blanks, sheeting, filling valve parts, tubes, dispensing devices and sampling containers. All material used for fabrication of a component part must meet the requirements of the *Federal Food, Drug and Cosmetic Act*, as amended.

Concentrated or Condensed Milk—a fluid product, unsterilized and unsweetened, resulting from the removal of a considerable portion of the water from the milk, which when combined with potable water in accordance with

instructions printed on the container label, results in a product conforming with the milk fat and milk solids not fat levels of milk as defined in this Part.

Cooling Pond—a man-made structure that conforms with the requirements of this Part and the PMO designed for the specific purpose of cooling cows.

*Cottage Cheese**—the soft uncured cheese prepared from the curd obtained by adding harmless lactic acid-producing bacteria, with or without rennet, to pasteurized nonfat (fat free, skim) milk. It contains not more than 80 percent moisture content to not less than 0.5 percent or not more than 2 percent. All cottage cheese sold in the State shall be Grade A.

Cream—liquid milk product high in fat separated from milk which may have been adjusted by adding thereto: milk, concentrated milk and lower fat milks or dry milk or lower fat dry milks and may be modified by whipping, acidifying or culturing. Cream contains not less than 18 percent milk fat.

Creamed Cottage Cheese—the soft uncured cheese prepared by mixing cottage cheese with pasteurized cream or a pasteurized mixture of cream with milk or nonfat (fat free, skim) milk, which contains not less than 4 percent of milk fat by weight, nor more than 80 percent of moisture.

Creole Cream Cheese or Creole Cheese—the soft uncured cheese prepared by culturing pasteurized, ultra-pasteurized or aseptically processed milk, nonfat milk or lowfat milk with harmless lactic acid bacteria and coagulating milk with this culture or rennet or other safe and suitable milk clotting enzymes. The curd is drained in molds prior to packaging. Prior to packaging a creaming mixture may or may not be added to the curd. All dairy ingredients used in Creole Cream Cheese and Creole Cheese shall be Grade A. Dairy plants in which these cheeses are manufactured shall conform with the requirements for Grade A milk and milk products contained in this Part.

Cultured Milk and Cultured Milk Products, Cultured Anomalous Milk and Cultured Anomalous Milk Products and Cultured Filled Milk and Cultured Filled Milk Products—foods produced by culturing pasteurized, ultra-pasteurized or aseptically processed milk or milk products, anomalous milk or anomalous milk products or filled milk or filled milk products with characterizing microorganisms. Sweeteners, flavor and aroma producing ingredients, salt, citric acid or sodium citrate may be added. All ingredients shall have been declared safe and suitable for use in the products by FDA and the state health officer. The cultured products shall contain a titratable acidity of not less than 0.5 percent by weight calculated as lactic acid. The name of these cultured products shall be accompanied by a declaration indicating the presence of any characterizing flavoring and by a declaration such as a traditional name of the microorganisms used thereby indicating the presence of the microbial organisms used as ingredients, e.g., “Kefir Cultured Milk”, “Kefir Milk with Vegetable Fat”, “Kefir Cultured Dairy Beverage”, “Acidophilis Cultured Milk”, etc.

When lactic acid producing microorganisms are used, the food may be named “Cultured Buttermilk”.

Dairy Facility—includes dairy farms, milk tank trucks, milk tank truck cleaning facilities, receiving stations, transfer stations, dairy plants, finished product depots, finished product transfer points, single service containers and closures for milk and milk products manufacturing plants and vehicles used to transport dairy products.

Dairy Farm—any place or premises where one or more cows, goats, sheep, water buffaloes or other hooved mammals are kept for milking and from which a part or all of the milk produced is provided, sold, or offered for sale to a dairy plant, transfer station, or receiving station possessing a permit from the state milk regulatory agency.

Dairy Plant—any place, premises or establishment where milk, milk products (including frozen desserts, frozen dessert mixes, filled milk or filled milk products, anomalous milk, anomalous milk products or anomalous dairy products) and dairy products are collected, handled, processed, stored, pasteurized, ultra-pasteurized, aseptically processed, churned, frozen, dried, blended, concentrated, condensed, packaged or prepared for distribution and where milk tank trucks are cleaned and sanitized when received.

Dairy Plant Receiver/Sampler—a person who collects official milk and milk product samples from milk transport tank trucks and other types of containers of milk and milk products being received by a dairy plant or receiving station and may also unload such milk transport tank trucks and containers.

Dairy Product Condensing, Concentrating, Drying or Blending Plants—dairy plants that condense, concentrate, dry or blend dry dairy products.

Dairy Product Distributor—any person who offers for sale or sells to another any processed milk or dairy products for human consumption as such.

Dairy Products—include but are not limited to milk and milk products, anomalous milk and anomalous milk products, filled milk and filled milk products, whey and whey products, imitation milk and imitation milk products (whether the aforesaid products have been acidified, condensed, concentrated, cultured, dried, flavored, frozen or stabilized), frozen desserts, frozen dessert mixes, butter, butter products, cheese (whether natural or processed), cheese products and any food which is prepared or manufactured in whole or in part from any of the aforesaid products which the state health officer may hereafter so designate. All dairy products produced, manufactured or sold in the state shall comply with the chemical and bacteriological standards and specifications contained in this Part, determined by the state health officer to be applicable to each product. Dairy products processed, manufactured or sold in the state shall be processed or manufactured in plants that are in conformity with the requirements for dairy plants contained in this Part as determined by the state health officer to be applicable to each plant.

Dry Cream—product obtained by removal of water only, from pasteurized milk or cream or a mixture thereof, which may have been homogenized. Alternatively, dry cream may be obtained by blending dry milks and dry cream, provided, that the resulting product is equivalent in composition to that obtained by the method described in the first sentence of this paragraph, it contains not less than 40 percent but less than 75 percent by weight of milk fat on an as is basis and it contains not more than 5 percent by weight of moisture on a milk solids not-fat basis. Safe and suitable sweeteners, fruit and fruit juices, characterizing flavoring ingredients, colorings and artificial flavorings as approved by the state health officer may be added.

Dry Milk (Powdered Milk)—the product resulting from the removal of water from milk or lower fat milks and contains the milk fat, lactose, milk proteins and milk minerals in the same relative proportions as in the milk from which it is made. It contains not more than 2.5 percent by weight of moisture. Said product has been processed in compliance with Chapter 21 of this Part.

Dry Dairy Products—include dry milk (powdered milk), nonfat dry milk [powdered nonfat (fat free, skim) milk], instant nonfat dry milk, dry whey, dry buttermilk and any other products resulting from the combination of dry milk products with other wholesome dry ingredients, and which comply with and have been processed in compliance with the applicable provisions of Chapter 21 of this Part.

Egg Nog or Boiled Custard—food consisting of a mixture of milk, nonfat (fat free, skim) milk, nonfat dry milk, buttermilk, whey, lactose, lactalbumins, lactoglobulins or modified whey. It shall contain not less than 1.0 percent by weight of egg yolk solids in the finished food and nutritive carbohydrate sweeteners. Egg nog or boiled custard shall contain not less than 6 percent milk fat and not less than 8.25 percent milk solids not fat. The food shall be pasteurized, ultra-pasteurized or aseptically processed.

EPA—United States Environmental Protection Agency.

Evaluation of Milk Laboratories—2007 Revision, published by the U.S. Department of Health and Human Services, Public Health Service, Food and Drug Administration.

Extra Grade and Standard Grade Dry Dairy Products—products resulting from the drying of pasteurized milk or milk products in dairy plants that are in substantial compliance with all of the requirements of this Part for dairy products condensing, dairy products drying or dairy products blending plants.

FDA—United States Department of Health and Human Services, Food and Drug Administration.

FDD—flow diversion device.

Filled Dairy Products—any food product made by combining, blending or compounding milk or derivatives of milk with any fat or oil other than milk fat so that the resulting product resembles in sensory properties and physical characteristics (taste, appearance, texture or

consistency) a dairy product. The above definition shall not include any distinctive proprietary food compound not readily mistaken for a dairy product in taste or appearance. Filled dairy products shall conform with the microbiological requirements of this Part determined by the state health officer to be applicable to the product and shall be processed in plants that conform with the requirements of this Part, determined by the state health officer to be applicable to such plant facility.

Filled Milk and Filled Milk Products—any milk, lower fat milks, cream (whether or not condensed, evaporated, concentrated, powdered, dried or desiccated) to which has been added, or which has been blended or compounded with, any fat or oil other than milk fat, so that the resulting product is in imitation of, or is in semblance of, and resembles, milk, lower fat milks or cream (whether or not condensed, concentrated, powdered, dried or desiccated) in physical characteristics, sensory properties, functional attributes and being of such nature that it may be used interchangeably with the milk or milk product it resembles (whether condensed, concentrated, powdered, dried or desiccated). Filled milk or filled milk products shall be labeled with a descriptive name, which is suggestive enough to identify the milk or milk product it resembles, followed by a qualifier that accurately describes what the product is (examples: “Filled Milk - Non Fat Milk with Vegetable Fat”, “Filled Cream - Non Fat Dry Milk with Vegetable Fat”, etc.). This definition shall not include any distinctive proprietary food compound readily mistaken in physical characteristics, sensory properties, and functional attributes such that it resembles milk or milk products (whether or not condensed, concentrated, powdered, dried or desiccated) but is of such a nature that it is not reasonably likely to be used interchangeably for a milk or milk product. Nothing in this definition shall be used to prevent the use, blending or compounding of chocolate as a flavor to milk, lower fat milks or cream to which no other fats or oils have been added, blended or compounded. Filled milk and filled milk products shall conform with the microbiological standards for Grade A milk and milk products contained in this Part. Plants that process or manufacture filled milk or filled milk products shall conform with the requirements for Grade A dairy plants contained in this Part.

Finished Dairy Products Depots—establishments in which dairy products contained in their final packages are unloaded from refrigerated transport trucks, stored and reloaded onto refrigerated delivery trucks for transport to retail sales outlets or to other finished dairy products depots or transfer points.

Finished Dairy Product Transfer Points—premises upon which dairy products in their final containers are unloaded from refrigerated transport trucks and loaded into delivery trucks or other refrigerated transport trucks.

Federal Information Processing Standards (FIPS) Number—a voluntary national uniform coding system number that is used to identify the milk plant at which the pasteurizing, ultra-pasteurizing, aseptic processing, condensing, concentrating or drying has been accomplished.

Flavored Dairy Products—such products to which have been added flavoring ingredients that are generally recognized as safe by the FDA and the state health officer and may contain nutritive sweeteners or stabilizers that are generally recognized as safe by the state health officer.

Food Allergens—proteins in foods that are capable of inducing an allergic reaction or response in some individuals. There is scientific consensus that the following foods account for more than 90 percent of all food allergies: peanuts, soybeans, milk, eggs, fish, crustacea, tree nuts, and wheat.

Frozen Dessert Manufacturing Plants—dairy plants that manufacture, process, freeze or partially freeze frozen desserts and provide or sell those products to institutional food service programs, restaurants, groceries, supermarkets, soda fountains, delicatessens and other retail outlets located on premises other than the premises on which they were frozen or partially frozen. Frozen dessert manufacturing plants are also dairy plants that manufacture or process mixes from which frozen desserts are produced.

Frozen Dessert Mixes—foods made with ingredients in such proportions that the mix when frozen will meet the definitions and standards of identity prescribed for the frozen products.

Frozen Desserts—any food produced by freezing or partially freezing, with or without stirring, any combination of two or more of the following: milk or milk products, vegetable fat, animal fat, eggs or egg products and other food products approved by the state health officer, nutritive sweetening ingredients, artificial sweetening ingredients, nut meats, fruit or fruit juices, citric or other organic food acid, other wholesome flavoring agents and colors, and harmless stabilizer; and shall be deemed to include ice cream, fruit ice cream, nut ice cream, sherbets, frozen yogurt, water ices, goat ice cream, sheep ice cream, water buffalo ice cream or any other food product deemed by the state health officer to be a frozen dessert and shall conform with the standards of identity contained in this Part.

Fruit Sherbet—a frozen dessert made from one or more milk or milk products determined to be safe and suitable by the FDA and the state health officer, water, and one or more sweetening ingredients determined to be safe and suitable by the state health officer with not more than 0.5 percent of stabilizer or binder with fruit or fruit juice ingredients in such an amount that the finished product shall contain not less than 20 percent by weight of such fruit ingredient, with or without addition of organic food acid. The finished product shall contain not less than 0.35 percent of organic acid calculated as lactic acid. The quantity of milk or milk products used shall be such that the finished product shall contain not less than 1 percent of milk fat and not more than 10 percent of total milk solids. The finished product shall weigh not less than 6 pounds per gallon.

Frozen Lowfat Yogurt—a frozen dessert prepared with one or more of the optional milk or milk products sweetened with one or more of the optional sweetening agents, with or without eggs or egg products, fruit or fruit juices, confection

or other optional flavoring ingredients, with or without harmless coloring, which is cultured after pasteurization by one or more strains of *Lactobacillus bulgaricus* and *Streptococcus thermophilus*. The standard plate count requirement for the product shall apply only to the mix prior to culturing. The finished product shall weigh not less than 5 pounds per gallon. For the purpose of this regulation, the strains of bacteria may be collectively referred to as yogurt culture. It shall contain not less than 0.5 percent and not more than 2.0 percent by weight of milk fat.

Frozen Nonfat Yogurt—a frozen dessert prepared with one or more of the optional milk or milk products sweetened with one or more of the optional sweetening agents with or without eggs or egg products, fruit or fruit juices, confection or other optional flavoring ingredients, with or without harmless coloring, which is cultured after pasteurization by one or more strains of *Lactobacillus bulgaricus* and *Streptococcus thermophilus*. The standard plate count requirement for the product shall apply only to the mix prior to culturing. The finished product shall weigh not less than 5 pounds per gallon. For the purpose of this regulation, the strains of bacteria may be collectively referred to as yogurt culture. It shall contain less than 0.5 percent by weight of milk fat.

Frozen Yogurt—a frozen dessert prepared with one or more of the optional milk or milk products of this Part, sweetened with one or more of the optional sweetening agents, with or without eggs or egg products, fruit or fruit juices, confection or other optional flavoring ingredients, with or without harmless coloring, which is cultured after pasteurization by one or more strains of *Lactobacillus bulgaricus* and *Streptococcus thermophilus*. The standard plate count requirement for the product shall apply only to the mix prior to culturing. The finished yogurt shall weigh not less than 5 pounds per gallon. For the purpose of this regulation, the strains of bacteria may be collectively referred to as yogurt culture. It shall contain not less than 3.25 percent by weight of milk fat.

Generally Recognized as Safe (GRAS)—a food or ingredient used in a food, that is generally recognized as safe and suitable for a specific use by the FDA.

GMP—see *Good Manufacturing Practices*.

Goat Milk—the normal lacteal secretion, practically free of colostrum, obtained by the complete milking of one or more healthy goats. Goat milk sold in retail packages shall contain not less than 2.2 percent milk fat and not less than 7.5 percent milk solids non fat. Goat milk shall be produced according to the sanitary standards of this Part. The word “milk” shall be interpreted to include goat milk.

Good Manufacturing Practices (GMP)—practices used in the manufacturing, packing, or holding of dairy products that comply with the requirements contained in this Part and in 21 CFR 110 and 21 CFR 117 as revised on April 1, 2016, when applicable.

Grade A Concentrated Milk and Concentrated Milk Products—the unsterilized and unsweetened dairy products

resulting from the removal of a considerable portion of the water from Grade A raw milk for pasteurization in a dairy plant that is in substantial compliance for all of the sanitation requirements for Grade A in this Part.

Grade A Dry Buttermilk and Dry Buttermilk Products—the products resulting from the drying of pasteurized liquid buttermilk that was derived from the churning of Grade A pasteurized-cream in a dairy plant that is in substantial compliance with the Grade A requirements of this Part.

Grade A Dry Whey or Dry Whey Products—the products obtained by the drying of Grade A whey for condensing or concentrating or by the drying of Grade A pasteurized condensed whey, while leaving all other constituents in the same relative proportions as in the Grade A whey for condensing or concentrating.

Grade A Nonfat Dry Milk—the product resulting from the drying of Grade A raw milk for pasteurization from which the milk fat has been removed in a dairy plant that is in substantial compliance with all of the sanitation requirements for Grade A of this Part.

Grade A Pasteurized Condensed Whey—the liquid substance obtained by partial removal of water from Grade A whey for condensing or concentrating, while leaving all other constituents in the same relative proportions as in the Grade A whey for condensing or concentrating.

Grade A Whey for Condensing or Concentrating—whey from cheese made from Grade A raw milk for pasteurization which has been pasteurized or heat-treated to a temperature of at least 64°C (147°F) and held continuously at that temperature for at least 21 seconds or to at least 67°C (153°F) and held continuously at that temperature for at least 15 seconds in equipment meeting the pasteurization requirements of this Part.

GRAS—see *Generally Recognized as Safe*.

HACCP—hazard analysis critical control point.

Half and Half—food consisting of a mixture of milk and cream which contains not less than 10.5 percent but less than 18 percent milk fat. It shall be pasteurized, ultra-pasteurized or aseptically processed and may be homogenized. Half and Half may contain flavoring and nutritive sweeteners GRAS by the state health officer and added prior to pasteurization, ultra-pasteurization or aseptic processing.

Heavy Cream—cream that contains not less than 36 percent milk fat. It is pasteurized, ultra-pasteurized or aseptically processed, may be homogenized and may contain other ingredients approved by the state health officer.

HHST—high heat-short time pasteurization.

HTST—high temperature-short time pasteurization.

Homogenized—dairy products that have been treated to insure break-up of the fat globules to such an extent that after 48 hours of quiescent storage at 4.4EC (40EF), no visible cream separation occurs in the dairy product; and the

fat percentage of the top 100 milliliters of dairy product in a quart, or proportionate volumes in containers of other sizes, does not differ by more than 10 percent from the fat percentage of the remaining milk as determined after thorough mixing.

Hooved Mammals Milk—the normal lacteal secretion, practically free of colostrum, obtained by the complete milking of one or more healthy hooved mammals. This product shall be produced according to the sanitary standards of this Part.

Ice Cream—a frozen dessert produced by freezing, while stirring, a pasteurized, ultra-pasteurized or aseptically processed frozen dessert mix consisting of one or more dairy products, other than cheese, filled milk or filled milk products, determined by the FDA, to be safe and suitable for use in ice cream, and may contain caseinates and hydrolyzed milk proteins of a type and in amounts determined to be appropriate by the FDA, sweetened with safe and suitable sweeteners approved by the FDA and may also contain eggs, egg products, fruit, fruit flavoring, nuts, natural or artificial flavors, coloring and other food products, each of which have been determined by the FDA to be safe and suitable for use in ice cream. Ice cream shall contain not less than 10 percent of milk fat, 10 percent of non fat milk solids, by weight, provided that the non fat milk solids level may be reduced as the milk fat level increases per the following chart:

Percent Milk Fat	Minimum Percent Non Fat Solids
10	10
11	9
12	8
13	7
14	6

a. In ice cream which contains bulky flavors (fruit, nuts, etc.) the weights of milk fat and total milk solids shall be not less than 10 percent and 20 percent, respectively, of the remainder obtained by subtracting the weight of the bulky flavors from the weight of the finished product; but, in no case shall the weight of milk fat or total milk solids be less than 8 percent and 16 percent, respectively, of the total weight of the finished product. Ice cream may contain safe and suitable stabilizers in amounts not more than 0.5 percent by weight of the total weight of the product. Ice cream shall contain not less than 1.6 pounds of total solids per gallon and shall weigh not less than 4.5 pounds per gallon. The term “ice cream” includes goat ice cream, sheep ice cream, water buffalo ice cream and ice cream made from the milk of other hooved mammals, fruit ice cream, nut ice cream, provided the labeling of such products comply with the labeling requirements contained in §121 of this Part.

Imitation Milk or Imitation Milk Products—foods that are made in semblance of and resemble a milk or milk product in physical characteristics, sensory properties, functional attributes and being of such nature that they may be used, interchangeably with the milk or milk product they are in semblance of and resemble, but are nutritionally

inferior to said milk or milk product. If, by this definition, a food is an imitation of a milk or milk product, the label shall bear the term “imitation” in a uniform type and size and prominence immediately before the name of the imitated milk or milk product. Imitation milk or milk products shall conform with the microbiological requirements for the milk or milk product which they are an imitation, contained in this Part. Plants that manufacture or process imitation milk or milk products shall conform with the requirements for dairy plants that manufacture or process the milk or milk product of which they are an imitation, contained in this Part.

IMS—interstate milk shipper.

IMS List Sanitation Compliance and Enforcement Rating of Interstate Milk Shippers—a list published quarterly by the U.S. Department of Health and Human Services, Public Health Service, Food and Drug Administration, Center for Food Safety and Applied Nutrition. The list consists of interstate milk shippers certified by State Milk sanitation authorities as having attained required milk sanitation compliance ratings; (to subscribe online, see <http://www.cfsan.fda.gov/~ear/imsl-1.html>).

Inspection—a series of observations, made by the state health officer, to determine whether or not a dairy facility, the operations conducted therein, and the products being produced, processed or handled are in compliance with the requirements of this Part.

Lactase Enzyme Preparation—derived from the nonpathogenic, nontoxicogenic yeast *Kluyveromyces lactis*. It is used to convert lactose to glucose and galactose. The current GMPs require the use of lactase enzyme in milk to produce “lactase-treated” milk, which contains less lactose than regular milk, or “lactose-reduced” milk, which contains at least 70 percent less lactose than regular milk (21 CFR §184.1388 Lactase enzyme preparation from *Kluyveromyces lactis*).

Lactose Reduced Milk, Lactose Reduced Lowfat Milk or Lactose Reduced Nonfat (Fat free, skim) Milk—the product resulting from the treatment of milk, lowfat milk or nonfat (fat free, skim) milk with safe and suitable enzymes to convert sufficient amounts of the lactose to glucose and/or galactose so that the remaining lactose is less than 30 percent of the lactose in milk, lowfat milk or nonfat (fat free, skim) milk.

Lower Fat—a general term related to any type of dairy product which contains less milk fat than that required by the definition and/or standard of identity for the primary (or traditional) dairy product. Such dairy products are to be labeled as “reduced fat”, “low fat”, “non fat (fat free, skim)” or “light”, the term being determined by the content of or the absence of milk fat in the finished product and the type of product.

Low Fat Cottage Cheese—the same as Cottage Cheese except that it contains 0.5 percent to 2.0 percent butterfat by weight and a maximum of 82.5 percent moisture. The label

must bear the phrase “contains not more than 2.0 percent butterfat.”

Low Fat Milk—milk from which a sufficient portion of milk fat has been removed to reduce its milk fat content to not less than 0.5 percent nor more than 1.5 percent.

Low Fat Yogurt—the same as Yogurt, except that it contains a lower butterfat content. It must contain at least 0.5 percent but not more than 2.0 percent butterfat.

LSPC—Louisiana State Plumbing Code, i.e., Part XIV (Plumbing) of this Code (LAC 51:XIV).

Manufacture—when used contextually with frozen desserts shall include all other similar terms, such as produce, process, convert, freeze and partially freeze.

Manufacturer—any person or company in the business of manufacturing a single service container or closure product which is to be used by a milk plant for the packaging or sampling of a finished Grade A milk or milk product.

Manufacturing Grade Milk—milk for manufacturing purposes that conforms with the requirements of this Part.

Manufacturing Line—a manufacturing process such as extrusion, blow mold, etc.

Manufacturing/Processing—making of a food from one or more ingredients and synthesizing, preparing, treating, modifying or manipulating food, including food crops or ingredients such as cutting, peeling, trimming, washing, waxing, bottling, labeling, packaging, etc.

Metals—metals which are nontoxic, nonabsorbent and corrosion-resistant under conditions of intended use.

Methods of Making Sanitation Ratings of Milk Shippers—2007 revision, as amended, published by the U.S. Department of Health and Human Services, Public Health Service, FDA; (internet URL address: <http://www.fda.gov/downloads/Food/GuidanceRegulation/UCM290758.pdf>).

Milk—the lacteal secretion, practically free from colostrum, obtained by the complete milking of one or more healthy cows. Milk that is in its final packaged form for beverage use shall have been pasteurized, ultra-pasteurized or aseptically processed and shall contain not less than 8.25 percent milk solids not fat and not less than 3.25 percent milk fat. Milk may have been adjusted by separating part of the milk fat therefrom or by adding thereto cream, concentrated milk, concentrated low fat milks, dry milk or dry low fat milks. Milk may be homogenized. Water shall not be added to milk or any ingredient used in milk. Milk may be flavored with safe and suitable flavoring ingredients approved by the state health officer. The word “milk” shall be interpreted to include goat, sheep, water buffalo, camel milk and the milk of other hooved mammals.

Milk Fat—the fat of milk.

Milk Plant—any place, premises or establishment where milk or milk products are collected, handled, processed,

stored, pasteurized, ultra-pasteurized, aseptically processed, condensed, dried, packaged or prepared for distribution and where milk tank trucks are cleaned or sanitized when received.

Milk Producer—any person who operates a dairy farm and provides, sells, or offers milk for sale to a dairy plant, receiving station, or transfer station.

Milk Products—cream, light cream, light whipping cream, heavy cream, heavy whipping cream, whipped cream, whipped light cream, sour cream, acidified sour cream, cultured sour cream, half-and-half, sour half-and-half, acidified sour half-and-half, cultured sour half-and-half, reconstituted or recombined milk products, concentrated or condensed milk and low fat milk, nonfat (fat free, skim) milk or nonfat (fat free, skim) milk products, dry milk, reduced fat milk, lower fat milk products, dry milk products, frozen milk and concentrated low fat milk, egg nog or boiled custard, buttermilk and low fat buttermilk, cultured milk and cultured reduced fat, cultured low fat milk [including kefir cultured milk, acidophilis cultured milk, cultured buttermilk, yogurt and low fat yogurts (whether spoonable or drinkable)], cultured nonfat (fat free, skim) milk, nonfat yogurt, acidified milk and acidified reduced fat or low fat milk, acidified nonfat (fat free, skim) milk, low-sodium milk and low-sodium reduced fat or low fat milk, low-sodium nonfat (fat free, skim) milk, lactose-reduced milk and lactose-reduced reduced fat or low fat milk, lactose-reduced nonfat (fat free, skim) milk, aseptically processed and packaged milk and aseptically processed and packaged milk products, milk, reduced fat, low fat milk, or nonfat (fat free, skim) milk with or without added safe and suitable microbial organisms and any other milk product made by the addition or subtraction of milk fat or the addition of safe and suitable optional ingredients approved by the FDA, for protein, vitamin or mineral fortification of the milk products contained herein. Milk products also include those dairy foods made by modifying the federally standardized products listed in this Part in accordance with the 21 Code of Federal Regulation (CFR) 130.10 *Requirements for foods named by the use of a nutrient content claim and a standardized term*. This definition shall include imitation milk and imitation milk products, anomalous milk and anomalous milk products, filled milk and filled milk products. Milk and milk products which have been retort processed after packaging or which have been concentrated, condensed or dried shall be included in this definition. Dried blends of milk products and blends of dried products, which have milk or a derivative of milk as their predominant ingredient and are used for human consumption, shall be included in this definition. This definition is not intended to include dietary products (except as defined herein), infant formula, ice cream or other frozen desserts, butter or cheese.

Milk Sanitation Rating Officer—a state employee who has been standardized by the *Public Health Service/Food and Drug Administration* to perform required milk sanitation ratings of farms, plants, or HACCP listing of dairy plants or a combination thereof, has a valid certificate of qualification issued by the *Public Health Service/Food and Drug*

Administration and who does not have responsibility for the routine inspections/audits or enforcement action for the plants or farms he/she rates. State program directors, administrators, etc., may be certified.

Milk Shake—a pasteurized, ultra-pasteurized or aseptically processed dairy product consisting of one or more milk or milk products, determined by the FDA to be safe and suitable flavoring and sweetening ingredients, stabilizers and may contain fruits, nuts, and other bulky flavors determined by the FDA to be safe and suitable. Milk shakes shall contain not less than 4.5 percent milk fat and 8.8 percent solids non fat by weight.

Milk Tank Truck—a bulk milk pickup tanker or a milk transport tank truck.

Milk Tank Truck Cleaning Facility—any place, premise or establishment, separate from a milk plant or receiving station, where milk tank trucks are cleaned and sanitized.

Milk Tank Truck Operator—any person who operates a milk tank truck, bulk milk pickup tanker or a milk transport tank truck and may or may not be a bulk milk tank truck operator/sampler.

a. milk tank truck and milk tank transport operators who are not licensed as bulk milk tank truck operator/samplers shall not perform any of the duties of a bulk milk tank truck operator/sampler that directly involve the collection or measuring of milk for official records; and

b. milk tank truck operators who are not bulk milk tank truck operator/samplers and perform any of the duties of a bulk milk tank truck operator/sampler other than duties involved in the sampling and measuring of the raw milk shall conform with the requirements for such duties contained in this Part related to those non sampling, non measuring duties of the bulk milk tank truck operator/sampler.

Milk Transport Tank Truck—a vehicle, including the truck and tank, used to transport bulk shipments of milk from a milk plant, receiving station or transfer station to another milk plant, receiving station or transfer station.

Misbranded Milk, Milk Products and Other Dairy Products—products which are not labeled in accordance with the requirements of §121 of this Part.

NACMCF—U.S. National Advisory Committee on Microbiological Criteria for Foods.

NCIMS—the cooperative State-Federal program of the National Conference on Interstate Milk Shipments.

Non-Dairy Frozen Desserts—

a. food which is prepared by freezing, while stirring, a non-dairy frozen dessert mix composed of one or more optional characterizing ingredients specified in Subparagraph b of this Paragraph, sweetened with one or more of the optional sweetening ingredients specified in Subparagraph c of this Paragraph. The non-dairy product, with or without water added, may be seasoned with salt. One or more of the ingredients specified in Subparagraph d may

be used. Pasteurization is not required. The optional caseinates specified in Clause i of Subparagraph d are deemed not to be dairy products.

b. the optional flavoring ingredients referred to in Subparagraph a of this Paragraph are natural and artificial flavoring and characterizing food ingredients.

c. the optional sweetening ingredients referred to in Subparagraph a of this Paragraph: Sugar (sucrose), dextrose, invert sugar (paste or syrup), glucose syrup, dried glucose syrup, corn sweetener, dried corn sweetener, malt syrup, malt extract, dried malt extract, maltose syrup and dried maltose syrup.

d. other optional ingredients referred to in Subparagraph a of this Paragraph are:

i. Casein prepared by precipitation with gums, ammonium caseinate, caseinate, calcium caseinate, potassium caseinate or sodium caseinate.

ii. hydrogenated and partially hydrogenated vegetable oil.

iii. dipotassium phosphate.

iv. coloring, including artificial coloring.

v. monoglycerides, diglycerides or polysorbates.

vi. thickening ingredients such as agar-agar, algin (sodium alginate), egg white, gelatin, gum acacia, guar seed gum, gum karaya, locust bean gum, oat gum, gum tragacanth, hydroxypropyl, methyl cellulose, carrageenan, salts of carrageenan, furcelleran, propylene glycol alginate, pectin, psyllium seed husk, sodium carboxymethylcellulose.

e. such non-dairy frozen desserts are deemed “processed” when manufactured as a dry powdered mix.

f. dry non-dairy frozen dessert mixes shall be reconstituted with potable water in a sanitary manner and shall be rapidly cooled to a temperature of 45°F or below within four hours of reconstitution.

g. the product shall meet the bacterial standards prescribed in §2705.A.18 of this Part.

h. the name of the food is “non-dairy frozen dessert”.

i. the fact that the product offered for sale is a non-dairy frozen dessert shall be conspicuously displayed on or near the dispensing freezer in a manner and print that is easily readable by the consumer.

Nonfat (Fat Free, Skim) Milk—milk from which a sufficient portion of milk fat has been removed to reduce its milk fat percentage to less than 0.5 percent.

Nontoxic Materials—materials which are free of substances which may render the milk injurious to health or which may adversely affect the flavor, odor, composition or bacteriological quality of the product and which meet the requirements of the *Federal Food, Drug and Cosmetic Act*, as amended.

Nutritionally Inferior—foods that contain a reduction of 2.0 percent or more of the daily recommended value (DRV) of protein and potassium and 2.0 percent or more of the U.S. recommended daily intake (RDI) of any vitamin or mineral of the food that they resemble or may be used as a substitute for that food. Foods that are nutritionally inferior to the food which they resemble shall be labeled “imitation”. Foods that are not nutritionally inferior to the food which they resemble shall be considered nutritionally equivalent to the food which they resemble.

Official Laboratory—a biological, chemical, radiological, or physical laboratory which is under the direct supervision of the state health officer or which is under the direct supervision of a duly authorized regulatory official which has been approved by the state health officer.

Official Methods of Analysis—18th Edition, Revision 2, 2007, as amended, published by the AOAC International.

NOTE: AOAC International was formally called the Association of Official Analytical Chemists.

Officially Designated Laboratory—a commercial laboratory authorized to analyze official samples by the state health officer or the milk regulatory official of the state in which it is domiciled or a milk industry laboratory officially designated by the state health officer or the milk regulatory official of the state in which it is domiciled.

Overflow Milk or Milk Product—a milk or milk product which has either:

- a. been collected in containers from leaking valves, leaking joints in sanitary milk pipelines, spillage at coolers and bottling machines, or broken bottles; or
- b. been exposed to contamination by contact with the surfaces of equipment which have not been treated with a bactericide.

PHS—United States Public Health Services.

PHS/FDA—United States Public Health Service/Food and Drug Administration.

PMO—the 2015 edition, as amended, of the *Grade “A” Pasteurized Milk Ordinance*, Public Health Service/Food and Drug Administration.

Packing or Packaging—placing, putting or repacking food into different containers without making any change to the form of the food. Facilities that pack dairy products shall be considered to be dairy plants.

Paper Stock—any paper made from the following materials:

- a. paper and paperboard manufactured from clean, sanitary virgin chemical or mechanical processed pulp or from broke and trim of such paper and paperboard, provided they have been handled, treated and stored in a clean, sanitary manner or reclaimed fiber using acceptable or approved protocol in compliance with Title 21 CFR 176.260; and

- b. components meeting the requirements of the *Federal Food, Drug and Cosmetic Act*, as amended.

Pasteurization—the process of heating every particle of a dairy product to the appropriate temperature, contained in the chart below, and held continuously at or above the temperature for at least the corresponding time contained in the chart. The pasteurization process shall be performed in equipment designed, manufactured and operated in accordance with the requirements contained in the PMO. The required recording charts for perishable or refrigerated products shall be retained at the dairy plant for a period of one year after the products were prepared. The required recording charts for frozen, preserved or shelf-stable products shall be retained at the plant for a period of two years.

Temperature	Time
63°C (145°F)*	30 minutes
72°C (161°F)*	15 seconds
89°C (191°F)	1.0 second
90°C (194°F)	0.5 seconds
94°C (201°F)	0.1 seconds
96°C (204°F)	0.05 seconds
100°C (212°F)	0.01 seconds

*If the fat content of the milk product is 10 percent or more, or if it contains added sweeteners, the specified temperature shall be increased by 3°C (5°F).

- a. Eggnog shall be heated to at least the following temperature and time specifications.

Temperature	Time
69°C (155°F)	30 minutes
80°C (175°F)	25 seconds
83°C (180°F)	15 seconds

- b. Provided further, that should scientific evidence indicate that the above temperatures or times are not adequate to destroy pathogenic microorganisms of human significance or for any other reason, may not be adequate to protect the public’s health, the state health officer may, with the concurrence of the FDA, immediately require that all pasteurized or ultra-pasteurized dairy products sold in the state are pasteurized or ultra-pasteurized at temperatures or times recommended to be adequate by the FDA. Provided further that should the FDA hereafter determine that any of the requirements for pasteurization or ultra-pasteurization contained in the PMO are not adequate to protect the public’s health and require a change in any of the aforesaid requirements, the state health officer shall immediately require that all pasteurization or ultra-pasteurized products sold in the State conform with the new FDA requirements for pasteurization or ultra-pasteurization. Provided further, that nothing shall be construed as barring any other pasteurization process, which has been recognized by the FDA to be equally efficient and which is approved by the state health officer.

Pasteurized Process Cheese—food prepared by comminuting and mixing, with the aid of heat, one or more cheeses of the same or two or more varieties, except Cream Cheese, Neufchatel Cheese, Cottage Cheese, Lowfat Cottage

Cheese, Cottage Cheese Dry Curd, Cook Cheese, Hard Grating Cheese, Semisoft part Skim Cheese, part Skim Spiced Cheese and Skim Milk Cheese for manufacturing with a suitable emulsifying agent approved by the FDA and the state health officer into a homogeneous plastic mass. One or more of the optional suitable ingredients approved by the FDA and the state health officer may be used. During its preparation, pasteurized process cheese is heated for not less than 30 seconds at a temperature of not less than 66EC (150EF). Pasteurized process cheese shall conform with the standard of identity contained in this Part and 21 CFR 133.169. Pasteurized process cheese related products are foods that contain pasteurized process cheese as the predominant ingredient. They may contain suitable fruits, vegetables, nuts or meats that have been GRAS by the FDA and the state health officer. These products shall conform with the microbiological requirements for cheese contained in this Part and shall be manufactured in dairy plants that conform with the requirements for cheese manufacturing plants contained in Chapter 25 of this Part. These products shall conform with the standard of identity contained in §107.

Pasteurized Process Cheese Manufacturing Plants—dairy plants that manufacture, process or package pasteurized process cheese or pasteurized process cheese related products.

Phosphatase Test—an index of the efficiency of the pasteurization process.

Plant or Facility—an establishment or structure(s) under one management at one general physical location (or in case of a mobile facility, traveling to multiple locations) that manufactures/processes, packs or holds food for human consumption. A “plant or facility” may be one food processing plant with multiple buildings in one location. A building that has multiple companies at the same address would be considered to be multiple plants or facilities.

Plastic Molding—

- a. forming, extrusion, and laminating resins:
 - i. resins or an intimate admixture of resins with other ingredients which meet the requirements of the Federal Food, Drug, and Cosmetic Act, as amended; and
 - ii. plastic composed solely of clean cuttings or re-grind, provided they have been handled and maintained in a sanitary manner.
- b. This definition shall not preclude the use of recycled plastic material when it complies with a protocol which has been reviewed and accepted by the FDA.

Powdered or Dry Frozen Dessert Mixes—frozen dessert mixes that have been dried in dairy products drying plants that are in substantial compliance with the provisions for such plants contained in this Part.

Preformed Container—a container in completed form ready for filling.

Product Contact Surface—surfaces of the container or closure with which the product comes in contact.

Production Scrap—material which remains from the manufacture of single service containers or closures which has been handled or treated in such a manner that it does not comply with the definition for broke and trim or re-grind, but may be collected for recycling. It may contain material such as containers or trim that have fallen on the floor.

Quiescently Frozen Confections—a clean and wholesome frozen, sweetened, flavored dessert in the manufacture of which freezing has not been accompanied by stirring or agitation (generally known as quiescent freezing). This confection may be acidulated with food grade acid, may contain milk solids, water, may be made with or without added harmless pure or imitation flavoring, with or without harmless coloring. The finished product shall contain not more than 0.5 of 1 percent by weight of stabilizer composed of wholesome edible material. The finished product shall contain not less than 17.0 percent by weight of total food solids. In the producing of this confection, no processing or mixing prior to quiescent freezing shall be used that develops in the finished confection mix any physical expansion in excess of 10 percent.

Quiescently Frozen Dairy Confections—a clean and wholesome frozen dessert made from water, milk products and sugar, with added harmless pure or imitation flavoring, with or without added harmless coloring, with or without added stabilizer and with or without added emulsifier; and in the manufacture of which freezing has not been accompanied by stirring or agitation (generally known as quiescent freezing). It contains not less than 13.0 percent by weight of total milk solids, not less than 33.0 percent by weight of total food solids, not more than 0.5 percent by weight of stabilizer and not more than 1/5 of 1 percent by weight of emulsifier. Stabilizer and emulsifier must be composed of wholesome, edible material. In the production of quiescently frozen dairy confections, no processing or mixing prior to quiescently freezing shall be used that develops in the finished confection mix any physical expansion in excess of 10.0 percent.

Quiescently Frozen Ice Creams or Sherbets—frozen desserts which conform with the standards of identity contained in §107 of this Part and in the manufacture of which freezing has not been accompanied by stirring or agitation (generally known as quiescent freezing). These products may be produced in various forms and figurations such as “stick novelties”, bars, loaves, molded into various shapes and sizes, etc.

Receiving Station—any place, premise, or establishment where raw milk is received, collected, handled, stored or cooled and prepared for shipment to other facilities.

Reclaimed Water (dairy farm) or Reclaimed Water_{af}—potable water which has been used for heat exchange purposes in plate or other type heat exchangers or compressors on a Grade A dairy farm and which is later re-

used for certain limited purposes as is specified in §525 of this Part.

Reclaimed Water (dairy plant) or Reclaimed Water_{dp}—water obtained from the processing of Grade A milk and milk products (for example, condensing water from dairy product evaporators complying with this Part and water reclaimed from milk or dairy products during the evaporation or condensing process) at a dairy plant and which is later re-used for certain limited purposes as is specified in §2117 of this Part.

Reconstituted or Recombined Milk, Reconstituted or Recombined Milk Products, Reconstituted or Recombined Anomalous (Substitute) Milk, or Reconstituted or Recombined Anomalous (Substitute) Milk Products—milk and milk products defined in this Part that result from reconstituting or recombining milk constituents with potable water. The sale of reconstituted or recombined milk or milk products and reconstituted or recombined anomalous (substitute) milk or milk products in the state shall be prohibited.

Reduced Fat Milk—milk which has a milk fat content of 2.0 percent.

Re-Grind—clean plastic material which is trimmed from the container or closure, and imperfectly formed containers or closures which result from the manufacture of single service containers and closures, provided it is handled in a clean, sanitary manner. This may be in its trimmed or molded form and ground in a grinder, approved by the FDA, within the plant. It shall not include any material, container or closure which comes from an unapproved source or whose source, chemical content and treatment is unknown, or which may have poisonous or deleterious material retained in the plastic which migrates to the food at levels exceeding regulatory levels. Re-grind, when transported from one approved plant to another, shall be shipped in clean, sealed, properly labeled containers approved by the FDA. This definition shall not preclude the use of re-grind plastic material when it complies with a protocol which has been reviewed and accepted by the FDA.

Ripened or Aged Cheese—cheese that has been purposely exposed to warm temperatures or held for long periods at colder temperatures to permit bacteria and enzymes to transform the fresh curd into cheese of a specific flavor, texture and appearance. Cheese shall be ripened by placing it in a temperature controlled room at temperatures no lower than 2EC (35EF) and at a selective optimum relative humidity for a minimum of 60 days.

Sample Set—a minimum of four containers shall be tested. For the swab test a minimum of four 50-square centimeter areas of surface from separate containers shall be tested. In the case of containers or closures with a product-contact surface area smaller than 50-square centimeters, more than four containers or closures to equal at least 50-square centimeters times four will be required to be swabbed. Sample set from each manufacturing line shall:

a. for the rinse test, a minimum of four containers shall be tested; and,

b. for the swab test, a minimum of four 50-square centimeter areas of surface from separate containers shall be tested. In the case of containers or closures with a product contact surface area smaller than 50-square centimeters, more than four containers or closures to equal at least 50-square centimeters times four will be required to be swabbed.

Sanitization—is the application of any effective method or substance to a clean surface for the destruction of pathogens and of other microorganisms as far as is practicable. Such treatment shall not adversely affect the equipment, the milk or milk product, or the health of consumers and shall be acceptable to the FDA and the state health officer. Chemical sanitizers shall meet the requirements contained in Part I of Appendix F of the *PMO*.

SCC—somatic cell count.

Sensitivity Producing Ingredient—ingredients that cause individualistic adverse reactions other than those that result in immunoglobulin Epsilon (IgE) mediated allergies.

Sheep Milk—the lacteal secretion practically free from colostrum, obtained by the complete milking of one or more healthy sheep, and shall comply with all the requirements of this Part. The word milk shall be interpreted to include sheep milk.

Sherbet—a frozen dessert which complies with the definition and standard of identity of sherbet (see 21 CFR 135.140), with the exceptions that artificial flavoring may be substituted in whole or in part for the true fruit ingredient, and the butterfat content shall not be less than 1 percent.

Skim Milk—see *Nonfat (Fat Free, Skim) Milk*.

Single Service Articles—articles which are constructed wholly, in part, or in combination from paper, paperboard, molded pulp, plastic, metals, coatings or similar materials which are intended by the manufacturer for one usage only.

Single Service Milk Container—any container having a milk or dairy product contact surface and is to be used in the packaging, handling, wrapping or storage of Grade A milk and milk products and which is intended for one use only.

Single Service Milk and Milk Product Container or Closure Manufacturing Plants—fabricators, converters, printers, closure manufacturers, plastic laminators, sheet formers, blow molders, vacuum formers, plastic extruders, injection molders, preformers, manufacturers of valves, valve parts, tubes, dispensing devices and sample containers for use with milk or milk products.

Sour Cream, Acidified Sour Cream—food resulting from the souring by lactic acid producing microorganisms of pasteurized, ultra-pasteurized or aseptically processed cream. Sour cream may contain rennet, flavoring ingredients, salt, sodium citrate and safe and suitable natural and artificial food flavoring. Acidified sour cream also includes cream in which the souring was accomplished with

safe and suitable acidifiers with or without addition of lactic acid producing microorganisms.

SPC—standard plate count.

SRO—a milk sanitation rating officer operating under the authority of the state health officer (see *milk sanitation rating officer*).

Standard Methods for the Examination of Dairy Products—the 17th Edition, 2004, as amended, published by the American Public Health Association.

Standard Methods for the Examination of Water and Wastewater—the 21st Edition, 2005, as amended, published by the American Public Health Association.

State Health Officer—the legally appointed or acting State Health Officer of the Department of Health and Hospitals having jurisdiction over the entire state of Louisiana, and includes his/her duly authorized representatives in accordance with R.S. 40:4 and 40:5.

State Food, Drug and Cosmetic Act—R.S. 40:601, et seq., as amended.

Transfer Station—any place, premises, or establishment where milk or milk products are transferred directly from one milk tank truck to another.

UHT—Ultra High Temperature.

USDA—United States Department of Agriculture.

Ultra-Pasteurized—when used to describe a dairy product, shall mean that such product shall have been thermally processed at or above 138°C (280°F) for at least two seconds, either before or after packaging, so as to produce a product which has an extended shelf life under refrigerated conditions.

Unripened Cheese—cheese that has not been ripened or aged. Such cheese includes: Alemtejo, Alpinianari, Asadero, Asiago, Bokers, Banburg, Bondon, Cambridge, Cottage, Cream, Creole Cream, Farmers, Ferme Feta, Formagelle, Gournug, Liverot, Malgre, Mignot, Mont d'Or, Mozzarella, Neufchatel, Queso Blanco, Queso de Hoja, Queso del Pais, Queso de Puna, Queso Fresco, Provutura, Ricotta, Scamorze, Villiers and others designated by the state health officer.

Vitamin A Fortification—the addition of vitamin A (retinol), vitamin A acetate (retinyl acetate) or vitamin A palmitate (retinyl palmitate) is mandatory in low fat milk and low fat milk products (except yogurt). In fluid milk, vitamin A is required at levels to achieve nutritional equivalency [300 International Units (IU) per cup, 1200 IU per quart]. However, the FDA and the state health officer would prefer that dairy processors continue to fortify vitamin A to levels of 2000 IU/qt. Other modified fat milk products must be fortified with vitamin A to achieve nutritional equivalency. Vitamin A may be added to other products within the limits of GMP. There is no specified GMP level for vitamin A in milk and milk products. Vitamin A may be required to be added to new low fat products to

achieve nutritional equivalency with their full fat counterparts.

Vitamin D Fortification—the addition of vitamin D (vitamin D2 or D3 in crystalline, resin or crystal form) to all milk and milk products is optional. Many standards of identity prescribe the minimum level of vitamin D that must be present when it is added to a product. For example, if vitamin D is added to milk, it must be added at a level so that each quart contains 400 IU of vitamin D. If the standard of identity does not indicate a specific level or the product does not have a standard of identity then, the level at which vitamin D may be added must be in accordance with GMP. The maximum GMP level for vitamin D set for milk is (42 IU/100g)² and milk products (89 IU/100g)³.

Water Buffalo or other Hooved Mammal Milk—the lacteal secretion practically free from colostrum, obtained by the complete milking of one or more healthy water buffalo or other hooved mammals and shall comply with all of the requirements of this Part. The word milk shall be interpreted to include water buffalo and other hooved mammal milk.

Water Ices—a frozen dessert produced by freezing with or without stirring, does not contain any milk or milk derived ingredients, does not contain any egg ingredient other than egg white and does not contain any food fats, except such as are added in small amounts to accomplish specific functions or, are natural components of flavoring ingredients used in the water ice. Water ice is sweetened with safe and suitable nutritive carbohydrate sweeteners and is characterized by the addition of one or more characterizing fruit ingredients (including fruit juices, concentrated fruit juices) or one or more non fruit characterizing ingredients. Other safe and suitable ingredients such as ground spice, infusions of coffee or tea, natural or artificial food flavoring (except any having a characteristic fruit or fruit like flavor) may be added. Each ingredient used in water ice shall have been determined by the FDA to be safe and suitable for use in the product.

Whey—the fluid obtained by separating the coagulum from milk, cream, lowfat or nonfat (fat free, skim) milk in the cheese making process.

Whey Products—any fluid product removed from whey or made by the removal of any constituent from whey or by addition of any wholesome substance to whey or parts thereof. Whey products may be condensed, concentrated or dried.

Yogurt (Yogourt, Yoghurt), Spoonable or Drinkable—food produced by culturing of cream, milk, partially skimmed milk or nonfat (fat free, skim) milk used alone or in combination, with characterizing and lactic acid producing microorganisms. Concentrated nonfat (fat free, skim) milk and non fat dry milk may be added. Ingredients, other than flavoring ingredients shall be pasteurized, ultra-pasteurized or aseptically processed prior to the addition of the microorganism culture. Yogurt may be heat treated after culturing is completed. The finished product shall contain not less than 0.9 percent titratable acidity expressed as lactic acid. The word “yogurt” shall include drinkable and

spoonable yogurt. All yogurts sold in the state shall conform to the Grade A bacteriological standards/specifications contained in this Part. Plants that manufacture or process yogurts shall conform with the requirements for Grade A dairy plants contained in this Part.

B. Standards of identity listed in §107 of this Part are also herein incorporated as definitions of milk and dairy products. In case of conflicts, the more stringent definition shall apply.

AUTHORITY NOTE: The first source of authority for promulgation of the Sanitary Code is R.S. 36:258(B), with more particular provisions found in Chapters 1 and 4 of Title 40. This Part is promulgated in accordance with specific provisions of R.S.40: 4(A)(1)(a). Also see R.S. 40:5.A.(2)(3)(5)(7) (15)(17) and R.S. 40:922.

HISTORICAL NOTE: Promulgated by the Department of Health and Hospitals, Office of Public Health, LR 28:1258 (June 2002), amended LR 37:2633 (September 2011), LR 38:2793 (November 2012), amended by the Department of Health, Office of Public Health, LR 43:1391 (July 2017).

§103. Local Ordinances

A. Parishes and municipalities may adopt local milk ordinances provided that such ordinances do not conflict with and are not less restrictive than the PMO, this Code, or state statutes pertaining to milk and further provided that such ordinances have been reviewed and approved by the state health officer prior to adoption.

AUTHORITY NOTE: Promulgated in accordance with the provisions of R.S. 40:4(A)(1)(a). Also see R.S. 40:5(2)(3)(5)(7) (15)(17), R.S. 40:922, and R.S. 40:925.

HISTORICAL NOTE: Promulgated by the Department of Health and Hospitals, Office of Public Health, LR 28:1262 (June 2002), amended LR 37:2646 (September 2011).

§105. Severability Clause

A. If any provision of this Part, or the application of such provision to any person or circumstance, shall be held invalid, the remainder of this Part, or the application of such provision to persons or circumstances other than those as to which it is held invalid, shall not be affected thereby.

AUTHORITY NOTE: Promulgated in accordance with the provisions of R.S. 40:4(A)(1)(a). Also see R.S. 40:5(2)(3)(5)(7) (15)(17) and R.S. 40:922.

HISTORICAL NOTE: Promulgated by the Department of Health and Hospitals, Office of Public Health, LR 37:2646 (September 2011).

§107. Standard of Identity

A. All dairy products sold in the state shall conform with the standards of identity (definitions, specifications and requirements) contained in this Section, 21 USC §321a, 21 CFR Part 130, 21 CFR Part 131, 21 CFR Part 133, 21 CFR Part 135 or 21 CFR Part 184, determined by the state health officer, to be applicable to the specific product. A product shall not be in compliance with a standard of identity when :

1. the product contains ingredients that are not provided for in the standard, unless the ingredient is an incidental additive;

2. the product fails to contain one or more ingredients required by the definition and standard; or

3. the product contains an ingredient or component not within the limitation of the definition or standard.

B. The following dairy products which may not be identified under Subsection A of this Section, shall have the standards of identity as defined in §101.A. If there is a conflict between a standard of identity listed in Subsection A of this Section and the same standard of identity is also listed (by reference to its definition in §101.A) in Subsection B of this Section, the standard of identity in Subsection A of this Section shall govern. These products must conform to the standards of identity prescribed by this Section in order to be sold in this state:

1. anomalous (substitute) dairy products;
2. anomalous (substitute) milk and anomalous (substitute) milk products;
3. acidified milk and acidified milk products;
4. butter;
5. buttermilk;
6. cheese;
7. concentrated or condensed milk;
8. cottage cheese;
9. cream;
10. creamed cottage cheese;
11. creole cream cheese or creole cheese;
12. cultured milk and cultured milk products;
13. cultured anomalous milk and cultured anomalous milk products;
14. cultured filled milk and cultured filled milk products;
15. dry cream;
16. dry milk (powdered milk);
17. dry milk products;
18. egg nog or boiled custard;
19. filled dairy products;
20. filled milk and filled milk products;
21. frozen low fat yogurt
22. frozen nonfat yogurt
23. frozen yogurt
24. fruit sherbet;
25. goat milk;
26. half and half;
27. heavy cream;

28. ice cream;
29. imitation milk or imitation milk products;
30. lactose reduced milk;
31. lactose reduced low fat milk
32. lactose reduced nonfat (fat free, skim) milk;
33. low fat cottage cheese;
34. low fat milk;
35. low fat yogurt
36. milk;
37. milk shake;
38. non-dairy frozen desserts;
39. nonfat (fat free, skim) milk;
40. pasteurized processed cheese;
41. quiescently frozen confections;
42. quiescently frozen dairy confections;
43. quiescently frozen ice creams or sherbets;
44. reduced fat milk;
45. ripened or aged cheese
46. sheep milk;
47. sherbet;
48. sour cream or acidified sour cream;
49. water buffalo or other hooved mammal milk;
50. water ices; and
51. yogurt (yogourt, yoghurt), spoonable or drinkable.

AUTHORITY NOTE: Promulgated in accordance with the provisions of R.S.40:4(A)(1)(a). Also see R.S. 40:5(2)(3)(5)(7) (15)(17) and R.S. 40:922.

HISTORICAL NOTE: Promulgated by the Department of Health and Hospitals, Office of Public Health, LR 37:2646 (September 2011).

Subchapter A. Required Permits

§109. Permits

A. Operators of dairy farms, receiving stations, transfer stations, dairy plants (including frozen dessert manufacturing plants, filled dairy products processing plants, anomalous milk and milk products processing plants, anomalous dairy products processing plants, imitation milk and milk products processing plants, single-service containers and closures for milk and milk products manufacturing plants, milk tank truck cleaning facilities, finished dairy product depots/transfer points and milk tank trucks) that are domiciled within the state shall obtain a permit to operate from the state health officer prior to beginning operation. Bulk milk tank truck operators/samplers and dairy plant receivers/samplers shall obtain a permit from the state health officer prior to

performing the duties associated with those positions. Only a person who complies with the requirements of this Part shall be entitled to receive or retain a permit from the state health officer.

B. Persons applying for permits shall complete and sign all forms for permit application and pay any and all fees required by the state health officer.

C. Such a permit may be temporarily suspended by the state health officer upon violation by the holder of any of the terms of these regulations, or for interference with the state health officer in the performance of his duties, or may be revoked after an opportunity for a hearing by the state health officer upon serious or repeated violations.

AUTHORITY NOTE: Promulgated in accordance with the provisions of R.S. 40:4(A)(1)(a). Also see R.S. 40:5(2)(3)(5)(7) (15)(17) and R.S. 40:922.

HISTORICAL NOTE: Promulgated by the Department of Health and Hospitals, Office of Public Health, LR 28:1262 (June 2002), amended LR 37:2647 (September 2011).

§111. Permits Required for Imported Milk, Milk Products and Frozen Desserts

A. It shall be unlawful for any person, firm or corporation to ship or receive into the state any milk or milk products (except extra grade and standard grade dry milk and milk products), filled milk and filled milk products, anomalous milk and milk products, imitation milk and imitation milk products and frozen desserts from outside of the state that were processed or packaged by a dairy plant that does not possess a current valid permit from the state health officer. Only a person, firm or corporation who complies with the requirements of this Part shall be entitled to receive or retain such permit.

B. All imported Grade A milk and milk products shall be processed and packaged only by dairy plants currently listed in the *IMS List Sanitation Compliance and Enforcement Rating of Interstate Milk Shippers*.

C. In the event a person requests a permit for a dairy plant domiciled outside the State of Louisiana, the person shall:

1. Complete and sign all forms for permit application required by the state health officer.
2. Pay any and all fees required by the state health officer.
3. Have the regulatory authority, responsible for permitting and inspecting/auditing of dairy plants in the state in which the plant is domiciled, send the following information directly to the state health officer if they are not currently in the IMS list:
 - a. a statement indicating whether or not the plant is in substantial compliance with all applicable laws and regulations of the locality, state, province or country in which the plant is domiciled;
 - b. a copy of the most recent inspection/audit report completed by the regulatory authority; and

c. copies of the last three results of bacteriological and chemical analyses performed on the plant's products by the regulatory authority.

4. Provide copies of labels of each product the plant intends selling in Louisiana.

5. Provide a copy of the laws and regulations of the regulatory authority responsible for permitting and inspecting/auditing of the plant when requested by the state health officer.

6. Provide any other information, data or records required by the state health officer.

AUTHORITY NOTE: Promulgated in accordance with the provisions of R.S.40:4(A)(1)(a). Also see R.S. 40:5(2)(3)(5)(7) (15)(17) and R.S. 40:922.

HISTORICAL NOTE: Promulgated by the Department of Health and Hospitals, Office of Public Health, LR 37:2647 (September 2011).

§113. Requirements for Imported Dairy Products

A. All dairy products (including frozen desserts, filled dairy products, anomalous milk and milk products, anomalous dairy products and imitation milk and imitation milk products) brought into Louisiana from outside of the state shall comply with the standards (specifications) contained in this Part determined to be applicable by the state health officer. These products shall be produced, processed and handled by facilities that comply with, the requirements of this Part. The production and processing facilities may be inspected by the state health officer; the cost of such inspections shall be borne by the person or firm producing or processing such dairy products or in lieu thereof, the state health officer may accept a certificate of compliance/inspection of a duly authorized agent of the dairy regulatory agency in the state or country wherein the products are produced or processed.

AUTHORITY NOTE: Promulgated in accordance with the provisions of R.S. 40:4(A)(1)(a). Also see R.S. 40:5(2)(3)(5)(7) (15)(17) and R.S. 40:922.

HISTORICAL NOTE: Promulgated by the Department of Health and Hospitals, Office of Public Health, amended LR 37:2647 (September 2011).

Subchapter B. Records

§115. Milk Records

A. Each dairy plant, and others receiving milk or dairy products, including frozen desserts, from one or more sources shall keep records of the sources and the amounts of such products received. They shall also keep records showing utilization and disposition of all such products they receive. These records shall include names and amounts of each such product used or disposed of. Such records shall be open to inspection by the state health officer.

AUTHORITY NOTE: Promulgated in accordance with the provisions of R.S. 40:4(A)(1)(a). Also see R.S. 40:5(2)(3)(5)(7) (15)(17) and R.S. 40:922.

HISTORICAL NOTE: Promulgated by the Department of Health and Hospitals, Office of Public Health, LR 37:2647 (September 2011).

§117. Falsification of Records

A. Falsification of any records, logs or recording charts shall constitute grounds for the suspension of permit.

AUTHORITY NOTE: Promulgated in accordance with the provisions of R.S. 40:4(A)(1)(a). Also see R.S. 40:5(2)(3)(5)(7) (15)(17) and R.S. 40:922.

HISTORICAL NOTE: Promulgated by the Department of Health and Hospitals, Office of Public Health, LR 37:2648 (September 2011).

Subchapter C. Registration and Labeling

§119. Registration

A. Each processed dairy product final manufacturer shall register each separate and distinct processed dairy product, in storage, offered for sale or being sold in the state, annually with the state health officer in accordance with the provisions contained in Chapter 4, Part 1, §627 of the State Food, Drug and Cosmetic Law (R.S. 40:601, et seq.). The state health officer shall not register any processed milk or milk product, anomalous milk or anomalous milk product, filled milk or filled milk products, imitation milk or imitation milk products, frozen dessert mixes or mix products processed or packaged by a dairy plant that does not have a current, valid permit for such products issued by the state health officer. The labels for the aforesaid products shall have been reviewed and approved by persons, operating under the authority of the state health officer.

AUTHORITY NOTE: Promulgated in accordance with the provisions of R.S. 40:4(A)(1)(a). Also see R.S. 40:5(2)(3)(5)(7) (15)(17), R.S. 40:604, and R.S. 40:922.

HISTORICAL NOTE: Promulgated by the Department of Health and Hospitals, Office of Public Health, LR 37:2648 (September 2011).

§121. Labeling

A. All dairy products (including but not limited to, milk, milk products, anomalous milk, anomalous milk products, anomalous dairy products, filled milk, filled milk products, filled dairy products, imitation milk, imitation milk products, imitation dairy products and frozen desserts) being offered for sale, distribution or held in storage within the state shall be labeled in accordance with the requirements of this Code determined to be applicable to such products by the state health officer, the State Food, Drug and Cosmetic Law (R.S. 40:601 et seq.), the *Federal Food, Drug and Cosmetic Act, as amended, the Nutrition Labeling and Education Act of 1990*, as amended, and regulations developed thereunder, the *Code of Federal Regulations* and the *Pasteurized Milk Ordinance (PMO)*.

B. Dairy plants which offer milk, milk products and condensed, concentrated or dry dairy products for sale in the state shall use labels which prominently display the grade of the product when grades for such products have been established by the state health officer.

C. All bottles, containers, wrappers and packages of a capacity of six gallons or less which enclose milk and milk products, shall be conspicuously marked with:

1. the name and address of the plant or Federal Information Processing Standards (FIPS) number [in indelible ink (or equivalent)] of the plant where the contents were pasteurized, ultra-pasteurized or aseptically processed. The name and address of the plant or the FIPS number shall be printed on the container or label in such a manner that it cannot be removed, changed or defaced;

2. a date, code or lot number that identifies the date, run or batch from which the contents originated, shall be prominently displayed on each final container (container that will reach the final consumer) of dairy product in indelible ink (or equivalent). The date, code or batch shall be printed on the container or label in such a manner that it cannot be removed, changed or defaced;

3. the words, “keep refrigerated after opening”, in the case of aseptically processed dairy products;

4. the name of the dairy product followed by the words “with vegetable fat” conspicuously displayed on the principal display panel in cases in which the product is a filled milk, filled milk product or filled dairy product. The letters in the words “with vegetable fat” shall be at least as large and as prominent as the letters in the name of the dairy product. Examples of this requirement include: “low fat milk with vegetable fat”, “cultured cream with vegetable fat”, “evaporated non fat milk with vegetable fat”;

5. the word, “goat”, “sheep”, “water buffalo” or the common name of any other hooved mammals shall precede the name of the milk and milk product when the product is made from the milk of animals other than cows;

6. the words “grade a”, “grade b”, “extra grade” or “standard grade” whichever is appropriate on the exterior surface when grades for the product have been established by the state health officer. Acceptable locations shall include the principal display panel, the secondary or informational panel or the cap/cover;

7. the words, “a product of”, followed by the name of the country in which the product was processed, except in cases in which the product was processed in the United States or Puerto Rico.

8. the word “reconstituted” or “recombined” if the product was made by reconstitution or recombination; and,

9. the words “made from unpasteurized milk” shall be prominently displayed on the principal display panel of each container of dairy product made from milk, milk products, anomalous milk or anomalous milk products, filled milk or filled milk products, imitation milk or imitation milk products in which each particle has not been pasteurized, ultra-pasteurized or aseptically processed except ripened (aged) cheeses.

D. Approval of the state health officer shall be obtained for all labels used on dairy products prior to the product being offered for sale in Louisiana.

E. All labeling of dairy products shall not be false or misleading in any particular in accord with the requirements of R.S. 40:608 (misbranded food).

F. Containers of dairy products, for which a grading protocol has been established shall be labeled with the appropriate grade of the product.

G. Containers labeled with a grade that contain products that do not conform with the requirements of this Part for that grade shall not be sold or offered for sale in this state.

AUTHORITY NOTE: Promulgated in accordance with the provisions of R.S. 40:4(A)(1)(a). Also see R.S. 40:5(2)(3)(5)(7)(15)(17), R.S. 40:604, and R.S. 40:922.

HISTORICAL NOTE: Promulgated by the Department of Health and Hospitals, Office of Public Health, LR 37:2648 (September 2011).

Chapter 3. Sampling, Examination, Inspections, Grading, Enforcement Procedures and Standards of Dairy Products Including Frozen Desserts

§301. General Requirements

A. Each dairy facility (dairy farm, receiving station, transfer station, dairy plant, single service containers and closures for milk and milk products manufacturing plant, milk tank truck, milk tank truck cleaning facility, finished product depot, final product transfer point) domiciled in the state shall conform with each requirement contained in this Part that is determined to be applicable to such facilities by the state health officer. Each dairy product brought into Louisiana from outside of the state for consumption within the state shall comply with each standard and specification determined by the state health officer to be applicable to each type of product and shall be produced, processed, stored, handled and distributed by dairy facilities that comply with each requirement determined by the state health officer to be applicable to each type of dairy facility involved with the products. The state health officer shall enforce each requirement for dairy facilities, contained in this Part, in a manner that is equal, impartial and equitable regardless of facility size, type, state or country in which they are domiciled. Dairy products regulated under the provisions of this Part shall be enforced in the aforesaid manner.

B. Registered sanitarians operating under the authority of the state health officer who meet the training and certification requirements for the inspection and auditing of dairy farms, milk tank trucks, dairy plants and milk and milk product containers and closure manufacturing plants shall perform all inspections and audits required of the state health officer.

C. Registered sanitarians who have extensive knowledge of dairy farm operations, milking operations, farm milk handling operations, construction, cleanliness, sanitation and operation of dairy farms and dairy farm waste facilities may apply for certification as dairy farm inspectors.

D. A certified milk Sanitation Rating Officer (SRO) certified for rating dairy farms by the PHS/FDA shall be the certification authority for dairy farm inspectors. The registered sanitarians applying for certification shall independently inspect, without prompting or any other type assistance, five dairy farms selected at random by the SRO. The SRO shall independently inspect the same five dairy farms. In order to be certified, the applicant shall agree with the SRO 80 percent on individual items of sanitation found to be violative at each of the five dairy farms inspected. After discussion with the SRO the applicant shall demonstrate, to the SRO's satisfaction, that he/she understands the items of sanitation which he/she failed to properly identify during each inspection/audit.

E. Registered sanitarians who have extensive knowledge of dairy plant and single service milk and milk products container manufacturing plant operations, equipment construction, operation, cleaning and sanitation, product processing requirements, CIP systems, pasteurizer operation, testing of pasteurization equipment and controls, butter manufacturing, cheese manufacturing and condensing and drying plant operations and sanitation requirements may apply for certification as dairy plant and single service milk and milk products containers and closures manufacturing plants inspectors. Registered sanitarians who perform Hazard Analysis Critical Control Point (HACCP) audits of dairy plants shall have successfully completed the NCIMS training requirements for state regulatory personnel conducting HACCP audits on dairy plants. SRO's who audit dairy plants shall have successfully completed the NCIMS training requirements for SRO's that perform HACCP listing audits and shall have been standardized by the PHS/FDA.

F. A certified milk Sanitation Rating Officer (SRO) certified for performing NCIMS required milk sanitation rating of milk and milk products receiving stations, transfer stations, milk and milk product plants, milk tank truck cleaning facilities and single service milk and milk products container manufacturing plants by the PHS/FDA shall be the certification authority for dairy plant and single service milk and milk products containers plant inspectors. The registered sanitarians applying for certification shall inspect at least two milk and milk products processing plants, one single service milk and milk products container and closure manufacturing plant, one condensing and drying plant (provided such plant exist within the state) and one cheese manufacturing plant without prompting or assistance of any type. The SRO shall independently inspect the same plants that were inspected by the applicant. In order to be certified, the applicant shall agree with the SRO 80 percent on individual items of sanitation found to be violative at each of the plants inspected. After discussion with the SRO, the applicant shall demonstrate to the SRO's satisfaction, that he/she understands the items of sanitation which he/she failed to properly identify during each inspection.

G. Registered sanitarians who have extensive knowledge of milk tank truck operations, construction, cleaning and sanitization and of all equipment used in the loading, unloading, cleaning and sanitation of milk tank trucks,

requirements for bulk milk tank truck operators/samplers, milk plant receivers/samplers may apply for certification as milk tank truck inspectors.

H. A certified milk SRO certified by PHS/FDA for performing NCIMS required milk sanitation ratings on milk and milk products, receiving stations, transfer stations, milk and milk products plants, milk tank truck cleaning facilities and single service milk and milk products containers and closure manufacturer plants shall be the certification authority for milk tank truck inspectors. The registered sanitarian applying for certification or re-certification shall inspect at least five milk tank trucks selected at random by the SRO without prompting or assistance of any type. The SRO shall independently inspect the same milk tank trucks that were inspected by the applicant. In order to be certified, the applicant shall agree with the SRO 80 percent on individual items of sanitation found to be violative on each of the five milk tank trucks inspected. After discussion with the SRO, the applicant shall demonstrate to the SRO's satisfaction, that he/she understands the items of sanitation which he/she failed to identify during each inspection.

I. Personnel operating under the authority of the state health officer, including farm bulk milk tank truck operators/samplers licensed by the state health officer shall meet all requirements for personnel who collect official samples contained in this Part and the PMO and any NCIMS requirements for such personnel.

J. Personnel operating under the authority of the state health officer who programmatically supervise registered sanitarians who inspect or audit dairy facilities shall meet all certification requirements contained in this part for the certified inspectors whom they supervise. Certification of registered sanitarians who inspect dairy farms and milk tank trucks and inspect or audit dairy plants and single service milk and milk products containers and closure manufacturing plants shall be for a period not to exceed two years and may be revoked by the state health officer for cause.

K. All registered sanitarians operating under the authority of the state health officer who are certified to inspect/audit dairy facilities shall be physically capable of inspecting/auditing all areas of the type of dairy facility and equipment therein, for which they are certified.

L. All registered sanitarians operating under the authority of the state health officer shall conform with the safety, dress, speed limit and other such regulations of the facility pertaining to the employees of that specific facility, while they are on the premises of the facility. They shall also comply with all such requirements of the Milk and Dairy Program.

AUTHORITY NOTE: Promulgated in accordance with the provisions of R.S. 40:4(A)(1)(a). Also see R.S. 40:5(2)(3)(5)(7)(15)(17)(19)(21) and R.S. 40:922.

HISTORICAL NOTE: Promulgated by the Department of Health and Hospitals, Office of Public Health, LR 37:2649 (September 2011).

Subchapter A. Sampling and Examination of Dairy Products Including Frozen Desserts

§303. Delivery of Samples

A. All persons engaged in the production, processing, handling or selling of milk, milk products or other dairy products shall deliver to the state health officer, upon request, samples of the dairy products in his possession. The state health officer shall not be required to pay for these samples. Any refusal to deliver such samples in his possession shall be deemed a violation of these regulations. All samples so collected shall be sealed, when possible, in the presence of the person from whom taken.

AUTHORITY NOTE: Promulgated in accordance with the provisions of R.S.40:4(A)(1)(a). Also see R.S. 40:5(2)(3)(5)(7)(15)(17) and R.S. 40:922.

HISTORICAL NOTE: Promulgated by the Department of Health and Hospitals, Office of Public Health, LR 37:2650 (September 2011).

§305. Samples and Examinations

A. Samples of milk, milk products or other dairy products from stores, soda fountains, restaurants, finished product depots and other places where dairy products are handled, stored or sold shall be examined to determine compliance with the product standards contained in this Part as often as the state health officer may require.

B. The state health officer shall collect samples of milk, milk products or other dairy products being sold within the state that were processed by each dairy plant domiciled in other states or countries and test them for compliance with the standards for such products contained in this Part as required by the state health officer.

C. Samples of milk, milk products or other dairy products shall be taken prior to sale to the final consumer. Samples of dairy products collected from containers other than dairy product storage, processing or bulk transportation tanks or totes that have been opened/uncapped shall not be considered official.

AUTHORITY NOTE: Promulgated in accordance with the provisions of R.S.40:4(A)(1)(a). Also see R.S. 40:5(2)(3)(5)(7)(15)(17) and R.S. 40:922.

HISTORICAL NOTE: Promulgated by the Department of Health and Hospitals, Office of Public Health, LR 37:2650 (September 2011).

§307. The Official Sampling of Dairy Plant Environments and Dairy Products Including Frozen Desserts

A. Each bulk milk tank truck operator/sampler shall collect a representative sample of raw milk from each farm bulk tank prior to transferring the milk from the farm bulk tank to a milk tank truck each time raw milk is removed from the farm bulk tank. All samples shall be collected as directed by the state health officer and at least one set of samples collected from each farm bulk tank of each dairy farm supply represented in the load shall accompany the

load of milk to the dairy plant, receiving station or transfer station at which it is unloaded.

B. Each dairy plant receiver/sampler shall collect a representative sample of raw milk from each tanker of raw milk that unloads at the plant each day. The dairy plant receiver/sampler shall obtain one set of the samples, collected by the bulk milk tank truck operator sampler, from each farm bulk tank of raw milk represented on the loads of raw milk from which the tanker samples were obtained. The dairy plant receiver/sampler shall store all of the samples in a manner consistent with the requirements of this Part and deliver them to the state health officer when requested.

C. The state health officer may sample the environments of each dairy plant using approved methodology for the sampling of plant environments for contamination with pathogenic microorganisms of human significance as often as he deems necessary. Controlling the environments of dairy plants to prevent contamination with pathogenic microorganisms is of utmost public health importance.

D. During each consecutive six months, at least four samples of raw milk for pasteurization, ultra-pasteurization and aseptic processing shall be collected in at least four separate months, except when three months show a month in which two of the sampling dates were separated by at least 20 days, and delivered in accordance with the requirements of this section from each farm bulk tank of each producer. These samples shall be obtained under the direction of the state health officer or shall be collected from each producer by the state health officer.

E. During each consecutive six months, at least four samples of commingled raw milk for pasteurization, ultra-pasteurization or aseptic processing, collected in at least four separate months, except when three months show a month containing two sampling dates separated by at least 20 days, shall be taken from each dairy plant after receipt of the milk by the plant and prior to pasteurization, ultra-pasteurization or aseptic processing by the state health officer.

F. During each consecutive six months, at least four samples of heat-treated milk and milk products, from each plant offering such products for sale, shall be collected in at least four separate months, except when three months show a month containing two sampling dates separated by at least 20 days, by the state health officer.

G. During each consecutive six months, at least four samples of each type of dairy product being processed by each dairy plant domiciled within the state shall be collected by the state health officer. Each fat level of product, each flavor of flavored products, and each type of cultured product shall be sampled by the state health officer. The state health officer shall attempt to collect these samples of product in each size and type of container packaged by each plant.

H. During each consecutive 12-month period the state health officer shall collect from each dairy plant domiciled in Louisiana at least one sample of each dairy product to which vitamins have been added.

I. If production of any dairy product, for which a grading system is prescribed by this Part, is not on a yearly basis at least five samples shall be taken within a continuous production period.

AUTHORITY NOTE: Promulgated in accordance with the provisions of R.S. 40:4(A)(1)(a). Also see R.S. 40:5(2)(3)(5)(7) (15)(17) and R.S. 40:922.

HISTORICAL NOTE: Promulgated by the Department of Health and Hospitals, Office of Public Health, LR 37:2650 (September 2011).

§309. Laboratory Examination of Dairy Products Including Frozen Desserts and Tests for Environmental Pathogens

A. The following laboratory examinations shall be performed on milk and dairy products, including frozen desserts.

1. Standard plate counts, drug residue tests, somatic cell counts and cooling temperature checks shall be performed on raw milk for pasteurization, ultra-pasteurization and aseptic processing from each producer's milk supply domiciled in the state at a frequency required in §307.D on samples collected by the state health officer or under the direction of the state health officer.

2. Standard plate counts, drug residue tests and cooling temperature checks shall be performed on commingled raw milk for pasteurization, ultra-pasteurization and aseptic processing from the supply of each dairy plant domiciled in Louisiana at a frequency required in §305.E on samples collected by the state health officer.

3. Sediment tests, tests for aflatoxins, beta lactams, tetracyclines, sulfonamides, tests for added water and other tests determined to be necessary by the state health officer shall be performed on raw milk samples collected from each farm bulk milk tank truck load of raw milk that unloaded at each dairy plant, transfer station and receiving station on two consecutive days during each consecutive six-month period.

4. All raw milk samples collected from each farm bulk milk tank represented on each load of raw milk that was found to have a USDA sediment standard that exceed number three or was found to be positive for any of the other tests listed in §309.A.3 above shall be tested using the same test from which the sediment result that exceed three or the positive result on the other tests were obtained on the sample from the load of raw milk.

5. Standard plate counts, drug residue tests and temperature checks, which are determined to be necessary by the state health officer, shall be performed on each type of heat treated dairy product processed by each dairy plant domiciled in the state at a frequency required in §307.F on samples collected by the state health officer.

6. Standard plate counts, coliform counts, drug residue tests, phosphatase tests and cooling temperature checks, which are determined to be necessary by the state health officer shall be performed on each type of dairy product, including frozen desserts, processed by each dairy plant domiciled in the state at a frequency required in §307.G on

samples collected by the state health officer or under the direction of the state health officer,

7. Standard plate counts, drug residue tests, coliform counts and cooling temperature checks shall be performed on condensed and concentrated dairy products produced by each dairy plant domiciled in the state at a frequency required in §307.G on samples collected by the state health officer or under the direction of the state health officer,

8. Standard plate counts and coliform counts shall be performed on each type of dry dairy product processed or blended by each dairy product drying or dairy product blending plant domiciled in the state at a frequency required in §307.G on samples collected by the state health officer or under the direction of the state health officer,

9. Drug residue tests determined to be appropriate by the state health officer shall be performed on each type of aseptically processed dairy product produced by each dairy plant domiciled in the state at a frequency required in §307.G on samples collected by the state health officer or under the direction of the state health officer.

10. Tests for contamination of finished products with pesticides, herbicides, PCB's, etc., shall be performed at intervals determined by the state health officer, on all finished products being sold or produced in Louisiana.

B. All sampling procedures and required laboratory examinations shall be conducted in laboratories approved by the state health officer and shall be in substantial compliance with the requirements of the *PMO*, the *Standard Methods for the Examination of Dairy Products*, the *Official Methods of Analysis*. Such procedures, including the certification of sample collectors and examinations shall be evaluated by the state health officer in accordance with the *Evaluation of Milk Laboratories*. Aseptically processed milk and milk products packaged in hermetically sealed containers shall be tested in accordance with the *Bacteriological Analytical Manual*. Examinations and tests to detect adulterants, including pesticides, shall be conducted as the state health officer requires. Assays of dairy products to which vitamin A, vitamin D or vitamins A and D have been added, shall be made at least annually in a laboratory which has been accredited by the U. S. Food and Drug Administration and which is acceptable to the state health officer, using test methods acceptable to the FDA and other official methodologies which give results statistically equivalent to the FDA methods.

C. All facilities fortifying products with vitamins shall keep volume control records. These volume control records shall cross reference the form and amount of vitamin D, vitamin A or vitamins A and D used with the amount of product produced and indicate a percent (plus or minus) of expected use.

AUTHORITY NOTE: Promulgated in accordance with the provisions of R.S. 40:4(A)(1)(a). Also see R.S. 40:5(2)(3)(5)(7) (15)(17) and R.S. 40:922.

HISTORICAL NOTE: Promulgated by the Department of Health and Hospitals, Office of Public Health, LR 37:2651

(September 2011), amended by the Department of Health, Office of Public Health, LR 43:1392 (July 2017).

Subchapter B. Inspections/Audits

§311. Frequency of Inspections/Audits

A. Each dairy farm, dairy plant including frozen desserts manufacturing plant, filled dairy products manufacturing plant, anomalous milk and milk products and other anomalous dairy product manufacturing plant, receiving station, milk tank truck cleaning facility, transfer station, single-service containers and closures for milk and milk products manufacturing plant, finished product depot/transfer point and dairy plant receiver/sampler, bulk milk tank truck operator/sampler and milk tank truck domiciled or operating in the state shall be inspected/audited by the state health officer prior to the issuance of a permit.

B. Following the issuance of a permit the state health officer shall:

1. Inspect the receiving, processing/packaging, cleaning, pre-operation and start-up procedures of each dairy plant including frozen dessert manufacturing plants at least once each month. (For the purposes of this Paragraph, the term “dairy plant” used herein shall not include receiving stations, transfer stations, single-service containers and closures for milk and milk products manufacturing plants, milk tank truck cleaning facilities and finished product depot/transfer points.)

2. Inspect receiving stations, transfer stations, single-service containers and closures for milk and milk products manufacturing plants, milk tank truck cleaning facilities and finished product depot/transfer point at least once each three months.

3. Inspect/audit each dairy plant, including frozen dessert manufacturing plants, that are required by the state health officer to implement HACCP systems or have been authorized by the state health officer to be regulated under the HACCP requirements contained in Chapter 11 of this Part with a frequency goal of at least once each month.

4. Inspect each milk tank truck and its appurtenances at least once each 12 months.

5. Observe and evaluate the receiving and sampling procedures of each dairy plant receiver/sampler at least once each three months to determine compliance with applicable requirements.

6. Observe and evaluate the milk pickup and sampling procedures of each bulk milk tank truck operator/sampler at least once each 24 months to determine compliance with applicable requirements.

7. Inspect each dairy farm with a frequency at least as that required by the Performance-Based Inspection Program.

C. Performance-Based Inspection Program requirements:

1. A risk assessment shall be performed on each dairy farm once each month by evaluating the performance of the farm using the last standard plate count, somatic cell count,

sanitation compliance score, sediment score, drug residue test, coliform count of the water supply and other areas of the operation related to product safety as the criteria for establishing the Inspectional Frequency Category for the dairy farm.

2. The state health officer shall inspect dairy farms in each category at a frequency not less than the following intervals:

- a. category I: at least once each three months;
- b. category II: at least once each two months;
- c. category III: at least once each month; and,

d. category IV: within 21 days of the last inspection but not before the lapse of three days.

3. The following criteria shall be used to categorize farms into the Inspection/Frequency Categories as defined below:

a. Category I (minimum of one inspection each three months):

i. standard plate count (SPC) not exceeding 10,000 cfu/milliliter (ml.);

ii. somatic cell count (SCC) not exceeding 250,000/ml;

iii. sanitation compliance score 97 percent - 100 percent;

iv. sediment not exceeding four;

v. no drug residue violations;

vi. no violation which may reasonably likely result in adulteration of

the milk supply or an imminent hazard to the public's health; and,

vii. bacteriologically safe water supply.

b. Category II (minimum of one inspection each two months):

i. SPC 11,000 cfu/ml. - 50,000 cfu/ml;

ii. SCC 251,000/ml. - 500,000/ml;

iii. sanitation compliance score 93 percent - 96 percent;

iv. sediment not exceeding four;

v. no drug residue violations;

vi. no violation which may reasonably likely result in adulteration of the milk supply or an imminent hazard to the public's health; and,

vii. bacteriologically safe water supply.

c. Category III (minimum of one inspection each month):

i. SPC 51,000 cfu/ml.—100,000 cfu/ml;

- ii. SCC 501,000/ml.—750,000/ml;
- iii. sanitation compliance score 90 percent—92 percent;
- iv. sediment not exceeding four;
- v. no drug residue violations;
- vi. no violation which may reasonably likely result in adulteration of the milk supply or an imminent hazard to the public’s health; and,

vii. bacteriologically safe water supply.

d. Category IV (inspect within 21days of the last inspection, but not before the lapse of three days):

- i. SPC not exceeding 100,000 cfu/ml.;
- ii. SCC not exceeding 750,000/ml.;
- iii. sanitation compliance score less than 90 percent;
- iv. sediment four;
- v. one or more drug residue violation(s);
- vi. one or more violation(s) that may reasonably likely result inadulteration of the milk supply or an imminent hazard to the public’s health;

vii. unsafe water supply.

viii. one or more warning letters issued due to non-compliance of two out of four previous sample results for SPC or SCC during last two months; and,

ix. farm conditions which caused the state health officer to take official regulatory action (i.e.; warning letter, intent to suspend, reinspection, etc).

4. When the risk assessment of a dairy farm indicates a category IV in one or more criteria the next inspection of the dairy farm should include:

a. an evaluation of the cleaning equipment and procedures when the SPC category is IV;

b. an evaluation of milking procedures and the environment of the areas of the farm in which the milking herd is kept when the SCC category is IV;

c. a conference with the owner/operator when the sanitation compliance score category is IV; and,

d. an evaluation of the milking procedures, milking equipment and the environment of the areas of the farm in which the milking herd is kept when the sediment category is IV.

AUTHORITY NOTE: Promulgated in accordance with the provisions of R.S. 40:4(A)(1)(a). Also see R.S. 40:5(2)(3)(5)(7) (15)(17) and R.S. 40:922.

HISTORICAL NOTE: Promulgated by the Department of Health and Hospitals, Office of Public Health, LR 37:2652 (September 2011).

§313. Pasteurization Equipment Tests, Examinations and Sealing

A. The state health officer shall perform the tests using the methodology prescribed in the *PMO* on the instruments and devices of each pasteurizer in each dairy plant and frozen dessert manufacturing plant indicated in the table below initially upon installation; and at least once each three months, including the remaining days of the month in which the equipment tests are due and whenever any alteration or replacement is made which may affect the proper operation of the instrument or device. Provided, that the holding time test shall be conducted at least once each six months, including the remaining days of the month in which the equipment test is due. A copy of the test report shall be retained by the plant.

Test No.	Equipment/Device/ Instrument	Test Type
1	Vat, HTST, HHST, aseptic indicating and airspace thermometers	Temperature accuracy
2	Vat, HTST, HHST, aseptic recording thermometer	Temperature accuracy
3	Vat, HTST, HHST, aseptic recording thermometer	Time accuracy
4	Vat, HTST, HHST, aseptic indicating and recording thermometer	Recording vs Indicating thermometer
5.1	HTST, HHST FDD	Leakage pass FDD
5.2	HTST, HHST FDD	FDD freedom of movement
5.3	HTST, HHST FDD	Device assembly (single stem)
5.4	HTST, HHST FDD	Device assembly (dual stem)
5.5	HTST FDD	Manual diversion
5.6	HTST, HHST FDD	Response time
5.7	HTST, HHST FDD	Time delay (inspect)
5.8	HTST, HHST FDD	Time delay (CIP)
5.9	HTST FDD	Time delay (leak detect flush)
6	Vat leak protector valve(s)	Leakage
7	HTST indicating thermometers	Response time
8	HTST recording thermometers	Response time
9.1	HTST pressure switches	Regenerator pressures
9.2.1	HTST, HHST, aseptic differential pressure controllers	Calibration
9.2.2	HTST differential pressure controllers	Regenerator pressure
9.2.3	HHST and aseptic differential pressure controllers	Regenerator pressure
9.3.1	HTST booster pump/FDD	Inter-wiring check
9.3.2	HTST booster pump/metering pump	Inter-wiring check
10.1	HTST FDD	Temperature cut-in/cut-out

Test No.	Equipment/Device/ Instrument	Test Type
10.2	HHST FDD, aseptic divert system (indirect heat)	Temperature cut-in/cut-out
10.3	HHST FDD, aseptic divert system (direct heat)	Temperature cut-in/cut-out
11.1	HTST holding tubes/timing pumps (except meter based)	Holding time
11.2.a	HTST holding tubes/magnetic flow meter based timing systems	Holding time
11.2.b	HTST, HHST, aseptic magnetic flow meter based timing systems	Flow alarm
11.2.c	HTST, HHST, aseptic magnetic flow meter based timing systems	Loss of signal/low flow
11.2.d	HTST magnetic flow meter based timing systems	Flow rate cut-in/cut-out
11.2.e	HTST magnetic flow meter based timing systems	Time delay
11.3	HHST holding tubes indirect heat	Holding time
11.4	HHST holding tubes direct injection heat	Holding time
11.5	HHST holding tubes direct infusion heat	Holding time
12.1	HHST, aseptic systems indirect heating	Sequence logic
12.2	HHST, aseptic systems direct heating	Sequence logic
13	HHST, aseptic systems	Pressure in the holding tubes
14	HHST, aseptic systems using direct injection heating	Pressure differential across injector
15	Vat, HTST, HHST, Aseptic (all electronic controls)	Electro-Magnetic Interference

B. Plants being regulated under the provisions of Chapter 11 (Dairy Plant HACCP System) shall be responsible for the performance for all above required tests should the state health officer fail to perform them at the required frequency.

C. The state health officer shall affix regulatory seals to all pasteurization equipment, as prescribed by the *PMO*, after testing the equipment.

D. The state health officer shall provide the plant a copy of the pasteurization equipment test report.

E. The plant shall notify the state health officer immediately if the regulatory seals are broken.

F. The pasteurization equipment shall not be operated without authorization from the state health officer when any of the required regulatory seals are broken.

AUTHORITY NOTE: Promulgated in accordance with the provisions of R.S. 40:4(A)(1)(a). Also see R.S. 40:5(2)(3)(5)(7)(15)(17) and R.S. 40:922.

HISTORICAL NOTE: Promulgated by the Department of Health and Hospitals, Office of Public Health, LR 37:2653 (September 2011).

§315. Milk Sanitation Rating/HACCP Listing Audit

A. Except for those dairy facilities which require a HACCP Listing audit, a milk sanitation rating shall be conducted on each bulk milk tank unit (BTU), single service container and closure manufacturer plant, milk tank truck cleaning facility, receiving station, transfer station, milk and milk products plant, and Grade A condensing and drying plant at least once each year by a certified milk sanitation rating officer using the methodology prescribed in the *Methods of Making Sanitation Rating of Milk Shippers*. Except for those dairy facilities which require a HACCP Listing audit, an inspection of all other dairy plants shall be conducted by a certified milk sanitation rating officer at least once each year using the requirements for that specific type of plant contained in this Part.

B. A HACCP listing audit shall be conducted on each dairy facility being regulated under the HACCP requirements of this Part at least once each year by a certified milk sanitation rating officer that has been standardized and certified as a HACCP listing officer by the FDA.

AUTHORITY NOTE: Promulgated in accordance with the provisions of R.S. 40:4(A)(1)(a). Also see R.S. 40:5(2)(3)(5)(7)(15)(17) and R.S. 40:922.

HISTORICAL NOTE: Promulgated by the Department of Health and Hospitals, Office of Public Health, LR 37:2654 (September 2011).

§317. Posting Inspection Reports

A. One copy of each inspection/audit report shall be handed to the operator or posted by the state health officer in a conspicuous place upon an inside wall of one of the dairy farm or dairy plant buildings, and said inspection report shall not be defaced and shall be made available to the state health officer upon request. The original of the inspection report shall be filed with the records of the state health officer.

AUTHORITY NOTE: Promulgated in accordance with the provisions of R.S. 40:4(A)(1)(a). Also see R.S. 40:5(2)(3)(5)(7)(15)(17) and R.S. 40:922.

HISTORICAL NOTE: Promulgated by the Department of Health and Hospitals, Office of Public Health, LR 37:2654 (September 2011).

§319. Field Supervision

A. Each Bulk Tank Unit (BTU) or others receiving milk from one or more dairy farms shall provide qualified field persons for the purpose of inspecting and testing sources of supply and assisting producers.

AUTHORITY NOTE: Promulgated in accordance with the provisions of R.S. 40:4(A)(1)(a). Also see R.S. 40:5(2)(3)(5)(7)(15)(17) and R.S. 40:922.

HISTORICAL NOTE: Promulgated by the Department of Health and Hospitals, Office of Public Health, LR 37:2654 (September 2011).

Subchapter C. Grading, Enforcement Procedures and Standards

§321. Grading

A. The state health officer shall establish grades and grading protocols for milk, milk products, condensed, concentrated and dried milk products.

B. The state health officer shall grade all milk, milk products, condensed, concentrated and dried milk and milk products produced or processed in the state.

C. The grade of the products shall be based upon:

1. compliance with the regulations governing milk production, milk and milk products and condensed, concentrated or dried dairy products processing and handling contained in this Part; and

2. compliance with the standards for milk and milk products contained in this Part as determined by the examination of at least four samples of milk or milk products and condensed, concentrated or dried dairy products during the current six month period, collected from each supply on separate days production by the state health officer.

D. All cartons, jugs, packages, wrappers, bottles or other containers enclosing graded milk, milk products and condensed, concentrated or dried dairy products shall be conspicuously marked with the grade of the contents on the principal display panel, secondary or informational panel or the cap/cover.

AUTHORITY NOTE: Promulgated in accordance with the provisions of R.S. 40:4(A)(1)(a). Also see R.S. 40:5(2)(3)(5)(7)(15)(17) and R.S. 40:922.

HISTORICAL NOTE: Promulgated by the Department of Health and Hospitals, Office of Public Health, LR 37:2654 (September 2011).

§323. Grades of Milk and Milk Products to be Sold

A. All milk and milk products sold to the final consumer or to restaurants, delicatessens, grocery stores and any other establishments that provide milk or milk products for human consumption shall be Grade A pasteurized, Grade A ultra-pasteurized or Grade A aseptic processed (UHT), provided that dry milk products sold or provided for human consumption may be Extra Grade, provided further that all milk and milk products (except Extra Grade dry milk products) provided to institutions who receive funds from the United States Government or the State of Louisiana for the purchase of milk and milk products shall be Grade A pasteurized, ultra-pasteurized or aseptically processed milk and milk products certified for interstate shipment.

B. Provided, that when the grade of a Grade A product has been lowered to Grade B, the state health officer may authorize the sale of the Grade B milk or milk product for a temporary period, not to exceed 30 days, provided further that the words Grade B shall prominently appear on the principal display panel of all containers of such product.

C. Provided further that extra grade and standard grade dry milk and milk products and ungraded evaporated milk or sweetened condensed milk in containers that have been retort processed after packaging may be sold to the final consumer, restaurants, institutions, grocery stores or other establishments that provide dry milk or milk products or evaporated, concentrated or condensed milk.

D. All raw milk from cows, goats, sheep, water buffaloes and other hooved mammals produced by dairy farms for sale to dairy plants domiciled in Louisiana shall be Grade A raw milk for pasteurization, provided that when the grade of a raw milk supply has been lowered to manufacturing grade raw milk for pasteurization, the state health officer may authorize the sale of manufacturing grade raw milk for pasteurization from the degraded supply for a temporary period, not to exceed 30 days, provided further it is sold for non-Grade A use.

E. The sale, exchange or otherwise providing [including bartering, selling stock in dairy cows in exchange for raw milk, exchanging raw milk in return of animal feed or the cost of animal feed and any other such type arrangement (regardless if there is an actual sale)] of raw milk or dairy products made from raw milk (other than aged/ripened cheese processed in a plant that conforms with the requirements contained in Chapter 25 of this Part) for human or animal consumption is prohibited.

EXCEPTION: This shall not be interpreted to prohibit a farmer from providing raw milk for his/her own animals on his/her own farm.

F. Filled milk, filled milk products, imitation milk products and anomalous milk and milk products shall conform with the bacteriological requirements for Grade A pasteurized, ultra-pasteurized milk, or aseptically processed milk and milk products contained in §355 of this Part and shall be processed and packaged in plants that conform with all of the requirements for dairy plants that process Grade A pasteurized, ultra-pasteurized or aseptically processed milk and milk products contained in §901 (General Requirements for Dairy Plants) of this Part.

AUTHORITY NOTE: Promulgated in accordance with the provisions of R.S.40:4(A)(1)(a). Also see R.S. 40:5(2)(3)(5)(7)(15)(17) and R.S. 40:922.

HISTORICAL NOTE: Promulgated by the Department of Health and Hospitals, Office of Public Health, R 37:2654 (September 2011).

§325. Procedure in Emergency

A. During emergency periods, the state health officer may temporarily permit the sale of ungraded milk.

AUTHORITY NOTE: Promulgated in accordance with the provisions of R.S. 40:4(A)(1)(a). Also see R.S. 40:5(2)(3)(5)(7)(15)(17) and R.S. 40:922.

HISTORICAL NOTE: Promulgated by the Department of Health and Hospitals, Office of Public Health, LR 37:2655 (September 2011).

§327. Continuous Grading

A. If at any time the lowering of the grade of a raw milk supply or dairy product becomes justified in accordance with

§329 or §333 of this Part, the state health officer shall lower the grade of such milk or milk product and shall enforce proper labeling thereof.

AUTHORITY NOTE: Promulgated in accordance with the provisions of R.S. 40:4(A)(1)(a). Also see R.S. 40:5(2)(3)(5)(7)(15)(17) and R.S. 40:922.

HISTORICAL NOTE: Promulgated by the Department of Health and Hospitals, Office of Public Health, LR 37:2655 (September 2011).

Subchapter D. Degrading or Suspension of Permit

§329. Degrading or Suspension of Permit Based upon Physical Violations

A. If during an inspection or audit the state health officer finds a violation(s) of this Part, he shall record the violation(s) on an inspection/audit report. A copy of the inspection/audit report shall be handed to the operator or posted in a prominent place on the premises.

B. In cases in which the state health officer finds conditions or violations of this Part that he deems to be of serious nature, violations that have not been corrected since the last inspection or reoccurring violations, he shall notify the operator, in writing, of the conditions or violations and specify a reasonable time, but not before the lapse of three days, in which the conditions or violations shall be corrected. The requirement of giving written notice shall be deemed to have been satisfied by handing it to the operator or posting it in a prominent place on the premises. The operator shall be allowed to request an extension of the time allowed for correction. The state health officer may authorize an extension of time for correction when warranted by the circumstances.

C. When the state health officer has specified a time in which conditions or violations shall be corrected, as in §329.B above, he shall conduct a second inspection after the time specified. In cases in which the second inspection reveals that the conditions or violations have not been corrected to the satisfaction of the state health officer, he may lower the grade of the milk supply or dairy product. In cases in which grades and grading criteria have not been established for a supply or a product and the second inspection reveals that any of the conditions or violations have not been corrected to the satisfaction of the state health officer, he may suspend the permit of the operator.

AUTHORITY NOTE: Promulgated in accordance with the provisions of R.S. 40:4(A)(1)(a). Also see R.S. 40:5(2)(3)(5)(7)(15)(17) and R.S. 40:922.

HISTORICAL NOTE: Promulgated by the Department of Health and Hospitals, Office of Public Health, LR 37:2655 (September 2011).

§331. Notification of Laboratory Analyses

A. When two of the last four standard plate counts or temperature checks, sediment tests or somatic cell counts of a raw milk supply fail to meet the requirements contained in this Part, the state health officer shall send written notice thereof by certified or return receipt request mail to the

permittee concerned and shall take an additional sample, within 21 days but not before the lapse of three days from the date of receipt of such notice.

B. When two of the last four standard plate counts or temperature checks from a heat treated dairy product supply fail to meet the requirements contained in this Part, the state health officer shall send written notice thereof by certified or return receipt request mail to the permittee concerned and shall take an additional sample, within 21 days but not before the lapse of three days from the date of receipt of such notice.

C. When two of the last four standard plate counts or coliform counts or temperature checks from a pasteurized dairy product, including frozen desserts, filled dairy products and anomalous dairy products fail to meet the requirements contained in this Part, the state health officer shall send written notice thereof by certified or return receipt request mail to the permittee concerned and shall take additional sample, within 21 days but not before the lapse of three days from the date of receipt of such notice.

AUTHORITY NOTE: Promulgated in accordance with the provisions of R.S. 40:4(A)(1)(a). Also see R.S. 40:5(2)(3)(5)(7)(15)(17) and R.S. 40:922.

HISTORICAL NOTE: Promulgated by the Department of Health and Hospitals, Office of Public Health, LR 37:2655 (September 2011).

§333. Degrading or Suspension of Permit or Removal of Product from the Market Based upon Laboratory Analyses

A. In cases in which the written notice required in §331 of this Part has been received by the operator and whenever three of the last five samples fail to meet the standard plate count, coliform count, sediment score, temperature check or somatic cell count requirements of this code unless the last individual sample result meets the requirements, the state health officer shall:

1. Degrade the raw milk supply or dairy product to the appropriate grade, in cases in where grades and grading protocol have been established.

2. Suspend the operator's permit in cases where grades and grading protocol have not been established, provided that the state health officer may allow the operator to discontinue the sale of the violative product(s) rather than suspend the permit.

B. Whenever a phosphatase test result is positive, suspend the permit for the product, place all product that is reasonably likely to have not been properly pasteurized under official seizure and require that any such product that has entered commerce be recalled by the processor and disposed of as directed by the state health officer.

C. Whenever pathogenic microorganisms of human significance are found in a dairy plant environment, require the plant operator to submit a written corrective action plan for eliminating and preventing the reoccurrence of the contamination to the state health officer for approval. The state health officer shall, during each inspection/audit

determine whether or not the plant is in conformity with the written corrective action plan. Failure to conform with the approved corrective action plan shall be grounds for suspension of permit.

AUTHORITY NOTE: Promulgated in accordance with the provisions of R.S. 40:4(A)(1)(a). Also see R.S. 40:5(2)(3)(5)(7)(15)(17) and R.S. 40:922.

HISTORICAL NOTE: Promulgated by the Department of Health and Hospitals, Office of Public Health, LR 37:2656 (September 2011).

§335. Suspension of Permit Based on Laboratory Analyses - Adulteration or Contamination with Pathogenic Microorganisms of Human Significance

A. Should any raw milk supply or dairy product including frozen desserts, anomalous milk and milk products and filled dairy products be found to be adulterated (water, drug residues, pesticide/herbicides, etc.), the state health officer shall immediately suspend the permit and place all product that may reasonably likely be adulterated, under official seizure. The state health officer shall require that the owner of the adulterated product, expeditiously remove any of the product that had entered commerce and to comply with instructions from the state health officer for the disposition of such product.

B. Should any pasteurized dairy product, including frozen desserts, anomalous milk and milk products and filled dairy products be found to contain one or more pathogenic microorganisms of human significance, the state health officer shall immediately suspend the permit and place all contaminated product and all product reasonably likely to be contaminated under official seizure. The state health officer shall require the owner of the product to expeditiously remove any of the product that had entered commerce and to comply with instructions from the state health officer for the disposition of such product. Provided, further, that raw and heat treated dairy products are excluded from this requirement.

C. Whenever the pasteurization recording charts for products requiring pasteurization are not available for review, the state health officer shall suspend the permit for the product and place under official seizure and require that any product involved that has entered commerce be recalled by the processor and disposed of as directed by the state health officer.

AUTHORITY NOTE: Promulgated in accordance with the provisions of R.S. 40:4(A)(1)(a). Also see R.S. 40:5(2)(3)(5)(7)(15)(17) and R.S. 40:922.

HISTORICAL NOTE: Promulgated by the Department of Health and Hospitals, Office of Public Health, LR 37:2656 (September 2011).

§337. Suspension of Permit for Reasons Other than Laboratory Analyses

A. The state health officer shall immediately suspend the permit to operate when:

1. the state health officer finds a condition(s) existing on a dairy farm, in a dairy product manufacturing plant

(including frozen desserts manufacturing plant and filled dairy products manufacturing), single service milk container or closure manufacturing plant or at a finished product depot/transfer point that he determines is reasonably likely to constitute an imminent hazard to the public's health;

2. a series of observations made during an inspection or audit is determined by the state health officer to indicate that a plant does not have sufficient control of its operations to prevent a compromise to food safety;

3. the holder of the permit or his employees or agents interfere with the state health officer in the performance of his duties; or,

4. the holder of the permit or his employees have falsified documents, charts or other records pertaining to the safety of dairy products.

AUTHORITY NOTE: Promulgated in accordance with the provisions of R.S. 40:4(A)(1)(a). Also see R.S. 40:5(2)(3)(5)(7)(15)(17) and R.S. 40:922.

HISTORICAL NOTE: Promulgated by the Department of Health and Hospitals, Office of Public Health, LR 37:2656 (September 2011).

§339. Seizure and Condemnation of Milk, Dairy Products, Ingredients of Milk and Ingredients of Dairy Products

A. Any milk, milk product or other dairy product, ingredient or component of such products that the state health officer determines to be adulterated, misbranded or not registered or which has been manufactured, processed or packaged in an establishment, which did not, at the time of manufacture, processing or packing, hold a valid permit issued by the state health officer is subject to seizure and condemnation by the state health officer as provided in §§632, 633, 634 and 635 of the State of Louisiana Food, Drug and Cosmetic Law, which is found in Part I, Chapter 4, Title 40 of the Louisiana Revised Statutes, as well as any applicable regulations which implement this law.

AUTHORITY NOTE: Promulgated in accordance with the provisions of R.S. 40:4(A)(1)(a). Also see R.S. 40:5(2)(3)(5)(7)(15)(17) and R.S. 40:922.

HISTORICAL NOTE: Promulgated by the Department of Health and Hospitals, Office of Public Health, LR 37:2656 (September 2011).

Subchapter E. Regrading and Reinstatement of Permit

§341. Application for Regrading, Reinstatement of Permit and Permission to Resume Sale of Product

A. Any producer or processor, the grade of whose milk supply or dairy products has been lowered or whose permit has been suspended by the state health officer, and who is properly labeling his dairy products, or who has removed the product from the market and has corrected the condition(s) that resulted in the suspension of the permit or degrade, may at any time make application for the regrading of his product

or reinstatement of his permit or for being allowed to resume the sale of a product that has been removed from the market.

AUTHORITY NOTE: Promulgated in accordance with the provisions of R.S. 40:4(A)(1)(a). Also see R.S. 40:5(2)(3)(5)(7)(15)(17) and R.S. 40:922.

HISTORICAL NOTE: Promulgated by the Department of Health and Hospitals, Office of Public Health, LR 37:2657 (September 2011).

§343. Regrading or Reinstatement of Permit when Degrade or Suspension was Based on Laboratory Analyses

A. Upon receipt of a satisfactory application from the operator, when the lowered grade or suspension of permit is the result of violative standard plate counts, violative coliform counts, violative temperatures, violative somatic cell counts, or violative sediment scores the state health officer shall take additional samples of the applicant's output at a rate of one sample from a single day's production and not more than two samples per week. The state health officer may:

1. regrade the milk supply or dairy product upward, whenever a minimum of two successive samples meet the grade requirements of a higher grade provided they are the last two samples collected; or

2. reinstate the permit of the manufacturer or allow the sale of a non-grade product that has been removed from the market whenever a minimum of two successive samples meet the bacteriological or chemical standards for such non-graded products, provided they are the last two samples collected.

AUTHORITY NOTE: Promulgated in accordance with the provisions of R.S. 40:4(A)(1)(a). Also see R.S. 40:5(2)(3)(5)(7)(15)(17) and R.S. 40:922.

HISTORICAL NOTE: Promulgated by the Department of Health and Hospitals, Office of Public Health, LR 37:2657 (September 2011).

§345. Regrading and Reinstatement of Permit when Degrade or Suspension was Based on Physical Violations

A. Whenever a suspension of a permit or the lowering of grade of a product or supply was the result of a violation of an item of these regulations other than laboratory results, the application referenced in §341 of this Part must be accompanied by a statement signed by the applicant stating that the violative item(s) of the regulations has been corrected. Within one week of receipt of such an application and statement, the state health officer shall make a re-inspection of the applicant's establishment, and thereafter as many additional re-inspections as may be deemed necessary, to verify that the applicant is again complying with the requirements. When the findings justify, he may reinstate the permit and re-grade the milk supply or dairy product upward.

AUTHORITY NOTE: Promulgated in accordance with the provisions of R.S. 40:4(A)(1)(a). Also see R.S. 40:5(2)(3)(5)(7)(15)(17) and R.S. 40:922.

HISTORICAL NOTE: Promulgated by the Department of Health and Hospitals, Office of Public Health, LR 37:2657 (September 2011).

§347. Reinstatement of Permit when Suspension was Based upon Adulteration of Product or Contamination of Pasteurized Product or Cheeses with Pathogenic Microorganisms of Human Significance

A. Upon receipt of a satisfactory application and a statement, signed by the applicant, certifying that the cause of the adulteration has been corrected and all product that was involved has been recalled, from an operator whose permit was suspended based upon adulteration of product, the state health officer shall take additional samples of the applicant's milk supply or dairy product. The state health officer may reinstate the permit when a sample result indicates the supply or product is in compliance, provided that it is the last sample collected. Provided further that in cases in which the suspension of permit was due to a dairy farm's drug residue violations of *Appendix N* of the *PMO* the state health officer shall make an inspection of the applicant's dairy farm and as many additional inspections as deemed necessary by the state health officer to assure that the applicant is again in substantial compliance with all applicable requirements. Said application shall be accompanied by a statement, signed by the applicant, to the effect that the cause of the violation has been corrected.

B. Upon receipt of a satisfactory application from an operator whose permit was suspended based upon contamination with pathogenic microorganisms of human significance and a written corrective action plan for eliminating and preventing a reoccurrence of the contamination the state health officer shall:

1. Review the corrective action plan and determine whether or not it is satisfactory. The state health officer may reject the plan when, in the state health officer's opinion, it is not satisfactory.

2. Upon concurring with the corrective action plan; inspect the dairy plant to determine whether the corrective action plan has been implemented to the state health officer's satisfaction. In cases in which the plant is not domiciled in Louisiana, the state health officer may accept certification that the plan has been implemented from the dairy regulatory agency of that state or country. In cases in which the state health officer deems that the regulatory agency of a state or country is not technically capable of providing acceptable assurance that the corrective action plan is being properly implemented, the state health officer shall perform such inspections. The dairy plant shall be required to pay all expenses the state health officer incurs in making the inspections. Failure to adhere to the corrective action plan at any time may constitute grounds for suspension of permit.

3. Take additional samples of the applicant's product(s).

4. The state health officer may reinstate the permit when the samples indicate the product no longer contains

pathogenic microorganisms of human significance and the corrective action plan to prevent a recurrence of the problem has been implemented to the state health officer's satisfaction.

AUTHORITY NOTE: Promulgated in accordance with the provisions of R.S. 40:4(A)(1)(a). Also see R.S. 40:5(2)(3)(5)(7)(15)(17) and R.S. 40:922.

HISTORICAL NOTE: Promulgated by the Department of Health and Hospitals, Office of Public Health, LR 37:2657 (September 2011).

Subchapter F. Standards and Specification for Grades of Milk and Milk Products

§349. Grade A Raw Milk for Pasteurization

A. Grade A raw milk for pasteurization is raw milk produced on dairy farms which are in substantial compliance with all of the requirements of this Part for dairy farms and is in conformity with the following bacteriological, chemical and temperature standards:

1. temperature: cooled to 7°C (45°F) or less within two hours after milking, provided that the blend temperature after the first and subsequent milkings does not exceed 10°C (50°F);
2. standard plate count: individual producer milk shall not exceed 100,000 cfu per ml. prior to commingling with other producer milk;
3. standard plate count: commingled raw milk shall not exceed 300,000 cfu per ml. prior to pasteurization;
4. sediment score of less than four;
5. drug residue: no positive results from any drug residue detection test which has been determined to be appropriate by the state health officer;
6. somatic cell count: individual producer milk shall not exceed 750,000 per ml., provided that goat milk shall not exceed 1,500,000 per ml.; and
7. cryoscope reading: not higher than -0.525°Hortvet.

AUTHORITY NOTE: Promulgated in accordance with the provisions of R.S. 40:4(A)(1)(a). Also see R.S. 40:5(2)(3)(5)(7)(15)(17) and R.S. 40:922.

HISTORICAL NOTE: Promulgated by the Department of Health and Hospitals, Office of Public Health, LR 37:2658 (September 2011).

§351. Grade A Raw Milk for Pasteurization (Certified for Interstate Milk Shipment)

A. Grade A raw milk for pasteurization (certified for interstate milk shipment) is raw milk, produced on dairy farms in Louisiana, that meet all requirements of this Part, as well as all the requirements of the National Conference on Interstate Milk Shipments (NCIMS) for Grade A and the requirements for inclusion in the U.S. Food and Drug Administration Interstate Milk Shippers List. In cases of conflicting provisions, the stricter codal requirement, as determined by the state health officer, shall be met.

1. Raw milk produced in Louisiana that is in substantial compliance with the provisions contained in §349.A above may be certified by the state health officer for inclusion in the U.S. Food and Drug Administration Interstate Milk Shippers List.

AUTHORITY NOTE: Promulgated in accordance with the provisions of R.S. 40:4(A)(1)(a). Also see R.S. 40:5(2)(3)(5)(7)(15)(17) and R.S. 40:922.

HISTORICAL NOTE: Promulgated by the Department of Health and Hospitals, Office of Public Health, LR 37:2658 (September 2011).

§353. Manufacturing Grade Raw Milk for Pasteurization/Milk for Manufacturing Purpose/Grade B Raw Milk for Pasteurization

A. Manufacturing grade raw milk for pasteurization/milk for manufacturing purpose/Grade B raw milk for pasteurization is raw milk that may not meet bacteriological, somatic cell, chemical, sediment or temperature requirements for Grade A or is produced on dairy farms which may violate one or more of the requirements of this Part provided, that the violation thereof does not reasonably likely constitute an imminent hazard to the public's health, as determined by the state health officer.

B. Manufacturing grade raw milk for pasteurization shall conform to the following bacteriological, chemical or temperature standards.

1. Individual producer raw milk standard plate count shall not exceed 500,000 cfu per ml., prior to commingling with other producer raw milk.
2. Individual producer raw milk shall have sediment score of less than number four.
3. Commingled raw milk standard plate count shall not exceed 3,000,000 cfu per ml. prior to pasteurization.
4. Drug residue: no positive results from drug residue detection test methods contained in §349.A.5 of this Part.
5. Milk temperature shall not exceed 7°C (45°F) upon delivery to the dairy plant unless it is delivered to the dairy plant in less than two hours after milking, provided cans of manufacturing grade milk shall be cooled to 7°C (45°F) or less within four hours after each can has been filled and shall remain at that temperature or less unless delivered to a receiving station or pasteurization plant within two hours after milking.

C. Manufacturing grade raw milk for pasteurization from degraded Grade A supplies shall be sold for non-Grade A use only and only for a period not to exceed 30 consecutive days and only when authorized by the state health officer.

D. When the state health officer finds a condition or conditions that he determines are reasonably likely to constitute an imminent hazard to the public's health he shall take immediate action to suspend the permit.

AUTHORITY NOTE: Promulgated in accordance with the provisions of R.S. 40:4(A)(1)(a). Also see R.S. 40:5(2)(3)(5)(7)(15)(17) and R.S. 40:922.

HISTORICAL NOTE: Promulgated by the Department of Health and Hospitals, Office of Public Health, LR 37:2658 (September 2011).

§355. Grade A Pasteurized, Ultra-pasteurized and Aseptically Processed Milk and Milk Products, Bulk Shipped Grade A Pasteurized or Ultra-pasteurized Milk and Milk Products and Pasteurized Filled Milk and Filled Milk Products

A. Grade A pasteurized, ultra-pasteurized and aseptically processed milk and milk products are the products resulting from Grade A raw milk for pasteurization that has been pasteurized, ultra-pasteurized or aseptically processed and placed in the final container in a dairy plant that is in substantial compliance with all of the requirements for Grade A dairy plants contained in this Part. Bottling/filling/packaging of the milk or milk products shall be done in the plant in which they were pasteurized or ultra-pasteurized.

B. The milk and milk products shall conform to the standards of identity prescribed by this Part.

C. The milk and milk products, and anomalous milk and milk products and filled milk and filled milk products shall conform with the following requirements:

1. temperature: cooled to 7°C (45°F) or less and maintained thereat;

2. standard plate count: not to exceed 20,000 cfu per ml. or gram (g);

3. coliform count: not to exceed 10 per ml. or g. Provided, that in case of bulk milk transport tank shipments, shall not exceed 100 per ml.;

4. drug residue: no positive results from drug residue detection test methods as performed in accord with Appendix G, Part V, Detection of Drug Residues in Milk of the PMO which have been found to be acceptable for use with pasteurized and heat-treated milk and milk products;

5. phosphatase: less than 350 milliunits/L for fluid products and other milk products by the Fluorophos ALP (Alkaline Phosphatase) system or equivalent;

6. cryoscope reading: not higher than -0.525 EHortvet; and,

7. pathogens: no pathogenic microorganisms of human significance.

AUTHORITY NOTE: Promulgated in accordance with the provisions of R.S. 40:4(A)(1)(a). Also see R.S. 40:5(2)(3)(5)(7)(15)(17) and R.S. 40:922.

HISTORICAL NOTE: Promulgated by the Department of Health and Hospitals, Office of Public Health, LR 37:2659 (September 2011).

§357. Grade A Bulk Shipped, Heat-Treated Milk and Milk Products

A. Grade A bulk shipped, heat-treated milk and milk products are the products resulting from Grade A raw milk for pasteurization that have been heat-treated in a dairy plant

that is in substantial compliance with all of the requirements for Grade A dairy plants contained in this Code and is bulk shipped in bulk milk transport tanks or totes to other food product plants. The raw milk shall have been heated, one time, to temperatures greater than 52°C (125°F) but less than 72°C (161°F) for separation purposes when the resulting shipment(s) of cream, nonfat, reduced fat, low-fat milk are labeled heat-treated. In the case of heat-treated cream, the cream may be heated to less than 75°C (166°F) in a continuing heating process and immediately cooled to 7°C (45°F) or less when enzyme deactivation (such as lipase reduction) for functional purposes is required.

B. The resulting products shall conform with the standards of identity prescribed in this Part.

C. Heat-treated milk and milk products shall conform to the following temperature, bacteriological and chemical standards:

1. temperature: cooled to 7°C (45°F) or less and maintained thereat;

2. standard plate count: not to exceed 20,000 cfu per ml. or g.;

3. drug residue: no positive results from drug residue detection test methods which have been determined to be appropriate by the state health officer; and,

4. cryoscope reading: not higher than -0.525° Hortvet.

AUTHORITY NOTE: Promulgated in accordance with the provisions of R.S. 40:4(A)(1)(a). Also see R.S. 40:5(2)(3)(5)(7)(15)(17) and R.S. 40:922.

HISTORICAL NOTE: Promulgated by the Department of Health and Hospitals, Office of Public Health, LR 37:2659 (September 2011).

§359. Grade A Aseptically Processed Milk and Milk Products/Ultra High Temperature (UHT)

A. Grade A aseptically processed milk and milk products are the products resulting from Grade A raw milk for pasteurization that has been commercially sterilized, cooled, then placed into pre-sterilized containers, followed by aseptic hermetical sealing with a pre-sterilized closure in an atmosphere free of microorganisms. Grade A aseptically processed milk and milk products shall conform with the requirements of *Title 21, Code of Federal Regulations (CFR), Part 113*, the requirements of the PMO and the requirements of this Part. In addition they shall conform with the following standards:

1. standards of identity prescribed in this Part;

2. drug residue: no positive results from drug residue detection test methods which have been determined to be appropriate by the state health officer;

3. phosphatase: less than 350 milliunits/L for fluid products and other milk products by the Fluorophos ALP system or Charm ALP or equivalent;

4. cryoscope reading: not higher than -0.525EHortvet; and

5. pathogens: no pathogenic microorganisms of human concern.

AUTHORITY NOTE: Promulgated in accordance with the provisions of R.S.

40:4(A)(1)(a). Also see R.S. 40:5(2)(3)(5)(7)(15)(17) and R.S. 40:922.

HISTORICAL NOTE: Promulgated by the Department of Health and Hospitals, Office of Public Health, LR 37:2659 (September 2011).

§361. Grade A Pasteurized, Ultra-pasteurized and Aseptically Processed Milk and Milk Products Certified for Interstate Shipment

A. Grade A pasteurized, ultra-pasteurized and aseptically processed milk and milk products (certified for interstate milk shipment) are pasteurized milk and milk products, obtained from sources included in the NCIMS List of certified sources processed in Louisiana dairy plants, that meet all requirements of this Part as well as all the requirements of the National Conference on Interstate Milk Shipments (NCIMS) for Grade A and the requirements for inclusion in the *U.S. Food and Drug Administration Interstate Milk Shippers List*. In cases of conflicting provisions, the stricter codal requirement as determined by the state health officer shall be met.

B. Pasteurized milk and milk products processed in Louisiana that are in substantial compliance with the provisions contained §359.A above may be certified by the state health officer for inclusion in the *U.S. Food and Drug Administration Interstate Milk Shippers List*.

AUTHORITY NOTE: Promulgated in accordance with the provisions of R.S. 40:4(A)(1)(a). Also see R.S. 40:5(2)(3)(5)(7)(15)(17) and R.S. 40:922.

HISTORICAL NOTE: Promulgated by the Department of Health and Hospitals, Office of Public Health, LR 37:2659 (September 2011).

§363. Grade B Pasteurized Milk and Milk Products

A. Grade B pasteurized milk or milk products are products resulting from Grade A raw milk for pasteurization and may not meet the requirements for Grade A pasteurized milk and milk products or have been pasteurized or ultra-pasteurized and placed in the final container in a dairy plant that may violate one or more of the requirements contained in this Part for Grade A dairy plants provided, further that any violation thereof does not constitute an imminent hazard to the public's health as determined by the state health officer.

B. The milk or milk products shall conform to the standards of identity prescribed by this Part.

C. The milk or milk products shall conform with the following bacteriological, chemical and temperature standards:

1. standard plate count not to exceed 50,000 cfu per ml.;
2. coliform count not to exceed 10 per ml.;

3. phosphatase less than 350 milliunits/L., for fluid products and other milk products by the Fluorophos ALP system or equivalent;

4. cryoscope reading not higher than -0.525° Hortvet;

5. no positive results from drug residue detection test method as performed in accord with Appendix G, Part V, Detection of Drug Residues in Milk of the PMO; and

6. no pathogenic microorganisms of human significance.

D. Grade B pasteurized milk or milk products may be sold only from supplies that were Grade A and have been degraded to Grade B for a period not to exceed 30 days and only upon authorization from the state health officer.

AUTHORITY NOTE: Promulgated in accordance with the provisions of R.S. 40:4(A)(1)(a). Also see R.S. 40:5(2)(3)(5)(7)(15)(17) and R.S. 40:922.

HISTORICAL NOTE: Promulgated by the Department of Health and Hospitals, Office of Public Health, LR 37:2660 (September 2011).

Chapter 5. Requirements for Grade A Dairy Farms

§501. Approval of Plans

A. All milking barns or parlors used on dairy farms from which Grade A raw milk is offered for sale and which are hereafter constructed, reconstructed, or altered shall conform with the requirements of this Part and the PMO. All equipment with which milk comes in contact and automated cleaning equipment shall comply with applicable 3-A Sanitary Standards in design, construction, employment and use. Plans for the construction, reconstruction or alteration of dairy farm facilities domiciled within the state shall be approved by the state health officer prior to construction, reconstruction or alteration.

AUTHORITY NOTE: Promulgated in accordance with the provisions of R.S. 40:4(A)(1)(a). Also see R.S. 40:5(2)(3)(5)(7)(15)(17) and R.S. 40:922.

HISTORICAL NOTE: Promulgated by the Department of Health and Hospitals, Office of Public Health, LR 28:1266 (June 2002), amended LR 37:2660 (September 2011).

Subchapter A. Health of Dairy Animals

§503. Health of Dairy Animals

A. Tuberculosis. All milk for pasteurization shall be from herds which are located in a modified accredited tuberculosis-free area, as determined by the Animal Health Program, Veterinary Services, the Animal and Plant Health Inspection Service (APHIS), U.S. Department of Agriculture, or the Louisiana State Livestock Sanitary Board and which have been tested for tuberculosis at least once in every six year period. Note that herds located in an area that fails to maintain such accredited status, or that has an incidence of bovine tuberculosis in excess of 0.2 percent shall have been accredited by said the Animal Health Program, Veterinary Services, the Animal and Plant Health Inspection Service (APHIS), U.S. Department of

Agriculture, or the Louisiana State Livestock Sanitary Board, for tuberculosis-free, accredited herds, in effect at the time of the adoption of this ordinance. A certificate identifying each animal signed by the veterinarian and filed as directed by the state health officer shall be evidence of the above tests. All milk for pasteurization shall be from herds in areas which have a Modified Accredited Advanced Tuberculosis status, any herd shall have established a tuberculosis testing protocol for livestock that assures tuberculosis protection and surveillance of the dairy industry within the areas and that it is approved by the Food and Drug Administration, the U. S. Department of Agriculture and the state health officer.

B. Brucellosis. All milk for pasteurization shall be from herds under a brucellosis eradication program which meets one of the following conditions:

1. is located in a certified brucellosis-free area as defined by the U. S. Department of Agriculture and enrolled in the testing program for such areas;

2. meets the U.S. Department of Agriculture requirements for an individually certified herd;

3. participates in a milk ring testing program at least two times per year at approximately 180-day intervals and all herds with positive milk ring results shall have the entire herd blood tested within 30 days from the date of the laboratory ring test; or

4. has an individual blood agglutination test performed annually with an allowable maximum grace period not exceeding two months.

C. Goat milk, sheep milk, water buffalo or other hooved mammal milk for pasteurization, ultra-pasteurization or aseptic processing shall be from a herd or flock which:

1. has passed an annual whole herd or flock brucellosis test as recommended by the state veterinarian or USDA Area Veterinarian in Charge (AVIC) followed by testing replacement animals or any animals entering the milking group or sold as dairy animals;

2. has passed an annual random blood-testing program sufficient to provide a statistical confidence level of 99 percent with a probability value (P-value) of 0.05. Any herd or flock with one or more confirmed positive animals shall go to 100 percent testing until the whole herd tests show no positive animals are found. Random sampling size shall be derived from *Table 1 Regulatory Statistics, 5th Edition (June 1975) by Victor C. Beal, Jr., Program Development and Application, Veterinary Services, APHIS: Animal Health Programs*; or

3. has passed a USDA approved bulk milk test at the USDA recommended frequency.

D. Lactating animals which show evidence of the secretion of milk with abnormalities in one or more quarters, based upon bacteriological, chemical or physical examination, shall be milked last or with separate equipment and the milk shall be discarded. Lactating animals producing contaminated milk, that is, lactating animals which have

been treated with, or have consumed chemical, medicinal or radioactive agents, which are capable of being secreted in the milk and which, in the judgment of the state health officer, may be deleterious to human health, shall be milked last or with separate equipment and the milk disposed of as the state health officer may direct. The state health officer may require the use of the strip cup, a mastitis screening test or bacteriological examination of the milk or any other tests he may determine to be necessary to protect the public's health.

E. For other diseases and residues of toxic substances, such tests and examinations as the state health officer may require, shall be made at intervals and by methods prescribed by him, and any diseased animal or reactors shall be disposed of as he may require.

F. Records supporting the tests required in this section shall be available to the state health officer and be validated with the signature of a licensed and accredited veterinarian or an accredited veterinarian in the employ of an official agency.

AUTHORITY NOTE: Promulgated in accordance with the provisions of R.S. 40:4(A)(1)(a). Also see R.S. 40:5(2)(3)(5)(7)(15)(17) and R.S. 40:922.

HISTORICAL NOTE: Promulgated by the Department of Health and Hospitals, Office of Public Health, LR 37:2660 (September 2011).

Subchapter B. Construction and Maintenance of Grade A Dairy Farm Facilities

§505. Surroundings of Dairy Barns

A. The immediate surroundings of the dairy barn shall be kept in a neat and clean condition.

AUTHORITY NOTE: Promulgated in accordance with the provisions of R.S. 40:4(A)(1)(a). Also see R.S. 40:5(2)(3)(5)(7)(15)(17) and R.S. 40:922.

HISTORICAL NOTE: Promulgated by the Department of Health and Hospitals, Office of Public Health, LR 37:2661 (September 2011).

§507. Cow Yard

A. All cow yards shall be effectively graded and drained and have no standing pools of water or accumulations of organic waste. A slab of concrete or other impervious material shall be provided, sufficient in size to hold the milking herd. Swine and poultry shall not be allowed in the cow yard.

AUTHORITY NOTE: Promulgated in accordance with the provisions of R.S. 40:4(A)(1)(a). Also see R.S. 40:5(2)(3)(5)(7)(15)(17) and R.S. 40:922.

HISTORICAL NOTE: Promulgated by the Department of Health and Hospitals, Office of Public Health, LR 37:2661 (September 2011).

§509. Manure, Sewage and Liquid Waste Disposal

A. All manure shall be removed and stored or disposed of in accordance with Part XXVII in such a manner as best to prevent the breeding of flies therein or the access of cows

to piles thereof. Note that in loafing free stall or pen type stables manure droppings shall be removed or clean bedding added at sufficiently frequent intervals to prevent the accumulation of manure on cows' udders and flanks and the breeding of flies.

B. Sewage shall be disposed of in a manner approved by the state health officer.

C. Liquid wastes resulting from the cleaning of cows, cleaning and rinsing of the barn and equipment, shall be properly disposed of so as not to contaminate the milk or milk equipment or milking barn or parlor, or to create a nuisance or a public health hazard.

AUTHORITY NOTE: Promulgated in accordance with the provisions of R.S. 40:4(A)(1)(a). Also see R.S. 40:5(2)(3)(5)(7)(15)(17) and R.S. 40:922.

HISTORICAL NOTE: Promulgated by the Department of Health and Hospitals, Office of Public Health, LR 37:2661 (September 2011).

§511. Dairy Barn Required

A. A dairy barn or milking parlor shall be required. The barn or parlor shall be constructed in a manner approved by the state health officer.

AUTHORITY NOTE: Promulgated in accordance with the provisions of R.S. 40:4(A)(1)(a). Also see R.S. 40:5(2)(3)(5)(7)(15)(17) and R.S. 40:922.

HISTORICAL NOTE: Promulgated by the Department of Health and Hospitals, Office of Public Health, LR 37:2661 (September 2011).

§513. Milking Barn or Parlor Cleanliness

A. The interior shall be kept clean. Floors, walls, windows, pipelines, and equipment shall be free of filth or litter, and shall be clean. Swine and fowl shall be kept out of the milking barn. All pens, calf stalls, etc., shall be located and maintained so as not to have a deleterious effect upon the conditions in the milking area(s) and the milk house/room.

AUTHORITY NOTE: Promulgated in accordance with the provisions of R.S. 40:4(A)(1)(a). Also see R.S. 40:5(2)(3)(5)(7)(15)(17) and R.S. 40:922.

HISTORICAL NOTE: Promulgated by the Department of Health and Hospitals, Office of Public Health, LR 37:2661 (September 2011).

§515. Lighting

A. The areas of the milking barn where cows are milked shall be provided with a minimum of 10-foot candles of well distributed light.

AUTHORITY NOTE: Promulgated in accordance with the provisions of R.S. 40:4(A)(1)(a). Also see R.S. 40:5(2)(3)(5)(7)(15)(17) and R.S. 40:922.

HISTORICAL NOTE: Promulgated by the Department of Health and Hospitals, Office of Public Health, LR 37:2661 (September 2011).

§517. Ventilation

A. Sections of all dairy barns where cows are kept or milked shall be well ventilated to minimize odor and to prevent condensation upon walls and ceilings.

AUTHORITY NOTE: Promulgated in accordance with the provisions of R.S.

40:4(A)(1)(a). Also see R.S. 40:5(2)(3)(5)(7)(15)(17) and R.S. 40:922.

HISTORICAL NOTE: Promulgated by the Department of Health and Hospitals, Office of Public Health, LR 37:2662 (September 2011).

§519. Floors

A. The floors and gutters of such parts of all dairy barns in which cows are milked shall be constructed of concrete or other impervious and easily cleaned material which has been approved by the state health officer. It shall be graded to drain and shall be in good repair.

AUTHORITY NOTE: Promulgated in accordance with the provisions of R.S. 40:4(A)(1)(a). Also see R.S. 40:5(2)(3)(5)(7)(15)(17) and R.S. 40:922.

HISTORICAL NOTE: Promulgated by the Department of Health and Hospitals, Office of Public Health, LR 37:2662 (September 2011).

§521. Walls and Ceilings

A. The walls and ceilings of all dairy barns shall be smooth, painted or finished in a manner approved by the state health officer and shall be kept clean and in good repair. In case there is a second story above that part of the barn in which cows are milked, the ceiling shall be dust-tight. If the feed room adjoins the milking space it shall be separated therefrom by a dust-tight partition and door. Feed may be stored in the milking portion of the barn only in such a manner as will not increase the dust content of the air, attract flies, or interfere with cleaning of the floor (as in covered, dust-tight boxes, or bins). Open feed dollies may be used for distributing the feed, but not for storing feed in the milking barn. Feed troughs shall be constructed of concrete or other approved impervious and easily cleanable material. A minimum of eight feet ceiling height shall be required in all dairies. When elevated stanchions are used, this height shall be measured from the floor of the elevated portion of the barn.

AUTHORITY NOTE: Promulgated in accordance with the provisions of R.S. 40:4(A)(1)(a). Also see R.S. 40:5(2)(3)(5)(7)(15)(17) and R.S. 40:922.

HISTORICAL NOTE: Promulgated by the Department of Health and Hospitals, Office of Public Health, LR 37:2662 (September 2011).

§523. Milk House or Room

A. There shall be provided a milk house or milk room of sufficient size for the cooling, handling, storing of milk and the washing, sanitizing and storing of milk containers and utensils. The milk house or milk room shall conform to the following requirements.

1. It shall be provided with a tight floor constructed of concrete or other impervious easily cleanable material, in good repair, graded to drain through trapped floor drains.

2. It shall have walls and ceilings of such construction as to permit easy cleaning and shall be painted or finished in a manner approved by the state health officer.

3. The milk house shall be provided with a minimum of 20-foot candles of well distributed light.

4. It shall be provided with windows and solid doors. All outside openings shall be effectively protected against entry of insects, dust and airborne contamination. All outside doors shall be self-closing and open outward.

5. It shall be used for no other purpose than those specified above, except as may be approved by the state health officer.

6. It shall not open directly into a stable or into any room used for domestic purposes.

7. The water supply for the milk room and milking operations shall be from a supply easily accessible, constructed and operated according to Part XII of this Code.

8. It shall have water piped into it and protected against normal freezing conditions.

9. It shall be provided with hot and cold running water under pressure. Water volume and temperature shall be adequate for the cleaning of utensils and operation of automated cleaning systems.

10. It shall be equipped with two-compartment stationary wash and rinse vats, large enough to submerge the largest piece of equipment or container.

11. A conveniently located hand washing facility with hot and cold running water under pressure, soap, air dryer or single service towel shall be provided.

12. The floors, walls, ceilings, windows, tables, shelves, cabinets and any equipment located in the milk house shall be clean. Only articles directly related to milk house activities shall be permitted in the milk house. The milk house shall be free of trash, animals and fowl.

13. Incidental articles may be kept in the milk house provided they are kept clean and ample space is available to conduct normal operations in the milk house and they will not contaminate milk.

14. The milk house shall be adequately ventilated to minimize condensation on floors, walls, ceilings and cleaned utensils.

15. Vents and artificial lighting fixtures shall be installed in a manner to preclude the contamination of bulk milk tank interiors or clean utensil storage areas. They shall not be located over bulk milk tank openings.

16. The state health officer may allow the use of a milk tank truck that is constructed, equipped, located and operated in a manner approved by the state health officer for the storage of raw milk.

17. Milk houses or rooms at dairy farms where the raw milk is transferred from the farm bulk milk tank to milk tank trucks for shipment shall be provided with a hose port in the exterior wall through which the hose used to transfer milk from the bulk tank to the milk tank truck shall be placed during the transfer. The port shall be fitted with a tight fitting door that shall be in good repair and kept closed except

when the port is in use. A concrete or equally impervious slab shall be provided under the hose port, sufficiently large to protect the hose from contamination during the transfer of milk. A water hose shall be conveniently located to allow the rinsing of the slab. The area around the slab shall be clean and free of insect harborage or attractants.

18. Milk houses or rooms in which raw milk is shipped in milk cans shall be equipped with mechanical cooling devices, constructed in a manner that meets the 3-A standards or requirements of the PMO, that cool the milk to 7°C (45°F) or less within four hours or less after each can is filled and maintained at that temperature or less until shipped.

AUTHORITY NOTE: Promulgated in accordance with the provisions of R.S. 40:4(A)(1)(a). Also see R.S. 40:5(2)(3)(5)(7)(15)(17) and R.S. 40:922.

HISTORICAL NOTE: Promulgated by the Department of Health and Hospitals, Office of Public Health, LR 37:2662 (September 2011).

§525. Reclaimed Water^{df}

A. Potable water utilized for heat exchangers or compressors on a Grade A dairy farm may be salvaged and used for certain limited applications in the milking operation on the dairy farm if the following criteria are met:

1. The reclaimed water^{df} piping system shall meet the requirements of Parts XII and XIV of this Code.

2. Any re-circulated cold reclaimed water^{df} which is used in exchangers, including systems in which a freezing point depressant is used, shall be from a safe source and protected from contamination. Such reclaimed water^{df} shall be tested at the minimum frequencies specified in this Section and shall otherwise comply with any other requirements of this Section. Freezing point depressants shall be non-toxic.

3. The reclaimed water^{df} shall be stored in a storage vessel properly constructed of such material that will not contaminate the reclaimed water^{df} system and will protect the system from possible contamination.

4. The storage vessel shall be equipped with a drain and access point to allow for cleaning.

5. No cross-connection shall exist between the reclaimed water^{df} supply and any unsafe or questionable water supply or any other source of pollution. No cross connection shall exist between any potable water supply or potable water distribution system and the reclaimed water^{df} system.

6. There are no submerged inlets through which the reclaimed water^{df} system may be contaminated.

7. The reclaimed water^{df} shall be of satisfactory organoleptic quality and shall have no off flavors or odors.

8. The reclaimed water^{df} shall comply with the bacteriological standards of Appendix G, Section I of the PMO.

9. Samples of the reclaimed water_{df} shall be collected and analyzed prior to initial approval and semi-annually thereafter.

10. Approved chemicals, such as chlorine, with a suitable retention period, may be used to suppress the development of bacterial growth and prevent the development of tastes and odors in the reclaimed water_{df}.

11. When chemicals are added to the reclaimed water_{df}, a monitoring program for such added chemicals shall be in effect and such chemicals shall not add substances that will prove deleterious to the use of the reclaimed water_{df} or contribute to product contamination.

12. If the reclaimed water_{df} is to be used for the sanitizing of teats or equipment (back-flush systems), approved sanitizers, such as iodine may be added by an automatic proportioning device located downstream from the storage vessel but prior to its end-use application. An approved backflow prevention device shall be installed immediately upstream of the point of chemical addition.

B. Reclaimed water_{df} from the current milking, obtained directly from the discharge of a raw milk heat exchanger or compressor into the wash vat or utensil sink, may be used in the following applications:

1. the one time pre-rinsing of milking equipment, including milk lines, milking claw assembly, milk receiver, etc., and then discharged to waste; or,

2. for non-potable purposes approved by the state health officer, e.g., use as a non-potable water source when the intended use does not require the use of potable water.

AUTHORITY NOTE: Promulgated in accordance with the provisions of R.S. 40:4(A)(1)(a). Also see R.S. 40:5(2)(3)(5)(7)(15)(17) and R.S. 40:922.

HISTORICAL NOTE: Promulgated by the Department of Health and Hospitals, Office of Public Health, LR 37:2663 (September 2011).

§527. Toilets

A. Every dairy farm shall be provided with one or more sanitary toilets, conveniently located, constructed according to Parts XIII and XIV of this Code, and operated in a sanitary manner. A covered trash container shall be provided in the toilet room. Materials, equipment or utensils used in milk production shall not be stored in the toilet room.

B. Toilet rooms and appurtenances shall be kept clean.

AUTHORITY NOTE: Promulgated in accordance with the provisions of R.S. 40:4(A)(1)(a). Also see R.S. 40:5(2)(3)(5)(7)(15)(17) and R.S. 40:922.

HISTORICAL NOTE: Promulgated by the Department of Health and Hospitals, Office of Public Health, LR 37:2663 (September 2011).

§529. Construction of Containers and Equipment

A. All multi-use containers, utensils and equipment used in the handling, storage or transportation of milk or milk products shall be constructed of smooth, non-absorbent, non-oxidizable and non-toxic material located as to be easily cleaned, shall be free of exposed copper or brass, and shall

be kept in good repair. Joints and seams shall be smooth and easily cleanable. Woven wire cloth shall not be used for straining milk. All milk pails shall be of heavy-gauge material and of small mouth design. The design, construction and manner of employment of all milk equipment shall conform with 3-A Standards and the requirements of the PMO, and be approved by the state health officer in writing prior to installation.

B. Systems are acceptable if they are designed, installed and operated in accordance with the following parameters for reverse flush systems:

1. All product contact surfaces shall conform to the construction criteria of §529.A of this Part.

2. An intervening break to the atmosphere shall be provided between the water and/or chemical solution and the product and/or product contact surfaces at all times.

3. If a pre-rinse cycle is used it shall be with potable water.

4. The system shall provide for:

a. A chemical solution cycle with a chemical solution complying with provisions of Appendix F of the PMO.

b. The chemical solution strength shall be limited to that strength necessary to accomplish its intended effect and shall not leave a significant residual in the milk.

c. A post-rinse cycle with safe water. The use of treated water to prevent psychrophilic microorganisms contamination should be considered.

d. A drain cycle with sufficient time to drain or remove all moisture from the product contact surfaces of the reverse flush system.

5. When air under pressure is used in contact with product or solution contact surfaces, it shall comply with the requirements for air under pressure contained in §929(I) of this Part, provided that an exception to the piping downstream from the terminal filter may be granted when:

a. the piping is used only for filtered air;

b. at least one access point is available to determine cleanliness of the air piping; and

c. the piping is of a smooth, non-absorbent, corrosion-resistant, non-toxic material, including any adhesives used in joints. In some installations, a check valve may be required to prevent water and/or chemical solution from entering these air lines.

AUTHORITY NOTE: Promulgated in accordance with the provisions of R.S. 40:4(A)(1)(a). Also see R.S. 40:5(2)(3)(5)(7)(15)(17) and R.S. 40:922.

HISTORICAL NOTE: Promulgated by the Department of Health and Hospitals, Office of Public Health, LR 37:2663 (September 2011).

§531. Sanitary Piping

A. All piping used to conduct milk or automated cleaning solutions shall comply with applicable 3-A Sanitary Standards. The installation and use thereof shall be approved, in writing, by the state health officer prior to installation. Detailed plans for mechanically cleaned pipeline systems shall be submitted to the state health officer for written approval prior to installation. No alteration or addition shall be made to any milk pipeline system without prior written approval of the state health officer.

AUTHORITY NOTE: Promulgated in accordance with the provisions of R.S. 40:4(A)(1)(a). Also see R.S. 40:5(2)(3)(5)(7)(15)(17) and R.S. 40:922.

HISTORICAL NOTE: Promulgated by the Department of Health and Hospitals, Office of Public Health, LR 37:2664 (September 2011).

Subchapter C. Sanitation**§533. Cleaning of Containers and Equipment**

A. All multi-use containers, equipment, and other utensils used in the handling, storage, transportation of milk shall be properly cleaned between each usage, provided that farm bulk tanks shall be emptied and cleaned at least once each 72 hours.

AUTHORITY NOTE: Promulgated in accordance with the provisions of R.S. 40:4(A)(1)(a). Also see R.S. 40:5(2)(3)(5)(7)(15)(17) and R.S. 40:922.

HISTORICAL NOTE: Promulgated by the Department of Health and Hospitals, Office of Public Health, LR 37:2664 (September 2011).

§535. Sanitizing Treatment of Containers and Equipment

A. All multi-use containers, equipment, and other utensils used in the handling, storage and transportation of milk shall be properly cleaned then sanitized before each usage. When empty and before being returned to a producer by a dairy plant, each container shall be properly cleaned and sanitized.

AUTHORITY NOTE: Promulgated in accordance with the provisions of R.S. 40:4(A)(1)(a). Also see R.S. 40:5(2)(3)(5)(7)(15)(17) and R.S. 40:922.

HISTORICAL NOTE: Promulgated by the Department of Health and Hospitals, Office of Public Health, R 37:2664 (September 2011).

§537. Storage

A. All containers and other utensils used in the handling, storage, or transportation of milk shall, unless stored in sanitizing solutions, be stored so as to drain and dry, and so as not to become contaminated before use.

AUTHORITY NOTE: Promulgated in accordance with the provisions of R.S. 40:4(A)(1)(a). Also see R.S. 40:5(2)(3)(5)(7)(15)(17) and R.S. 40:922.

HISTORICAL NOTE: Promulgated by the Department of Health and Hospitals, Office of Public Health, LR 37:2664 (September 2011).

§539. Handling

A. After sanitizing treatment, the handling of milk containers, utensils or equipment shall be done in such a manner as to preclude the contamination of the milk contact surface.

AUTHORITY NOTE: Promulgated in accordance with the provisions of R.S. 40:4(A)(1)(a). Also see R.S. 40:5(2)(3)(5)(7)(15)(17) and R.S. 40:922.

HISTORICAL NOTE: Promulgated by the Department of Health and Hospitals, Office of Public Health, LR 37:2664 (September 2011).

§541. Milk Stools, Surcingles, and Anti-Kickers

A. Milk stools, surcingles and anti-kickers shall be clean and stored above the floor.

AUTHORITY NOTE: Promulgated in accordance with the provisions of R.S. 40:4(A)(1)(a). Also see R.S. 40:5(2)(3)(5)(7)(15)(17) and R.S. 40:922.

HISTORICAL NOTE: Promulgated by the Department of Health and Hospitals, Office of Public Health, LR 37:2664 (September 2011).

§543. Flanks, Udders and Teats

A. The flanks, bellies, tails and udders shall be clipped as necessary. Udders and teats shall be free from visible dirt or liquids at the time of milking.

B. The udders and teats of all milk cows, goats, sheep, water buffaloes or other hooved mammals shall be cleaned, rinsed with a bactericidal solution and dried prior to milking.

C. The use of a common towel, sponge or similar device for cleaning udders is prohibited.

AUTHORITY NOTE: Promulgated in accordance with the provisions of R.S. 40:4(A)(1)(a). Also see R.S. 40:5(2)(3)(5)(7)(15)(17) and R.S. 40:922.

HISTORICAL NOTE: Promulgated by the Department of Health and Hospitals, Office of Public Health, LR 37:2664 (September 2011).

§545. Handling of Milk with Abnormalities

A. Milk from lactating animals being treated with medicinal agents, which are capable of being secreted in the milk, shall not be offered for sale for such a period as is recommended by the attending veterinarian or as indicated on the package label of the medicinal agent.

B. Milk with abnormalities shall not be offered for sale and shall be so handled to preclude the infection of other lactating animals or the contamination of milk utensils.

C. Lactating animals secreting milk with abnormalities shall be milked last or in separate equipment which effectively prevents the contamination of the milk to be offered for sale.

D. Equipment, utensils and containers used for the milking or handling of milk with abnormalities shall be properly cleaned and sanitized after use and prior to being used for the handling of milk to be offered for sale.

AUTHORITY NOTE: Promulgated in accordance with the provisions of R.S. 40:4(A)(1)(a). Also see R.S. 40:5(2)(3)(5)(7)(15)(17) and R.S. 40:922.

HISTORICAL NOTE: Promulgated by the Department of Health and Hospitals, Office of Public Health, LR 37:2664 (September 2011).

§547. Protection from Contamination

A. No milk shall be strained or poured in the dairy barn.

AUTHORITY NOTE: Promulgated in accordance with the provisions of R.S. 40:4(A)(1)(a). Also see R.S. 40:5(2)(3)(5)(7)(15)(17) and R.S. 40:922.

HISTORICAL NOTE: Promulgated by the Department of Health and Hospitals, Office of Public Health, LR 37:2665 (September 2011).

§549. Cooling

A. Raw milk for pasteurization shall be cooled to 10°C (50°F) or less within four hours of the commencement of the first milking and to 7°C (45°F) or less within two hours after the completion of milking. Provided, that the blend temperature after the first milking and subsequent milkings does not exceed 10°C (50°F). Provided, further, that Grade A raw milk for pasteurization, that is shipped in milk cans, shall be cooled to 7°C (45°F) or less within four hours after each can has been filled.

B. The construction and operation of all raw milk cooling equipment shall comply with 3-A Standards or §2113(H) of this Part as appropriate.

C. All farm bulk milk tanks manufactured after January 1, 2000 shall be equipped with a temperature recording device approved by the state health officer with concurrence of the FDA.

1. The recording device shall be operated continuously and be maintained in a properly functioning manner. Circular charts shall not overlap.

2. The recording device shall be calibrated with a traceable standard thermometer at least once in each six month period in a manner acceptable to the state health officer. The calibration shall be documented on records available for review by the state health officer.

3. Recording thermometer charts shall be maintained on the premises for a period of a minimum of six months and available to the state health officer.

4. The recording thermometer should be installed in an area convenient to the milk storage tank and acceptable to the state health officer.

5. The recording thermometer sensor shall be located to permit the registering of the temperature of the contents when the tank contains no more than 10 percent of its calibrated capacity.

6. The recording thermometers shall comply with the requirements for such thermometers contained in the *PMO*.

7. A recording thermometer or any other device that meets the specifications of the *PMO* and is acceptable to the

state health officer can be used to monitor and record the bulk tank temperature.

8. The recording thermometer charts shall properly identify the producer, date and signature of the person removing the chart.

AUTHORITY NOTE: Promulgated in accordance with the provisions of R.S. 40:4(A)(1)(a). Also see R.S. 40:5(2)(3)(5)(7)(15)(17) and R.S. 40:922.

HISTORICAL NOTE: Promulgated by the Department of Health and Hospitals, Office of Public Health, LR 37:2665 (September 2011).

§551. Cow Feed

A. No cows shall be fed any substance in a state of putrefaction or any swill or unwholesome feed. This regulation shall not be construed to prohibit the use of properly prepared ensilage.

AUTHORITY NOTE: Promulgated in accordance with the provisions of R.S. 40:4(A)(1)(a). Also see R.S. 40:5(2)(3)(5)(7)(15)(17) and R.S. 40:922.

HISTORICAL NOTE: Promulgated by the Department of Health and Hospitals, Office of Public Health, LR 37:2665 (September 2011).

§553. Insect and Rodent Control

A. Effective measures shall be taken to prevent the contamination of milk, containers, equipment, and utensils by insects, rodents, and by chemicals used to control such vermin. Milk houses shall be free of insects and rodents. Surroundings shall be kept neat, clean, and free of conditions which might harbor or be conducive to the breeding of insects and rodents. Feed shall be stored in such a manner that it does not attract birds, rodents or insects.

AUTHORITY NOTE: Promulgated in accordance with the provisions of R.S. 40:4(A)(1)(a). Also see R.S. 40:5(2)(3)(5)(7)(15)(17) and R.S. 40:922.

HISTORICAL NOTE: Promulgated by the Department of Health and Hospitals, Office of Public Health, LR 37:2665 (September 2011).

§555. Personal Cleanliness

A. All persons coming in contact with milk, containers or equipment shall wear clean outer garments and shall keep their hands clean at all times while thus engaged.

B. Milkers' hands shall be clean and dried with a clean towel immediately before milking and following any interruption in the milking operation. A faucet dedicated to the rinsing of milkers hands shall be conveniently located in the milking area. Wet-hand milking is prohibited.

AUTHORITY NOTE: Promulgated in accordance with the provisions of R.S. 40:4(A)(1)(a). Also see R.S. 40:5(2)(3)(5)(7)(15)(17) and R.S. 40:922.

HISTORICAL NOTE: Promulgated by the Department of Health and Hospitals, Office of Public Health, LR 37:2665 (September 2011).

§557. Clarifiers in the Milk House

A. It shall be unlawful for a milk producer to use any clarifiers, equipment or device in the milk house or dairy barn that would remove or alter a portion or all of the

constituents of the milk, provided that this would not prohibit the use of single service filters in the milk house to remove hair or foreign particles that may accidentally gain access to the milk.

AUTHORITY NOTE: Promulgated in accordance with the provisions of R.S. 40:4(A)(1)(a). Also see R.S. 40:5(2)(3)(5)(7)(15)(17) and R.S. 40:922.

HISTORICAL NOTE: Promulgated by the Department of Health and Hospitals, Office of Public Health, LR 37:2665 (September 2011).

§559. Drug and Chemical Control

A. Cleaners and sanitizers shall be stored in properly identified, dedicated end-use containers.

B. Animal drugs, medications and their administration equipment shall be stored in such a manner that milk, milking equipment and cleaning equipment are not subject to contamination.

C. Animal drugs and medications shall be properly labeled and segregated (lactating from non-lactating).

D. Unapproved drugs shall not be used.

AUTHORITY NOTE: Promulgated in accordance with the provisions of R.S. 40:4(A)(1)(a). Also see R.S. 40:5(2)(3)(5)(7)(15)(17) and R.S. 40:922.

HISTORICAL NOTE: Promulgated by the Department of Health and Hospitals, Office of Public Health, LR 37:2665 (September 2011).

Chapter 7. Sampling, Hauling and Transporting of Milk

§701. Milk Tank Trucks

A. The construction of all milk tank trucks shall comply with applicable 3-A Standards and the requirements of the PMO.

B. Permitting. Each tank truck that loads or unloads milk or other dairy products in the State of Louisiana shall bear a current, valid milk tank truck permit issued by the state health officer, provided that milk tank trucks bearing a permit issued by a milk or dairy regulatory agency from another state whose milk tank truck regulations and inspectional procedures have been determined, by the state health officer, to be equivalent to those contained in this Part may be loaded or unloaded for an indefinite period until such milk tank trucks have been inspected and permitted by the state health officer. Milk tank trucks bearing a permit issued by a milk or dairy regulatory agency from another state whose permitting regulations or inspectional procedures for milk tank trucks have been determined, by the state health officer, not to be equivalent to those contained in this Part, may be loaded or unloaded for a period not to exceed five times in a one month period, provided further that each dairy plant maintain a log showing the dates and times each milk tank truck is loaded or unloaded and such log is made available to the state health officer for review. When such milk tank trucks have been loaded or unloaded more than five times in a one month period at a dairy plant in Louisiana, the plant shall

contact the state health officer expeditiously and make necessary arrangements to have such milk tank trucks inspected and permitted. After the plant has done this, they may continue to load or unload such milk tank trucks until they have been inspected by the state health officer. Upon inspecting the milk tank truck, should the state health officer determine that it is not in substantial compliance with this Part and deny the issuance of a permit for the milk tank truck, it shall not load or unload dairy products in the state until all violations have been corrected and verified in a manner approved by the state health officer.

1. Under no circumstances or situations shall milk or other dairy products be loaded onto or unloaded from a tank truck that does not bear a current, valid permit issued by an official milk or dairy regulatory agency without prior authorization from the state health officer.

2. Owners of milk tank trucks that bear a current, valid permit issued by other state official milk or dairy regulatory agencies shall not be required to pay any inspection or permit fees of any kind or type.

3. The state health officer shall perform an inspection of the milk tank truck and its appurtenances prior to the issuance of the permit. This inspection shall be comprehensive and shall include a visual inspection of all of the product contact surfaces of the interior of the tank (interior surfaces of the tank, CIP equipment and any other product contact surfaces). This may be done by the inspector entering the interior of the tank or by using instruments that enable the inspector to visually observe all product contact surfaces in the interior of the tank. All other product surfaces (including pumps, valves, hoses, sampling equipment, etc.) shall be inspected.

4. Milk tank trucks that are found to be in compliance with §701.A above and are in substantial compliance with all other requirements of this Code, but are not equipped with an internal CIP system which complies with 3-A Standards shall be issued a restricted permit. This restricted permit shall authorize them to be unloaded only at plants that have cleaning systems (including manual cleaning and sanitizing programs), approved by the state health officer, capable of properly cleaning and sanitizing the vehicle. Provided, that arrangements may be made to have the milk tank truck properly cleaned and sanitized at a permitted dairy plant or milk tank truck cleaning facility that is capable of properly cleaning and sanitizing such trucks, as determined by the state health officer, within four hours after the milk tank truck is unloaded and prior to next use. Milk tank trucks that haul multiple loads within a 24 hours period, and are not empty for periods exceeding four hours each, during that time period, are excluded from this requirement, provided that they are cleaned and sanitized at a dairy plant or cleaning station that can accommodate such milk tank trucks.

5. Permits shall be valid for a period of one year unless suspended or revoked by the state health officer for cause.

6. A decal indicating the permit number and date of expiration shall be affixed to the milk tank truck trailer, in an area near the rear of the milk tank, where it can easily be seen.

7. Dairy plants that do not have facilities for properly cleaning and sanitizing milk tank trucks shall not unload milk tank truck loads of milk or dairy products. Provided, that the milk tank truck may be unloaded when arrangements are made by the dairy plant for the milk tank truck to be properly cleaned and sanitized at a permitted dairy plant or milk tank truck cleaning facility capable of properly cleaning and sanitizing the milk tank truck within four hours after being unloaded and prior to next use.

8. Milk tank trucks shall transport milk products only, provided that the state health officer may authorize the transporting of other food grade products. Milk tank trucks that have transported egg products shall not be used for transportation of milk products.

9. Milk tank trucks that have transported unpasteurized products shall not be used to transport pasteurized products that will not be re-pasteurized.

C. The following applies to the suspension of permit, removal from service, and/or inspection reports relative to milk tank trucks:

1. When the state health officer determines that a milk tank truck has significant cleaning, construction or repair defects he shall:

a. in cases in which the milk tank truck has been issued a Louisiana permit, suspend the permit immediately until such time as the discrepancies are corrected and verified by an inspection by the state health officer; or

b. in cases in which the milk tank truck has been issued a permit by a state other than Louisiana:

i. Refuse to issue a permit for the milk tank truck.

ii. Notify the operator that the milk tank truck shall not be authorized to

transport milk products in the State of Louisiana until such time as the discrepancies have been corrected and verified by the milk regulatory agency that issued the permit in a manner acceptable to the state health officer.

iii. Include, on the inspection report, a statement indicating that the milk tank truck shall not be authorized to transport milk products in Louisiana until the discrepancies have been corrected and verified by the milk regulatory agency that issued the permit.

iv. Expeditiously contact the milk regulatory agency that issued the permit, give notification of the problem and make necessary arrangements to have that regulatory agency notify the state health officer when the discrepancies have been corrected and verified.

2. Each time a milk tank truck permitted by a state other than Louisiana has been inspected by the state health

officer, he shall send a copy of the inspection report to the state milk regulatory agency that issued the permit.

D. The following cleaning and sanitizing requirements apply to milk tank trucks.

1. Each milk tank truck shall be properly cleaned and sanitized at a dairy plant or milk tank truck cleaning facility possessing a valid permit, issued by the state health officer or the official state agency having regulatory authority over the plant or facility, prior to first use. When time elapsed after cleaning and sanitizing and before first use exceeds 96 hours, the tank shall be re-sanitized. Provided, when the time elapsed between cleaning and sanitizing and before first use exceeds seven days, the milk tank truck shall be properly cleaned and sanitized prior to use.

2. It shall be the responsibility of the dairy plant or milk tank truck cleaning facility that cleans and sanitizes the milk tank truck to properly clean and sanitize the interior of the tank, the outlet valve(s), dome dust cover, dome cover, tank cover gasket and tank cover vent.

3. It shall be the responsibility of the operator of the milk tank truck to properly clean and sanitize milk hose(s), pumps, sampling equipment and pump compartments of bulk milk pickup tank trucks. These appurtenances shall be properly cleaned and sanitized by the milk tank truck operator each time the milk tank truck is cleaned and sanitized, regardless of whether they were used or not used in the loading of the milk tank truck. Removable fittings on the hoses shall be disassembled and properly cleaned at least once each week.

4. It is allowable to pickup multiple loads within a 24-hour period provided that the milk tank is washed and sanitized after each day used, provided further that the time interval between any unloading and loading during that 24-hour period does not exceed four hours.

5. It is allowable for a milk tank truck to be unloaded at one facility and proceed to a permitted facility to be washed and sanitized, provided that the time interval between unloading and washing does not exceed four hours.

6. Milk tank trucks shall be cleaned and sanitized only at facilities possessing a valid permit for such activities issued by the state health officer or by the milk regulatory agency in the state in which the facility is located.

7. The following cleaning and sanitization tag/record requirements are applicable to milk tank trucks:

a. The operator of the milk tank truck shall be responsible for assuring that the milk tank truck has been properly cleaned, sanitized and has a cleaning and sanitization tag placed on the tank truck by the facility that last cleaned and sanitized the tank truck. A milk tank truck that does not have a valid cleaning and sanitization tag shall not be loaded or unloaded until the proper cleaning and sanitization can be verified and approval is received from the state health officer.

b. A cleaning and sanitization tag shall be affixed to the outlet valve or in an area in the vicinity of the outlet

valve of the milk tank truck by the plant or cleaning facility that cleaned and sanitized the truck. The tag shall remain in place and intact until the tank truck is next cleaned and sanitized. When the milk tank truck is cleaned and sanitized, the cleaning and sanitization tag shall be removed and stored at that location for a period of not less than 15 days. In cases in which the tank truck is only sanitized and not cleaned and sanitized, the date, time, facility's name and location, and initials of the person that sanitized the truck shall be annotated on the existing tag. This tag shall remain in place and intact until the tank truck receives a complete cleaning and sanitization.

c. The following information shall be recorded on the cleaning and sanitization tag:

- i. identification of the milk tank truck;
- ii. date, time, facility's name and location where the milk tank truck was cleaned and sanitized;
- iii. signature or initial of person who cleaned and sanitized the milk tank truck;
- iv. the numbers of the numbered seals placed on the tank truck; and
- v. date, time, facility name and location where product was unloaded from the truck.

d. The maintenance of all information on the cleaning and sanitization tag shall be the responsibility of bulk milk hauler/sampler or the milk tank truck operator until the tank truck is cleaned and sanitized.

8. The date, time, facility's name and location of the last cleaning and sanitization of the milk tank truck shall be provided to the State Health Officer during any milk tank truck inspection and such information shall be recorded on the milk tank truck's inspection report.

AUTHORITY NOTE: Promulgated in accordance with the provisions of R.S. 40:4(A)(1)(a). Also see R.S. 40:5(2)(3)(5)(7)(15)(17) and R.S. 40:922.

HISTORICAL NOTE: Promulgated by the Department of Health and Hospitals, Office of Public Health, LR 37:2666 (September 2011).

§703. Sealing and Protection of Milk Tank Trucks

A. Tamper evident, numbered seals shall be placed on all outer openings of the tank (C.I.P. fittings, valves, vents, hatches, dust covers and doors of the valve, pump and sample compartment) by the milk receiver/sampler immediately upon completion of washing and sanitizing of the milk tank truck, provided that the operator of the milk tank truck may lock the doors of the valve, pump and sample compartments with padlocks instead of being sealed.

B. The tank truck shall be constructed in such a manner as to preclude the opening of any sealed portion of the tank truck without breaking the seals (hinges on dust cover, doors, etc.).

C. In cases in which a milk tank truck is unloaded at a dairy plant, is not washed and sanitized and will be used to haul milk or milk products, it shall be sealed and protected

as prescribed in §703.A above and the date, time, location the milk tank truck was unloaded shall be recorded on the cleaning and sanitizing tag by the milk receiver/sampler.

D. The seal numbers shall be annotated on the cleaning and sanitization tag.

E. It shall be the responsibility of the milk tank truck operator to insure that the milk tank truck has been properly cleaned and sanitized.

F. It shall be the responsibility of the milk tank truck operator to insure that the milk tank truck has been properly sealed and compartments are locked or sealed and maintained in such manner at all times that the milk tank truck is not being loaded, unloaded or under immediate control of the operator.

G. The milk tank truck operator shall check the integrity of all seals and locks upon arrival at the first farm or other facility from which milk or milk products are to be loaded.

H. When seals must be broken in order to load the truck, the operator shall store the seals in a secure location on the truck and record the seal numbers and reason for breaking the seals on the cleaning and sanitization tag or on the manifest.

I. If at any time the operator discovers that a seal has been broken or removed without his/her knowledge, he/she shall immediately notify the state health officer and ensure that the milk tank truck is not unloaded without permission from the state health officer.

AUTHORITY NOTE: Promulgated in accordance with the provisions of R.S. 40:4(A)(1)(a). Also see R.S. 40:5(2)(3)(5)(7)(15)(17) and R.S. 40:922.

HISTORICAL NOTE: Promulgated by the Department of Health and Hospitals, Office of Public Health, LR 37:2668 (September 2011).

§705. Manifest for Bulk Milk Tank Trucks

A. Bulk milk tank trucks that pick up milk from dairy farms and haul it to dairy plants shall have a shipping statement (manifest) containing:

1. name and address of tank truck owner;
2. tank truck permit number and state issuing permit;
3. bulk milk tank truck operator/sampler(s) name(s) and permit number(s) and state issuing permit(s); and,
4. the bulk milk tank truck operator/sampler signature.

B. The following information concerning each individual dairy farm having milk represented on the load shall be annotated on the manifest by the bulk milk tank truck operator/sampler:

1. name and permit number of dairy farm;
2. date and time milk was picked up;
3. identity of bulk tank on farms where milk was picked up from two or more farm bulk tanks;
4. temperature of the milk in each bulk tank;

5. milk gauge reading of each bulk tank;
6. pounds of milk collected from each bulk tank;
7. the initials of the bulk milk tank truck operator/sampler who picked up the milk; and,
8. the BTU permit number of the BTU to which the farm belonged.

C. The following information shall be annotated on manifest at point and time of unloading of bulk milk tank truck by the receiver/sampler:

1. the name and permit number of the plant or receiving station at which the tank truck was unloaded;
2. the date and time the tank truck was unloaded (this shall also be recorded on the cleaning and sanitizing tag);
3. the temperature of the load of milk;
4. the numbers of the numbered seals on the milk tank truck;
5. the date and time of the last cleaning and sanitization of the tank truck as annotated on the cleaning and sanitization tag; and,
6. the dairy plant receiver/sampler's permit number and signature.

AUTHORITY NOTE: Promulgated in accordance with the provisions of R.S. 40:4(A)(1)(a). Also see R.S. 40:5(2)(3)(5)(7)(15)(17) and R.S. 40:922.

HISTORICAL NOTE: Promulgated by the Department of Health and Hospitals, Office of Public Health, LR 37:2668 (September 2011).

§707. Bulk Milk Tank Truck Operator/Sampler

A. A bulk milk tank truck operator/sampler is a person who collects official raw milk samples and may transport raw milk from dairy farms to milk plants, receiving stations, transfer stations or other food processing plants.

B. Milk tank truck and milk tank transport operators who are not licensed as bulk milk tank truck operator/samplers shall not perform any of the duties of a bulk milk tank truck operator/sampler that directly involves the collection of official samples or measuring of milk for official records.

C. Milk tank truck operators who are not bulk milk tank truck operator/samplers and perform any of the duties of a bulk milk tank truck operator/sampler that do not involve the collection of samples or measuring of milk shall conform with the requirements for such duties contained in this Part.

D. Bulk milk tank truck operator/samplers shall obtain a permit to operate a bulk milk pickup tank truck and collect official samples of raw milk prior to the performance of these duties.

E. The bulk milk tank truck operator/sampler must be instructed in proper procedures of milk pick up and sample collection prior to permit application.

F. The bulk milk tank truck operator/sampler shall obtain a passing score on a test administered by the state

health officer and demonstrate his ability to perform the required milk pick up and sampling duties to the state health officer prior to being issued a permit.

G. Each bulk milk tank truck operator/sampler shall attend one of the bulk milk pickup tanker operator/sampler seminars conducted biannually by the state health officer and receive a passing score on the test administered as part of the seminar. Failure to attend the required seminar or failure to achieve a passing score on the test shall result in suspension of his/her permit.

H. The examination shall be composed of a minimum of 20 questions broken down into the following areas:

1. six questions relating to sanitation and personal cleanliness;
2. six questions relating to sampling and weighing procedures;
3. four questions relating to equipment (including proper use, care, cleaning, etc); and
4. four questions relating to proper record keeping requirements.

I. Candidates failing the exam (a score of less than 70 percent) shall be denied permits or licenses until such time as they achieve a passing score.

J. The bulk milk hauler/sampler shall insure that he/she has the following equipment at all times while engaged in picking up and hauling milk:

1. sample rack and compartment to hold all samples collected;
2. refrigerant to hold temperature of milk samples between 0° - 4.4°C (32° - 40°F);
3. sample dipper or other sampling devices of sanitary design approved by the state health officer;
4. sterile sample bags, tubes or bottles; stored properly;
5. calibrated pocket thermometer; certified for accuracy every six months; accuracy $\pm 1^{\circ}\text{C}$ (2°F);
6. approved sanitizing agent and sample dipper container;
7. watch for timing milk agitation; and
8. appropriate sanitizer test kit.

K. Specific procedures that shall be performed by each milk tank truck operator/sampler:

1. The bulk milk hauler/sampler shall insure that all outer openings of the milk tank truck are properly sealed with numbered seals at all times the milk tank truck is not being loaded, unloaded or under his/her immediate supervision; padlocks may be used on the valve, pump and sample compartments.

2. The bulk milk hauler/sampler shall check the integrity of all seals and padlocks upon arrival at the first point at which the milk tank truck is to be loaded.

3. If any seal must be broken in order to load the truck, the bulk milk tank truck operator/sampler shall record the number of the seal(s) broken on the cleaning and sanitizing tag or manifest, this record may be referred to as a "broken seal record". The broken seal shall be placed in a secure place in the milk tank truck so that it can be presented to the milk receiver/sampler at the unloading point.

4. If at any time should the bulk milk tank truck operator/sampler find that any numbered seal or padlock securing the outer openings of the milk tank truck has been removed without his/her permission, he/she shall immediately notify the state health officer and then follow instructions given by the state health officer.

L. The specific procedures used by an individual bulk milk tank truck operator must be such that they preclude contamination of the milk and milk contact surfaces. The individual bulk milk tank truck operator shall insure the accuracy of all measurements taken, that samples collected are representative of the product sampled and that records and reports are accurate and complete.

M. The following are examples of acceptable procedures used in the measurement, sampling and pick up of milk from farm bulk tanks by the bulk milk tank truck operator/sampler:

1. he/she shall practice good hygiene, shall maintain a neat and clean appearance and not use tobacco in the milk house;

2. wash hands thoroughly and dry with a clean single service towel or acceptable air dryer immediately prior to measuring and sampling the milk;

3. examine the milk by sight and smell for any off odor or any other abnormalities that would classify the milk as not being acceptable. Reject if necessary;

4. measure the milk prior to agitation. If the agitator is running upon arrival at the milk house, the measurement shall be taken only after the surface of the milk has become quiescent;

5. carefully insert the measuring rod, after it has been wiped dry with a single service towel, into the tank. Repeat this procedure until two identical measurements are taken. Record measurements on the farm weight ticket;

6. do not contaminate the milk during measurement;

7. agitate the milk a sufficient time to obtain a homogeneous blend. Tanks with a capacity of less than 1,500 gallons, five minutes, and more than 1,500 gallons, 10 minutes;

8. while the milk is being agitated, insert thermometer into milk and determine temperature of the milk. Rinse thermometer and place it into holder. Record temperature;

9. while the tank is being agitated, bring the sample container, dipper, dipper container or single service sampling tubes and sanitizing agent for the outlet valve into the milk house. Remove the cap from the tank outlet valve and examine for milk deposits or foreign matter and then sanitize

if necessary. Protect the hose cap from contamination when removing it from the transfer hose and during storage;

10. collect samples only after the milk has been properly agitated. Remove the dipper or sampling device from the sanitizing solution or sterile container and rinse at least twice in the milk;

11. collect a representative sample or samples from the bulk tank. When transferring milk from the sampling equipment, caution should be used to assure that no milk is spilled into the tank. Do not fill the sampling container more than $\frac{3}{4}$ full. Close the cover on the sample container;

12. rinse the dipper and place in its carrying container;

13. close the cover or lid of the bulk tank;

14. identify samples at the point of collection with the producer's number annotated on the sample container;

15. take a temperature control sample at the first stop of each load. This sample must be labeled with time, date, temperature, producer and bulk milk tank truck operator/sampler identification;

16. place the sample or samples immediately into the sample storage case;

17. record milk temperature, time, date of pick up and bulk milk tank truck operator/sampler identification on the farm weight ticket. He/she shall check the accuracy of the thermometer on each bulk tank monthly and record results on document that remains in the farm. Pocket thermometer must be sanitized before use;

18. once the measurement and sampling procedures are completed, with the agitator still running, open the outlet valve and start the pump. Turn off the agitator when the level of milk is below the level that will cause over agitation;

19. when the milk has been removed from the tank, disconnect the transfer hose from the outlet valve and cap the hose;

20. observe the inside surfaces of the bulk tank for foreign matter or extraneous material and record any objectionable observations on the farm weight ticket;

21. with the outlet valve open, thoroughly rinse the entire inside surface of the tank with warm water;

22. samples shall be cooled to and held between 0°C (32°F) and 4.4°C (40°F) during transit to the laboratory;

23. means shall be provided to properly protect the samples in the sample case. Keep refrigerant at an acceptable level;

24. racks must be provided so that the samples are properly cooled in an ice bath and are not submerged in the coolant; and,

25. adequate insulation of the sample container box or ice chest shall be provided to maintain the proper temperature of the samples.

N. At least one sample of raw milk collected by the bulk milk tank operator/sampler from each farm bulk milk tank represented on each load shall accompany the load to the dairy plant at which it will be unloaded.

O. The bulk milk tank truck operator/sampler shall follow the practices and procedures described in *Appendix B, Milk Sampling, Hauling and Transportation of the PMO* as well as those contained in this Part.

P. An on-site evaluation of the bulk milk tank truck operator/sampler's techniques should be made by the state health officer at least once each 24 months.

AUTHORITY NOTE: Promulgated in accordance with the provisions of R.S. 40:4(A)(1)(a). Also see R.S. 40:5(2)(3)(5)(7)(15)(17) and R.S. 40:922.

HISTORICAL NOTE: Promulgated by the Department of Health and Hospitals, Office of Public Health, LR 37:2668 (September 2011).

Chapter 9. General Requirements for Dairy Plants

§901. General Requirements

A. The requirements contained within this chapter pertain to Grade A dairy plants and dairy plants in general. Some types of dairy plants are not required to conform with each of these requirements. Those requirements to which specific types of dairy plants shall be required to conform shall be listed in the chapter of this Part that pertains to that specific type of plant.

B. The state health officer has the authority to require an individual dairy plant to implement any additional requirements he/she determines necessary to prevent a compromise to food safety in that individual dairy plant. Failure to comply with such requirements may constitute grounds for suspension or denial of permit.

C. Dairy plants that produce Grade A pasteurized, ultra-pasteurized or aseptically processed milk and milk products shall conform with each of the requirements contained in this Chapter, provided that dairy plants that produce Grade A pasteurized, ultra-pasteurized or aseptically processed milk and milk products which have been required or authorized by the state health officer to be regulated under the provisions of Chapter 11 of this Part [Hazard Analysis Critical Control (HACCP) systems] shall conform with the requirements contained in Chapter 11 of this Part.

AUTHORITY NOTE: Promulgated in accordance with the provisions of R.S. 40:4(A)(1)(a). Also see R.S. 40:5(2)(3)(5)(7)(15)(17) and R.S. 40:922.

HISTORICAL NOTE: Promulgated by the Department of Health and Hospitals, Office of Public Health, LR 37:2671 (September 2011).

§903. Approval of Plans

A. All milk, milk products plants and other dairy plants domiciled in the State from which dairy products are processed, packaged or offered for sale in the state and which are hereafter constructed, reconstructed, or renovated shall conform with the requirements of this Part. Prior to

construction, reconstruction or alterations, written approval of plans and specifications shall be obtained from the state health officer.

B. Prior to installation or modification, written approval shall be obtained from the state health officer of plans and specifications for the design, construction and manner of employment for all equipment used in dairy plants.

C. Written, detailed plans describing the processing of each product shall be submitted to the state health officer for approval prior to manufacture of product and prior to any process or product changes.

AUTHORITY NOTE: Promulgated in accordance with the provisions of R.S. 40:4(A)(1)(a). Also see R.S. 40:5(2)(3)(5)(7)(15)(17) and R.S. 40:922.

HISTORICAL NOTE: Promulgated by the Department of Health and Hospitals, Office of Public Health, LR 37:2671 (September 2011).

Subchapter A. Milk, Milk Products and Non Milk Derived Ingredients Receiving

§905. Raw Milk Receiving

A. All milk and other dairy products received by each dairy plant, including receiving stations and transfer stations, shall be from sources which possess a current valid permit issued by the state health officer.

B. Milk or dairy products shall not be loaded onto or unloaded from tank trucks that do not bear a current, valid permit issued by an official milk or dairy regulatory agency.

C. For any milk tank truck that bears a permit of an official state milk or dairy regulatory agency from another state whose milk tank truck regulations have been determined by the state health officer not to be equivalent to those contained in this Part, each dairy facility shall maintain a log showing the dates and times that each and every such truck has been loaded or unloaded. Such logs shall be made available for review by the state health officer. When such milk tank trucks have been loaded or unloaded by a dairy facility more than five times in a one month period, the dairy facility shall expeditiously notify the state health officer and make necessary arrangements for the state health officer to inspect and permit such milk tank trucks. The facility may continue to load and unload such milk tank trucks until the state health officer has inspected and permitted them.

D. Each dairy facility (including dairy plants, receiving stations, transfer stations and milk tank truck cleaning facilities) that cleans and sanitizes milk tank trucks or other confined spaces which hold dairy products, such as tanks, shall be equipped with approved, functional equipment, devices, etc., and provide all services and programs necessary to satisfy the confined space entry safety requirements of the Occupational Safety and Health Administration (OSHA) thereby permitting personnel to safely enter the interior of the milk tank trucks and other confined spaces. The dairy facility shall allow the state health officer to use all such equipment, devices, services

and programs, etc., and shall provide the state health officer with any assistance necessary to enable the state health officer (or his authorized representative) to safely enter and inspect the interior of the milk tank trucks or other confined spaces. Dairy facilities, as identified above, which fail to provide the state health officer with any assistance necessary and required under OSHA regulations to safely enter and inspect the interior of milk tank trucks or other confined spaces may be held liable should the safety of the state health officer (or his authorized representative) be in peril while inside of milk tank trucks or any other confined space.

E. When the area in which milk tank trucks are unloaded is not totally enclosed or doors of the unloading area are open during unloading, a filter approved by the state health officer, shall be placed on the manhole or air inlet of the milk tank truck and a roof or ceiling must be provided over the area.

F. All milk or other dairy products received by each dairy plant, including receiving stations, shall be received by a dairy receiver/sampler possessing a current, valid dairy plant receiver/sampler permit issued by the state health officer.

G. Each dairy plant, including receiving stations receiving raw milk, shall be equipped with a drug residue screening laboratory approved by the state health officer.

H. The construction of the laboratory, the laboratory equipment, sampling procedures and laboratory examinations shall be in compliance with the *PMO*, the *Official Methods of Analysis* and the *Standards Methods for the Examination of Dairy Products* and shall be approved by the state health officer.

I. All drug residue analyses shall be performed by approved analysts certified by the state health officer.

J. Each dairy plant and receiving station shall maintain all records of testing required by the state health officer.

K. A sample of raw milk shall be collected from each milk tank truckload of raw milk by a dairy plant receiver/sampler and tested for drug residues in the milk drug residue screening laboratory of the dairy plant prior to the milk tank truck being unloaded.

L. In cases where a dairy plant receives raw milk in cans, a composite sample composed of raw milk from each can of raw milk shipped from each individual dairy farm, shall be collected and tested for drug residues prior to the milk from that individual dairy farm being commingled with any other milk.

M. In cases where a dairy plant processes raw milk produced by a dairy farm located on the same premises, all raw milk produced by the dairy farm shall be tested for drug residues prior to processing.

N. When any sample referred to in §905(K),(L) or (M) above is found to be positive for drug residues, the dairy plant or receiving station shall:

1. refuse to unload the milk tank truck, not commingle any cans of milk from that farm with any other milk, not commingle any milk found to be positive for drug residues with any other milk and isolate the contaminated milk from any other milk;

2. immediately notify the state health officer;

3. insure that the contaminated milk remains on the premises of the dairy plant or receiving station and ensure that it is isolated from any other milk until the state health officer determines the disposition of the milk and authorizes it to be moved; and,

4. immediately cease processing of any product that has inadvertently become commingled with milk contaminated with drug residues, isolate the product, notify the state health officer and expeditiously remove all such product that has entered commerce.

AUTHORITY NOTE: Promulgated in accordance with the provisions of R.S. 40:4(A)(1)(a). Also see R.S. 40:5(2)(3)(5)(7)(15)(17) and R.S. 40:922.

HISTORICAL NOTE: Promulgated by the Department of Health and Hospitals, Office of Public Health, LR 37:2671 (September 2011).

§907. Dairy Plant Receivers/Samplers

A. Prior to performing the duties associated with same, dairy plant receivers/samplers shall obtain a permit from the state health officer for receiving tank truck or other type of container loads of milk and milk products as well as to collect and handle official samples of milk and milk products.

B. Prior to applying for a permit, the person desiring to become permitted as a dairy plant receiver/sampler shall be instructed in the proper procedures for loading and receiving loads of milk and milk products and for collecting/handling official samples of milk and milk products. These procedures shall be properly performed by each dairy plant receiver/sampler. The instructions of dairy plant receivers/samplers shall minimally include the following:

1. obtaining producer samples from the hauler;

2. checking temperature of the pilot sample;

3. immediately placing samples in an approved refrigerator;

4. checking the manifest for accuracy;

5. verifying that the bulk milk tank truck operator/sampler that picked up milk from the farm has a current, valid permit;

6. verifying that the milk tank truck has a current, valid permit issued by an official state milk or dairy products regulatory agency whose milk tank truck regulations are equivalent to those contained in this Part;

7. recording the permit number, the date and the time that milk tank trucks which bear current, valid permits issued by an official state milk or dairy products regulatory agency whose milk tank trucks regulations have been

determined by the state health officer not to be equivalent to those contained in this Part, and notifying facility management when such milk tank trucks have been loaded or unloaded more than five times in any one month period;

8. verifying that the load is from an approved source;
9. checking the cleaning and sanitization tag;
10. recording the date and time the product was unloaded on the cleaning and sanitizing tag;
11. reporting any discrepancies in any of the above to his/her supervisor immediately and does not proceed any further without orders from supervisor;
12. verify the identity of each milk tank truck operator and that he/she is an authorized operator of the vehicle;
13. checking the seals to verify that they are present, intact and agree with the numbers recorded on the cleaning and sanitization tag and that any seals that have been broken are available and agree with the number of the broken seal numbers on the sanitization tag or manifest;
14. immediately notifying the state health officer if seals are missing or if the seal record does not match the intact seals or the operator is unable to produce broken seals for seal numbers recorded on "broken seal record" on the cleaning and sanitization tag. In any such case, the milk tank truck shall not be unloaded without authorization from the state health officer;
15. examining the load of milk or milk products for foreign matter;
16. collecting official samples of milk and milk products from the load;
17. checking and recording the temperature of the load;
18. testing or having a sample from each load of raw milk tested for drug residue;
19. placing dome filter over the dome;
20. unloading the tanker in the manner prescribed by the dairy plant;
21. cleaning and sanitizing the interior of the tank using the procedures prescribed by the plant. When an automated cleaning system is used, the milk tank truck permit number shall be recorded in the appropriate place on the CIP recording chart;
22. cleaning and sanitizing the dome cover, dust cover, gasket, vent and outlet valve(s);
23. inspecting the pump compartment, sample compartment, pump, hoses, sample chest, sample canister, sampling dipper and all other milk and handling appurtenances;
24. placing numbered seals on the dome dust cover, C.I.P. fittings and all other openings of the tank or ensuring that padlocks have been locked as provided in §703.A;
25. recording the cleaning and sanitizing date and time and seal numbers, on the cleaning and sanitization tag;

26. upon verifying that the requirement in §907.B.21.-25. above has been properly satisfied, affixing a cleaning and sanitization tag to the outlet valves; and,

27. cleaning, sanitizing and storing receiving equipment properly.

C. The dairy plant receiver/sampler shall obtain a passing score on a test administered by the state health officer prior to being issued a permit.

D. Bi-annually, each dairy plant receiver/sampler shall attend one of the bulk milk pickup tanker operator/sampler and dairy plant receiver/sampler seminars conducted by the state health officer and receive a passing score on the test administered as part of the seminar. Failure to attend the required seminar or failure to achieve a passing score on the test shall result in suspension of his/her permit.

E. The state health officer shall evaluate the performance of each dairy plant receiver/sampler at least once each three-month period.

AUTHORITY NOTE: Promulgated in accordance with the provisions of R.S. 40:4(A)(1)(a). Also see R.S. 40:5(2)(3)(5)(7)(15)(17) and R.S. 40:922.

HISTORICAL NOTE: Promulgated by the Department of Health and Hospitals, Office of Public Health, LR 37:2672 (September 2011).

§909. Receiving and Handling of Milk Derived and Non-Dairy Ingredients

A. Non-milk derived ingredients used in the manufacturing of dairy products shall have been determined by the FDA to be GRAS for use in dairy products.

B. All dairy ingredients used in the manufacture of dairy products shall be produced, packed, held and shipped in a manner consistent with the requirements of this Part.

C. All non-milk derived ingredients shall be purchased only from suppliers which certify or guarantee that their products have been produced and handled in a manner that will assure a safe and wholesome ingredient which will not adulterate the finished product. Records of such verification or guarantee shall be available for review by the state health officer.

D. A safety and quality inspection of all incoming milk derived and non-milk derived ingredients shall be performed. Records of the results of this inspection, corrective action taken when problems are identified and the date and initials of the person performing the inspection shall be maintained and made available to the state health officer. The inspection shall include an evaluation for conditions related to:

1. product identity and labeling;
2. package condition and integrity;
3. bulging;
4. leaking;
5. dirt/grime;

- 6. insect infestation;
- 7. rodent damage; and,
- 8. off-odors and non-food materials (especially toxic compounds) or residues of such materials in the truck or other conveyance.

E. All ingredients used in the manufacture of dairy products shall be stored and handled in such a manner as to preclude their contamination. Particular attention shall be given to closing or resealing of containers that have been opened and the contents of which have been partially used.

F. Dusty raw ingredient blending or liquification operations which create powdery conditions shall not be conducted in areas where pasteurized products are handled or stored.

G. Dairy products operations in which ingredients are exposed shall be conducted in processing areas. Except when ingredients are being added, all openings into vessels and lines containing product shall be covered. The outer box or wrapper of powdered ingredients shall be removed prior to dumping into mixing vessels.

H. All liquid ingredients which will support bacterial growth shall be kept or immediately cooled to 7EC (45EF) or below.

AUTHORITY NOTE: Promulgated in accordance with the provisions of R.S. 40:4(A)(1)(a). Also see R.S. 40:5(2)(3)(5)(7)(15)(17) and R.S. 40:922.

HISTORICAL NOTE: Promulgated by the Department of Health and Hospitals, Office of Public Health, LR 37:2673 (September 2011).

Subchapter B. Dairy Plant Construction, Sanitation and Operation

§911. Immediate Surroundings

A. The immediate surroundings of the dairy plant shall be well drained and kept neat, clean, and free from conditions which might attract flies, insects or rodents or otherwise constitute a nuisance.

AUTHORITY NOTE: Promulgated in accordance with the provisions of R.S. 40:4(A)(1)(a). Also see R.S. 40:5(2)(3)(5)(7)(15)(17) and R.S. 40:922.

HISTORICAL NOTE: Promulgated by the Department of Health and Hospitals, Office of Public Health, LR 37:2673 (September 2011).

§913. Floors

A. The floors of all rooms in which milk or dairy products are received, handled or stored or in which utensils are cleaned shall be constructed of concrete or other equally impervious and easily cleanable material and shall be smooth, properly drained, provided with trapped drains, kept clean and in good repair.

AUTHORITY NOTE: Promulgated in accordance with the provisions of R.S. 40:4(A)(1)(a). Also see R.S. 40:5(2)(3)(5)(7)(15)(17) and R.S. 40:922.

HISTORICAL NOTE: Promulgated by the Department of Health and Hospitals, Office of Public Health, LR 37:2673 (September 2011).

§915. Walls and Ceilings

A. Walls and ceilings of rooms in which milk and dairy products are handled or stored or in which utensils are cleaned shall be constructed of concrete or other equally impervious and easily cleanable material and kept clean and in good repair.

AUTHORITY NOTE: Promulgated in accordance with the provisions of R.S. 40:4(A)(1)(a). Also see R.S. 40:5(2)(3)(5)(7)(15)(17) and R.S. 40:922.

HISTORICAL NOTE: Promulgated by the Department of Health and Hospitals, Office of Public Health, LR 37:2673 (September 2011).

§917. Doors and Windows

A. The dairy plant shall be provided with solid doors which shall be kept closed during the presence of dusty conditions, smoke or fumes. All outside openings shall be effectively protected against the entry of insects, rodents, dust and airborne contamination. Screen doors shall be self-closing and open outward.

AUTHORITY NOTE: Promulgated in accordance with the provisions of R.S. 40:4(A)(1)(a). Also see R.S. 40:5(2)(3)(5)(7)(15)(17) and R.S. 40:922.

HISTORICAL NOTE: Promulgated by the Department of Health and Hospitals, Office of Public Health, LR 37:2674 (September 2011).

§919. Light and Ventilation

A. All rooms in which milk or dairy products are handled or processed and in which milk containers, equipment and utensils are cleaned shall be provided with a minimum of 40-foot candles of evenly distributed light. Dry and cold storage areas shall be provided with a minimum of 15-foot candles of evenly distributed light.

B. Ventilation shall be sufficient in all areas of the plant to prevent excessive odors and the formation of excessive water condensation. Vents or lighting fixtures shall be installed in a manner to preclude the contamination of product, ingredients, packaging material, packaged products or product contact surfaces of equipment.

C. All bulk dairy product storage tanks shall be vented into a room used for processing or packaging or in a storage tank alley. Vents located elsewhere shall be equipped with air filters approved for that use by the state health officer.

AUTHORITY NOTE: Promulgated in accordance with the provisions of R.S. 40:4(A)(1)(a). Also see R.S. 40:5(2)(3)(5)(7)(15)(17) and R.S. 40:922.

HISTORICAL NOTE: Promulgated by the Department of Health and Hospitals, Office of Public Health, LR 37:2674 (September 2011).

§921. Separate Rooms

A. There shall be separate rooms for:

1. the pasteurizing, ultra-pasteurizing and aseptically processing, cooling and packaging of milk and dairy products;

2. the cleaning of milk cans, bottles, totes, cases and other containers;

3. the fabrication of containers and closures for milk and dairy products;

4. cleaning and sanitizing facilities for milk tank trucks in plants receiving milk in such tanks;

5. receiving cans of milk and dairy products and cleaning and sanitizing such cans in milk plants that receive milk in cans;

6. the processing of cheese or any other dairy products in vats or other types of vessels that are uncovered while product is in them. Provided, that in dairy plants that currently have such open vats or other types of vessels in processing rooms, the state health officer may allow the use of these vats/vessels during periods in which there are no processing or cleaning activities being conducted while the vats/vessels are uncovered. Provided further, that such vats/vessels shall be equipped with properly constructed covers which are tight fitting and designed in such manner as to preclude contamination of product and shall be kept in place during the "setting operation"; and,

7. the boiler and other non-processing mechanical equipment, shop rooms and repair areas.

B. The state health officer shall have the authority to require individual plants to provide separate rooms for any purpose he determines to be necessary to prevent a compromise to food safety.

C. Rooms in which milk or dairy products are handled, processed or stored or in which dairy product containers, utensils and equipment are cleaned or stored, shall not open directly into any stable, farmstead or area in which meat, poultry or any other non-dairy foods of animal origin are handled or stored, any restaurant food preparation area or any room used for domestic purposes. All rooms shall be of sufficient size for their intended purposes.

D. Separate areas or rooms and equipment shall be provided for receiving, handling, storage and disposal of returned dairy products that have left direct control of the plant and shall be used for this purpose only. They shall be kept neat, clean and maintained in such a manner as to preclude contamination of other products and equipment or attraction of flies and rodents. Such products shall not be used for human consumption.

AUTHORITY NOTE: Promulgated in accordance with the provisions of R.S. 40:4(A)(1)(a). Also see R.S. 40:5(2)(3)(5)(7)(15)(17) and R.S. 40:922.

HISTORICAL NOTE: Promulgated by the Department of Health and Hospitals, Office of Public Health, LR 37:2674 (September 2011).

§923. Toilet Facilities

A. Every dairy plant shall be provided with flush toilet facilities conforming to the regulations of Part XIII and Part XIV of this Code. Toilet rooms shall not open directly into any room in which milk, milk products, equipment, or containers are handled or stored. The doors of all toilet

rooms shall be self-closing. Toilet rooms shall be kept in clean condition and in good repair. Toilet rooms shall be well ventilated by use of mechanical exhaust which discharges to the outside atmosphere. Hand washing facilities provided with hot and cold running water under pressure, soap, air dryer or single service towel shall be provided in the toilet room. Signs shall be posted in all toilet rooms informing employees that they are required to wash their hands before returning to work.

B. Toilets shall be conveniently located in or immediately adjacent to the plant and shall not be located in residences.

C. A covered trash container shall be provided in each toilet room.

AUTHORITY NOTE: Promulgated in accordance with the provisions of R.S. 40:4(A)(1)(a). Also see R.S. 40:5(2)(3)(5)(7)(15)(17) and R.S. 40:922.

HISTORICAL NOTE: Promulgated by the Department of Health and Hospitals, Office of Public Health, LR 37:2674 (September 2011).

§925. Water Supply

A. The water supply shall comply with Part XII of this Code.

B. Potable water supplies for dairy plants shall comply with the following:

1. Water for dairy plant purposes shall be from supplies approved by the state health officer and properly located, protected and operated. It shall be accessible and of a safe, sanitary quality.

2. There shall be no cross-connection between the safe water supply and any unsafe or questionable water supply, or any source of pollution through which the safe water supply might become contaminated. A connection between the water supply piping and a make-up tank (such as for cooling or condensing), unless protected by an air gap or effective back-flow preventer, constitutes a violation of this requirement.

3. New individual water supplies and water supply systems which have been installed, repaired or otherwise become contaminated shall be disinfected before being placed in use. The supply or water supply system shall be made free of the disinfectant (or lowered until the disinfectant residual is equal to the normal disinfectant residual coming from the existing water supply system) by pumping to waste before any sample for bacteriological testing shall be collected.

4. Samples for bacteriological testing of individual water supplies and water supply systems shall be taken by the state health officer upon the initial approval of the physical structure, each six months thereafter and when any repair or alteration of the individual water supply or water supply system has been made. Samples shall be taken by the state health officer and examinations shall be conducted in an official laboratory. To determine if water samples have been taken at the frequency established in this section, the

interval shall include the designated six-month period plus the remaining days of the month in which the sample is due.

5. Besides meeting bacteriological standards of Appendix G, Section I of the PMO, of potable water supplied by individual water supplies shall also comply with applicable chemical, physical, and radiological standards. Samples for same shall be submitted by the milk or dairy facility to a certified chemical laboratory/drinking water (as defined in Part XII of this Code) every five years. The state health officer shall determine which chemical, physical, or radiological contaminants or parameters the water should be tested for. Copies of the laboratory results of samples shall be submitted to the state health officer by the milk or dairy facility.

6. The water samples shall be tested in a laboratory, approved by the state health officer using the methodology prescribed by *Appendix G* of the *PMO*. The state health officer shall take appropriate regulatory action on violative water samples in accordance with the requirements of the *PMO*.

7. Current records of water test results shall be retained on file by the state health officer and by the plant.

C. Any potable water system associated with a milk or dairy facility which has at least 15 service connections or regularly serves an average of 25 individuals daily for at least 60 days out of the year is considered a public water system and must also be regulated under provisions applicable to public water systems as required in Part XII of this Code. If a potable water system meets this criteria and the source of supply of such system is from a water well, such water well shall be constructed in accord with public water system standards. With the exception of achieving and maintaining potable water quality standards as specified in other Paragraphs of this Section, compliance with other provisions under Part XII of this Code which are applicable only to public water systems shall not be required if the public water system meets all of the following conditions:

1. consists only of distribution and storage facilities (and does not have any collection and treatment facilities);
2. obtains all of its water from, but is not owned or operated by, a public water system to which such regulations apply;
3. does not sell water to any person; and,
4. is not a carrier which conveys passengers in interstate commerce.

AUTHORITY NOTE: Promulgated in accordance with the provisions of R.S. 40:4(A)(1)(a). Also see R.S. 40:5(2)(3)(5)(7)(15)(17) and R.S. 40:922.

HISTORICAL NOTE: Promulgated by the Department of Health and Hospitals, Office of Public Health, LR 37:2674 (September 2011).

§927. Hand-washing Facilities

A. Hand-washing facilities provided with hot and cold running water under pressure through a mixing faucet, soap, air dryer or single service sanitary towels shall be

conveniently located to all areas in which dairy products are handled and equipment is cleaned. The use of a common towel is prohibited.

AUTHORITY NOTE: Promulgated in accordance with the provisions of R.S. 40:4(A)(1)(a). Also see R.S. 40:5(2)(3)(5)(7)(15)(17) and R.S. 40:922.

HISTORICAL NOTE: Promulgated by the Department of Health and Hospitals, Office of Public Health, LR 37:2675 (September 2011).

§929. Protection from Contamination

A. Dairy plant operations shall be so conducted and equipment and facilities located in such manner as to prevent contamination of dairy products, ingredients, packaging materials, equipment, containers and utensils.

B. All milk products or ingredients which have been spilled, overflowed or leaked shall not be used for human consumption.

C. The storage, handling or use of poisonous or toxic materials shall be performed in such a manner as to preclude contamination of milk products, ingredients, packaging materials or product contact surfaces of equipment, containers or utensils. All containers containing poisonous or toxic materials, including cleaning and sanitizing compounds, shall be distinctly and prominently labeled.

D. All equipment and piping containing cleaning solutions/compounds shall be physically separated from equipment containing dairy products.

E. All equipment and piping containing pasteurized food products shall be physically separated from equipment and piping containing unpasteurized food products.

F. Pasteurized dairy products shall not be permitted to come in contact with equipment or piping with which unpasteurized dairy products or non-dairy products have been in contact, unless such equipment has first been properly cleaned and sanitized.

G. All water used to flush pasteurized product out of lines, vessels or equipment shall be pasteurized or treated by other treatment approved by the state health officer with the concurrence of the FDA. All lines, vessels or equipment that have contained water or product that was not pasteurized or treated, as afore provided, shall be cleaned and sanitized prior to use for pasteurized products.

H. The dairy plant shall be used for no other purpose than the processing of dairy products and the operations incident thereto, provided that the state health officer may authorize the processing or handling of products other than dairy products in such a manner as to preclude the contamination of dairy products, product contact surfaces of all equipment, piping or containers.

I. Air under pressure that comes in contact with dairy products or product contact surfaces shall be free from oil, dust, rust, excessive moisture, extraneous materials or odor and shall comply with the requirements for air under pressure contained in the *PMO*.

J. Steam that is used in contact with dairy products shall comply with the applicable standards of the *PMO* and be of culinary quality.

K. Equipment and operations shall be so located within the dairy plant as to prevent overcrowding and contamination of product, equipment, containers, packaging materials or ingredients by splash, condensation, manual contact or drippings, spillage or splash from overhead piping, cooling equipment, platforms, etc.

L. Effective insect and rodent control programs shall be conducted. Dogs, cats and other animals or fowl and birds shall not be allowed in the dairy plant.

M. Multi-use containers or equipment used for dairy products, such as milk crates, bossy carts, milk cans, etc., that have been on premises where swine or poultry are kept, or premises where raw poultry or pork products are processed or have been used to store raw poultry or pork products shall not be used in the processing or handling of dairy products.

N. Eggs and raw egg products shall be handled or stored in areas separated from dairy products in such a manner as to preclude contamination of floors, conveyors, cases, etc., used for dairy products handling or storage, provided, that delivery vehicles are exempt from this requirement when adequate steps are taken to preclude contamination of dairy products or containers/crates from broken eggs or leaking raw egg products.

O. Fork lifts, pallet jacks and other materials handling equipment that have been in contact with driveways, concrete/ground surfaces of the exterior of the dairy plant or have been used in areas where meat, poultry, pork and returned dairy products are handled shall not enter the areas of the dairy plant where dairy products are handled, processed or stored or areas in which containers and equipment are cleaned, sanitized or stored.

P. Entry into each specific area of the plant where dairy products are handled, processed, packaged or stored shall be restricted to personnel whose presence is necessary for conducting, supervising or inspecting operations in that specific area. Training activities may be allowed.

Q. Each entrance into each area where dairy products are handled, processed, packaged, stored or dairy equipment is cleaned shall be provided with footwear baths containing sanitizers that effectively sanitize footwear. These footwear baths shall be so located and maintained in such a manner as to effectively sanitize the footwear of all persons entering these areas. Spray type devices and other devices approved by the state health officer that adequately perform the same function as the footwear baths may be used.

R. Lighting fixtures shall be constructed and installed in such a manner as to preclude the contamination of products, ingredients, packaging material, packaged products or product contact surfaces of equipment.

S. Graded dairy products, not in the final package, shall not be permitted to come in contact with products of a lower

grade or with ungraded products or with utensils, piping or equipment which has been in contact with lower grade or ungraded products unless such utensils, piping or equipment have been properly cleaned prior to use for higher graded product.

T. Returned dairy products (dairy products that have left the direct control of the plant that processed them) shall be handled in such a manner that they do not come in physical contact or contact through drippage or spillage with any area in which other products are stored or handled. They shall not come in such contact with any equipment used in the handling of other products. The returned dairy products shall be clearly identified and other prudent measures taken to preclude contamination or integration with wholesome products.

U. All floor drains in areas of the plant used for receiving, processing, handling dairy products and where containers, utensils and equipment are cleaned shall be kept in good repair, cleaned and sanitized at least once each week. Brushes used to clean floor drains should be color coded and said brushes shall not be used for any other purpose.

AUTHORITY NOTE: Promulgated in accordance with the provisions of R.S. 40:4(A)(1)(a). Also see R.S. 40:5(2)(3)(5)(7)(15)(17) and R.S. 40:922.

HISTORICAL NOTE: Promulgated by the Department of Health and Hospitals, Office of Public Health, LR 37:2675 (September 2011).

§931. Reclaim or Rework Operations

A. Reclaim or rework operations are all activities associated with the recovery, handling and storage of processed or partially processed products for use as an ingredient in products to be used for human consumption.

B. Product that has left the direct control of the plant or has been temperature-abused, tampered with or exposed to chemical or biological contamination shall not be reclaimed or reworked for use as an ingredient in other products for human consumption.

C. Reclaimed or reworked products and reclaim or rework operations shall conform with the following requirements.

1. Reclaim areas and equipment shall be constructed, maintained and protected in a manner that is in substantial compliance with the requirements for the production and processing equipment areas contained in this Part.

2. Product that has left the direct control of the plant in which it was packaged shall not be reclaimed or reworked.

3. All product to be reclaimed shall be maintained at 7°C (45°F) or below. Product salvaged from defoamers and tank or line rinsing shall be immediately cooled to 7°C (45°F) or below.

4. Packages of product to be reclaimed or reworked shall be clean and free of contamination. Product from open,

leaking or badly damaged containers shall not be reclaimed or reworked.

5. Packaged product shall be opened in such a manner as to minimize the potential for contamination. Containers shall not be opened by slashing, smashing or breaking.

6. Woven wire strainers shall not be used in reclaim or rework operations.

7. Reclaim or rework dump stations and tanks shall be covered except when product is actually being dumped through the openings.

8. Reclaim or rework storage tanks shall be equipped with approved thermometers.

9. Cleaning and sanitization requirements shall be the same as those for raw dairy ingredient handling equipment.

10. Reclaimed or reworked product shall be handled as a raw dairy ingredient.

11. Reclaimed or reworked products when used as an ingredient shall be added to the final product prior to pasteurization.

12. It is recommended that higher than minimum temperatures and times be used in the pasteurization of product containing reclaimed or reworked ingredients.

13. The milk plant shall take appropriate steps to preclude the contamination of products or equipment with allergenic or sensitive producing ingredients, reclaimed or reworked ingredients or substances that will not be appropriately declared in the labeling of the final container of product.

AUTHORITY NOTE: Promulgated in accordance with the provisions of R.S. 40:4(A)(1)(a). Also see R.S. 40:5(2)(3)(5)(7)(15)(17) and R.S. 40:922.

HISTORICAL NOTE: Promulgated by the Department of Health and Hospitals, Office of Public Health, LR 37:2676 (September 2011).

§933. Dairy Plant Cleanliness

A. All rooms in which milk and dairy products are handled, processed or stored, or in which containers, utensils or equipment are cleaned or stored, shall be kept clean, neat and free of evidence of insects and rodents. Approved pesticides shall be stored, handled and used so as not to present a health hazard. Only equipment directly related to processing operations or to handling of containers, utensils and equipment shall be permitted in the receiving, pasteurizing, ultra-pasteurizing, aseptic processing, cooling, packaging and bulk milk and dairy products storage areas.

AUTHORITY NOTE: Promulgated in accordance with the provisions of R.S. 40:4(A)(1)(a). Also see R.S. 40:5(2)(3)(5)(7)(15)(17) and R.S. 40:922.

HISTORICAL NOTE: Promulgated by the Department of Health and Hospitals, Office of Public Health, LR 37:2677 (September 2011).

§935. Sanitary Piping

A. All sanitary piping, fittings, connections and automated cleaning systems shall comply with applicable 3-

A Standards or the construction thereof shall be approved in writing by the state health officer, and shall consist of smooth, impervious, corrosion-resistant, non-toxic, easily cleanable material. All piping, fittings and connections shall be in good repair. Pasteurized milk and milk products shall be transferred from one piece of equipment to another only through sanitary piping.

AUTHORITY NOTE: Promulgated in accordance with the provisions of R.S. 40:4(A)(1)(a). Also see R.S. 40:5(2)(3)(5)(7)(15)(17) and R.S. 40:922.

HISTORICAL NOTE: Promulgated by the Department of Health and Hospitals, Office of Public Health, LR 37:2677 (September 2011).

§937. Construction and Repair of Containers and Equipment

A. All multi-use containers and equipment with which milk or dairy products come into contact and automated cleaning equipment shall comply with applicable 3-A Standards. They shall be of smooth, impervious, corrosion-resistant, non-toxic material; shall be constructed for ease of cleaning and be easily accessible or demountable for manual cleaning or be designed for mechanical cleaning. All product contact surfaces shall be readily accessible for inspection, shall be self-draining and shall be kept in good repair. All single-service milk containers and closures used for milk, milk products or other dairy products shall be manufactured by plants certified by FDA and listed in the latest publication of the *IMS List Sanitation Compliance and Enforcement Ratings of Interstate Milk Shippers* or shall comply with all requirements of this Part. Gaskets and other articles with which milk or dairy products come in contact shall be non-toxic, and shall have been manufactured, packaged, transported and handled in a sanitary manner. Articles intended for single-service use shall not be reused. The design, construction and method of employment of all dairy equipment shall be approved by the state health officer prior to installation.

AUTHORITY NOTE: Promulgated in accordance with the provisions of R.S. 40:4(A)(1)(a). Also see R.S. 40:5(2)(3)(5)(7)(15)(17) and R.S. 40:922.

HISTORICAL NOTE: Promulgated by the Department of Health and Hospitals, Office of Public Health, LR 37:2677 (September 2011).

§939. Thermometers

A. Unless the thermometers and other temperature monitoring instruments and recording devices used in dairy plants are accurate within known limits, there can be no assurance that proper temperatures for cooling, pasteurization, ultra-pasteurizing, aseptic processing, storage, cleaning, etc., are being applied.

B. All thermometers, temperature monitoring instruments, and recording devices used in dairy plants shall conform with the requirements for such thermometers, temperature monitoring instruments, and recording devices contained in the *PMO*.

C. The operator shall record the temperature, as shown by the indicating thermometer, on the recording chart each

time a chart is placed in each recorder and at least once during each 24-hour period of operation.

D. The dairy plant shall test and calibrate all indicating and recording thermometers used in the dairy plant (including CIP system and dairy product storage tank and product storage rooms recording thermometers) at least once in each three-month period using a test thermometer approved by the state health officer. Provided that any thermometers tested and calibrated by the state health officer need not be tested and calibrated by the dairy plant until the lapse of three months from the date they were tested and calibrated by the state health officer.

E. During each inspection of each milk plant's processing operation, the state health officer shall examine and initial a representative sample of each type of recording charts and logs to verify the calibration of monitoring devices and to verify that the operations were conducted in accordance with the requirements of this Part.

AUTHORITY NOTE: Promulgated in accordance with the provisions of R.S. 40:4(A)(1)(a). Also see R.S. 40:5(2)(3)(5)(7)(15)(17) and R.S. 40:922.

HISTORICAL NOTE: Promulgated by the Department of Health and Hospitals, Office of Public Health, LR 37:2677 (September 2011).

§941. Pasteurization, Ultra-pasteurization and Aseptic Processing

A. All dairy products (e.g., milk solids, whey, nonfat dry milk, condensed milk, cream, nonfat (fat free, skim) milk, etc.), eggs, egg products, cocoa, cocoa products, frozen dessert mixes, emulsifiers, stabilizers, vitamins, sweeteners and any other approved ingredients (with the exception of those ingredients listed in Subsection B of this Section shall be added prior to pasteurization, ultra pasteurization or aseptic processing.

B. The only ingredients which shall be added after pasteurization or ultra pasteurization are those flavoring ingredients which are:

1. fresh fruits or vegetables and only when they are added to cultured dairy products having a pH of less than 4.7 and only in a dairy plant having a quality assurance program which is considered adequate by the state health officer;
2. subjected to prior heat treatment sufficient to destroy all pathogenic microorganisms;
3. a water activity of 0.85 (Aw) or less;
4. high acid content products;
5. roasted nuts;
6. dry sugars;
7. flavor extracts containing high alcohol content; or
8. safe and suitable bacterial cultures.

C. Such additions shall be made only with approval of the state health officer with the concurrence of FDA and in a manner which prevents product contamination.

D. Pasteurization and ultra-pasteurization shall be performed in equipment and using procedures that conform with the requirements of *PMO* and current applicable 3-A Standards and are approved by the state health officer.

E. Aseptic processing shall be performed in accordance with *Title 21 CFR Parts 108 and 113* and the requirements of *PMO*.

F. Pasteurization, ultra-pasteurization and aseptic processing shall be controlled as a CCP in plants being regulated under HACCP.

AUTHORITY NOTE: Promulgated in accordance with the provisions of R.S. 40:4(A)(1)(a). Also see R.S. 40:5(2)(3)(5)(7)(15)(17) and R.S. 40:922.

HISTORICAL NOTE: Promulgated by the Department of Health and Hospitals, Office of Public Health, LR 37:2678 (September 2011).

§943. Cleaning and Sanitization of Containers and Equipment

A. All multi-use containers and equipment used in the processing, handling, storage or transportation of milk and dairy products shall be properly cleaned after each use and shall be cleaned at least once each 24 hours of use, provided:

1. storage tanks shall be cleaned each time they are emptied and shall be emptied at least every 72 hours;
2. storage tanks used to store raw milk or heat treated milk products longer than 24 hours and silo tanks used to store raw milk or heat treated milk products shall be equipped with a seven-day temperature recording device complying with the requirements for such devices contained in the *PMO* and shall be approved by the state health officer prior to installation;
3. upon review of information provided by the milk plant supporting the cleaning of multi-use containers and equipment at frequencies extending beyond the 24 hour requirement, the state health officer may with the concurrence of the FDA, on a case by case basis, authorize cleaning intervals greater than 24 hours;
4. records shall be available to the state health officer to verify that storage tanks have been properly cleaned at least once each 72 hours or at the frequency established by the state health officer in concurrence with the FDA.

B. Milk and milk product pipelines and equipment designed for mechanical CIP cleaning shall meet the following requirements.

1. An effective cleaning and sanitization regimen that shall be followed for each separate cleaning and sanitization operation shall be posted near the cleaned -in-place equipment controls.

2. A temperature recording device complying with the requirements for such recording device contained in the *PMO* and approved by the state health officer shall be installed in the cleaning and sanitizing solution return line or other area, approved by the state health officer with the concurrence of the FDA, to record the temperatures and

times during which the line or equipment is exposed to cleaning and sanitizing solutions. The state health officer may require that pressure gauges, other instruments or logs be provided to verify that cleaning and sanitization was properly performed.

3. Charts/records/logs used to verify proper cleaning and sanitizing shall be retained for a minimum of three months.

4. During each inspection of the cleaning and sanitizing operations of each plant, the state health officer shall examine and initial a representative sample of each type of charts/records/logs to verify that the operations were conducted in accordance with the posted cleaning and sanitization regimens.

C. All multi-use containers and equipment shall be effectively sanitized before first use by means approved by the state health officer. Assembled equipment shall be sanitized prior to each first use.

D. Piping, equipment and containers used to process, conduct or package aseptically processed milk and dairy products beyond the final heat treatment process, shall be sterilized before any aseptically milk or milk product is packaged and shall be re-sterilized whenever any unsterile product has contaminated it.

E. Multi-use milk crates and bossy carts shall be properly cleaned and sanitized before each use and before being brought into any area of the plant where milk and dairy products are pasteurized, processed, cooled or packaged.

F. Cleaning procedures; including solution mixing directions, strengths, testing procedures, temperature requirements, circulation times, etc., shall be posted adjacent to all equipment used to clean or sanitize dairy equipment.

G. The posted procedures shall be followed in the cleaning and sanitization of the equipment.

AUTHORITY NOTE: Promulgated in accordance with the provisions of R.S. 40:4(A)(1)(a). Also see R.S. 40:5(2)(3)(5)(7)(15)(17) and R.S. 40:922.

HISTORICAL NOTE: Promulgated by the Department of Health and Hospitals, Office of Public Health, LR 37:2678 (September 2011).

§945. Storage of Cleaned Containers and Equipment

A. After cleaning, all multi-use milk or dairy product containers, utensils and equipment shall be transported and stored to assure complete drainage, unless stored in sanitizing solutions, and shall be protected from contamination before use.

AUTHORITY NOTE: Promulgated in accordance with the provisions of R.S. 40:4(A)(1)(a). Also see R.S. 40:5(2)(3)(5)(7)(15)(17) and R.S. 40:922.

HISTORICAL NOTE: Promulgated by the Department of Health and Hospitals, Office of Public Health, LR 37:2679 (September 2011).

§947. Storage of Single-service Containers, Utensils and Materials

A. Single-service caps, cap stock, parchment paper, films, containers, gaskets and other single-service articles for use in contact with dairy products including frozen desserts products shall be purchased from sources approved by the state health officer and stored in the original container or in equipment designed for storage of single service articles and shall be kept therein in a clean, dry place until used; and shall be handled in a sanitary manner.

AUTHORITY NOTE: Promulgated in accordance with the provisions of R.S. 40:4(A)(1)(a). Also see R.S. 40:5(2)(3)(5)(7)(15)(17) and R.S. 40:922.

HISTORICAL NOTE: Promulgated by the Department of Health and Hospitals, Office of Public Health, LR 37:2679 (September 2011).

§949. Packing, Bottling and Wrapping

A. Bottling, packaging and wrapping of milk and dairy products shall be done at the place of pasteurization, ultra-pasteurization or aseptic processing in mechanical equipment that complies with applicable 3-A Standards and the *PMO, Item 18p*.

B. Upright open containers and container closures shall be protected from contamination by the use of overhead shields and drip deflectors.

C. Air directed at the contact surfaces of containers or closures shall comply with the requirements for such air, contained in the *PMO*.

AUTHORITY NOTE: Promulgated in accordance with the provisions of R.S. 40:4(A)(1)(a). Also see R.S. 40:5(2)(3)(5)(7)(15)(17) and R.S. 40:922.

HISTORICAL NOTE: Promulgated by the Department of Health and Hospitals, Office of Public Health, LR 37:2679 (September 2011).

§951. Capping

A. Capping or closing of milk and dairy product containers shall be done in a sanitary manner in mechanical equipment that complies with applicable 3-A Standards and the *PMO, Item 19p*. Single service containers and closures used for milk and milk products shall have been manufactured by plants that comply with the single service container and closure requirements of this Code. The cap or closure shall protect the milk pouring lip to at least its largest diameter and, with regard to fluid product containers, removal cannot be made without detection.

B. Hand capping is prohibited.

AUTHORITY NOTE: Promulgated in accordance with the provisions of R.S. 40:4(A)(1)(a). Also see R.S. 40:5(2)(3)(5)(7)(15)(17) and R.S. 40:922.

HISTORICAL NOTE: Promulgated by the Department of Health and Hospitals, Office of Public Health, LR 37:2679 (September 2011).

§953. Delivery Containers

A. All pasteurized, ultra-pasteurized and aseptically processed milk and dairy products shall be placed in their final delivery containers in the plant in which they are

pasteurized, ultra-pasteurized or aseptically processed. It shall be unlawful for hotels, soda fountains, restaurants, grocery stores, markets and similar establishments to sell or serve any milk or milk products except in the original containers received from the plant in which it was pasteurized, ultra-pasteurized or aseptically processed or from a bulk container dispensing device that conforms with 3-A Standards. Packaging of milk and milk products from such dispensers is prohibited. This requirement shall not apply to cream consumed on the premises or milk and milk products in portions less than 1/2 pint used in mixed drinks, cereals, desserts or other foods. In these instances, pouring from a commercially filled container of not more than one gallon capacity is acceptable. (see LAC 51:XXIII.1115.B)

AUTHORITY NOTE: Promulgated in accordance with the provisions of R.S. 40:4(A)(1)(a). Also see R.S. 40:5(2)(3)(5)(7)(15)(17) and R.S. 40:922.

HISTORICAL NOTE: Promulgated by the Department of Health and Hospitals, Office of Public Health, LR 37:2679 (September 2011).

§955. Cooling of Dairy Products

A. All raw milk and milk products shall be received and maintained at 7°C (45°F) or less until processed, except that acid-type whey with a titratable acidity of 0.40% or above, or a pH of 4.6 or below, is exempted from these temperature requirements. Provided, that all balance or surge tanks (continuous flow with a retention time not to exceed one hour) for raw milk and milk products, pasteurized milk and milk products and whey and whey products may be maintained at any temperature for up to 24 hours.

B. All whey and whey products for condensing and/or drying are maintained at a temperature of 7°C (45°F) or less; or 57°C (135°F) or greater until processed. Storage tanks containing whey and whey product above 7°C (45°F) and below 57°C (135°F) shall be emptied, cleaned and sanitized after each 4 hours of use or less. (Nothing shall be construed as barring other time and temperature relationships, which have been recognized to be equally efficient and which are approved by the state health officer).

C. All pasteurized milk and milk products, except the following, are cooled immediately in approved equipment prior to filling or packaging to a temperature of 7°C (45°F) or less, unless drying is commenced immediately after condensing:

1. those to be cultured;
2. cultured sour cream at all milkfat levels with a pH of 4.70 or below. (Critical factors including, but not limited to, pH and cooling time and temperature shall be monitored and documented by the processing facility for verification by the state health officer. pH limit with a pH variance of +0.05 units to account for reproducibility and inaccuracies in pH measurements. Formulation or processing changes that affect critical factors shall be communicated to the state health officer);
3. acidified sour cream at all milkfat levels with a pH of 4.60 or below. (Critical factors including, but not limited

to, pH and cooling time and temperature shall be monitored and documented by the processing facility for verification by the state health officer. pH limit with a pH variance of +0.05 units to account for reproducibility and inaccuracies in pH measurements. Formulation or processing changes that affect critical factors shall be communicated to the state health officer);

4. all yogurt products at all milkfat levels with an initial pH of 4.80 or below at filling. (Critical factors including, but not limited to, pH and cooling time and temperature shall be monitored and documented by the processing facility for verification by the state health officer. pH limit with a pH variance of +0.05 units to account for reproducibility and inaccuracies in pH measurements. Formulation or processing changes that affect critical factors shall be communicated to the state health officer);

5. cultured buttermilk at all milkfat levels with a pH of 4.60 or below. (Critical factors including, but not limited to, pH and cooling time and temperature shall be monitored and documented by the processing facility for verification by the state health officer. pH limit with a pH variance of +0.05 units to account for reproducibility and inaccuracies in pH measurements. Formulation or processing changes that affect critical factors shall be communicated to the state health officer); and

6. all condensed whey and whey products shall be cooled during the crystallization process to 10°C (50°F) or less within 72 hours of condensing, including the filling and emptying time, unless filling occurs above 57°C (135°F), in which case, the 72 hour time period begins when cooling is started. (Nothing shall be construed as barring other time and temperature relationships, which have been recognized to be equally efficient and which are approved by the state health officer).

D. All pasteurized milk and milk products, except the following, shall be stored at a temperature of 7°C (45°F) or less and be maintained thereat following filling or until further processed:

1. Cultured sour cream at all milkfat levels with a pH of 4.70 or below. (Critical factors including, but not limited to, pH and cooling time and temperature shall be monitored and documented by the processing facility for verification by the state health officer. pH limit with a pH variance of +0.05 units to account for reproducibility and inaccuracies in pH measurements. Formulation or processing changes that affect critical factors shall be communicated to the state health officer) and cooled to 7°C (45°F) or less within 168 hours of filling. (Temperature monitored at the slowest cooling portion, i.e., middle of the container, of the slowest cooling container, i.e., in the middle of the pallet).

2. Acidified sour cream at all milkfat levels with a pH of 4.60 or below. (Critical factors including, but not limited to, pH and cooling time and temperature shall be monitored and documented by the processing facility for verification by the state health officer. pH limit with a pH variance of +0.05 units to account for reproducibility and inaccuracies in pH measurements. Formulation or processing changes that

affect critical factors shall be communicated to the state health officer) and cooled to 7°C (45°F) or less within 168 hours of filling (Temperature monitored at the slowest cooling portion, i.e., middle of the container, of the slowest cooling container, i.e., in the middle of the pallet).

3. All yogurt products at all milkfat levels with an initial pH of 4.80 or below. (Critical factors including, but not limited to, pH and cooling time and temperature shall be monitored and documented by the processing facility for verification by the state health officer. pH limit with a pH variance of +0.05 units to account for reproducibility and inaccuracies in pH measurements. Formulation or processing changes that affect critical factors shall be communicated to the state health officer) at filling, with a pH of 4.60 or below within 24 hours of filling (critical factors including, but not limited to, pH and cooling time and temperature shall be monitored and documented by the processing facility for verification by the state health officer. pH limit with a pH variance of +0.05 units to account for reproducibility and inaccuracies in pH measurements. Formulation or processing changes that affect critical factors shall be communicated to the state health officer) and cooled to 7°C (45°F) or less within 168 hours of filling (Temperature monitored at the slowest cooling portion, i.e., middle of the container, of the slowest cooling container, i.e., in the middle of the pallet).

4. Cultured buttermilk at all milkfat levels with a pH of 4.60 or below (Critical factors including, but not limited to, pH and cooling time and temperature shall be monitored and documented by the processing facility for verification by the state health officer. pH limit with a pH variance of +0.05 units to account for reproducibility and inaccuracies in pH measurements. Formulation or processing changes that affect critical factors shall be communicated to the state health officer) and cooled to 7°C (45°F) or less with 24 hours of filling (Temperature monitored at the slowest cooling portion, i.e., middle of the container, of the slowest cooling container, i.e., in the middle of the pallet).

E. All pasteurized milk and milk products to be condensed and/or dried, shall be stored at a temperature of 10°C (50°F) or less and be maintained thereat until further processed. If storage tanks are used between the condenser and dryer, any such storage tank(s) containing pasteurized milk or milk products stored above 10°C (50°F) and below 57°C (135°F) shall be completely emptied and cleaned after each six hours of operation or less (Nothing shall be construed as barring other time and temperature relationships, which have been recognized to be equally efficient and which are approved by the state health officer).

F. Each refrigerated room in which milk and milk products are stored, except aseptically processed milk and milk products, is equipped with an indicating thermometer that complies with the applicable specifications of Appendix H, Subsection IV (Indicating thermometers used in refrigerated rooms where milk and milk products are stored) of the PMO. Such thermometer shall be located in the warmest zone of the refrigerated room.

G. Each storage tank shall be equipped with an indicating thermometer, the sensor of which shall be located to permit the registering of the temperature of the contents when the tank contains no more than 20 percent of its calibrated capacity. Such thermometer shall comply with the applicable specifications of Appendix H, Subsection IV (Indicating thermometer used in storage tanks) of the PMO. See §943.A.2 of this Part for recording device requirements in certain circumstances.

H. On delivery vehicles, the temperature of milk and milk products shall not exceed 7°C (45°F).

I. All surface coolers comply with the following specifications:

1. The sections of open-surface coolers shall be so installed as to leave a gap of at least 6.4 millimeters (0.25 inches) between the header sections to permit easy cleaning.

2. Where header ends are not completely enclosed within the cooler covers, condensation or leakage from the headers shall be prevented from entering the milk or milk product by so shaping the exposed header faces, above and below all gaps, that condensation is directed away from the tubes, and by using deflectors at the bottom of the headers, or by shortening the bottom trough, or by some other approved method.

3. The location of supports of cooler sections shall prevent condensation and leakage from entering the milk or milk product.

4. All open-surface coolers shall be provided with tight-fitting shields that protect the milk and milk product from contamination by insects, dust, drip, splash or manual contact.

J. Recirculated cooling water, which is used in coolers and heat exchangers, including those systems in which a freezing point depressant is used, is from a safe source and protected from contamination. Such water shall be tested semiannually and shall comply with the bacteriological standards of Appendix G, Section I of the PMO. Samples shall be taken by the state health officer and examination shall be conducted in an DHH-OPH Certified Bacteriological/Drinking Water Laboratory. Recirculated cooling water systems, which become contaminated through repair work or otherwise, shall be properly disinfected and tested before being returned to use. Freezing point depressants and other chemical additives, when used in recirculating systems, shall be non-toxic under conditions of use. Recirculated cooling water contained in corrosion resistant, continuous piping, with no joints or welds, which fail to meet applicable American Society of Mechanical Engineers (ASME) or equivalent standards in the non-potable water contact areas, may be considered to be protected from contamination, as required above, when cooled by non-potable water flowing over the exterior of the piping, within open evaporative type cooling tower. In these systems, the recirculated cooling water piping shall be properly maintained and shall be installed so that it is at least 2 pipe diameters above the flood rim of the cooling tower.

K. Water from an open, evaporative cooling tower may be used to cool water in an intermediate cooling media loop that will subsequently be used to cool product, provided that the water in the intermediate cooling media loop is effectively protected against infiltration and contamination by tower water at all times. If a plate type or double/triple tube type heat exchanger is used to exchange heat between the water from the open tower and the water in the intermediate cooling media loop it must be protected by an Isolation System to assure that there is no possibility of contamination of the intermediate cooling media loop water by the tower water. The isolation system shall include:

1. tower water heat exchangers shall be constructed, installed and operated so that the intermediate cooling media water in the heat exchanger will automatically be under greater pressure than the open tower water in the heat exchanger at all times;

2. the tower water heat exchanger shall be effectively isolated from the tower water system and the tower water side of the heat exchanger shall drain during shut down;

3. the Isolation System shall be controlled with a pressure differential controller set to a minimum of 6.9 kPa (1 psi). Pressure sensors shall be installed at the tower water inlet to the heat exchanger and intermediate cooling water outlet of the heat exchanger. The differential pressure controller will be interwired with the related supply valves and/or pumps to automatically shut down all supply pumps and return valves in the Isolation System to a fail-safe position to isolate the heat exchanger from the open tower water system, as would occur in a shut down or power failure;

4. the intermediate cooling water shall rise to a vertical elevation of at least 30.5 centimeters (12 inches) above the highest tower water heat exchanger Isolation System, and shall be open to the atmosphere at this elevation. During a shut down the intermediate cooling water shall not drain from the tower water heat exchanger;

5. the Isolation System shall meet one of the following:

a. in a system with tower water supplied directly from the tower water distribution line without a balance tank, or with a balance tank higher than the lowest water level in the tower water heat exchanger, refer to Figures 8, 9, and 10 in Appendix D, Section VII of the *PMO*. In this application, the Isolation System shall begin at the normally closed tower water supply stop “block” valve and ends at the check-valve in the line returning to the open cooling tower. Isolation is accomplished by meeting all of the following:

i. closing the tower water supply valve. This tower water supply valve shall be a normally closed (spring-to-close) valve;

ii. opening a full port vent valve on the supply side of the tower water heat exchanger and a full port drain valve prior to a check-valve in the tower water return line. This drain valve shall be normally open (spring-to-open);

iii. the drain valve and any pipes or pumps located between the drain valve and the heat exchanger must be lower than the lowest liquid level in the heat exchanger;

iv. de-energize any dedicated tower water supply pump, if present, located between the tower water reservoir and the tower water heat exchanger; and

v. if a tower water return pump is used, a bypass line may be used to flood the dry pump at start up;

b. in a system with the overflow of an atmospheric balance tank lower than the lowest water level in the heat exchanger, refer to Figures 11 and 12 in Appendix D, Section VII of the *PMO*. In this application, the Isolation System shall begin at the tower water balance tank and end at the check-valve in the line returning to the open cooling tower. Isolation is accomplished by meeting all of the following:

i. de-energizing the “local tower water supply pump”, if present;

ii. opening a full port vent valve on the supply side of the tower water heat exchanger;

iii. open a full port drain valve prior to a check-valve in the tower water return line. This drain valve must be normally open (spring-to-open); and

iv. the drain valve and any pipes or pumps located between it and the heat exchanger must be lower than the lowest liquid level in the heat exchanger;

c. variations from the above isolation systems may be individually evaluated and found to also be acceptable by the state health officer, if the level of protection required by this Subsection is not compromised.

6. A means to test the response of this isolation system must be developed and available at the milk plant. The accuracy of the required differential pressure controller shall be checked by the state health officer on installation; every six months thereafter; and following repair or replacement.

AUTHORITY NOTE: Promulgated in accordance with the provisions of R.S. 40:4(A)(1)(a). Also see R.S. 40:5(2)(3)(5)(7)(15)(17) and R.S. 40:922.

HISTORICAL NOTE: Promulgated by the Department of Health and Hospitals, Office of Public Health, LR 37:2679 (September 2011).

§957. Use of Overflow, Leaked, Spilled or Mishandled Dairy Products

A. The use of overflow, leaked, spilled or mishandled dairy products for human consumption is prohibited.

AUTHORITY NOTE: Promulgated in accordance with the provisions of R.S. 40:4(A)(1)(a). Also see R.S. 40:5(2)(3)(5)(7)(15)(17) and R.S. 40:922.

HISTORICAL NOTE: Promulgated by the Department of Health and Hospitals, Office of Public Health, LR 37:2682 (September 2011).

§959. Sale of Reconstituted or Recombined Milk or Milk Products and Reconstituted or Recombined Anomalous (Substitute) Milk or Milk Products

A. The sale of reconstituted or recombined milk or milk products and reconstituted or recombined anomalous (substitute) milk or milk products shall be prohibited.

B. No reconstituted or recombined milk or milk products, (to include whole milk, reduced fat milk, lowfat milks, nonfat milk, flavored milks, creams, half-and-half) and reconstituted or recombined anomalous (substitute) milk and milk products shall be permitted to be held, kept, offered for sale, sold or delivered, provided in an emergency, the sale of reconstituted fluid milk products may be authorized by special permit from the state health officer and shall be labeled in accordance with the labeling requirements of this Part.

AUTHORITY NOTE: Promulgated in accordance with the provisions of R.S. 40:4(A)(1)(a). Also see R.S. 40:5(2)(3)(5)(7)(15)(17) and R.S. 40:922.

HISTORICAL NOTE: Promulgated by the Department of Health and Hospitals, Office of Public Health, LR 37:2682 (September 2011).

§961. Use of Inhibitors

A. The addition of any substance to dairy products for the purpose of preventing growth of bacteria is prohibited (see definition of adulterated milk, milk products, or dairy products, §101 of this Part).

AUTHORITY NOTE: Promulgated in accordance with the provisions of R.S. 40:4(A)(1)(a). Also see R.S. 40:5(2)(3)(5)(7)(15)(17) and R.S. 40:922.

HISTORICAL NOTE: Promulgated by the Department of Health and Hospitals, Office of Public Health, LR 37:2682 (September 2011).

§963. Denaturing of Milk or Dairy Products

A. The state health officer may immediately denature, with rennet or some harmless coloring matter, dairy products found to be adulterated, misbranded with respect to grading or sold without a permit.

AUTHORITY NOTE: Promulgated in accordance with the provisions of R.S. 40:4(A)(1)(a). Also see R.S. 40:5(2)(3)(5)(7)(15)(17) and R.S. 40:922.

HISTORICAL NOTE: Promulgated by the Department of Health and Hospitals, Office of Public Health, LR 37:2682 (September 2011).

§965. Dipping or Transferring Dairy Products

A. Dairy products shall not be dipped or transferred from one container to another on the street or in any vehicle or store or in any place except in dairy plants possessing a permit for such activity issued by the state health officer, provided, that milk producers may transfer raw milk from milking pails or milking machines to milk cans or bulk tanks in the milk house/room on dairy farms in a sanitary manner.

AUTHORITY NOTE: Promulgated in accordance with the provisions of R.S. 40:4(A)(1)(a). Also see R.S. 40:5(2)(3)(5)(7)(15)(17) and R.S. 40:922.

HISTORICAL NOTE: Promulgated by the Department of Health and Hospitals, Office of Public Health, LR 37:2682 (September 2011).

§967. Apparatus, Containers, Equipment and Utensils

A. Apparatus, containers, equipment and utensils used in the production, handling, storage, processing or transporting of dairy products shall not be used for any other purpose without the authorization of the state health officer.

AUTHORITY NOTE: Promulgated in accordance with the provisions of R.S. 40:4(A)(1)(a). Also see R.S. 40:5(2)(3)(5)(7)(15)(17) and R.S. 40:922.

HISTORICAL NOTE: Promulgated by the Department of Health and Hospitals, Office of Public Health, LR 37:2682 (September 2011).

§969. Personnel Health

A. No persons affected with any disease capable of being transmitted to others through the contamination of food shall work at a dairy plant in any capacity which brings them into direct contact with finished products, such as pasteurized, ultra-pasteurized or aseptically processed milk or dairy products or which brings them into direct contact with associated pasteurized, ultra-pasteurized or aseptically processed dairy product-contact surfaces.

B. Dairy plant employees, or applicants to whom a conditional offer of employment has been made, shall be responsible to report to the dairy plant management if he/she:

1. is diagnosed with an illness due to Hepatitis A virus, Salmonella typhi, Shigella species, Norwalk-like viruses, Staphylococcus aureus, Streptococcus pyogenes, Escherichia coli, Campylobacter jejuni, Entamoeba histolytica, Giardia lamblia, Non-typhoidal Salmonella, Rotovirus, Taenia solium, Yersinia enterocolitica, Vibrio cholerae O1, tuberculosis or other infectious or communicable disease that has been declared by the state health officer to be transmissible to others through the handling of food, or has been clearly shown to be so based upon verifiable epidemiological data;

2. has been exposed to, or is suspected of causing, a confirmed foodborne disease outbreak of one of the diseases specified in §971, including an outbreak at an event such as a family meal, church supper or ethnic festival because the employee or applicant to whom a conditional offer of employment has been made:

- a. prepared food implicated in the outbreak;
- b. consumed food implicated in the outbreak; or
- c. consumed food at the event prepared by a person who is infected or ill.

3. lives in the same household as a person who attends or works in a day care center, school, or similar institution experiencing a confirmed outbreak of one of the diseases specified in §969.B.1 above.

C. Similarly, dairy plant employees shall be instructed by the dairy plant management to report to the dairy plant

management if the employee, or applicant to whom a conditional offer of employment has been made if he/she;

1. has a symptom associated with acute gastrointestinal illness such as diarrhea, fever, loss of appetite for three or more days, vomiting, jaundice; or

2. has a pustular lesion such as a boil or infected wound that is:

a. on the hands, wrists or exposed portions of the arms, unless the lesion is covered by a durable, moisture proof, tight-fitting barrier; or

b. on other parts of the body if the lesion is open or draining, unless the lesion is covered by a durable, moisture proof, tight-fitting barrier.

AUTHORITY NOTE: Promulgated in accordance with the provisions of R.S. 40:4(A)(1)(a). Also see R.S. 40:5(2)(3)(5)(7)(15)(17) and R.S. 40:922.

HISTORICAL NOTE: Promulgated by the Department of Health and Hospitals, Office of Public Health, LR 37:2682 (September 2011).

§971. Notification of Disease

A. Dairy plant operators and dairy plant management who have received reports, under §969, from employees who have handled pasteurized, ultra-pasteurized or aseptically processed milk, pasteurized milk products or associated product-contact surfaces shall immediately report these facts to the state health officer.

B. When a person has been reported under §969, or is otherwise known to meet one or more of the conditions listed under §969, and it is found that such person may have handled pasteurized, ultra-pasteurized or aseptically processed milk, pasteurized milk products or associated product-contact surfaces, the state health officer is authorized to require any or all the following measures:

1. the immediate restricting of that person from duties which require handling finished product such as, but not limited to, pasteurized milk or dairy products, or the handling of related product-contact surfaces. This restriction may be lifted after an appropriate medical clearance or cessation of symptoms or both, according to the following criteria in the following table;

Removal of Restrictions When Infection or High Risk of Infection is Discovered	
Health Status	Removing Restrictions
Is diagnosed with an illness due to Hepatitis A virus, <i>Salmonella typhi</i> , Shigella species, Norwalk and Norwalk-like viruses, <i>Staphylococcus aureus</i> , <i>Streptococcus pyogenes</i> , <i>Escherichia coli</i> 0157:H7, enterohemorrhagic <i>Escherichia coli</i> , enterotoxigenic <i>Escherichia coli</i> , <i>Campylobacter jejuni</i> , <i>Entamoeba histolytica</i> , <i>Giardia lamblia</i> , Non-typhoidal Salmonella, Rotavirus, <i>Taenia solium</i> , <i>Yersinia enterocolitica</i> , <i>Vibrio cholerae</i> O1, tuberculosis or other infectious or communicable disease that has been declared by the state health officer to be transmissible to others through the handling of food or has been clearly shown to be so based upon verifiable epidemiological data.	Restrictions lifted by medical clearance.
Meeting a high risk scenario as specified in §969.B.2 or 3 and/or experiencing symptoms in §969.C.1 or 2.	Restrictions lifted when symptoms cease or medical documentation is provided that infection does not exist.
Asymptomatic, but stools positive for <i>Salmonella typhi</i> , <i>Shigella</i> or <i>Escherichia coli</i> 0157:H7.	Restrictions lifted by medical clearance.
Past illness from <i>Salmonella typhi</i> , <i>Shigella</i> , <i>Escherichia coli</i> 0157:H7 or other human pathogens for which humans have been determined to be carriers.	Restrictions lifted by medical clearance.
In the case of diagnosed or suspected Hepatitis A, onset of jaundice within the last seven days.	Restrictions lifted by medical clearance.
In the case of diagnosed or suspected Hepatitis A, onset of jaundice occurred more than seven days ago.	Restrictions lifted by medical clearance or jaundice ceases.

2. the immediate exclusion of the affected dairy products from distribution and use when medically appropriate; and

3. the immediate requesting of medical and microbiological examination of the person at risk.

AUTHORITY NOTE: Promulgated in accordance with the provisions of R.S. 40:4(A)(1)(a). Also see R.S. 40:5(2)(3)(5)(7)(15)(17) and R.S. 40:922.

HISTORICAL NOTE: Promulgated by the Department of Health and Hospitals, Office of Public Health, LR 37:2683 (September 2011).

§973. Procedure when Infection Suspected

A. When suspicion arises as to the possibility of transmission of infection from any person concerned with the handling of dairy products, the state health officer is authorized to require any or all of the following measures:

1. the immediate exclusion from dairy products handling;

2. the immediate exclusion of the dairy products which may have in some manner been handled by such person from distribution and use; and

3. adequate medical and microbiological examination of the person or his associates, and of his and their body discharges or body fluids.

AUTHORITY NOTE: Promulgated in accordance with the provisions of R.S. 40:4(A)(1)(a). Also see R.S. 40:5(2)(3)(5)(7)(15)(17) and R.S. 40:922.

HISTORICAL NOTE: Promulgated by the Department of Health and Hospitals, Office of Public Health, LR 37:2683 (September 2011).

§975. Personal Cleanliness

A. All persons while coming in contact with dairy products, dairy containers, or dairy equipment shall conform to the following.

1. Clean outer garments shall be worn. Shorts shall not be worn as outer garments.

2. Hands shall be kept clean at all times.

3. Other than wedding bands, no jewelry, watches, chains, artificial nails, etc., shall be worn on hands, arms, around the neck or exposed flesh.

4. Adequate hair and facial hair covering shall be worn at all times.

5. Pens, pencils, thermometers or any other objects that may fall into product or equipment shall not be carried/worn above the level of the person's waist.

6. The use of tobacco is prohibited except in designated areas in which the use of tobacco would not have a deleterious effect upon food safety.

7. Food or drink shall not be brought into or consumed in areas in which products are being processed or where equipment or containers are being cleaned or stored.

AUTHORITY NOTE: Promulgated in accordance with the provisions of R.S. 40:4(A)(1)(a). Also see R.S. 40:5(2)(3)(5)(7)(15)(17) and R.S. 40:922.

HISTORICAL NOTE: Promulgated by the Department of Health and Hospitals, Office of Public Health, LR 37:2684 (September 2011).

§977. Allergen and Sensitivity Producing Ingredient

A. Allergens of public health significance include: eggs and egg products, milk and dairy products, peanuts and peanut products, seafood/shellfish, seeds, soy and soy products, tree nuts, wheat and wheat products and sulfites.

B. Sensitivity producing ingredients are those ingredients that cause individualistic adverse reactions other than those which result in Immunoglobulin Epsilon (I-g-E) mediated allergies.

C. Allergens and sensitivity producing ingredients shall be appropriately declared in the labeling of all foods that contain allergens and sensitivity producing ingredients.

D. The dairy plant shall take appropriate steps to preclude the contamination of products that do not contain allergens or sensitivity producing ingredients with any allergenic materials or sensitivity producing ingredients. The plant shall also take appropriate steps to insure that only

ingredients or substances that are listed in the labeling are in the final product. These steps shall include:

1. proper cleaning of all equipment used in the production of products containing allergens or sensitivity producing ingredients prior to the production of products that do not contain allergens or sensitivity producing ingredients (such as cleaning of equipment used to process egg nog prior to processing dairy products not containing egg products or cleaning equipment used to process dairy products prior to processing juices, flavoring non-dairy items, etc.); and

2. insuring that CIP systems and CIP solutions that have been used to clean equipment that was used to process products containing allergen or sensitivity producing ingredients does not contain allergen or sensitivity producing ingredients residues when used to clean or sanitize equipment to be used to process products that do not contain sensitivity producing ingredients.

AUTHORITY NOTE: Promulgated in accordance with the provisions of R.S. 40:4(A)(1)(a). Also see R.S. 40:5(2)(3)(5)(7)(15)(17) and R.S. 40:922.

HISTORICAL NOTE: Promulgated by the Department of Health and Hospitals, Office of Public Health, LR 37:2684 (September 2011).

§979. Storage of Bottled or Packaged Milk and Dairy Products

A. Bottled milk or packaged milk or dairy products, if stored in water or ice, shall be so stored that the tops of bottles or pouring spouts of cartons will not be submerged in the water or the ice, provided that milk or dairy products packaged in pouches shall not be stored in water or ice.

AUTHORITY NOTE: Promulgated in accordance with the provisions of R.S. 40:4(A)(1)(a). Also see R.S. 40:5(2)(3)(5)(7)(15)(17) and R.S. 40:922.

HISTORICAL NOTE: Promulgated by the Department of Health and Hospitals, Office of Public Health, LR 37:2684 (September 2011).

§981. Sale of Warm Milk

A. Any hotel, soda fountain, restaurant, grocery store, supermarket or similar establishment which sells or serves any milk or milk products may receive such milk or milk products at a temperature of 7°C (45°F) or less but, in any instance, shall be cooled and maintained at 5°C (41°F), provided that Ultra High Temperature (UHT) processed and packaged products are exempt from this requirement prior to being opened.

AUTHORITY NOTE: Promulgated in accordance with the provisions of R.S. 40:4(A)(1)(a). Also see R.S. 40:5(2)(3)(5)(7)(15)(17) and R.S. 40:922.

HISTORICAL NOTE: Promulgated by the Department of Health and Hospitals, Office of Public Health, LR 37:2684 (September 2011).

§983. Cleaning of Containers

A. When milk or dairy products are delivered, in multi use containers the person receiving such milk or dairy products shall thoroughly clean the containers before returning such containers.

AUTHORITY NOTE: Promulgated in accordance with the provisions of R.S. 40:4(A)(1)(a). Also see R.S. 40:5(2)(3)(5)(7)(15)(17) and R.S. 40:922.

HISTORICAL NOTE: Promulgated by the Department of Health and Hospitals, Office of Public Health, LR 37:2684 (September 2011).

§985. Rat Proofing

A. All buildings used in the production, processing and handling of dairy products shall be constructed and maintained in such a manner as to preclude rodents from entering such buildings. Effective measures shall be taken as to eliminate rodents on the outer premises of such buildings.

AUTHORITY NOTE: Promulgated in accordance with the provisions of R.S. 40:4(A)(1)(a). Also see R.S. 40:5(2)(3)(5)(7)(15)(17) and R.S. 40:922.

HISTORICAL NOTE: Promulgated by the Department of Health and Hospitals, Office of Public Health, LR 37:2684 (September 2011).

§987. Waste Disposal

A. All wastes shall be properly handled and disposed of as specified by the state health officer, in accordance with Part XXVII of the Sanitary Code.

B. Trash, solid waste and defiled dairy products shall be stored in covered, impervious, leak-proof containers in such a manner that it does not attract insects or rodents.

C. Liquid waste from stopped up or backed up drains in areas where dairy products are received, processed, handled or stored reasonably constitutes an imminent hazard to the public's health and shall be eliminated expeditiously. Dairy products in containers which have been in contact with such aforementioned wastes and trash shall not be used for human consumption.

D. The waste resulting from the cleaning, rinsing and sanitization of containers and equipment and the cleaning of floors, walls, and vehicles and any waste from flush toilet facilities shall be disposed of so as not to contaminate the products or equipment, or to create a nuisance or a public health hazard.

AUTHORITY NOTE Promulgated in accordance with the provisions of R.S. 40:4(A)(1)(a). Also see R.S. 40:5(2)(3)(5)(7)(15)(17) and R.S. 40:922.

HISTORICAL NOTE: Promulgated by the Department of Health and Hospitals, Office of Public Health, LR 37:2685 (September 2011).

§989. Vehicles

A. All vehicles used to transport dairy products in their final containers shall be constructed with permanent tops, sides, fronts and backs. Doors of a size necessary to allow the loading and unloading are permitted. The tops, sides, fronts, backs and doors or the interior of the compartment(s) in which the dairy products are transported shall be constructed of smooth, impervious and easily cleanable material. The floors of such compartments shall be constructed of metal or equally impervious materials and shall be easily cleanable and kept clean.

B. All vehicles used to transport dairy products in their final containers shall be provided with refrigeration equipment capable of cooling the ambient temperature of the compartments, in which dairy products are transported, to a temperature not to exceed 7°C (45°F).

C. The construction and operation of vehicles shall be such that dairy products are maintained at temperatures of 7°C (45°F) or less and protected from contamination.

D. Dairy products transported in vehicles with other products or materials shall be transported in a compartment(s) separated from other products or materials and maintained in such a manner as to preclude contamination of the dairy product. Provided, that the state health officer may authorize the transportation of items he may determine which are not reasonably likely to constitute a potential for contamination of the dairy products contained in the compartment.

E. The transportation of eggs or egg products, raw meat, raw poultry, raw fish or seafood in the same compartment(s) with dairy products shall be prohibited without written authorization from the state health officer. Such written authorization shall be predicated upon:

1. the state health officer's approval of a written plan, submitted by the operator, describing in detail the manner in which the dairy products will be protected from contamination;

2. the state health officer's approval of a written plan, submitted by the operator, describing, in detail, the procedures to be used by the operator to verify that the plan is being followed; and

3. failure of the operator to fulfill the requirements of the plan, shall be grounds for the seizure and condemnation of the product involved.

AUTHORITY NOTE: Promulgated in accordance with the provisions of R.S. 40:4(A)(1)(a). Also see R.S. 40:5(2)(3)(5)(7)(15)(17) and R.S. 40:922.

HISTORICAL NOTE: Promulgated by the Department of Health and Hospitals, Office of Public Health, LR 37:2685 (September 2011).

Chapter 11. Dairy Plant Hazard Analysis Critical Control Point (HACCP) Systems

§1101. Hazard Analysis Critical Control Point (HACCP) Systems

A. HACCP systems are science-based systems used to ensure that food safety hazards are controlled to prevent unsafe food from reaching the consumer.

B. HACCP Definitions

Centralized Deviation Log—a centralized log or file identifying data detailing any deviation from critical limits and the corrective actions taken as required by this document.

Control—to manage the conditions of an operation to maintain compliance with established criteria, control also means that correct procedures are being followed and criteria are being met.

Control Measure—any action or activity that can be used to prevent, eliminate, or reduce a significant hazard that is managed as a critical control point.

Control Point—any step at which biological, chemical or physical factors can be controlled.

Corrective Action—procedures followed when a deviation occurs.

Critical Control Point (CCP)—a step at which control can be applied and is essential to prevent or eliminate a food safety hazard or reduce it to an acceptable level.

Critical Limit—the value(s) to which a biological, chemical or physical parameter must be controlled at a CCP to prevent, eliminate or reduce to an acceptable level the occurrence of a food safety hazard.

Critical Listing Element—a condition that constitutes a major dysfunction likely to result in a potential compromise to food safety and shall be grounds for suspension of a permit.

Deficiency—an element inadequate or missing from the requirements of the HACCP system or of this document.

Deviation—a failure to meet a critical limit.

Hazard Analysis Critical Control Point (HACCP)—a systematic approach to the identification, evaluation and control of significant dairy products safety hazards.

HACCP Plan—the written document which is based upon the principles of HACCP and which delineates the procedures to be followed.

HACCP System—the implemented HACCP plan and pre-requisite programs including other applicable NCIMS requirements contained in the PMO.

HACCP Team—the group of people within, employed by a facility or assisting, who are responsible for developing, implementing and maintaining the HACCP system.

Hazard—a biological, chemical or physical agent that is reasonably likely to cause illness or injury in the absence of its control.

Hazard Analysis—the process of collecting and evaluating information on hazards associated with the food under consideration to decide which are significant and must be addressed in the HACCP plan.

Listing Audit—an evaluation conducted by a certified milk sanitation rating officer (that has been standardized and certified as a HACCP listing officer by FDA) using the methodology prescribed in the *Methods of Making Sanitation Rating of Milk Shippers* of the entire dairy facility to ensure compliance with Chapter 11 of this Part.

Monitor—to conduct a planned sequence of observations or measurements to assess whether a CCP is

under control or to assess the conditions and practices of all required Pre-requisite Programs (PPs) and to produce an accurate record for future use in verification.

Non-Conformity—a failure to meet specified requirements of the HACCP system or of this document.

Pre-Requisite Program (PP)—procedures, including good manufacturing practices, that address operational conditions providing the foundation for the HACCP system.

Potential Hazard—any hazard to be evaluated by the hazard analyses.

Validation—the element of verification focused on collecting and evaluating scientific and technical information to determine whether the HACCP plan, when properly implemented, will effectively control the hazards.

Verification—those activities, other than monitoring, that determine the validity of the HACCP plan and that the system is operating according to the plan.

AUTHORITY NOTE: Promulgated in accordance with the provisions of R.S. 40:4(A)(1)(a). Also see R.S. 40:5(2)(3)(5)(7)(15)(17) and R.S. 40:922.

HISTORICAL NOTE: Promulgated by the Department of Health and Hospitals, Office of Public Health, LR 37:2685 (September 2011).

§1103. General Requirements

A. All dairy plants, including cheese manufacturing plants and frozen dessert manufacturing plants, that are required by this Part or have been required or authorized by the state health officer to implement HACCP systems shall develop and implement HACCP systems conforming with the requirements of this Chapter.

B. The state health officer shall require that dairy plants, including cheese manufacturing plants and frozen dessert manufacturing plants, implement a HACCP system that conforms with the requirements of this Part, when in his opinion, it is in the best interest of the public health. Each dairy plant's HACCP system, when implemented shall provide a level of product safety equivalent to the level provided by similar dairy plants that are being regulated under the provisions of other Chapters of this Part.

C. Dairy plants being regulated under the provisions of this Chapter shall comply with the following provisions of the requirements contained in this Part:

1. permits (in accordance with §109 of this Part);
2. permits required for imported milk, milk products and frozen desserts (in accordance with 111 of this Part);
3. requirements for imported dairy products (in accordance with §113 of this Part);
4. milk records (in accordance with §115 of this Part);
5. falsification of records (in accordance with §117 of this Part);
6. registration (in accordance with §119 of this Part);
7. labeling (in accordance with §121 of this Part);

8. delivery of samples (in accordance with §303 of this Part);

9. pasteurization equipment tests, examination and sealing (in accordance with §313 of this Part);

10. grades of milk and milk products to be sold (in accordance with §323 of this Part);

11. procedures in emergency (in accordance with §325 of this Part);

12. continuous grading (in accordance with §327 of this Part);

13. application for regrading, reinstatement of permit and permission to resume sale of product (in accordance with §341 of this Part);

14. Grade A raw milk for pasteurization (in accordance with §349 of this Part);

15. Grade A raw milk for pasteurization (certified for interstate milk shipment) (in accordance with §351 of this Part);

16. manufacturing grade raw milk for pasteurization (milk for manufacturing purpose) (in accordance with §353 of this Part);

17. Grade A pasteurized, ultra-pasteurized and aseptically processed milk and milk products, bulk shipped Grade A pasteurized or ultra-pasteurized milk and milk products and pasteurized filled milk and filled milk products (in accordance with §355 of this Part);

18. Grade A bulk shipped, heat-treated milk and milk products (in accordance with §357 of this Part);

19. Grade A aseptically processed milk and milk products (in accordance with §359 of this Part);

20. Grade A pasteurized, ultra-pasteurized and aseptically processed milk and milk products certified for interstate shipment (in accordance with §361 of this Part);

21. milk tank trucks (in accordance with §701 of this Part);

22. sealing and protection of milk tank trucks (in accordance with §703 of this Part);

23. labeling (in accordance with §705 of this Part);

24. bulk milk tank truck operator/sampler (in accordance with §707 of this Part);

25. general requirements (in accordance with §901 of this Part);

26. approval of plans (in accordance with §903 of this Part);

27. dairy plant receivers/samplers (in accordance with §907 of this Part);

28. sale of reconstituted or recombined milk or milk products and anomalous (substitute) milk or milk products (in accordance with §959 of this Part);

29. use of inhibitors (in accordance with §961 of this Part);

30. dipping or transferring dairy products (in accordance with §965 of this Part); and

31. vehicles (in accordance with §989 of this Part).

D. The state health officer may authorize dairy plants that request permission to be regulated under the provisions of this Part to be regulated in such a manner.

E. Following are the seven HACCP principles to be included in a HACCP Plan:

1. conduct a hazard analysis for each product and process;

2. determine critical control points;

3. establish critical limits;

4. establish monitoring procedures;

5. establish corrective actions;

6. establish verification procedures; and,

7. establish record-keeping and documentation procedures.

F. Dairy plants regulated under the provisions of this Part shall perform the following HACCP Preliminary Steps:

1. Assemble a multi-disciplinary HACCP team of plant/consultant personnel.

a. Team responsibilities:

i. develop and update all written documentation;

ii. implement HACCP program;

iii. periodically verify and validate HACCP system;

iv. provide opportunities for necessary training;

v. maintain effective communication with plant management; and,

vi. interact with regulatory personnel during audits/inspections.

2. Describe the product and its distribution.

a. product description to include composition, safety characteristics, water activity, pH, and temperature requirements;

b. list of ingredients and packaging materials;

c. processing methods;

d. method of distribution; and,

e. distribution condition including frozen, refrigerated, shelf-stable.

3. Identify the intended use and consumers.

a. intended use-ingredient, retail, institutional;

b. intended and likely consumers—children, adults, elderly, healthy, sick, teenagers; and,

c. distribution area—local, regional, nationwide, international.

4. Construct a flow diagram for each product/like product and each type of process, raw materials, packaging, sequence of all processing steps including addition of rework, use of air or gases, filters, screens, clarifiers, metal detectors, storage and distribution.

5. Conduct on-site verification of each flow diagram to (each product type and process shall have a different flow diagram) ensure that the intended flow diagram is accurate, complete and is the actual flow of products through the processing flow.

AUTHORITY NOTE: Promulgated in accordance with the provisions of R.S. 40:4(A)(1)(a). Also see R.S. 40:5(2)(3)(5)(7)(15)(17) and R.S. 40:922.

HISTORICAL NOTE: Promulgated by the Department of Health and Hospitals, Office of Public Health, LR 37:2686 (September 2011).

§1105. Pre-requisite Programs (PPs)

A. HACCP is not a stand-alone program but is part of a larger control system. PPs are the universal procedures used to control the conditions of the plant environment that contribute to the overall safety of the product. They represent the sum of programs, practices and procedures that must be applied to produce and distribute safe products in a clean, sanitary environment. They differ from CCPs in that they are background programs that reduce the potential for the occurrence of a food safety hazard. Frequently, both HACCP plan CCPs and PPs control measures are necessary to control a food safety hazard.

B. HACCP may be implemented only in a facility that is constructed and operated in a manner that provides a sanitary environment. Dairy plant premises, building construction, maintenance and housekeeping shall be maintained in a manner sufficient to provide such an environment.

C. Dairy plants that are required to develop and implement HACCP systems by this Part shall develop and implement the following pre-requisite programs that conform with the following requirements prior to the implementation of the HACCP Plan:

1. safety of the water, steam or ice that comes into contact with food or food contact surfaces;

2. condition and cleanliness of the food contact surfaces of equipment;

3. prevention of cross-contamination from insanitary objects and or practices to food products, packaging material and other food contact surfaces, including utensils, gloves, outer garments, etc., and from raw product to processed product (e.g., pasteurizer pressure differential);

4. maintenance of hand washing, hand sanitizing and toilet facilities;

5. protection of food, food packaging material and food contact surfaces from adulteration with lubricants, fuel, pesticides, cleaning compounds, sanitizing agents, condensate and other chemical, physical and biological contaminants;

6. proper labeling, storage and use of toxic compounds;

7. control of employee health conditions that could result in the microbiological contamination of food, food packaging materials and food contact surfaces; and,

8. pest exclusion from the food plant.

D. Each dairy plant shall monitor the conditions and practices of all required PPs with sufficient frequency to ensure conformance with those conditions and that are appropriate both to the plant and to the safety of the food being processed. Each milk plant, receiving station or transfer station shall correct those conditions and practices that are not in conformance.

E. Each dairy plant shall maintain records that document the ongoing application of the PPs including a brief written description, monitoring and correction records.

F. In addition to the required prerequisite programs, any other prerequisite programs that are being relied upon in the hazard analysis to reduce the likelihood of hazards such that they are not reasonably likely to occur shall also be monitored and documented.

AUTHORITY NOTE: Promulgated in accordance with the provisions of R.S. 40:4(A)(1)(a). Also see R.S. 40:5(2)(3)(5)(7)(15)(17) and R.S. 40:922.

HISTORICAL NOTE: Promulgated by the Department of Health and Hospitals, Office of Public Health, LR 37:2687 (September 2011).

§1107. Hazard Analysis

A. Each dairy plant shall develop, or have developed for it, a written hazard analysis to determine whether there are food hazards that are reasonably likely to occur for each type of dairy product processed by that dairy plant, receiving station or transfer station and to identify the control measures that the dairy plant, receiving station or transfer station can apply to control those hazards.

B. The plant shall develop or have developed for it a hazard analysis each time a product, product ingredient or process is added or changed.

C. The hazard analysis shall include hazards that can be introduced both within and outside the processing plant environment, including hazards that can occur during production, transportation, processing and distribution.

D. The hazard analysis shall be submitted in writing to the state health officer for approval prior to processing of a product or change of process for which the hazard analysis was made.

E. A hazard that is reasonably likely to occur is one for which a prudent dairy plant operator would establish controls because experience, illness data, scientific reports or

other information provide a basis to conclude that there is a reasonable possibility that, in the absence of these controls, the hazard will occur in the particular type of product being processed. The hazard analysis shall be developed by an individual(s) trained in accordance with this program and shall be subject to the record keeping requirement as described in this document.

1. In evaluating what food hazards are reasonably likely to occur, at a minimum, consideration should be given to the following:

- a. microbiological contamination;
- b. parasites;
- c. chemical contamination;
- d. unlawful drug and pesticide residues;
- e. natural toxins;
- f. unapproved use of food or color additives;
- g. presence of undeclared ingredients that may be allergens or sensitivity producing ingredients; and
- h. physical hazards.

2. Dairy plant operators shall evaluate product ingredients, processing procedures, packaging, storage and intended use; facility and equipment function and design; and plant sanitation including employee hygiene to determine the potential effect of each on the safety of the finished product for the intended consumer.

AUTHORITY NOTE: Promulgated in accordance with the provisions of R.S. 40:4(A)(1)(a). Also see R.S. 40:5(2)(3)(5)(7)(15)(17) and R.S. 40:922.

HISTORICAL NOTE: Promulgated by the Department of Health and Hospitals, Office of Public Health, LR 37:2688 (September 2011).

§1109. HACCP Plan

A. Dairy plants that are required by the state health officer to implement a HACCP system or have authorization from the state health officer to be regulated under the provisions of this Chapter shall have and implement a written HACCP plan whenever a hazard analysis reveals one or more hazards that are reasonably likely to occur. The HACCP plan shall be developed by an individual(s) who meets the requirements contained in the PMO and shall be subject to record keeping requirements as described in this Code. A HACCP plan shall be specific to each location and product. The plan may group types of products together, or group types of production methods together, if the hazards, critical control points, critical limits and procedures required for each are essentially identical and that any required features of the plan that are unique to a specific product or method are clearly delineated in the plan and are observed in practice.

B. Written HACCP plans shall be submitted to the state health officer for review and approval prior to processing a product addressed by the plan and prior to processing a new product or making changes in a product or the manner in

which a product is processed. Such review and approval shall be performed by a registered sanitarian that meets the PMO requirements for auditing HACCP plants.

C. The HACCP plan shall, at a minimum:

1. include complete up-to-date process flow diagrams for all products manufactured. Flow diagrams may be combined when process, products and hazards are similar;

2. list all hazards that are reasonably likely to occur as identified in the hazard analysis specified above, and that must be controlled for each type of product;

3. list the critical control points for each of the identified hazards, including the appropriate:

a. critical control points designed to control hazards that could occur or could be introduced in the plant environment;

b. critical control points designed to control hazards introduced outside the plant environment, including hazards that occur before arriving at the dairy plant, receiving station or transfer station; and,

c. critical control points for pasteurization as described in *Appendix H*, Section VIII of the PMO (Milk and milk products HACCP CCP models for pasteurization equipment);

4. list the critical limits that shall be met at each of the critical control points;

5. list the procedures, and the frequency with which they are to be performed, that will be used to monitor each of the critical control points to ensure compliance with the critical limits;

6. include any corrective action plans that have been developed in accordance with the corrective action requirements as described in this document, and that are to be followed in response to deviations from critical limits at critical control points;

7. list the verification procedures and the frequency with which they are to be performed, that the dairy plant will use in accordance with verification and validation requirements as described in this Part;

8. provide for a record keeping system that documents the monitoring of the critical control points in accordance with the record requirements as described in this Part. The records shall contain the actual values and observations obtained during monitoring.

D. Sanitation. Sanitation controls may be included in the HACCP plan. However, to the extent that they are monitored in accordance with the pre-requisite programs, they need not be included in the HACCP plan.

AUTHORITY NOTE: Promulgated in accordance with the provisions of R.S. 40:4(A)(1)(a). Also see R.S. 40:5(2)(3)(5)(7)(15)(17) and R.S. 40:922.

HISTORICAL NOTE: Promulgated by the Department of Health and Hospitals, Office of Public Health, LR 37:2688 (September 2011).

§1111. Corrective Actions

A. Whenever a deviation from a critical limit occurs, a dairy plant shall take corrective action as follows.

1. Dairy plants may develop written corrective action plans, which become part of their Hazard Analysis and Critical Control Point (HACCP) plans, in accordance with this Part, by which dairy plants predetermine the corrective actions that they will take whenever there is a deviation from a critical limit. A corrective action plan that is appropriate for a particular deviation is one that describes the steps to be taken and assigns responsibility for taking those steps, to ensure that:

a. no product enters commerce that is either injurious to health or is otherwise adulterated as a result of the deviation.

b. if such product has entered commerce, it is expeditiously removed; and,

c. the cause of the deviation is corrected.

2. When a deviation from critical limit occurs, and the dairy plant does not have a corrective action plan that is appropriate for that deviation, the dairy plant shall:

a. segregate and hold the affected product.

b. perform or obtain a review to determine the acceptability of the affected product for distribution. The review shall be performed by an individual or individuals qualified by training or experience to perform such a review.

c. take corrective action, when necessary, with respect to the affected product to ensure that no product enters commerce that is either injurious to health or is otherwise adulterated as a result of the deviation.

d. take corrective action, when necessary, to correct the cause of the deviation; and,

e. perform or obtain timely validation as required in this document, by a qualified individual(s), to determine whether modification of the HACCP plan is required to reduce the risk of recurrence of the deviation, and modify the HACCP plan as necessary.

3. All corrective action taken in accordance with this Section shall be fully documented in records that are subject to verification.

AUTHORITY NOTE: Promulgated in accordance with the provisions of R.S. 40:4(A)(1)(a). Also see R.S. 40:5(2)(3)(5)(7)(15)(17) and R.S. 40:922.

HISTORICAL NOTE: Promulgated by the Department of Health and Hospitals, Office of Public Health, LR 37:2689 (September 2011).

§1113. Verification and Validation

A. Every dairy plant shall verify that the hazard analysis and critical control point (HACCP) system is being implemented according to design:

1. verification activities shall include:

a. the calibration of CCP process-monitoring instruments, (pasteurization tests, thermometers, etc.) and instruments/equipment used to monitor PPs;

b. a review, including signing and dating, by an individual who has been trained in accordance with the training requirements contained in this Part, of the records that document:

i. the monitoring of CCPs. The purpose of the monitoring of CCPs review shall be, at a minimum, to ensure that the records are complete and to verify that the records document values that are within the critical limits. This review shall occur at a frequency that is appropriate to the importance of the record and as specified in the HACCP plan;

ii. the taking of corrective actions. The purpose of corrective actions review shall be, at a minimum, to ensure that the records are complete and to verify that appropriate corrective actions were taken in accordance with the corrective action requirements of §1111 of this Part. This review shall occur at a frequency that is appropriate to the importance of the record. A centralized deviation log is required; and

iii. the calibrating of any process monitoring instruments used at CCPs and the performance of any periodic end-product or in-process testing that is part of the dairy plant, receiving station or transfer station's verification activities. The purpose of the calibrating of any process monitoring instruments used at CCPs and the performance of any periodic end-product or in-process testing that is part of the dairy plant reviews shall be, at a minimum, to ensure that the records are complete and that these activities occurred in accordance with the dairy plant written procedures. These reviews shall occur within a reasonable time after the records are made;

c. the taking of corrective action procedures whenever any verification procedure establishes the need to take a corrective action;

2. the calibration of CCP process-monitoring instruments, and the performance of any periodic end-product and in-process testing shall be documented in records that are subject to the record keeping requirements in this Part.

B. Validation of the HACCP Plan. Every dairy plant shall validate that the HACCP plan is adequate to control hazards that are reasonably likely to occur. This validation shall occur at least once within 12 months after implementation and at least annually thereafter or whenever any changes in the process occur that could affect the hazard analysis or alter the HACCP plan and prerequisite program.

1. Such changes may include raw materials or source of raw materials; product formulation; processing methods or systems, including computers and their software; packaging; finished product distribution systems; or the intended use or intended consumers of the finished product. Consumer complaints may also reveal a need for validation.

2. The validation shall be performed by a qualified individual(s) and shall be subject to the record keeping requirements of §1115 of this Part. The HACCP plan shall be modified immediately whenever a validation reveals that the plan is no longer adequate to fully meet the requirements of this Part.

C. Validation of the hazard analysis. Whenever a dairy plant has no HACCP plan because a hazard analysis has revealed no hazards that are reasonably likely to occur, the dairy plant shall reassess the adequacy of the hazard analysis whenever there are any changes in the process that could reasonably affect whether a hazard exists.

1. Such changes may include raw materials; product formulation; processing methods or systems, including computers and their software; packaging; finished product distribution systems; or the intended use or intended consumers of the finished product and consumer complaints.

2. The validation shall be performed by a qualified individual(s) trained in accordance with the training requirements of this Part.

AUTHORITY NOTE: Promulgated in accordance with the provisions of R.S. 40:4(A)(1)(a). Also see R.S. 40:5(2)(3)(5)(7)(15)(17) and R.S. 40:922.

HISTORICAL NOTE: Promulgated by the Department of Health and Hospitals, Office of Public Health, LR 37:2689 (September 2011).

§1115. Records

A. Dairy plants shall use consistent terminology to identify each piece of equipment, record, document or program throughout their written HACCP system. Dairy plants shall maintain the following records documenting the dairy plant, receiving station or transfer station's hazard analysis and critical control point (HACCP) system:

1. records documenting the ongoing application of the pre-requisite programs, including a brief written description monitoring and correction records;

2. the written hazard analysis;

3. the written HACCP plan;

4. records documenting the ongoing application of the HACCP plan that include:

a. monitoring of critical control points and their critical limits, including the recording of actual times, temperatures, or other measurements, as prescribed in the establishment's HACCP plan; and

b. corrective actions, including all actions taken in response to a deviation; and a centralized deviation log is required.

5. records documenting verification of the HACCP system and validation of the HACCP system including, HACCP plan, hazard analysis and pre-requisite programs; and

6. Records and documents shall be dated and each page of documents and forms marked with a new date or version number whenever updated.

B. General Requirements. All records required by this Part shall include:

1. the identity and location of the dairy plant, receiving station or transfer station;

2. the date and time of the activity that the record reflects;

3. the signature or initials of the person(s) performing the operation or creating the record; and,

4. where appropriate, the identity of the product and the production code, if any. Processing and other information shall be entered on records at the time that it is observed. The records shall contain the actual values and observations obtained during monitoring.

C. Documentation. The records in §1115.A.1-3 shall be signed and dated by the most responsible individual onsite at the dairy plant, receiving station or transfer station. These signatures shall signify that these records have been accepted by the firm.

1. The records in §1115.A.1-3 shall be signed and dated:

a. upon initial acceptance;

b. upon any modification; and

c. upon verification and validation in accordance with the requirements of §1113 of this Part.

D. Record Retention. In the case of perishable or refrigerated products, all records required by this Part shall be retained at the dairy plant facility for at least one year after the date that such products were prepared and, in the case of frozen, preserved, or shelf - stable products, two years or the shelf life of the product, whichever is greater, after the date that the products were prepared unless longer retention time is required by other regulations.

1. Records that relate to the adequacy of equipment or processes used, such as commissioning or process validation records, including the results of scientific studies and evaluations, shall be retained at the dairy plant facility for at least two years after the date that the dairy plant, receiving station or transfer station last used such equipment or process.

2. Off-site storage of processing records is permitted after six months following the date that the monitoring occurred, if such records can be retrieved and provided on-site within 24 hours of request for official review. Electronic records are considered to be on-site if they are accessible from an on-site location.

3. If the processing facility is closed for a prolonged period, the records may be transferred to some other reasonably accessible location but shall be immediately returned to the processing facility for official review upon request by the state health officer.

E. Official review. All records required by this Section shall be available for official review by the state health officer.

F. Records maintained on a computer. The maintenance of records on computer, in accordance with the above, is acceptable.

AUTHORITY NOTE: Promulgated in accordance with the provisions of R.S. 40:4(A)(1)(a). Also see R.S. 40:5(2)(3)(5)(7)(15)(17) and R.S. 40:922.

HISTORICAL NOTE: Promulgated by the Department of Health and Hospitals, Office of Public Health, LR 37:2690 (September 2011).

§1117. Training and Standardization

A. HACCP training for industry and state regulatory personnel shall be based on the August 14, 1997 “Hazard Analysis and Critical Control Points Principles and Application Guidelines” of the U.S. National Advisory Committee on Microbiological Criteria for Foods (NACMCF), current FDA and NCIMS HACCP requirements and the requirements of this Part. State regulatory personnel responsible for auditing dairy plants being regulated under this Part shall have the training required to inspect dairy plants and specialized training in conducting HACCP System Audits that is approved by the FDA.

B. Only industry personnel who have received the training requirements contained in §1117.A shall be responsible for the following functions:

1. developing the hazard analysis including delineating control measures as required;
2. developing a HACCP plan that is appropriate for each individual dairy plant;
3. validating and modifying the HACCP Plan in accordance with the corrective action procedures and the validation activities contained in this Part; and,
4. performing required HACCP plan record reviews.

AUTHORITY NOTE: Promulgated in accordance with the provisions of R.S. 40:4(A)(1)(a). Also see R.S. 40:5(2)(3)(5)(7)(15)(17) and R.S. 40:922.

HISTORICAL NOTE: Promulgated by the Department of Health and Hospitals, Office of Public Health, LR 37:2690 (September 2011).

§1119. Audit of Dairy Plants that Operate under the HACCP Systems Defined in this Part

A. Procedures that shall be used by the state health officer in the audit of dairy plants which are required to implement HACCP Systems:

1. conduct a pre-audit management interview during which he shall review and discuss the plant HACCP system including:
 - a. changes in management structure;
 - b. the hazard analysis—ensure that all food hazards are addressed;

- c. changes in the HACCP plan;
- d. changes in the prerequisite programs (PPs);
- e. changes in the flow diagrams; and
- f. changes in products or process;

2. review past audit reports and correction of deficiencies;

3. perform a comprehensive in-plant review of the facilities, equipment, operations and implementation of the HACCP system;

4. review records of the implementation of the plant’s HACCP system;

5. review the plant’s compliance with other applicable requirements of this Part including:

- a. raw milk supply source;
- b. labeling compliance;
- c. adulteration;
- d. permit requirements;
- e. drug residue testing;
- f. regulatory sample compliance; and
- g. pasteurization equipment design, construction and operation;

6. conduct an exit interview with plant management and the plant HACCP team, which includes:

- a. discussing the findings and observations;
- b. establishing time lines for the correction of all identified deficiencies and non conformities; and
- c. preparing and issuing the audit report;

7. take appropriate action to verify that all deficiencies have been corrected within the established time frame as soon as practical after the established time or date;

8. take immediate action when an imminent health hazard is observed to prevent further movement of products until such hazards have been eliminated;

9. initiate regulatory enforcement such as permit suspension, revocation or other equivalent measures when the dairy plant has failed to recognize or correct a deficiency or non conformity;

10. critical listing elements. It is essential that each regulatory audit includes a thorough review of each of the critical listing elements of the plant’s HACCP System;

a. Deficiencies or non conformities related to Critical Listing Elements require immediate attention and constitute grounds for suspension of the permit;

b. The following are critical listing elements:

i. hazard analysis—flow diagram and a hazard analysis has been conducted and written for each kind or

group of dairy products, including frozen desserts, which are processed;

ii. HACCP plan—a written HACCP plan prepared for each kind or group of dairy products, including frozen desserts, which are processed;

iii. HACCP plan—critical limits (CL) are adequate to control the hazard identified.

iv. HACCP plan—corrective action taken for products produced during a deviation from the critical limits defined in the plan;

v. HACCP plan—verification and validation—calibration of CCP process monitoring instruments and equipment was performed as required and at the frequency defined in the plan;

vi. HACCP system records—information on HACCP records were not falsified;

vii. Other NCIMS requirements—in coming milk supply from NCIMS listed source(s) with sanitation scores of 90 or better or acceptable HACCP Listing;

viii. other NCIMS requirements—drug residue control program implemented; and,

ix. HACCP system audit findings—follow up action—no major HACCP system dysfunction exists, but if a series of observations made during an audit indicate that a plant does not have sufficient control of its HACCP system or operations to prevent a compromise to food safety, this shall constitute grounds for immediate suspension of permit.

AUTHORITY NOTE: Promulgated in accordance with the provisions of R.S. 40:4(A)(1)(a). Also see R.S. 40:5(2)(3)(5)(7)(15)(17) and R.S. 40:922.

HISTORICAL NOTE: Promulgated by the Department of Health and HospLR 28:1277 (June 2002), amended LR 37:2691 (September 2011).

Chapter 13. Receiving Stations

§1301. Receiving Station Requirements

A. Receiving stations that are required or have been authorized by the state health officer to be regulated under the HACCP requirements of this Part, shall conform with each of the HACCP requirements contained in Chapter 11 of this Part.

B. Receiving stations shall comply with the applicable provisions of the following general requirements for dairy plants:

1. permits (in accordance with §109 of this Part);
2. permits required for imported milk, milk products and frozen desserts (in accordance with §111 of this Part);
3. requirements for imported dairy products (in accordance with §113 of this Part);
4. milk records (in accordance with §115 of this Part);
5. falsification of records (in accordance with §117 of this Part);
6. delivery of samples (in accordance with §303 of this Part);
7. the official sampling, of dairy plant environments and dairy products including frozen desserts (in accordance with §307 of this Part);
8. posting inspection reports (in accordance with §317 of this Part);
9. field supervision (in accordance with §319 of this Part);
10. grades of milk and milk products to be sold (in accordance with §323 of this Part);
11. application for regrading, reinstatement of permit and permission to resume sale of product (in accordance with §341 of this Part);
12. grade A raw milk for pasteurization (in accordance with §349 of this Part);
13. manufacturing grade raw milk for pasteurization (milk for manufacturing purpose) (in accordance with §353 of this Part);
14. grade A pasteurized, ultra-pasteurized and aseptically processed milk and milk products, bulk shipped grade A pasteurized or ultra-pasteurized milk and milk products and pasteurized filled milk and filled milk products (in accordance with §355 of this Part);
15. grade A bulk shipped, heat-treated milk and milk products (in accordance with §357 of this Part);
16. milk tank trucks (in accordance with §701 of this Part);
17. sealing and protection of milk tank trucks (in accordance with §703 of this Part);
18. labeling (in accordance with §705 of this Part);
19. general requirements (in accordance with §901 of this Part);
20. raw milk receiving (in accordance with §905 of this Part);
21. dairy plant receivers/samplers (in accordance with §907 of this Part);
22. receiving and handling of milk derived and non-dairy ingredients (in accordance with §909 of this Part);
23. immediate surroundings (in accordance with §911 of this Part);
24. floors (in accordance with §913 of this Part);
25. walls and ceilings (in accordance with §915 of this Part);
26. doors and windows (in accordance with §917 of this Part);

27. light and ventilation (in accordance with §919 of this Part);
28. separate rooms (in accordance with §921 of this Part);
29. toilet facilities (in accordance with §923 of this Part);
30. water supply (in accordance with §925 of this Part);
31. protection from contamination (in accordance with §929 of this Part);
32. reclaim or rework operations (in accordance with §931 of this Part);
33. dairy plant cleanliness (in accordance with §933 of this Part);
34. sanitary piping (in accordance with §935 of this Part);
35. construction and repair of containers and equipment (in accordance with §937 of this Part);
36. thermometers (in accordance with §939 of this Part);
37. cleaning and sanitization of containers and equipment (in accordance with §943 of this Part);
38. storage of single-service containers, utensils and materials (in accordance with §947 of this Part);
39. cooling of milk and dairy products (in accordance with §955 of this Part);
40. use of inhibitors (in accordance with §961 of this Part);
41. apparatus, containers, equipment and utensils (in accordance with §967 of this Part);
42. personnel health (in accordance with §969 of this Part);
43. notification of disease (in accordance with §971 of this Part);
44. procedure when infection suspected (in accordance with §973 of this Part);
45. personal cleanliness (in accordance with §975 of this Part);
46. cleaning of containers (in accordance with §983 of this Part);
47. rat proofing (in accordance with §985 of this Part); and
48. waste disposal (in accordance with §987 of this Part).

AUTHORITY NOTE: Promulgated in accordance with the provisions of R.S. 40:4(A)(1)(a). Also see R.S. 40:5(2)(3)(5)(7)(15)(17) and R.S. 40:922.

HISTORICAL NOTE: Promulgated by the Department of Health and Hospitals, Office of Public Health, LR 37:2693 (September 2011).

Chapter 15. Transfer Stations

§1501. Transfer Station Requirements

A. Transfer stations that are required or have been authorized by the state health officer to be regulated under the HACCP requirements of this Part, shall conform with each of the HACCP requirements contained in Chapter 11 of this Part.

B. Transfer stations shall comply with the applicable provisions of the following general requirements for dairy plants:

1. permits (in accordance with §109 of this Part);
2. permits required for imported milk, milk products and frozen desserts (in accordance with §111 of this Part);
3. requirements for imported dairy products (in accordance with §113 of this Part);
4. milk records (in accordance with §115 of this Part);
5. falsification of records (in accordance with §117 of this Part);
6. delivery of samples (in accordance with §303 of this Part);
7. the official sampling of dairy plant environments and dairy products including frozen desserts (in accordance with §307 of this Part);
8. posting inspection reports (in accordance with §317 of this Part);
9. field supervision (in accordance with §319 of this Part);
10. grades of milk and milk products to be sold (in accordance with §323 of this Part);
11. application for regrading, reinstatement of permit and permission to resume sale of product (in accordance with §341 of this Part);
12. grade A raw milk for pasteurization (in accordance with §349 of this Part);
13. manufacturing grade raw milk for pasteurization (milk for manufacturing purpose) (in accordance with §353 of this Part);
14. grade A pasteurized, ultra-pasteurized and aseptically processed milk and milk products, bulk shipped grade A pasteurized or ultra-pasteurized milk and milk products and pasteurized filled milk and filled milk products (in accordance with §355 of this Part);
15. grade A bulk shipped, heat-treated milk and milk products (in accordance with §357 of this Part);
16. milk tank trucks (in accordance with §701 of this Part);
17. sealing and protection of milk tank trucks (in accordance with §703 of this Part);
18. labeling (in accordance with §705 of this Part);

19. general requirements (in accordance with §901 of this Part);
20. approval of plans (in accordance with §903 of this Part);
21. raw milk receiving (in accordance with §905 of this Part);
22. confined space entry (in accordance with §905(D) of this Part);
23. dairy plant receivers/samplers (in accordance with §907 of this Part);
24. immediate surroundings (in accordance with §911 of this Part);
25. floors (in accordance with §913 of this Part);
26. light and ventilation (in accordance with §919 of this Part);
27. toilet facilities (in accordance with §923 of this Part);
28. water supply (in accordance with §925 of this Part);
29. hand washing facilities (in accordance with §927 of this Part);
30. protection from contamination (in accordance with §929 of this Part);
31. dairy plant cleanliness (in accordance with §933 of this Part);
32. sanitary piping (in accordance with §935 of this Part);
33. construction and repair of containers and equipment (in accordance with §937 of this Part);
34. thermometers (in accordance with §939 of this Part);
35. cleaning and sanitization of containers and equipment (in accordance with §943 of this Part);
36. storage of single-service containers, utensils and materials (in accordance with §947 of this Part);
37. cooling of milk and dairy products (in accordance with §955 of this Part);
38. notification of disease (in accordance with §971 of this Part);
39. personal cleanliness (in accordance with §975 of this Part);
40. rat proofing (in accordance with §985 of this Part);
41. waste disposal (in accordance with §987 of this Part); and
42. vehicles (in accordance with §989 of this Part).

AUTHORITY NOTE: Promulgated in accordance with the provisions of R.S. 40:4(A)(1)(a). Also see R.S. 40:5(2)(3)(5)(7)(15)(17) and R.S. 40:922.

HISTORICAL NOTE: Promulgated by the Department of Health and Hospitals, Office of Public Health, LR 37:2694 (September 2011).

Chapter 17. Finished Dairy Products Depots and Transfer Points

§1701. Approval of Plans

A. All finished dairy product depots or finished dairy product transfer points that are domiciled within the state and which are hereafter constructed, reconstructed or altered shall conform to the requirements contained in this Chapter. Prior to construction, reconstruction or alteration of such facilities, written approval of plans and specifications shall be obtained from the state health officer.

AUTHORITY NOTE: Promulgated in accordance with the provisions of R.S. 40:4(A)(1)(a). Also see R.S. 40:5(2)(3)(5)(7)(15)(17) and R.S. 40:922.

HISTORICAL NOTE: Promulgated by the Department of Health and Hospitals, Office of Public Health, LR 37:2695 (September 2011).

§1703. Basic Requirements for Finished Dairy Product Depots

A. Finished product depots shall conform with the following general requirements for dairy plants:

1. permits (in accordance with §109 of this Part);
2. permits required for imported milk, milk products and frozen desserts (in accordance with §111 of this Part);
3. requirements for imported dairy products (in accordance with §113 of this Part);
4. milk records (in accordance with §115 of this Part);
5. falsification of records (in accordance with §117 of this Part);
6. registration (in accordance with §119 of this Part);
7. labeling (in accordance with §121 of this Part);
8. delivery of samples (in accordance with §303 of this Part);
9. posting inspection reports (in accordance with §317 of this Part);
10. grades of milk and milk products to be sold (in accordance with §323 of this Part);
11. application for regrading, reinstatement of permit and permission to resume sale of product (in accordance with §341 of this Part);
12. regrading or reinstatement of permit when degrade or suspension was based on laboratory analyses (in accordance with §343 of this Part);
13. regrading and reinstatement of permit when degrade or suspension was based on physical violations (in accordance with §345 of this Part);
14. general requirements (in accordance with §901 of this Part);

15. approval of plans (in accordance with §903 of this Part);
16. receiving and handling of milk derived and non-dairy ingredients (in accordance with §909 of this Part);
17. immediate surroundings (in accordance with §911 of this Part);
18. floors (in accordance with §913 of this Part);
19. walls and ceilings (in accordance with §915 of this Part);
20. light and ventilation (in accordance with §919 of this Part);
21. toilet facilities (in accordance with §923 of this Part);
22. water supply (in accordance with §925 of this Part);
23. hand washing facilities (in accordance with §927 of this Part);
24. protection from contamination (in accordance with §929 of this Part);
25. reclaim or rework operations (in accordance with §931 of this Part);
26. dairy plant cleanliness (in accordance with §933 of this Part);
27. thermometers (in accordance with §939 of this Part);
28. cooling of milk and dairy products (in accordance with §955 of this Part);
29. use of overflow, leaked, spilled or mishandled dairy products (in accordance with §957 of this Part);
30. sale of reconstituted or recombined milk or milk products and anomalous (substitute) milk or milk products (in accordance with §959 of this Part);
31. dipping or transferring dairy products (in accordance with §965 of this Part);
32. personal health (in accordance with §969 of this Part);
33. notification of disease (in accordance with §971);
34. procedure when infection suspected (in accordance with §973 of this Part);
35. storage of bottled or packaged milk and dairy products (in accordance with §979 of this Part);
36. sale of warm milk (in accordance with §981 of this Part);
37. rat proofing (in accordance with §985 of this Part);
38. waste disposal (in accordance with §987 of this Part); and
39. vehicles (in accordance with §989 of this Part).

AUTHORITY NOTE: Promulgated in accordance with the provisions of R.S. 40:4(A)(1)(a). Also see R.S. 40:5(2)(3)(5)(7)(15)(17) and R.S. 40:922.

HISTORICAL NOTE: Promulgated by the Department of Health and Hospitals, Office of Public Health, LR 37:2695 (September 2011).

§1705. Basic Requirements for Finished Dairy Product Transfer Points

A. Finished dairy product transfer points shall conform with the following general requirements for dairy plants:

1. permits (in accordance with §109 of this Part);
2. permits required for imported milk, milk products and frozen desserts (in accordance with §111 of this Part);
3. requirements for imported dairy products (in accordance with §113 of this Part);
4. milk records (in accordance with §115 of this Part);
5. falsification of records (in accordance with §117 of this Part);
6. labeling (in accordance with §121 of this Part);
7. delivery of samples (in accordance with §303 of this Part);
8. grades of milk and milk products to be sold (in accordance with §323 of this Part);
9. application for regrading, reinstatement of permit and permission to resume sale of product (in accordance with §341 of this Part);
10. immediate surroundings (in accordance with §911 of this Part);
11. toilet facilities (in accordance with §923 of this Part);
12. water supply (in accordance with §925 of this Part);
14. thermometers (in accordance with §939 of this Part);
15. sale of reconstituted or recombined milk or milk products and anomalous (substitute) milk or milk products (in accordance with §959 of this Part);
16. storage of bottled or packaged milk and dairy products (in accordance with §979 of this Part);
17. sale of warm milk (in accordance with §981 of this Part);
18. rat proofing (in accordance with §985 of this Part);
19. waste disposal (in accordance with §987 of this Part); and
20. vehicles (in accordance with §989 of this Part).

AUTHORITY NOTE: Promulgated in accordance with the provisions of R.S. 40:4(A)(1)(a). Also see R.S. 40:5(2)(3)(5)(7)(15)(17) and R.S. 40:922.

HISTORICAL NOTE: Promulgated by the Department of Health and Hospitals, Office of Public Health, LR 37:2696 (September 2011).

Chapter 19. Milk Tank Truck Cleaning Facilities

§1901. Approval of Plans

A. All milk tank truck cleaning facilities that are hereafter constructed, reconstructed or altered in the state shall conform to the requirements of these regulations. Written approval shall be obtained from the state health officer of plans and specifications prior to construction, reconstruction or alteration.

B. Prior to installation or modification, written approval of plans and specifications for the design, construction and the employment of equipment shall be obtained from the state health officer.

AUTHORITY NOTE: Promulgated in accordance with the provisions of R.S. 40:4(A)(1)(a). Also see R.S. 40:5(2)(3)(5)(7)(15)(17) and R.S. 40:922.

HISTORICAL NOTE: Promulgated by the Department of Health and Hospitals, Office of Public Health, LR 37:2696 (September 2011).

§1903. Basic Requirements for Milk Tank Truck Cleaning Facilities

A. All milk tank truck cleaning facilities shall conform with the following general requirements for dairy plants:

1. permits (in accordance with §109 of this Part);
2. falsification of records (in accordance with §117 of this Part);
3. application for regrading, reinstatement of permit and permission to resume sale of product (in accordance with §341 of this Part);
4. general requirements (in accordance with §901 of this Part);
5. immediate surroundings (in accordance with §911 of this Part);
6. floors (in accordance with §913 of this Part);
7. light and ventilation (in accordance with §919 of this Part);
8. toilet facilities (in accordance with §923 of this Part);
9. water supply (in accordance with §925 of this Part);
10. hand washing facilities (in accordance with §927 of this Part);
11. protection from contamination (in accordance with §929 of this Part);
12. dairy plant cleanliness (in accordance with §933 of this Part);
13. sanitary piping (in accordance with §935 of this Part);
14. construction and repair of containers and equipment (in accordance with §937 of this Part);

15. thermometers (in accordance with §939 of this Part);

16. cleaning and sanitization of containers and equipment (in accordance with §943 of this Part);

17. storage of cleaned containers and equipment (in accordance with §945 of this Part);

18. storage of single-service containers, utensils and materials (in accordance with §947 of this Part);

19. use of overflow, leaked, spilled or mishandled dairy products (in accordance with §957 of this Part);

20. apparatus, containers, equipment and utensils (in accordance with §967 of this Part);

21. personal cleanliness (in accordance with §975 of this Part);

22. allergen control and sensitivity producing ingredient (in accordance with §977 of this Part); and

23. waste disposal (in accordance with §987 of this Part).

AUTHORITY NOTE: Promulgated in accordance with the provisions of R.S. 40:4(A)(1)(a). Also see R.S. 40:5(2)(3)(5)(7)(15)(17) and R.S. 40:922.

HISTORICAL NOTE: Promulgated by the Department of Health and Hospitals, Office of Public Health, LR 37:2697 (September 2011).

§1905. Supplemental Requirements for Milk Tank Truck Cleaning Facilities

A. Milk tank truck cleaning facilities shall conform with the following additional requirements.

1. Milk tank truck cleaning facilities shall clean or sanitize tank trucks that transport food grade products only. The cleaning or sanitization of any tank truck, tote or any type of container that has contained products that are not food grade is prohibited.

2. All equipment used in the cleaning and sanitization of milk tank trucks shall be dedicated to the cleaning and sanitization of milk tank trucks and shall not be used in the cleaning and sanitization of tank trucks that transport other food grade products without written approval of the state health officer.

3. Each dairy facility (including dairy plants, receiving stations, transfer stations and milk tank truck cleaning facilities) that cleans and sanitizes milk tank trucks shall be equipped with approved, functional equipment, devices, etc., and provide all services and programs necessary to satisfy the confined space entry safety requirements of the Occupational Safety and Health Administration (OSHA) thereby permitting personnel to safely enter the interior of the milk tank trucks. The dairy facility shall allow the state health officer to use all such equipment, devices, services, and programs, etc., and shall provide the state health officer with any assistance necessary to enable the state health officer (or his authorized representative) to safely enter and inspect the interior of the

milk tank trucks. Dairy facilities, as identified above, which fail to provide the state health officer with any assistance necessary and required under OSHA regulations to safely enter and inspect the interior of milk tank trucks or other confined spaces may be held liable should the safety of the state health officer (or his authorized representative) be in peril while inside of milk tank trucks.

AUTHORITY NOTE: Promulgated in accordance with the provisions of R.S. 40:4(A)(1)(a). Also see R.S. 40:5(2)(3)(5)(7)(15)(17) and R.S. 40:922.

HISTORICAL NOTE: Promulgated by the Department of Health and Hospitals, Office of Public Health, LR 37:2697 (September 2011).

Chapter 21. Dairy Products Condensing, Dairy Products Concentrating, Dairy Products Drying or Dry Dairy Products Blending Plants

§2101. Approval of Plans

A. All dairy product condensing, concentrating, drying or blending plants that are domiciled within the State and in which condensed, concentrated or dry dairy products are condensed, concentrated, dried or blended and which are hereafter constructed, reconstructed or altered shall conform in their construction to the requirements contained in Chapter 9 of this Part. Prior to construction, reconstruction or alteration, written approval of plans and specifications shall be obtained from the state health officer.

B. Prior to installation or modification, written approval shall be obtained from the state health officer of plans and specifications for the design, construction and manner of employment for all equipment.

C. Written, detailed plans describing the processing of each product shall be submitted to the state health officer for approval prior to product manufacture and prior to any product or process change.

AUTHORITY NOTE: Promulgated in accordance with the provisions of R.S. 40:4(A)(1)(a). Also see R.S. 40:5(2)(3)(5)(7)(15)(17) and R.S. 40:922.

HISTORICAL NOTE: Promulgated by the Department of Health and Hospitals, Office of Public Health, LR 37:2697 (September 2011).

§2103. Basic Requirements for Condensed, Concentrated, Dry and Blended Dry Dairy Products and Dairy Plants that Condense, Concentrate, Dry or Blend Dry Dairy Products

A. Dairy plants which condense, concentrate, dry or blend dry dairy products which are required or have been authorized by the state health officer to be regulated under the HACCP requirements of this Part shall conform with each of the HACCP requirements contained in Chapter 11 of this Part.

B. Dairy plants that condense, concentrate, dry or blend dry dairy products shall conform with the following general requirements for dairy plants:

1. definitions (in accordance with §101 of this Part);
2. standards of identity (in accordance with , §107 of this Part);
3. permits (in accordance with §109 of this Part);
4. permit required for imported milk; milk products and frozen desserts (in accordance with , §111 of this Part);
5. requirements for imported dairy products (in accordance with §113 of this Part);
6. milk records (in accordance with §115 of this Part);
7. falsification of records (in accordance with §117 of this Part);
8. registration (in accordance with §119 of this Part);
9. labeling (in accordance with §§121 and 2121 of this Part);
10. delivery of samples (in accordance with §303 of this Part);
11. pasteurization equipment tests, examinations and sealing (in accordance with §313 of this Part);
12. posting inspection reports (in accordance with §317 of this Part);
13. grading (in accordance with §321 of this Part);
14. grades of milk and milk products to be sold (in accordance with §323 of this Part);
15. application for regrading, reinstatement of permit and permission to resume sale of product (in accordance with §341 of this Part);
16. regrading and reinstatement of permit when degrade or suspension was based on physical violations (in accordance with §345 of this Part);
17. reinstatement of permit when suspension was based upon adulteration of product or contamination of pasteurized product or cheeses with pathogenic microorganisms of human significance (in accordance with §347 of this Part);
18. grade A raw milk for pasteurization (in accordance with §349 of this Part);
19. grade A raw milk for pasteurization (certified for interstate milk shipment) (in accordance with §351 of this Part);
20. grade A pasteurized, ultra-pasteurized and aseptically processed milk and milk products, bulk shipped grade A pasteurized or ultra-pasteurized milk and milk products and pasteurized filled milk and filled milk products (in accordance with §355 of this Part);
21. grade A pasteurized, ultra-pasteurized and aseptically processed milk and milk products certified for interstate shipment (in accordance with §361 of this Part);

22. milk tank trucks (in accordance with §701 of this Part);
23. sealing and protection of milk tank trucks (in accordance with §703 of this Part);
24. general requirements (in accordance with §901 of this Part);
25. approval of plans (in accordance with §903 of this Part);
26. raw milk receiving (in accordance with §905 of this Part);
27. receiving and handling of milk derived and non-dairy ingredients (in accordance with §909 of this Part);
28. immediate surroundings (in accordance with §911 of this Part);
29. floors (in accordance with §913 of this Part);
30. walls and ceilings (in accordance with §915 of this Part);
31. doors and windows (in accordance with §917 of this Part);
32. light and ventilation (in accordance with §919 of this Part);
33. separate rooms (in accordance with §921 of this Part);
34. toilet facilities (in accordance with §923 of this Part);
35. water supply (in accordance with §925 of this Part);
36. hand washing facilities (in accordance with §927 of this Part);
37. protection from contamination (in accordance with §929 of this Part);
38. reclaim or rework operations (in accordance with §931 of this Part);
39. dairy plant cleanliness (in accordance with §933 of this Part);
40. sanitary piping (in accordance with §935 of this Part);
41. construction and repair of containers and equipment (in accordance with §937 of this Part);
42. thermometers (in accordance with §939 of this Part);
43. pasteurization, ultra-pasteurization and aseptic processing (in accordance with §941 of this Part);
44. cleaning and sanitization of containers and equipment (in accordance with §943 of this Part);
45. storage of cleaned containers and equipment (in accordance with §945 of this Part);

46. storage of single-service containers, utensils and materials (in accordance with §947 of this Part);
47. packing, bottling and wrapping (in accordance with §949 of this Part);
48. cooling of milk and dairy products (in accordance with §955 of this Part);
49. use of overflow, leaked, spilled or mishandled dairy products (in accordance with §957 of this Part);
50. sale of reconstituted or recombined milk or milk products and anomalous (substitute) milk or milk products (in accordance with §959 of this Part);
51. use of inhibitors (in accordance with §961 of this Part);
52. dipping or transferring dairy products (in accordance with §965 of this Part);
53. apparatus, containers, equipment and utensils (in accordance with §967 of this Part);
54. personnel health (in accordance with §969 of this Part);
55. notification of disease (in accordance with §971 of this Part);
56. procedure when infection suspected (in accordance with §973 of this Part);
57. personal cleanliness (in accordance with §975 of this Part);
58. allergen and sensitivity producing ingredient (in accordance with §977 of this Part);
59. cleaning of containers (in accordance with §983 of this Part);
60. rat proofing (in accordance with §985 of this Part);
61. waste disposal (in accordance with §987 of this Part); and
62. vehicles (in accordance with §989 of this Part).

AUTHORITY NOTE: Promulgated in accordance with the provisions of R.S. 40:4(A)(1)(a). Also see R.S. 40:5(2)(3)(5)(7)(15)(17) and R.S. 40:922.

HISTORICAL NOTE: Promulgated by the Department of Health and Hospitals, Office of Public Health, LR 37:2698 (September 2011).

Subchapter A. Supplemental Requirements for Dairy Plants that Condense, Concentrate, Dry or Blend Dry Dairy Products

§2105. General Requirements

A. In addition to the requirements for dairy plants, all dairy plants that condense, concentrate, dry or blend dry dairy products shall conform with the additional requirements contained in this Subchapter.

B. Pasteurization, ultra-pasteurization or aseptic processing shall be performed in accordance with the requirements for pasteurization or ultra-pasteurization contained in the PMO.

C. In all cases, pasteurization, ultra-pasteurization or aseptic processing of raw milk, raw milk products, whey or whey products shall be performed before any raw milk, raw milk products, whey or whey products enter the evaporator, reverse-osmosis, ultra-filtration or condensing equipment and shall be performed in the plant in which the evaporation or condensing is done.

D. All condensed/concentrated milk transported to a dairy products drying plant shall be re-pasteurized at the plant at which it is dried. When condensed whey contains at least 40 percent total solids and has been partially crystallized by cooling, it may be transported to a separate drying plant for drying without re-pasteurization provided, the following conditions are complied with:

1. The condensed/concentrated, partially crystallized whey shall be cooled and maintained at 7°C (45°F) or less;

2. Milk transport tanks used to transport the condensed/concentrated, partially crystallized whey shall be cleaned and sanitized prior to filling and are sealed after filling until unloaded; and,

3. Separate unloading pumps and pipelines shall be provided and used only for the unloading of the condensed/concentrated, partially crystallized whey. Such pumps and pipelines shall be cleaned and sanitized as a separate cleaning circuit.

E. All monitoring devices, such as metal detectors, etc., shall be calibrated at the frequency recommended by the manufacturer with the concurrence of the FDA.

AUTHORITY NOTE: Promulgated in accordance with the provisions of R.S. 40:4(A)(1)(a). Also see R.S. 40:5(2)(3)(5)(7)(15)(17) and R.S. 40:922.

HISTORICAL NOTE: Promulgated by the Department of Health and Hospitals, Office of Public Health, LR 37:2699 (September 2011).

§2107. Cleaning and Sanitizing of Containers and Equipment

A. The product contact surfaces of all multi-use containers and equipment used in the processing, drying, storing, handling and transporting of milk, milk products, dairy products, whey, whey products, condensed or dry milk and buttermilk shall be properly cleaned and sanitized before each use. Each dairy plant that condenses, concentrates, dries or blends dry dairy products shall develop and implement effective cleaning and sanitizing programs based upon the recommendations of the manufacturer of the equipment and the recommendations contained in the PMO, Appendix F. Each dairy plant handling dry or blended dry dairy products shall be equipped with a heavy duty industrial type vacuum cleaner, so designed as not to recontaminate the atmosphere for cleaning areas in which powder accumulates.

B. Non-product contact surfaces of utensils and equipment shall be kept clean.

C. Effective cleaning and sanitizing regimen instructions, including solution mixing directions, solution strength requirements, testing and recording procedures, temperature requirements, circulation times and all other pertinent information necessary to properly clean and sanitize equipment, shall be posted adjacent to all equipment used in cleaning and sanitizing dairy equipment.

D. The posted procedures and instructions shall be followed in the cleaning and sanitization of dairy equipment.

E. Storage tanks shall be cleaned and sanitized when emptied and shall be emptied at least every 72 hours provided, that the state health officer may with the concurrence of FDA authorize an interval greater than 72 hours, determined on a case by case basis.

F. Drying equipment, blending equipment, cloth-collector systems, packaging equipment and multi-use dry dairy products and dry whey storage containers shall be cleaned at intervals and by methods recommended by the manufacturer or the PMO, Appendix F and approved by the state health officer. Such methods may include cleaning without water by use of vacuum cleaners, brushes or scrapers; such equipment and brushes shall be used exclusively for cleaning product contact surfaces. After cleaning, such equipment is sanitized by a method approved by the state health officer. Cloth collector systems and all dry product contact surfaces downstream from the dryer shall be sanitized or purged at intervals and by methods recommended by the manufacturer and approved by the state health officer. Sanitary single service outer clothing and shoe covers shall be provided for personnel and worn exclusively when it is necessary to enter the interior of the dryer to perform the cleaning operation.

G. Storage bins or totes used to transport dry products shall be dry cleaned after each usage and wet-cleaned and sanitized at regular intervals.

H. Pipelines and equipment designed for mechanical cleaning shall meet the following requirements:

1. operating instructions shall be posted near the cleaning equipment and shall be followed;

2. a temperature recording device, complying with the requirements contained in the PMO or a recording device which has been approved by the FDA and found to provide sufficient information to adequately evaluate the cleaning and sanitizing regimen and which is approved by the state health officer, shall be installed in the return solution line or other appropriate area to record the temperature and time during which the line or equipment is exposed to cleaning and sanitizing solutions;

3. pipelines and equipment designed for automated mechanical cleaning of evaporators shall have a pH recording device in the return lines to record the pH and time which the line or equipment is exposed during cleaning and sanitizing operations. These charts shall be identified, dated

and initialed by the operator and maintained for three months;

4. temperature and pH recording charts shall be signed, dated and retained for three months;

5. during each inspection, the state health officer shall examine and initial a representative sample of each type of temperature recording charts to verify the time of exposure to solutions and their temperatures.

I. All multi-use containers, equipment, and utensils shall be sanitized before use, employing one or a combination of the following methods or any other method which has been demonstrated to be equally efficient and has been approved by the state health officer:

1. exposure to an enclosed jet of steam for not less than one minute;

2. complete immersion in hot water at a temperature of at least 77°C (170°F), for at least five minutes or exposure to a flow of hot water at a temperature of at least 77°C (170°F), as determined by use of a suitable accurate thermometer located at the outlet, for at least five minutes;

3. exposure to hot air at a temperature of at least 83°C (180°F) for at least 20 minutes as measured by an acceptable indicating thermometer located in the coldest zone;

4. complete immersion for at least one minute in, or exposure for at least one minute to a flow of a chemical sanitizer of acceptable strength. All product-contact surfaces must be wetted by the sanitizing solution, and piping so treated must be filled. Sanitizing sprays may be used. Chemical solutions, once used, shall not be reused for sanitizing but may be reused for other purposes approved by FDA. Assembled equipment shall be sanitized prior to each day's run;

5. All thermometers and temperature recorders shall be calibrated at least once every three-month period and a log identifying the thermometers calibrated, date and the initials of the person performing the calibration shall be maintained and made available to the state health officer; and

6. All other monitoring devices and equipment such as metal detectors, etc., shall be calibrated at the frequency recommended by the manufacturer and a log identifying the device or equipment calibrated, date calibrated, the name and initials of the person performing the calibration shall be maintained and made available to the state health officer.

AUTHORITY NOTE: Promulgated in accordance with the provisions of R.S. 40:4(A)(1)(a). Also see R.S. 40:5(2)(3)(5)(7)(15)(17) and R.S. 40:922.

HISTORICAL NOTE: Promulgated by the Department of Health and Hospitals, Office of Public Health, LR 37:2699 (September 2011).

§2109. Packaging and Container Filling

A. The filling of condensed and dry dairy product containers shall be done only by mechanical equipment and by methods which preclude contamination.

B. Approval in writing by the state health officer, shall be obtained prior to the installation, operation or modification of any such equipment.

C. Dry dairy products shall be packaged in unused single service containers, which protect the contents from contamination. These containers shall be obtained from a source approved by the state health officer and after packaging shall be stored in a sanitary manner.

D. Condensed and dry dairy product containers shall be stored in a sanitary manner.

E. Condensed and dry dairy products may be transported from one plant to another for further processing or packaging, provided that the products are transported in sealed containers whose construction conforms with 3-A Standards.

AUTHORITY NOTE: Promulgated in accordance with the provisions of R.S. 40:4(A)(1)(a). Also see R.S. 40:5(2)(3)(5)(7)(15)(17) and R.S. 40:922.

HISTORICAL NOTE: Promulgated by the Department of Health and Hospitals, Office of Public Health, LR 37:2700 (September 2011).

§2111. Container Closure, Sealing and Storage

A. Closing or sealing of dry dairy products shall be done in a sanitary manner.

B. The closing and sealing of containers of sizes of 6 gallons (net contents) or less shall be done in mechanical equipment, approved by the state health officer, using methods which preclude product contamination.

AUTHORITY NOTE: Promulgated in accordance with the provisions of R.S. 40:4(A)(1)(a). Also see R.S. 40:5(2)(3)(5)(7)(15)(17) and R.S. 40:922.

HISTORICAL NOTE: Promulgated by the Department of Health and Hospitals, Office of Public Health, LR 37:2700 (September 2011).

§2113. Cooling of Milk, Milk Products, Whey, Whey Products, and Condensed Dairy Products

A. All raw milk and dairy products shall be maintained at 7°C (45°F) or less until processed except that acid-type whey with a titratable acidity of 0.40 percent or above, or a pH of 4.6 or below, is exempted from these temperature requirements.

B. All whey and whey products for condensing or drying shall be maintained at a temperature of 7°C (45°F) or less; or 57°C (135°F) or greater until processed. Storage tanks containing whey and whey products above 7°C (45°F) and below 57°C (135°F) shall be emptied, cleaned and sanitized after each four hours of use or less.

1. Whey and whey products in balance (constant level) tanks or hot wells may be allowed to remain at temperatures above 7°C (45°F) and below 57°C (135°F) for a period not to exceed four hours.

2. The balance tank or hot well shall be emptied, cleaned and sanitized at least once each four hours of operation.

3. Whey and whey products in balance tanks or hot wells that are maintained at temperatures of 57°C (135°F) or above are exempt from the four hour cleaning and sanitizing requirement as long as a continuous flow is maintained (with a retention time not to exceed one hour). All such balance tanks or hot wells shall be cleaned and sanitized at least once every 24 hours.

C. All pasteurized milk and dairy products (including pasteurized whey and condensed dairy products), except those to be dried immediately, shall be cooled immediately in approved equipment to a temperature of 7°C (45°F) or less. All pasteurized milk and dairy products (including pasteurized whey and condensed dairy products), shall be stored at a temperature of 7°C (45°F) or less and be maintained thereat until further processing. Whenever pasteurized milk and dairy products are to be condensed and/or dried and storage tanks are used between the condenser and dryer, any such storage tank(s) containing pasteurized milk or milk products (including pasteurized whey and condensed dairy products), stored above 7°C (45°F) and below 57°C (135°F) shall be completely emptied, cleaned, and sanitized after four hours of operation or less.

D. All indicating and recording thermometers shall be calibrated at least once each three-month period and a log indicating each thermometer and recorder calibrated and the initials of the person performing the calibration shall be maintained and made available to the state health officer.

E. All condensed whey and whey products shall be cooled during the crystallization process to 7°C (45°F) or less, within 72 hours of condensing including the filling and emptying time, unless filling occurs above 57°C (135°F), in which case, the 72 hour time period begins when the cooling is started.

F. Each refrigerated room in which milk, dairy products or whey are stored shall be equipped with an indicating thermometer approved by the state health officer. Such thermometer shall be located in the warmest zone of the refrigerator room.

G. Each storage tank shall be equipped with an indicating thermometer, the sensor of which shall be located to permit the registering of the temperature of the contents when the tank contains no more than 20 percent of its calibrated capacity.

H. All surface coolers shall comply with the following specifications:

1. The section of open-surface coolers shall be so installed as to leave a gap of at least 6.4 millimeters (0.25 inch) between the header sections to permit easy cleaning;

2. Where header ends are not completely enclosed within the cooler covers, condensation or leakage from the headers shall be prevented from entering the product by so shaping the exposed header faces, above and below all gaps, that condensation is directed away from the tubes, and by using deflectors at the bottom of the headers, or by

shortening the bottom trough or by some other approved method;

3. The location of supports of cooler sections shall prevent drip from entering the milk or dairy products; and,

4. All open surface coolers shall be provided with tight-fitting shields which protect the product from contamination by flies, dust, drip, splash or manual contact.

I. Re-circulated cooling water which is used in coolers and exchangers, including those systems in which a freezing point depressant is used, shall be from a safe source and protected from contamination. Such water shall be tested at the minimum frequencies specified in §2117 of this Part and shall otherwise comply with the requirements of §2117 of this Part. Re-circulated water systems which become contaminated through repair work or otherwise shall be properly treated and tested before being returned to use. Freezing point depressants, when used in re-circulating systems, shall be non-toxic.

AUTHORITY NOTE: Promulgated in accordance with the provisions of R.S. 40:4(A)(1)(a). Also see R.S. 40:5(2)(3)(5)(7)(15)(17) and R.S. 40:922.

HISTORICAL NOTE: Promulgated by the Department of Health and Hospitals, Office of Public Health, LR 37:2700 (September 2011).

§2115. Separate Rooms

A. There shall be separate rooms for:

1. pasteurizing, processing, cooling, condensing, drying and blending of milk, dairy products, whey, whey products, buttermilk or condensed products;

2. packaging or filling of bulk bins, drums, bags or other bulk containers;

3. hopper or dump room for the transfer of bulk dry dairy products from bags or drums to the hoppers or conveyors which lead to the container fillers;

4. repackaging room for the filling of small packages with dry dairy products from bulk containers;

5. cleaning of milk cans and containers and dry product containers;

6. receiving cans of milk and dairy products in plants receiving cans of milk;

7. receiving milk, cleaning and sanitizing milk tank trucks in plants receiving milk or whey in tank trucks; and

8. boilers and other non-processing mechanical equipment and shop areas.

B. Rooms in which milk, dairy products, whey or whey products are handled, processed, stored, dried, condensed or in which containers, utensils and equipment are cleaned or stored, shall not open directly into any stable, farmstead or area in which meat, poultry or any non-dairy foods of animal origin are handled or stored or any room used for domestic purposes.

C. All rooms shall be of sufficient size for their intended purposes.

AUTHORITY NOTE: Promulgated in accordance with the provisions of R.S. 40:4(A)(1)(a). Also see R.S. 40:5(2)(3)(5)(7)(15)(17) and R.S. 40:922.

HISTORICAL NOTE: Promulgated by the Department of Health and Hospitals, Office of Public Health, LR 37:2701 (September 2011).

§2117. Reclaimed Water_{ap}

A. Condensing water for dairy product evaporators, and water used to produce vacuum or to condense vapors in vacuum heat processing equipment, shall be from a source complying with §925.B.1 of this Part. Provided, that when approved by the state health officer, water from sources not complying with §925.B.1 of this Part may be used when the condenser or vacuum heat equipment is constructed and operated to preclude contamination of such equipment, or its

contents, by condensing water or by water used to produce vacuum. Means of preventing such contamination include:

1. use of a surface type condenser in which the condensing water is physically separated from the vapors and condensate; or

2. use of reliable safeguards to prevent the overflow of condensing water from the condenser into the evaporator. Such safeguards include a barometric leg extending at least 35 feet vertically from the invert of the outgoing condensing water line to the free level at which the leg discharges, and/or a safety shutoff valve, located on the water feed line to the condenser, automatically actuated by a control which will shutoff the in-flowing water when the water level rises above a predetermined point in the condenser. This valve may be actuated by water, air or electricity, and shall be designed so that failure of the primary motivating power will automatically stop the flow of water into the condenser.

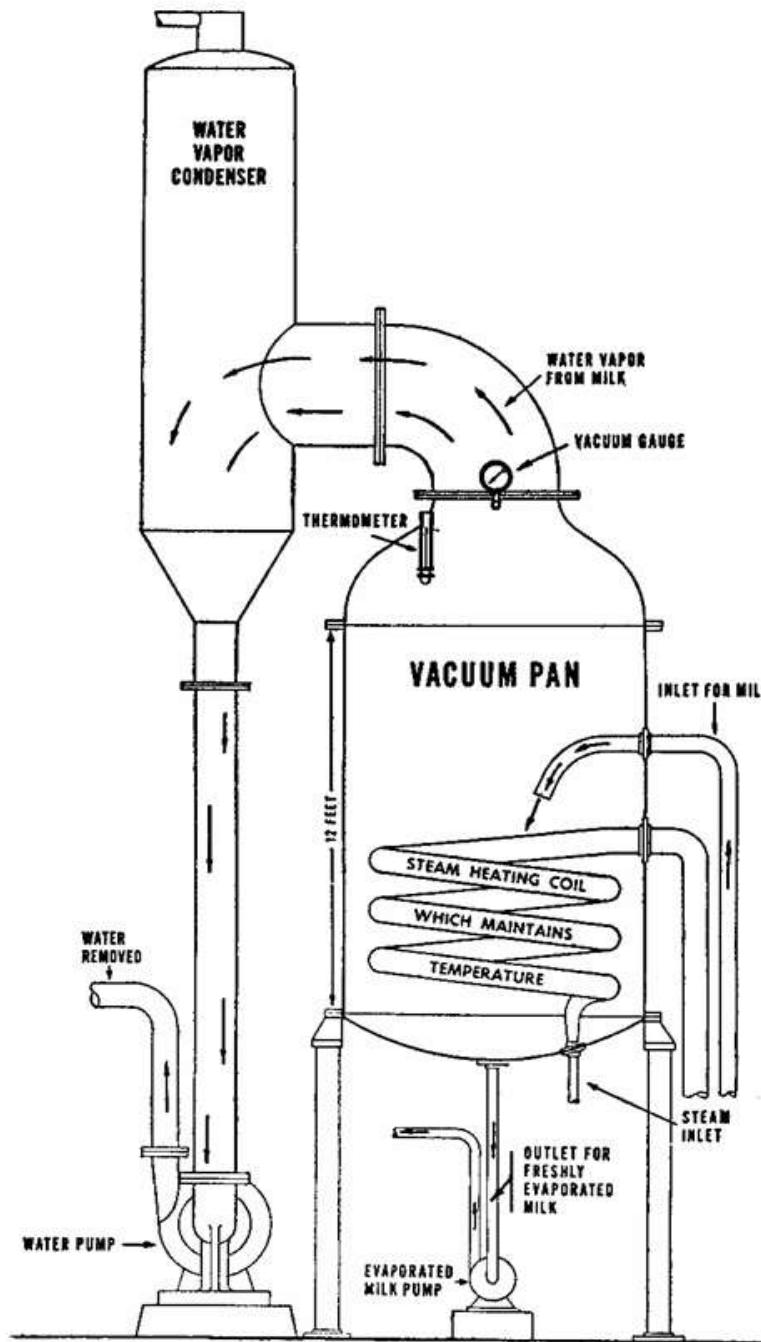

VACUUM PAN DETAIL
(For Informational Purposes Only)

FIGURE 2117.A

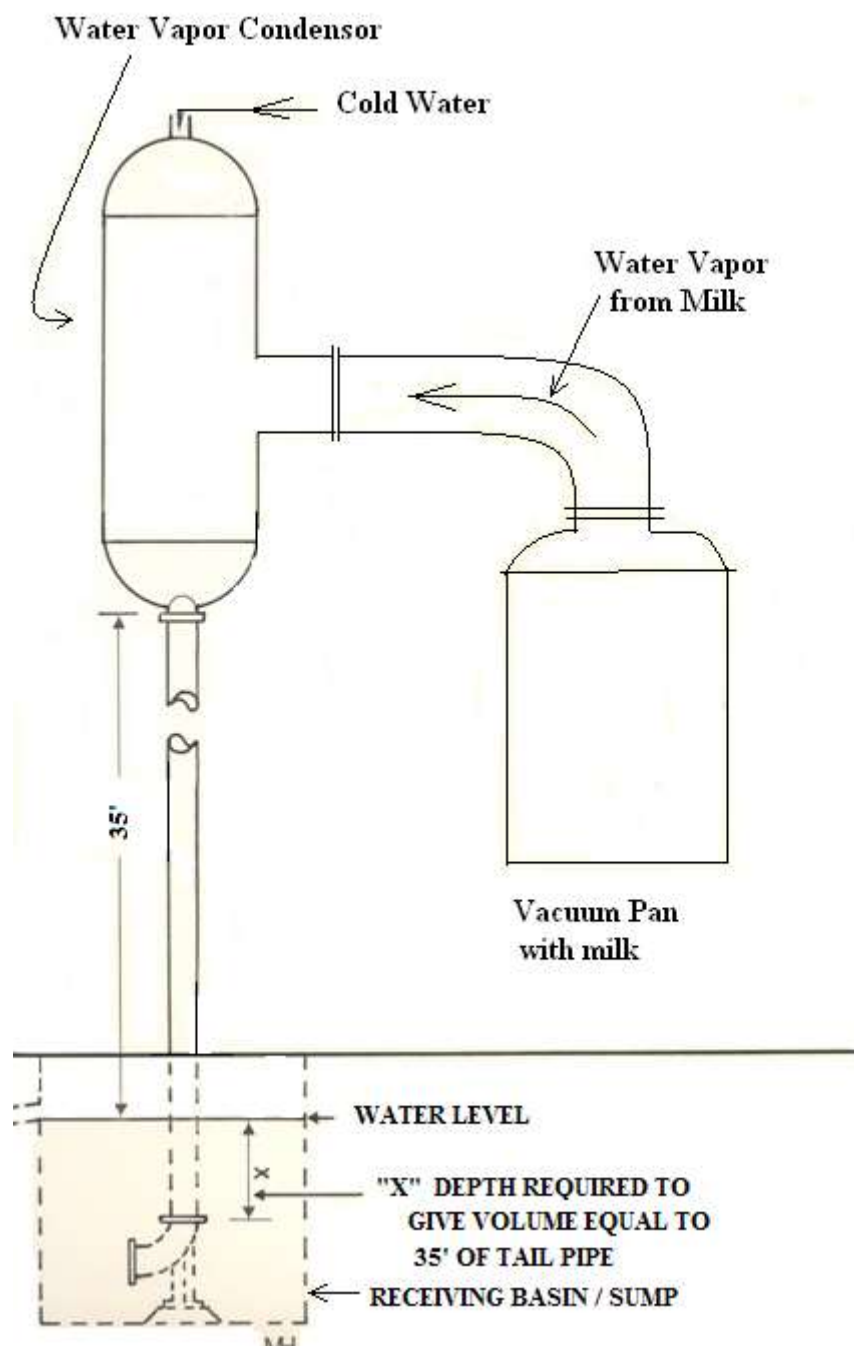

BAROMETRIC LEG DETAIL (For Informational Purposes Only)

FIGURE 2117.A.2

B. Condensing water for dairy product evaporators complying with this Section and water reclaimed from milk or dairy products may be reused when all necessary means of protection are afforded and it complies with the procedures outlined in this Part and the PMO.

C. Reclaimed water_{dp} shall comply with the following requirements:

1. Reclaimed water_{dp} shall comply with the bacteriological standards of Appendix G, Section I of the PMO.

2. Samples of reclaimed water_{dp} shall be collected daily for two weeks following initial approval of the installation and semi-annually thereafter, provided, that daily tests shall be conducted for one week following any repairs or alterations to the system.

3. The organic content of reclaimed water_{dp} shall be less than 12.0 milligrams per liter as measured by the chemical oxygen demand or permanganate consumed test; or a standard turbidity of less than 5.0 units.

4. Automatic fail-safe monitoring devices shall be used to monitor and automatically divert to the sewer any reclaimed water_{dp} which exceeds the standards.

5. The reclaimed water_{dp} shall be of satisfactory organoleptic quality and shall have no off-flavors, odors or slime formations.

6. The reclaimed water_{dp} shall be sampled and tested organoleptically at weekly intervals.

7. Approved chemicals, such as chlorine, with suitable detention period may be used to suppress the development of bacterial growth and prevent the development of tastes and odors in reclaimed water_{dp}.

8. The addition of approved chemicals shall be by an automatic proportioning device prior to the reclaimed water_{dp} entering the storage tank to assure satisfactory quality reclaimed water_{dp} in the storage tank at all times.

9. When chemicals are added, a daily testing program for such added chemicals shall be in effect and shall not add substances that will prove deleterious to use of the reclaimed water_{dp} or contribute to product contamination.

10. The storage vessel shall be properly constructed of such material that it will not contaminate the reclaimed water_{dp} and can be satisfactorily cleaned.

11. The distribution system within a plant for such reclaimed water_{dp} shall be a separate system with no cross-connections to a municipal or private water system or any other potable water distribution system.

12. All physical, chemical, radiological and microbiological tests on the reclaimed water_{dp} shall be conducted in accordance with the latest edition of *Standard Methods for the Examination of Water and Wastewater*.

D. When §2117.C.1 through §2117.C.12 of this Section are satisfied and documented, reclaimed water_{dp} may be used for the following limited applications:

1. pre-rinsing of the product contact surfaces where pre-rinses will not be used in food products; and,

2. cleaning solution make-up water; provided that for either of these uses, the following additional items are complied with:

a. there is no carry-over of reclaimed water_{dp} from one day to the next, and any reclaimed water_{dp} collected is used promptly or the temperature of all reclaimed water_{dp} in the storage and distribution system is maintained at 63EC (145EF) or higher by automatic means; or, the reclaimed water_{dp} is treated with a suitable, approved chemical to suppress bacterial propagation by means of an automatic proportioning device, prior to the reclaimed water_{dp} entering the storage tank;

b. distribution lines and hose stations are clearly identified in accordance with LAC 51:XIV.607 as limited use reclaimed water_{dp};

c. water handling practices and guidelines are clearly described and prominently displayed at appropriate locations within the plant; and

d. these water lines are not permanently connected to product vessels, without a break to the atmosphere and sufficient automatic controls, to prevent the inadvertent addition of this water to product streams.

E. Reclaimed water_{dp} may be used as boiler feed-water for boilers which are not used for generating culinary steam, or in a thick, double walled, enclosed heat exchanger.

AUTHORITY NOTE: Promulgated in accordance with the provisions of R.S. 40:4(A)(1)(a). Also see R.S. 40:5(2)(3)(5)(7)(15)(17) and R.S. 40:922.

HISTORICAL NOTE: Promulgated by the Department of Health and Hospitals, Office of Public Health, LR 37:2701 (September 2011), amended LR 38:2793 (November 2012).

§2119. Air for Dairy Product Drying Equipment and Air under Pressure-Direct Contact with Milk and Dairy Products or Milk and Dairy Product Contact Surfaces

A. Air for dairy product drying equipment shall conform with the following:

1. Air intake and pipeline filters shall consist of fiberglass with downstream backing dense enough to prevent fiberglass break off from passing through, cotton flannel, wool flannel, spun metal, electrostatic material, or other equally acceptable filtering media, which do not release to the air toxic volatiles or other contaminants or volatiles which may impart any flavor or odor to the product. Disposable media filters shall consist of cotton flannel, wool flannel, spun metal, non-woven fabric, United States Pharmacopeia (USP) absorbent cotton fiber, or suitable inorganic materials which, under conditions of use, are non-toxic and non-shedding. Chemical bonding material contained in the media shall be non-toxic, non-volatile, and insoluble under all conditions of use. Disposable media shall not be cleaned and reused.

2. The efficiency of the initial or primary supply air filters for air which will be heated before it comes in contact with non-food contact surfaces shall be designed, selected to operate at a face velocity, and installed in a manner which will allow the filter manufacturer's rating to be 90 percent or higher, when tested in accordance with the American Society of Heating, Refrigerating and Air-Conditioning Engineers (ASHRAE) Synthetic Dust Arrestance test (ASHRAE Standard 52.1-1992). The efficiency of the initial or primary supply air filters for air, which will not be heated before it comes in contact with non-food contact surfaces shall be of a design, selected to operate at a face velocity, and installed in a manner which will allow the filter manufacturer's rating to be 85 percent or higher when tested in accordance with the ASHRAE Atmospheric Dust Spot Method (ASHRAE Standard 52.1-1992).

3. Air-intakes for drying equipment shall be located so as to minimize atmospheric contamination and shall be equipped with suitable single-service filters or multi-use systems approved by the state health officer.

B. Air under pressure which comes into direct contact with milk or dairy products or milk or dairy product contact surfaces shall comply with §929.I of this Part and the following:

1. Air intake and pipeline filters shall consist of fiberglass with downstream backing dense enough to prevent fiberglass break off from passing through, cotton flannel, wool flannel, spun metal, electrostatic material, or other equally acceptable filtering media, which do not release to the air toxic volatiles or other contaminants or volatiles which may impart any flavor or odor to the product. Disposable media filters shall consist of cotton flannel, wool flannel, spun metal, non-woven fabric, USP absorbent cotton fiber, or suitable inorganic materials which, under conditions of use, are non-toxic and non-shedding. Chemical bonding material contained in the media shall be non-toxic, non-volatile, and insoluble under all conditions of use. Disposable media shall not be cleaned and reused.

2. The efficiency of the initial or primary supply air filters for air which will be heated before it comes in contact with milk or dairy products or milk or dairy product contact surfaces shall be designed, selected to operate at a face velocity, and installed in a manner which will allow the filter manufacturer's rating to be 90 percent or higher, when tested in accordance with the American Society of Heating, Refrigerating and Air-Conditioning Engineers (ASHRAE) Synthetic Dust Arrestance test (ASHRAE Standard 52.1 - 1992). The efficiency of the initial or primary supply air filters for air, which will not be heated before it comes in contact with milk or dairy products or milk or dairy product contact surfaces shall be of a design, selected to operate at a face velocity, and installed in a manner which will allow the filter manufacturer's rating to be 85 percent or higher when tested in accordance with the ASHRAE Atmospheric Dust Spot Method (ASHRAE Standard 52.1 - 1992).

3. Air which will come into direct contact with milk or dairy products or milk or dairy product contact surfaces shall first pass through the initial or primary supply air filters meeting the requirements of Paragraph 2 of this Subsection. The initially filtered air in the pipeline downstream from the initial or primary supply air filters shall be used as the supply air for downstream (secondary) air filters on the air pipeline. The efficiency of such secondary air filters shall be at least 98 percent in accord with the Society of Automotive Engineers (SAE) Standard J726 - June 1987 using the Air Cleaner (AC) coarse test dust. All air that comes into direct contact with milk or dairy products or milk or dairy product contact surfaces shall additionally pass through further downstream (tertiary) air filters on the air pipeline. The filter efficiency of the final filter before coming into direct contact with milk or dairy products or milk or dairy product contact surfaces shall be at least 99 percent as measured by the Dioctylphthalate Fog Method (DOP) test (with a mean particle diameter of 0.3 microns) per Military Standard 282

(MIL-STD-282: Method 102.9.1). When commercially sterile air is required, the final filter efficiency shall be at least 99.99 percent as measured by the DOP test.

C. Air exhausts from dryer systems shall be covered when dryers are not in operation.

AUTHORITY NOTE: Promulgated in accordance with the provisions of R.S. 40:4(A)(1)(a). Also see R.S. 40:5(2)(3)(5)(7)(15)(17) and R.S. 40:922.

HISTORICAL NOTE: Promulgated by the Department of Health and Hospitals, Office of Public Health, LR 37:2905 (September 2011).

§2121. Supplemental Labeling Requirements for Condensed, Concentrated, Dry or Blend Dry Dairy Products

A. All containers and packages enclosing condensed, concentrated, dry or blend dry dairy products defined in § 101 of this Code shall be labeled in accordance with the applicable requirements of the *Federal Food, Drug and Cosmetic Act*, as amended, *the State Food, Drug and Cosmetic Law (R.S. 40:601, et seq.)*, *the Nutrition Labeling and Education Act of 1990*, as amended, and the regulations developed thereunder, the requirements of this Part and in addition shall be conspicuously and permanently labeled or marked with:

1. the name of the contents as prescribed by this Part, and the common name of the ingredients;
2. the grade of the product when grades for the product have been established;
3. the identity of the plant in which the product was manufactured or processed by either name and address or by permit number and identity of the state issuing such permit or by FIPS number;
4. a code or lot number identifying the contents with a specific date, run, or batch of the product, and the quantity of the contents of the container;
5. the word "goat", "sheep", "water buffalo" or the common name of other hooved mammals shall precede the name of the milk or dairy product when the product is made from the milk of animals other than cows; and,
6. the words, "a product of", followed by the name of the country in which the product was processed in cases in which the product was not processed in the United States or Puerto Rico.

B. Required labeling information shall be in letters of an acceptable size, kind and color satisfactory to the state health officer and shall contain no marks or words which are misleading. Other information, such as a registered trademark design, which is not misleading and does not obscure any of the labeling requirements above may also be included.

C. Milk tank trucks transporting whey, condensed whey or concentrated/condensed dairy products to a drying plant from another dairy plant, receiving or transfer station are required to be marked with the name and address of the

dairy plant or hauler and shall be sealed; in addition, for each shipment a shipping statement shall be prepared containing at least the following information:

1. shipper's name; address and permit number;
2. permit identification of hauler, if not employee of shipper;
3. point of origin of shipment;
4. tanker permit number;
5. name of product;
6. weight of product;
7. grade of product;
9. date of shipment;
10. name of supervising regulatory agency at the point of origin;
11. whether the contents are raw, pasteurized, or in the case of cream, lowfat or nonfat milk, whether it has been heat-treated; and,
12. seal number on inlet and outlet.

AUTHORITY NOTE: Promulgated in accordance with the provisions of R.S. 40:4(A)(1)(a). Also see R.S. 40:5(2)(3)(5)(7)(15)(17) and R.S. 40:922.

HISTORICAL NOTE: Promulgated by the Department of Health and Hospitals, Office of Public Health, LR 37:2706 (September 2011).

SubChapter B. Specifications for Grade A Condensed and Dry Dairy Products and Blended Dry Dairy Products

§2123. Grade A Condensed Milk and Condensed Milk Products

A. Grade A condensed milk and condensed milk products shall conform to the standards of identity prescribed by this Part.

B. Grade A condensed milk and condensed milk products shall conform with the following microbiological, chemical and temperature requirements:

1. temperature—cooled to 7EC (45EF) or less immediately after processing and maintained thereat unless drying is commenced immediately after condensing;
2. standard plate count—not to exceed 30,000 cfu per gram;
3. coliform count—not to exceed 10 per gram, provided, that in the case of bulk milk transport tank shipments the coliform count shall not exceed 100 per gram;
4. phosphatase—less than 350 milliunits per liter for fluid products and less than 500 milliunits per liter for other milk products by the Fluorophos ALP system or equivalent;

5. drugs—no positive results from drug residue detection test methods which the state health officer has determined to be appropriate; and,

6. pathogens—no pathogenic microorganisms of human significance.

AUTHORITY NOTE: Promulgated in accordance with the provisions of R.S. 40:4(A)(1)(a). Also see R.S. 40:5(2)(3)(5)(7)(15)(17) and R.S. 40:922.

HISTORICAL NOTE: Promulgated by the Department of Health and Hospitals, Office of Public Health, LR 37:2707 (September 2011).

§2125. Grade A Nonfat Dry Milk

A. Grade A nonfat dry milk shall conform with the standards of identity prescribed by this Part.

B. Grade A nonfat dry milk shall conform with the following microbiological, chemical and physical requirements not to exceed:

1. milk fat—1.25 percent;
2. moisture—4.00 percent;
3. titratable acidity—0.15 percent;
4. solubility index—1.25ml;
5. standard plate count—not to exceed 30,000 cfu per gram;
6. coliform count—not to exceed 10 per gram;
7. scorched particles—disc B - 15.0 per gram;
8. drugs—no positive results from drug residue detection test methods which the state health officer has determined to be appropriate; and,
9. pathogens—no pathogenic microorganisms of human significance.

AUTHORITY NOTE: Promulgated in accordance with the provisions of R.S. 40:4(A)(1)(a). Also see R.S. 40:5(2)(3)(5)(7)(15)(17) and R.S. 40:922.

HISTORICAL NOTE: Promulgated by the Department of Health and Hospitals, Office of Public Health, LR 37:2707 (September 2011).

§2127. Grade A Whey for Condensing or Concentrating

A. The processes used in the production of Grade A whey for condensing and concentrating shall be performed in cheese manufacturing plants that are in substantial compliance with the sanitation requirements for Grade A dairy plants contained in this Part.

B. Grade A whey for condensing and concentrating shall conform to the following temperature and chemical standards:

1. temperature—maintained at a temperature of 7°C (45°F) or less, or 63°C (145°F) or greater, except for acid-type whey with a titratable acidity of 0.40 percent or above, or a pH of 4.6 or below.

AUTHORITY NOTE: Promulgated in accordance with the provisions of R.S. 40:4(A)(1)(a). Also see R.S. 40:5(2)(3)(5)(7)(15)(17) and R.S. 40:922.

HISTORICAL NOTE: Promulgated by the Department of Health and Hospitals, Office of Public Health, LR 37:2707 (September 2011).

§2129. Grade A Pasteurized Condensed Whey

A. Grade A pasteurized condensed whey shall conform with the following bacteriological, chemical and temperature standards:

1. temperature—cooled to 10°C (50°F) or less during crystallization, within 72 hours of condensing;
2. standard plate count—not to exceed 30,000 cfu per gram;
3. coliform count—not to exceed 10 per gram;
4. phosphatase—less than 350 milliunits per liter for fluid products and less than 500 milliunits per liter for other milk products by the Fluorophos ALP system or equivalent;
5. drugs—no positive results from drug residue detection test methods which the state health officer has determined to be appropriate for condensed whey; and,
6. pathogens - no pathogenic microorganisms of human significance.

AUTHORITY NOTE: Promulgated in accordance with the provisions of R.S. 40:4(A)(1)(a). Also see R.S. 40:5(2)(3)(5)(7)(15)(17) and R.S. 40:922.

HISTORICAL NOTE: Promulgated by the Department of Health and Hospitals, Office of Public Health, LR 37:2707 (September 2011).

§2131. Grade A Dry Whey or Dry Whey Products

A. Grade A dry whey or dry whey products shall conform with the following bacteriological standards:

1. standard plate count—not to exceed 30,000 cfu per gram;
2. coliform count—not to exceed 10 per gram;
3. drugs—no positive results from drug residue detection test methods which the state health officer has determined to be appropriate for use with dry whey and dry whey products; and,
4. pathogens—no pathogenic microorganisms of human significance.

B. The product shall conform with the standards of identity prescribed by this Part.

AUTHORITY NOTE: Promulgated in accordance with the provisions of R.S. 40:4(A)(1)(a). Also see R.S. 40:5(2)(3)(5)(7)(15)(17) and R.S. 40:922.

HISTORICAL NOTE: Promulgated by the Department of Health and Hospitals, Office of Public Health, LR 37:2707 (September 2011).

§2133. Grade A Dry Buttermilk and Dry Buttermilk Products

A. Grade A Dry Buttermilk or Dry Buttermilk Products shall conform with the following bacteriological and chemical standards:

1. standard plate count—not to exceed 30,000 cfu per gram;
2. coliform count—not to exceed 10 per gram;
3. drugs—no positive results on drug residue detection test methods which the state health officer has determined to be appropriate for use with dry buttermilk and dry buttermilk products; and,
4. pathogens—no pathogenic microorganisms of human significance.

B. The product shall conform with the standards of identity prescribed by this Part.

AUTHORITY NOTE: Promulgated in accordance with the provisions of R.S. 40:4(A)(1)(a). Also see R.S. 40:5(2)(3)(5)(7)(15)(17) and R.S. 40:922.

HISTORICAL NOTE: Promulgated by the Department of Health and Hospitals, Office of Public Health, LR 37:2708 (September 2011).

§2135. Other Grade A Condensed, Concentrated or Dry Dairy Products

A. Other condensed, concentrated or dry dairy products which are designated Grade A by the NCIMS shall be processed in dairy plants that are in substantial compliance with the requirements for Grade A dairy plants contained in this Part and shall conform with the following.

1. All such products shall conform with the standards of identity prescribed by this Part.
2. The products shall conform with the following bacteriological, chemical and temperature requirements:
 - a. standard plate count—not to exceed 30,000 cfu per gram;
 - b. coliform count—not to exceed 10 per gram;
 - c. drugs—no positive results from drug residue detection test methods which the state health officer has determined to be appropriate; and,
 - d. pathogens no pathogenic microorganisms of human significance.

AUTHORITY NOTE: Promulgated in accordance with the provisions of R.S. 40:4(A)(1)(a). Also see R.S. 40:5(2)(3)(5)(7)(15)(17) and R.S. 40:922.

HISTORICAL NOTE: Promulgated by the Department of Health and Hospitals, Office of Public Health, LR 37:2708 (September 2011).

§2137. Blended Dry Dairy Products

A. The manufacture of blended dry dairy products shall be performed in a plant that is in substantial compliance with the requirements of this Part for dairy products condensing, dairy products drying or dairy products blending plants.

B. Blended dry dairy products shall conform with the following bacteriological standards:

1. standard plate count—not to exceed 30,000 cfu per gram;
2. coliform count—not to exceed 10 per gram;
3. drugs—no positive results from drug residue detection test methods which the state health officer has determined to be appropriate; and,
4. pathogens—no pathogenic microorganisms of human significance.

AUTHORITY NOTE: Promulgated in accordance with the provisions of R.S. 40:4(A)(1)(a). Also see R.S. 40:5(2)(3)(5)(7)(15)(17) and R.S. 40:922.

HISTORICAL NOTE: Promulgated by the Department of Health and Hospitals, Office of Public Health, LR 37:2708 (September 2011).

Subchapter C. Specifications for Extra Grade and Standard Grade Dry Dairy Products

§2139. Extra Grade and Standard Grade Dry Dairy Products

A. Extra grade and standard grade dry dairy products shall be manufactured from Grade A raw milk for pasteurization or manufacturing grade (milk for manufacturing purposes) for pasteurization.

B. Extra grade and standard grade dry dairy products shall conform with the standards of identity prescribed by this Part.

C. Extra grade and standard grade dry dairy products shall have no positive results from drug residue detection test methods which the state health officer has determined to be appropriate.

AUTHORITY NOTE: Promulgated in accordance with the provisions of R.S. 40:4(A)(1)(a). Also see R.S. 40:5(2)(3)(5)(7)(15)(17) and R.S. 40:922.

HISTORICAL NOTE: Promulgated by the Department of Health and Hospitals, Office of Public Health, LR 37:2708 (September 2011).

§2141. Bacteriological Requirements for Extra Grade Dry Dairy Products

A. Extra grade dry dairy products shall conform with the bacteriological requirements indicated below.

1. Dry whole milk:
 - a. standard plate count - not to exceed 10,000 cfu per gram;
 - b. coliform count - not to exceed 10 per gram; and
 - c. pathogens—no pathogenic microorganisms of human significance.
2. Instant nonfat dry milk:

- a. standard plate count—not to exceed 10,000 cfu per gram;

- b. coliform count—not to exceed 10 per gram; and,

- c. pathogens—no pathogenic microorganisms of human significance.

3. Nonfat dry milk (spray process):

- a. standard plate count—not to exceed 10,000 cfu per gram;

- b. coliform count—not to exceed 10 per gram; and,

- c. pathogens—no pathogenic microorganisms of human significance.

4. Nonfat dry milk (roller process):

- a. standard plate count—not to exceed 50,000 cfu per gram;

- b. coliform count—not to exceed 10 per gram; and,

- c. pathogens—no pathogenic microorganisms of human significance.

5. Dry whey:

- a. standard plate count—not to exceed 30,000 cfu per gram;

- b. coliform count—not to exceed 10 per gram; and,

- c. pathogens—no pathogenic microorganisms of human significance.

6. Dry buttermilk:

- a. standard plate count—not to exceed 20,000 cfu per gram;

- b. coliform count—not to exceed 10 per gram; and,

- c. pathogens—no pathogenic microorganisms of human significance.

7. Edible dry casein (acid):

- a. standard plate count—not to exceed 30,000 cfu per gram;

- b. coliform count—negative (0 cfu) per 0.1 gram; and,

- c. pathogens—no pathogenic microorganisms of human significance.

B. Instant nonfat dry milk and dry whey that does not meet the bacteriological requirements for Grade A or extra grade shall not be sold or otherwise provided for human consumption.

AUTHORITY NOTE: Promulgated in accordance with the provisions of R.S. 40:4(A)(1)(a). Also see R.S. 40:5(2)(3)(5)(7)(15)(17) and R.S. 40:922.

HISTORICAL NOTE: Promulgated by the Department of Health and Hospitals, Office of Public Health, LR 37:2708 (September 2011).

§2143. Bacteriological Requirements for Standard Grade Dry Dairy Products

A. Standard grade dry dairy products shall conform with the bacteriological requirements indicated below:

1. Dry whole milk:
 - a. standard plate count—not to exceed 50,000 cfu per gram;
 - b. coliform count—not to exceed 10 per gram; and,
 - c. pathogens—no pathogenic microorganisms of human significance.
2. Nonfat dry milk (spray process):
 - a. standard plate count—not to exceed 75,000 cfu per gram;
 - b. coliform count—not to exceed 10 per gram; and, pathogens—no pathogenic microorganisms of human significance.
3. Nonfat dry milk (roller process):

standard plate count—not to exceed 100,000 cfu per gram;

coliform count—not to exceed 10 per gram; and,

 - c. pathogens—no pathogenic microorganisms of human significance.
4. Dry buttermilk:
 - a. standard plate count—not to exceed 75,000 cfu per gram;
 - b. coliform count—not to exceed 10 per gram; and,
 - c. pathogens—no pathogenic microorganisms of human significance.
5. Edible dry casein (acid):
 - a. standard plate count—not to exceed 100,000 cfu per gram;
 - b. coliform count—not more than 2 cfu per 0.1 gram; and,
 - c. pathogens—no pathogenic microorganisms of human significance.

AUTHORITY NOTE: Promulgated in accordance with the provisions of R.S. 40:4(A)(1)(a). Also see R.S. 40:5(2)(3)(5)(7)(15)(17) and R.S. 40:922.

HISTORICAL NOTE: Promulgated by the Department of Health and Hospitals, Office of Public Health, LR 37:2709 (September 2011).

Chapter 23. Butter Plants

§2301. Approval of Plans

A. All butter plants that are domiciled within the state and in which butter or butter related products are processed or packaged and which are hereafter constructed, reconstructed or altered shall conform in their construction

to the requirements of these regulations. Prior to construction, reconstruction or alteration, written approval of plans and specifications shall be obtained from the state health officer.

B. Prior to installation or modification, written approval shall be obtained from the state health officer of plans and specifications for the design, construction and manner of employment for all equipment.

C. Written detailed plans describing the processing of each product shall be submitted to the state health officer for approval prior to manufacture of each product and prior to any product or process changes.

D. Butter plants that are required or have been authorized by the state health officer to be regulated under the HACCP requirements of this Part shall conform with each of the HACCP requirements contained in Chapter 11 of this Part.

AUTHORITY NOTE: Promulgated in accordance with the provisions of R.S. 40:4(A)(1)(a). Also see R.S. 40:5(2)(3)(5)(7)(15)(17) and R.S. 40:922.

HISTORICAL NOTE: Promulgated by the Department of Health and Hospitals, Office of Public Health, LR 37:2709 (September 2011).

§2303. Basic Requirements for Dairy Plants that Manufacture, Process or Package Butter and Butter Related Products

A. Dairy plants that manufacture, process or package butter or butter related products shall conform with the following general requirements for dairy plants:

1. definitions (in accordance with §101 of this Part);
2. standards of identity (in accordance with §107 of this Part);
3. permits (in accordance with §109 of this Part);
4. permits required for imported milk, milk products and frozen desserts (in accordance with §111 of this Part);
5. milk records (in accordance with §115 of this Part);
6. falsification of records (in accordance with §117 of this Part);
7. registration (in accordance with §119 of this Part);
8. labeling (in accordance with §121 of this Part);
9. delivery of samples (in accordance with §303 of this Part);
10. pasteurization equipment tests, examinations and sealing (in accordance with §313 of this Part);
11. field supervision (in accordance with §319 of this Part);
12. application for regrading, reinstatement of permit and permission to resume sale of product (in accordance with §341 of this Part);
13. reinstatement of permit when suspension was based upon adulteration of product or contamination of pasteurized

product or cheeses with pathogenic microorganisms of human significance (in accordance with §347 of this Part);

14. manufacturing grade raw milk for pasteurization (milk for manufacturing purpose) (in accordance with §353 of this Part);

15. grade A pasteurized, ultra-pasteurized and aseptically processed milk and milk products, bulk shipped grade A pasteurized or ultra-pasteurized milk and milk products and pasteurized filled milk and filled milk products (in accordance with §355 of this Part);

16. grade A bulk shipped, heat-treated milk and milk products (in accordance with §357 of this Part);

17. grade A pasteurized, ultra-pasteurized and aseptically processed milk and milk products certified for interstate shipment (in accordance with §361 of this Part);

18. milk tank trucks (in accordance with §701 of this Part);

19. sealing and protection of milk tank trucks (in accordance with §703 of this Part);

20. labeling (in accordance with §705 of this Part);

21. general requirements (in accordance with §901 of this Part);

22. approval of plans (in accordance with §903 of this Part);

23. raw milk receiving (in accordance with §905 of this Part);

24. dairy plant receivers/samplers (in accordance with §907 of this Part);

25. receiving and handling of milk derived and non-dairy ingredients (in accordance with §909 of this Part);

26. immediate surroundings (in accordance with §911 of this Part);

27. floors (in accordance with §913 of this Part);

28. walls and ceilings (in accordance with §915 of this Part);

29. doors and windows (in accordance with §917 of this Part);

30. light and ventilation (in accordance with §919 of this Part);

31. separate rooms (in accordance with §921 of this Part);

32. toilet facilities (in accordance with §923 of this Part);

33. water supply (in accordance with §925 of this Part);

34. hand washing facilities (in accordance with §927 of this Part);

35. protection from contamination (in accordance with §929 of this Part);

36. reclaim or rework operations (in accordance with §931 of this Part);

37. sanitary piping (in accordance with §935 of this Part);

38. construction and repair of containers and equipment (in accordance with §937 of this Part);

39. thermometers (in accordance with §939 of this Part);

40. pasteurization, ultra-pasteurization and aseptic processing (in accordance with §941 of this Part);

41. cleaning and sanitizing of containers and equipment (in accordance with §943 of this Part);

42. storage of cleaned containers and equipment (in accordance with §945 of this Part);

43. storage of single service containers; utensils and materials (in accordance with §947 of this Part);

44. packing, bottling and wrapping (in accordance with §949 of this Part);

45. cooling of milk and dairy products (in accordance with §955 of this Part);

46. use of overflow, leaked, spilled or mishandled dairy products (in accordance with §957 of this Part);

47. apparatus, containers, equipment and utensils (in accordance with §967 of this Part);

48. personnel health (in accordance with §969 of this Part);

49. notification of disease (in accordance with §971 of this Part);

50. procedure when infection suspected (in accordance with §973 of this Part);

51. personal cleanliness (in accordance with §975 of this Part);

52. allergen and sensitivity producing ingredient (in accordance with §977 of this Part);

53. rat proofing (in accordance with §985 of this Part);

54. waste disposal (in accordance with §987 of this Part); and

55. vehicles (in accordance with §989 of this Part).

AUTHORITY NOTE: Promulgated in accordance with the provisions of R.S. 40:4(A)(1)(a). Also see R.S. 40:5(2)(3)(5)(7)(15)(17) and R.S. 40:922.

HISTORICAL NOTE: Promulgated by the Department of Health and Hospitals, Office of Public Health, LR 37:2709 (September 2011).

Subchapter A. Supplemental Requirements for Butter Plants

§2305. General Information

A. In addition to the requirements for dairy plants, all plants manufacturing butter and related products shall conform with the following additional requirements:

1. churn rooms in addition to proper construction and sanitation as prescribed by this Part, shall be so equipped that the air is kept free from objectionable odors, vapors or extreme temperatures by means of adequate ventilation, exhaust systems or air conditioning and heating systems; and

2. print and bulk packaging rooms shall in addition to proper construction and sanitation, as prescribed by this Part, provide an atmosphere relatively free from mold (no more than 10 mold colonies per cubic foot of air), dust or other airborne contamination and be maintained at a reasonable room temperature.

AUTHORITY NOTE: Promulgated in accordance with the provisions of R.S. 40:4(A)(1)(a). Also see R.S. 40:5(2)(3)(5)(7)(15)(17) and R.S. 40:922.

HISTORICAL NOTE: Promulgated by the Department of Health and Hospitals, Office of Public Health, LR 37:2710 (September 2011).

§2307. Construction of Utensils and Equipment

A. All utensils and equipment used in the manufacture of butter and related products shall conform with the requirements contained in §937 of this Part. In addition, for certain other equipment, the following requirements shall be met.

1. Continuous Churns. All product contact surfaces shall be of non-corrosive materials. All non-metallic product contact surfaces shall comply with 3-A Standards for plastic, rubber, and rubber-like materials. All product contact surfaces shall be accessible for cleaning and inspection.

2. Conventional churns shall be constructed of aluminum, stainless steel or equally corrosion resistant metal, free from cracks and in good repair. All gasket material shall be non-toxic and durable. Seals around doors and covers shall be tight.

3. Bulk butter trucks, boats and packers shall be constructed of aluminum, stainless steel or equally corrosion resistant metal, free from cracks or seams and must have product contact surfaces that are smooth and easily cleanable.

4. Butter, frozen or plastic cream melting machines, shavers and shredders used for the rapid melting of butter or plastic cream shall be constructed of stainless steel or equally corrosion resistant metal and shall be of sanitary construction and easily cleanable.

5. Printing equipment shall be designed to be easily disassembled for cleaning of product contact surfaces. All product contact surfaces shall be of aluminum, stainless steel or equally corrosion resistant metal or plastic, rubber and rubber-like materials that meet 3-A Standards.

6. The product contact surfaces of all utensils and equipment used in the manufacture of butter and related products shall be smooth and easily cleanable. The use of wood or other fibrous or porous materials on product contact surfaces shall be prohibited.

AUTHORITY NOTE: Promulgated in accordance with the provisions of R.S. 40:4(A)(1)(a). Also see R.S. 40:5(2)(3)(5)(7)(15)(17) and R.S. 40:922.

HISTORICAL NOTE: Promulgated by the Department of Health and Hospitals, Office of Public Health, LR 37:2711 (September 2011).

§2309. Cream for the Manufacture of Butter and Butter Related Products

A. Cream for the manufacture of butter and butter related products shall be derived from Grade A raw milk for pasteurization or manufacturing grade raw milk for pasteurization from a source approved by the state health officer. The milk or cream shall be pasteurized, ultra-pasteurized or aseptically processed in the plant in which the butter or butter related products are manufactured.

B. Pasteurization or ultra-pasteurization shall be performed in accordance with the requirements contained in §941 of this Part provided that:

1. the temperature of pasteurization for cream to be processed for plastic or frozen cream shall be not less than 77°C (170°F) for not less than 30 minutes or not less than 88°C (190°F) for not less than 15 seconds;

2. The temperature of pasteurization for cream to be processed into butter and other butter related products shall be not less than 74°C (165°F) for not less than 30 minutes or not less than 85EC (185EF) for not less than 15 seconds.

AUTHORITY NOTE: Promulgated in accordance with the provisions of R.S. 40:4(A)(1)(a). Also see R.S. 40:5(2)(3)(5)(7)(15)(17) and R.S. 40:922.

HISTORICAL NOTE: Promulgated by the Department of Health and Hospitals, Office of Public Health, LR 37:2711 (September 2011).

§2311. Composition and Wholesomeness of Ingredients Used in the Manufacture of Butter and Butter Related Products

A. The composition and wholesomeness of all ingredients used in the manufacture of butter and butter related products shall be in conformance with the requirements of the *Federal Food, Drug and Cosmetic Act*, as amended.

AUTHORITY NOTE: Promulgated in accordance with the provisions of R.S. 40:4(A)(1)(a). Also see R.S. 40:5(2)(3)(5)(7)(15)(17) and R.S. 40:922.

HISTORICAL NOTE: Promulgated by the Department of Health and Hospitals, Office of Public Health, LR 37:2711 (September 2011).

§2313. Examination of Butter and Butter Related Products

A. Samples of butter and butter related products shall be collected and examined as often as the state health officer

may require. The state health officer shall not be required to pay for such samples.

B. All sampling procedures and required laboratory examinations shall be in compliance with the *Standard Methods for the Examination of Dairy Products*.

AUTHORITY NOTE: Promulgated in accordance with the provisions of R.S. 40:4(A)(1)(a). Also see R.S. 40:5(2)(3)(5)(7)(15)(17) and R.S. 40:922.

HISTORICAL NOTE: Promulgated by the Department of Health and Hospitals, Office of Public Health, LR 37:2711 (September 2011).

§2315. Standards of Identity for Butter

A. All butter and butter related products shall conform with the standards of identity prescribed by this Part.

AUTHORITY NOTE: Promulgated in accordance with the provisions of R.S. 40:4(A)(1)(a). Also see R.S. 40:5(2)(3)(5)(7)(15)(17) and R.S. 40:922.

HISTORICAL NOTE: Promulgated by the Department of Health and Hospitals, Office of Public Health, LR 37:2711 (September 2011).

§2317. Bacteriological Requirements

A. All butter and butter related products shall conform with the following microbial requirements:

1. standard plate count—not to exceed 1,000 cfu per gram;
2. coliform count—not to exceed 10 per gram; and,
3. pathogens—no pathogenic microorganisms of human significance.

AUTHORITY NOTE: Promulgated in accordance with the provisions of R.S. 40:4(A)(1)(a). Also see R.S. 40:5(2)(3)(5)(7)(15)(17) and R.S. 40:922.

HISTORICAL NOTE: Promulgated by the Department of Health and Hospitals, Office of Public Health, LR 37:2711 (September 2011).

§2319. Seizure and Condemnation of Butter and Butter Related Products

A. Butter and butter related products that do not conform with the bacteriological requirements contained in §2317 of this Part shall be subject to seizure and condemnation by the state health officer as provided in §632 of the *State Food, Drug and Cosmetic Act*.

AUTHORITY NOTE: Promulgated in accordance with the provisions of R.S. 40:4(A)(1)(a). Also see R.S. 40:5(2)(3)(5)(7)(15)(17) and R.S. 40:922.

HISTORICAL NOTE: Promulgated by the Department of Health and Hospitals, Office of Public Health, LR 37:2711 (September 2011).

§2321. Containers

A. Containers used for the packaging of butter and butter related products shall be containers or packaging materials from sources approved by the state health officer and satisfactorily protect the safety and quality of the contents in regular channels of trade. Caps or covers which extend over the lip of the container shall be used on all cups or tubs

containing two pounds or less to protect the product from contamination.

B. Liners, wrappers and other packaging materials shall be from sources approved by the state health officer and protect the products from dust, mold and other contaminants.

AUTHORITY NOTE: Promulgated in accordance with the provisions of R.S. 40:4(A)(1)(a). Also see R.S. 40:5(2)(3)(5)(7)(15)(17) and R.S. 40:922.

HISTORICAL NOTE: Promulgated by the Department of Health and Hospitals, Office of Public Health, LR 37:2712 (September 2011).

§2323. Printing and Packaging of Butter and Butter Related Products

A. Printing and packaging of butter and butter related products shall be performed using procedures that preclude the contamination of product and have been approved by the state health officer.

AUTHORITY NOTE: Promulgated in accordance with the provisions of R.S. 40:4(A)(1)(a). Also see R.S. 40:5(2)(3)(5)(7)(15)(17) and R.S. 40:922.

HISTORICAL NOTE: Promulgated by the Department of Health and Hospitals, Office of Public Health, LR 37:2712 (September 2011).

Chapter 25. Cheese Manufacturing Plants

§2501. Approval of Plans

A. All cheese manufacturing plants that are domiciled within the state and are hereafter constructed, reconstructed or altered shall conform in their construction and operation with the requirements of this Part. Prior to construction, reconstruction or alteration, written approval of plans and specifications shall be obtained from the state health officer.

B. Prior to installation or modification, written approval shall be obtained from the state health officer of plans and specifications for the design, construction and manner of employment for all equipment.

C. Written detailed plans describing the processing of each product shall be submitted to the state health officer for approval prior to manufacture of each product and prior to any product or process change.

AUTHORITY NOTE: Promulgated in accordance with the provisions of R.S. 40:4(A)(1)(a). Also see R.S. 40:5(2)(3)(5)(7)(15)(17) and R.S. 40:922.

HISTORICAL NOTE: Promulgated by the Department of Health and Hospitals, Office of Public Health, LR 37:2712 (September 2011).

§2503. Basic Requirements for Cheese Manufacturing Plants

A. All dairy plants that manufacture, process, cut, slice or package cheese or cheese related products shall conform with the following general requirements for dairy plants:

1. definitions (in accordance with §101 of this Part);
2. standards of identity (in accordance with §107 of this Part);

3. permits (in accordance with §109 of this Part);
4. permits required for imported milk, milk products and frozen desserts (in accordance with §111 of this Part);
5. requirements for imported dairy products (in accordance with §113 of this Part);
6. milk records (in accordance with §115 of this Part);
7. falsification of records (in accordance with §117 of this Part);
8. labeling (in accordance with §121 of this Part);
9. delivery of samples (in accordance with §303 of this Part);
10. pasteurization equipment tests, examinations and sealing (in accordance with §313 of this Part);
11. posting inspection reports (in accordance with §317 of this Part);
12. field supervision (in accordance with §319 of this Part);
13. application for regrading, reinstatement of permit and permission to resume sale of product (in accordance with §341 of this Part);
14. regrading and reinstatement of permit when degrade or suspension was based on physical violations (in accordance with §345 of this Part);
15. reinstatement of permit when suspension was based upon adulteration of product or contamination of pasteurized product or cheeses with pathogenic microorganisms of human significance (in accordance with §347 of this Part);
16. grade A raw milk for pasteurization (in accordance with §349 of this Part);
17. grade A raw milk for pasteurization (certified for interstate milk shipment) (in accordance with §351 of this Part);
18. manufacturing grade raw milk for pasteurization (milk for manufacturing purpose) (in accordance with §353 of this Part);
19. grade A aseptically processed milk and milk products (in accordance with §359 of this Part);
20. grade A pasteurized, ultra-pasteurized and aseptically processed milk and milk products certified for interstate shipment (in accordance with §361 of this Part);
21. milk tank trucks (in accordance with §701 of this Part);
22. sealing and protection of milk tank trucks (in accordance with §703 of this Part);
23. labeling (in accordance with §705 of this Part);
24. general requirements (in accordance with §901 of this Part);
25. approval of plans (in accordance with §903 of this Part);
26. raw milk receiving (in accordance with §905 of this Part);
27. dairy plant receivers/samplers (in accordance with §907 of this Part);
28. receiving and handling of milk derived and non-dairy ingredients (in accordance with §909 of this Part);
29. immediate surroundings (in accordance with §911 of this Part);
30. floors (in accordance with §913 of this Part);
31. walls and ceilings (in accordance with §915 of this Part);
32. doors and windows (in accordance with §917 of this Part);
33. light and ventilation (in accordance with §919 of this Part);
34. separate rooms (in accordance with §921 of this Part);
35. toilet facilities (in accordance with §923 of this Part);
36. water supply (in accordance with §925 of this Part);
37. hand washing facilities (in accordance with §927 of this Part);
38. protection from contamination (in accordance with §929 of this Part);
39. reclaim or rework operations (in accordance with §931 of this Part);
40. dairy plant cleanliness (in accordance with §933 of this Part);
41. sanitary piping (in accordance with §935 of this Part);
42. construction and repair of containers and equipment (in accordance with §937 of this Part);
43. thermometers (in accordance with §939 of this Part);
44. cleaning and sanitizing of containers and equipment (in accordance with §943 of this Part);
45. storage of cleaned containers and equipment (in accordance with §945 of this Part);
46. storage of single-service containers, utensils and materials (in accordance with §947 of this Part);
47. packing, bottling and wrapping (in accordance with §949 of this Part);
48. cooling of milk and dairy products (in accordance with §955 of this Part);

49. use of overflow, leaks, spilled or mishandled dairy products (in accordance with §957 of this Part);
50. dipping or transferring dairy products (in accordance with §965 of this Part);
51. apparatus, containers, equipment and utensils (in accordance with §967 of this Part);
52. personnel health (in accordance with §969 of this Part);
53. notification of disease (in accordance with §971 of this Part);
54. procedure when infection suspected (in accordance with §973 of this Part);
55. personal cleanliness (in accordance with §975 of this Part);
56. rat proofing (in accordance with §985 of this Part);
57. waste disposal (in accordance with §987 of this Part); and
58. vehicles (in accordance with §989 of this Part).

AUTHORITY NOTE: Promulgated in accordance with the provisions of R.S. 40:4(A)(1)(a). Also see R.S. 40:5(2)(3)(5)(7)(15)(17) and R.S. 40:922.

HISTORICAL NOTE: Promulgated by the Department of Health and Hospitals, Office of Public Health, LR 37:2712 (September 2011).

Subchapter A. Supplemental Requirements for Cheese Manufacturing Plants

§2505. General Information

A. Cheese manufacturing plants that manufacture, process, cut, slice or package cheese shall conform with all of the basic requirements for cheese manufacturing plants contained in this Part and with the following additional requirements.

1. All cheese and cheese related products shall conform to the standards of identity prescribed by this Part.
2. Written, detailed plans describing the processing of each product shall be submitted to the state health officer for approval prior to manufacture of each product and prior to any product process change.
3. The words “made from unpasteurized milk” shall be prominently displayed on the principal display panel of each container of cheese and cheese related products made from milk in which each particle has not been pasteurized, ultra-pasteurized or aseptically processed in a manner that conforms with the requirements for pasteurization contained in this Part.
4. All containers and packages enclosing cheese and cheese related products shall be labeled in accordance with the applicable requirements of the Federal Food, Drug and Cosmetic Act, as amended, the State Food, Drug, and Cosmetic Law (R.S. 40:601, et seq.), the Nutrition Labeling

and Education Act of 1990, as amended, and the regulations developed thereunder and the requirements for labeling contained in this Part.

5. Whey disposal or use shall conform the following:

- a. adequate sanitary facilities shall be provided for the handling and disposal of whey. Necessary precautions shall be taken to minimize flies, insects and objectionable odors;
- b. whey or whey products to be used for human food shall be handled in accordance with the applicable provisions of this Part; and
- c. whey or whey products to be used as or in Grade A products shall be produced in a cheese manufacturing plant that complies with all applicable requirements for dairy plants that produce Grade A pasteurized, ultra-pasteurized and aseptically processed products contained in Chapter 9. All such whey shall be derived from cheese produced from Grade A raw milk for pasteurization;

6. Cooling of milk and dairy products shall conform with the following:

- a. all Grade A raw milk or heat treated products shall be received at 7°C (45°F) or less and maintained at or below that temperature until processed;
- b. all manufacturing grade raw milk (milk for manufacturing purposes) shall not exceed 10°C (50°F) upon delivery to the dairy plant unless it is delivered to the dairy plant in less than four hours after milking. It shall be cooled immediately upon receipt to 7°C (45°F) or below and maintained at or below that temperature until processed;
- c. whey and whey products in balance (constant level) tanks or hot wells may be allowed to remain at temperatures above 7°C (45°F) and below 66°C (150°F) for a period not to exceed four hours of operation provided:
 - i. when foam is present on the product, the temperature of the foam shall be considered the temperature of the product;
 - ii. the balance tank or hot well shall be emptied, cleaned and sanitized at least once each four hours of operation; and
 - iii. dairy products in balance tanks or hot wells at temperatures below 7°C (45°F) or above 66°C (150°F) or above are exempt from this requirement;
- d. all pasteurized dairy products, except those to be cultured, shall be cooled immediately after pasteurization in approved equipment, to a temperature of 7°C (45°F) or less and stored at a temperature of 7°C (45°F) or less;
- e. the temperature of milk or dairy products in delivery vehicles shall not exceed 7°C (45°F);
- f. every room or tank in which dairy products are stored shall be equipped with an approved thermometer;

g. aseptically processed dairy products to be packaged in hermetically sealed containers shall be exempt from the cooling requirement for this item; and,

h. re-circulated water which is used in coolers and exchangers, including systems in which a freezing point depressant is used shall be from a safe source and protected from contamination. Such water shall be tested at the minimum frequencies specified in §2117 of this Part and shall otherwise comply with the requirements of §2117 of this Part. Freezing point depressants, when used, shall be non toxic.

AUTHORITY NOTE: Promulgated in accordance with the provisions of R.S. 40:4(A)(1)(a). Also see R.S. 40:5(2)(3)(5)(7)(15)(17) and R.S. 40:922.

HISTORICAL NOTE: Promulgated by the Department of Health and Hospitals, Office of Public Health, LR 37:2713 (September 2011).

§2507. Additional Requirements for Cheese Manufacturing Plants that Manufacture, Process, Package, Cut or Slice Ripened or Aged Cheese and Cheese Related Products

A. Cheese manufacturing plants that manufacture, process, package, cut or slice aged cheese and cheese related products shall conform with all of the requirements for cheese manufacturing plants contained in this Part and shall conform with the following additional requirements.

1. Milk for the manufacture of aged cheese shall be derived from Grade A raw milk for pasteurization or manufacturing grade raw milk for pasteurization from a source approved by the state health officer.

2. Milk used in the manufacture of aged cheese and cheese related products may be pasteurized, ultra-pasteurized, aseptically processed or clarified or both.

3. The pasteurization, ultra-pasteurization or aseptic processing of raw milk used in the manufacture of aged cheese and cheese related products shall be performed in accordance with the requirements for pasteurization, ultra-pasteurization or aseptic processing contained in this Part.

4. The following additional separate rooms shall be provided.

a. Starter Room. Starter rooms or areas shall be properly equipped and maintained for the propagation and handling of starter cultures. All necessary precautions shall be taken to prevent contamination of starter cultures, of the room, equipment, and the air therein.

b. Make Room. The room in which the cheese is manufactured in vats that are uncovered while product is in them. It shall be of adequate size, and the vats adequately spaced to permit movement around the vats and presses for proper cleaning and satisfactory working conditions. Adequate ventilation shall be provided. In existing installations in which the make room is an integral part of a processing room, the operation shall conform with the requirements contained in §921.A.6 of this Part.

c. Drying Room. If cheese is to be paraffined, a drying room of adequate size shall be provided to accommodate the maximum production of cheese during the flush period. Adequate sanitary shelving and air circulation shall be provided for proper drying. Suitable temperature and humidity control facilities shall be provided.

d. Paraffining Room. For rind cheese, a separate room or compartment shall be provided for paraffining and boxing the cheese. The room or compartment shall be of adequate size and the temperature maintained near the temperature of the drying room to avoid sweating of the cheese prior to paraffining.

e. Rindless Block Wrapping Area. For rindless blocks a suitable space shall be provided for proper wrapping and boxing of the cheese. The area shall be free from dust, condensation, mold or other conditions which may contaminate the surface of the cheese or contribute to an unsatisfactory packaging of the cheese.

f. Coolers or Curing Rooms. Coolers or curing rooms where cheese is held for curing or storage shall be clean and maintained at the proper uniform temperature and humidity to adequately protect the cheese. Proper circulation of air shall be maintained at all times. The rooms shall be free from rodents, insects, and pests. The shelves shall be kept clean and dry. All racks, shelves and other equipment used in this room shall conform with the requirements of equipment construction required in this Part.

g. Cutting and Packaging Rooms. When cheese is cut, sliced or wrapped, separate rooms shall be provided for the cleaning and preparation of the bulk cheese and a separate room shall be provided for the cutting, slicing or wrapping operation. The rooms shall be well lighted, ventilated, and provided with filtered air. Air movement shall be outward to minimize the entrance of unfiltered air into the cutting and packaging room.

5. Rooms in which dairy products are handled, processed or stored, or in which dairy product containers, utensils and equipment are cleaned or stored, shall not open directly into any stable, farm-stead, area in which meat, poultry or any other non-dairy foods of animal origin are handled or stored, any restaurant food preparation area or any room used for domestic purposes. All rooms shall be of sufficient size for their intended purposes.

6. Designated areas or rooms shall be provided to segregate the receiving, handling and storage of returned packaged dairy products. They shall be properly identified, kept neat, clean and maintained in such a manner as to preclude contamination of other products or equipment or the attraction of flies.

7. Construction and repair of containers and equipment:

a. The construction of all containers and equipment used in the manufacture of aged cheeses and related products shall conform with the requirements for containers and equipment contained in §937 of this Part.

b. In addition, for certain other equipment the following requirements shall be met.

i. Starter Vats. Bulk starter vats shall be of stainless steel or equally corrosion-resistant metal and shall be in good repair, equipped with tight-fitting lids and have adequate temperature controls, such as valves, indicating and/or recording thermometers and shall conform with the applicable 3-A Standards.

ii. Cheese Vats, Tanks and Drain Tables. The vats used for making cheese shall be of metal construction with adequate jacket capacity for uniform heating. The inner liner shall be minimum 16-gage stainless steel or other equally corrosion-resistant metal, properly pitched from side to center and from rear to front for adequate drainage. The liner shall be smooth, free from excessive dents or creases and shall extend over the edge of the outer jacket. The outer jacket when metal, shall be constructed of stainless steel or other metal which can be kept clean and sanitary. The junction of the liner and outer jackets shall be constructed so as to prevent milk or cheese from entering the inner jacket. The vat, tank and drain table shall be equipped with a suitable sanitary outlet valve. Effective valves shall be provided and properly maintained to control the application of heat to the vat.

iii. Mechanical Agitators. The mechanical agitators shall be of sanitary construction. The carriage and track shall be so constructed as to prevent the dropping of dirt or grease into the vat. Metal blades, forks, or stirrers shall be constructed of stainless steel and of material approved in the 3-A Standards and shall be free from rough or sharp edges which might scratch the equipment or remove metal particles.

iv. Knives, hand rakes, shovels, scoops, paddles, strainers, and miscellaneous equipment shall be stainless steel or of material approved in the 3-A Standards. The product contact surfaces of the curd mill shall be of stainless steel. All pieces of equipment shall be so constructed that they can be kept clean and free from rough or sharp edges which might scratch the equipment or remove metal particles. The wires in the curd knives shall be stainless steel, kept tight, replaced when necessary and kept clean.

v. Hoops, Forms and Followers. The hoops, forms and followers shall be constructed of stainless steel or heavy tinned steel. If tinned, they shall be kept tinned and free from rust. All hoops, forms, and followers shall be kept in good repair. Drums or other special forms used to press and store cheese shall be clean and sanitary.

vi. Press. The cheese press shall be constructed of stainless steel and all joints welded and all surfaces, seams, and openings readily cleanable. The pressure device shall be the continuous type. Press cloths shall be maintained in good repair and in a sanitary condition. Single-service press cloths, starch circles, bandages, etc., shall be used only once.

vii. Rindless Cheese Press. The press used to heat seal the wrapper applied to rindless cheese shall have square interior corners, reasonably smooth interior surface and have

controls that shall provide uniform pressure and heat equally to all surfaces.

viii. Paraffin Tanks. The metal tank shall be adequate in size, have heat controls and an indicating thermometer. The cheese wax contained in the paraffin tank shall be kept clean at all times.

ix. Automatic Curd Maker. The automatic curd making system shall be constructed of stainless steel or of material approved in the 3-A Standards. All areas shall be free from cracks and rough surfaces and constructed so that they can be easily cleaned.

x. Curd Conveying Systems. The curd conveying system, conveying lines and cyclone separator shall be constructed of stainless steel or other equally corrosion resistant metal in such manner that it can be satisfactorily cleaned. The system shall be of sufficient size to handle the volume of curd and be provided with filtered air of the quality satisfactory for the intended use. Air compressors or vacuum pumps shall not be located in the processing or packaging areas.

xi. Automatic Salter. The automatic salter shall be constructed of stainless steel or other equally corrosion resistant metal. This equipment shall be constructed to equally distribute the salt throughout the curd. It shall be designed to accurately weigh the amount of salt added. The automatic salter shall be constructed so that it can be satisfactorily cleaned. The salting system shall provide for adequate absorption of the salt in the curd. Water and steam used to moisten the curd prior to salting shall be potable water or culinary steam.

xii. Automatic Curd Filler. The automatic curd filler shall be constructed of stainless steel or other equally corrosion resistant metal. This equipment shall be of sufficient size to handle the volume of curd and constructed and controlled so as to accurately weigh the amount of curd as it fills. The curd filler shall be constructed so that it can be satisfactorily cleaned.

xiii. Hoop and Barrel Washer. The washer shall be constructed so that it can be satisfactorily cleaned. It shall also be equipped with temperature and pressure controls to ensure satisfactory cleaning of the hoops or barrels. It should be adequately vented to the outside.

xiv. Cheese Vacuumizing Chamber. The vacuum chamber shall be satisfactorily constructed and maintained so that the product is not contaminated with rust or flaking paint. An inner liner of stainless steel or other corrosion resistant material should be provided.

xv. Monorail. The monorail shall be constructed so as to prevent foreign material from falling on the cheese or cheese containers.

xvi. Conveyor for moving and draining block or barrel cheese. The conveyor shall be constructed so that it will be easily cleaned. It shall be installed so that the press drippings will not cause an environmental problem.

xvii. **Rindless Cheese Wrapping Equipment.** The equipment used to heat seal the wrapper applied to rindless cheese shall have square interior corners, reasonably smooth interior surfaces and have controls that shall provide uniform pressure and heat to all surfaces. The equipment used to apply shrinkable wrapping material to rindless cheese shall operate to maintain the natural intended shape of the cheese in an acceptable manner, reasonably smooth surfaces on the cheese, and tightly adhere the wrapper to the surface of the cheese.

xviii. **Special Equipment.** All product contact areas of speciality equipment shall be constructed of stainless steel or of material approved in the 3-A Standards and constructed following 3-A Standards principles.

xix. **Washing Machine.** When used, the washing machine for cheese cloths and bandages shall be of commercial quality and size; or of sufficient size to handle the applicable load. It should be equipped with temperature and water level controls.

8. **Packaging, cutting, slicing, repackaging of aged cheese.**

a. The packaging, cutting, slicing or repackaging of aged cheese shall be conducted under rigid sanitary conditions that preclude contamination of the product.

b. The plant shall submit detailed plans of the equipment and procedures to be used in these operations to the state health officer for written approval prior to beginning such operations.

AUTHORITY NOTE: Promulgated in accordance with the provisions of R.S. 40:4(A)(1)(a). Also see R.S. 40:5(2)(3)(5)(7)(15)(17) and R.S. 40:922.

HISTORICAL NOTE: Promulgated by the Department of Health and Hospitals, Office of Public Health, LR 37:2714 (September 2011).

§2509. Additional Requirements for Pasteurized Process Cheese Manufacturing Plants

A. All pasteurized process cheese and cheese related products shall conform with the standards of identify contained in the Code of Federal Regulations.

B. Dairy plants that manufacture, process or package process cheese or cheese related products shall conform with all of the requirements for cheese manufacturing plants contained in this Part and shall conform with the following additional requirements:

1. Milk used in the manufacture of pasteurized process cheese and cheese related products shall be derived from Grade A raw milk for pasteurization or manufacturing grade raw milk for pasteurization from a source approved by the state health officer

2. Milk and milk products used in the manufacture of pasteurized process cheese or cheese related products shall be pasteurized, ultra-pasteurized or aseptically processed in accordance with the requirements for pasteurization or ultra-pasteurization contained in this Part.

3. Conveyors shall be constructed of material which can be properly cleaned, will not rust, or otherwise contaminate the cheese and shall be maintained in good repair.

4. The grinders or shredders used in the preparation of the trimmed and cleaned natural cheese for the cookers shall be adequate in size. Product contact surfaces shall be of corrosion resistant material, and of such construction as to prevent contamination of the cheese and to allow thorough cleaning of all parts and product contact surfaces.

5. The cookers shall be the steam jacketed or direct steam type. They shall be constructed of stainless steel or other equally corrosion-resistant material. All product contact surfaces shall be readily accessible for cleaning. Each cooker shall be equipped with an indicating thermometer, and shall be equipped with a temperature recording device. The recording thermometer stem may be placed in the cooker. Steam check valves on direct steam type cookers shall be mounted flush with cooker wall, be constructed of stainless steel and designed to prevent the backup of product into the steam line, or the steam line shall be constructed of stainless steel pipes and fittings which can be readily cleaned. If direct steam is applied to the product only culinary steam shall be used.

6. The hoppers of all fillers shall be covered but the cover may have sight ports. If necessary, the hopper may have an agitator to prevent buildup on side walls. The filler valves and head shall be kept in good repair and capable of accurate measurements.

7. The natural cheese shall be cleaned free of all nonedible portions. Paraffin and bandages as well as rind surface, mold, or unclean areas or any other part which is unwholesome or unappetizing shall be removed.

8. Each batch of cheese within the cooker, including the optional ingredients shall be thoroughly commingled and the contents pasteurized at a temperature of at least 70°C (158°F) and held at that temperature for not less than 30 seconds. Care shall be taken to prevent the entrance of cheese particles or ingredients after the cooker batch of cheese has reached the final heating temperature. After holding for the required period of time, the hot cheese shall be emptied from the cooker as quickly as possible.

9. Containers, either lined or unlined, shall be assembled and stored in a sanitary manner to prevent contamination. The handling of containers by filler crews shall be done with extreme care and observance of personal cleanliness. Performing and assembling of pouch liners and containers shall be kept to a minimum and the supply rotated to limit the length of time exposed to possible contamination prior to filling.

10. Hot fluid cheese from the cookers may be held in hot wells or hoppers to assure a constant and even supply of processed cheese to the filler or slice former. Filler valves shall effectively measure the desired amount of product into the pouch of containers in a sanitary manner and shall cut off sharply without drip or drag of cheese across the opening.

An effective system shall be used to maintain accurate and precise weight control. Damaged or unsatisfactory packages shall be removed from production, and the cheese may be salvaged into sanitary containers, added back to cookers and recooked prior to repackaging.

AUTHORITY NOTE: Promulgated in accordance with the provisions of R.S. 40:4(A)(1)(a). Also see R.S. 40:5(2)(3)(5)(7)(15)(17) and R.S. 40:922.

HISTORICAL NOTE: Promulgated by the Department of Health and Hospitals, Office of Public Health, LR 37:2716 (September 2011).

§2511. Additional Requirements for Cheese Manufacturing Plants that Manufacture, Process or Package Unripened Cheese

A. Dairy plants that manufacture, process or package unripened cheese shall conform with all of the requirements for cheese manufacturing plants contained in this Part and shall conform with the following additional requirements.

1. Milk and milk products used in the manufacture of unripened cheese and related products shall be from a Grade A raw milk for pasteurization source approved by the state health officer.

2. All milk and milk products used in the manufacture of unripened cheese and cheese related products shall be pasteurized, ultra-pasteurized or aseptically processed in accordance with the requirements for pasteurization, ultra-pasteurization or aseptic processing contained in this Part.

3. Milk and milk products including reconstituted milk or milk product shall be pasteurized, ultra-pasteurized or aseptically processed in the plant in which the unripened cheese or cheese related products are manufactured or processed, provided that the state health officer may authorize cheese manufacturing plants that comply with the requirements of §2513 of this Part to manufacture or process unripened cheese or cheese related products from milk or milk products pasteurized, ultra-pasteurized or aseptically processed in other plants.

4. Rooms and compartments. Processing operations with open cheese vats in them shall be separated from other rooms or areas.

a. Processing and packaging rooms shall be adequately ventilated to maintain sanitary conditions, preclude the growth of mold and airborne contaminants, prevent condensation, and to minimize objectionable odors.

b. Starter rooms or areas shall be properly equipped and maintained for the propagation and handling of starter cultures.

c. Coolers shall be equipped with the facilities necessary for maintaining proper temperature and humidity, consistent with GMPs for the applicable product and to prevent contamination of the products.

5. Packaging. Packaging of unripened cheese and cheese related products shall be done in a sanitary manner with mechanical equipment that complies with applicable 3-A Sanitary Standards.

a. Packaging materials for unripened cheese or cheese related products shall provide sufficiently low permeability to air and moisture and shall be resistant to puncturing, tearing, cracking or fragmentation. Any materials used in the package or packaging that has contact with product shall conform with this requirement. Approval of the state health officer shall be obtained for all packaging materials prior to use.

b. Upright open containers and closures shall be protected from contamination by overhead shields.

c. Single service containers and closures and other single service articles for use in contact with dairy products shall be of sanitary design and construction and from sources approved by the state health officer. They shall be stored in their original containers or in equipment designed for storage of single service articles, shall be kept therein in a clean, dry place until used and shall be handled in a sanitary manner.

d. Caps or covers which extend over the lip of the container shall be used on all cups or tubs of two pounds or less.

e. Capping or closing of containers of two pounds or less shall be done in a sanitary manner using mechanical equipment that complies with applicable 3-A Sanitary Standards. Hand capping of such containers shall be prohibited.

f. A date, code or lot number that identifies the date, run or batch from which the contents originated, shall be prominently displayed on each final container (container that will reach the final consumer) of dairy product in indelible ink (or equivalent). The date, code or batch shall be printed on the container or label in such a manner that it cannot be removed, changed or defaced.

6. The cheese manufacturing plant shall:

a. obtain a representative sample of each batch or lot of cheese or related cheese product, manufactured or processed by the plant. Normally, this shall be done by collecting a closed final container of the cheese or the cheese related product, randomly selected, and perform or have a coliform count performed on the sample;

b. perform the sampling procedures and laboratory examination in substantial compliance with the procedures contained in the *Standard Methods for the Examination of Dairy Products*;

c. record the results of each test and retain the record for a period of one year after the date that the product was produced. These records shall be made available for review by the state health officer;

d. immediately take steps to determine and eliminate the cause when the coliform count of a sample of product exceeds 10 per gm; and

e. maintain a record, for review by the state health officer, of action taken to correct the cause of each coliform count that exceeded 10 per gm. Such records shall be

retained for a period of one year after the date the product was produced.

B. Unripened cheese and cheese related products shall conform with the following bacteriological, chemical and temperature standards:

- a. temperature—cooled to 7°C (45° F) or less prior to final storage and maintained thereat;
- b. coliform count—not to exceed 10 per gram; and,
- c. pathogens—no pathogenic microorganisms of human significance;

C. During any consecutive six months at least four samples of each type of cheese manufactured or processed by each plant shall be taken by the state health officer and tested for coliform count. The state health officer shall take appropriate regulatory action on violative sample results, as prescribed in §331 of this Part.

AUTHORITY NOTE: Promulgated in accordance with the provisions of R.S. 40:4(A)(1)(a). Also see R.S. 40:5(2)(3)(5)(7)(15)(17) and R.S. 40:922.

HISTORICAL NOTE: Promulgated by the Department of Health and Hospitals, Office of Public Health, LR 37:2716 (September 2011).

§2513. Additional Requirements for Cheese Manufacturing Plants that Manufacture or Process Unripened Cheese or Cheese Related Products from Milk or Milk Products that were Pasteurized, Ultra-pasteurized or Aseptically Processed at Other Plants without Repasteurization

A. Cheese manufacturing plants that manufacture or process unripened cheese or cheese related products from milk or milk products that were pasteurized, ultra-pasteurized or aseptically processed at another plant without being repasteurized shall conform with all of the requirements for unripened cheese contained in this Part and with the following additional requirements.

1. All milk or milk products used in the manufacture or processing of unripened cheese or cheese related products shall be Grade A pasteurized or Grade A ultra-pasteurized or aseptically processed and obtained from a plant possessing a valid permit from the state health officer.
2. All reconstituted milk or milk products shall be pasteurized, ultra-pasteurized or aseptically processed in the dairy plant in which it was reconstituted and shall be obtained from a plant possessing a valid permit from the state health officer.
3. All milk and milk products, including reconstituted milk and milk products shall be packaged and transported in sealed containers, approved by the state health officer.
4. Cheese manufacturing plants that manufacture or process unripened cheese made from milk or milk products pasteurized or ultra-pasteurized at another plant without being re-pasteurized or ultra-pasteurized shall develop and

implement a HACCP system conforming with the requirements contained in Chapter 11 of this Part.

5. The cheese manufacturing plant shall:

- a. obtain a representative sample of each batch or lot of cheese or related cheese product, manufactured or processed by the plant. Normally, this shall be done by collecting a closed final container of the cheese or the cheese related product, randomly selected, and perform or have a coliform count performed on the sample;
- b. perform the sampling procedures and laboratory examination in substantial compliance with the procedures contained in the *Standard Methods for the Examination of Dairy Products*;
- c. record the results of each test and retain the record for a period of one year after the date that the product was produced. These records shall be made available for review by the state health officer;
- d. immediately take steps to determine and eliminate the cause when the coliform count of a sample of product exceeds 10 per gm; and,
- e. maintain a record, for review by the state health officer, of action taken to correct the cause of each coliform count that exceeded 10 per gm. Such records that shall be retained for a period of one year after the date the product was produced.

B. Unripened cheese and related products shall conform with the following bacteriological and temperature standards:

1. temperature—cooled to 7°C (45°F) prior to final storage and maintained thereat;
2. coliform count—not to exceed 10 per gram; and,
3. pathogens—no pathogenic microorganisms of human significance.

C. During any consecutive six months, at least four samples of pasteurized or ultra-pasteurized milk or milk products to be used in the manufacture or processing unripened cheese or cheese related products shall be taken by the state health officer at the cheese manufacturing plant after receipt of the milk by the plant and prior to being manufactured or processed and tested for standard plate count, coliform count, temperature. The state health officer shall take appropriate regulatory action, as prescribed in §331 of this Part, on violative sample results.

D. During any consecutive six months at least four samples of each type of cheese manufactured or processed by each plant shall be taken by the state health officer and tested for coliform count. The state health officer shall take appropriate regulatory action, as prescribed in §331 of this Part, on violative sample results.

AUTHORITY NOTE: Promulgated in accordance with the provisions of R.S. 40:4(A)(1)(a). Also see R.S. 40:5(2)(3)(5)(7)(15)(17) and R.S. 40:922.

HISTORICAL NOTE: Promulgated by the Department of Health and Hospitals, Office of Public Health, LR 37:2717 (September 2011).

Chapter 27. Frozen Desserts

§2701. Approval of Plans

A. All frozen dessert manufacturing plants that are domiciled within the state and are hereafter constructed, reconstructed or altered shall conform in their construction and operation with the requirements of this Part. Prior to construction, reconstruction or alteration, written approval of plans and specifications shall be obtained from the state health officer.

B. Prior to installation or modification, written approval shall be obtained from the state health officer of plans and specifications for the design, construction and manner of employment for all equipment.

C. Written detailed plans describing the processing of each product shall be submitted to the state health officer for approval prior to the manufacture of each product and prior to any product or process change.

AUTHORITY NOTE: Promulgated in accordance with the provisions of R.S. 40:4(A)(1)(a). Also see R.S. 40:5(2)(3)(5)(7)(15)(17) and R.S. 40:922.

HISTORICAL NOTE: Promulgated by the Department of Health and Hospitals, Office of Public Health, LR 37:2718 (September 2011).

§2703. Basic Requirements for Frozen Dessert Manufacturing Plants

A. All frozen dessert manufacturing plants that manufacture, process or freeze frozen desserts shall conform with the following general requirements for dairy plants:

1. definitions (in accordance with §101 of this Code);
2. standards of identity (in accordance with §107 of this Part);
3. permits (in accordance with §109 of this Part);
4. permits required for imported milk, milk products and frozen desserts (in accordance with , §111 of this Part);
5. requirements for imported dairy products (in accordance with §113 of this Part);
6. milk records (in accordance with §115 of this Part);
7. falsification of records (in accordance with §117 of this Part);
8. registration (in accordance with §119 of this Part);
9. labeling (in accordance with §121 of this Part);
10. delivery of samples (in accordance with §303 of this Part);
11. pasteurization equipment tests, examination and sealing (in accordance with §313 of this Part);

12. application for regrading, reinstatement of permit and permission to resume sale of product (in accordance with §341 of this Part);

13. regrading and reinstatement of permit when degrade or suspension was based on physical violations (in accordance with §345 of this Part);

14. reinstatement of permit when suspension was based upon adulteration of product or contamination of pasteurized product or cheeses with pathogenic microorganisms of human significance (in accordance with §347 of this Part);

15. milk tank trucks (in accordance with §701 of this Part);

16. sealing and protection of milk tank trucks (in accordance with §703 of this Part);

17. labeling (in accordance with §705 of this Part);

18. general requirements (in accordance with §901 of this Part);

19. approval of plans (in accordance with §903 of this Part);

20. raw milk receiving (in accordance with §905 of this Part);

21. dairy plant receivers/samplers (in accordance with §907 of this Part);

22. receiving and handling of milk derived and non-dairy ingredients (in accordance with §909 of this Part);

23. immediate surroundings (in accordance with §911 of this Part);

24. floors (in accordance with §913 of this Part);

25. walls and ceilings (in accordance with §915 of this Part);

26. doors and windows (in accordance with §917 of this Part);

27. light and ventilation (in accordance with §919 of this Part);

28. separate rooms (in accordance with §921 of this Part);

29. toilet facilities (in accordance with §923 of this Part);

30. water supply (in accordance with §925 of this Part);

31. hand washing facilities (in accordance with §927 of this Part);

32. protection from contamination (in accordance with §929 of this Part);

33. reclaim or rework operations (in accordance with §931 of this Part);

34. dairy plant cleanliness (in accordance with §933 of this Part);

- 35. sanitary piping (in accordance with §935 of this Part);
- 36. construction and repair of containers and equipment (in accordance with §937 of this Part);
- 37. thermometers (in accordance with §939 of this Part);
- 38. pasteurization, ultra pasteurization and aseptic processing (in accordance with §941 of this Part);
- 39. cleaning and sanitization of containers and equipment (in accordance with §943 of this Part);
- 40. storage of cleaned containers and equipment (in accordance with §945 of this Part);
- 41. storage of single-service containers, utensils and materials (in accordance with §947 of this Part);
- 42. packing, bottling and wrapping (in accordance with §949 of this Part);
- 43. capping (in accordance with §951 of this Part);
- 44. delivery containers (in accordance with §953 of this Part);
- 45. cooling of milk and dairy products (in accordance with §955 of this Part);
- 46. use of overflow, leaked, spilled or mishandled dairy products (in accordance with §957 of this Part);
- 47. dipping or transferring dairy products (in accordance with §965 of this Part);
- 48. apparatus, containers, equipment and utensils (in accordance with §967 of this Part);
- 49. personnel health (in accordance with §969 of this Part);
- 50. notification of disease (in accordance with §971 of this Part);
- 51. procedure when infection suspected (in accordance with §973 of this Part);
- 52. personal cleanliness (in accordance with §975 of this Part);
- 53. allergen and sensitivity producing ingredient (in accordance with §977 of this Part);
- 54. rat proofing (in accordance with §985 of this Part);
- 55. waste disposal (in accordance with §987 of this Part); and
- 56. vehicles (in accordance with §989 of this Part).

AUTHORITY NOTE: Promulgated in accordance with the provisions of R.S. 40:4(A)(1)(a). Also see R.S. 40:5(2)(3)(5)(7)(15)(17) and R.S. 40:922.

HISTORICAL NOTE: Promulgated by the Department of Health and Hospitals, Office of Public Health, LR 37:2718 (September 2011).

Subchapter A. Supplemental Requirements for Dairy Plants that Manufacture Frozen Desserts

§2705. General Information

A. Dairy plants that manufacture frozen desserts including frozen dessert mixes shall conform with the basic requirements for frozen dessert manufacturing plants in §2703 of this Part and with the following additional requirements.

1. If the powdered or dry frozen dessert mix contains any dairy product, egg ingredient or other potentially hazardous food ingredient, the mix shall be pasteurized, ultra pasteurized or aseptically processed following reconstitution using pasteurization, ultra pasteurization or aseptic processing methods specified in this Part.

2. Optional dairy ingredients shall be derived from Grade A raw milk for pasteurization or manufacturing grade raw milk for pasteurization (milk for manufacturing purposes) obtained from sources that are in substantial compliance with the requirements of this Part and are approved by the state health officer.

3. Dry dairy products used in the manufacture of frozen desserts for which grades and grading criteria are specified in this Part shall be Grade A or extra grade. Products of a lower grade shall not be used.

4. Non-milk derived ingredients used in the manufacture of frozen desserts shall have been determined by the FDA to be GRAS for use in frozen desserts.

5. All dairy ingredients used in the manufacture of frozen desserts shall be produced, packed, held and shipped in a manner consistent with the requirements of this Part.

6. All non-milk derived ingredients shall be purchased only from suppliers which certify or guarantee that their product has been produced and handled in a manner that will assure a safe and wholesome ingredient which will not adulterate the finished product. Records of such verification or guarantee shall be available for review by the state health officer.

7. A safety and quality inspection of all incoming non-milk derived ingredients shall be performed. Records of the results of these inspections, corrective actions taken when problems are identified and the date and initials of the person performing the inspection shall be maintained and made available to the state health officer. The inspection shall include an evaluation for conditions related to:

- a. product identity and labeling;
- b. package condition and integrity;
- c. bulging;
- d. leaking;
- e. dirt/grime;
- f. insect infestation;

g. rodent damage; and

h. off-odors and non-food materials (especially toxic compounds) or residues of such materials in the truck or other conveyance.

8. All ingredients used in the manufacture of frozen desserts shall be stored and handled in such a manner as to preclude their contamination. Particular attention shall be given to closing or resealing of containers that have been opened and the contents of which have been partially used.

9. Dusty raw ingredient blending or liquification operations which create powdery conditions shall not be conducted in areas where pasteurized products are handled or stored.

10. Mix preparation operations in which ingredients are exposed shall be conducted in processing areas. Except when ingredients are being added, all openings into vessels and lines containing product shall be covered. The outer box or wrapper of powdered ingredients shall be removed prior to dumping into mixing vessels.

11. All liquid ingredients which will support bacterial growth shall be kept or immediately cooled to 7°C (45°F) or below.

12. Pasteurization, ultra-pasteurization and aseptic processing shall be performed on the following products.

a. All frozen dessert mixes, dairy and non-dairy shall be pasteurized, ultra-pasteurized or aseptically processed, provided that the state health officer may exempt some specific frozen dessert mixes that do not contain dairy ingredients and do not support the growth of pathogenic microorganisms of human significance from this requirement dependent upon their ingredients and manner of processing.

b. Pasteurization, ultra-pasteurization and aseptic processing of frozen dessert mixes shall be performed in equipment and using procedures that conform with the requirements of the *PMO* for pasteurization and with current applicable 3-A sanitary standards as approved by the state health officer.

c. Frozen desserts to be sold or distributed to retail outlets shall be frozen and packaged at the plant in which the frozen dessert mix was made and pasteurized provided that the state health officer may authorize dairy plants that have implemented HACCP systems that comply with the requirements of this Part to freeze, partially freeze or package frozen desserts from mixes that were pasteurized, ultra-pasteurized or aseptically processed in other plants.

i. The following minimum times and temperatures shall apply to pasteurization of frozen dessert mixes:

- (a). 68°C (155°F) for 30 minutes;
- (b). 79°C (175°F) for 25 seconds;
- (c). 82°C (180°F) for 15 seconds;

(d). 88°C (191°F) for 1.0 second;

(e). 90°C (194°F) for 0.5 second;

(f). 93°C (201°F) for 0.1 second;

(g). 95°C (204°F) for 0.05 second; and,

(h). 100°C (212°F) for 0.01 second.

d. Should scientific evidence indicate that the above temperatures or times are not adequate to destroy pathogenic microorganisms of human significance or for any other reason, may not be adequate to protect the public's health, the state health officer may, with the concurrence of the FDA, immediately require that all pasteurized dairy products sold in the state be pasteurized at temperatures or times recommended to be adequate by the FDA. Should the FDA hereafter determine that any of the requirements for pasteurization or ultra-pasteurization contained in the *PMO* are not adequate to protect the public's health and require a change in any of the aforesaid requirements, the state health officer shall immediately require that all pasteurization or ultra-pasteurized products sold in the state conform with the new FDA requirements for pasteurization or ultra-pasteurization. Nothing shall be construed as barring any other pasteurization process, which has been recognized by the FDA to be equally efficient and which is approved by the state health officer.

13. The only ingredients that shall be added after pasteurization, ultra-pasteurization or aseptic processing are the following flavoring and coloring ingredients:

- a. those subjected to prior heat treatment sufficient to destroy pathogenic microorganisms;
- b. those of 0.85 percent water activity or less;
- c. those with a pH of less than 4.7;
- d. roasted nuts (added at freezer);
- e. those that contain high alcohol content;
- f. bacterial cultures; and
- g. those that have been subjected to any other process which will assure that the ingredient is free of pathogenic microorganisms of human significance.

14. Reclaim or Rework Operations. Reclaim or rework operations are all activities associated with the recovery, handling, and storage of processed or partially processed products for use as an ingredient in products to be used for human consumption.

a. Product that has entered the distribution channels or has been temperature-abused, tampered with or exposed to chemical or biological contamination shall not be reclaimed or reworked for use as an ingredient in other products for human consumption.

b. Reclaimed or reworked products and reclaim or rework operations shall conform with the following requirements.

i. Reclaim areas and equipment shall be constructed, maintained and protected in a manner that is in substantial compliance with the requirements for production and processing areas contained in this Part.

ii. Products that have left the premises of the plant in which it was packaged shall not be reclaimed or reworked.

iii. All products to be reclaimed shall be maintained at 7°C (45°F) or below. Product salvaged from defoamers and tank or line rinsing shall be immediately cooled to 7°C (45°F) or below.

iv. Packages of products to be reclaimed or reworked shall be clean and free of contamination. Products from leaking or badly damaged containers shall not be reclaimed or reworked.

v. Packaged products shall be opened in such a manner as to minimize the potential for contamination. Containers shall not be opened by slashing, smashing or breaking.

vi. Woven wire strainers shall not be used in reclaim or rework operations.

vii. Reclaim or rework dump stations and tanks shall be covered except when products are actually being dumped through the openings.

viii. Reclaim or rework storage tanks shall be equipped with adequate thermometers.

ix. Reclaimed or reworked products shall be handled as a raw dairy ingredient.

x. Cleaning and sanitizing requirements shall be the same as those for other raw ingredient handling equipment.

xi. It is recommended that higher than minimum temperatures and times be used in the pasteurization of product containing reclaimed or reworked ingredients.

xii. The dairy plant shall take appropriate steps to preclude the contamination of products or equipment with allergenic and sensitivity producing reclaim or reworked ingredients or substances that will not be appropriately declared in the labeling of the final container of product.

15. Allergen and Sensitive Producing Ingredients Control

a. Due to the large number of allergens and sensitivity producing ingredients usually present in frozen dessert operations, each plant shall have a trained individual study each ingredient used in the plant and the processing steps and sequence used in the manufacture of each product. He shall determine where, how and when potentials exist for an allergen to inadvertently enter products.

b. The plant shall take appropriate steps to preclude the contamination of all products with allergens and sensitive producing ingredients that will not be declared in the labeling of the final container of each product.

16. Packaging of Frozen Desserts. Frozen dessert products shall be packaged in unused single service containers, obtained from a source approved by the state health officer, which protects the contents from contamination and after packaging shall be stored in a sanitary manner.

a. Packaging and closing or capping of all containers of half-gallon or less shall be performed in a sanitary manner in mechanical equipment that conforms with the applicable 3-A Sanitary Standards. Hand capping of such containers is prohibited.

b. Upright open containers and all closures shall be protected from contamination by overhead shields.

c. Caps or covers shall extend over the lip of the container on all cups, tubs or containers of can-type configuration.

d. A date, code or lot number that identifies the date, run or batch from which the contents originated, shall be prominently displayed on each final container (container that will reach the final consumer) of dairy product in indelible ink (or equivalent). The date, code or batch shall be printed on the container or label in such a manner that it cannot be removed, changed or defaced.

17. All frozen desserts including frozen dessert mixes shall conform with the standards of identity prescribed by this Part.

18. Frozen desserts, including frozen dessert mixes shall conform with the following temperature and bacteriological standards:

a. cooled to 7°C (45°F) or less and maintained thereat;

b. bacteriological limits—not to exceed 50,000 cfu per gm (Cultured products are exempt from this requirement);

c. coliform count limits—not to exceed 10 per gram, except that the coliform count of those frozen desserts which contain fruit, nuts, chocolate or other bulky flavors shall not exceed 20 per gram; and,

d. pathogens—no pathogenic microorganisms of human significance.

AUTHORITY NOTE: Promulgated in accordance with the provisions of R.S. 40:4(A)(1)(a). Also see R.S. 40:5(2)(3)(5)(7)(15)(17) and R.S. 40:922.

HISTORICAL NOTE: Promulgated by the Department of Health and Hospitals, Office of Public Health, LR 37:2719 (September 2011).

§2707. Additional Requirements for Frozen Dessert Manufacturing Plants that Have Been Authorized by the State Health Officer to Freeze or Partially Freeze and Package Frozen Desserts Made from Frozen Dessert Mixes that were Pasteurized, Ultra-pasteurized or Aseptically Processed at Another Plant

A. The plant shall implement a HACCP system, approved by the state health officer, that conform with the requirements contained in Chapter 11 of this Part.

B. Frozen dessert manufacturing plants that have been authorized by the state health officer to freeze or partially freeze and package frozen desserts made from frozen dessert mixes that were pasteurized, ultra-pasteurized or aseptically processed at another plant without being repasteurized or ultra-pasteurized again shall conform with all of the requirements for frozen dessert manufacturing plants contained in this Part and shall conform with the following additional requirements.

1. All frozen dessert mixes shall have been manufactured in dairy plants possessing a valid permit from the state health officer.

2. All reconstituted mixes shall be pasteurized, ultra-pasteurized or aseptically processed in the plant in which it was reconstituted.

3. All frozen dessert mixes shall be packaged and transported in sealed containers which have been approved by the state health officer.

4. Each plant shall develop and implement a HACCP system conforming with the HACCP requirements contained in this Part and shall be approved by the state health officer.

C. During any consecutive 6 months one sample of each fat level of product packaged by the plant shall be taken by the state health officer and tested for standard plate count and coliform count. The state health officer shall take appropriate regulatory action on violative sample results as prescribed in §331 of this Part.

AUTHORITY NOTE: Promulgated in accordance with the provisions of R.S. 40:4(A)(1)(a). Also see R.S. 40:5(2)(3)(5)(7)(15)(17) and R.S. 40:922.

HISTORICAL NOTE: Promulgated by the Department of Health and Hospitals, Office of Public Health, LR 37:2721 (September 2011), amended by the Department of Health, Office of Public Health, LR 46:356 (March 2020).

Subchapter B. Frozen Dessert Retail Requirements

**§2709. Counter Freezers
[formerly paragraph 8:013]**

A. The processing, handling, and distribution of milk and milk products in the manufacture of frozen desserts shall conform to the minimum requirements for Grade A milk as prescribed in this Part. All milk and milk products shall be of quality approved by the state health officer. Counter freezer

operations which freeze mixes and sell only at retail on the premises shall comply with the following requirements:

1. only mixes that have been processed and packaged in an approved plant shall be allowed;

2. counter freezers used for freezing mixes which contain milk solids, milk fat, or vegetable fat shall be located only in premises which meet the minimum requirements for retail food establishments as prescribed in Part XXIII of this Code;

3. the frozen dessert operator shall be a food handler other than the cashier of a grocery or convenience store;

4. ice cream, ice milk and other frozen desserts shall be offered to consumers who serve themselves only when dispensed from approved dispensing machines designed expressly for that purpose;

5. the dipping and/or packaging of firmly frozen frozen desserts by consumers who serve themselves is prohibited.

AUTHORITY NOTE: Promulgated in accordance with the provisions of R.S. 40:4.A.(1)(a). Also see R.S. 40:5(2)(3)(5)(7)(15)(17) and R.S. 40:922.

HISTORICAL NOTE: Promulgated by the Department of Health and Hospitals, Office of Public Health, LR 37:2722 (September 2011).

**§2711. Mobile Frozen Dessert Units
[formerly paragraph 8:021]**

A. All milk and milk products used in the manufacture of frozen desserts shall be of a quality approved by the state health officer. The processing, handling and distribution of milk and milk products as well as the building, equipment, and other entities used in the manufacture of frozen desserts shall conform to the requirements for Grade A milk in this Part. In addition, mobile frozen dessert units shall comply with the following requirements.

1. Each operator of a mobile frozen dessert unit shall obtain a permit to operate from the state health officer.

2. Truck interior shall be completely enclosed with the exception of serving windows and shall be of sufficient size with equipment and fixtures conveniently located so as to render efficient and sanitary operation.

3. Serving openings shall not be larger than 18 inches wide and 28 inches high, and there shall not be more than two serving openings to each mobile unit. The serving openings shall be closed at all times that the operator of the mobile unit is not actually dispensing frozen desserts.

4. A potable water supply tank, minimum capacity of 40 gallons, heated electrically or otherwise, and tilted toward a capped drain cock, shall be provided. Water inlet pipe shall be of removable flexible copper or other tubing approved by the state health officer, with nozzle for hose connection capped when not being used. The tank shall be provided with permanent vacuum breaker properly mounted (6 inches above top of tank). Tank shall be vented and screened with copper, brass or bronze screen. Hose and rack for connection

to potable water supply shall be provided. An approved gauge shall be provided to determine content levels.

5. A three-compartment seamless sink supplied with running hot and cold water, equipped with a swivel faucet, shall be provided. Each compartment shall be large enough to accommodate the largest piece of equipment to be cleansed therein. Said sink shall be trapped and vented.

6. A hand sink, seamless, with running hot and cold water, soap and single service or individual towels, shall be provided. The sink shall be trapped and vented.

7. A suitable waste tank with capacity of at least 15 percent larger than the water supply tank, shall be provided, tilted toward a drain cock with an adequate method of gauging the contents. It shall be emptied and flushed as often as necessary in a sanitary manner. All connections on the vehicle for servicing the waste tank shall be of different size or shape than those used for supplying potable water. The waste connection shall be located lower than the water inlet connection to preclude contamination of the potable water system. An approved gauge shall be provided to determine content levels.

8. A refrigerator box, constructed of stainless steel or other noncorrosive material and equipped with an indicating thermometer shall be provided. Metal racks or platforms shall be provided to store all ingredients.

9. Floors of the mobile unit shall be of material approved by the state health officer. Junctures of floors, wall and adjoining fixtures shall be watertight and covered. The floors shall be kept clean and dry at all times during the operation of the mobile unit.

10. Only mixes that have been processed and packaged in a plant approved by the state health officer shall be allowed, and mixes which require reconstitution are not allowed.

11. A covered waste can or container of sufficient size shall be provided for daily needs, constructed, designed and placed for ready cleaning. An easily accessible covered waste can or container shall be provided for customer's use. It shall be readily cleanable and kept clean, so located as not to create a nuisance, and so labeled that the public will be informed.

12. The truck interior shall be provided with artificial light sufficient to provide 15 foot-candles of light in all areas.

13. Separation of partition (self-closing doors accepted) shall be made between driver's seat and manufacturing unit unless vehicle is air-conditioned.

14. Persons preparing and handling frozen desserts shall wear clean, washable clothing, and effective, clean hair restraints.

15. The original frozen dessert permit to operate shall be displayed on each vehicle with photostat posted in operator's depot.

16. Each mobile unit shall display a sign advising the public of the type of frozen dessert being sold (e.g., ice milk, ice cream, etc.). The sign shall be printed in letters at least 8 inches in height.

AUTHORITY NOTE: Promulgated in accordance with the provisions of R.S. 40:4.a.(1)(a). Also see R.S. 40:5(2)(3)(5)(7)(15)(17) and R.S. 40:922.

HISTORICAL NOTE: Promulgated by the Department of Health and Hospitals, Office of Public Health, LR 37:2722 (September 2011).

§2713. Depots for Mobile Frozen Dessert Units [formerly paragraph 8:022]

A. All mobile units shall operate from depots and shall report to their respective depot for cleaning and sanitizing at least once each day. All depots shall comply with the following requirements.

1. All plans and specifications for depots shall be approved by the state health officer prior to construction of same in accordance with §1701.A of this Part. Structurally the building shall comply with the provisions of §1703 of this Part.

2. For washing purposes there shall be at least three large sinks, each of which shall be large enough to accommodate the largest piece of equipment to be washed. Sinks are to be provided with drainboards of impervious material.

3. A metal pipe drying rack for utensils shall be provided.

4. Clothes lockers and garbage cans shall be provided.

5. Adequate storage for perishable materials shall be provided.

6. A separate room shall be provided for the storage of all non-perishable food and paper products.

7. Adequate facilities shall be provided for the washing of vehicles.

AUTHORITY NOTE: Promulgated in accordance with the provisions of R.S. 40:4.A(1)(a). Also see R.S. 40:5(2)(3)(5)(7)(15)(17) and R.S. 40:922.

HISTORICAL NOTE: Promulgated by the Department of Health and Hospitals, Office of Public Health, LR 37:2723 (September 2011).

Chapter 29. Standards for the Fabrication of Single Service Containers and Closures for Milk and Milk Products Including Fabricating Plants Producing Component Parts, Films and Closures

§2901. General Requirements

A. The following criteria pertains to manufactures of preforms and bottles preformed at one plant and molded at a second plant:

1. The preforming plant must be IMS listed, but sampling of the pre-form is not required at this plant.

2. If the first preforming plant is also molding the containers into their final form, this plant must be IMS listed and the containers must be sampled at this plant.

3. If the second plant, where containers are molded into their final form, is a single-service manufacturer, this plant must be IMS listed and the containers must be sampled at this plant.

4. If the second plant is a milk plant where containers are molded into their final form, for use only in that milk plant, the milk plant listing is sufficient, but the containers shall be sampled at this plant.

AUTHORITY NOTE: Promulgated in accordance with the provisions of R.S. 40:4(A)(1)(a). Also see R.S. 40:5(2)(3)(5)(7)(15)(17) and R.S. 40:922.

HISTORICAL NOTE: Promulgated by the Department of Health and Hospitals, Office of Public Health, LR 37:2723 (September 2011).

§2903. Approval of Plans

A. All plants domiciled within the state, in which single service milk containers or closures are manufactured, shall conform in their construction to the requirements of these regulations. Equipment and installation of all equipment used in single service milk container or closure manufacturing plants shall conform in design, construction and manner in which it is installed and used, to the requirements of these regulations. Written approval of plans for construction, reconstruction or alteration shall be obtained from the state health officer prior to construction, reconstruction or alteration. Written approval of plans for the design, construction, installation and employment for all equipment used in the single service milk container or closure manufacturing plant shall be obtained from the state health officer prior to the installation or modification of the equipment.

AUTHORITY NOTE: Promulgated in accordance with the provisions of R.S. 40:4(A)(1)(a). Also see R.S. 40:5(2)(3)(5)(7)(15)(17) and R.S. 40:922.

HISTORICAL NOTE: Promulgated by the Department of Health and Hospitals, Office of Public Health, LR 37:2723 (September 2011).

§2905. Bacterial Standards and Examination of Single Service Containers and Closures

A. Paper stock shall meet the bacteriological standard of not more than 250 cfu per gram as determined by the disintegration test. The supplier of the paper stock shall certify that his/her paper stock was manufactured in compliance with this standard. This applies only to the paper stock prior to lamination.

B. Where a rinse test can be used, the residual microbial count shall not exceed 50 cfu per container, except that in containers less than 100 ml., the count shall not exceed 10 cfu, or not over 50 cfu per eight square inches (one cfu per square centimeter) of product contact surface when the swab test is used, in three out of four samples taken at random on

a given day. All single service containers and closures shall be free of coliform bacteria.

C. During any consecutive six months, at least four sample sets shall be collected in at least four separate months, except when three months show a month containing two sampling dates separated by at least 20 days, and analyzed at a laboratory approved by the state health officer.

D. When a single service container or closure is made from one or more component parts as defined in this document, only those final assembled products which may have product contact surface(s) must be sampled and tested for compliance.

E. All sampling procedures and required laboratory examinations shall be conducted in laboratories approved by the state health officer and shall be made in substantial compliance with the methods contained in the *Standard Methods for the Examination of Dairy Products*.

AUTHORITY NOTE: Promulgated in accordance with the provisions of R.S. 40:4(A)(1)(a). Also see R.S. 40:5(2)(3)(5)(7)(15)(17) and R.S. 40:922.

HISTORICAL NOTE: Promulgated by the Department of Health and Hospitals, Office of Public Health, LR 37:2723 (September 2011).

§2907. Single Service Milk Container or Closure Manufacturing Plant Standards

A. Floors. The floor of all fabricating areas shall be smooth, impervious and maintained in a state of good repair. The floor of storage rooms may be constructed of tightly joined wood.

1. The joints between the walls and floor shall be tight, impervious and shall have coved or sealed joints.

2. Where floor drains are provided, they shall be properly trapped and floors sloped to drain.

B. Walls and Ceilings. Walls and ceilings of fabricating areas shall have a smooth, cleanable, light colored surface.

1. Walls and ceilings in fabricating and storage areas shall be kept in good repair.

C. Doors and Windows. All outside openings shall be effectively protected against entry of insects, dust and airborne contamination.

1. All outer doors shall be tight and self closing.

D. Lighting and Ventilation. All rooms shall be adequately lighted by either natural light, artificial light or both. A minimum of 20-foot candles shall be maintained in fabricating areas and 5-foot candles should be maintained in storage areas. Packaging, sealing, wrapping, labeling and similar procedures are considered part of the fabricating area.

1. Ventilation shall be sufficient to prevent excessive odors and the formation of excessive water condensation.

2. The intake of all pressure ventilation systems in fabricating areas, whether they are positive or exhaust, shall be properly filtered.

E. Separate Rooms. All fabricating areas shall be separate from non fabricating areas to protect against contamination, provided, that if the entire plant meets all sanitation requirements and no source of cross contamination exists, separation between areas is not required.

1. All re-grinding of plastic and the shredding, packaging or baling of paper trim shall be conducted in rooms separate from the fabricating room except that they may be conducted within the fabricating room provided such operations are kept clean and free of dust.

F. Toilet Facilities-Sewage Disposal. Disposal of sewage and other wastes shall be in a public sewerage system, if available. If a public sewerage system is not available, the disposal of sewage and other wastes shall be done in a manner which is in compliance with Part XIII of this Code.

1. All plumbing shall comply with Part XIV of this Code and any stricter local plumbing regulations.

2. Toilet rooms shall have solid, tight-fitting doors that are self-closing.

3. The toilet room and fixtures shall be maintained in a clean and sanitary condition and in good repair.

4. Each toilet room shall be well lighted and adequately ventilated by mechanical means. Air ventilation ducts from toilet facilities shall directly vent to the outside atmosphere.

5. Proper hand washing facilities with hot and cold running water under pressure delivered through a mixing faucet shall be provided in toilet rooms.

6. All windows shall be effectively screened when open.

7. Signs shall be posted in all toilet rooms informing the employees that they shall wash their hands before returning to work.

8. Eating or storage of food is prohibited in toilet rooms.

9. A covered trash container shall be provided.

G. Water Supply. The water supply shall comply with Part XII of this Code.

1. There shall be no cross-connection between the potable water supply and any unsafe or questionable water supply or any source of pollution through which the potable water supply might become contaminated.

2. Samples for bacteriological testing of private water supplies are taken upon the initial approval of the physical structure, each 12 months thereafter, and when any repair or alteration of the water supply system has been made. The examination of the sample shall be conducted by a laboratory which has been certified by the state health officer for the examination of potable water for bacteriological contaminants.

H. Hand Washing Facilities. Hot and cold or warm running water delivered under pressure through a mixing faucet, soap, air dryer or individual sanitary towels shall be convenient to all fabricating areas, provided that solvent or soft soap dispensers containing sanitizers may be used if water is not available. When individual sanitary towels are used, covered trash containers shall be provided.

1. Hand washing facilities shall be kept clean.

I. Plant Cleanliness. The floors, walls, ceilings, overhead beams, fixtures, pipes and ducts of production, storage, re-grind, baling and compacting rooms shall be clean.

1. All production areas, warehouse, toilet, lunch and locker rooms shall be free of evidence of insects, rodents and birds.

2. Machines and appurtenances shall be kept clean. Provided, that minor accumulations of paper, plastic or metal dust and other production soils incidental to normal fabricating operations do not violate this requirement.

J. Locker and Lunch Rooms. Locker and lunch rooms shall be separate from plant operations and be equipped with self closing doors.

1. Eating or storage of food is prohibited in fabricating and storage areas.

2. Locker and lunch rooms shall be kept in a clean and sanitary condition.

3. Cleanable refuse containers, properly labeled, shall be provided which are covered, impervious, leak-proof and readily accessible.

4. Proper hand washing facilities shall be convenient to locker and lunch rooms.

5. Signs shall be posted informing employees that they shall wash their hands before returning to work.

K. Storage and Disposal of Wastes. All waste disposal shall be handled in accordance with Part XXVII of this Code.

1. All refuse and garbage shall be stored in covered, impervious and leak-proof containers. This requirement does not pertain to production scrap.

2. All waste containers shall be clearly labeled for their intended purpose and contents.

3. Where possible, garbage and assorted rubbish should be stored outside the building in covered, impervious, cleanable containers. If stored inside the building, it must be contained in similar receptacles, but in an area separate from fabricating areas.

L. Personal Cleanliness. Hands shall be thoroughly washed before commencing plant functions and as often as may be required to remove soil and contamination, and before returning to work after visiting the toilet room or lunch room.

1. All personnel shall wear clean outer garments and shall wear effective hair restraints, hair nets or caps. Shorts shall not be worn as outer garments.

2. No person affected with any disease in a communicable form or while a carrier of such disease, and no person with an infected cut or lesion shall work in any processing area in any capacity where there is a likelihood of such person contaminating product or product contact surfaces with pathogenic microorganisms.

3. The use of tobacco products is prohibited in fabricating, re-grind and storage areas.

M. Protection from Contamination. All product-contact surfaces of containers, closures and all materials in process are covered or otherwise protected to prevent the access of insects, dust, condensation and other contamination.

1. The manufacture of single service containers and closures for milk and milk products shall be conducted in such a manner that there will be no cross contamination of raw material or re-grind with non-food grade materials.

2. Whenever air under pressure is directed at resin, regrind, colorants and similar materials, it shall be free of oil, dust, rust, excessive moisture, extraneous materials and odor and shall otherwise comply with the applicable requirements of Appendix H of the *PMO*.

3. Air that is directed at product contact surfaces by fans or blowers shall be filtered and shall otherwise comply with the applicable requirements of Appendix H of the *PMO*.

4. Only pesticides approved for use in food plants and registered with the U.S. Environmental Protection Agency shall be used for insect and rodent control.

5. Pesticides shall be used in accordance with the manufacturer's directions and used so as to preclude the contamination of containers or closures.

N. Storage of Materials and Finished Product. Blanks, roll stock and all other single service containers, closures and articles shall be stored off the floor by use of pallets, slip sheets or other methods and away from any wall a sufficient distance to facilitate inspection, cleaning and pest control activities. Any roll stock having dirty or soiled outer turns or edges shall have sufficient turns discarded prior to use and edges trimmed to provide protection from contamination.

1. Single service articles in process shall be protected from contamination by use of single service cover sheet or other protective device. This includes chip board, dividers, separators, bags and other items that can become contact surfaces.

2. Appropriate clean, dry storage facilities shall be provided for single service containers, closures, paper for wrapping, adhesives, blanks and other production material to provide protection from splash, insects, dust and other contamination.

3. Where containers and closures are preformed in plants other than the original fabricating facility:

a. containers, blanks and closures shall be stored in the original cartons and sealed until used;

b. partially used cartons of containers, blanks and closures shall be resealed until used.

4. Containers used for storage of resin and other raw materials, re-grind, broke and trim, intended for use in the process, shall be covered, clean, impervious and properly identified. Reuse of storage containers, such as gaylords, is permitted provided single-use plastic liners are used.

5. In process storage bins that touch the product contact surface of containers or closures shall be constructed of cleanable, nonabsorbent material and kept clean.

O. Fabricating, Processing and Packaging Equipment. The requirements of this Subsection pertain to all equipment and processes used in the fabrication of containers and closures irrespective of the materials used and whether or not mentioned herein. Some of this equipment includes grinders, rollers, reamers and cutters, molders and fittings, extruders, silos, resin bins and hoppers, printing equipment, blanking equipment and sealing equipment.

1. Rolls, dies, belts, tables, mandrels, transfer tubing and all other contact surfaces shall be kept clean, sanitary and reasonably free of accumulation of paper, plastic or metal dust and other production soils. Equipment designed for dairy plant use which is utilized for preforming containers shall be clean and sanitized prior to operation.

2. All materials in process for containers and closures shall be protected from contamination by condensate or drippage from overhead pipes or equipment components.

3. Makeshift devices such as tape, rope, twine, paperboards, etc., shall not be used. All fasteners, guides, hangers, supports and baffles shall be constructed of impervious, cleanable materials and kept in good repair.

4. Take off tables and other container contact surfaces shall be constructed of cleanable material, kept clean and in good repair.

5. All grinders, shredders and similar equipment used for re-grinding shall be installed above the floor or installed in such a manner that they are protected, so that floor sweepings and other contaminants cannot enter the grinder or shredder.

6. Storage tanks, silos, gaylords or bins used for plastic resin shall be so constructed to protect the resin from contamination. All air vents shall be filtered to prevent the entrance of dust or insects. Air tubes used to conduct resin shall be supported above ground to prevent their becoming submerged in water. Air tubes used to convey resin shall have end caps, attached by a chain or cable that prevent contamination. This Paragraph also applies to all raw materials handled in like manner.

7. Storage tanks, silos, etc., located outside of buildings shall have all outer openings locked or sealed at all times when not being filled, repaired or cleaned.

P. Equipment and Materials for Construction of Containers and Closures. Single service containers and closures for milk and milk products shall not be fabricated on equipment used for the manufacture of products made of non-food grade materials unless such equipment has been thoroughly cleaned and purged of all non-food grade material by a process that will not contaminate the food grade material.

1. Only plastic sheeting and extrusions, plastic laminated paper, metal and paperboard blanks, or combination thereof from a manufacturing or fabricating plant conforming with these standards shall be used. Fabricating plants listed in the current IMS publication of *Certified Manufacturers of Single Service Containers and Closures for Milk and Milk Products* shall be considered in compliance with this item.

2. Only sanitary, nontoxic lubricants shall be used on container closure contact surfaces. Excess lubricant shall be removed from surfaces close to shafts, rollers bearing sleeves and mandrels. These lubricants shall be handled and stored in a manner that will prevent cross contamination with non food grade lubricants. Such storage areas shall be clean and adequately ventilated.

3. Containers, resin and flashing on the floor and floor sweepings of production materials are prohibited from being reused. This shall not preclude the use of these materials when it complies with a protocol which has been reviewed and accepted by the FDA.

Q. Waxes, Adhesives, Sealants and Inks. Waxes, adhesives, sealants and inks used for containers and closures shall be handled and stored in a manner that will prevent cross contamination with similar non-food grade materials. Such storage areas shall be clean and adequately ventilated.

1. Waxing shall be performed so as to assure that containers or closures are completely coated and the wax shall be kept at temperature of 60°C (140°F) or higher.

2. Unused materials shall be covered and properly stored.

3. Waxes, adhesives, sealants and inks shall not impart odor or taste to the milk or milk products and shall not contaminate the product with microorganisms or toxic or injurious substances. All materials that are applied to the product contact surface shall comply with the requirements of Parts 175 through 178 of Title 21 of the CFR.

4. Transfer containers shall be kept clean and shall be properly identified and covered.

R. Handling of Containers and Equipment. Handling of containers and closure contact surfaces shall be kept to a minimum.

S. Wrapping and Shipping. Blanks, closures, halves, nested or preformed containers and parts such as valves, hoses, tubes and other fittings shall be properly packaged or containerized prior to shipping.

1. The outer package or containerized units shall protect the contents from dust and other contamination.

2. Transportation vehicles used to ship finished materials from the single service container and closure plant or within the plant shall be clean and in good repair and shall not have been used for the transportation of garbage, waste or toxic materials.

3. Paperboard containers, wrappers and dividers that contact the surface of the container or closure shall not be reused for this purpose.

4. All packaging materials that contact the product contact surface of the container or closure shall comply with the requirements of *Parts 175 through 178 of Title 21 of the CFR* and the bacteriological standards of §2905, but the material does not have to be manufactured at a listed single service plant. Some outer packaging material such as corrugated cardboard boxes used for the packaging of milk carton flats, are exempt from this bacteriological standard. The edges of these flats are subject to heat during the forming and sealing of the container.

T. Identification and Records. Outer wrappings shall be identified with the name and city of the plant where the contents are fabricated, except those manufactured in, and which are only for use in the same facility. In the cases where several plants are operated by one firm, the common firm name may be utilized, provided that the location of the plant at which the contents were fabricated is also shown either directly or by the FIPS numerical code on the outer wrapper.

1. Records of all required bacteriological tests of containers and closures shall be maintained at the plant of manufacture for two years and results shall be in compliance with §2905.

2. The fabricating plant shall have on file information from suppliers of raw materials, waxes, adhesives, sealants, coating and inks indicating that the material complies with the requirements of Parts 175 through 178 of Title 21 of the CFR.

3. The fabricating plant shall have on file information from the suppliers of packaging materials specified in Paragraph 3 of this Subsection indicating that the material complies with the bacteriological standards of §2905. There are no specifications for sampling frequency. The state health officer may choose to collect samples of packaging materials to determine compliance with bacteriological standards of this Part.

4. Multi plant corporations may have all required information at a central location as long as it can be transmitted to the site upon request.

U. Surroundings. Exterior surroundings shall be neat and clean and free from conditions which might attract or harbor flies, other insects and rodents.

1. Driveways, lanes and areas serving the plant vehicular traffic are graded, drained and free from pools of standing water.

PUBLIC HEALTH—SANITARY CODE

AUTHORITY NOTE: Promulgated in accordance with the provisions of R.S. 40:4(A)(1)(a). Also see R.S. 40:5(2)(3)(5)(7)(15)(17) and R.S. 40:922.

HISTORICAL NOTE: Promulgated by the Department of Health and Hospitals, Office of Public Health, LR 37:2724 (September 2011).

Title 51
PUBLIC HEALTH—SANITARY CODE
Part IX. Marine and Fresh Water Animal Food Products

Chapter 1. Shellfish Growing Areas

§101. Definitions

[formerly paragraph 9:001]

A. Unless otherwise specifically provided herein, the following words and terms used in this Part of the Sanitary Code, and all other Parts which are adopted or may be adopted, are defined for the purposes thereof as follows.

Adverse Pollution Conditions—a state or situation caused by meteorological, hydrological, or seasonal events or point source discharges that has historically resulted in elevate fecal coliform levels in a particular growing area.

Approved Area—the classification of a Louisiana shellfish growing area which has been approved by the state health officer with the assistance of the secretary of the Department of Wildlife and Fisheries for growing or harvesting shellfish for direct marketing. The classification of an approved area is determined through a sanitary survey conducted by the Department of Health in accordance with the guidelines set out in this rule and as hereafter amended and duly promulgated. An approved shellfish growing area may be temporarily made a closed area when a public health emergency resulting from, for instance a hurricane or flooding, is declared by the state health officer.

Aquaculture—cultivating shellfish in controlled conditions for human consumption. Cultivation includes propagation and growing of shellfish. These activities may occur in natural or man-made water bodies. These activities include seed collection, production, and cultivation in natural water bodies when shellfish are held off the bottom such as the use of racks, bags, or cages, and when shellfish are held in man-made water bodies such as the use of tanks, ponds, or raceways. These activities do not include depuration or wet storage.

Bacteriological Database—bacteriological analysis organized and used as the basis for the classification of shellfish growing waters.

Certified Dealer—a person who has been registered with and certified by the Office of Public Health to be a dealer.

Certified Laboratory—a laboratory conducting analysis for the Louisiana Molluscan Shellfish Program that has received a satisfactory rating during an on-site evaluation by the shellfish evaluation officer for the state of Louisiana or the federal Food and Drug Administration (FDA) evaluation officer. The purpose of the evaluation will be to assure the uniform application of standard procedures and methods in the sampling and analytical examination of shellfish growing waters and to determine and assure the adequacy of

facilities, equipment, and personnel to perform analytical testing necessary to meet the requirements recommended by the National Shellfish Sanitation Program and found to be acceptable by the Louisiana Molluscan Shellfish Program. This evaluation only certifies that the laboratory facility and its staff meet the specifications of the National Shellfish Sanitation Program at the time of the evaluation.

Certified Laboratory Personnel—individuals administratively attached to an officially designated laboratory of the shellfish sanitation laboratory system for the purpose of conducting microbiological analysis for LSSP who have achieved a satisfactory rating during an on-site evaluation by the shellfish evaluation officer for the state of Louisiana for the FDA evaluation officer.

Closed Area—a growing area where the harvesting of shellfish is temporarily or permanently not permitted. A closed area status is or may be placed on any of four classified area designations—approved, conditionally approved, restricted, or prohibited.

Closed Safety Zone—an area designated by the state health officer for the purpose of lessening the impact of an actual or potential pollution source.

Coliform Group—includes all of the aerobic and facultative anaerobic, gram-negative, non-spore-forming bacilli which ferment lactose with gas formation within 48 hours at 35 degrees C.

Conditional Management Plan—a written management program approved by the state health officer and the secretary of the Department of Wildlife and Fisheries governing classification of shellfish harvesting water classified as conditionally approved.

Conditionally Approved Area—the classification of a Louisiana shellfish growing area determined by the state health officer to meet the approved area criteria for a predictable period. A conditionally approved shellfish growing area is a closed area when the area does not meet the approved growing area criteria and is temporarily closed by the state health officer.

Cull—to remove dead or unsafe shellstock from a lot of shellstock.

Dealer—a person engaged in the purchasing, storing, shipping, and selling of seafood.

Department—the Louisiana Department of Health, Office of Public Health.

Direct Impact—a pollution source or potential source which may have an immediate impact on shellfish harvesting waters. Examples are:

- a. any waste directly piped to shellfish harvesting waters;
- b. any waste discharged to a property which would drain directly to shellfish harvesting waters;
- c. domestic animals penned or confined so the animals have direct contact with the harvesting waters or their waste drain directly to growing waters;
- d. marinas;
- e. processing waste draining directly to harvesting waters.

Edible Crustaceans—include any edible, commercially distributed shrimp, crab, crayfish, lobster or other member of the animal kingdom classified as crustaceans (Crustacea).

Fecal Coliform Group—includes bacteria of the coliform group which will produce gas from lactose in a suitable multiple tube procedure liquid medium (EC or A-1) within 24 plus/minus two hours at 44.5° plus/minus 0.2°C in a water bath.

Fish—includes any edible, commercially distributed fresh or salt-water member of the animal kingdom classified as fish (Pisces).

Growing Area—an area which supports or could support live shellfish.

Habitable Structure—any structure capable of giving shelter from the environment and producing sewage waste.

Harvest—the act of removing shellstock from growing areas and its placement on or in a manmade conveyance or other means of transport.

Harvest Area—an area that contains commercial quantities of shellstock and may include aquaculture sites and facilities.

Harvester—a person who takes shellfish by any means from a growing area.

Hazard Analysis Critical Control Point (HACCP)—a systematic, science-based approach used in food production as a means to assure food safety. The concept is built upon the seven principles identified by the National Advisory Committee on Microbiological Criteria for Foods (1992).

Hazard Analysis Critical Control Point Plan—a written document that delineates the formal procedures that a dealer follows to implement the HACCP requirements set forth in 21 Code of Federal Regulations (CFR) 123.6 as adopted by the Interstate Shellfish Sanitation Conference.

Indirect Impact—a discharge or pollution source which could reach shellfish growing waters in a roundabout way. Example: an outfall which discharges to a drainage system which discharges into the immediate area of shellfish growing waters.

In-Shell Product—nonliving, processed shellfish with one or both shells present.

Interstate Shellfish Sanitation Conference (ISCC)—the organization which consists of agencies from shellfish producing and receiving states, FDA, the shellfish industry, NOAA, and the Environmental Protection Agency (EPA). The ISCC provides the formal structure wherein state regulatory authorities, with FDA concurrence, can establish updated guidelines and procedures for sanitary control of the shellfish industry.

Laboratory Evaluation Officer (LEO)—a person from either a state, federal or foreign authority that has met the personnel training requirements for implementing the NSSP.

Louisiana Molluscan Shellfish Laboratory System—all laboratories that have been successfully evaluated during an on-site evaluation by the Laboratory Evaluation Officer for the state of Louisiana and have been consequently officially designated as a shellfish sanitation laboratory for the Louisiana Molluscan Shellfish Sanitation Program.

Louisiana State Shellfish Sanitation Laboratory System—all laboratories that have been successfully evaluated during an on-site evaluation by the shellfish evaluation officer for the state of Louisiana or FDA evaluation officer and have been consequently officially designated as a shellfish sanitation laboratory for the Louisiana State Shellfish Sanitation Program.

Marina—any water area with a structure (docks, basin, floating docks, etc) which is used for docking and constructed to provide temporary or permanent docking space for more than 10 boats.

Marina Policy—the prescribed plan approved by the state health officer to be used in the classification of shellfish harvesting waters in and around marinas.

Marine and Freshwater Animal Food Products—any food products used as food for human consumption which are made from or contains fish, shellfish, edible crustaceans, or any other animal whose normal life span, in whole or part, is spent in fresh, brackish or salt water.

Marine Biotoxin—any poisonous compound produced by marine microorganisms and accumulated by shellstock. Examples include toxins produced by *Alexandrium spp* [*Protogonyaulax* species] and *Karenia brevis*.

Molluscan Shellfish Program—the program which regulates and monitors the growing, harvesting, handling and shipping of shellfish in the state of Louisiana. The program is with the Louisiana Department of Health, Office of Public Health, Sanitation Services Section.

Most Probable Number (abbreviated *MPN*)—a statistical estimate of the number of bacteria per unit volume and is determined from the number of positive results in a series of fermentation tubes.

Narrative Report—a report submitted by the shellfish evaluation officer for the state of Louisiana or the FDA evaluation officer following an on-site evaluation. The report shall include the identity of the laboratory, the date of evaluation, name of evaluator, information on personnel and procedures and conclusions and shall precisely and

accurately describe the conditions which existed during the evaluation, including what recommendations were made to correct deficiencies and proposed timetable for any corrective action necessary to bring the laboratory into substantial conformity with the requirements of the National Shellfish Sanitation Program (NSSP) as approved by the Louisiana Molluscan Shellfish Program.

National Shellfish Sanitation Program (NSSP) —the cooperative State-FDA-Industry program for the certification of interstate shellfish shippers as described in the National Shellfish Sanitation Program for the Control of Molluscan Shellfish. The National Shellfish Sanitation Program for the Control of Molluscan Shellfish guide may be obtained from the Interstate Shellfish Sanitation Conference.

On-Site Evaluation—inspection of a laboratory and all appropriate personnel at the physical laboratory site by the Laboratory Evaluation Officer for the purpose of conducting evaluation according to the NSSP Guide for the Control of Molluscan Shellfish.

Open Water Aquaculture—the cultivation of bivalve shellfish in natural shellfish growing areas.

Opening/Closing Line—a boundary drawn on a map to delineate the classification of shellfish grown waters.

Person—includes any individual, partnership, corporation, association or other legal entity.

Point Source—any discernible, confined and discrete conveyance including but not limited to any pipe, ditch, channel, tunnel, or conduit that carries pollution.

Poisonous or Deleterious Substance—a toxic substance occurring naturally or added to the environment for which a regulatory tolerance limit or action level has been established in shellfish to protect public health.

Pollution—the contamination of the shellfish waters by the discharge of microbiological substances into these waters (chemicals, bacterial, or biotoxins).

Post-Harvest Processing (PHP)—any process which has been validated using NSSP validation procedures which reduces levels of pathogenic hazards to below the appropriate FDA action level or in absence of such a level, below the appropriate level as determined by the ISCC.

Processing—any activity associated with the handling, shucking, freezing, packing, labeling or storing of shellfish in preparation for distribution. This would include the activities of a shellstock shipper, shucker packer, repacker, reshipper, or depuration processor.

Prohibited Area—Louisiana waters that have been classified by the state health officer as prohibited for the harvesting of shellfish for any purpose except depletion and production of seed for aquaculture. A prohibited shellfish growing area is a closed area for the harvesting of shellfish at all times. Harvesting of shellfish from a closed area may result in criminal charges pursuant to R.S. 56:424.

Relaying—the transfer of shellfish from restricted areas to approved areas for natural biological cleansing using the ambient environment as a treatment system.

Restricted Area—a classification used to identify a growing area where harvesting shall be by special permit and the shellstock, following harvest, is subjected to a suitable and effective treatment process.

Sanitary Survey—the written evaluation report of all environmental factors, including actual and potential pollution sources, which have a bearing on shellfish growing area water quality.

Seafood—includes but is not limited to fish, shellfish, edible crustaceans, marine and freshwater animal food products.

Seed—shellstock which is less than market size.

Shellfish—all edible species of oysters, clams, or mussels, either shucked or in the shell, fresh or frozen; whole or in part. Some of the common bivalves included in this definition are:

Common Name	Scientific Name
Cockle	<i>Clinordium nuttalli</i> <i>Cardium corbis</i> (Pacific)
Geoduck	<i>Panope generosa</i>
Fresh water clam	<i>Rangia cuneata</i>
Soft shell clam	<i>Mya arenaria</i>
Hard or quahog clam	<i>Mercenaria mercenaria</i> <i>Mercenaria campechiensis</i>
Surf clam	<i>Spisula solidissima</i>
Mahogany or Ocean quahog, clam	<i>Artica islandica</i>
Gaper or Horse clam	<i>Tresus nuttalli</i> and <i>T. capax</i>
Razor clam	<i>Solen resaceus</i> , <i>Ensis directus</i> (Atlantic) <i>Solen viridis</i> , <i>Tagelus plebeius</i> , and <i>Siliqua patula</i> (Pacific)
Bent-nose clam	<i>Macoma nasuta</i>
Pismo clam	<i>Tivela stultorum</i>
Butter clam	<i>Saxidomus giganteus</i>
Calico clam	<i>Macrocallista maculata</i>
Sunray venus	<i>Macrocallista nimbosa</i>
Pacific littleneck clam	<i>Protothaca tenerrima</i> and <i>Protothaca staminea</i>
Manila clam	<i>Tapes semidecussata</i>
Pacific (Japanese) oyster	<i>Crassostrea gigas</i>
Eastern oyster	<i>Crassostrea virginica</i>
Olympia or yaquina oyster	<i>Ostrea lurida</i>
European oyster	<i>Ostrea edulis</i>
Blue or bay mussel	<i>Mytilus edulis</i>
California sea mussel	<i>Mytilus californianus</i>
Green lipped mussel	<i>Perna canaliculus</i> (New Zealand)

Shellfish Evaluation Officer for the State of Louisiana—state health officer or his/her designee approved by letter by the federal Department of Health and Human Services, Public Health Service, Food and Drug Administration, Bureau of Food Technology, Shellfish Sanitation Branch to conduct on-site evaluations of laboratories deserving official recognition as a member of the shellfish sanitation laboratory system other than the certified laboratory. Official

approval is based upon the individual meeting the requirements of Shellfish Sanitation Interpretation S.S. 35 entitled "Evaluation of Laboratories by State Shellfish Laboratory Evaluation Officers.

Shellstock—live molluscan shellfish in the shell.

State Shellfish Patrol Agency—the enforcement agents of the Louisiana Department of Wildlife and Fisheries having the responsibility for the enforcement of lines concerning harvesting of shellfish.

State Waters—waters that belong wholly to the state of Louisiana, including the Territorial Sea.

Transplanting—the moving of shellfish from one area to another area for improving growth, stocking depleted area and leases, and for other aquaculture purposes.

AUTHORITY NOTE: The first source of authority for promulgation of the sanitary code is in R.S. 36:258.B, with more particular provisions found in Chapters 1 and 4 of Title 40 of the Louisiana Revised Statutes. This Part is promulgated in accordance with the specific provisions of R.S. 40:4.A(1), R.S. 40:5.A(2)(3)(5)(7)(9)(15)(17)(19)(20) and R.S. 40:5.3

HISTORICAL NOTE: Promulgated by the Department of Health and Hospitals, Office of Public Health, LR 28:1289 (June 2002), amended LR 28:1591 (July 2002), LR 31:2895 (November 2005), LR 34:2175 (October 2008), amended by the Department of Health, Office of Public Health, LR 48:1844 (July 2022), repromulgated LR 48:2132 (August 2022).

§103. Harvesting and/or Sales Shellfish—In Open Status
[formerly paragraph 9:002-1]

A. No shellfish shall be harvested and/or sold in the state of Louisiana for food unless taken from areas sanctioned by the state health officer, or if taken from sources outside of the state, from areas sanctioned by the state authorities having jurisdiction, and unless secured from shellfish dealers whose state certifications have been endorsed by the United States Food and Drug Administration, Public Health Service for interstate shipment.

AUTHORITY NOTE: Promulgated in accordance with R.S. 40:4.A(1) , R.S. 40:5.A(2)(3)(5)(7)(9)(15)(17)(19)(20) and R.S. 40:5.3.

HISTORICAL NOTE: Promulgated by the Department of Health and Hospitals, Office of Public Health, LR 28:1291 (June 2002), repromulgated by the Department of Health, Office of Public Health, LR 48:1846 (July 2022), repromulgated LR 48:2134 (August 2022).

§105. Sanitary Surveys of Growing Areas—Satisfactory Compliance
[formerly paragraph 9:002-2]

A. This item will be satisfied when the following requirements are met.

1. Before an area is classified as approved, conditionally approved, or restricted, a sanitary survey shall be completed. The survey is a report completed prior to allowing harvesting from the area.

2. Each sanitary survey report shall identify and evaluate all actual and potential sources of pollution which

may affect the growing area; determine the distance of such sources to the growing area; assess the effectiveness and reliability of sewage treatment systems; and ascertain the presence of poisonous or deleterious substances, e.g., industrial, and agricultural wastes, pesticides or radionuclides. The presence and location of small sources of pollution such as boats which might contribute direct fresh fecal matter and poisonous or deleterious substances to the area shall be evaluated. The presence of domestic, wild animal, or migrating bird populations shall be considered for possible adverse effects upon water quality. Offshore growing areas located in the vicinity of ocean dump sites shall be evaluated for biological and chemical wastes and radiological materials. Other environmental health factors that may affect the quality of the shellfish resources should also be evaluated in the sanitary survey report.

3. Each sanitary survey report shall evaluate any meteorological and hydrodynamic effects and geographic characteristics that may affect the distribution of pollutants over the growing area. These factors shall be assessed to determine their maximum effect on water quality.

4. Each sanitary survey report shall include the collection of growing area water samples and their analysis for bacteriological quality. The number and location of sampling stations selected shall be adequate to produce the data necessary to effectively evaluate all point and non-point pollution sources. Recommended that sampling stations shall be established to evaluate all freshwater discharges into the growing area. The collection of samples shall form a profile reflecting adverse meteorological, hydrographic, seasonal, and point source, and geographic pollution conditions to assure the requirements for classifying growing areas as approved (§109), conditionally approved (§111), or restricted (§113) are met.

5. The sanitary survey shall be maintained on an annual basis in order to assure that data is current and sanitary conditions are unchanged. If actual or potential pollution sources impact upon the area, it is necessary to annually update sanitary survey data including the field review of pollution sources and the collection of at least five water quality samples from each stations selected to accurately represent shellfish sanitation in the area under consideration.

6. The sanitary survey shall be reviewed and the growing area classification reevaluated at least every three years to assure the accurate classification of each growing area. The reevaluation shall include, at a minimum, an examination of the Oyster Water Monitoring Program's bacteriological database of at least the last five prior years. The minimum number of samples required within the five-year database is 15. For a harvesting area to be classified as approved, the requirements of §109 must be met. For a harvesting area to be classified as conditionally approved, the requirement of §111 must be met. For an area to be classified as restricted, the requirements of §113 shall be met.

7. A report shall be prepared for each sanitary survey and each reevaluation. Reports shall contain an analysis of the sanitary survey data, and a determination that the area classification conforms with the applicable criteria.

8. Areas classified as approved, conditionally approved, or restricted that do not comply with the sanitary requirements of the designated classification shall be immediately reclassified to the appropriate category.

9. The central sanitary survey file shall contain all information related to the classification of each area including sanitary survey reports, updated sanitary survey data, and reevaluation reports.

AUTHORITY NOTE: Promulgated in accordance with R.S. 40:4.A.(1) , R.S. 40:5.A(2)(3)(5)(7)(9)(15)(17)(19)(20) and R.S. 40:5.3.

HISTORICAL NOTE: Promulgated by the Department of Health and Hospitals, Office of Public Health, LR 28:1292 (June 2002), amended by the Department of Health, Office of Public Health, LR 48:1846 (July 2022), repromulgated LR 48:2134 (August 2022).

§107. Classification of Growing Areas—Satisfactory Compliance
[formerly paragraph 9:002-3]

A. This item will be satisfied when:

1. all actual and potential shellfish growing areas in the state of Louisiana are correctly designated with one of the following classifications on the basis of sanitary survey information: approved, conditionally approved, restricted or prohibited. Unclassified areas are managed as prohibited;

2. an area classified as prohibited will be established adjacent to all identified actual or potential pollution discharges, including sewage treatment plants outfall, which have a direct or indirect impact and, which have been determined to be of a significant nature in the growing area;

a. the determination of the size of the area to be classified as prohibited adjacent to each outfall shall include the following minimum criteria:

i. the volume flow rate, location of discharge, performance of the wastewater treatment plant and microbial quality of the effluent;

ii. the decay rate of the contaminants of public health significance in the wastewater discharge;

iii. the wastewater's dispersion and dilution, and the time of waste transport to the area where shellstock may be harvested; and

iv. the location of shellstock resources, classification of adjacent waters and identifiable landmarks and boundaries.

3. an upward revision of an area classification shall be supported by an adequate sanitary survey report. This report shall include a written analysis of the data and shall be part of the growing area central file. The reopening of an area temporarily closed because of an emergency, the failure to meet the performance standards for a conditional area, or the

presence of biotoxins shall be supported by appropriate data showing that the original classification criteria are met, and documented by a written record in the central file of the Molluscan Shellfish Program, Office of Public Health, Department of Health;

4. maps showing the boundaries and classification of each shellfish growing area are maintained in the central file by the Molluscan Shellfish Program, Office of Public Health, Department of Health;

5. maps showing the boundaries and status (opened or closed) of each shellfish growing area are posted at designated locations. These locations are listed in the *Louisiana Register*, Vol. 13, pages 413-415.

AUTHORITY NOTE: Promulgated in accordance with R.S. 40:4.A.(1), , R.S. 40:5.A(2)(3)(5)(7)(9)(15)(17)(19)(20) and R.S. 40:5.3.

HISTORICAL NOTE: Promulgated by the Department of Health and Hospitals, Office of Public Health, LR 28:1292 (June 2002), LR 48:1846 (July 2022), LR 48:2135 (August 2022).

§109. Approved Areas—Satisfactory Compliance
[formerly paragraph 9:002-4]

A. Growing areas may be designated as approved when the sanitary survey and marine biotoxin surveillance data indicates that fecal material, pathogenic microorganisms, poisonous and deleterious substances are not present in the area in dangerous concentrations. This item will be satisfied when:

1. Results of sampling under adverse pollution conditions indicate that the fecal coliform median or geometric mean MPN of the water does not exceed 14 per 100 ml and not more than 10 percent of the samples exceed an MPN of 43 for a five-tube dilution test (or an MPN of 49 per 100 ml for a three-tube decimal dilution test);

2. Sanitary Survey Report, as required in §§105 and 107, are on file with the Molluscan Shellfish Program.

AUTHORITY NOTE: Promulgated in accordance with R.S. 40:4.A.(1) and R.S. 40:5.3.

HISTORICAL NOTE: Promulgated by the Department of Health and Hospitals, Office of Public Health, LR 28:1293 (June 2002), LR 48:1847 (July 2022), repromulgated LR 48:2135 (August 2022).

§111. Conditionally Approved Areas—Satisfactory Compliance
[formerly paragraph 9:002-5]

A. Growing areas that are subject to intermittent micro-biological pollution may be classified as conditionally approved. Shellfish growing areas that are subject to intermittent microbiological pollution may, at the discretion of the state health officer, be classified as conditionally approved when:

1. the factors, environmental and otherwise, which affect a growing area are known and predictable;

2. a current sanitary survey is on file with the Molluscan Shellfish Program;

3. data review of the factors indicates the area will meet approved area criteria;

4. statistical analysis shows the area to meet approved area classification under regulated factors;

5. statistical analysis shows the factor(s) to be a significant contributor to the microbiological pollution event.

B. If the growing area meets the requirements specified in §111.A.1-5, a conditional management plan will be developed. The conditional management plan will include, at a minimum, the following:

1. definition of the growing area by use of a map or verbal description. When a verbal description is used, a map will be included as part of the conditional management plan;

2. an evaluation of each known or potential source of pollution which may have a direct or indirect impact on the growing area as defined in §111.B.1;

3. criteria for opening and closing the defined area;

4. a patrol system to prevent illegal harvesting of shellfish;

5. an alert system for immediately notifying the Louisiana Department of Health and Hospitals, Office of Public Health and the Louisiana Department of Wildlife and Fisheries of an adverse change in the environmental conditions;

6. specified performance factors for the defined conditionally approved area;

7. random sampling schedule to ensure a cross section of all environmental and other factors are examined.

C. A conditionally approved area will be immediately closed to shellfish harvesting when the established criteria in the conditional management plan are not met. The management area will remain closed until:

1. the criteria established in the management plan area fully met;

2. a time period has elapsed to allow the natural depuration of the shellfish;

3. when determined as necessary by the state health officer, bacteriological and/or chemical analysis to verify shellfish growing water and/or shellfish meat quality.

D. If the proposed conditionally approved area is affected by a waste water discharge, the following will be included within the conditional management plan:

1. performance standards which, if not adhered to, represent a pollution threat to the management area;

2. effluent volume at average and peak flow;

3. identification of factors which cause plant failures;

4. an established reporting procedure of discharge failure;

5. an established monthly reporting procedure of discharge parameters;

6. the establishment of an immediate reporting procedure in the event of facility or collection system by-pass.

E. Reevaluation of Conditional Classification

1. The classification shall be reevaluated at least once each year. The reevaluation shall include:

a. evaluation of compliance with the management plan;

b. determination of adequacy of reporting of failure to meet performance standards;

c. review of cooperation of all parties involved;

d. evaluation of water quality in the growing area with respect to the bacteriological standards for its classification;

e. field inspection of critical pollution sources, where necessary; and

f. written findings, evaluations, and recommendations.

F. The purpose of the conditional management plan will be agreed upon by the Louisiana Department of Health and Hospitals and the Louisiana Department of Wildlife and Fisheries.

G. A conditional management plan will not become effective until the order establishing the conditional management area has been signed by:

1. the Louisiana State Health Officer;

2. the Secretary, Louisiana Department of Health and Hospitals; and

3. the Secretary, Louisiana Department of Wildlife and Fisheries. Such a statement will be included in all conditional management plans when the plan is being prepared or upon the review/reevaluation of the management plan. In the event the last signature is obtained after the stated effective date of the management plan, the conditional management plan will become effective seven days after the latest signature affixed to the order.

AUTHORITY NOTE: Promulgated in accordance with R.S. 40:4.A.(1), R.S. 40:5.A(2)(3)(5)(7)(9)(15)(17)(19)(20) and R.S. 40:5.3.

HISTORICAL NOTE: Promulgated by the Department of Health and Hospitals, Office of Public Health, LR 28:1293 (June 2002), LR 48:1847 (July 2022), repromulgated LR 48:2135 (August 2022).

§113. Restricted Area—Satisfactory Compliance [formerly paragraph 9:002-6]

A. An area may be classified as restricted when a sanitary survey indicates a limited degree of pollution. This option may arise when levels of fecal pollution or poisonous or deleterious substances are low enough that relaying will make the shellfish safe to market. This item will be satisfied

when the following criteria are met in areas designated as restricted.

1. Sanitary surveys of restricted areas are conducted, maintained, and reevaluated in the same manner and frequency as for approved areas.

2. The area is not so contaminated with fecal material, poisonous or deleterious substances that consumption of the shellfish might be hazardous after relaying. Verification of these findings shall be done by a laboratory found to conform by a laboratory evaluation officer.

3. For restricted areas to be used for harvest of shellfish for controlled purification the bacteriological quality of every sampling station in those portions of the area exposed to fecal contamination during adverse pollution conditions shall meet one of the following standards.

a. The total coliform median or geometric mean MPN of the water does not exceed 700 per 100 ml and not more than 10 percent of the samples exceed an MPN of 2,300 per 100 ml for a 5-tube decimal dilution test (or 3,300 per 100 ml for a 3-tube decimal dilution test).

b. The fecal coliform median or geometric mean MPN of water does not exceed 88 per 100 ml and not more than 10 percent of the samples exceed an MPN of 260 per 100 ml for a 5-tube decimal dilution test (or 300 per 100 ml for a 3-tube decimal dilution test).

4. Shellfish quality specifications are established by the Louisiana state health officer for the use in classifying areas. These specifications are based on the data obtained from surveys, water samples and product samples taken from the potential restricted area. With this information the Louisiana state health officer may evaluate the bacteriological and chemical quality of the shellfish and determine whether the shellfish may be used for relaying..

5. The Louisiana state health officer with the Secretary of the Louisiana Department of Wildlife and Fisheries have effective protocols for assuring that shellfish are not harvested from restricted areas except by special permit and under the effective supervision of the Louisiana Department of Wildlife and Fisheries.

6. All data, criteria, and protocols relating to the operation of a restricted area including survey reports, treatment effectiveness studies, classification criteria, harvesting permits, and harvesting control records are maintained in a central file.

AUTHORITY NOTE: Promulgated in accordance with R.S. 40:4A.(1) , R.S. 40:5.A(2)(3)(5)(7)(9)(15)(17)(19)(20) and R.S. 40:5.3.

HISTORICAL NOTE: Promulgated by the Department of Health and Hospitals, Office of Public Health, LR 28:1294 (June 2002), LR 48:1847 (July 2022), repromulgated LR 48:2135 (August 2022).

§115. Prohibited Areas—Satisfactory Compliance [formerly paragraph 9:002-7]

A. Louisiana state shellfish growing water areas shall be classified as prohibited if:

1. no current sanitary survey exists; or

2. sanitary survey determines

a. the growing area is adjacent to a sewage treatment plant outfall or other point source of outfall with public health significance;

b. pollution sources may unpredictably contaminate the growing area;

c. the growing area is contaminated with fecal waste so that the shellfish may be vectors for disease microorganisms;

d. the concentration of biotoxin is sufficient to cause a public health risk; or

e. the area is contaminated with poisonous or deleterious substances cause the shellfish to be adulterated; or

3. risk assessment determines shellstock are not safe for human consumption; or

4. wastewater discharges are adjacent to sewage treatment plant outfall or any other point source outfall of public health significance. The determination of the size of the area to be classified as prohibited adjacent to each outfall shall include the following:

a. the volume flow rate, location of discharge, performance of the wastewater treatment plant and the microbiological quality of the effluent;

b. the decay rate of the contaminants of public health significance in the wastewater discharged;

c. the wastewater's dispersion and dilution, and the time of waste transport to the area where shellstock may be harvested; and

d. the location of the shellfish resources, classification of adjacent waters and identifiable landmarks or boundaries.

B. No shellfish shall be taken from prohibited areas for human food use unless it is seed to be cultured in accordance with aquaculture requirements.

AUTHORITY NOTE: Promulgated in accordance with R.S. 40:4.A.(1), R.S. 40:5.A(2)(3)(5)(7)(9)(15)(17)(19)(20) and R.S. 40:5.3.

HISTORICAL NOTE: Promulgated by the Department of Health and Hospitals, Office of Public Health, LR 28:1294 (June 2002), LR 48:1847 (July 2022), repromulgated LR 48:2136 (August 2022).

§117. Control of Areas Due to Marine Biotoxins—Satisfactory Compliance [formerly paragraph 9:002-8]

A. This item will be satisfied when:

1. areas affected by marine biotoxins shall be the subject of an effective control plan developed by the Louisiana state health officer and the Secretary of the Louisiana Department of Wildlife and Fisheries. The plans shall define those administrative procedures and resources necessary to:

a. initiate an emergency shellfish sampling and assay program;

b. close areas and embargo shellfish; and

c. prevent harvesting of contaminated species. The Louisiana state health officer and the Secretary of the Louisiana Department of Wildlife and Fisheries may designate such affected areas as conditionally approved;

2. during the harvesting season in those areas where shellfish toxins are likely to occur, representative samples of shellfish shall be collected from indicator stations and assayed for the presence of toxins;

3. a quarantine shall be imposed against the taking of shellfish when the concentration of paralytic shellfish poison equals or exceeds 80 micrograms per 100 grams of edible portion of raw shellfish, or when neurotoxic shellfish poison is found in detectable levels. To implement this quarantine, the growing area shall be closed, and the prohibition of harvesting shall be enforced;

4. the quarantine shall remain in effect until such time as the Louisiana state health officer has analytical data to show that the poison content of shellfish involved is below the quarantine level. The determination to reopen an area shall consider whether marine biotoxin levels in the shellfish from adjacent areas are decreasing; and whether environmental factors such as water temperature, upwelling or bottom sediments, and numbers of toxic cysts in the sediment are such that conditions can be expected to be stable. This analysis and determination shall be adequately documented;

5. the central file shall contain all information relating to the levels of poison in the growing areas involving monitoring data, closure notices, evaluation reports, and reopening notices;

6. if heat processing is practiced, a control procedure shall be developed. This procedure shall define the following:

a. toxicity limits for processing;

b. controls for harvesting and transporting the shell stock to processor;

c. special marking for unprocessed shell stock;

d. scheduled processes; and

e. end product controls on the processed shellfish.

AUTHORITY NOTE: Promulgated in accordance with R.S. 40:4.A.(1) and R.S. 40:5.3.

HISTORICAL NOTE: Promulgated by the Department of Health and Hospitals, Office of Public Health, LR 28:1294 (June 2002).

§119. Procedures for Receipt of Shellfish Growing Water Samples
[formerly paragraph 9:002-9]

A. Samples of shellfish growing waters, properly collected and labeled in accordance with criteria stipulated in the current edition of American Public Health Association (APHA) *Recommended Procedures for the Examination of*

Sea Water and Shellfish and appropriate sections in *Official Methods of Analysis* of the Association of Official Analytical Chemists (A.O.A.C.), shall be brought to a certified Louisiana shellfish sanitation laboratory immediately after collected and preferably within one hour after collection. When conditions necessitate delay in the transport of samples, the samples shall be kept at a temperature at or below 10°C until bacteriologic examination. In no case shall samples be tested if they have been held for more than 30 hours.

B. The submitter shall bring the samples, which must be clearly identified, directly to the shellfish laboratory. The submitter shall transfer possession of the sample to the laboratory scientist on duty or place the samples in a secured, designated area of the laboratory.

C. The receiving laboratory scientist shall verify the receipt of the samples and record the date and temperature of receipt in an appropriate manner. Analysis should begin immediately after receipt and preferably within one hour after collection. When conditions necessitate delay in the analysis of samples, the samples shall be kept at a temperature at or below 10°C until microbiologic examination. In no case shall samples be tested if they have been held for more than 30 hours.

D. Samples shall be held at a temperature at or below 10°C for a minimum of 30 hours after collection before being discarded.

AUTHORITY NOTE: Promulgated in accordance with R.S. 40:4.A.(1) and R.S. 40:5.3.

HISTORICAL NOTE: Promulgated by the Department of Health and Hospitals, Office of Public Health, LR 28:1295 (June 2002).

§121. Preparation for Laboratory Analysis of Shellfish Growing Waters
[formerly paragraph 9:002-10]

A. Laboratory apparatus used in the analysis of shellfish growing waters shall conform to the criteria stipulated in the current edition of American Public Health Association (APHA) *Recommended Procedures for the Examination of Sea Water and Shellfish* and appropriate sections in *Official Methods of Analysis* of the Association of Official Analytical Chemists (A.O.A.C.).

1. Air incubators used in the preliminary incubation of tubes of test media shall maintain a uniform and constant temperature of 35° plus/minus 0.5°C at all times.

2. Covered, circulating water baths used to incubate tubes of test media for the remaining incubation period shall maintain a uniform and constant temperature of 44.5° plus/minus 0.2°C at all times.

3. Hot air ovens used in the heat sterilization of glassware and related supplies shall be of sufficient size to prevent overcrowding, maintain uniform and adequate sterilizing temperature, and be equipped with suitable thermometers able to accurately register in the range of 160-180°C.

4. Autoclaves used in the sterilization of test media shall be sufficiently large enough to prevent interior

crowding, provide uniform temperature within the chambers, including the sterilizing temperature of 121°C, and be equipped with accurate temperature and pressure recording devices. Pressure gauges and properly adjusted safety valves should be connected directly to either the saturated steam power lines or to a suitable steam generator. The autoclave should be capable of reaching the desired temperature within 30 minutes.

5. Electrometric pH meters used in the preparation of test media and reagents shall have an accuracy of plus/minus 0.1 pH unit.

6. Balances used in the preparation of test media and reagents shall provide a sensitivity of at least 0.1g at a load of 150g and be used with standardized weights. When less than 2g of materials is weighed, the analytical balance used must have a sensitivity of 1 mg under a load of 10g.

7. Water deionization units should be fitted with a 0.22 um-pore diameter filter.

B. Laboratory glassware, reagents and medias used in the analysis of shellfish growing waters shall conform to the criteria stipulated in the current edition of the American Public Health Association (APHA) *Recommended Procedures for the Examination of Sea Water and Shellfish* and appropriate sections *Official Methods of Analysis* on the Association of Official Analytical Chemists (A.O.A.C.).

1. Pipets shall be 1.0 ml serological pipets with 0.1 ml graduations and 10.0 ml pipets with 0.1 ml graduations. Pipets with damaged tips are not to be used. The error calibration shall not exceed 2.5 percent. Pipets that conform to APHA standards as given in "Standard Methods for the Examination of Dairy Products," 14th ed. 1978, American Public Health Association, 1015 18th Street, N.W. Washington, DC 20036 may also be used.

2. Dilution bottles or tubes used in the analysis of shellfish growing waters shall be of borosilicate glass or other material resistant to the solvent action of the water. The bottles shall be fitted with glass or rubber stoppers or polyethylene screw caps equipped with Teflon or equivalent liners that do not produce bacteriostatic compounds on sterilization.

3. Only satisfactorily tested laboratory pure water from stills or deionization units shall be used in the preparation of culture media and reagents and shall be tested and found free from traces of dissolved metals and bactericidal or inhibitory compounds as described in the latest edition of *Standard Methods for the Examination of Water and Wastewater*.

4. Butterfield's buffered phosphate diluent used in the analysis of shellfish growing waters shall be prepared as follows: Stock solution: dissolve 34.0g of potassium phosphate, monobasic, in 500 ml of laboratory pure water, adjust with 1 N NaOH to a pH of 7.2 and bring to 1000 ml volume with laboratory pure water. Dilute 1.25 ml of stock solution to 1 L with laboratory pure water and dispense into dilution bottles in amounts necessary to achieve the desired quantity within a 2 percent tolerance after sterilization.

Autoclave the bottles at 121°C for 15 minutes. Store in a cold, dry place at room temperature.

5. A-1 media is to be prepared from individual components as follows: Dissolve 5g lactose, 20g tryptone, 5g NaCl, and 0.5g salicin in 1 L distilled water. Heat to dissolve ingredients, pipet in 1 ml Triton-X-100 and adjust pH 6.9 plus/minus .1 with 1 N NaOH solution. For 10 ml sample aliquots, prepare and use double strength medium. Single strength medium should be dispensed in 10 ml amount for 10 ml inocula. Autoclave media for 10 minutes at 121°C. Store in dark at room temperature away from possibility of excessive evaporation and contamination. Use media within seven days.

6. All laboratory glassware used in the analysis of shellfish growing waters must be thoroughly cleaned using a suitable detergent and hot water (160°F), then rinsed in hot water (180°F) to remove all traces of residual detergent, and then rinsed four times with a complete change of water, the final rinse being laboratory pure water. The effectiveness of the rinse should be established by testing the as described in the current edition of *Standard Methods for the Examination of Water and Wastewater*. Glassware should be autoclaved or should be sterilized for not less than 60 minutes at 170°C. If glassware is in metal containers, it must be heated to a temperature of 170°C for not less than two hours. Plasticware may be sterilized with low-temperature ethylene oxide gas. However, precautions should be taken to assure that all of the gas has been removed from containers before using.

7. Bromothymol blue (BTB) indicator solution used in the quality control of glassware shall be prepared by adding 16 ml 0.01 N NaOH to 0.1 g BTB and diluted to 250 ml with laboratory pure water to equal a 0.04 percent solution.

AUTHORITY NOTE: Promulgated in accordance with R.S. 40:4.A.(1) and R.S. 40:5.3.

HISTORICAL NOTE: Promulgated by the Department of Health and Hospitals, Office of Public Health, LR 28:1295 (June 2002).

§123. Procedure for the Analysis of Shellfish Growing Waters **[formerly paragraph 9:002-11]**

A. Analysis of shellfish growing waters for the Louisiana Molluscan Shellfish Program shall be performed by a laboratory officially designated as part of the Louisiana shellfish sanitation laboratory system. Procedures and methods for analysis of shellfish growing water shall conform to criteria stipulated in the 4th edition of American Public Health Association (APHA) *Recommended Procedures for the Examination of Sea Water and Shellfish* published August 29, 2011, and appropriate sections in *Official Methods of Analysis*, 21st Edition, published in 2019, of the Association of Official Analytical Chemists (A.O.A.C.).

1. Microbiological examinations shall be conducted as follows: Appropriate dilutions shall be made with Butterfield's buffered phosphate diluent. Shake the sample and each successive dilution bottle 25 times vigorously

using up and down movements of about 30 cm in seven seconds. Inoculate the water sample directly into tubes containing A-1 medium in suitable decimal dilutions using three or five tubes/dilution and a minimum of three dilutions. Place inoculated tubes into air incubator and incubate three hours plus/minus 0.5 hour at 35 degrees plus/minus 0.5 degrees Centigrade (C). Transfer tubes to water bath and incubate 21 plus/minus two hours at 44.5 degrees plus/minus 0.2 degrees C. Maintain the water level above the level of liquid in the inoculated tubes. Examine the inoculated tubes at the end of this period and record the results.

AUTHORITY NOTE: Promulgated in accordance with R.S. 40:4.A.(1), R.S. 40:5.A.(2)(3)(5)(7)(9)(15)(17)(19)(20) and R.S. 40:5.3.

HISTORICAL NOTE: Promulgated by the Department of Health and Hospitals, Office of Public Health, LR 28:1296 (June 2002), amended by the Department of Health, Office of Public Health, LR 48:1848 (July 2022), repromulgated LR 48:2136 (August 2022).

§125. Determination of Results, Records and Data Reporting
[formerly paragraph 9:002-12]

A. Test result data for use by the Louisiana Molluscan Shellfish Program shall be generated by an officially designated laboratory of the Louisiana molluscan shellfish sanitation laboratory system.

B. Determination of results of microbiological analysis of shellfish growing waters shall conform to criteria stipulated in the current edition of American Public Health Association (APHA) *Recommended Procedures for the Examination of Sea Water and Shellfish* and appropriate sections in *Official Methods of Analysis*, of the Association of Official Analytical Chemists (A.O.A.C.).

1. The presence of gas in the inverted vial or of dissolved gas which can be removed by slight agitation of the test medium test tube shall constitute a positive test. The number of positive tests in each dilution shall be recorded for determination of the Most Probable Number (MPN).

2. The standard Most Probable Number (MPN) tables as found in the appropriate tables in the current edition of American Public Health Association (APHA) *Recommended Procedures for the Examination of Sea Water and Shellfish* and *Official Methods of Analysis*, of the Association of Official Analytical Chemists (A.O.A.C.) shall be used to determine MPN values.

C. All test result data shall be verified and documented and shall be reported by the laboratory as fecal coliform MPN/100 ml sample to the proper authorities.

D. A record of all test result data shall be maintained by the laboratory or remain accessible to the laboratory for a period of five years. Records may be in tabular and/or electronic form and should include date, place and time of sampling, name of person collecting sample, identification of sample, date of receipt of sample and analysis, laboratory person responsible for performing analysis, analytical technique used, and results of analysis.

AUTHORITY NOTE: Promulgated in accordance with R.S. 40:4.A.(1), R.S. 40:5.A.(2)(3)(5)(7)(9)(15)(17)(19)(20) and R.S. 40:5.3.

HISTORICAL NOTE: Promulgated by the Department of Health and Hospitals, Office of Public Health, LR 28:1296 (June 2002), amended by the Department of Health, Office of Public Health, LR 48:1848 (July 2022), repromulgated LR 48:2136 (August 2022).

§127. Qualification for Laboratories Conducting Analysis of Shellfish Growing Waters for the Louisiana Molluscan Shellfish Program
[formerly paragraph 9:002-13]

A. Laboratories conducting microbiological analysis of shellfish growing waters for the Louisiana Molluscan Shellfish Program shall be officially designated as part of the Louisiana state shellfish sanitation laboratory system. To be so designated, laboratories shall be evaluated by the Laboratory Evaluation Officer and shall maintain a satisfactory rating.

1. The Certified Laboratory shall be evaluated by the FDA Laboratory Evaluation Officer, Department of Health and Human Services, Public Health Service, Food and Drug Administration, Center for Food Safety and Applied Nutrition, Office of Food Safety, Division of Seafood Safety, Shellfish Aquaculture and Policy Branch.

B. Evaluations shall be conducted at a minimum of every three years or more frequently if necessary. Loss of satisfactory reevaluation will result in loss of said designation. More frequent evaluations will be required under the following circumstances:

1. a previous marginal or low evaluation rating;
2. notable deviations from acceptable or established methods;
3. major changes in workloads or priorities;
4. a substantial turnover of personnel;
5. at the request of the FDA, Director, Shellfish and Aquaculture Policy Branch or the Louisiana Molluscan Shellfish Program control authorities.

C. The laboratory shall meet all requirements as described in this document and be found to be in substantial conformity with the National Shellfish Sanitation (NSSP) as approved by the Louisiana Shellfish Sanitation Program (LSSP).

D. Analysts, supervisory and administrative personnel involved in the generation, verification and reporting of laboratory data for the LSSP shall meet qualifications described in the following Section.

E. The laboratory facilities shall meet the following criteria.

1. Work space shall be adequate (200 square ft., 2 and 6 linear feet of bench/analyst) to accommodate peak workloads.
2. Work space shall include sufficient bench top area for processing samples, storage space for media, glassware, and portable equipment, floor space for stationary equipment

and instrumentation, and associated areas for cleaning glassware and for sterilizing materials.

3. Facilities shall be clean, air-conditioned, and have adequate lighting at the bench top (100 ft. candles).

F. The laboratory shall demonstrate a conscious effort to safeguard against electrical, fire and accidental chemical spills and to minimize microbiological hazards, facility deficiencies and equipment failures.

G. The laboratory shall have an established quality control program to substantiate the validity of analytical data. The quality control procedures in effect shall conform to the criteria stipulated in the current edition of *Standard Methods for the Examination of Water and Wastewater* and/or *APHA Recommended Procedures for the Examination of Sea Water and Shellfish and Official Methods of Analysis* of the Association of Official Analytical Chemists (A.O.A.C.). Compliance with procedures shall be recorded and documented and records maintained by or be accessible to the laboratory for a period of five years.

H. The following constitute minimal quality assurance procedure requirements for the laboratory.

1. Water deionization units shall be monitored daily continuously with a conductivity meter and analyzed at least annually for trace metals. Cartridges shall be replaced at intervals recommended by the manufacturer or as indicated by analytical results. Units shall be monitored for effectiveness in removing bacterial contamination monthly with heterotrophic plate counts and filters shall be changed when the count exceeds 1,000/ml.

2. The suitability and bacteriological quality of pure water used in the analysis of shellfish growing waters shall be tested annually and shall meet the acceptable limits of water quality as stipulated in the table of requirements for quality of purified water used in microbiology testing, current edition of *Standard Methods for the Examination of Water and Wastewater*.

3. Media dispensing units shall be checked for accuracy of dispensing with a graduated cylinder at the start of each volume change and periodically through extended runs.

4. The performance of hot air ovens shall be tested for performance quarterly with commercially available spore strips or spore. The temperature shall be monitored and recorded with a thermometer accurate to 160° to 180°C range. Heat-indicating tapes should be used to identify supplies and material that have been exposed to sterilization temperatures.

5. The temperature, pressure, and time for each autoclave run shall be recorded. Operating temperature shall be checked weekly with a minimum/maximum thermometer and the autoclave performance shall be tested with spore strips or suspensions monthly. Heat-sensitive tape shall be used to identify supplies and material that have been sterilized.

6. The temperature of air incubators shall be checked and recorded twice daily (morning and afternoon) on the shelf areas in use. If a glass thermometer is used, the bulb and stem shall be submerged in water or glycerin to the stem mark. Ideally, a recording thermometer and an alarm system should be used. Locate incubator where room temperature is in the range of 16°C.

7. Batches of clean glassware shall be spot checked for pH reaction as follows: Add a few drops of 0.04 percent Bromothymol blue or other pH indicator and observe the color reaction. Bromothymol blue may be yellow (acid) to blue-green (neutral) to blue (alkaline), in the pH range of 6.5 to 7.3.

8. Glassware and prewashed, presterilized plasticware shall be tested annually and before using a new supply of detergent for inhibitory residues from wetting agents or detergents that may contain bacteriostatic or inhibiting substances according to procedures in the current edition of *Standard Methods for the Examination of Water and Wastewater*.

9. Each new lot of media shall be checked with known positive and negative control cultures for the organisms under test. For media prepared, the date of preparation, type of medium, lot number, sterilization and temperature, final pH and preparing technician shall be recorded.

10. A representative sample from each batch of media, dilution water and buffers and glassware shall be verified for sterility according to procedures in the current edition of *Standard Methods for the Examination of Water and Wastewater*.

11. In laboratories where there is more than one analyst, analysts shall make parallel analyses on at least one positive sample quarterly.

12. Balances shall be calibrated monthly using Class S or S-1 reference weights or weights traceable to Class S or S-1 reference weights. If non-reference weights are used they shall be calibrated annually with Class S or S-1 reference weights.

13. Glass/mercury thermometer calibration should be checked annually against a reference National Institute of Standards and Technology (NIST) thermometer or one which meets the requirements of NIST monograph 150, 2020 edition, published August 2020.

14. The temperature of refrigerators used to store samples, media, reagents and other laboratory supplies shall be recorded once daily for days in use.

15. Air quality in the laboratory should be monitored weekly with air density plates and bench tops with RODAC plates or the swab method.

16. Electrometric pH meters shall be standardized each use period with pH 7.0 standard buffer.

17. The accurate transfer of test result data from the bench worksheet to the final report and/or electronic information storage and retrieval systems shall be verified and initialed by the analyst.

AUTHORITY NOTE: Promulgated in accordance with R.S. 40:4.A.(1), R.S. 40:5.A.(2)(3)(5)(7)(9)(15)(17)(19)(20) and R.S. 40:5.3.

HISTORICAL NOTE: Promulgated by the Department of Health and Hospitals, Office of Public Health, LR 28:1297 (June 2002), amended by the Department of Health and Hospitals, Office of Public Health, Center for Environmental Health Services, LR 34:445 (March 2008), amended by the Department of Health, Office of Public Health, LR 48:1848 (July 2022), repromulgated LR 48:2137 (August 2022).

§129. Qualification for Personnel Conducting Analysis of Shellfish Growing Waters
[formerly paragraph 9:002-14]

A. Laboratory personnel conducting microbiological analysis for LSSP shall be administratively attached to an officially designated laboratory of the shellfish sanitation laboratory system, shall be evaluated by the shellfish evaluation officer for the state of Louisiana for the FDA evaluation officer during an on-site evaluation and shall maintain a satisfactory rating.

1. Analysts in the Certified Laboratory in Baton Rouge shall be evaluated by the FDA Laboratory Evaluation Officer, Department of Health and Human Services, Public Health Service, Food and Drug Administration, Center for Food Safety and Applied Nutrition, Office of Food Safety, Division of Seafood Safety, Shellfish Aquaculture and Policy Branch.

B. Laboratory analysts eligible for evaluation shall have qualifications equal to or greater than required for employment in an entry level position as a state laboratory scientist under the Louisiana Civil Service system.

1. Minimum qualifications include a baccalaureate degree with 24 semester hours in a biological science, microbiology, chemistry, nuclear science, physical science or any combination.

2. Any laboratory analyst with three years experience conducting microbiological analysis and who is so employed on the effective date of these regulations shall be exempt from the requirements of Paragraph 1 above.

C. Supervision in the laboratory shall be by a professional laboratory scientist experienced in shellfish sanitation microbiology and with qualifications equal to or greater than required for employment as a state laboratory scientist, first-line supervisor under the Louisiana Civil Service system. If a supervisor is not available, a consultant having the same qualifications may be substituted.

1. Minimum qualifications include a baccalaureate degree with semester hours in a biological science, microbiology, chemistry, nuclear science, physical science or any combination followed by three years of full time professional experience in a laboratory facility performing microbiological, chemical or nuclear science procedures.

2. Any laboratory supervisor so employed on the effective date of these regulations and who has the other qualifications specified in Paragraph 1 above shall be exempt from the requirement of a baccalaureate degree.

AUTHORITY NOTE: Promulgated in accordance with R.S. 40:4.A.(1), R.S. 40:5.A.(2)(3)(5)(7)(9)(15)(17)(19)(20) and R.S. 40:5.3.

HISTORICAL NOTE: Promulgated by the Department of Health and Hospitals, Office of Public Health, LR 28:1298 (June 2002), amended by the Department of Health, Office of Public Health, LR 48:1849 (July 2022), repromulgated LR 48:2137 (August 2022).

§131. Qualifications, Requirements for Laboratory Evaluation Officer for the State of Louisiana
[formerly Paragraph 9:002-15]

A. The shellfish evaluation officer for the state of Louisiana shall be designated by letter by the Federal Department of Health and Human Services, Public Health Service, Food and Drug Administration, Center for Food Safety and Applied Nutrition, Office of Food Safety, Division of Seafood Safety, Shellfish Aquaculture and Policy Branch. Designation is based upon meeting the requirements of the NSSP Guide Guidance document.

1. The individual shall be administratively attached to a Louisiana Molluscan Shellfish Laboratory which has been found by the FDA to conform or provisionally conform with the National Shellfish Sanitation Program (NSSP).

2. The individual shall be an experienced analyst and should have supervisory experience.

3. If deemed necessary by an FDA laboratory evaluation officer, the individual shall conduct several laboratory evaluations jointly with FDA Shellfish and Aquaculture Policy Branch laboratory evaluation officers.

4. During a joint on-site evaluation with an FDA laboratory evaluation officer, the individual shall demonstrate competence in evaluating analysts' performance of the applicable shellfish laboratory test methods in the 4th edition of the APHA Recommended Procedures for the Examination of Sea Water and Shellfish and the Official Methods of Analysis of the Association of Official Analytical Chemists (A.O.A.C). The evaluation will be recorded on the FDA Evaluation Laboratory Checklist.

5. The individual shall submit a written report to all evaluations conducted to the FDA Division of Cooperative Programs, Shellfish Sanitation Branch with a copy to the appropriate FDA shellfish specialist. The report should consist of the FDA Shellfish Standard Laboratory Evaluation Form, a summary list of qualified analysts and a narrative discussion for each laboratory evaluated. The narrative discussions shall include the identity of the laboratory, the date of evaluation, name of evaluator, a precise and accurate description of the conditions which existed during the evaluation, including what recommendations were made to correct deviations necessary to bring the laboratory into substantial conformity with the requirements of NSSP as approved by the Louisiana State Shellfish Sanitation Program and appropriate information on personnel and procedures and conclusions.

B. The evaluation shall be valid for a period of three years and reevaluation will be held triennially. Satisfactory

reevaluation is based on the individual satisfying the following criteria.

1. The individual shall continue to be administratively attached to a state central shellfish sanitation laboratory which has been found by FDA to be in conformity with the National Shellfish Sanitation Program (NSSP) requirements.

2. The individual shall demonstrate continued satisfactory competence in evaluating the shellfish laboratory test methods of analysts during a joint laboratory evaluation with an FDA laboratory evaluation officer.

3. The individual shall submit a written report of the joint laboratory evaluation to the FDA Shellfish and Aquaculture Policy Branch laboratory evaluation officers with a copy to the appropriate FDA shellfish specialist.

4. The individual shall have all state laboratory evaluations, quality control examinations, and reports up-to-date.

5. The individual shall receive continuing training, as necessary, in laboratory evaluations and analytical procedures.

C. Laboratory evaluation officers who fail to meet the recertification requirements shall lose their certification until it is demonstrated that all necessary requirements, including training are met.

AUTHORITY NOTE: Promulgated in accordance with R.S. 40:4.A.(1) , R.S. 40:5.A.(2)(3)(5)(7)(9)(15)(17)(19)(20) and R.S. 40:5.3.

HISTORICAL NOTE: Promulgated by the Department of Health and Hospitals, Office of Public Health, LR 28:1298 (June 2002), amended by the Department of Health, Office of Public Health, LR 48:1849 (July 2022), repromulgated LR 48:2137 (August 2022).

§133. Requirements for Laboratory Certification
[formerly paragraph 9:002-16]

A. The laboratory and laboratory analysts are required to receive a satisfactory evaluation during an on-site visit by the shellfish evaluation officer for the state of Louisiana or FDA laboratory evaluation officer in order to be certified.

1. The purpose of the evaluation will be to assure the uniform application of standard procedures and methods in the sampling and analytical examination of shellfish growing waters and to determine and assure the adequacy of facilities, equipment and personnel to perform analytical testing necessary to meet the requirements recommended by the National Shellfish Sanitation Program and found to be acceptable by the Louisiana Molluscan Shellfish Program, administered by the Department of Health , Office of Public Health. Evaluation is not an endorsement of the laboratory facility, its staff the operation as this implies continuing guarantee of performance.

2. A satisfactory rating is achieved by demonstration during an on-site evaluation that the laboratory and laboratory personnel are found to conform or conditionally conform with all requirements as listed in the Shellfish Laboratory Evaluation Check Lists provided by the Federal Department of Health and Human Services, Public Health

Service, Food and Drug Administration, Center for Food Safety and Applied Nutrition, Office of Food Safety, Shellfish Aquaculture and Policy Branch. A satisfactory rating indicates that FDA recognizes that the laboratory complies with recommended procedures and capabilities and that the analytical results produced by the laboratory are in support of the Louisiana Shellfish Sanitation Program and are acceptable to FDA.

3. No reference shall be made in any advertising or sales promotion which would indicate or imply that the Louisiana state shellfish evaluation officer or FDA laboratory evaluation officer evaluated this laboratory or approves, endorses or recommends any proprietary materials, services, or publications mentioned herein or which has as its purpose and intent to cause directly or indirectly the advertised materials or services to be used or purchased because of the evaluation.

B. An applicable, currently dated (i.e., the last satisfactory on-site evaluation shall be documented to have been held within the prior three year period) satisfactory FDA Shellfish Standard Laboratory Evaluation Form and narrative report submitted by the appropriate laboratory evaluation officer to the FDA Division of Cooperative Programs, Shellfish Sanitation Branch with a copy to the appropriate FDA shellfish specialist and the public health laboratory director shall be on file or available upon request.

1. Said narrative report shall include the identity of the laboratory, the date of evaluation, name of evaluator, information on personnel and procedures and conclusions and shall precisely and accurately describe the conditions which existed during the evaluation, including what recommendations were made to correct deficiencies and proposed timetable for any corrective action necessary to bring the laboratory into substantial conformity with the requirements of NSSP as approved by the Louisiana State Shellfish Sanitation Program.

2. If any deficiencies or recommendations were noted in the narrative report, the laboratory shall demonstrate that the stated deficiencies and/or recommendations have been satisfactorily corrected or addressed within the proposed timetable and that the laboratory is substantially in compliance with the requirements of NSSP as approved by the Louisiana state Sanitation Program.

3. Failure to be found to conform or provisionally conform during the on-site evaluation by the appropriate Laboratory Evaluation Officer and/or failure to correct or address deficiencies or recommendations as noted in the narrative report within the stated timetable shall result in loss of satisfactory evaluation.

C. As samples are available, the laboratory shall periodically participate in a split-sample program to test laboratory proficiency and shall receive a grade of satisfactory.

1. Refusal to participate and/or repeated failure to receive a satisfactory grade shall result in loss of satisfactory evaluation.

D. The laboratory shall maintain a list of qualified analysts who have received a satisfactory rating as a result of the evaluation procedures and who are consequently approved to conduct analysis in the laboratory.

AUTHORITY NOTE: Promulgated in accordance with R.S. 40:4.A.(1), R.S. 40:5.A.(2)(3)(5)(7)(9)(15)(17)(19)(20) and R.S. 40:5.3.

HISTORICAL NOTE: Promulgated by the Department of Health and Hospitals, Office of Public Health, LR 28:1299 (June 2002), amended by the Department of Health, Office of Public Health, LR 48:1849 (July 2022), repromulgated LR 48:2138 (August 2022).

§135. Fees for Services
[formerly paragraph 9:002-17]

A. Fees for evaluations, analysis, determination, processing and reporting of results shall be incorporated into the Louisiana Molluscan Shellfish Program fee and assessed in accordance with rules and regulations controlling their collection.

B. The department shall charge and collect an imported seafood safety fee of one hundred dollars annually from each holder of a commercial seafood permit fee who sells imported seafood. The proceeds of such fee shall be used for the purposes described in R.S. 40:5.10.1. Pursuant to said statute, the department or its agents or contractors may conduct sampling of imported seafood stored on the premises of any business holding a commercial seafood permit issued pursuant to R.S. 40:31.35, the scope and frequency of which shall be within the discretion of the department. Samples collected pursuant to this Subsection may be laboratory tested at the discretion of the Department for any substances prohibited in applicable types or categories of seafood by the U.S. Food and Drug Administration (FDA). Such testing shall be conducted by laboratories accredited therefor by the FDA or an FDA-recognized accreditation body.

AUTHORITY NOTE: Promulgated in accordance with R.S. 40:4.A.(1) , R.S. 40:5.A.(2)(3)(5)(7)(9)(15)(17)(19)(20), R.S. 40:5.3 and R.S.40:31:35.

HISTORICAL NOTE: Promulgated by the Department of Health and Hospitals, Office of Public Health, LR 28:1300 (June 2002), amended by the Department of Health, Office of Public Health, LR 48:1850 (July 2022), repromulgated LR 48:2138 (August 2022).

§137. References
[formerly paragraph 9:002-18]

A. Where the "current edition" of the following works is referred to in these regulations, such shall mean:

1. Recommended Procedures for the Examination of Sea Water and Shellfish, fourth edition, American Public Health Association, Inc., 1970;

2. Official Methods of Analysis, of the Association of Official Analytical Chemists, Edition 14, §46.017-46.019, 1984;

3. Official Methods of Analysis of the Association of Analytical Chemists, Edition 14, Table 46:01 and Table 46:02, 1984;

4. Standard Methods for the Examination of Water and Wastewater, Sixteenth Edition, 1985, Part 900;

5. Shellfish Sanitation Interpretation S.S. 35 entitled "Evaluation of Laboratories by State Shellfish Laboratory Evaluation Officers" Part III, §B(I), 1985.

AUTHORITY NOTE: Promulgated in accordance with R.S. 40:4.A.(1) and R.S. 40:5.3.

HISTORICAL NOTE: Promulgated by the Department of Health and Hospitals, Office of Public Health, LR 28:1300 (June 2002).

§139. Records of Shellfish Purchases and Sales
[formerly paragraph 9:003]

A. Every person, firm or corporation who conducts any wholesale business of buying, selling or shipping shellfish shall keep an accurate daily record which shall include shipping documents.

1. Each shellfish shipment shall be accompanied by a shipping document which shall contain:

- a. the name, address, and certification number of the shipping dealer;
- b. the name and address of the major consignee; and
- c. the kind and quantity of the shellfish product.

2. The receiving dealer shall:

- a. maintain in his files a copy of the completed shipping document; and
- b. make the shipping document available to the authority upon request.

3. If the shipment is subdivided to different dealers, each receiving dealer shall maintain records sufficient to trace his portion back to the original shipment.

B. Transaction and Shipping Records. Each dealer shall have a business address at which transaction records are maintained. Each dealer shall maintain accurate and legible transaction records that are sufficient to:

1. document that the shellfish are from an authorized source;

2. permit a container of shellfish to be traced back to the specific incoming lot of shucked shellfish from which it was taken;

3. permit a lot of shucked shellfish or a lot of shellstock to be traced back to the growing area(s), date(s) of harvest, date and location of wet storage, if applicable, and if possible, the harvester or group of harvesters.

4. trace the wet storage history of the shellstock including, original harvest site, original harvest date, wet storage site(s) and dates.

5. purchase and sales shall be recorded within 72 hours of any purchase or sales:

- a. in a permanently bound ledger book; or

b. computer record, or other method acceptable to and authorized by the Molluscan Shellfish Program;

6. the transaction records shall be retained:

a. in the case of fresh shellfish, for a minimum of one year; and

b. in the case of frozen shellfish, for at least two years or the shelf life of the product, whichever is longer.

AUTHORITY NOTE: Promulgated in accordance with R.S. 40:4.A.(1) and R.S. 40:5.3.

HISTORICAL NOTE: Promulgated by the Department of Health and Hospitals, Office of Public Health, LR 28:1300 (June 2002), amended by the Department of Health, Office of Public Health, LR 48:1850 (July 2022), repromulgated LR 48:2138 (August 2022).

§141. Relaying of Shellfish [formerly paragraph 9:004]

A. No person shall engage in the business of relaying shellfish from waters not approved for direct market harvesting by the state health officer prior to obtaining a permit for that purpose from the Department of Health, Office of Public Health. Growing waters to be utilized for shellfish relaying purposes must meet or exceed the Department of Health's criteria for a restricted area classification. Applications shall be completed and submitted with a fee of \$100, which shall be paid by cashier's check or money order and filed not less than 14 days prior to the beginning of such proposed relaying. Relaying of shellfish shall be permitted only during the first two weeks of each calendar month. The Louisiana Molluscan Shellfish Program shall allow the relay of suitable shellstock during all 12 months of the year.

B. The Louisiana Molluscan Shellfish Program hereby establishes species-specific critical values for water temperature and salinity, which may affect the natural treatment process in the growing area to which the shell stock *Crassostrea virginica* (American Oyster, Eastern Oyster) will be relayed.

1. The critical salinity tolerances *Crassostrea virginica* shall be established as 3 to 36 parts per thousand. Salinities shall be measured at approximately twelve inches below the water surface.

2. The critical temperature for *Crassostrea virginica* shall be established at temperatures 44-89 degrees Fahrenheit. Water temperatures shall be measured at approximately 12 inches below the water surface.

3. The species-specific critical pollution criteria shall be that the growing area for relay shall demonstrate through its historical data that the water quality can reasonably be expected to meet the approved or conditionally approved criteria.

4. Relay activities which expose shell stock to this range of temperature and salinity values for a minimum of fourteen days shall be considered as meeting the species-specific critical values for relay of *Crassostrea virginica*.

5. The requirement for monitoring environmental conditions of the relay area shall be accomplished by collecting bacteriological water sample data and salinity data from sample stations nearest the relay area which are actively collected each month by the program. Three sample stations which triangulate, if possible, the relay area will be selected to meet this monitoring requirement.

6. No studies of contaminant levels of poisonous or deleterious substances in shellstock shall be conducted on shellstock for relay unless there exists scientific evidence which indicates the relay shellstock contains a poisonous or deleterious substance(s) which exceed a FDA tolerance level(s), or it is known that relay shellstock have been exposed to high levels of poisonous or deleterious substances.

7. The growing area to be used for the treatment process shall be monitored with sufficient frequency to identify when limiting critical value of water temperature of 44-89 degrees Fahrenheit and salinity 3-36 parts per thousand may be approached.

8. The effectiveness of species-specific contaminated reduction shall be determined based on a study. The study report shall demonstrate that, after the completion of the relay activity, the microbiological quality of shellstock is the same microbiological quality as that of the same shellstock already present in the approved or conditionally approved area.

AUTHORITY NOTE: Promulgated in accordance with R.S. 40:4.A.(1), R.S. 40:5.A.(2)(3)(5)(7)(9)(15)(17)(19)(20) and R.S. 40:5.3.

HISTORICAL NOTE: Promulgated by the Department of Health and Hospitals, Office of Public Health, LR 28:1300 (June 2002), amended by the Department of Health, Office of Public Health, LR 48:1850 (July 2022), repromulgated LR 48:2139 (August 2022).

§143. Performance Bond Required [formerly paragraph 9:004-1]

A. A \$5,000 cash performance bond consisting of a bank cashier's check made payable to the Department of Health shall be submitted with each completed application. In addition to the bond, a permittee, at his own expense shall secure the services of a surveillance officer approved by the Department of Health and the Department of Wildlife and Fisheries for the purpose of monitoring all harvesting, transporting, and bedding of shellfish for relaying purposes. In order to satisfy the monitoring requirements, all harvesting, transporting and bedding of shellfish for relaying purposes shall take place in the direct line of sight of the state-approved surveillance officer.

AUTHORITY NOTE: Promulgated in accordance with R.S. 40:4.A.(1), R.S. 40:5.A.(2)(3)(5)(7)(9)(15)(17)(19)(20) and R.S. 40:5.3.

HISTORICAL NOTE: Promulgated by the Department of Health and Hospitals, Office of Public Health, LR 28:1300 (June 2002), amended by the Department of Health, Office of Public Health, LR 48:1851 (July 2022), repromulgated LR 48:2139 (August 2022).

§145. Permit Required for Relaying
[formerly paragraph 9:004-2]

A. Permits are required prior to performing any relaying at the discretion of the Department of Health, Office of Public Health under the following restrictions.

1. No permittee or boat captain may serve on any vessel subject to this permit who has been cited or found guilty of violations relative to the harvesting of shellfish within three years of the application date; provided, however that said permittee or boat captain may receive a waiver of this condition with regard to those citations which did not result in a conviction upon the appropriate showing being made to the Department of Wildlife and Fisheries.

2. Should environmental conditions in the growing area used for relay exceed the limits of classification of the growing area, the relay area shall be closed along with all other affected growing area. The minimum 14-day treatment time shall only be during the time that relay area is characterized by water temperatures and salinity units that are within critical limits.

3. Shellfish harvested for relaying purposes from restricted waters shall not be laid down within 500 feet of any adjoining lease where shellfish may be taken for sale as food during the active period of the relay permit.

4. Sacking of shellfish, storage of empty shellfish sacks on board permitted or authorized relaying vessels and/or the direct marketing of shellfish taken from waters not approved for that purpose by the state health officer shall be strictly prohibited.

5. Culling of shellfish shall be permitted only when container relaying is practiced and written authorization is obtained from the Department of Health a.

6. Only two leases in the restricted area and approved bedding area, each pre-approved by the Department of Health, shall be utilized in the relaying of shellfish.

a. Shellfish relayed from a restricted area of a public oyster seed ground will be allowed at the discretion of the Louisiana Department of Wildlife and Fisheries (LDWF) only during the open oyster season. Shellstock from the public oyster seed ground will be allowed to be bedded on only two approved leases which will be pre-approved by the Department of Health. Relaying from a public oyster seed ground area shall be for the purpose of moving the live oyster resource. The removal of excessive amounts of non-living reef material in relay loads shall result in the forfeiture of the relay permit and/or the closure of the public oyster seed ground area to transplanting. Permit-holders shall allow on-board inspection and sampling of relay loads by the LDWF.

7. The permittee shall be responsible for notifying the Department of Wildlife and Fisheries prior to leaving port to relay shellfish and immediately upon returning from the permitted trip each day. The Department of Wildlife and Fisheries shall be notified by calling (800) 442-2511.

8. All leases shall be "red flagged" so that they may be easily spotted by both aircraft and boats. "Red flagged" as used in this Paragraph, means that the four outside corners of the lease must be marked with poles with red flags attached.

9. All activities relative to the relaying of shellfish shall be permitted only during daylight hours with all activities completed no later than 30 minutes after official sunset. Applicants may apply for a written exemption to this requirement when the distance between the restricted area and bedding area is such that compliance is not possible.

10. Both sides of the permitted vessel shall be marked with the permit number in at least 6-inch-high letters on a contrasting background so as to be visible from low flying aircraft or from any other vessel in the immediate vicinity.

11. A copy of the complete relay permit and applicable rules shall be on board each authorized vessel at all times during the active period of the relay permit.

12. The harvesting of shellfish for relaying purposes within 150 feet of any sewage discharge point emanating from any camp, home, or other habitable structure shall be prohibited.

AUTHORITY NOTE: Promulgated in accordance with R.S. 40:4.A.(1), R.S. 40:5 (2)(3)(5)(7)(15), and R.S. 40:5.3.

HISTORICAL NOTE: Promulgated by the Department of Health and Hospitals, Office of Public Health, LR 28:1300 (June 2002), amended by the Department of Health and Hospitals, Office of Public Health, Center for Environmental Health Services, LR 34:445 (March 2008), LR 34:2175 (October 2008), LR 48:1851 (July 2022), LR 34:2175 (October 2008), repromulgated LR 48:2140 (August 2022).

§147. Surveillance Officer's Daily Trip Report
[formerly paragraph 9:004-3]

A. An official Department of Health's "Surveillance Officers Daily Trip Report" must be completed each day by the surveillance officer and mailed to the Department of Health, Seafood Sanitation Unit after each completed day of relaying.

AUTHORITY NOTE: Promulgated in accordance with R.S. 40:4.A.(1), R.S. 40:5.A.(2)(3)(5)(7)(9)(15)(17)(19)(20) and R.S. 40:5.3.

HISTORICAL NOTE: Promulgated by the Department of Health and Hospitals, Office of Public Health, LR 28:1301 (June 2002), amended by the Department of Health, Office of Public Health, LR 48:1852 (July 2022), repromulgated LR 48:2140 (August 2022).

§149. Enforcement Provisions
[formerly paragraph 9:004-4]

A. Failure to comply with any of the permitting requirements specified in §§141-147 shall result in the following administrative action.

1. The relay permit and all relay permitting privileges shall be immediately suspended by the Department of Health or the Department of Wildlife and Fisheries.

2. All shellfish harvested for relaying purposes in violation of permitting requirements shall be returned to the

original growing waters or destroyed at a permittee's own expense.

3. If said charges are upheld in an administrative hearing, the following additional penalties shall be imposed.

a. Relay permitting privileges shall be denied for a period of three years.

b. The \$5,000 cash bond posted by the permittee shall be forfeited and retained by the state.

AUTHORITY NOTE: Promulgated in accordance with R.S.40:4.A.(1)), R.S. 40:5.A.(2)(3)(5)(7)(9)(15)(17)(19)(20) and R.S. 40:5.3.

HISTORICAL NOTE: Promulgated by the Department of Health and Hospitals, Office of Public Health, LR 28:1301 (June 2002), amended by the Department of Health, Office of Public Health, LR 48:1852 (July 2022), repromulgated LR 48:2140 (August 2022).

Chapter 3. Preparation and Handling of Seafood for Market

§301. Water Storage of Shellfish [formerly paragraph 9:005]

A. The water storage, cleansing, bedding or conditioning of shell stock shall not be permitted or practiced in water with a salt content less than that in which shell fish will naturally grow to maturity, and shall not be permitted or practiced on the following:

1. [formerly paragraph 9:005-1] artificial bodies of water, unless the entering water has a bacteriological quality at all times at least equal to the U. S. Public Health Service standards for drinking water; or

2. [formerly paragraph 9:005-2] natural bodies of water which are subject to either constant or intermittent pollution as disclosed by a sanitary survey, or any water in such proximity to dwellings, industrial plants, boats or docks that their cleanliness can be protected only by the strict observance of sanitary regulations by all persons in the vicinity.

AUTHORITY NOTE: Promulgated in accordance with R.S. 40:4.A.(1) and R.S. 40:5.3.

HISTORICAL NOTE: Promulgated by the Department of Health and Hospitals, Office of Public Health, LR 28:1301 (June 2002).

§303. Construction and Cleanliness of Shellfish Boats [formerly paragraph 9:006]

A. All boats utilized for the harvesting or transporting of shellfish shall be provided with a false deck or bottom to prevent the contamination of shellfish with bilge water. For the purpose of this regulation, bilge water may be defined as any water that collects in the lowest inner part of a boat's hull. Decks, holds or binds used for storage of shellfish shall be washed daily with either potable water, or water drawn from an approved growing area or Conditionally Approved area in open status. Unless otherwise exempted in writing by the Louisiana Department of Health, a suspended awning shall be provided on harvest boats to protect shellfish from direct exposure to sun, birds and other adverse conditions.

The suspended awning shall be a minimum of 12 inches above the shellfish with a maximum height of 7 feet. The suspended awning shall be of such width and length so as to extend to the outer edges of the harvesting or transporting vessel. The provisions of this rule shall apply to all types of harvesting and transporting vessels. Small children in diapers, dogs, cats or other forms of wildlife shall not be permitted on board harvesting vessels while shellfish are being fished or transported. Violation of any of the requirements in this Section shall result in one of the following penalties.

1. Shellfish shall be seized and destroyed at violator's expense.

2. Shellfish shall be bedded on a Department of Wildlife and Fisheries managed seed reservation at violator's expense.

AUTHORITY NOTE: Promulgated in accordance with R.S. 40:4.A.(1), R.S. 40:5.A.(2)(3)(5)(7)(9)(15)(17)(19)(20) and R.S. 40:5.3.

HISTORICAL NOTE: Promulgated by the Department of Health and Hospitals, Office of Public Health, LR 28:1301 (June 2002), repromulgated LR 29:173 (February 2003), repromulgated by the Department of Health, Office of Public Health, LR 48:1852 (July 2022), repromulgated LR 48:2140 (August 2022).

§305. Sewage Disposal on Shellfish Boats [formerly paragraph 9:007]

A. Owners and operators of all vessels in which persons are engaged in the handling of shellfish from the planting or growing grounds, shall provide their vessels with suitable receptacles, including tight fitting lids. These waste receptacles shall be properly labeled with the wording "FOR HUMAN WASTE ONLY" with the letter size being no less than 1 and 1/2 inches and be of adequate size and type having a capacity of at least 2 gallons for each person on the boat, in which the extract, both solid and liquid, of person on the boats, shall be received. The contents of such receptacles shall be disposed of either by means of the sewerage system of a municipality, by incineration, or by burial in the ground at points sufficiently removed from the banks of streams or tidal waters to prevent the pollution of the waters thereof, or any other means of disposal authorized by law.

AUTHORITY NOTE: Promulgated in accordance with R.S. 40:4.A.(1) and R.S. 40:5.3.

HISTORICAL NOTE: Promulgated by the Department of Health and Hospitals, Office of Public Health, LR 28:1302 (June 2002), amended LR 33:850 (May 2007), LR 35:1239 (July 2009).

§307. Sewage Disposal near Shellfish Areas [formerly paragraph 9:008]

A. The discharge of human waste from any camp, boat or other source into the waters directly over, or adjacent to, areas where the shellfish are being produced for market is prohibited.

AUTHORITY NOTE: Promulgated in accordance with R.S. 40:4.A.(1) and R.S. 40:5.3.

HISTORICAL NOTE: Promulgated by the Department of Health and Hospitals, Office of Public Health, LR 28:1302 (June 2002).

§309. Contamination of Shell-Stock Prohibited
[formerly paragraph 9:009]

A. Shell-stock held in wet or dry storage shall be so kept at all times that it will not become contaminated. Shell-stock held in wet storage shall meet the requirements of §301 of this Part. Shell-stock held in dry storage shall be packed in clean containers and stored above the floor, so as to be protected from filth, animal droppings, and other possible contamination.

AUTHORITY NOTE: Promulgated in accordance with R.S. 40:4.A.(1) and R.S. 40:5.3.

HISTORICAL NOTE: Promulgated by the Department of Health and Hospitals, Office of Public Health, LR 28:1302 (June 2002).

§311. Permits to Operate Seafood Establishments
[formerly paragraph 9:010]

A. No person, firm or corporation shall operate or conduct an establishment for the cleaning, shucking, picking, peeling, or packing of any marine or fresh-water animal food product within the state of Louisiana until it has been inspected and approved by the Louisiana state health officer. Application for such inspection and approval shall be made in writing. After inspection and approval the Louisiana state health officer shall issue to the owner, operator or manager of the establishment, a permit to operate, which shall be serially numbered. Said permit may be revoked for violation of any of the provisions of the sanitary code. The serial number of said permit shall appear on every package, can, carton, or other container in which shell-fish are packed for distribution and sale. Other marine or fresh water animal food products shall be satisfactorily identified if the serial number of the permit or the packer's name and address is imprinted, embossed, or lithographed on the seafood container.

AUTHORITY NOTE: Promulgated in accordance with R.S. 40:4.A.(1), R.S. 40:5.A.(2)(3)(5)(7)(9)(15)(17)(19)(20), R.S. 40:5.3, R.S. 40:5.10.1 and R.S. 40:31.35(C).

HISTORICAL NOTE: Promulgated by the Department of Health and Hospitals, Office of Public Health, LR 28:1302 (June 2002), repromulgated by the Department of Health, Office of Public Health, LR 48:1852 (July 2022), repromulgated LR 48:2140 (August 2022).

§313. Plant Construction
[formerly paragraph 9:011]

A. Plans for new establishments shall be submitted to the Louisiana state health officer for approval before construction.

B. [formerly paragraph 9:012] The construction of plants for cleaning, shucking, picking, peeling, packing, or otherwise handling marine or fresh water animal food products, shall meet the requirements listed in §313.C-K.

C. [formerly paragraph 9:013] Lighting shall be a minimum of 40 foot-candles (either natural or artificial) and ventilation (force draft if necessary) shall be provided in all parts of the building used.

D. [formerly paragraph 9:014] Space used for washing and packing marine or fresh water animal food products shall be effectively separated by flytight walls or partitions from space used for cleaning, shucking, peeling, picking, or otherwise preparing such products for packing, storing, or shipping. Rooms used for the above purpose shall be constructed throughout so as to permit easy and thorough cleaning and, where necessary to ensure such cleaning, shall be of sheet metal, cement or other type of impervious construction.

E. [formerly paragraph 9:015] Floors shall be constructed of concrete, tile, glazed brick, or other impervious construction to facilitate cleaning. Drainage of all water therefrom shall be complete and rapid.

F. [formerly paragraph 9:016] Storage bins and storage rooms shall be so constructed as to permit easy, thorough, cleaning and drainage, and shall be located adjacent to the washing and packing room.

G. [formerly paragraph 9:017] Cleaning, skinning, shucking, picking or peeling benches shall be of concrete, non-toxic and non-corrosive metal, or other materials approved by the state health officer, and shall be cleaned thoroughly at the end of each day's operation. Walls immediately adjacent to such benches shall be of smooth hard material to a height of 3 feet above said benches and so constructed as to be easily and thoroughly cleaned.

I. The establishment shall be provided with an abundant supply of water under pressure from a source approved by the Louisiana state health officer. No cross connections with unapproved water supplies shall be permitted. The requirements of Parts XII (Water Supplies) of this Code shall be met.

H. [formerly paragraph 9:018] Lavatories with hot and cold running water under pressure, delivered through a mixing faucet, liquid or powdered soap in dispensers, paper or individual towels, shall be provided for use of employees. Towels for common use are prohibited. Lavatories shall be so located that employees can readily use them after using the toilet, but they shall not be located in the toilet rooms.

I. [formerly paragraph 9:019] Sanitary toilets of approved construction and location shall be provided for the use of employees. Toilets shall not open directly into rooms used for cleaning, shucking, picking, peeling, packing or storage of food products. Where sewerage facilities are available, water flush toilets connected to the sewerage system shall be provided. No insanitary privy shall be permitted or maintained on the premises of any seafood establishment. Self-closing doors must be provided for toilet room facilities.

J. [formerly paragraph 9:020] Refrigeration rooms, coolers or ice boxes for the storage or retention of marine and fresh-water animal food products shall be so constructed, painted or otherwise treated as to provide a smooth, impervious surface for easy and thorough cleaning. Floors of refrigeration rooms or walk-in coolers shall be of concrete, tile, glazed brick or other impervious material with

adequate floor drains, or the floor so sloped as to ensure complete and rapid drainage. Walls shall be of concrete, metal, glass board or other material approved by the state health officer. Ice boxes shall be metal, fiberglass or plastic lined with seams welded, soldered, or otherwise treated, to give a smooth, impervious, easily cleaned surface.

K. [formerly paragraph 9:021] Establishments engaged in the cleaning, shucking, picking, peeling or packing of marine or fresh-water animal food products shall be so constructed as to exclude rodents and insects. All outside openings shall be screened. Screen doors shall open outward and, where doors from shipping rooms are open for extended period of time during loading or shipping operations, inside screen doors shall be provided for all openings between the cleaning, picking, shucking, peeling or packing rooms and the shipping rooms.

AUTHORITY NOTE: Promulgated in accordance with R.S. 40:4.A.(1), R.S. 40:5.A.(2)(3)(5)(7)(9)(15)(17)(19)(20) and R.S. 40:5.3.

HISTORICAL NOTE: Promulgated by the Department of Health and Hospitals, Office of Public Health, LR 28:1302 (June 2002), amended by the Department of Health, Office of Public Health, LR 48:1852 (July 2022), repromulgated (August 2022).

§315. Seafood Plant Equipment
[formerly paragraph 9:022]

A. The minimum equipment of marine and fresh water animal food product plants shall comply with the requirements listed in §315.B-E of this Part.

B. [formerly paragraph 9:023] There shall be available a continuous supply of hot water for cleaning purposes, in or about the establishment, while operating. Automatic heaters shall be provided, wherever possible, to ensure a minimum temperature of 170°F.

C. [formerly paragraph 9:024] Shucking pails, measures, skimmers, colanders, tubs, paddles or other utensils shall be made of noncorrosive, nonrustable, smooth, impervious material, and constructed in such manner as to eliminate grooves, seams and cracks where food particles and slime may collect. All seams and joints shall be well filled with solder and dressed to a smooth surface. Knives or other working tools shall be free from cracks or crevices which would retain food particles and slime, or shall allow taking them apart in order to permit easy and thorough cleaning.

D. [formerly paragraph 9:025] Shipping containers for shucked shellfish shall be purchased in tightly sealed, dustproof packages and kept therein in a clean, dry place until used. All containers for marine and fresh water animal food products shall be stored and handled so that the inside surfaces will not become contaminated.

E. [formerly paragraph 9:026] No returnable container shall be used unless it is constructed with straight side walls and a tight fitting cover which is sealed in place after the container is filled; and the whole shall be of noncorrosive, nonrustable, smooth metal of at least 12 gauge and so constructed as to eliminate seams, cracks and grooves that are not well filled with solder dressed to a smooth surface. Returnable containers shall be cleaned immediately after use

and shall be cleaned again and treated with a bactericide just prior to packing food material in them.

AUTHORITY NOTE: Promulgated in accordance with R.S. 40:4.A.(1) and R.S. 40:5.3.

HISTORICAL NOTE: Promulgated by the Department of Health and Hospitals, Office of Public Health, LR 28:1303 (June 2002).

§317. Seafood Plant Operation
[formerly paragraph 9:027 and 9:027-1]

A. The operation of plants engaged in shucking, cleaning, picking, peeling or packing marine or fresh water animal food products shall meet the requirements listed in §317.B-O.

1. Hazard Analysis. Every dealer shall conduct a hazard analysis to determine the food safety hazards that are reasonably likely to occur for each kind of shellfish product processed by that dealer and to identify the preventive measures that the dealer can apply to control those hazards. Such food safety hazards can be introduced both within and outside the processing plant environment, including food safety hazards that can occur before, during, and after harvest. A food safety hazard that is reasonably likely to occur is one for which a prudent dealer would establish controls because experience, illness data, scientific reports, or other information provide a basis to conclude that there is a reasonable possibility that it will occur in the particular type of shellfish product being processed in the absence of those controls.

2. HACCP Plan. Every dealer shall have and implement a written HACCP plan. A HACCP plan shall be specific to:

- a. each location where shellfish products are processed by that dealer; and
- b. each kind of shellfish product processed by the dealer. The plan may group kinds of shellfish products together, or group kinds of production methods together, if the food safety hazard, critical control points, critical limits, and procedures required to be identified and performed in Paragraph 3. are identical for all shellfish products so grouped or for all production methods so grouped.

3. Contents of the HACCP Plan. The HACCP plan shall, at a minimum:

- a. list the food safety hazards that are reasonably likely to occur, as identified in accordance with Paragraph 1 and that thus must be controlled for each shellfish product. Consideration should be given to whether any food safety hazards are reasonably likely to occur as a result of the following:
 - i. natural toxins;
 - ii. microbiological contamination;
 - iii. chemical contamination;
 - iv. pesticides;
 - v. drug residues;

vi. unapproved use of direct or indirect food or color additives; and

vii. physical hazards;

b. list the critical control points for each of the identified food safety hazards, including as appropriate:

i. critical control points designed to control food safety hazards introduced outside the processing plant environment, including food safety hazards that occur before, during, and after harvest. As an alternative, the dealer may establish other critical control points which the dealer can demonstrate that provides equivalent public health protection. If the dealer can demonstrate through a hazard analysis that the food safety hazard is not reasonably likely to occur, the critical control point is not required with the exception of receiving which shall always be considered as a critical control point;

ii. critical control points designed to control food safety hazards that could be introduced in the processing plant environment. As an alternative, the dealer may establish other critical control points which provide equivalent public health protection. If the dealer can demonstrate to the Authority through a hazard analysis that the food safety hazard is not reasonably like to occur, the critical control point is not required;

c. list the critical limits that must be met at each of the critical control points. As an alternative the dealer may establish other critical limits which the dealer has demonstrated provide equivalent public health protection with the exception of receiving which shall always be considered as a critical control point;

d. list the procedures, and frequency thereof, that will be used to monitor each of the critical control points to ensure compliance with the critical limits;

e. include any corrective action plans that have been developed in accordance with Subparagraph 6.b to be followed in response to deviations from critical limits at critical control points;

f. provide for a record keeping system that documents the monitoring of the critical control points. The records shall contain the actual values and observations obtained during monitoring;

g. list the verification procedures, and frequency thereof, that the dealer will use in accordance with Subparagraph 7.a.

4. Signing and Dating the HACCP Plan

a. The HACCP plan shall be signed and dated, either by the most responsible individual on site at the processing facility or by a higher level official of the dealer. This signature shall signify that the HACCP plan has been accepted for implementation by the dealer.

b. The HACCP plan shall be signed and dated:

i. upon initial acceptance;

ii. upon any modification; and

iii. upon verification of the plan in accordance with Clause 7.a.i.

5. Sanitation. Sanitation controls may be included in the HACCP plan. However, to the extent that they are monitored in accordance with Paragraphs 10, 11, and 12. They need not be included in the HACCP plan, and vice versa.

6. Corrective Actions

a. Whenever a deviation from a critical limit occurs, a dealer shall take corrective action either by:

i. following a corrective action plan that is appropriate for the particular deviation; or

ii. following the procedures in Subparagraph 6.c.

b. Dealers may develop written corrective action plans, which become part of their HACCP plans in accordance with Subparagraph 3.e, by which they predetermine the corrective actions that they will take whenever there is a deviation from a critical limit. A corrective action plan that is appropriate for a particular deviation is one that describes the steps to be taken and assigns responsibility for taking those steps, to ensure that:

i. no product enters commerce that is either injurious to health or is otherwise adulterated as a result of the deviation; and

ii. the cause of the deviation is corrected.

c. When a deviation from a critical limit occurs and the dealer does not have a corrective action plan that is appropriate for that deviation, the dealer shall:

i. segregate and hold the affected product, at least until the requirements of Clauses 6.c.ii and iii are met;

ii. perform or obtain a review to determine the acceptability of the affected product for distribution. The review shall be performed by an individual or individuals who have adequate training or experience to perform such a review. Adequate training may or may not include training in accordance with Paragraph 9;

iii. take corrective action, when necessary, with respect to the affected product to ensure that no product to ensure that no product enters commerce that is either injurious to health or is otherwise adulterated as a result of the deviation;

iv. take corrective action, when necessary, to correct the cause of the deviation;

v. perform or obtain timely reassessment by an individual or individuals who have been trained in accordance with Paragraph 9, to determine whether the HACCP plan needs to be modified to reduce the risk of recurrence of the deviation, and modify the HACCP plan as necessary.

d. All corrective actions taken in accordance with this Section shall be fully documented in records that are

subject to verification in accordance with Paragraph 7 and the record keeping requirements of Paragraph 8.

7. Verification

a. Every processor shall verify that the HACCP plan is adequate to control food safety hazards that are reasonably likely to occur, and that the plan is being effectively implemented. Verification shall include, at a minimum:

i. a reassessment of the adequacy of the HACCP plan whenever any changes occur that could affect the hazard analysis or alter the HACCP plan in any way or at least annually. These changes may include: Raw materials or source of raw materials, product formulation, processing methods or systems, finished product distribution systems, or the intended use or consumers of the finished product. The reassessment shall be performed by an individual or individuals who have been trained in accordance with Paragraph 9. The HACCP plan shall be modified immediately whenever a reassessment reveals that the plan is no longer adequate to fully meet the requirements of Paragraph 3;

ii. ongoing verification of activities including:

(a) a review of any consumer complaints that have been received by the dealer to determine whether they relate to the performance of critical control points or reveal the existence of unidentified critical control points;

(b) the calibration of process-monitoring instruments; and

(c) At the option of the dealer, the performing of periodic end-product or in-process testing;

iii. a review, including signing and dating, by an individual who has been trained in accordance with Paragraph 9, of the records that document:

(a). the monitoring of critical control points. The purpose of this review shall be, at a minimum, to ensure that the records are complete and to verify that they document values that are within the critical limits. This review shall occur within one week of the day that the records are made;

(b). the taking of corrective actions. The purpose of this review shall be, at a minimum, to ensure that the records are complete and to verify that appropriate corrective actions were taken in accordance with Paragraph 6. This review shall occur within one week of the day that the records are made;

(c). the calibrating of any process monitoring instruments used at critical control points and the performing of any periodic end-product or in-process testing that is part of the dealer's verification activities. The purpose of these reviews shall be, at a minimum, to ensure that the records are complete, and that these activities occurred in accordance with the processor's written procedures. These reviews shall occur within a reasonable time after the records are made.

b. Dealers shall immediately follow the procedures in Paragraph 6. Whenever any verification procedure, including the review of a consumer complaint, reveals the need to take a corrective action.

c. The calibration of process-monitoring instruments, and the performing of any periodic end product and in-process testing, in accordance with Subclauses 7.a.ii.(b) and (c) shall be documented in records that are subject to the record keeping requirements of Paragraph 8.

8. Records

a. All records required by Paragraphs 1-12 shall include:

i. the name and location of the dealer;

ii. the date and time of the activity that the record reflects;

iii. the signature or initials of the person performing the operation; and

iv. where appropriate, the identity of the product and the production code, if any. Processing and other information shall be entered on records at the time that it is observed.

b. All records required by Paragraphs 1-12 shall be retained at the processing facility for at least one year after the date they were prepared in the case of refrigerated products and for at least two years after the date they were prepared in the case of frozen products.

c. Records that relate to the general adequacy of equipment or processes being used by a processor, including the results of scientific studies and evaluations, shall be retained at the processing facility for at least two years after their applicability to the product being produced at the facility.

d. If the processing facility is closed for a prolonged period between seasonal operations, or if record storage capacity is limited on a processing vessel or at a remote processing site, the records may be transferred to some other reasonably accessible location at the end of the seasonal operations but shall be immediately returned for official review upon request.

e. All records required by Paragraphs 1-12 and HACCP plans required by Paragraphs 2 and 3 shall be available for official review and copying at reasonable times.

f. The maintenance of records on computers is acceptable, provided that appropriate controls are implemented to ensure the integrity of the electronic data and electronic signatures.

9. Training

a. At a minimum, the following functions shall be performed by an individual who has successfully completed training in the application of HACCP principles to shellfish processing at least equivalent to that received under standardized curriculum recognized as adequate by the FDA or who is otherwise qualified through job experience to perform these functions:

i. developing a HACCP plan, which could include adapting a model or generic-type HACCP plan that is appropriate for a specific processor, in order to meet the requirements of Paragraph 3;

ii. reassessing and modifying the HACCP plan in accordance with the corrective action procedures specified in Clause 6.c.v, and the HACCP plan in accordance with the verification activities specified in Clause 7.a.i; and

iii. performing the record review required by Clause 7.a.iii.

b. Job experience will qualify an individual to perform these functions if it has provided knowledge at least equivalent to that provided through the standardized curriculum.

c. The trained individual need not be an employee of the dealer.

10. Sanitation Monitoring. Each dealer shall monitor conditions and practices that are both appropriate to the plant and the food being processed with sufficient frequency. The requirements relate to the following sanitation items:

a. safety of the water that comes into contact with food or food contact surfaces, or is used in the manufacture of ice, hereinafter referred to as: safety of water for processing and ice production;

b. condition and cleanliness of food contact surfaces, including utensils, gloves, and outer garments, and from raw product to cooked product, hereinafter referred to as: Condition and cleanliness of food contact surfaces;

c. prevention of cross contamination from insanitary objects to food, food packaging materials, and other food contact surfaces, including utensils, gloves, and outer garments, and from raw product to cooked product, hereinafter referred to as: prevention of cross contamination;

d. maintenance of hand washing and toilet facilities, hereinafter referred to as: maintenance of hand washing and toilet facilities;

e. protection of food, food packaging material, and food contact surfaces from adulteration with lubricants, fuel, pesticides, cleaning compounds, sanitizing agents, condensate, and other chemical, physical, and biological contaminants, hereinafter referred to as: protection from adulterants;

f. proper labeling, storage, and use of toxic compounds, hereinafter referred to as: proper labeling storage, use of toxic compounds;

g. control of employee health conditions that could result in the microbiological contamination of food packaging materials, and food contact surfaces, hereinafter referred to as: control of employees with adverse health conditions; and

h. exclusion of pests from the food plant, hereinafter referred to as: Exclusion of pests. While monitoring of those specified conditions and practices that

are not appropriate to the plant and the food being processed is not required, compliance with such conditions and practices remains mandatory.

11. Sanitation Monitoring Records. Each dealer shall maintain sanitation control records that, at a minimum, document the monitoring and corrections prescribed by Paragraph 10. These records are subject to the requirements of Paragraph 8.

12. Relationship to HACCP Plan. Sanitation controls may be included in the HACCP plan, required by Paragraph 2. However, to the extent that they are monitored in accordance with Paragraph 10. they need not be included in the HACCP plan, and vice versa.

B. [formerly paragraph 9:028] Employee Health. The requirements of Part I, §117 and Part II, §§501-503.C of this Code shall be met.

C. [formerly paragraph 9:029] During the operating season, the plant shall be used for no purpose other than the handling of shellfish or other marine or fresh water animal foods. Materials and equipment not used in the processing of seafood shall not be stored within the operating part of the plant. All abandoned equipment shall be removed from the plant and the floors shall be kept clear for thorough cleaning. The unoccupied portion of the storage bins, the shucking benches, work tables and all the floors shall be swept and flushed until they are thoroughly cleaned, at least once every day, at the completion of the day's run, with water from a source approved by the state health officer. Refrigeration rooms or ice boxes shall be washed out and thoroughly cleaned once a week or more often if necessary. At least once a week the cleansing shall include the washing of walls.

D. [formerly paragraph 9:030] All employees shall wash their hands thoroughly with running water and soap on beginning work and after each visit to the toilet. Signs to this effect shall be posted by the proprietor in conspicuous places in the plant and in each toilet.

1. The outer clothing worn by persons engaged in handling these food products shall be of such material as to be readily cleaned, and shall be kept clean. Persons engaged in cleaning, shucking, peeling, picking or packing marine or fresh water animal food products to be consumed without further cooking or processing shall be required to wear outer garments that are clean at the start of each day's employment. If finger cots or shields for protecting the palm of the hand are worn, they shall be of waterproof, nonabsorbent material, preferably of rubber (when available).

E. [formerly paragraph 9:031] Spitting and smoking in a marine or fresh water animal food product establishment is strictly prohibited.

F. [formerly paragraph 9:032] All utensils and tools in use, such as opening knives, shucking pails, measures, skimmers, colanders, tanks, tubs, and paddles, which come in contact with oysters, cooked shrimp or cooked and picked crabs, shall each day be thoroughly scoured until clean,

using detergent or an alkali cleanser and then sanitized either:

1. by exposure for at least 15 minutes to a temperature of not less than 170°F, or for not less than five minutes to a temperature of at least 200°F, in a steam cabinet equipped with an indicating thermometer located in the coldest zone;
2. by exposure to a steam jet for at least one minute;
3. by immersion in or exposure to a flow of a chlorine solution of not less than 100 parts of free chlorine per million parts of water for not less than two minutes;
4. by immersion in an iodine solution concentration between 12.5 mg/L and 25 mg/L(ppm); or
5. by immersion in a quaternary ammonium compound solution concentration of 200 mg/L (ppm) or as indicated by the manufacturer's use directions included in labeling; or
6. by immersion in hot water at a temperature of 170 degrees F or more for not less than two minutes; or
7. by exposure to hot air at a temperature of not less than 180 degrees F for not less than 20 minutes, in a properly designed oven or hot air cabinet equipped with an indicating thermometer located in the coldest zone or other method of eliminating pathogenic bacteria as approved by the state health officer.

G. [formerly paragraph 9:033] All equipment used in the shucking, picking, packing or other handling of seafoods, including shucking buckets, knives breaking blocks, finger cots and so forth, shall be stored in such a manner as not to become contaminated after cleaning and bactericidal treatment. Equipment in daily use during operating seasons shall not be removed from the plant for storage, but sufficient room or space shall be provided to store equipment that is not being used.

H. [formerly paragraph 9:034] Shucking, picking, peeling, packing, or other work operations shall be carried out on tables, counters, etc., above floor-level; such operations shall not be performed on the floor. Where marine or fresh water animal food products are stored, adequate protection shall be provided within the storage space to prevent possible contamination from fresh water, wastes, and from foot traffic. Utensils, for handling marine or fresh water animal food products that are to be consumed without further cooking or processing, shall be so placed as to prevent handling of drippings from the food by the workers.

I. [formerly paragraph 9:035] The "nesting" of empty pails shall not be permitted during the operating season. When not in use, pails shall be inverted on racks or benches provided for this purpose.

J. [formerly paragraph 9:036] The cooling to a temperature of 45°F or less of shucked shellfish, picked crabs, cooked, peeled shrimp or other seafoods which are to be consumed without further cooking or processing shall be effected as promptly as possible, and in no case shall the time exceed two hours after shucking, picking or cooking;

provided that crabs or similar seafoods, which are picked after cooking, shall be cooled as rapidly as possible after cooking to a temperature of 45°F or less and held at such temperature until ready to be picked, after which the picked material shall again be cooled, as specified above.

K. [formerly paragraph 9:037] Water for washing any marine or fresh water animal used as a food, or any food products derived from them, shall be from an approved source as defined in Part XII, Water Supplies, of this Code.

L. [formerly paragraph 9:038] Shells, washings and other wastes shall be disposed of in such manner defined in Part XIII of the state sanitary code.

M. [formerly paragraph 9:039] All persons handling shucked shellfish, picked crabs, cooked, peeled shrimp, or other marine or fresh water animal food to be consumed without further cooking or processing, shall keep their hands scrupulously clean. A solution of at least 50 parts per million (ppm) of free chlorine should be provided in which such persons can frequently rinse their hands and forearms.

N. [formerly paragraph 9:040] When necessary in the interest of the public health, a duly authorized representative of the state health officer shall attach a tag to any equipment or utensil which is insanitary, or the use of which would be in violation of these regulations. Any equipment or utensil so tagged shall not be used again until made sanitary and approved by the state health officer. Tags so placed shall not be removed by anyone other than a duly authorized representative of the state health officer.

O. [formerly paragraph 9:041] A single individual shall be designated by the management to supervise the shucking and packing of shellfish, the packing of peeled and cooked shrimp and picked crabs. They shall be responsible for the cleanliness the shucking, picking, or packing rooms and shall see that the requirements with reference to washing of hands after interruption of working operations is carried out by all persons engaged in the establishment. They shall be responsible at the end of each day's operations for the thorough cleansing and sanitizing of all equipment such as pails, knives, breaking blocks, finger cots, aprons, and so forth.

AUTHORITY NOTE: Promulgated in accordance with R.S. 40:4.A.(1) and R.S. 40:5.3.

HISTORICAL NOTE: Promulgated by the Department of Health and Hospitals, Office of Public Health, LR 28:1303 (June 2002), amended by the Department of Health, Office of Public Health, LR 48:1853 (July 2022), repromulgated LR 48:2141 (August 2022).

**§319. Seafood (Except Shell-Stock)
Shipping Requirements
[formerly paragraph 9:042]**

A. The shipping of shucked shellfish, picked crabmeat, cooked, peeled shrimp or other marine or fresh water animal food products to be consumed without further cooking or processing, shall comply with the requirements listed in §319.B-D.

B. [formerly paragraph 9:043] Such products shall be maintained at a temperature of 45°F or below throughout transit.

C. [formerly paragraph 9:044] Such products shall be shipped in containers approved by the state health officer and marked with the packer's certificate number preceded by the letters "La." when packed in Louisiana, or by the abbreviation of the state in which packed. The date when such containers are filled shall be indicated on the container by the packer, either in code or by actual date. If the date is in code, a key to the code shall be supplied the state health officer of the state in which the shellfish are packed, and to the surgeon general of the U.S. Public Health Service. Shipping documents shall show the name and address of the consignee, the name and address of the shipper, the name of the state of origin, and the certificate number of the shipper.

D. [formerly paragraph 9:045] All establishments that sell or serve raw oysters must display signs, menu notices, table tents, or other clearly visible messages at the point of sale with either of the following wording:

1.a. "THERE MAY BE A RISK ASSOCIATED WITH CONSUMING RAW SHELLFISH AS IS THE CASE WITH OTHER RAW PROTEIN PRODUCTS. IF YOU SUFFER FROM CHRONIC ILLNESS OF THE LIVER, STOMACH OR BLOOD OR HAVE OTHER IMMUNE DISORDERS, YOU SHOULD EAT THESE PRODUCTS FULLY COOKED"; or

b. "CONSUMING RAW OR UNDERCOOKED MEATS, POULTRY, SEAFOOD, SHELLFISH OR EGGS MAY INCREASE YOUR RISK OF FOODBORNE ILLNESS, ESPECIALLY IF YOU HAVE CERTAIN MEDICAL CONDITIONS."

2. In addition, this message must appear on the principal display panel and top of containers of pre-packaged raw oysters. This may be done by printing on the container or by pressure sensitive labels.

E. [formerly paragraph 9:045-1] These changes will become effective August 20, 1993. For those individuals and/or establishments currently using the message previously approved by the state health officer, they may have additional time to use existing supplies not to exceed February 20, 1994.

F. [formerly paragraph 9:046] Use of containers bearing the certificate number of another packer shall not be permitted. If shellfish are repacked, records shall be maintained by the repacker which show the packing date, certificate number, and name and address of the original shucker and packer.

AUTHORITY NOTE: Promulgated in accordance with R.S. 40:4(A)(1), R.S. 40:5(2)(3)(5)(7)(15), and R.S. 40:5.3.

HISTORICAL NOTE: Promulgated by the Department of Health and Hospitals, Office of Public Health, LR 28:1307 (June 2002), amended by the Department of Health and Hospitals, Office of Public Health, Center for Environmental Health Services, LR 34:445 (March 2008).

§321. Shipping Shell-Stock Requirements [formerly paragraph 9:047]

A. Shellfish in the shell, except bulk shipments made as described in §321.A and B, shall be packed in clean barrels or sacks.

B. [formerly paragraph 9:048] Shipments of shell-stock in bulk, not sacked or barreled, shall not be made by truck or car except where the shipment is from only one consignor to only one consignee. Each shipment shall be accompanied by a shipping tag as specified in §323.A.

C. [formerly paragraph 9:049] Bulk shipments of shell-stock by boat may be made in cases where the tongers or dredgers obtain the shellfish directly from growing areas and sell them to various consumers direct without shucking. Where shell-stock is shipped by boat for the shell trade, it shall be labeled as specified in §319. If shellfish shipped by boat are intended for processing in shucking houses, records shall be kept by the boat operator in a book provided for such purposes only, showing the sources and quantity of shellfish, date and local waters where the shellfish were taken, license or certificate number of person or persons from to whom sold. These records shall be retained for 12 months.

D. [Formerly paragraph 9:050] Railroad cars and trucks in which shellfish are shipped in sacks shall be kept clean. All cars and trucks shall be subjected to proper inspection to see that they conform to this rule. Conveyances used to transport shellstock shall be constructed to prevent contamination, deterioration, or decomposition of the shellstock during transport. Conveyances must be pre-chilled to 45°F or below prior to loading. The dealer shall keep a record of compliance with the pre-chilling requirement.

E. If shellstock is received either "sacked or in boxes" from a certified dealer and is not processed or repacked in any form, the product when reshipped to another certified dealer, wholesaler, or retailer, must have a label attached to the package, bearing the name and certification number of the reshipper.

F. Bulk labeling of shellstock in sacks will be accepted for sales between certified dealers.

AUTHORITY NOTE: Promulgated in accordance with R.S. 40:4(A)(1), R.S. 40:5(2)(3)(5)(7)(15), and R.S. 40:5.3.

HISTORICAL NOTE: Promulgated by the Department of Health and Hospitals, Office of Public Health, LR 28:1307 (June 2002), amended by the Department of Health and Hospitals, Office of Public Health, Center for Environmental Health Services, LR 34:445 (March 2008), LR 34:2175 (October 2008), LR 35:1239 (July 2009), LR 38:2788 (November 2012).

§323. Tags [formerly paragraph 9:051]

A. In order that information may be available to inspectors and others with reference to the origin of shell-stock oysters, clams and mussels from all areas, all containers holding shell-stock shall be identified by a tag or label, form and substance of which shall be approved by the

state health officer, and the secretary of the Department of Wildlife and Fisheries.

B. [formerly paragraph 9:051-1] The initial tagging of the shell-stock shall be performed by the harvester before the shell-stock are removed from the harvester's boat. In the event that shell-stock are harvested from more than one growing area on a given day, the shell-stock shall be sacked and tagged before leaving from the growing area from which the shell-stock was harvested. The harvester's tags shall contain legible information as follows:

1. a place shall be provided where the dealer's name, address, certification number assigned by the Office of Public Health, Seafood Sanitation Program and the original shell-stock shipper's number if different;

2. the harvester's identification number assigned by the Department of Wildlife and Fisheries;

3. the date of harvesting;

4. harvest area as defined by Office of Public Health;

5. type and quantity of shellfish; and

6. the following additional statements or their equivalent as approved by the state authority shall appear on each tag in bold capitalized letters:

a. **THIS TAG IS REQUIRED TO BE ATTACHED UNTIL CONTAINER IS EMPTY OR RETAGGED AND THEREAFTER KEPT ON FILE, IN CHRONOLOGICAL ORDER, FOR 90 DAYS. "RETAILERS: DATE WHEN LAST SHELLFISH FROM THIS CONTAINER SOLD OR SERVED (INSERT DATE)";**

NOTE: Shellstock tagged for restricted use (Green Tag) should not include the retailer guidance language "RETAILERS: DATE WHEN LAST SHELLFISH FROM THIS CONTAINER SOLD OR SERVED (INSERT DATE)"

b. **AS IS THE CASE WITH CONSUMING OTHER RAW ANIMAL PROTEIN PRODUCTS, THERE IS A RISK ASSOCIATED WITH CONSUMING RAW OYSTERS, CLAMS AND MUSSELS. IF YOU SUFFER FROM CHRONIC ILLNESS OF THE LIVER, STOMACH, OR BLOOD OR HAVE IMMUNE DISORDERS, DO NOT EAT THESE PRODUCTS RAW. RETAILERS PLEASE ADVISE CUSTOMERS.**

C. The color of a tag placed on a container holding shellstock shall have the following meanings.

1. A white-colored tag indicates that the shellstock has met the time/temperature requirements of §329.A for raw (half shell) consumption in both interstate and intrastate commerce.

2. A fuchsia-colored (pinkish-purple) tag indicates that the shellstock has met the time/temperature requirements of §330.A for raw (half shell) consumption in intrastate commerce only (i.e., may be sold for raw consumption only by persons within the state of Louisiana).

3. A green-colored tag indicates that the shellstock is for shucking by a certified dealer or post-harvest processing only.

4. A blue-colored tag indicates that the shell stock has been post-harvest processed by a certified dealer and may

now be sold for raw (half shell) consumption in both interstate and intrastate commerce. This tag must also include a "SELL BY" date which is a reasonable subsequent shelf-life or the words "BEST IF USED BY" followed by a date when the product would be expected to reach the end of its shelf-life. The date shall include month, day, and year.

AUTHORITY NOTE: Promulgated in accordance with R.S. 40:4(A)(1), R.S. 40:5(2)(3)(5)(7)(15), and R.S. 40:5.3.

HISTORICAL NOTE: Promulgated by the Department of Health and Hospitals, Office of Public Health, LR 28:1308 (June 2002), amended LR 28:1591 (July 2002), LR 33:850 (May 2007), LR 40:1009 (May 2014), amended by the Department of Health, Office of Public Health, LR 48:1853 (July 2022), repromulgated LR 48:2142 (August 2022).

§325. Penalties Relative to Shellstock Container Tagging [formerly paragraph 9:051-2]

A. Shellstock containers which are not tagged or labeled in accordance with the tagging or labeling requirements of this Part shall subject the contents thereof to seizure and destruction.

AUTHORITY NOTE: Promulgated in accordance with R.S. 40:4.A(1), R.S. 40:5(2), (3), (5), (7), (15), (17), (19), (20), (21), and R.S. 56:437.

HISTORICAL NOTE: Promulgated by the Department of Health and Hospitals, Office of Public Health, LR 28:1308 (June 2002), amended LR 38:96 (January 2012).

§327. Refrigeration of Shellstock Oysters, Clams and Mussels [formerly paragraph 9:052]

A. Shellstock shall be placed under mechanical refrigeration at an air temperature (measured 12 inches from the blower) not to exceed 45°F within the time period prescribed herein; and shall be maintained at or below that temperature through out all levels of commerce. Shellstock harvested for raw consumption during the months January through December shall be subject to the time to refrigeration requirements outlined in Subsection A of §329 of this Part.

EXCEPTION: Shellstock harvested in the months of May through October for raw consumption only by persons within the state of Louisiana shall be allowed, in accordance with all of the requirements of §330 of this Part [including, but not limited to, use of a fuchsia (pinkish-purple) color tag or label on the container], to be placed under mechanical refrigeration at an air temperature not to exceed 45°F within 5.0 hours from the time harvesting begins. Any such shellstock meeting this exception shall not be sold for use outside of the state of Louisiana.

B. All shellstock harvested for raw consumption shall be placed under temperature control in accordance with the requirements specified under Subsection A of §329 of this Part. Any shellstock harvested which exceeds the time-temperature matrix requirements of Subsection A of §329 of this Part shall not be provided to or served to anyone for the purpose of raw consumption, but shall only be provided to a certified dealer for the express purposes of shucking or post-harvest processing only.

EXCEPTION: Shellstock harvested in the months of May through October for raw consumption only by persons within the state of Louisiana shall be allowed, in accordance with all of the requirements of §330 of this Part [including, but not limited to, use of a fuchsia (pinkish-purple) color tag or label on the container], to be placed under mechanical refrigeration at an air temperature not to exceed 45°F within 5.0 hours from the time harvesting begins. Any such shellstock meeting this exception shall not be sold for use outside of the state of Louisiana.

C. Once shellstock is off-loaded from the harvest vessel onto the dock it must be placed under mechanical refrigeration within 2.0 hours; but the total harvest to refrigeration time shall not exceed the time-temperature matrix specified under Subsection A of §329 of this Part.

EXCEPTION: Shellstock harvested in the months of May through October for raw consumption only by persons within the state of Louisiana shall be allowed, in accordance with all of the requirements of §330 of this Part [including, but not limited to, use of a fuchsia (pinkish-purple) color tag or label on the container], to be placed under mechanical refrigeration at an air temperature not to exceed 45°F within 5.0 hours from the time harvesting begins. Any such shellstock meeting this exception shall not be sold for use outside of the state of Louisiana.

D. Once shellstock is off-loaded from a harvest vessel to an oyster cargo vessel, oysters must be placed under mechanical refrigeration at a time not to exceed the original harvester's time-temperature matrix specified under Subsection A of §329 of this Part.

EXCEPTION: Shellstock harvested in the months of May through October for raw consumption only by persons within the state of Louisiana shall be allowed, in accordance with all of the requirements of §330 of this Part [including, but not limited to, use of a fuchsia (pinkish-purple) color tag or label on the container], to be placed under mechanical refrigeration at an air temperature not to exceed 45°F within 5.0 hours from the time harvesting begins. Any such shellstock meeting this exception shall not be sold for use outside of the state of Louisiana.

E. To comply with the time to temperature requirements for harvested shellstock for raw consumption, the type of cooling must be capable of achieving the required internal temperature within the time frames required in the *Vibrio vulnificus* control plan developed by the Office of Public Health Molluscan Shellfish Program (see §329.A). The use of tempering and inadequate cooling is not acceptable. Cooling that occurs prior to receipt by the original dealer does not alleviate the dealer requirement to document the time to internal temperature requirements.

F. To comply with the time to temperature requirements for harvested shellstock for shucking or post-harvest processing consumption, the type of cooling must be capable of achieving the required internal temperature within the time frames required in the *Vibrio vulnificus* control plan developed by the Office of Public Health Molluscan Shellfish Program (see §331.A) or in the matrix for all other shellstock. The use of tempering and inadequate cooling is not acceptable. Cooling that occurs prior to receipt by the original dealer does not alleviate the dealer requirement to document the time to internal temperature requirements.

AUTHORITY NOTE: Promulgated in accordance with R.S. 40:4(A)(1), R.S. 40:5(2)(3)(5)(7)(15), and R.S. 40:5.3.

HISTORICAL NOTE: Promulgated by the Department of Health and Hospitals, Office of Public Health, LR 28:1308 (June 2002), amended LR 31:2896 (November 2005), LR 34:2175 (October 2008), LR 36:1016 (May 2010), LR 38:96 (January 2012), LR 38:2789 (November 2012).

§329. Refrigeration Requirements for Shellstock Harvested for Raw Consumption during the Months of January through December [formerly paragraph 9:052-1]

A. Time to refrigeration requirements for shell-stock harvested for raw consumption during the months January through December shall be based on the Average Monthly Maximum Water Temperatures based on the *Vibrio vulnificus* control plan developed by the Office of Public Health Molluscan Shellfish Program according to the following schedule.

1. Water Temperature—<65°F—Shell-stock shall be placed under mechanical refrigeration at an air temperature not to exceed 45°F within 36 hours from the time harvesting begins. Internal oyster meat temperature of 55°F must be achieved in 10 hours from when oysters are placed in mechanical refrigeration.

2. Water temperature: 65°F to 74°F—Shell-stock shall be placed under mechanical refrigeration at an air temperature not to exceed 45°F within 8 hours from the time harvesting begins. Internal oyster meat temperature of 55°F must be achieved in 10 hours from when oysters are placed in mechanical refrigeration.

3. Water temperature: >74°F—Shell-stock shall be placed under mechanical refrigeration at an air temperature not to exceed 45°F within 1 hour from the time harvesting begins. Internal oyster meat temperature of 55°F must be achieved within 6 hours from when oysters are placed in mechanical refrigeration.

B. For shellstock harvested for raw consumption, harvesters will adhere to the applicable time and temperature controls as established by the *Vibrio vulnificus* control plan in this Section developed by the Office of Public Health Molluscan Shellfish Program. The harvester must provide harvest records to the original shellfish dealer demonstrating compliance with the applicable time and temperature requirements. This record may be in the form of a harvester tag, trip record, or other record deemed appropriate by the Office of Public Health Molluscan Shellfish Program. The record must include the date and time harvest begins for each lot of shellfish harvested. The harvester shall document the time harvest begins for each lot prior to harvest and shall immediately document the time each lot is placed under refrigeration. The harvester shall properly attach a shellstock tag on all containers holding shellstock, with the corresponding lot identification, number or character printed legibly on the shellstock tag, prior to being placed under refrigeration. This tag shall be approved by the state health officer and the secretary of the Louisiana Department of Wildlife and Fisheries. It shall also be the responsibility of the harvester to record the number of sacks contained within

each lot immediately after oysters are placed under refrigeration. Harvest vessels equipped with refrigeration capabilities must provide documentation to the original dealer that the time and temperature requirements established by the *Vibrio vulnificus* control plan developed by the Office of Public Health Molluscan Shellfish Program (see §329.A) have been met.

C. Under the requirements of the *Vibrio vulnificus* control plan during the months of March through November, if oysters are removed from a vessel before the product reaches an internal temperature of 55°F or below, it is the dealer's responsibility to verify that all last lots of oysters harvested and placed in mechanical refrigeration meet the internal temperature of 55°F or below in six hours. This shall be documented on the same log sheet that was provided to the dealer from the harvester.

AUTHORITY NOTE: Promulgated in accordance with R.S. 40:4(A)(1), R.S. 40:5(2)(3)(5)(7)(15), and R.S. 40:5.3.

HISTORICAL NOTE: Promulgated by the Department of Health and Hospitals, Office of Public Health, LR 28:1308 (June 2002), amended LR 31:2896 (November 2005), LR 34:2175 (October 2008), LR 36:1016 (May 2010), LR 38:2789 (November 2012), LR 40:1009 (May 2014), amended by the Department of Health, Office of Public Health, LR 48:1853 (July 2022), repromulgated LR 48:2142 (August 2022).

§330. Refrigeration Requirements for Shellstock Harvested during the months of May through October for Raw Consumption only by Persons Located Within the State of Louisiana

A. Any shellstock harvested in the months of May through October for raw consumption only by persons within the state of Louisiana shall be placed under mechanical refrigeration at an air temperature not to exceed 45°F within 5.0 hours from the time harvesting begins and such shellstock shall not be sold for use outside of the state of Louisiana.

B. The Department of Health and the Department of Wildlife and Fisheries have cooperatively developed a single tag which purpose is to immediately and specifically indicate by its fuchsia (pinkish-purple) color that the oysters contained in the sack or box have been harvested following the requirements of this Section. Language shall be printed on the tag which shall explicitly state "oysters contained herein must not be sold for use outside of the state of Louisiana" and the oysters contained in the sack or box (excluding post-harvest process product) shall not be sold for use outside of the state of Louisiana. This tag shall be in addition to any tag(s) required under §323 of this Part.

C. Oysters being processed (shucked or frozen) under this Section must identify on the packing container that this product cannot be sold for use outside of the state of Louisiana.

D. When harvesting for oysters which will be harvested and tagged under the requirements of this Section (i.e., oysters to be sold for raw consumption only by persons located within the state of Louisiana), each harvester shall contact and notify the Department of Wildlife and Fisheries

prior to leaving port. The Department of Wildlife and Fisheries shall be notified by calling 1-800-442-2511.

E. Records relating to oysters which will only be sold for raw consumption within the state of Louisiana shall be completed by both the harvester and dealer(s) and shall be kept separate from records for shellstock product intended for interstate shipment. These records shall be maintained for a period of one year (two years if frozen) and be made readily available for examination by agents of the Department of Health and the Department of Wildlife and Fisheries. Approved log sheets properly completed and maintained, for the current and previous 15 days harvest shall be kept aboard the harvest vessel for immediate examination. A copy of the log sheet form required to be kept and maintained is shown below in §345 of this Part.

F. All oysters on board any vessel actively being utilized for the purpose of intrastate shipments under the conditions of this Section shall be restricted to the use of intrastate [fuchsia (pinkish purple) color] tags for all oysters contained on that vessel from the time harvesting begins until all oysters are offloaded dockside.

G. In addition to all other required notifications/entries by harvesters prior to the taking of oysters under this Section, the harvester shall legibly document on the required harvester-dealer time temperature log sheet "For Intrastate Shipments Only."

AUTHORITY NOTE: Promulgated in accordance with R.S. 40:4(A)(1), R.S. 40:5(2), (3), (5), (7), (15), (17), (19), (20), (21), and R.S. 56:437.

HISTORICAL NOTE: Promulgated by the Department of Health and Hospitals, Office of Public Health, LR 38:96 (January 2012), amended by the Department of Health, Office of Public Health, LR 48:1853 (July 2022), repromulgated LR 48:2142 (August 2022).

§331. Refrigeration Requirements for Shellstock Harvested for Shucking or Post-Harvest Processing by a Certified Dealer during the Months of January through December [formerly paragraph 9:052-2]

A. Time to refrigeration requirements for shell-stock harvested for shucking or post-harvest processing by a certified dealer during the months January through December shall be based on the Average Monthly Maximum Air Temperature developed by the Office of Public Health Molluscan Shellfish Program according to the following schedule.

1. Air Temperature: <50 degrees F. Shellstock shall be placed under mechanical refrigeration at an air temperature not to exceed 45 degrees F within 36 hours from the time harvesting begins.

2. Air Temperature: 50 degrees F to 60 degrees F. Shellstock shall be placed under mechanical refrigeration at an air temperature not to exceed 45 degrees F within 24 hours from the time harvesting begins.

3. Air Temperature: >60 degrees F - 80 degrees F. Shellstock shall be placed under mechanical refrigeration at

an air temperature not to exceed 45 degrees F within 18 hours from the time harvesting begins.

4. Air Temperature: >80 degrees F. Shellstock shall be placed under mechanical refrigeration at an air temperature not to exceed 45 degrees F within 12 hours from the time harvesting begins.

B. Dealer/harvester tags utilized to identify shell-stock harvested for shucking or post-harvest processing consumption by a certified dealer must be identified with the green tag which states: "FOR SHUCKING BY A CERTIFIED DEALER OR POST-HARVEST PROCESSING ONLY".

C. For shellstock harvested for shucking or post-harvest processing consumption, harvesters will adhere to the applicable time and temperature controls as established in this Section by the Office of Public Health Molluscan Shellfish Program. The harvester must provide harvest records to the original shellfish dealer demonstrating compliance with the applicable time and temperature requirements. This record may be in the form of a harvester tag, trip record, or other record deemed appropriate by the Office of Public Health Molluscan Shellfish Program. The record must include the date and time harvest begins for each lot of shellfish harvested. Harvest vessels equipped with refrigeration capabilities must provide documentation to the original dealer that the time and temperature requirements established by the Office of Public Health Molluscan Shellfish Program have been met.

D. "Green" or restricted use tag product may be shipped in commerce if the internal temperature is 50°F or below. If the oysters have not reached an internal temperature of 50°F or below, the product may be shipped provided a working time/temperature recording device accompanies every shipment. Shipments of 4 hours or less will not be required to have a working time/temperature recording device. The documentation stating the time of shipment will accompany the bill of lading and will be used to determine if shipment is less than four hours.

E. All shellstock that has been refrigerated must not be allowed to remain without mechanical refrigeration for more than two hours at points of processing or transfer such as loading docks.

AUTHORITY NOTE: Promulgated in accordance with R.S. 40:4.A.(1), R.S. 40:5.A.(2)(3)(5)(7)(9)(15)(17)(19)(20), and R.S. 40:5.3.

HISTORICAL NOTE: Promulgated by the Department of Health and Hospitals, Office of Public Health, LR 28:1309 (June 2002), amended LR 31:2896 (November 2005), LR 34:2175 (October 2008), LR 35:1239 (July 2009), LR 36:1017 (May 2010), LR 38:97 (January 2012), LR 38:2789 (November 2012), amended by the Department of Health, Office of Public Health, LR 48:1854 (July 2022), repromulgated LR 48:2142 (August 2022).

§333. General Provisions **[formerly paragraph 9:052-3]**

A. Shell-stock harvested for delivery to a steam factory for canning and thermal processing shall be landed at the factory within 72 hours from the time harvesting begins. The

time harvesting begins and the time of arrival at the factory shall be recorded on the harvester's invoice.

B. If a harvester elects to fish shellstock intended for raw (half shell) consumption during the months of March-November, it shall be unlawful to possess shellstock intended for shucking, post-harvest processing, relaying or bedding until all shellstock harvested for raw (half shell) consumption are off-loaded dockside. However a harvester may fish shellstock for shucking and post-harvest processing at the same time when fishing shellstock for raw (half shell) consumption provided that the refrigeration and time/temperature requirements for raw (half shell) consumption are followed for the entire harvest (i.e., all harvested shellstock on board shall meet the time/temperature requirements of §329.A of this Part).

C. Except for deliveries made to a shellfish dealer certified by the Office of Public Health for inclusion on the U.S. Food and Drug Administration's Interstate Certified Shellfish Shippers List and located less than 30 minutes from dockside, all land-based deliveries of shell stock shall be made aboard mechanically refrigerated trucks with an internal air temperature of 45 degrees Fahrenheit or less as measured 12 inches from the blower. For shipments by air, an internal meat temperature of 45 degrees Fahrenheit or less shall be maintained at all times. To accomplish this it shall be necessary to pre-chill shellstock to an internal temperature of 40 degrees Fahrenheit or less prior to being packed into insulated containers with frozen gel packs. Land-based deliveries of molluscan shell stock to a steam factory for thermal processing and canning shall be exempt from these refrigeration requirements during the months November through May provided that the shellfish are delivered to the cannery in accordance with the requirements cited in Paragraph A of this Section and the Department of Wildlife and Fisheries, Enforcement Division is notified via their toll free telephone number [(800) 442-2511] prior to making each delivery.

D. When shell-stock are temporarily off-loaded for any reason, storage must be on pallets or on a well graded paved surface, with direct exposure to the sun limited to no more than 30 minutes.

E.1. A Harvester-Dealer Time/Temperature Log Sheet (see §345) shall be completed by both the harvester and first certified dealer to document compliance with time to refrigeration requirements during the months January through December. Log sheets shall be maintained for a period of one year and made readily available for inspection by agents of the Department of Health and Hospitals, Department of Wildlife and Fisheries and the U.S. Food and Drug Administration. Log sheets for the current and previous 15 days harvest shall be kept aboard the harvest vessel for immediate examination. The requirement for a Harvester-Dealer Time/Temperature Log Sheet will not apply to the West Cove Conditional Management Area or the Lower Calcasieu Lake Conditional Management Area which are located in Cameron Parish. Log Sheet Instructions: A Harvester-Dealer Time/Temperature Log Sheet (see §345

formerly Table 1). Prior to the taking of oysters the harvester shall make the following legible entries:

- a. boat name/number;
- b. harvester name/license number;
- c. harvester signature and date;
- d. harvesting area/lease number (Note: if there is a change relating to harvesting area/lease number, the changes must be documented on log sheet.);
- e. time harvesting begins;
- f. harvester shall declare whether oysters will be bedded, shucked, relayed or other (explain).

2. Upon completion of the taking of oysters and prior to the leaving of the harvesting site, the harvester shall record the time harvesting ended and the total number of sacks harvested.

3. If the harvester declares sacks of oysters for both shucking and half-shell, those oysters shall be distinguished by placing the appropriate tag on the sack prior to leaving the harvesting area.

4. The certified dealer information shall be completed as follows.

- a. The certified dealer/agent shall legibly document in the appropriate place on the harvester dealer time/temperature log sheet the temperature of the cooler where oysters are being stored at the time unloading of the harvesting vessel begins.

- b. The certified dealer/agent shall legibly document in the appropriate place the time when the last sack or container of oysters taken from the harvest vessel is placed in the cooler. This entry must be made immediately upon removal of the last sack or container of shellfish from the vessel.

- c. The certified dealer/agent shall legibly document in the appropriate place the temperature of the cooler immediately upon removal of the last sack or container of oysters from the harvesting vessel and placement of same under refrigeration.

- d. The certified dealer/agent shall immediately sign and date the log sheet in the appropriate place.

5. Alternate designs for the Harvester-Dealer Time/Temperature Log Sheet depicted in §345 may be submitted for consideration and approval to the Office of Public Health.

F. Post-Harvest Processing

1. If a dealer elects to use a process to reduce the levels(s) of one target pathogen or some target pathogens, or all pathogens of public health concern in shellfish, the dealer shall:

- a. have a Hazard Analysis Critical Control Point (HACCP) plan approved by the authority for the process that ensures that the target pathogen(s) are at safe levels for the

at-risk population in product that has been subjected to the process:

- i. for processes that target *Vibrio vulnificus*, the level of *Vibrio vulnificus* in product that has been subjected to the process shall be non-detectable (<30 per gram) to be determined by use of the *Vibrio vulnificus* FDA approved EIA procedure of Tamplin, et al, as described in Chapter 9 of the FDA Bacteriological Analytical Manual, 7th Edition, 1992;

- ii. for processes that target *Vibrio parahaemolyticus*, the level of *Vibrio parahaemolyticus* in product that has been subjected to the process shall be non-detectable (<30 per gram)

- iii. for processes that target other pathogens, the level of those pathogens in product that has been subjected to the process shall be below the appropriate FDA action level, or, in the absence of such a level, below the appropriate level as determined by the ISSC;

- iv. the ability of the process to reliably achieve the appropriate reduction in the target pathogen(s) shall be validated by a study approved by the authority, with the concurrence of FDA;

- v. the HACCP plan shall include:

- (a) process controls to ensure that the end point criteria are met for every lot; and

- (b) a sampling program to periodically verify that the end point criteria are met;

- b. package and label all shellfish in accordance with all requirements of the Model Ordinance. This includes labeling all shellfish which have been subjected to the process but which are not frozen in accordance with applicable shellfish tagging and labeling requirements in Chapter X.05 and X.06 and X.07 of the National Shellfish Sanitation Program Model Ordinance;

- c. keep records in accordance with Chapter X.08 of the National Shellfish Sanitation Program Model Ordinance.

2. A dealer who meets the requirements of this Section may label product that has been subjected to the reduction process as:

- a. "processed for added safety," if the process reduces the levels of all pathogens of public health concern to safe levels for the at-risk population;

- b. "processed to reduce [name of target pathogen(s)] to non-detectable levels," if the process reduces one or more, but not all, pathogens of public health concern to safe levels for the at-risk population, and if that level is non-detectable; or

- c. "processed to reduce [name of target pathogen(s)] to non-detectable levels for added safety," if the process reduces one or more, but not all, pathogens of public health concern to safe levels for the at-risk population, and if that level is non-detectable; or

d. a term that describes the type of process applied (e.g., "pasteurized," "individually quick frozen," "pressure treated") may be substituted for the word "processed" in the options contained in §333.F.2.c.

3. For the purpose of product temperature the receiving and storage critical control points of shucked product apply to shell stock prior to PHP processing. Following PHP processing, if the end product is dead, the product shall be treated as shucked product. If the end product is live, the product shall be treated as shellstock.

4. A harvester-dealer oyster tag, blue in color, shall be used for In-Shell Product that has undergone a Post-Harvest Treatment Process

5. Certification number of the post-harvest treatment facility is required on all post-harvest treated tags.

G. Recalls

1. Certified dealers shall adopt written procedures for conducting recalls of adulterated or misbranded shellfish products. These written procedures for conducting recalls shall be based on, and complementary to, the FDA Enforcement Policy on Recalls published in the April 1, 2003 Code of Federal Regulations, Title 21, Chapter 1, Subchapter A, Part 7-Enforcement Policy which is also contained in the 2019 NSSP Guide for the Control of Molluscan Shellfish under Section VII (Federal Regulations) thereof.

2. Certified dealers shall follow their written recall procedures to include timely notification of the Office of Public Health of a situation requiring recall, timely notification of consignee who received the affected product, and effective removal or correction of the affected product.

H. A Hazard Analysis Critical Control Point (HACCP) plan for oyster harvesters shall be required for all oyster harvesters dredging for product intended for the half-shell market.

1. The oyster harvester must demonstrate through record keeping that oysters harvested have met the refrigeration time and temperature requirements of §329.

AUTHORITY NOTE: Promulgated in accordance with R.S. 40:4(A)(1), R.S. 40:5(2)(3)(5)(7)(15)(17)(19)(20)(21), and R.S. 40:5.3.

HISTORICAL NOTE: Promulgated by the Department of Health and Hospitals, Office of Public Health, LR 28:1309 (June 2002), amended LR 28:1592 (July 2002), repromulgated LR 29:173 (February 2003), amended LR 34:2176 (October 2008), LR 38:97 (January 2012), LR 40:1009 (May 2014), amended LR 48:1854 (July 2022), repromulgated LR 48:2143 (August 2022).

§335. Penalties Relative to Shell-Stock Refrigeration [formerly paragraph 9:052-4]

A. Shell-stock not produced in accordance with the requirements outlined in §§327-333 shall be deemed adulterated and shall be subject to seizure and destruction.

AUTHORITY NOTE: Promulgated in accordance with R.S. 40:4.A.(1) and R.S. 40:5.3.

HISTORICAL NOTE: Promulgated by the Department of Health and Hospitals, Office of Public Health, LR 28:1310 (June 2002).

§337. Checking on Condition of Molluscan Shellfish in Growing Waters Closed by the State Health Officer [formerly paragraph 9:053]

A. No person shall engage in the business of checking on the condition of molluscan shellfish in growing waters closed by the state health officer prior to obtaining a permit for that purpose from the state health officer. Applications shall be and filed not less than 14 days prior to the beginning of such proposed checking activities. Permits will be applicable for one day only.

AUTHORITY NOTE: Promulgated in accordance with R.S. 40:4.A.(1) and R.S. 40:5.3.

HISTORICAL NOTE: Promulgated by the Department of Health and Hospitals, Office of Public Health, LR 28:1310 (June 2002), amended by the Department of Health, Office of Public Health, LR 48:1855 (July 2022), repromulgated LR 48:2143 (August 2022).

§341. Permits [formerly paragraph 9:053-2]

A. Permits shall be granted at the discretion of the Department of Health and Hospitals with the following restrictions.

1. No permittee, boat captain or crew member may serve on any vessels subject to this permit who has been cited or found guilty of violations relative to the harvesting of shellfish from closed areas within three years of the application date; provided, however that said permittee, crew member or boat captain may receive a waiver of this condition with regard to those citations which did not result in a conviction upon the appropriate showing being made to the Department of Wildlife and Fisheries.

2. Sacking of shellfish and storage of empty shellfish sacks on board permitted or authorized vessel utilized in the checking of shellfish shall be strictly prohibited. No more than one bushel of shellfish may be on board an authorized vessel at any given time.

3. Culling of shellfish shall be strictly prohibited.

4. Only five leases in the closed growing waters shall be utilized in the checking of shellfish.

5. The permittee shall be responsible for notifying the Department of Wildlife and Fisheries prior to leaving port to check shellfish under permitted conditions and immediately upon returning from permitted trip. The department shall be notified by calling (800) 442-2511.

6. All activities relative to the checking of shellfish in closed growing waters shall be permitted only during daylight hours with all activities completed no later than 30 minutes after official sunset.

7. Only one vessel may be utilized and both side of the permitted vessel shall be marked with the permit number in at least 6-inch high letters on a contrasting background so

as to be visible from a low flying aircraft or from any vessel in the immediate vicinity.

8. A copy of the shellfish checking permit and applicable rules shall be on board the authorized vessel at all times on the active day of permit.

AUTHORITY NOTE: Promulgated in accordance with R.S. 40:4.A.(1) and R.S. 40:5.3.

HISTORICAL NOTE: Promulgated by the Department of Health and Hospitals, Office of Public Health, LR 28:1310 (June 2002).

§343. Permit Enforcement [formerly paragraph 9:053-3]

A. Failure to comply with any of the permitting requirements specified in §§327-333 shall result in the following administrative actions.

1. The shellfish checking permit and all applicable privileges shall be immediately suspended by the Department of Wildlife and Fisheries or the Department of Health.

2. If said charges are upheld in an administrative hearing, shellfish checking and shellfish relay permitting privileges shall be denied for a period of three years.

AUTHORITY NOTE: Promulgated in accordance with R.S. 40:4.A.(1), R.S. 40:5.A.(2)(3)(5)(7)(9)(15)(17)(19)(20) and R.S. 40:5.3.

HISTORICAL NOTE: Promulgated by the Department of Health and Hospitals, Office of Public Health, LR 28:1310 (June 2002, LR 48:1855 (July 2022), repromulgated LR 48:2143 (August 2022).

§345. Harvester-Dealer Time/Temperature Log Sheet [formerly Table I]

HARVESTER-DEALER TIME/TEMPERATURE LOG SHEET

Harvester Information:

BOAT NAME/NUMBER: _____

HARVESTER NAME/ LICENSE NUMBER: _____

HARVESTER SIGNATURE: _____ DATE: _____

Molluscan Shellfish Harvested for Other Than Raw (Half Shell) Consumption:

HARVESTING AREA/LEASE NO.: _____

PRODUCT INTENDED FOR OTHER THAN RAW CONSUMPTION:
CIRCLE ONE:

BEDDING SHUCKING RELAYING OTHER

(EXPLAIN) _____

TIME HARVESTING BEGINS: _____

TIME HARVESTING ENDS: _____

NUMBER OF SACKS OF OYSTERS HARVESTED: _____

Molluscan Shellfish Harvested for Raw (Half Shell) Consumption:

HARVESTING AREA/LEASE NO.: _____

TIME HARVESTING BEGINS: _____

NUMBER OF SACKS OF OYSTERS HARVESTED: _____

Certified Dealer Information:

TEMPERATURE OF COOLER WHEN UNLOADING OYSTERS BEGINS _____

TIME WHEN LAST OYSTER FROM BOAT ARE PLACED IN COOLER: _____

TEMPERATURE OF COOLER WHEN LAST OYSTERS FROM THE BOAT ARE PLACED IN COOLER: _____

ORIGINAL CERTIFIED DEALER SIGNATURE _____ (OR AUTHORIZED REPRESENTATIVE)

DATE _____

AUTHORITY NOTE: Promulgated in accordance with R. S. 40:4.A.(1) and R.S. 40:5.3.

HISTORICAL NOTE: Promulgated by the Department of Health and Hospitals, Office of Public Health, LR 28:1311 (June 2002).

§347. FDA Laboratory Evaluation Forms [formerly Appendix A]

A. Current FDA Laboratory Evaluation Forms used in on-site inspection in evaluation procedures toward designation as an official laboratory of the Louisiana shellfish sanitation laboratory system.

AUTHORITY NOTE: Promulgated in accordance with R.S. 40:4.A.(1) and R.S. 40:5.3.

HISTORICAL NOTE: Promulgated by the Department of Health and Hospitals, Office of Public Health, LR 28:1311 (June 2002).

Chapter 5. Molluscan Shellfish Aquaculture

§501. General

A. Aquaculture activities which may pose a significant public health concern are regulated in this chapter and include, but not limited to:

1. seed production in waters classified as prohibited or unclassified;
2. aquaculture structures that attract birds or mammals; and
3. land based aquaculture.

B. Requirements:

1. approved written operational plan;
2. an annual inspection by representative of the department, including operator records, to verify that appropriate permits are up to date and operational plans are implemented;
3. when aquaculture attracts birds or mammals, their presence should be considered for possible adverse effects on growing area water quality.

C. The maximum seed size for *Cassostrea virginica* (eastern oyster) that can be produced in prohibited waters is 1 inch. If seed size produced in prohibited waters exceeds 1 inch, the seed shall be deemed adulterated and shall be subject to seizure and destruction.

D. Any person who performs aquaculture as defined in §101 of this Part or operates an aquaculture facility to raise shellfish for human consumption shall obtain:

1. a permit from the department for the activity and functioning of their facility;
2. a harvester's license; and
3. certification as a dealer, where necessary.

E. Shellfish aquaculture as defined in §101 of this Part shall be practiced only in strict compliance with the provisions of the permit issued by the department for the shellfish aquaculture activity. Authorization shall be based on the operator's written operational plan.

F. Prior to beginning their activity, a harvester shall obtain permission of the department for use of their facility.

G. Any shellfish seed raised in aquaculture shall be subjected to relaying prior to direct marketing if the culture are or facility is located in or using water which is in:

1. the closed status of the conditionally approved classification;
2. the restricted classification; or
3. the open status of the conditionally restricted classification.

H. Only drugs sanctioned by the FDA shall be used for shellfish treatment.

I. Harvesting, processing, storage, and shipping requirements for shellfish raised in a land-based aquaculture facility shall be the same as the requirements for wild molluscan shellfish specified in this Part of Title 51.

J. Complete and accurate records shall be maintained for at least two years by the operator of the aquaculture facility and shall include the:

1. source of shellfish, including seed if the seed is from growing areas which are not in the approved classification; and
2. water source, its treatment method, if necessary, and its quality in land-based systems.

AUTHORITY NOTE: Promulgated in accordance with R.S.40:4.A.(1), R.S. 40:5.A.(2)(3)(5)(7)(9)(15)(17)(19)(20) and R.S. 40:5.3.

HISTORICAL NOTE: Promulgated by the Department of Health, Office of Public Health, LR 48:1855 (July 2022), repromulgated, LR 48:2143 (August 2022).

§503. Exceptions

A. Hatcheries and nurseries rearing larvae and/or seed that are located in:

1. approved or conditionally approved growing areas are exempt from the requirements of this part; or
2. restricted, or conditionally restricted, growing areas would be exempt from the requirements of this part but subject to relay requirements for seed that exceeds the maximum seed size established by the department.

AUTHORITY NOTE: Promulgated in accordance with R.S.40:4.A.(1), R.S. 40:5.A.(2)(3)(5)(7)(9)(15)(17)(19)(20) and R.S. 40:5.3.

HISTORICAL NOTE: Promulgated by the Department of Health, Office of Public Health, LR 48:1855 (July 2022), repromulgated LR 48:2144 (August 2022).

§505. Seed Production in Water Classified as Prohibited or Unclassified

A. Seed may come from any growing area, or from any growing area which is not in an approved classification, provided that:

1. the source of the seed is approved by the department;
2. each aquaculture site that cultures seed in waters classified as prohibited or unclassified shall have a written operational plan. The plan shall be approved by the department prior to its implementation and shall include the following:
 - a. a description of the design and activities of the culture facility;
 - b. the specific site and boundaries in which shellfish aquaculture activities will be conducted;
 - c. the types and locations of any structures, including rafts, pens, cages, nets, or floats which will be placed in the waters;
 - d. the species of shellfish to be cultured and harvested;
 - e. the procedures to assure that no poisonous or deleterious substances are introduced from the seed production activities;
 - f. the corrective actions for addressing seed exceeding the maximum seed size as defined by the department.

AUTHORITY NOTE: Promulgated in accordance with R.S.40:4.A.(1), R.S. 40:5.A.(2)(3)(5)(7)(9)(15)(17)(19)(20) and R.S. 40:5.3.

HISTORICAL NOTE: Promulgated by the Department of Health, Office of Public Health, LR 48:1856 (July 2022), repromulgated LR 48:2144 (August 2022).

§507. Aquaculture That Attracts Birds or Mammals

A. Operational Plan. Each aquaculture site that the department determines may attract sufficient birds and/or mammals that their waste presents a human health risk shall have a written operational plan. The operational plan shall be approved by the department prior to its implementation and shall include:

1. a description of the design and activities of the aquaculture facility;
2. the specific site and boundaries in which shellfish aquaculture activities will be conducted;
3. the types and locations of any structures, including rafts, pens, cages, nets, or floats which will be placed in the waters;

4. the genus and species of shellfish to be cultured and harvested;
5. procedures to assure that no poisonous or deleterious substances are introduced from the aquaculture activities;
6. a description of the mitigation or deterrent measures to minimize the potential pollution impact of birds and/or mammals; and
7. maintenance of the required records.

AUTHORITY NOTE: Promulgated in accordance with R.S.40:4.A.(1), R.S. 40:5.A.(2)(3)(5)(7)(9)(15)(17)(19)(20) and R.S. 40:5.3.

HISTORICAL NOTE: Promulgated by the Department of Health, Office of Public Health, LR 48:1856 (July 2022), repromulgated LR 48:2144 (August 2022).

§509. Land Based Aquaculture

A. Operational Plan. Each land-based aquaculture facility shall have a written operational plan. The facility must obtain approval from the department prior to its implementation and shall include:

1. a description of the design and activities of the aquaculture facility;
2. the specific site and boundaries in which shellfish aquaculture activities will be conducted;
3. the types and locations of any structures, including rafts, pens, cages, nets, tanks, ponds, or floats which will be placed in the waters;
4. the genus and species of shellfish to be cultured and harvested;
5. procedures to assure that no poisonous or deleterious substances are introduced into the activities;

6. a program of sanitation, maintenance, and supervision to prevent contamination of the shellfish products;

7. a description of the water source, including the details of any water treatment process or method;

8. a program to maintain water quality, which includes collection of microbial water samples and their method of analysis and routine temperature and salinity monitoring (the bacterial indicator monitored shall be the same as used for monitoring natural growing areas);

9. if applicable, collection of data concerning the quality of food production (algae or other) used in the artificial harvest system; and

10. maintenance of the required records.

B. Each land-based facility conducting aquaculture as defined by Section 101 of this Part shall maintain the following records while the aquaculture activity continues:

1. construction and remodeling plans for any permitted aquaculture facility;
2. aquaculture operational plans; and
3. aquaculture permits.

C. Water Systems. If the land-based aquaculture system is of continuous flow through design, water from a growing area classified as approved, or in the open status of the conditionally approved classification at all times shellfish are held, may be used without treatment.

AUTHORITY NOTE: Promulgated in accordance with R.S.40:4.A.(1), R.S. 40:5.A.(2)(3)(5)(7)(9)(15)(17)(19)(20) and R.S. 40:5.3.

HISTORICAL NOTE: Promulgated by the Department of Health, Office of Public Health, LR 48:1856 (July 2022), repromulgated LR 48:2145 (August 2022).

Title 51
PUBLIC HEALTH—SANITARY CODE
Part X. Game Bird and Small Animal Slaughter and Processing

Chapter 1. Required Permits

§101. Definitions
[formerly paragraph 10:001]

A. Unless otherwise specifically provided herein, the following words and terms used in this Part of the sanitary code, and all other Parts which are adopted or may be adopted, are defined for the purposes thereof as follows.

Game Bird—includes, but is not limited to, quail, chukars, pheasants, guinea fowl and pigeons.

LSPC—Louisiana State Plumbing Code, i.e., (Plumbing) of this Code (LAC 51:XIV).

Meat Packing Plant—any establishment operating to manufacture, process, can or pack any meat product except those prepared from cattle, sheep, swine, goats, equines, chickens and turkeys.

Offal—waste, especially from a butchered animal, including but not limited to bones, cartilage, fatty tissue and gristle.

Poultry Processing Plant—any establishment operating to slaughter, manufacture, pack or prepare poultry or poultry products for human consumption, but shall not include plants processing chickens, turkeys, ducks and geese.

Slaughter—any establishment operating to slaughter, manufacture, pack or prepare any meat for human consumption, except that it shall not apply to establishments slaughtering cattle, sheep, swine, goats, equines, chickens, turkeys, ducks, and geese.

Small Animal—includes, but is not limited to, rabbits.

AUTHORITY NOTE: The first source of authority for promulgation of the sanitary code is in R.S. 36:258.B, with more particular provisions found in Chapters 1 and 4 of Title 40. This Part is promulgated in accordance with specific provisions of R.S. 40: 4.A.(1)(a), (6), (8) and 40:5.(5), (9). Also see R.S. 40:627.

HISTORICAL NOTE: Promulgated by the Department of Health and Hospitals, Office of Public Health, LR 28:1311 (June 2002), amended LR 38:2793 (November 2012).

§103. Permits; Regulated and Exempted Facilities
[formerly paragraph 10:002]

A. No slaughter house, meat packing plant, poultry processing plant or other establishment operated to slaughter, manufacture, pack or prepare any meat, meat food product, poultry or poultry products for human consumption shall be allowed to operate until the owner, manager or operator has obtained a permit to operate from the state health officer; provided these regulations do not apply to establishments slaughtering cattle, sheep, swine, goats,

equines, chickens or turkeys or preparing meats therefrom, and do not apply to retail meat markets.

B. [formerly paragraph 10:003] The inspection of slaughter houses, meat packing plants and sausage kitchens preparing cattle, sheep, swine, goats, equines, chickens and turkeys is vested in the Department of Agriculture and Forestry (LDAF) under authority of the State Meat and Poultry Inspection Law, R.S. 40:2271 et seq. The only services the Department of Health and Hospitals (LDHH) shall provide such establishments will be approval of their water supplies and waste disposal facilities and registration of meat products in accordance with the provisions of R.S. 40:627, and Parts XII and XIII of this Code.

AUTHORITY NOTE: Promulgated in accordance with the provisions of R.S. 40:4.A.(1)(a), (6), (8) and 40:5(5), (9). Also see R.S. 40:627.

HISTORICAL NOTE: Promulgated by the Department of Health and Hospitals, Office of Public Health, LR 28:1312 (June 2002).

§105. Applications for Permits
[formerly paragraph 10:004]

A. Each owner or operator of a slaughter house, meat packing plant, or poultry processing plant operated to slaughter, manufacture, pack or prepare for human consumption, any meat or meat products or poultry or poultry products subject to the regulations of this Part, shall make written application on a form prescribed and furnished by the state health officer, with such other information as the state health officer shall require.

B. [formerly paragraph 10:005] Permits shall be renewed annually by making written application on a form prescribed and furnished by the state health officer, with such other information as the state health officer shall require.

C. [formerly paragraph 10:008] Permits shall be issued only to the person or persons responsible for the operations of the facility and shall not be transferrable.

D. [formerly paragraph 10:009] Permits shall not be granted for operations in any building, any part of which is used as living quarters, unless floors, walls and ceilings are without openings that directly or indirectly communicate with any part of the building used as living quarters.

E. [formerly paragraph 10:010] Permits shall not be granted unless or until the building and premises are in a sanitary condition as determined by the state health officer.

F. [formerly paragraph 10:011] The permit of any establishment may be revoked for failure to comply with any of the provisions of the regulations in this Part.

G. [formerly paragraph 10:012] The state health officer shall have access at all times during reasonable working

hours to every part of any establishment subject to these regulations, for the purpose of making inspections.

AUTHORITY NOTE: Promulgated in accordance with the provisions of R.S. 40:4.A.(1)(a), (6), (8) and 40:5(5), (9). Also see R.S. 40:627.

HISTORICAL NOTE: Promulgated by the Department of Health and Hospitals, Office of Public Health, LR 28:1312 (June 2002).

§107. Labeling Requirements
[formerly paragraph 10:006]

A. All carcasses shall be identified as having been prepared in a permitted slaughter house by being labeled with all information required by the State Food, Drug and Cosmetic Law (R.S. 40:601 et seq.) and identified by the permit number of the establishment in which prepared. Any meat or meat product, poultry or poultry product, when offered for sale for human consumption, which is not identified with the permit number of the establishment where slaughtered or prepared, shall be subject to seizure and destruction as provided for by R.S. 40:632 and 635.

AUTHORITY NOTE: Promulgated in accordance with the provisions of R.S. 40:4.A.(1)(a), (6), (8) and 40:5(5), (9). Also see R.S. 40:627.

HISTORICAL NOTE: Promulgated by the Department of Health and Hospitals, Office of Public Health, LR 28:1312 (June 2002).

§109. Registration of Meat Products Offered for Sale
[formerly paragraph 10:007]

A. Establishments processing meat products from cattle, sheep, swine, goats, equines and poultry for sale principally at retail (but some at wholesale), that are exempt from meat inspection services of the Department of Agriculture and Forestry, shall operate under a permit issued by their parish health unit in accordance with §§501-503 of Part XXIII of this Code. Those products sold in package form at wholesale by exempt retailers shall be registered with the Food and Drug Control Unit as required by R.S. 40:627.

AUTHORITY NOTE: Promulgated in accordance with the provisions of R.S. 40:4.A.(1)(a), (6), (8) and 40:5(5), (9). Also see R.S. 40:627.

HISTORICAL NOTE: Promulgated by the Department of Health and Hospitals, Office of Public Health, LR 28:1312 (June 2002).

§111. Required Records
[formerly paragraph 10:013]

A. Each slaughter house operator shall keep a daily record to show the kind and number of birds or animals slaughtered.

B. [formerly paragraph 10:014] When slaughtering is done for an individual, or group of individuals other than the slaughter house operator, there shall also be kept a daily record as to the number and kind of animals slaughtered for each individual or group of individuals.

C. [formerly paragraph 10:015] These records shall be kept on file for one year by the owner or operator of the slaughter house and shall be available for the state health

officer's inspection at any time during reasonable working hours.

AUTHORITY NOTE: Promulgated in accordance with the provisions of R.S. 40:4.A.(1)(a), (6), (8) and 40:5(5), (9). Also see R.S. 40:627.

HISTORICAL NOTE: Promulgated by the Department of Health and Hospitals, Office of Public Health, LR 28:1312 (June 2002).

§113. Building Requirements
[formerly paragraph 10:016]

A. Every slaughter house and meat packing plant shall be maintained in a sanitary condition and in compliance with the requirements of the regulations contained in this Part and those in Parts V (Disease Vector Control), XIII (Sewage Disposal) and XIV (Plumbing) of this Code.

B. [formerly paragraph 10:017] Plans and specifications for new establishments shall be submitted to the Department of Health and Hospitals, Office of Public Health, Food and Drug Unit for review and approval before construction.

C. [formerly paragraph 10:018-1] Slaughter and processing plants shall be well lighted, naturally and/or artificially with at least 40 foot-candles of light on all working surfaces.

D. [formerly paragraph 10:018-2] Slaughter and processing plants shall be provided with adequate ventilation or control equipment to minimize odors and vapors (including steam and noxious fumes) in areas where they may contaminate food; and locate and operate fans and other air-blowing equipment in a manner that minimizes the potential for contaminating food, food-packaging materials, and food-contact surfaces.

E. [formerly paragraph 10:019] Drainage, sewage disposal, and plumbing systems shall comply with Parts XIII and XIV of this Code. Floor drains shall be provided in the slaughter and packing rooms in accordance with Part XIV.

F. [formerly paragraph 10:020] Potable water shall be available in all areas of the slaughter house for cleaning and sanitizing utensils and equipment, and for hand washing, as specified in the Louisiana State Plumbing Code (LSPC), particularly Chapter 6 thereof. A heating facility capable of producing hot water for these purposes shall be provided on the premises. Water samples to verify microbiological quality and potability shall be collected from each plant at least annually.

G. [formerly paragraph 10:021] The floors, walls, ceilings, partitions, posts, doors and other parts of all structures shall be smooth and tight, and of such materials, construction and finish as will enable ready and thorough cleaning. The floors shall be constructed of concrete or tile laid in concrete, or of any other material impermeable to water.

H. [formerly paragraph 10:022] General construction of building shall include:

1. a holding area for animals and fowls;
2. a slaughter, skinning or defeathering room; and

3. a packing, labeling and storage room.

I. [formerly paragraph 10:023] All openings into the outer air shall be protected against the entrance of flies, insects and vermin. "Fly Chaser" fans and ducts should be provided over frequently used openings to the outside.

AUTHORITY NOTE: Promulgated in accordance with the provisions of R.S. 40:4.A(1)(a), (6), (8) and 40:5(5)(9). Also see R.S. 40:627.

HISTORICAL NOTE: Promulgated by the Department of Health and Hospitals, Office of Public Health, LR 28:1313 (June 2002), amended LR 38:2793 (November 2012).

§115. Required Sanitary Facilities
[formerly paragraph 10:024]

A. Sanitary facilities and accommodations shall be furnished by every establishment engaged in the slaughter, preparation or packing of meat or poultry product for human consumption.

B. [formerly paragraph 10:025] Toilet facilities shall be provided and installed in accordance with LAC 51:XIV.411. Facilities shall be conveniently located and shall be accessible to employees at all times.

C. [formerly paragraph 10:026] Hand washing lavatories shall be provided in food processing and other food handling areas and shall be installed in accordance with LAC 51:XIV.411. Hand washing lavatories shall be conveniently located and accessible to employees at all times. Hand washing lavatories shall also be located in or immediately adjacent to toilet rooms or vestibules. Sinks used for food preparation or for washing and sanitizing of equipment and utensils shall not be used for hand washing. Each hand-washing lavatory shall be provided with hot and cold water tempered by means of a mixing valve or combination faucet. An ample supply of hand cleansing soap or detergent shall be available at each lavatory. An ample supply of sanitary towels or a hand-drying device providing heated air shall be conveniently located near each hand-washing lavatory. The use of common towels is prohibited. If disposable towels are used, easily cleanable waste receptacles shall be conveniently located near the hand washing facilities.

D. [Formerly paragraph 10:027] A three compartment sink constructed of smooth, impervious non-corrosive material such as stainless steel or high density food grade polymer plastic shall be provided in slaughter rooms, packing rooms or other preparation rooms for washing, rinsing and sanitizing utensils and equipment. Sinks constructed of galvanized steel are not acceptable. Sinks shall be adequate in size and number and shall be large enough to accommodate the largest utensil or movable piece of equipment. Each sink compartment is to be designated and used for a specific purpose as shown in Table 10.1 below.

Table 10.1 Three Compartment Sink Usage		
Sink Compartment #1	Sink Compartment #2	Sink Compartment #3
Detergent Wash to remove soil and food residues.	Rinse with potable water to remove detergent solution.	Immersion in hot water or chemical sanitizing solution to destroy harmful microbes not removed by washing process.

1. [formerly a part of paragraph 10:027] Each sink compartment shall be provided with hot and cold running water delivered under pressure through a mixer faucet or mixing valve. Sinks are to be properly installed and shall be trapped and vented. Sinks designated for washing or thawing of food or food ingredients shall be designated for that purpose only and shall not be used for cleaning equipment or utensils.

AUTHORITY NOTE: Promulgated in accordance with the provisions of R.S. 40:4.A(1)(a), (6), (8) and 40:5(5)(9). Also see R.S. 40:627, amended LR 38:2793 (November 2012).

HISTORICAL NOTE: Promulgated by the Department of Health and Hospitals, Office of Public Health, LR 28:1313 (June 2002), amended LR 38:2793 (November 2012), repromulgated LR 38:3233 (December 2012).

§117. Equipment and Utensils
[formerly paragraph 10:028-1]

A. Equipment and utensils used for preparing, processing and otherwise handling any meat, meat product or poultry shall be of such material and construction so as to enable ready and thorough cleaning and sanitizing such as will insure strict cleanliness in the preparation and handling of all food products. Trucks and receptacles used for inedible products shall bear some conspicuous and distinct mark and shall not be used for handling edible products.

B. [formerly paragraph 10:028-2] Equipment and utensils used for preparing, processing and otherwise handling any meat, meat product or poultry shall be cleaned as often as necessary to avoid contamination of food, food ingredients and food-packaging materials. Food contact surfaces of equipment and utensils used in the processing and packaging of foods subject to contamination by harmful microbes shall be washed with a suitable detergent solution, rinsed with potable water and then sanitized in a manner specified as follows.

1. [formerly paragraph 10:028-2.A] Hot Water Immersion. Cleaned equipment and utensils shall be immersed in fresh hot water of 170° F (77°C) or above.

2. [formerly paragraph 10:028-2.B] Chemical Sanitizers. A chemical sanitizer used in a sanitizing solution for a manual or mechanical operation at exposure times specified in §117.C shall be listed in 21 CFR 178.1010, shall be used in accordance with the EPA approved manufacturer's label use instructions, and shall be used as follows:

a. [formerly paragraph 10:028-2.B.(1)] a chlorine solution shall have a minimum temperature based on the concentration and pH of the solution as listed in the following chart;

PUBLIC HEALTH—SANITARY CODE

Minimum Concentration mg/L	Minimum Temperature pH of 10 or less °F (°C)	Minimum Temperature pH of 8 or less °F (°C)
25	120 (49)	120 (49)
50	100 (38)	75 (24)
100	55 (13)	55 (13)

b. [formerly paragraph 10:028-2.B.(2)] an iodine solution shall have a:

i. minimum temperature of 75°F (24°C);

ii. pH of 5.0 or less, unless the manufacturer's use directions included in the labeling specify a higher pH limit of effectiveness; and

iii. concentration between 12.5 mg/L and 25 mg/L;

c. [formerly paragraph 10:028-2.B.(3)] a quaternary ammonium compound solution shall:

i. have a minimum temperature of 75°F (24°C);

ii. have an effective concentration of not more than 200 mg/L as specified in 21 CFR 178.1010;

iii. be used only in water with 500 mg/L hardness or less;

d. [formerly paragraph 10:028-2.B.(4)] other solutions of the chemicals specified in §117.B.2.a-c of this Part may be used if demonstrated to the state health officer to achieve sanitization and approved by the state health officer; or

e. [formerly paragraph 10:028-2.B.(5)] other chemical Sanitizers may be used if they are applied in accordance with the manufacturer's use directions included in the labeling.

C. [formerly paragraph 10:028-2.C] Sanitization Exposure Times. Utensils and food-contact surfaces shall be exposed to hot water and chemical compounds for a period of time as specified below.

Method	Minimum Exposure Time
Hot Water Immersion	30 seconds
Chlorine Solutions	10 seconds
Other Chemical Sanitizing Solutions	30 seconds

1. [formerly paragraph 10:029] Rooms, compartments, places, equipment and utensils used for preparing, storing or otherwise handling any meat, meat products or poultry and all other parts of the establishment shall be kept clean and sanitary.

2. [formerly paragraph 10:030] Operations and procedures involving the preparation, storing and handling of any meat, meat product or poultry shall be in accordance with clean and sanitary methods as approved by the state health officer.

3. [formerly paragraph 10:031] Rooms, compartments, places, equipment and utensils used for preparing, storing or otherwise handling any meat, meat products or poultry processed or packed, shall be kept free of steam and vapor to allow for inspections and to insure clean operations. The walls and ceilings of coolers and rooms under refrigeration shall be kept free from moisture so that

condensation does not accumulate on walls and ceilings. Fresh meat and poultry shall be stored at 41°F or below.

4. [formerly paragraph 10:032-1] Butchers and others who dress or handle diseased carcasses or parts shall, before handling or dressing other carcasses or parts, cleanse hands of grease, immerse them in a prescribed disinfectant and rinse them in clean water. Implements used in dressing diseased carcasses should be thoroughly cleaned in boiling water with a prescribed disinfectant, followed by rinsing in clean water.

5. [formerly paragraph 10:032-2] The employees of the establishment who handle any meat, meat products or poultry shall keep their hands clean and in all cases after visiting the toilet room or urinal shall wash their hands before handling any meat, meat products, poultry or implements used in their preparation. A sign so instructing shall be posted in the toilet or lavatory areas.

6. [formerly paragraph 10:033] Aprons, frocks and other outer clothing worn by persons who handle any meat, meat products or poultry shall be of material that is readily cleaned and only clean garments shall be worn. At all times during work employees shall wear hair restraints such as hats, caps, nets or a type of restraint approved by the state health officer.

7. [formerly paragraph 10:034] The vehicle in which any meat, meat products or poultry is transported shall be kept in a clean and sanitary condition. Accumulations of blood, drippings, trimmings or decomposed carcasses are prohibited. Wagons, carts, trucks or other conveyances used in transferring loose meat, meat products or poultry from the slaughter house to other places of storage or final distribution shall be closed or so covered that the contents shall be kept clean.

8. [formerly paragraph 10:035] In addition, all vehicles used to transport meat, meat products or poultry shall be equipped with refrigeration units capable of maintaining 41°F or below for refrigerated products and 0°F or below for frozen products to insure their cleanliness.

9. [formerly paragraph 10:036] When there is an imminent danger to public health, a duly authorized representative of the state health officer shall attach a tag to any equipment or utensil which is insanitary. The use of tagged equipment or utensils will be in violation of these regulations. No equipment or utensils so tagged shall again be used until made sanitary. Such tag so placed shall not be removed by anyone other than the state health officer.

10. [formerly paragraph 10:037] All operations and storage rooms and departments used for inedible products shall be maintained in clean condition acceptable to the state health officer. The outer premises of their establishment including the dock area where cars, trucks or wagons are loaded, and the driveway's, approaches, yards, pens and alleys shall be properly drained and kept clean, orderly and free of accumulations of refuse, spilled products and materials which may decompose and provide harborage for rodents, insects and vermin. All catch basins on the premises

shall be of such construction and location that they shall be kept clean and free from odors.

AUTHORITY NOTE: Promulgated in accordance with the provisions of R.S. 40:4.A.(1)(a), (6), (8) and 40:5.(5), (9). Also see R.S. 40:627.

HISTORICAL NOTE: Promulgated by the Department of Health and Hospitals, Office of Public Health, LR 28:1314 (June 2002).

§119. Employee Health Provisions
[formerly paragraph 10:038]

A. The requirements of Part I, §117 and Part II, §§501-503.C of this Code shall be met.

AUTHORITY NOTE: Promulgated in accordance with the provisions of R.S. 40:4.A.(1)(a), (6), (8) and 40:5.(5), (9). Also see R.S. 40:627.

HISTORICAL NOTE: Promulgated by the Department of Health and Hospitals, Office of Public Health, LR 28:1315 (June 2002).

§121. Dogs or Cats Prohibited on Premises
[formerly paragraph 10:039]

A. Dogs or cats shall not be admitted into any establishment where meat or poultry is handled in any way to be prepared for human consumption.

AUTHORITY NOTE: Promulgated in accordance with the provisions of R.S. 40:4.A.(1)(a), (6), (8) and 40:5.(5), (9). Also see R.S. 40:627.

HISTORICAL NOTE: Promulgated by the Department of Health and Hospitals, Office of Public Health, LR 28:1315 (June 2002).

§123. Offal Prohibited on Premises
[formerly paragraph 10:040]

A. Offal shall be properly disposed of in a manner so as not to create nuisances or unsanitary conditions in or around the slaughter and processing plant that would provide a source of contamination. Offal shall be hauled away and properly disposed of daily pursuant to the requirements set forth in Parts XI and XXVII of the state sanitary code.

AUTHORITY NOTE: Promulgated in accordance with the provisions of R.S. 40:4.A.(1)(a), (6), (8) and 40:5.(5), (9). Also see R.S. 40:627.

HISTORICAL NOTE: Promulgated by the Department of Health and Hospitals, Office of Public Health, LR 28:1315 (June 2002).

§125. Storage of Hides or Pelts on Premises
[formerly paragraph 10:041]

A. Hides or pelts shall be treated and stored in a fly-tight room or fly-tight receptacle so as not to create a nuisance or health problem.

AUTHORITY NOTE: Promulgated in accordance with the provisions of R.S. 40:4.A.(1)(a), (6), (8) and 40:5.(5), (9). Also see R.S. 40:627.

HISTORICAL NOTE: Promulgated by the Department of Health and Hospitals, Office of Public Health, LR 28:1315 (June 2002).

§127. Plant Wastes
[formerly paragraph 10:042]

A. All plant wastes shall be disposed of in a manner approved by the state health officer as provided for by Parts XIII and XIV of this Code.

AUTHORITY NOTE: Promulgated in accordance with the provisions of R.S. 40:4.A.(1)(a), (6), (8) and 40:5.(5), (9). Also see R.S. 40:627.

HISTORICAL NOTE: Promulgated by the Department of Health and Hospitals, Office of Public Health, LR 28:1315 (June 2002).

Chapter 3. Nutria Program

§301. Nutria Inspection Program
[formerly paragraph 10:043]

A. In order to protect the health and welfare of consumers and to properly manage the nutria inspection program, an initial pilot program will be established and will include the supervision of a limited number of nutria processing facilities. For the initial pilot program, permits to operate will be issued to a maximum of five qualified applicants. Application for permits to process nutria shall be made on a form provided by the Department of Health and Hospitals. However, no application to process nutria will be accepted after the maximum number of permits have been issued or after the closing of the nutria trapping season. The nutria processing pilot program will commence and cease on dates coinciding with the beginning and ending of the nutria-trapping season as promulgated by the Wildlife and Fisheries Commission. Permits issued by LDHH will expire at midnight of the last official day of the nutria-trapping season. Only nutria taken by licensed trappers will be considered eligible for processing and inspection under the cooperative inspection program. The number of nutria processing plants that will be approved and permitted for nutria processing in future years will be determined each year after the close of the nutria trapping season and after an evaluation of each year's production has been made.

AUTHORITY NOTE: Promulgated in accordance with the provisions of R.S. 40:4.A.(1)(a), (6), (8) and 40:5.(5), (9). Also see R.S. 40:627.

HISTORICAL NOTE: Promulgated by the Department of Health and Hospitals, Office of Public Health, LR 28:1315 (June 2002).

§303. Nutria for Human Consumption
[formerly paragraph 10:044]

A. Persons wanting to process nutria for human consumption must meet certain minimum qualifications in order to be considered for inclusion in the nutria processing pilot program.

1. [formerly paragraph 10:044-1] Permitted facilities shall:

a. have access to an abundant supply of nutria animals for slaughtering and processing in order to keep each processing facility operating at an acceptable capacity in order to best utilize the personnel and resources of all departments;

b. utilize processing facilities that are designed and constructed to meet the minimum standards of Part X of the state sanitary code;

c. establish and adhere to a Hazard Analysis Critical Control Point (HACCP) quality control plan approved by LDAF that will render safe nutria meat which is free of harmful microorganisms and of sound, wholesome quality;

d. receive and process only those nutria animals that have been taken by trappers who hold a valid license issued by the Department of Wildlife and Fisheries (LDWF);

e. pre-inspect nutria carcasses upon receipt from licensed trappers to verify suitability for submission for inspection. Carcasses that are deemed unsuitable for processing for human consumption shall be clearly marked or otherwise identified so as not to be subject to inspection or otherwise commingled with nutria deemed suitable for human consumption. Nutria carcasses declared not fit for human consumption shall be rejected from inspection and shall be destroyed and disposed of in a manner approved by LDHH and LDAF and shall not be allowed to create a nuisance and/or a source of contamination.

AUTHORITY NOTE: Promulgated in accordance with the provisions of R.S. 40:4.A.(1)(a), (6), (8) and 40:5.(5), (9). Also see R.S. 40:627.

HISTORICAL NOTE: Promulgated by the Department of Health and Hospitals, Office of Public Health, LR 28:1316 (June 2002).

§305. Labeling Requirements
[formerly paragraph 10:045]

A. Each package, container, carton, or case of nutria, nutria meat, or nutria meat products shall be labeled in

accordance with Section 49:3.0601 of the meat and meat products regulations. Labels and labeling shall be reviewed and approved by the LDAF. All nutria taken, processed, packaged and distributed under this cooperative program shall be labeled and identified as "certified cajun nutria."

B. [formerly paragraph 10:046] No nutria meat shall be sold in any butcher shop, meat market, grocery store, restaurant or to any wholesale grocer, dealer or distributors unless such nutria meat is clearly identified as having been processed and inspected in an approved processing facility. Nutria meat not clearly identified as having been processed and inspected in an approved processing facility shall be subject to seizure and destruction as provided for by R.S. 40:632 and 635.

AUTHORITY NOTE: Promulgated in accordance with the provisions of R.S. 40:4.A.(1)(a), (6), (8) and 40:5.(5), (9). Also see R.S. 40:627.

HISTORICAL NOTE: Promulgated by the Department of Health and Hospitals, Office of Public Health, LR 28:1316 (June 2002).

§307. Provisions Applicable to Nutria
[formerly paragraph 10:047]

A. The provisions herein constituting Part X of the state sanitary code shall apply to the nutria program, as appropriate.

AUTHORITY NOTE: Promulgated in accordance with the provisions of R.S. 40:4.A.(1)(a), (6), (8) and 40:5.(5), (9). Also see R.S. 40:627.

HISTORICAL NOTE: Promulgated by the Department of Health and Hospitals, Office of Public Health, LR 28:1316 (June 2002).

Title 51
PUBLIC HEALTH—SANITARY CODE
Part XI. Animals and Animal Diseases; Rendering of Animals

Chapter 1. General

§101. Definitions
[formerly paragraph 11:001]

A. Unless otherwise specifically provided herein, the following words and terms used in this Part of the sanitary code and all other Parts which are adopted or may be adopted, are defined for the purposes thereof as follows.

Animal—all animals, any part of the body of which is used as food for human consumption and, insofar as these regulations relate to sanitation of premises or to spread of any communicable disease dangerous to man, shall also include dogs, donkeys and other similar livestock.

Fowl—all poultry, ducks, geese, turkeys, or game birds used as food for human consumption, and parrots or other birds capable of spreading any disease dangerous to man.

Nuisance—a source of inconvenience, annoyance, vexation; bother.

Offal—waste, especially of a butchered animal.

Rendering Plant—any establishment equipped to cook and make innocuous any animal or fowl dead from any cause, or any offal from a slaughter house, abattoir, or butcher shop.

AUTHORITY NOTE: The first source of authority for promulgation of the sanitary code is R.S. 36:258(B), with more particular provisions found in Chapters 1 and 4 of Title 40 of the Louisiana Revised Statutes. This Part is promulgated with the specific provisions of R.S. 40:4(A)(12).

HISTORICAL NOTE: Promulgated by the Department of Health and Hospitals, Office of Public Health, LR 28:1316 (June 2002).

§103. Inspection of Premises Used to Hold Animals or Fowls
[formerly paragraph 11:002]

A. Any premises to be used as a corral, stable, poultry yard, hog pen, aviary, or for the holding of any animals or fowls, shall be open to inspection by the state health officer at any reasonable time.

AUTHORITY NOTE: Promulgated in accordance with the provisions of R.S. 40:4(A)(12).

HISTORICAL NOTE: Promulgated by the Department of Health and Hospitals, Office of Public Health, LR 28:1317 (June 2002).

§105. Sanitary Disposal of Dead Animals or Fowl
[formerly paragraph 11:003]

A. The body of any animal or fowl dead of any disease, killed on account of a diseased condition, or killed by accident, shall be buried, incinerated, rendered into tankage, or otherwise disposed of in such a manner as not to constitute a nuisance or hazard to the public health.

AUTHORITY NOTE: Promulgated in accordance with the provisions of R.S. 40:4(A)(12).

HISTORICAL NOTE: Promulgated by the Department of Health and Hospitals, Office of Public Health, LR 28:1317 (June 2002).

Chapter 3. Rendering Plants

§301. Required Health Permit for Rendering Plant
[formerly paragraph 11:004]

A. No person shall operate a rendering plant without first obtaining a permit to operate from the parish health unit in the parish in which it operates.

B. [formerly paragraph 11:005] In applying for a permit, the applicant shall submit detailed plans for the rendering plant, showing its location, construction, equipment, water supply, sewage and refuse disposal.

C. [formerly paragraph 11:006] On receipt of an application, the state health officer shall review the plans submitted to ensure that they comply with sound sanitary engineering principles. If the plans are found satisfactory, a permit to build said facility shall be issued.

1. [formerly a part of paragraph 11:006] After completion, and during construction as necessary, the state health officer shall inspect the facility. If the inspection reveals that the facility is in compliance with all requirements of this code, a permit to operate shall be issued. This permit is conditioned on the plant being operated in such a manner so as not to create a nuisance or any condition which might injuriously affect the public health.

D. [formerly paragraph 11:007] The permit shall be issued to the person responsible for the operation of the rendering plant and is not transferable. If a different person becomes responsible, the plant will not be allowed to operate until a permit for that person has been issued.

E. [formerly paragraph 11:008] Any permit to operate a rendering plant is subject to revocation if the plant is operating at any time in violation of the provisions of this Code.

AUTHORITY NOTE: Promulgated in accordance with the provisions of R.S. 40:4(A)(12).

HISTORICAL NOTE: Promulgated by the Department of Health and Hospitals, Office of Public Health, LR 28:1317 (June 2002).

§303. Sanitary Hauling Dead Animals or Offal
[formerly paragraph 11:009]

A. The hauling of any dead animal, or of offal, shall be done in a truck, or other conveyance having a water tight floor and sides made of an impervious material capable of

being washed and scrubbed to eliminate any residues. It shall be provided with a tight covering to prevent entrance by flies. Said conveyance shall be washed at the end of each day's use, or more often if residues accumulate or odors become offensive. Said washing shall be done on concrete or other impervious surface sloping toward a drain so that none of the wash water escapes the controlled area. Said drain shall be equipped with a strainer and shall be connected to a sanitary sewage treatment system which meets the requirements of Part XIII of this Code.

B. [Former paragraph 11:010] Truck or other conveyance hauling any dead animal or offal shall not stop until it reaches its destination, unless detained by a situation or event not within the control of the driver of the conveyance.

AUTHORITY NOTE: Promulgated in accordance with the provisions of R.S. 40:4(A)(12).

HISTORICAL NOTE: Promulgated by the Department of Health and Hospitals, Office of Public Health, LR 28:1317 (June 2002).

§305. Prohibited Activities
[formerly paragraph 11:011]

A. None of the products of any rendering plant shall be utilized in any food products for human consumption.

B. [formerly paragraph 11:013] No person shall keep, throw into, or place in any public water, street, or any other place, other than a facility designed for processing or disposing of same, and which is in compliance with all requirements of this code, any dead, sick, or injured animal or any part thereof.

C. [formerly paragraph 11:014] No person shall bring, or cause to be brought, into the limits of any municipality any hides, bones, pelts, rags or any other articles that might serve as an attraction to or a breeding place for flies or other vectors of infection, or which may in any way endanger the public health or create a public nuisance.

D. [formerly paragraph 11:015] No hide, bones, or any other parts of animals not intended as food for human consumption shall be kept in any room, refrigerator, cold storage area, or any other area where meat for human consumption is processed or stored, such as in slaughter houses or meat markets.

AUTHORITY NOTE: Promulgated in accordance with the provisions of R.S. 40:4(A)(12).

HISTORICAL NOTE: Promulgated by the Department of Health and Hospitals, Office of Public Health, LR 28:1317 (June 2002).

§307. Label and Tagging Requirements
[formerly paragraph 11:012]

A. All grease and other products of a rendering plant not utilized in fertilizers but packed for use in, or transportation to, some other locality, shall be branded, marked, tagged or otherwise identified on every package with a conspicuous label, printed in read ink, as follows: "Inedible _____ of Dead Animals," with the name of the product to appear in the space left blank.

AUTHORITY NOTE: Promulgated in accordance with the provisions of R.S. 40:4(A)(12).

HISTORICAL NOTE: Promulgated by the Department of Health and Hospitals, Office of Public Health, LR 28:1317 (June 2002).

Title 51

PUBLIC HEALTH—SANITARY CODE

Part XII. Water Supplies

Chapter 1. General

§101. Definitions

[formerly paragraph 12:001]

A. Unless otherwise specifically provided herein, the following words and terms used in this Part of the *Sanitary Code*, and all other Parts which are adopted or may be adopted, are defined for the purposes thereof as follows.

Abandoned Well—a water well that has been permanently discontinued; has had its pumping equipment permanently removed; is in such a state of disrepair that it cannot be used to supply water and/or has the potential for transmitting surface contaminants into the aquifer; poses potential health or safety hazards or the well is in such a condition that it cannot be placed in service.

Auxiliary Intake—any piping connection or other device whereby water may be secured from a source other than that normally used.

Average Daily Demand during the Month of Maximum Water Use—the largest volume of flow anticipated to occur during a calendar month, expressed as a daily average.

Back Siphonage—a form of backflow caused by negative or subatmospheric pressure within a water system.

Backflow—

a. a flow condition, induced by a differential pressure, that causes the flow of water or other liquid into the distribution pipes of a potable water supply from any source or sources other than its intended source; or

b. the backing up of water through a conduit or channel in the direction opposite to normal flow.

Backflow Preventer—a device for a potable water supply pipe to prevent the backflow of water of questionable quality into the potable water supply system.

Boil Notice—an official order authorized by the state health officer to the owner/users of a specific water supply, directing that water from that supply be boiled according to directions, or otherwise disinfected prior to human consumption.

By-Pass—any system of piping or other arrangement whereby the water may be diverted around any part or portion of a water supply or treatment facility.

Category—a group of physical, chemical, or radiological parameters associated with drinking water for which laboratory certification is offered under the *laboratory certification program*.

Certification Fee—the annual charge assessed laboratories requesting certification from the Department of Health and Hospitals to provide the needed chemical (organic, inorganic and radiological) analytical support for the public water systems.

Certified Chemical Laboratory/Drinking Water—a laboratory meeting the requirements contained within the *laboratory certification regulations* and which has been officially certified by the state health officer to analyze and report compliance monitoring sample results for one or more physical, chemical, or radiological parameters associated with drinking water. Certification may be obtained on a parameter by parameter basis only.

Committee of Certification—the committee, created by R.S. 40:1141-1151, responsible for certification of waterworks operators and sewerage works operators.

Community Water Supply—a public water system which serves at least 15 service connections used by year-round residents or regularly serves at least 25 year-round residents.

Community Water System—community water supply.

Contaminant—any physical, chemical, biological, or radiological substance or matter in water.

Critical Component—a component is considered critical if failure is expected to result in a quality or quantity of finished water that fails to meet the requirements of this Part.

Cross Connection—

a. a physical connection through which a supply of potable water could be contaminated or polluted; or

b. a connection between a supervised potable water supply and an unsupervised supply of unknown potability.

Drain—any pipe which carries waste water or water-borne waste in a building drainage system.

Drainage System—(drainage piping) includes all the piping within public or private premises, which conveys sewage, rain water, or other liquid wastes to a point of disposal, but does not include the mains of a public sewer system or a private or public sewage treatment plant.

Engineer of Record—the Louisiana licensed professional engineer responsible for the submission of plans and specifications for an installation to be permitted by the state health officer under this Part.

Ground Water—subsurface water occupying the saturation zone from which wells and springs are fed. In a strict sense the term applies only to water below the water table.

Hospital—see LAC 51:XIX.101.

Human Consumption—the use of water by humans for drinking, cooking, bathing, showering, hand washing, dishwashing, or maintaining oral hygiene.

Interconnection—a physical connection between two water supply systems.

Laboratory Certification Manual—the reference book which contains the Department of Health and Hospitals' regulations governing laboratory certification and standards of performance for laboratories conducting drinking water analyses for public water supplies in the state of Louisiana.

Laboratory Certification Program—a program carried out by the Department of Health and Hospitals, Office of Public Health to certify commercially and publicly owned laboratories to perform compliance monitoring analyses for public water systems and other potable water supply systems in accordance with the National Primary Drinking Water Regulations and this Part. The cost of the program will be recouped from the laboratories requesting certification.

Laboratory Certification Regulations—the regulations which govern laboratory certification and standards of performance for laboratories conducting drinking water analyses for public water systems and other potable water supply systems in the state of Louisiana. Such regulations are housed in LAC 48:V.Chapter 80.

Laboratory Requesting Certification—an uncertified laboratory which has submitted an acceptable application and appropriate fee(s) for the category in which it desires certification.

Lead Free—

a. In general:

i. not containing more than 0.2 percent lead when used with respect to solder and flux; and

ii. not more than a weighted average of 0.25 percent lead when used with respect to the wetted surfaces of pipes, pipe fittings, plumbing fittings, and fixtures.

b. Calculation

i. The weighted average lead content of a pipe, pipe fitting, plumbing fitting, or fixture shall be calculated by using the following formula:

(a). For each wetted component, the percentage of lead in the component shall be multiplied by the ratio of the wetted surface area of that component to the total wetted surface area of the entire product to arrive at the weighted percentage of lead of the component. The weighted percentage of lead of each wetted component shall be added together, and the sum of these weighted percentages shall constitute the weighted average lead content of the product. The lead content of the material used to produce wetted components shall be used to determine compliance with Clause "a.ii." above. For lead content of materials that are provided as a range, the maximum content of the range shall be used.

Level 1 Assessment—an evaluation to identify the possible presence of sanitary defects, defects in distribution

system coliform monitoring practices, and (when possible) the likely reason that the system triggered the assessment. Minimum elements include review and identification of atypical events that could affect distributed water quality or indicate that distributed water quality was impaired; changes in distribution system maintenance and operation that could affect distributed water quality (including water storage); source and treatment considerations that bear on distributed water quality, where appropriate; existing water quality monitoring data; and inadequacies in sample sites, sampling protocol, and sample processing. The system must conduct the assessment consistent with any State directives that tailor specific assessment elements with respect to the size and type of the system and the size, type, and characteristics of the distribution system.

Level 2 Assessment—an evaluation to identify the possible presence of sanitary defects, defects in distribution system coliform monitoring practices, and (when possible) the likely reason that the system triggered the assessment. A Level 2 assessment provides a more detailed examination of the system (including the system's monitoring and operational practices) than does a Level 1 assessment through the use of more comprehensive investigation and review of available information, additional internal and external resources, and other relevant practices. Minimum elements include review and identification of atypical events that could affect distributed water quality or indicate that distributed water quality was impaired; changes in distribution system maintenance and operation that could affect distributed water quality (including water storage); source and treatment considerations that bear on distributed water quality, where appropriate; existing water quality monitoring data; and inadequacies in sample sites, sampling protocol, and sample processing. The system must comply with any expedited actions or additional actions required by the State in the case of an *E. coli* MCL violation.

Listed—equipment or materials included in a list published by an approved nationally recognized testing laboratory, inspection agency or other organization concerned with product evaluation that maintains periodic inspection of production of *listed* equipment or materials, and whose listing states either that the equipment or material meets nationally recognized standards or has been tested and found suitable for use in a specified manner. The means for identifying *listed* equipment may vary for each testing laboratory, inspection agency, or other organization concerned with product evaluation, some of which do not recognize equipment as *listed* unless it is also labeled. The water supplier should utilize the system employed by the listing organization to identify a *listed* product.

a. In respect to any solder, flux, pipes, pipe fittings, plumbing fittings, fixtures, and any other appurtenances which are claimed to be lead free, this defined term (*listed*) shall additionally include the requirement that all such solder, flux, pipes, pipe fittings, plumbing fittings, fixtures, and any other appurtenances have been certified to be lead free by an independent American National Standards Institute (ANSI)-accredited third party testing laboratory, inspection agency or other organization concerned with product evaluation.

Louisiana Water Well Rules, Regulations, and Standards—see LAC 56: I.

LSPC—Louisiana State Plumbing Code, i.e., Part XIV (Plumbing) of this Code (LAC 51:XIV) became null and void on January 1, 2016 per Act 836 of the 2014 Regular Legislative Session. See the Louisiana State Uniform Construction Code (LAC 17:I:Chapter 1) for state plumbing regulations.

Maximum Contaminant Level (MCL)—the highest permissible concentration of a substance allowed in drinking water as established by the U.S. Environmental Protection Agency.

National Primary Drinking Water Regulations—

a. drinking water regulations promulgated by the U.S. Environmental Protection Agency pursuant to applicable provisions of title XIV of the Public Health Service Act, commonly known as the "Safe Drinking Water Act," 42 U.S.C.A. §300f et seq., and as published in the July 1, 2015 edition of the *Code of Federal Regulations*, Title 40, Part 141 (40 CFR 141), less and except:

i. 40 CFR §141.35 Reporting for unregulated contaminant monitoring results;

ii. 40 CFR §141.40 Monitoring requirements for unregulated contaminants;

iii. Subpart H—Filtration and Disinfection (40 CFR §§141.70-141.76);

iv. Subpart P—Enhanced Filtration and Disinfection—Systems Serving 10,000 or More People (40 CFR §§141.170-141.175);

v. Subpart T—Enhanced Filtration and Disinfection—Systems Serving Fewer Than 10,000 People (40 CFR §§141.500—571); and

vi. Subpart X—Aircraft Drinking Water Rule (40 CFR §§141.800—810).

b. when "Subpart H", "Subpart P", or "Subpart T" is used within the actual text of the drinking water regulations cited in Subparagraph "a." of this Paragraph (definition), "LAC 51:XII:Chapter 11" shall be substituted therein.

National Secondary Drinking Water Regulations (NSDWR)—regulations (40 CFR Part 143) promulgated by the U.S. Environmental Protection Agency pursuant to applicable provisions of P.L. 99-339, the "Safe Drinking Water Act," and as published in the *Federal Register* of July 19, 1979, pages 42,195-42,202 and April 2, 1986, page 11,412.

Non-Community Water Supply—a public water system that does not meet the criteria for a community water supply and serves at least 25 individuals (combination of residents and transients) at least 60 days out of each year. A non-community water supply is either a *transient non-community water supply* or a *non-transient non-community water supply*.

Non-Transient Non-Community Water Supply—a public water system that is not a community system and regularly

serves at least 25 of the same persons (non-residents) over six months per year.

Operator—the individual, as determined by the committee of certification, in attendance, onsite of a water supply system and whose performance, judgment and direction affects either the safety, sanitary quality or quantity of water treated or delivered.

Permit—a written document issued by the state health officer through the Office of Public Health which authorizes construction and operation of a new water supply or a modification of any existing supply.

Person—a natural *person*, his heirs, executors, administrators, or assigns; and includes a firm, partnership, or corporation, it's or their successors or assigns, the state of Louisiana or any of its political subdivisions, the United States government or any of its political subdivisions and any officer, employee and agent of one of those entities. Singular includes plural; male includes female.

Potable Water—water having bacteriological, physical, radiological, and chemical qualities that make it safe and suitable for *human consumption*.

Potable Water Supply—a source of potable water, and the appurtenances that make it available for use.

Private Water Supply—a potable water supply that does not meet the criteria for a public water supply.

Public Water Supply—*public water system*.

Public Water System—a system for the provision to the public of water for potable water purposes through pipes or other constructed conveyances, if such system has at least 15 service connections or regularly serves an average of at least 25 individuals daily at least 60 days out of the year. (A public water system is either a *community water supply* or a *non-community water supply*.) Such term includes:

a. any collection, treatment, storage, and distribution facilities under the control of the operator of such system and used primarily in connection with such system; and

b. any collection or pretreatment storage facilities not under such control which are used primarily in connection with such system.

Reservoir—a natural or artificial lake or impoundment for storage of water (either raw or treated) used or proposed to be used for potable purposes.

Sanitary Survey—an onsite review of the water source, facilities, equipment, operation, maintenance, and monitoring compliance of a public water system to evaluate the adequacy of the system, its sources and operations and the distribution of safe drinking water.

Sanitary Well Seal—a suitable threaded, flanged, or welded water-tight cap or compression seal installed at the top of the well casing so as to prevent the entrance of contaminated water or other objectionable material into the well.

Service Connection—the pipe from the water main and/or water meter, water supply system or other source of water supply to the building or structure served.

Significant Deficiency—a defect in design, operation, or maintenance, or a failure or malfunction of the sources, treatment, storage, or distribution system that the state health officer determines to be causing, or has the potential for causing the introduction of contamination into the water delivered to consumers.

Source of Water Supply—any well, spring, cistern, infiltration gallery, stream, reservoir, pond, or lake from which, by any means, water is taken either temporarily or continuously for potable use.

Substantial Renovation—instances when new water treatment units are added to existing water treatment plants or non-serviceable portions of existing water treatment units are reconstructed. In addition, alterations or changes which increase plant capacity are included in this term.

Surface Water—derived from water sources on the surface of the earth such as streams, ponds, lakes, or reservoirs.

Tier 1 Public Notice—the form, manner, timing, and frequency required to notify the public of *National Primary Drinking Water Regulations* violations and/or situations (as well as violations and/or situations of §§913, 1139, 1317, 1507, and 1509) with a significant potential to have serious adverse effects on human health as a result of short-term exposure.

Tier 2 Public Notice—the form, manner, timing, and frequency required to notify the public of all other *National Primary Drinking Water Regulations* violations and/or situations (as well as violations and/or situations of §§913, 1139, 1317, 1507, and 1509) with a potential to have serious adverse effects on human health.

Tier 3 Public Notice—the form, manner, timing, and frequency required to notify the public for all other *National Primary Drinking Water Regulations* violations and/or situations (as well as violations and/or situations of §§913, 1139, 1317, 1507, and 1509) not included in *Tier 1 Public Notice* or *Tier 2 Public Notice*.

Transient Non-Community Water Supply—a non-community water supply that does not regularly serve at least 25 of the same persons over six months per year.

Treatment Technique Requirement—a treatment process/standard which has been established in lieu of a maximum contaminant level when, in the state health officer's judgment, it is not economically or technologically feasible to ascertain the level of a contaminant in water intended for potable purposes.

Vacuum Breaker—a device for relieving a vacuum or partial vacuum formed in a pipeline, thereby preventing back siphonage.

Water Supplier—a person who owns or operates a *water supply system* including, but not limited to, a person who owns or operates a *public water system*.

Water Supply System—the system of pipes or other constructed conveyances, structures and facilities through which water is obtained, treated to make it potable (if

necessary), and then distributed (with or without charge) for *human consumption* or other use.

Water Well (Well)—an artificial excavation that derives water from the interstices of the rocks or soil which it penetrates.

AUTHORITY NOTE: Promulgated in accordance with R.S. 36:258(B), R.S. 36:254(B)(7), R.S. 40:4(A)(8), R.S. 40:4.13(D)(1)(2), R.S. 40:5(A) (2)(3)(5)(6)(17)(20), and R.S. 40:1281.8.

HISTORICAL NOTE: Promulgated by the Department of Health and Hospitals, Office of Public Health, LR 28:1318 (June 2002), amended LR 28:2513 (December 2002), LR 30:1194 (June 2004), LR 30:2326 (October 2004), LR 35:484 (March 2009), LR 35:1240 (July 2009), LR 38:2375 (September 2012), LR 38:2793 (November 2012), LR 38:3232 (December 2012), amended by the Department of Health, Office of Public Health, LR 43:84 (January 2017), LR 44:296 (February 2018), effective August 1, 2018, LR 44:1251 (July 2018), effective August 1, 2018, LR 48:1101 (April 2022).

§103. General Requirements for a Potable Water Supply **[formerly paragraph 12:002-1]**

A. Every potable water supply which is hereafter constructed, or reconstructed, or every existing water supply which the state health officer determines is unsafe, shall be made to comply with the requirements of the Code.

AUTHORITY NOTE: Promulgated in accordance with R.S. 40:4 (A)(8) and R.S. 40:5 (2)(3)(5)(6)(17)(20).

HISTORICAL NOTE: Promulgated by the Department of Health and Hospitals, Office of Public Health, LR 28:1320 (June 2002).

§105. Permit Requirements for a Potable Water Supply **[formerly paragraph 12:002-2]**

A. No public water supply shall be constructed, operated or modified to the extent that the capacity, hydraulic conditions, functioning of treatment processes, or the quality of finished water is affected, without, and except in accordance with, a permit from the state health officer.

B. No public water supply shall be constructed or modified to the extent mentioned above except in accordance with the plans and specifications for the installation which have been approved, in advance, as a part of a permit issued by the state health officer prior to the start of construction or modification.

C. Submission of plans for maintenance and replacement of existing facilities in-kind shall not be required.

1. Interior coating of potable water storage tanks is not considered maintenance and shall be submitted to the state health officer for approval. Submission for pre-approval of materials for minor repairs is allowable.

D. Detailed plans and specifications for the installation for which a permit is requested shall be submitted by the Engineer of Record or the person having responsible charge of a municipally owned public water supply or by the owner of a privately owned public water supply.

E. Effective August 1, 2018, the provisions set forth under LAC 51:XII.111-191 and 201-277, together with any

additional requirements of the state health officer as set forth in this Part, shall be used as the basis of the design of any new public water system or any proposed new construction or modification to an existing public water system. After a permit by the state health officer has been issued, such system/modification shall be constructed, installed and maintained in accordance with said permit.

F. Permits required by this Section and any related letters issued by the state health officer or copy of letters issued to the state health officer concerning the review of related plans and specifications, as well as the related approved plans and specifications themselves, shall be permanently retained by the owner of the public water system including any subsequent or successor owner.

AUTHORITY NOTE: Promulgated in accordance with R.S. 40:4(A)(8), 40:4.13(D)(1)(2) and R.S. 40:5(A)(2)(3)(5)(6)(7)(17)(19).

HISTORICAL NOTE: Promulgated by the Department of Health and Hospitals, Office of Public Health, LR 28:1320 (June 2002), amended LR 38:2376 (September 2012), amended by the Department of Health, Office of Public Health, LR 44:297 (February 2018), effective August 1, 2018, LR 44:1251 (July 2018), effective August 1, 2018.

§107. Provision for Grandfather Systems [formerly paragraph 12-002-3]

A. Permits issued and approvals of plans and specifications granted by the state health officer prior to August 1, 2018 shall remain valid as they pertain to the design of the public water supply, unless the revision of such is determined necessary by the state health officer.

B. Notwithstanding §107.A of this Part, every public water system shall undertake corrective action in accordance with §319.B and C of this Part regarding any significant deficiencies, as defined in §319.D of this Part, identified on a sanitary survey conducted by the state health officer.

C. The owner shall have the burden of proving that a public water system, and any modifications thereto or component parts thereof, was permitted by and conforms to plans and specifications approved by the state health officer.

AUTHORITY NOTE: Promulgated in accordance with R.S. 40:4 (A)(8), 40:4.13D.(1)(2) and R.S. 40:5(A)(2)(3)(5)(6)(7)(17)(19).

HISTORICAL NOTE: Promulgated by the Department of Health and Hospitals, Office of Public Health, LR 28:1320 (June 2002), amended by the Department of Health, Office of Public Health, LR 44:297 (February 2018), effective August 1, 2018.

§109. Requirements for Sources of a Potable Water Supply [formerly paragraph 12-002-4]

A. Water supplied for potable purposes shall be:

1. obtained from a source free from pollution; or
2. obtained from a source adequately protected by natural agencies from the effects of pollution; or
3. adequately protected by artificial treatment.

AUTHORITY NOTE: Promulgated in accordance with R.S. 40:4 (A)(8) and R.S. 40:5 (2)(3)(5)(6)(17)(20).

HISTORICAL NOTE: Promulgated by the Department of Health and Hospitals, Office of Public Health, LR 28:1320 (June 2002).

Subchapter A. Submission of Plans

§111. General Requirements

A. All reports, final plans, specifications, and design criteria required by §105 of this Part shall be submitted at least 60 days prior to the date on which action by the state health officer is desired. Environmental assessments, and permits for construction, to take water, for waste discharges, for stream crossings, etc., may be required from other federal, state, or local agencies.

B. No approval for construction can be issued until final, complete, detailed plans and specifications have been submitted to the state health officer and found to be satisfactory.

C. Documents submitted for formal approval shall include but not be limited to:

1. engineer's report, where applicable;
2. summary of the design criteria;
3. operation requirements, where applicable;
4. general layout;
5. detailed plans;
6. specifications;
7. cost estimates;
8. documentation of adequate source of supply (e.g., water purchase contracts between water supplies, and/or inter-municipal agreements), where applicable;
9. evaluation of technical, managerial, and financial capacity where applicable:
 - a. public water systems are required by the Louisiana Department of Health, Office of Public Health (LDH-OPH) to demonstrate adequate capacity development under LAC 48:V.77, Subchapter B;
 - b. except as may otherwise be required under LAC 48:V.77.Subchapter B., the evaluation for existing public water systems shall include:
 - i. a discussion of the system's current technical capacity along with any project related changes with respect to operator certification requirements and the operator's ability to implement any system changes that may be required upon project completion;
 - ii. a discussion of the system's current overall management and how the system's management will be impacted by the project including but not limited to whether the system has an asset management plan and, if so, how the project components will be incorporated into that plan;
 - iii. a discussion of the water system's overall financial capacity along with user projected water rates including the system's outstanding obligations combined with the anticipated debt from the current project under review and the overall operation and maintenance. If

applicable, the financial capacity discussion should include details of any energy efficiency components included as part of the project along with the estimated long term cost and energy savings associated with them; and

iv. other additional information as required by the state health officer.

AUTHORITY NOTE: Promulgated in accordance with the provisions of R.S. 40:4(A)(8), 40:4.13.D.(1)(2) and 40:5(A)(2)(3)(5)(6)(7)(17).

HISTORICAL NOTE: Promulgated by the Department of Health, Office of Public Health, LR 44:297 (February 2018), effective August 1, 2018.

§113. Engineer's Report

A. The engineer's report for water supply system improvements shall, where applicable, present the following information.

1. General information, including:
 - a. description of the existing water works and sewerage facilities;
 - b. identification of the municipality or area served;
 - c. name and mailing address of the owner or official custodian; and
 - d. imprint of professional engineer's seal or conformance with engineering registration requirements of the Louisiana Professional Engineering and Land Surveying Board.
2. Extent of water supply system, including:
 - a. description of the nature and extent of the area to be served;
 - b. provisions for extending the water supply system to include additional areas;
 - c. appraisal of the future requirements for service, including existing and potential industrial, commercial, institutional, and other water supply needs.
3. Justification of the Project. Where two or more solutions exist for providing public water system facilities, each of which is feasible and practicable, discuss the alternatives. Give reasons for selecting the one recommended, including financial considerations, operational requirements, operator qualifications, reliability, and water quality considerations.
4. Soil, groundwater conditions, and foundation problems, including a description of:
 - a. the character of the soil through which water mains are to be laid;
 - b. foundation conditions prevailing at sites of proposed structures;
 - c. the approximate elevation of ground water in relation to subsurface structures.
5. Water use data, including:
 - a. a description of the population trends as indicated by available records, and the estimated population which

will be served by the proposed water supply system or expanded system 20 years in the future in 5 year intervals or over the useful life of critical structures and/or equipment;

b. present water consumption and the projected average and maximum daily demands, including fire flow demand (Subchapter C);

c. present and/or estimated yield of the sources of supply;

d. unusual occurrences;

e. current percent of unaccounted water for the system and the estimated reduction of unaccounted for water after project completion if applicable, i.e., project is to replace aged water mains, leaking storage, or other improvements that will result in reduced water loss.

6. Flow requirements, including:

a. hydraulic analyses based on flow demands and pressure requirements (see §237.A)

b. fire flows, when fire protection is provided, meeting the recommendations of the Insurance Services Office or other similar agency for the service area involved.

7. Description of the proposed source or sources of water supply to be developed, the reasons for their selection, and provide information as follows:

a. Surface water sources, including:

i. hydrological data, stream flow and weather records;

ii. safe yield, including all factors that may affect it;

iii. maximum flood flow, together with approval for safety features of the spillway and dam from the state health officer;

iv. description of the watershed, noting any existing or potential sources of contamination (such as highways, railroads, chemical facilities, land/water use activities, etc.) which may affect water quality;

v. summarized quality of the raw water with special reference to fluctuations in quality, changing meteorological conditions, etc.

vi. source water protection issues or measures, including erosion and siltation control structures that need to be considered or implemented.

b. Groundwater sources, including:

i. sites considered;

ii. advantages of the site selected;

iii. elevations with respect to surroundings;

iv. probable character of formations through which the source is to be developed;

v. geologic conditions affecting the site, such as anticipated interference between proposed and existing wells;

vi. summary of source exploration, test well depth, and method of construction; placement of liners or screen; test pumping rates and their duration; water levels and specific yield; water quality;

viii. sources of possible contamination such as sewers and sewage treatment/disposal facilities, highways, railroads, landfills, outcroppings of consolidated water-bearing formations, chemical facilities, waste disposal wells, agricultural uses, etc.;

ix. wellhead protection measures being considered (see §169 of this Part).

8. Proposed treatment processes, including:

a. a summary establishing the adequacy of proposed processes and unit parameters for the treatment of the specific water under consideration. Bench scale test, pilot studies, or demonstrations may be required to establish adequacy for some water quality standards.

b. Alternative methods of water treatment and chemical use should be considered as a means of reducing waste handling and disposal problems.

9. Sewerage System Available. Describe the existing sewerage system and sewage treatment works, with special reference to their relationship to existing or proposed water supply system structures which may affect the operation of the water supply system, or which may affect the quality of the supply.

10. Waste disposal, including:

a. Discuss the various wastes from the water treatment plant, their volume, proposed treatment and points of discharge.

b. If discharging to a sanitary sewerage system, verify that the system, including any lift stations, is capable of handling the flow to the sewage treatment works and that the treatment works is capable and will accept the additional loading.

11. Automation, including:

a. supporting data justifying automatic equipment, including the servicing and operator training to be provided.

b. Manual override must be provided for any automatic controls.

c. Highly sophisticated automation may put proper maintenance beyond the capability of the plant operator, leading to equipment breakdowns or expensive servicing. Adequate funding shall be assured for maintenance of automatic equipment.

12. Project sites, including:

a. discussion of the various sites considered and advantages of the recommended ones;

b. the proximity of residences, industries, and other establishments;

c. any potential sources of pollution that may influence the quality of the supply or interfere with effective operation of the water supply system, such as sewage

absorption systems, septic tanks, privies, cesspools, sink holes, sanitary landfills, refuse and garbage dumps, etc.

13. Financing, including:

a. estimated cost of integral parts of the system, broken down by dollar amount or percentages for source development, storage, distribution mains, pumping, transmission mains, treatment, and planning (including all soft costs);

b. detailed estimated annual cost of operation;

c. proposed methods to finance both capital charges and operating expenses.

d. Summarize planning for future needs and services.

AUTHORITY NOTE: Promulgated in accordance with the provisions of R.S. 40:4(A)(8), 40:4.13.D.(1)(2) and 40:5(A)(2)(3)(5)(6)(7)(17).

HISTORICAL NOTE: Promulgated by the Department of Health, Office of Public Health, LR 44:298 (February 2018), effective August 1, 2018.

§115. Plans

A. Plans for water supply system improvements shall, where applicable, provide the following:

1. general layout, including:

a. suitable title;

b. name of municipality, or other entity or person responsible for the water supply;

c. area or institution to be served;

d. scale;

e. north point;

f. datum used;

g. boundaries of the municipality or area to be served;

h. seal, signature and date of the Louisiana licensed professional engineer or in conformance with engineering registration requirements of the Louisiana Professional Engineering and Land Surveying Board;

i. imprint of professional engineer's seal or in conformance with engineering registration requirements of the Louisiana Professional Engineering and Land Surveying Board;

j. legible prints suitable for reproduction;

k. location and size of existing water mains;

1. location and nature of existing water supply structures and appurtenances affecting the proposed improvements, noted on one sheet, if possible;

2. detailed plans, including:

a. stream crossings, providing profiles with elevations of the stream bed and the normal and extreme high and low water levels except where submarine crossings are to be installed by means of directional drilling then the extreme high water level may be omitted;

b. profiles having a horizontal scale of not more than 100 feet to the inch and a vertical scale of not more than 10 feet to the inch, with both scales clearly indicated;

c. location and size of the property to be used for the groundwater development with respect to known references such as roads, streams, section lines, or streets;

d. topography and arrangement of present or planned wells or structures, with contour intervals not greater than two feet;

e. elevations of the highest known flood level, floor of the structure, upper terminal of protective casings and outside surrounding grade, using United States Coast and Geodetic Survey, United States Geological Survey or equivalent elevations where applicable as reference;

f. plat and profile drawings of well construction, showing diameter and depth of drill holes, casing and liner diameters and depths, grouting depths, elevations and other details to describe the proposed well completely. Upon completion submit record drawings reflecting geologic formations and water levels;

g. location of all existing and potential sources of pollution which may affect the water source or, underground treated water storage facilities;

h. size, length, and materials of proposed water mains;

i. location of existing or proposed streets; water sources, ponds, lakes, and drains; storm, sanitary, combined and house sewers; septic tanks, disposal fields and cesspools;

j. schematic flow diagrams and hydraulic profiles showing the flow through various plant units;

k. piping in sufficient detail to show flow through the plant, including waste lines;

l. locations of all chemical storage areas, feeding equipment and points of chemical application (see Subchapter A of Chapter 2 of this Part);

m. all appurtenances, specific structures, equipment, water treatment plant waste disposal units and points of discharge having any relationship to the plans for water mains and/or water supply structures;

n. locations of sanitary or other facilities, such as lavatories, showers, toilets, and lockers, when applicable or required by the state health officer;

o. locations, dimensions, and elevations of all proposed plant facilities;

p. locations of all sampling taps;

q. adequate description of any features not otherwise covered by the specifications.

AUTHORITY NOTE: Promulgated in accordance with the provisions of R.S. 40:4(A)(8), 40:4.13.D.(1).

HISTORICAL NOTE: Promulgated by the Department of Health, Office of Public Health, LR 44:299 (February 2018), effective August 1, 2018.

§117. Specifications

A. Complete, detailed technical specifications for those applicable sanitary components shall be supplied for the proposed project, including:

1. a program for keeping existing water supply facilities in operation during construction of additional facilities so as to minimize interruption of service;

2. laboratory facilities and equipment, including the capacity to perform laboratory analyses of required tests;

3. the number and design of chemical feeding equipment (see §201 and §203 of this Part);

4. procedures for flushing, disinfection and testing, as needed, prior to placing the project in service;

5. materials or proprietary equipment for sanitary or other facilities including any necessary backflow or back-siphonage protection.

AUTHORITY NOTE: Promulgated in accordance with the provisions of R.S. 40:4(A)(8), 40:4.13.D.(1)(2) and 40:5(A)(2)(3)(5)(6)(7)(17).

HISTORICAL NOTE: Promulgated by the Department of Health, Office of Public Health, LR 44:300 (February 2018), effective August 1, 2018.

§119. Design Criteria

A. A summary of complete design criteria for those applicable sanitary components shall be submitted for the proposed project.

B. The summary shall contain but shall not be limited to the following:

1. long-term dependable yield of the source of supply;

2. reservoir surface area, volume, and a volume-versus-depth curve, if applicable;

3. area of watershed, if applicable;

4. estimated average and maximum day water demands for the design period;

5. number of proposed services;

6. fire fighting requirements;

7. flash mix, flocculation and settling basin capacities;

8. retention times;

9. unit loadings;

10. filter area and the proposed filtration rate;

11. backwash rate;

12. chemical feeder capacities and ranges;

13. minimum and maximum chemical application rates.

AUTHORITY NOTE: Promulgated in accordance with the provisions of R.S. 40:4(A)(8), 40:4.13.D.(1)(2) and 40:5(A)(2)(3)(5)(6)(7)(17).

HISTORICAL NOTE: Promulgated by the Department of Health, Office of Public Health, LR 44:300 (February 2018), effective August 1, 2018.

§121. Revisions to Approved Plans

A. Any substantial deviations from approved plans or specifications must be approved by the state health officer before such changes are made.

B. Substantial deviations include, but are not limited to deviations in:

1. capacity;
2. hydraulic conditions; and
3. operating units; the functioning of water treatment processes, or the quality of water to be delivered.

C. Revised plans or specifications should be submitted in time to permit the review and approval of such plans or specifications before any construction work, which will be affected by such changes, is begun.

AUTHORITY NOTE: Promulgated in accordance with the provisions of R.S. 40:4(A)(8), 40:4.13.D.(1)(2) and 40:5(A)(2)(3)(5)(6)(7)(17).

HISTORICAL NOTE: Promulgated by the Department of Health, Office of Public Health, LR 44:300 (February 2018), effective August 1, 2018.

§123. Additional Information Required

A. The state health officer may require additional information which is not part of the construction drawings, such as head loss calculations, proprietary technical data, copies of deeds, copies of contracts, etc.

AUTHORITY NOTE: Promulgated in accordance with the provisions of R.S. 40:4(A)(8), 40:4.13.D.(1)(2) and 40:5(A)(2)(3)(5)(6)(7)(17).

HISTORICAL NOTE: Promulgated by the Department of Health, Office of Public Health, LR 44:300 (February 2018), effective August 1, 2018.

Subchapter B. General Design**§125. Design Basis**

A. The system including the water source and treatment facilities shall be designed for average daily flow of the maximum month.

AUTHORITY NOTE: Promulgated in accordance with the provisions of R.S. 40:4(A)(8), 40:4.13.D.(1)(2) and 40:5(A)(2)(3)(5)(6)(7)(17).

HISTORICAL NOTE: Promulgated by the Department of Health, Office of Public Health, LR 44:300 (February 2018), effective August 1, 2018.

§127. Plant Layout

A. Plant layout, at a minimum, shall consider the following:

1. functional aspects of the plant layout;
2. provisions for future plant expansion;
3. provisions for expansion of the plant waste treatment and disposal facilities;
4. access roads;
5. site grading;
6. site drainage;

7. walks;
8. driveways; and
9. chemical delivery.

AUTHORITY NOTE: Promulgated in accordance with the provisions of R.S. 40:4(A)(8), 40:4.13.D.(1)(2) and 40:5(A)(2)(3)(5)(6)(7)(17).

HISTORICAL NOTE: Promulgated by the Department of Health, Office of Public Health, LR 44:300 (February 2018), effective August 1, 2018.

§129. Building Layout

A. Building layout shall be designed to provide for:

1. adequate ventilation;
2. adequate lighting;
3. adequate heating;
4. adequate drainage;
5. dehumidification equipment, if necessary;
6. accessibility of equipment for operation, servicing, and removal;
7. flexibility of operation;
8. operator safety;
9. convenience of operation; and
10. if rooms are used for chemical storage and feed equipment use of a separate room to reduce hazards and dust problems.

AUTHORITY NOTE: Promulgated in accordance with the provisions of R.S. 40:4(A)(8), 40:4.13.D.(1)(2) and 40:5(A)(2)(3)(5)(6)(7)(17).

HISTORICAL NOTE: Promulgated by the Department of Health, Office of Public Health, LR 44:301 (February 2018), effective August 1, 2018.

§131. Location of Structures

A. The appropriate regulating authority must be consulted regarding any structure which is so located that normal or flood stream flows may be impeded.

AUTHORITY NOTE: Promulgated in accordance with the provisions of R.S. 40:4(A)(8), 40:4.13.D.(1)(2) and 40:5(A)(2)(3)(5)(6)(7)(17).

HISTORICAL NOTE: Promulgated by the Department of Health, Office of Public Health, LR 44:301 (February 2018), effective August 1, 2018.

§133. Electrical and Controls

A. Electrical equipment, electrical instrumentation and controls shall be located above grade, in areas not subject to flooding or protected from damage due to water inundation.

B. The design of all electrical work for new facilities or modifications to existing facilities shall conform to the applicable requirements of the State Uniform Construction Code, LAC 17:I and any other applicable local code(s) which may have stricter requirements.

C. Existing electrical equipment, electrical instrumentation and controls at facilities may remain provided they do not create an unsafe condition and do not

reduce the reliability of the equipment or cause failure to system components.

AUTHORITY NOTE: Promulgated in accordance with the provisions of R.S. 40:4(A)(8), 40:4.13.D.(1)(2) and 40:5(A)(2)(3)(5)(6)(7)(17).

HISTORICAL NOTE: Promulgated by the Department of Health, Office of Public Health, LR 44:301 (February 2018), effective August 1, 2018.

§135. Standby Power

A. Dedicated standby power shall be provided by any community water supply and any non-community water supply serving a hospital so that water can be treated and/or pumped to the distribution system during power outages to meet the average daily demand during the month of maximum water use.

B. Carbon monoxide detectors should be installed where fuel-fired generators are housed.

C. Alternatives to dedicated standby power may be considered by the state health officer with proper justification.

AUTHORITY NOTE: Promulgated in accordance with the provisions of R.S. 40:4(A)(8), 40:4.13.D.(1)(2) and 40:5(A)(2)(3)(5)(6)(7)(17).

HISTORICAL NOTE: Promulgated by the Department of Health, Office of Public Health, LR 44:301 (February 2018), effective August 1, 2018.

§137. Laboratory Facilities

A. Each public water system shall have equipment and facilities or contracted services for the routine daily laboratory testing necessary to ensure the proper operation of the water supply system.

B. Laboratory equipment selection shall be based on:

1. the characteristics of the raw water source;
2. the complexity of the treatment process involved;
3. the contaminants or analytes for which monitoring is required or desired; and
4. the particular laboratory methodology and minimum accuracy to be performed for such contaminants or analytes.

C. Laboratory test kits which simplify procedures for making one or more tests may be acceptable.

D. An operator or chemist qualified to perform the necessary laboratory tests shall be required.

E. Other than those analytes allowed to be analyzed in a LDH-OPH Approved Chemical Laboratory/Drinking Water (see Chapter 15 of this Part), analyses conducted to determine compliance with drinking water regulations shall be performed in a LDH-OPH certified or a U. S. Environmental Protection Agency (EPA) certified laboratory in accordance with the requirements of this Part.

F. Persons designing and equipping laboratory facilities shall confer with the state health officer before beginning the preparation of plans or the purchase of equipment. Methods

for verifying adequate quality assurances and for routine calibration of equipment shall be provided.

G. Testing Equipment. As a minimum, the following laboratory equipment shall be provided.

1. Surface water systems or groundwater under the direct influence of surface water (GWUDISW) systems shall have a nephelometric turbidimeter meeting the requirements of the approved turbidity methods in Chapter 11 of this Part.

2. Each surface water treatment plant or GWUDISW plant utilizing flocculation and sedimentation, including those which lime soften, shall have a pH meter, jar test equipment, and titration equipment for both hardness and alkalinity.

3. Each ion-exchange softening plant, and lime softening plant treating only groundwater shall have a pH meter and titration equipment for both hardness and alkalinity.

4. Each iron and/or manganese removal plant shall have test equipment capable of accurately measuring iron to a minimum of 0.1 milligrams per liter, and/or test equipment capable of accurately measuring manganese to a minimum of 0.05 milligrams per liter.

5. Public water systems which chlorinate shall have test equipment for determining both free and total chlorine residual by the applicable methods listed in Table 1 of §1105.C of this Part.

6. If a public water system adjusts its fluoride level, equipment shall be provided for measuring the quantity of fluoride in the water. Such equipment shall be subject to the approval of the state health officer.

7. Public water systems which feed poly and/or orthophosphates shall have test equipment capable of accurately measuring phosphates from 0.1 to 20 milligrams per liter or to 0.1 to 1.2 times the target dose whichever is less.

8. Public water systems that use chlorine dioxide shall have test equipment for determining both chlorine dioxide and chlorite residual by the applicable methods listed in Chapters 11 and 13 of this Part.

9. Surface water systems, GWUDISW systems, and any groundwater system required to or choosing to achieve a minimum CT value [residual disinfectant concentration ("C") times the contact time ("T") when the pipe, vessel, etc., is in operation] at or before the first customer shall have a method of measuring water temperature using a thermometer or thermocouple with a minimum accuracy of plus or minus 0.5 degrees Celsius (0.5°C).

H. Physical Facilities. Where laboratory facilities are provided each public water system shall provide:

1. sufficient bench space;
2. adequate ventilation;
3. adequate lighting;
4. storage room;

5. laboratory sink; and

6. auxiliary facilities (e.g., restroom facilities available on-site of the in-house lab for the operator, analyst, or chemist running the lab tests; special fire-proof cabinets for storing volatile reagents as may be required by the state fire marshal; special ventilation hoods as may be required by OSHA over the work area; refrigerator; Bunsen burner, stirrers; etc.);

7. air conditioning as deemed necessary.

AUTHORITY NOTE: Promulgated in accordance with the provisions of R.S. 40:4(A)(8), 40:4.13.D.(1)(2) and 40:5(A)(2)(3)(5)(6)(7)(17).

HISTORICAL NOTE: Promulgated by the Department of Health, Office of Public Health, LR 44:301 (February 2018), effective August 1, 2018.

§139. Monitoring Equipment

A. Water treatment plants shall be provided with equipment (including recorders, where applicable) to monitor the water as follows.

1. Plants treating ground water using iron removal and/or ion exchange softening shall have the capability to monitor and record free chlorine residual.

2. Ion exchange plants for nitrate removal shall continuously monitor and record the treated water nitrate level.

AUTHORITY NOTE: Promulgated in accordance with the provisions of R.S. 40:4(A)(8), 40:4.13.D.(1)(2) and 40:5(A)(2)(3)(5)(6)(7)(17).

HISTORICAL NOTE: Promulgated by the Department of Health, Office of Public Health, LR 44:302 (February 2018), effective August 1, 2018.

§141. Sample Taps

A. Sampling facilities shall be provided so that water samples can be obtained from each water source and from appropriate locations in each unit operation of treatment, and from the finished water.

B. Taps shall be consistent with sampling needs and shall not be of the petcock type.

C. Taps used for obtaining samples for bacteriological analysis:

1. shall be: of the smooth-nosed type without interior or exterior threads;

2. shall not be of the mixing type; and

3. shall not have a screen, aerator, or other such appurtenance.

AUTHORITY NOTE: Promulgated in accordance with the provisions of R.S. 40:4(A)(8), 40:4.13.D.(1)(2) and 40:5(A)(2)(3)(5)(6)(7)(17).

HISTORICAL NOTE: Promulgated by the Department of Health, Office of Public Health, LR 44:302 (February 2018), effective August 1, 2018.

§143. Facility Water Supply

A. The water treatment plant’s service connection line and the finished water sample tap line shall both be supplied from a source of finished water at a point where all

chemicals have been thoroughly mixed, and the required disinfectant contact time has been achieved (see §179.C of this Part).

B. In some cases the take off point of the water treatment plant’s own service connection line and the finished water sample tap line may be downstream of the plant itself but at or before the first customer.

C. There shall be no cross-connections between the water treatment plant’s service connection line or the finished water sample tap line and any piping, troughs, tanks, or other treatment units containing wastewater, treatment chemicals, raw or partially treated water.

AUTHORITY NOTE: Promulgated in accordance with the provisions of R.S. 40:4(A)(8), 40:4.13.D.(1)(2) and 40:5(A)(2)(3)(5)(6)(7)(17).

HISTORICAL NOTE: Promulgated by the Department of Health, Office of Public Health, LR 44:302 (February 2018), effective August 1, 2018.

§145. Wall Castings

A. Consideration shall be given to providing extra wall castings built into the structure to facilitate future uses whenever pipes pass through walls of concrete structures.

AUTHORITY NOTE: Promulgated in accordance with the provisions of R.S. 40:4(A)(8), 40:4.13.D.(1)(2) and 40:5(A)(2)(3)(5)(6)(7)(17).

HISTORICAL NOTE: Promulgated by the Department of Health, Office of Public Health, LR 44:302 (February 2018), effective August 1, 2018.

§147. Meters

A. All public water systems shall have an acceptable means of measuring the flow from: each source, the washwater, the recycled water and any blended water of different quality, and the finished water.

AUTHORITY NOTE: Promulgated in accordance with the provisions of R.S. 40:4(A)(8), 40:4.13.D.(1)(2) and 40:5(A)(2)(3)(5)(6)(7)(17).

HISTORICAL NOTE: Promulgated by the Department of Health, Office of Public Health, LR 44:302 (February 2018), effective August 1, 2018.

§149. Piping Color Code

A. Except for those systems that comply with Louisiana Revised Statute 40:4.12, a water supply system shall utilize the color scheme provided in Table 149.B below to facilitate the identification of above ground piping in treatment plants and pumping stations.

Table 149.B Piping Color Code	
Water Lines	
Raw or Recycle	Olive Green
Settled or Clarified	Aqua
Finished or Potable	Dark Blue
Chemical Lines	
Alum or Primary Coagulant	Orange
Ammonia	White
Carbon Slurry	Black
Caustic	Yellow with Green Band
Chlorine (Gas or Solution)	Yellow
Chlorine Dioxide	Yellow with Violet Band
Fluoride	Light Blue with Red Band
Lime Slurry	Light Green

Ozone	Yellow with Orange Band
Phosphate Compounds	Light Green with Red Band
Polymers or Coagulant Aids	Orange with Green Band
Potassium Permanganate	Violet
Soda Ash	Light Green with Orange Band
Sulfuric Acid	Yellow with Red Band
Sulfur Dioxide	Light Green with Yellow Band
Waste Lines	
Backwash Waste	Light Brown
Sludge	Dark Brown
Sewer (Sanitary or Other)	Dark Gray
Other	
Compressed Air	Dark Green
Gas	Red
Reclaimed Water	Purple
Other liquids	Light Gray with a label

B. Any nonpotable water lines considered as plumbing (e.g., piping and outlets conveying nonpotable water within an office building, restroom, or other structure normally served by finished, potable water) and located on the water supply system's property is required to be identified in accordance with the State Uniform Construction Code, LAC 17:1.

C. In lieu of the color coding of pipes as described above, all pipes may be painted similar colors as long as each and every pipe is banded and labeled at 5 foot intervals with the name of the liquid or gas clearly displayed on the pipe. Arrows indicating the direction of flow should be included in this labeling or utilize other methods approved by the state health officer.

AUTHORITY NOTE: Promulgated in accordance with the provisions of R.S. 40:4(A)(8), 40:4.13.D.(1)(2) and 40:5(A)(2)(3)(5)(6)(7)(17).

HISTORICAL NOTE: Promulgated by the Department of Health, Office of Public Health, LR 44:302 (February 2018), effective August 1, 2018.

§151. Disinfection

A. Water from new systems, or from any new part(s) of existing systems shall not be furnished for consumer's use until all wells, pipes, tanks, and equipment which can convey or store potable water are disinfected in accordance with American Water Works Association (AWWA) procedures as required in §§169, 225, and 245 of this Part.

AUTHORITY NOTE: Promulgated in accordance with the provisions of R.S. 40:4(A)(8), 40:4.13.D.(1)(2) and 40:5(A)(2)(3)(5)(6)(7)(17).

HISTORICAL NOTE: Promulgated by the Department of Health, Office of Public Health, LR 44:303 (February 2018), effective August 1, 2018, amended LR 48:1101 (April 2022).

§153. Operation and Maintenance Manual

A. An operation and maintenance manual shall be supplied to the water supply system as part of any proprietary unit installed in the facility.

B. The manual shall provide:

1. a parts list;
2. a parts order form,
3. operator safety procedures; and
4. an operational trouble-shooting section.

AUTHORITY NOTE: Promulgated in accordance with the provisions of R.S. 40:4(A)(8), 40:4.13.D.(1)(2) and 40:5(A)(2)(3)(5)(6)(7)(17).

HISTORICAL NOTE: Promulgated by the Department of Health, Office of Public Health, LR 44:303 (February 2018), effective August 1, 2018.

§155. Operator Instruction

A. Provisions shall be made for operator instruction at the start-up of a plant or pumping station.

AUTHORITY NOTE: Promulgated in accordance with the provisions of R.S. 40:4(A)(8), 40:4.13.D.(1)(2) and 40:5(A)(2)(3)(5)(6)(7)(17).

HISTORICAL NOTE: Promulgated by the Department of Health, Office of Public Health, LR 44:303 (February 2018), effective August 1, 2018.

§157. Safety

A. Consideration shall be given to the safety of water plant personnel and visitors.

B. The design shall comply with all applicable safety codes and regulations that include, but are not limited to, the codes adopted under the authority of Act 12 of the 2005 First Extraordinary Session, State Fire Marshal regulations (see LAC 55:V), National Fire Protection Association (NFPA) standards, and federal Occupational Health and Safety Administration (OSHA) standards.

C. Items to be considered include, but are not limited to, noise arresters, noise protection, confined space entry, protective equipment and clothing, gas masks, safety showers and eye washes, handrails and guards, warning signs, smoke detectors, toxic gas detectors and fire extinguishers.

AUTHORITY NOTE: Promulgated in accordance with the provisions of R.S. 40:4(A)(8), 40:4.13.D.(1)(2) and 40:5(A)(2)(3)(5)(6)(7)(17).

HISTORICAL NOTE: Promulgated by the Department of Health, Office of Public Health, LR 44:303 (February 2018), effective August 1, 2018.

§159. Security

A. Security measures including but not limited to the requirements of §§315.A and 327.A.13 of this Part, shall be installed and instituted.

B. Design measures to help ensure the security of water system facilities shall be incorporated and, as a minimum, shall include a means to lock all exterior doorways, windows, gates and other entrances to source, production, treatment, pumping and water storage facilities.

C. Other measures may include signage, closed circuit monitoring, real-time water quality monitoring, and intrusion alarms, as well as safety measures to prevent tampering with any electronic, computer or other automated system which may operate or assist in the operation of the water supply system.

AUTHORITY NOTE: Promulgated in accordance with the provisions of R.S. 40:4(A)(8), 40:4.13.D.(1)(2) and 40:5(A)(2)(3)(5)(6)(7)(17).

HISTORICAL NOTE: Promulgated by the Department of Health, Office of Public Health, LR 44:303 (February 2018), effective August 1, 2018.

§161. Flood Protection

A. Other than surface water intakes, all critical water supply facilities shall be protected to at least the 100-year flood elevation.

B. The water supply system shall provide high water vehicles, boats, or other acceptable means and methods to be able to access, safely operate, and maintain its critical water supply facilities during floods or other high water events.

AUTHORITY NOTE: Promulgated in accordance with the provisions of R.S. 40:4(A)(8), 40:4.13.D.(1)(2) and 40:5(A)(2)(3)(5)(6)(7)(17).

HISTORICAL NOTE: Promulgated by the Department of Health, Office of Public Health, LR 44:304 (February 2018), effective August 1, 2018.

§163. Design; Other Considerations

A. Consideration shall be given to the design requirements of other federal, state, and local regulatory agencies for items including, but not limited to:

1. energy efficiency;
2. water conservation;
3. environmental impact;
4. safety requirements;
5. special designs for the handicapped;
6. plumbing and electrical codes; and
7. construction in the flood plain.

AUTHORITY NOTE: Promulgated in accordance with the provisions of R.S. 40:4(A)(8), 40:4.13.D.(1)(2) and 40:5(A)(2)(3)(5)(6)(7)(17).

HISTORICAL NOTE: Promulgated by the Department of Health, Office of Public Health, LR 44:304 (February 2018), effective August 1, 2018.

Subchapter C. Source Development**§165. General Requirements**

A. In selecting the source of water supply to be developed, the designing engineer shall prove to the satisfaction of the state health officer and other applicable reviewing authorities that an acceptable source having an adequate quantity of water will be available, and that the water which is to be delivered to the consumers shall be adequately treated, when necessary or required, to meet the current requirements of the state health officer with respect to microbiological, physical, chemical and radiological qualities.

B. Each water supply system should take its raw water from the best available source which is economically reasonable and technically possible.

AUTHORITY NOTE: Promulgated in accordance with the provisions of R.S. 40:4(A)(8), 40:4.13.D.(1)(2) and 40:5(A)(2)(3)(5)(6)(7)(17).

HISTORICAL NOTE: Promulgated by the Department of Health, Office of Public Health, LR 44:304 (February 2018), effective August 1, 2018.

§167. Surface Water

A. A source water protection plan enacted for continued protection of the watershed from potential sources of contamination shall be provided as determined by the state health officer. Surface water includes sources of water supply such as, but not limited to:

1. all streams;
2. tributary streams;
3. drainage basins,
4. natural and man-made ponds and lakes; and
5. artificial reservoirs or impoundments.

B. Surface Water Quantity. The quantity of water at the source shall be adequate to meet the maximum projected water demand of the service area as shown by calculations based on a 1 in 50 year drought or the extreme drought of record, and should include consideration of multiple year droughts. Requirements for minimum flows downstream of the intake shall:

1. comply with requirements of the appropriate reviewing authority/authorities;
2. provide a reasonable surplus for anticipated growth;
3. be adequate to compensate for all losses such as silting, evaporation, seepage, etc; and
4. be adequate to provide ample water for other legal users of the source.

C. Surface Water Quality. A study shall be made of the factors, both natural and man-made, which may affect water quality in the water supply stream, river, lake or reservoir and shall include, but not be limited to:

1. determining possible future uses of impoundments or reservoirs;
2. determining degree of control of watershed by owner;
3. assessing degree of hazard to the supply posed by agricultural, domestic, industrial, or recreational activities in the watershed, which may generate toxic or harmful substances detrimental to treatment processes;
4. assessing all waste discharges (point source and non-point sources) and activities that could impact the water supply. The location of each waste discharge shall be shown on a scale map;
5. obtaining samples over a sufficient period of time to assess the microbiological, physical, chemical and radiological characteristics of the water;
6. assessing the capability of the proposed treatment process to reduce contaminants to applicable standards; and
7. consideration of currents, wind and ice conditions, salt water wedges/intrusion and the effect of confluencing streams.

D. Structures. Structures shall be designed in accordance with the following requirements.

PUBLIC HEALTH—SANITARY CODE

1. The design of intake structures shall provide for:
 - a. withdrawal of water from more than one level if quality varies with depth, as determined by the state health officer;
 - b. separate facilities for release of less desirable water held in storage;
 - c. inspection of manholes every 1000 feet for pipe sizes large enough to permit visual inspection;
 - d. occasional cleaning of the inlet line;
 - e. adequate protection against rupture by dragging anchors, ice, etc.;
 - f. ports located above the bottom of the stream, lake or impoundment, but at sufficient depth to be kept submerged at low water levels;
 - g. where shore wells are not provided, a diversion device capable of keeping large quantities of fish or debris from entering an intake structure; and
 - h. when buried surface water collectors are used, sufficient intake opening area must be provided to minimize inlet headloss. Particular attention should be given to the selection of backfill material in relation to the collector pipe slot size and gradation of the native material over the collector system.

2. Raw water pumping wells shall:

- a. have motors and electrical controls located above grade, and protected from flooding as required by the state health officer;
- b. be accessible;
- c. be designed against flotation;
- d. be equipped with removable or traveling screens before the pump suction well;
- e. provide for introduction of chlorine or other chemicals in the raw water transmission main if necessary for quality control;
- f. have intake valves and provisions for backflushing or cleaning by a mechanical device and testing for leaks, where practical;
- g. have provisions for withstanding surges where necessary; and
- h. be constructed in a manner to prevent intrusion of contaminants.

3. Off Stream Raw Water Storage Reservoirs. An off-stream raw water storage reservoir is a facility into which water is pumped during periods of good quality and high stream flow for future release to treatment facilities. The off-stream raw water storage reservoirs shall be constructed to assure that:

- a. water quality is protected by controlling runoff into the reservoir;
- b. dikes are structurally sound and protected against wave action and erosion;

- c. intake structures and devices meet requirements of §167.D.1;
- d. point of influent flow is separated from the point of withdrawal;
- e. separate pipes are provided for influent to and effluent from the reservoir; and
- f. a bypass line is provided around the reservoir to allow direct pumping to the treatment facilities.

E. Nuisance Plant or Animal. If it is determined that chemical treatment is warranted for the control of nuisance plants or animals treatment shall be in accordance with Subchapter D of Chapter 1 of this Part and shall be acceptable to the state commissioner of agriculture and the state health officer. In addition, the following requirements shall be met.

1. Chemical treatment shall be in accordance with the manufacturer's label and application instructions, the Louisiana Pesticide Law (R.S. 3:3201, et seq.) and its implementing rules and regulations [see LAC Title 7 (Agriculture and Animals), Part XXIII (Pesticides) including, but not limited to, Chapter 31 (Water Protection)], LAC Title 51 (Public Health—Sanitary Code) Part XII (Water Supplies).

2. Chemical treatment shall be performed in such a manner as to prevent a USEPA (or state-equivalent) maximum contaminant level of a primary drinking water contaminant to be exceeded in finished drinking water.

3. Any analyses of finished drinking water to confirm whether or not a USEPA (or state-equivalent) maximum contaminant level of a primary drinking water contaminant has been exceeded shall only be acceptable if the water sample is collected, transported and stored in accordance with USEPA-approved methods [see 40 CFR Part 136.3, Table II] and then analyzed by a LDH - Certified Chemical Laboratory/Drinking Water.

4. In all cases involving a pesticide application for nuisance plant or animal control, when the water being treated is a source of water supply, the final determination of the safety of finished drinking water shall be made exclusively by the state health officer

- a. Facility safety items, including but not limited to ventilation, operator protective equipment, eyewashes/showers, cross connection control, etc. shall be provided;

- b. Solution piping and diffusers shall be installed within the intake pipe or in a suitable carrier pipe.

- c. Provisions shall be made to prevent dispersal of chemical into the water environment outside the intake. Diffusers shall be located and designed to protect all intake structure components;

- d. A spare solution line should be installed to provide redundancy and to facilitate the use of alternate chemicals;

e. The chemical feeder shall be interlocked with plant system controls to shut down automatically when the raw water flow stops;

f. when alternative control methods are proposed for nuisance plant and animal control, appropriate piloting or demonstration studies, satisfactory to the state health officer, may be required.

F. Impoundments and Reservoirs. Site preparation of impoundments and reservoirs shall provide where applicable:

1. removal of brush and trees to high water elevation;
2. protection from floods during construction;
3. abandonment of all wells which will be inundated, in accordance with requirements of the Department of Natural Resources, Office of Conservation, and the state health officer.

AUTHORITY NOTE: Promulgated in accordance with the provisions of R.S. 40:4(A)(8), 40:4.13.D.(1)(2) and 40:5(A)(2)(3)(5)(6)(7)(17).

HISTORICAL NOTE: Promulgated by the Department of Health, Office of Public Health, LR 44:304 (February 2018), effective August 1, 2018.

§169. Groundwater

A. A groundwater source includes all water obtained from:

1. dug;
2. drilled;
3. bored or driven wells;
4. springs; and
5. infiltration lines.

B. Groundwater quantity shall conform to the following standards.

1. Source capacity. The total developed groundwater source capacity, unless otherwise specified by the state health officer, shall equal or exceed the design maximum day demand with the largest producing well out of service.

2. Number of sources. When groundwater is the only source of water supply for any community water supply or for any non-community water supply serving a hospital, a minimum of two approved and active groundwater wells (or, if not a second well, connection to another approved water supply of sufficient capacity) shall be provided, unless otherwise specified by the state health officer.

a. Each of these two groundwater wells (or, if not a second well, connection to another approved water supply of sufficient capacity) shall be maintained and regularly operated to ensure that each one can immediately supply safe drinking water into the system when the other fails.

b. Consideration should be given to locating redundant sources in different aquifers or different locations of an aquifer.

3. Standby power. To ensure continuous service provided by any community water supply and any non-

community water supply serving a hospital when the primary power has been interrupted, a standby power supply shall be provided through a dedicated portable or in-place auxiliary power of adequate supply and connectivity. When automatic pre-lubrication of pump bearings is necessary, and an auxiliary power supply is provided, design shall assure that the pre-lubrication is provided when auxiliary power is in use.

C. Groundwater Quality shall conform to the following standards.

1. An assessment should be made of the factors, both natural and man-made, which may affect water quality in the well and aquifer. Such an assessment may include, obtaining samples over a sufficient period of time to assess the microbiological and physical characteristics of the water including dissolved gases, chemical, and radiological characteristics.

2. Unless LDH-OPH's exclusion criteria are met, a ground water under the direct influence of surface water (GWUDISW) determination acceptable to the state health officer shall be provided for all new wells.

a. Part of this determination shall include the proper submission of one or more 1 micron filters through which at least 500 gallons of produced groundwater being tested have passed at a regulated flow rate over a period of no more than a 24 hours.

b. Such filters shall be refrigerated, as appropriate, and delivered to a laboratory for the identification of insects or other macroorganisms, algae, rotifers and large diameter pathogens such as *Giardia* or *Cryptosporidium* [see USEPA's "Consensus Method for Determining Groundwaters under the Direct Influence of Surface Water Using Microscopic Particulate Analysis (MPA)"].

c. The laboratory utilized shall be recognized by the USEPA for such work and it shall identify such macroorganisms found on the filter and, in the case of *Giardia* or *Cryptosporidium*, whether any observed specimens were alive or dead.

d. In addition, the laboratory report shall indicate the overall risk as being either a low, medium, or high occurrence of such macroorganisms.

e. This information, in combination, with other factors mentioned under the definition of GWUDISW contained in Chapter 11 of this Part, shall be used by the state health officer in determining whether or not a new well will be deemed as a GWUDISW source.

3. Microbiological quality. After disinfection of each new, modified or reconditioned groundwater source, one or more water samples shall be submitted to a LDH-OPH-certified drinking water laboratory for microbiological analysis with satisfactory results reported to the state health officer prior to placing the well into service.

4. Physical, chemical and radiological characteristics. Every new, modified or reconditioned groundwater source shall be examined for applicable physical, chemical and radiological characteristics as required by the state health officer by tests of representative samples in a LDH-OPH

certified drinking water laboratory, with results reported to the state health officer.

a. Samples shall be collected and analyzed at the conclusion of the test pumping procedure.

b. Field determinations of physical and chemical constituents or special sampling procedures may be required by the state health officer.

D. Groundwater location shall conform to the following requirements.

1. Well location. The state health officer shall be consulted prior to design and construction regarding proposed well location as it relates to required separation between existing and potential sources of contamination and groundwater development.

a. All ground water sources of water supply shall comply with the following requirements.

i. The ground surface within a safe horizontal distance of the source in all directions shall not be subject to flooding (as defined in Footnote 4 of a.ii below) and shall be so graded and drained as to facilitate the rapid removal of surface water. This horizontal distance shall in no case be less than 10 feet for potable water supplies.

ii. Every potable water well, and the immediate appurtenances thereto that comprise the well, shall be located at a safe distance from all possible sources of contamination, including but not limited to, privies, cesspools, septic tanks, subsurface tile systems, sewers, drains, barnyards and pits below the ground surface. The horizontal distance from any such possible source of pollution shall be as great as possible, but in no case less than the following minimum distances, except as otherwise approved by the state health officer.

Table 169.D.1.a.ii. Sources of Contamination	Distance in Feet
Septic tanks	50
Storm or sanitary sewer	50 ¹
Cesspools, outdoor privies, oxidation ponds, subsurface absorption fields, pits, mechanical sewage treatment plants, etc.	100 ²
Another water-well	25 ³
Sanitary landfills, feed lots, manure piles, solid waste dumps and similar installations	100
Drainage canal, ditch or stream	50 ⁴

¹This distance may be reduced to 30 feet if the sewer is of ductile iron with water-tight joints or pressure rated plastic pipe.

²For a private water well this distance may be reduced to 50 feet.

³This minimum distance requirement does not take into consideration the effects of interference from pumping nearby wells in the same aquifer.

⁴Horizontally measured from the water's edge to the well at the highest water level which may have occurred in a 10-year period.

iii. No toilet, sewer, soil pipe or drain shall be located above or where leakage therefrom can reach any water storage basin, reservoir or source of water supply.

iv. There shall be no unauthorized pits or unfilled spaces below level of ground surface, any part of which is within 50 feet of such water supply, except properly

constructed well, pump, or valve pits as covered under §329.A.4 of this Part.

v. Earth formations above the water-bearing stratum shall be of such character and depth as to exclude contamination of the source of supply by seepage from the surface of the ground.

b. A well shall be located far enough from a building to allow reworking or rehabilitation with a drilling rig. A well shall not be located below ground surface, such as in pits and basements, and shall not be located within the foundation of a building, except a building constructed solely to house pumping and water system equipment.

c. Groundwater development shall be in conformance with the applicable standards, laws, and regulations of the government agency or agencies having jurisdiction.

2. Continued sanitary protection of the well site from potential sources of contamination shall be provided by having a minimum 50-foot radius of ownership and a minimum 100-foot radius of control from the well head. The radius of control required beyond the minimum 50-foot radius of ownership shall be provided either through ownership, zoning, easements, leasing or other means acceptable to the state health officer which shall be maintained for the life of the well until the well is ultimately properly abandoned.

3. Wellhead Protection. Wellhead protection assessment for continued protection of the wellhead from potential sources of contamination shall be provided as determined by the state health officer.

E. General Well Construction. All wells constructed to serve a potable water supply shall be constructed in accordance with LAC 56, Part I, Water Wells. Drillers of wells that serve a potable water supply shall comply with these requirements pursuant to Louisiana Revised Statutes 38:2226, 38:3098-3098.8. In addition, the following requirements shall be met.

1. Drilling fluids and additives shall:

a. not impart any toxic substances to the water or promote bacterial contamination; and

b. be acceptable to the state health officer.

2. Minimum protected depths of drilled wells shall provide watertight construction to such depth as may be required by the state health officer, to:

a. exclude contamination; and

b. seal off formations that are, or may be, contaminated or yield undesirable water.

3. All well and spring basin casings or curbing shall extend a safe distance below the ground surface. The minimum depth of casings or curbing shall not be less than 50 feet in the case of public water supplies and not less than 10 feet in the case of private water supplies.

4. Polyvinyl Chloride Plastic (PVC). The state health officer may approve the use of PVC casing for all or for

limited applications. PVC casing shall not be used at sites where permeation by hydrocarbons or degradation may occur.

5. **Other Nonferrous Casing Materials.** Approval of the use of any nonferrous material as well casing shall be subject to special determination by the state health officer prior to submission of plans and specifications. Nonferrous material proposed as a well casing must be resistant to the corrosiveness of the water and to the stresses to which it will be subjected during installation, grouting and operation.

6. **Packers.** Packers shall be of material that will not impart taste, odor, toxic substances or bacterial contamination to the well water. Lead packers shall not be used.

7. **Screens.** Screens shall be provided with a bottom plate or washdown bottom fitting of the same material as the screen.

8. **Upper terminal well construction** shall be in accordance with the following requirements.

a. In wells with pipe casings, the casings shall project at least 12 inches above ground level or the top of the cover or floor, and the cover or floor shall slope away from the well casing or suction pipe in all directions.

i. Dug well linings shall extend at least 12 inches above the ground surface and cover installed thereon. The cover shall be watertight, and its edges shall overlap and extend downward at least 2 inches over the walls or curbing of such wells.

ii. In flood-prone areas the top of the casing shall be at least two feet above the 100-year flood elevation, but in no case less than two feet above the ground surface.

b. Where a well house is constructed, the floor surface shall be at least six inches above the final ground elevation.

c. Sites subject to flooding shall be provided with an earth mound to raise the pumphouse floor to an elevation at least two feet above the 100-year flood elevation or other suitable protection as determined by the state health officer.

d. Protection from physical damage shall be provided as required by the state health officer.

e. The upper terminal shall be constructed to prevent contamination from entering the well.

f. Where well appurtenances protrude through the upper terminal, the connections to the upper terminus shall be mechanical or welded connections that are water tight.

9. **Disinfection of every new, modified or reconditioned groundwater source shall:**

a. be provided after completion of work, if a substantial period elapses prior to test pumping or placement of permanent pumping equipment;

b. be provided after placement of permanent pumping equipment; and

c. be done in accordance with AWWA C654 or method approved by the state health officer.

10. **Well Abandonment.** Abandoned water wells and well holes shall be plugged in accordance with LAC 56, Part I, Water Wells.

F. **Testing and records** shall comply with the following requirements.

1. **Yield and Drawdown Tests** shall:

a. be conducted in accordance with a protocol pre-approved by the reviewing authority;

b. be performed on every production well after construction or subsequent treatment and prior to placement of the permanent pump;

c. utilize methods clearly indicated in the project specifications;

d. be performed with a test pump with a capacity at least 1.5 times the flow anticipated at maximum anticipated drawdown;

e. shall provide, as a minimum, for continuous pumping for at least 24 hours at the design pumping rate or until stabilized drawdown has continued for at least six hours when test pumped at 1.5 times the design pumping rate, or as required by the state health officer;

f. provide the following data to be submitted to the state health officer:

i. test pump capacity-head characteristics;

ii. static water level;

iii. depth of test pump setting;

iv. time of starting and ending each test cycle; and

v. the zone of influence for the well or wells;

g. provide a report which details recordings and graphic evaluation of the following at one hour intervals or less as may be required by the state health officer:

i. pumping rate;

ii. pumping water level;

iii. drawdown; and

iv. water recovery rate and levels;

h. at the discretion of the state health officer, more comprehensive testing may be required.

2. **Plumbness and alignment** shall conform to the following requirements.

a. Every well shall be tested for plumbness and alignment in accordance with AWWA Standard for Water Wells (A100).

b. The test method and allowable tolerance shall be clearly stated in the specifications.

c. If the well fails to meet these requirements, it may be accepted by the engineer if it does not interfere with the installation or operation of the pump or uniform placement of grout or affect long term integrity.

3. **Geological data** shall:

a. be determined from samples collected at 5-foot intervals and at each pronounced change in formation;

b. be recorded and submitted to the Louisiana Department of Natural Resources, Office of Conversation (DNR-OC) and the state health officer.

c. be supplemented with a driller's log, accurate geographical location such as latitude and longitude or GIS coordinates, and other information on accurate records of drill hole diameters and depths, assembled order of size and length of casing, screens and liners, grouting depths, formations penetrated, water levels, and location of any blast charges.

4. The owner of each well shall retain all records pertaining to each well, until the well has been properly abandoned.

G. Aquifer Types and Construction Methods. Aquifer types and construction methods shall conform to the following requirements.

1. Criteria for Sand or Gravel Wells

a. If clay or hard pan is encountered above the water bearing formation, the permanent casing and grout shall extend through such materials or at least 50 feet below the original ground elevation, whichever is lower.

b. If a sand or gravel aquifer is overlaid only by permeable soils the permanent casing and grout shall extend to at least 50 feet below original or final ground elevation, whichever is lower. Excavation of topsoil around the well casing should be avoided.

c. If a temporary surface casing is used, it shall be completely withdrawn.

d. If a permanent surface casing is used, it shall be grouted in place.

2. The following requirements shall apply to gravel pack materials.

a. Gravel pack materials shall

i. be sized based on sieve analysis of the formation; and

ii. be well-rounded particles, 95 percent siliceous material, that are smooth and uniform, free of foreign material, properly sized, washed and then disinfected immediately prior to or during placement.

b. Gravel pack installation shall:

i. be in one continuous operation.

ii. provide the material be placed in a manner that prevents segregation and gradation during placement.

c. The annular space between the well screen and the hole shall be adequate to allow proper placement of gravel pack.

d. Gravel refill pipes, when used, shall be Schedule 40 steel pipe incorporated within the pump foundation and terminated with screwed or welded caps at least 12 inches above the pump house floor.

e. Gravel refill pipes located in the grouted annular opening shall be surrounded by a minimum of 1 ½ inches of grout.

f. Gravel pack shall extend above the highest well screen with an allowance for settling.

g. Protection from leakage of grout into the gravel pack or screen shall be provided.

h. Permanent inner casing and outer casings shall meet requirements of §169.E.4 or 5 of this Part.

3. Radial collectors shall conform to the following:

a. Locations of all caisson construction joints and porthole assemblies shall be indicated.

b. The caisson wall shall be reinforced to withstand the forces to which it will be subjected.

c. Radial collectors shall be in areas and at depths approved by the state health officer.

d. Provisions shall be made to assure that radial collectors are essentially horizontal.

e. The top of the caisson shall be covered with a watertight floor.

f. All openings in the floor shall be curbed and protected from entrance of foreign material.

g. The pump discharge piping shall not be placed through the caisson walls. In unique situations where this is not feasible, a water tight seal must be obtained at the wall.

4. Infiltration lines should be considered only where geological conditions preclude the possibility of developing an acceptable drilled well.

a. The area around infiltration lines shall be under the control of the water purveyor for a distance acceptable to or required by the state health officer.

b. Flow in the lines shall be by gravity to the collecting well.

c. Water from infiltration lines shall be considered as groundwater under the direct influence of surface water unless demonstrated otherwise.

5. Limestone or sandstone wells, where the depth of unconsolidated formations is more than 50 feet, the permanent casing shall be firmly seated in uncreviced or unbroken rock.

a. Grouting requirements shall be determined by the state health officer.

b. Where the depth of unconsolidated formations is less than 50 feet, the depth of casing and grout shall be at least 50 feet or as determined by the state health officer.

6. Naturally flowing wells shall require special consideration by the state health officer where there is an absence of an impervious confining layer.

a. Flow shall be controlled. Overflows shall discharge at least 18 inches above grade and flood level, and

be visible. Discharge shall be to an effective drainage structure.

b. Permanent casing and grout shall be provided.

c. If erosion of the confining bed appears likely, special protective construction may be required by the state health officer.

H. Well Pumps, Discharge Piping and Appurtenances. Well pumps, discharge piping and appurtenances shall conform to the following requirements.

1. Line Shaft Pumps. Wells equipped with line shaft pumps shall:

a. have the casing firmly connected to the pump structure or have the casing inserted into a recess extending at least one-half inch into the pump base;

b. have the pump foundation and base designed to prevent water from coming into contact with the joint; and

c. use lubricants that meet NSF International/American National Standards Institute (NSF/ANSI) Standard 60 or use well water itself as a lubricant.

d. All water pumps shall be so constructed and installed as to prevent contamination of the water supply.

i. Where pumps or pump motors are placed directly over the well, the pump or motor shall be supported on a base provided therefor. The well casing shall not be used to support pump or motor. This requirement shall not apply to submersible pumps/motors and single-pipe jet pumps/motors. The pump or motor housing shall have a solid watertight metal base without openings to form a cover for the well, recessed to admit the well casing or pump suction. The well casing or pump suction shall project into the base at least 1 inch above the bottom thereof, and at least 1 inch above the level of the foundation on which the pump rests. The well casing shall project at least 12 inches above ground level or the top of the floor.

ii. Where power pumps are not placed directly over the well, the well casing shall extend at least 12 inches above the floor of the pump house. In flood-prone areas the top of the casing shall extend at least two feet above the 100-year flood elevation, but in no case less than two feet above the ground surface. The annular space between the well casing and the suction pipe shall be closed by a sanitary well seal to prevent the entrance of contamination.

2. Submersible Pumps. Where a submersible pump is used:

a. the top of the casing shall be effectively sealed against the entrance of water under all conditions of vibration or movement of conductors or cables; and

b. the electrical cable shall be firmly attached to the riser pipe at 20 foot intervals or less.

3. Discharge Piping. The design criteria for discharge piping is as follows.

a. The discharge piping shall:

i. be designed to minimize friction loss;

ii. have control valves and appurtenances located above the pumphouse floor when an above-ground discharge is provided;

iii. be protected against the entrance of contamination;

iv. be equipped with a check valve in or at the well, a shutoff valve, a pressure gauge, and a means of measuring flow;

v. be equipped with a smooth nosed sampling tap located at a point before any treatment chemicals are applied. The sample tap shall be at least 18-inches above the floor to facilitate sample collection.

vi. where applicable, be equipped with an air release-vacuum relief valve located upstream from the check valve, with exhaust/relief piping terminating in a down-turned position at least 18 inches above the floor and covered with a 24 mesh corrosion resistant screen;

vii. be valved to permit test pumping and control of each well;

viii. have all exposed piping, valves and appurtenances protected against physical damage and freezing;

ix. be properly anchored to prevent movement, and be properly supported to prevent excessive bending forces;

x. be protected against surge or water hammer;

xi. conform to §235 of this Part; and

xii. be constructed so that it can be disconnected from the well or well pump to allow the well pump to be pulled.

b. The discharge piping should be provided with a means of pumping to waste, but shall not be directly connected to a sewer.

c. For submersible, jet and line shaft pumps, the discharge, drop or column piping inside the well shall:

i. conform to §235 of this Part; where such standards exist, or in the absence of such standards, conform to applicable product standards and be acceptable to the state health officer. Any lubricants, fittings, brackets, tape or other appurtenances shall meet NSF/ANSI Standards 60/61, where applicable; and

ii. be capable of supporting the weight of the pump, piping, water and appurtenances and of withstanding the thrust, torque and other reaction loads created during pumping. The actions of fatigue from repeated starting and stopping of the pump shall be considered when choosing a pipe and fittings.

4. Pitless Well Units. Pitless well units shall conform to the following standards and requirements.

a. The state health officer must be contacted for approval of specific applications of pitless units.

b. Pitless units shall:

- i. be shop-fabricated from the point of connection with the well casing to the unit cap or cover;
 - ii. be threaded or welded to the well casing;
 - iii. be of watertight construction throughout;
 - iv. be of materials and weight at least equivalent and compatible to the casing;
 - v. have field connection to the lateral discharge from the pitless unit of threaded, flanged or mechanical joint connection; and
 - vi. terminate at least 18 inches above final ground elevation or three feet above the 100-year flood level or the highest known flood elevation, whichever is higher, or as the state health officer directs.
- c. The design of the pitless unit shall make provision for:
- i. access to disinfect the well;
 - ii. a properly constructed casing vent meeting the requirements of §169.H.6 of this Part;
 - iii. facilities to measure water levels in the well (see §169.H.7);
 - iv. a cover at the upper terminal of the well that will prevent the entrance of contamination;
 - v. a contamination-proof entrance connection for electrical cable;
 - vi. an inside diameter as great as that of the well casing, up to and including casing diameters of 12 inches, to facilitate work and repair on the well, pump, or well screen; and
 - vii. at least one check valve within the well casing or in compliance with requirements of the state health officer.

d. If the connection to the casing is by field weld, the shop-assembled unit must be designed specifically for field welding to the casing. The only field welding permitted will be that needed to connect a pitless unit to the casing.

5. Pitless Adapters. Pitless adapters may be acceptable at the discretion of the state health officer. The use of any pitless adapter must be pre-approved by the state health officer.

6. Casing Vent. All potable water well casings shall be vented to atmosphere as provided below, with the exception that no vent will be required when single-pipe jet pumps are used.

a. All potable water well vents shall be so constructed and installed as to prevent the entrance of contamination.

b. All vent openings shall be piped water tight to a point not less than 24 inches above the 100-year flood elevation, but in no case less than 24 inches above the ground surface.

i. Such vent openings and extensions thereof shall be not less than 1/2 inch in diameter, covered with a 24

mesh, corrosion resistant screen with extension pipe firmly attached thereto.

ii. The openings of the vent pipes shall face downward and shall be screened to prevent the entrance of foreign matter.

7. Water Level Measurement. Provisions shall be made for periodic measurement of water levels in the completed well.

a. Where pneumatic water level measuring equipment is used it shall be made:

i. using corrosion-resistant materials attached firmly to the drop pipe or pump column; and

ii. in such a manner as to prevent entrance of foreign materials.

8. Liners may be acceptable at the discretion of the state health officer. The use of any liner must be pre-approved by the state health officer.

AUTHORITY NOTE: Promulgated in accordance with the provisions of R.S. 40:4(A)(8), 40:4.13.D.(1)(2) and 40:5(A)(2)(3)(5)(6)(7)(17).

HISTORICAL NOTE: Promulgated by the Department of Health, Office of Public Health, LR 44:305 (February 2018), effective August 1, 2018, amended LR 48:1101 (April 2022).

Subchapter D. Treatment

§171. General Requirements

A. The design of treatment processes and devices shall depend on evaluation of the nature and quality of the particular water to be treated, seasonal variations, the desired quality of the finished water and the mode of operation planned. Facilities shall be planned with future requirements in mind such as: tightened regulatory requirements, ability to obtain funding, potential growth, expansion and deterioration of existing facilities.

AUTHORITY NOTE: Promulgated in accordance with the provisions of R.S. 40:4(A)(8), 40:4.13.D.(1)(2) and 40:5(A)(2)(3)(5)(6)(7)(17).

HISTORICAL NOTE: Promulgated by the Department of Health, Office of Public Health, LR 44:310 (February 2018), effective August 1, 2018.

§173. Microscreening

A. Microscreening is a mechanical treatment process capable of removing suspended matter and organic loading from surface water by straining. It shall not be used in place of filtration or coagulation.

1. Design. Design criteria is as followed.

a. consideration shall be given to the following:

i. nature of the suspended matter to be removed;

ii. corrosiveness of the water;

iii. effect of chemicals used for pre-treatment;

iv. duplication of units for continuous operation during equipment maintenance;

v. provision of automated backwashing

- b. shall provide:
 - i. a durable, corrosion-resistant screen;
 - ii. provisions to allow for by-pass of the screen;
 - iii. protection against back-siphonage when potable water is used for backwashing;
 - iv. proper disposal of backwash waters (See Subchapter F, §§257-275 of this Part).

AUTHORITY NOTE: Promulgated in accordance with the provisions of R.S. 40:4(A)(8), 40:4.13.D.(1)(2) and 40:5(A)(2)(3)(5)(6)(7)(17).

HISTORICAL NOTE: Promulgated by the Department of Health, Office of Public Health, LR 44:310 (February 2018), effective August 1, 2018.

§175. Clarification Design

A. Clarification is generally considered to consist of any process or combination of processes which reduce the concentration of suspended matter in drinking water prior to filtration.

B. Plants designed to treat surface water, groundwater under the direct influence of a surface water, or for the removal of a primary drinking water contaminant shall have the ability to meet the plant's average daily flow of the maximum month with one unit out of service. Design of the clarification process shall:

1. be constructed to permit units to be taken out of service without disrupting operation, and with drains or pumps sized to allow dewatering in a reasonable period of time;
2. provide multiple-stage treatment facilities when required by the state health officer; and
3. minimize hydraulic head losses between units to allow future changes in processes without the need for repumping.

C. Presedimentation. Waters containing high turbidity may require pretreatment, usually sedimentation, with or without the addition of coagulation chemicals.

1. Basin Design. Presedimentation basins should have hopper bottoms or be equipped with continuous mechanical sludge removal apparatus, and provide arrangements for dewatering.

2. Inlet. Incoming water shall be dispersed across the full width of the line of travel as quickly as possible to prevent short-circuiting.

3. Bypass. Provisions for bypassing presedimentation basins shall be included.

4. Detention Time. Detention shall consider removal requirements for the unit.

D. Coagulation. Coagulation refers to a process using coagulant chemicals and mixing by which colloidal and suspended material are destabilized and agglomerated into settleable or filterable flocs, or both. The engineer shall submit the design basis for the velocity gradient (G value) selected, considering the chemicals to be added and water temperature, color and other related water quality

parameters. For surface water plants using direct or conventional filtration, the use of a primary coagulant is required at all times.

1. Mixing. The detention period should be instantaneous, but not longer than thirty seconds with mixing equipment capable of imparting a minimum velocity gradient (G) of at least 750 feet per second per foot (fps/ft). The design engineer should determine the appropriate G value and detention time through jar testing.

2. Equipment. Basins should be equipped with devices capable of providing adequate mixing for all treatment flow rates. Static mixing may be considered where the flow is relatively constant and will be high enough to maintain the necessary turbulence for complete chemical reactions.

3. Location. The coagulation and flocculation basin shall be as close together as practical.

4. Flow shall be determined at the point of coagulant dosing.

E. Flocculation. Flocculation refers to a process to enhance agglomeration or collection of smaller floc particles into larger, more easily settleable or filterable particles through gentle stirring by hydraulic or mechanical means.

1. Basin Design. Inlet and outlet design shall minimize short-circuiting and destruction of floc. Basins shall be designed so that individual basins may be isolated without disrupting plant operation. A drain and/or pumps shall be provided to handle dewatering and sludge removal.

2. Detention. Detention shall account for regulatory requirements for the plant.

3. Equipment. Agitators shall be designed to provide variable peripheral speed of paddles ranging from 0.5 to 3.0 feet per second.

4. Other Designs. Variations or alternate designs can be submitted to the state health officer at any time.

5. Piping. Flocculation and sedimentation basins shall be as close together as practical. The velocity of flocculated water through pipes or conduits to settling basins shall be no less than 0.5 feet per second (fps) and no greater than 1.5 fps. Allowances must be made to minimize turbulence at bends and changes in direction.

F. Sedimentation. Sedimentation refers to a process that allows particles to settle by gravity and typically precedes filtration. The detention time for effective clarification is dependent upon a number of factors related to basin design and the nature of the raw water. The following criteria apply to the design of conventional gravity sedimentation units.

1. A minimum of four hours of settling time shall be provided. This may be reduced to two hours for lime-soda softening facilities treating only groundwater. Reduced detention time may also be approved when equivalent effective settling is demonstrated or when the overflow rate is not more than 0.5 gallons per minute [gpm] per square foot [sqft] (1.2 m/hr).

2. Inlet Devices. Inlets shall be designed to distribute the water equally and at uniform velocities. A baffle should

be constructed across the basin close to the inlet end and should project several feet below the water surface to dissipate inlet velocities and provide uniform flows across the basin.

3. If flow is split, a means of measuring the flow to each train or unit shall be provided.

4. Velocity. The velocity through a sedimentation basin should not exceed 0.5 feet per minute. The basins shall be designed to minimize short-circuiting. Fixed or adjustable baffles shall be provided as necessary to achieve the maximum potential for clarification.

5. If flow is split, it is recommended that a means of modifying the flow to each train or unit be provided.

6. Outlet Devices. Outlet weirs or submerged orifices shall maintain velocities suitable for settling in the basin and minimize short-circuiting. The use of submerged orifices is recommended in order to provide a volume above the orifices for storage when there are fluctuations in flow. Outlet weirs and submerged orifices shall be designed as follows.

a. The rate of flow over the outlet weirs or through the submerged orifices shall not exceed 20,000 gallons per day per foot (250 m³/day/m) of the outlet launder or orifice circumference.

b. Submerged orifices located greater than three feet below the flow line shall be justified.

c. The entrance velocity through the submerged orifices shall not exceed 0.5 feet per second.

7. Overflow. An overflow weir or pipe designed to establish the maximum water level desired on top of the filters shall be provided. The overflow shall discharge by gravity with a free fall. The discharge shall be equipped with monitoring equipment to annunciate the overflow or be installed at a location where the discharge can be observed.

8. Drainage. Sedimentation basins shall be provided with a means for dewatering. Basin bottoms shall slope toward the drain where mechanical sludge collection equipment is not required.

9. Flushing lines or hydrants shall be provided and shall be equipped with backflow prevention devices acceptable to the state health officer.

10. Sludge collection system shall be designed to ensure the collection of sludge from throughout the basin.

11. Sludge removal design shall provide that:

a. sludge pipes shall be not less than three inches in diameter and arranged to facilitate cleaning;

b. entrance to sludge withdrawal piping shall prevent clogging;

c. valves shall be operable from outside the tank;

d. the operator can observe and sample sludge being withdrawn from the unit.

G. Solids Contact Unit. Plants designed to treat surface water, groundwater under the direct influence of surface

water or required to meet primary drinking water standards using solids contact shall have a minimum of two units. The clarifiers shall be designed for the average daily flow of the maximum month such that the plant's design capacity can be met with one unit out of service.

1. Operating equipment shall include:

a. adequate piping with suitable sampling taps or other means to sample sludge located to permit the collection of samples from various depths of the units; and

b. if flow is split, a means of measuring and modifying the flow to each unit.

2. Consideration shall be given to chemical feed location to ensure proper dosing and application.

3. A rapid mix device or chamber ahead of solids contact units may be required by the state health officer to assure proper mixing of the chemicals applied. Mixing devices within the unit shall be constructed to:

a. provide good mixing of the raw water with previously formed sludge particles; and

b. prevent deposition of solids in the mixing zone.

4. Flocculation. Flocculation equipment:

a. shall be adjustable (speed and/or pitch);

b. shall provide for coagulation in a separate chamber or baffled zone within the unit;

c. should provide a flocculation and mixing period of at least 30 minutes.

5. Sludge Concentrators. Large basins should have at least two sumps for collecting sludge located in the central flocculation zone.

6. Sludge removal design shall provide that:

a. sludge pipes are not less than three inches in diameter and so arranged as to facilitate cleaning;

b. entrance to sludge withdrawal piping shall prevent clogging;

c. valves shall be located outside the tank for accessibility, and

d. the operator may observe and sample sludge being withdrawn from the unit.

7. Criteria for backflow protection from cross-connections shall be as follows.

a. Blow-off outlets and drains shall terminate in a location with an acceptable air gap for backflow protection.

b. A backflow prevention device shall be included on potable water lines used to back flush sludge lines.

8. Detention Period. The detention time shall be established on the basis of the raw water characteristics, regulatory requirements and other local conditions that affect the operation of the unit.

9. Water Losses. Units shall be provided with controls to allow for adjusting the rate or frequency of sludge withdrawal.

10. Weirs or orifices. The units should be equipped with either overflow weirs or orifices constructed so that water at the surface of the unit does not travel over 10 feet horizontally to the collection trough.

a. Weirs shall be adjustable, and at least equivalent in length to the perimeter of the tank.

b. Weir loading shall not exceed:

i. 10 gpm per foot of weir length (120 L/min/m) for clarifiers;

ii. 20 gpm per foot of weir length (240 L/min/m) for softeners.

c. Where orifices are used the loading rates per foot of launder rates should be equivalent to weir loadings. Either shall produce uniform rising rates over the entire area of the tank.

11. Upflow Rates. Unless supporting data is submitted to the State Health Officer to justify rates exceeding the following, rates shall not exceed:

a. 1.0 gpm/sqft (2.4 m/hr) at the sludge separation line for units used for clarifiers;

b. 1.75 gpm/sqft (4.2 m/hr) at the slurry separation line, for units used for softeners.

H. Tube or Plate Settlers. Settler units consisting of variously shaped tubes or plates which are installed in multiple layers and at an angle to the flow may be used for sedimentation, following flocculation. Proposals for settler unit clarification must demonstrate satisfactory performance under on-site pilot plant conditions or documentation of full scale plant operation with similar raw water quality conditions as allowed by the state health officer prior to the preparation of final plans and specifications for approval.

1. General design criteria for tube or plate settlers is as follows.

a. Inlet and Outlet Considerations. Design to maintain velocities suitable for settling in the basin and to minimize short-circuiting. Plate units shall be designed to minimize maldistribution across the units.

b. Protection from Freezing. In areas where freezing occurs, consideration shall be given regarding sufficient freeboard.

c. Application Rate for Tubes. A maximum rate of 2 gallon per minute per square foot [gpm/sqft] of cross-sectional area (4.8 m/hr) for tube settlers, unless higher rates are successfully shown through pilot plant or in-plant demonstration studies.

d. Application Rates for Plates. A maximum plate loading rate of 0.5 gpm/sqft (1.2 m/hr), based on 80 percent of the projected horizontal plate area.

e. Flushing lines shall be provided to facilitate maintenance and must be properly protected against backflow or back siphonage.

f. Drain piping from the settler units shall be sized to facilitate a quick flush of the settler units and to prevent flooding other portions of the plant.

g. Placement. Modules shall be placed:

i. in zones of stable hydraulic conditions; and

ii. in areas nearest effluent launders for basins not completely covered by the modules.

h. Inlets and outlets shall conform to §175.F.2 and §175.F.6 of this Part.

i. The support system shall be able to carry the weight of the modules when the basin is drained plus any additional weight to support maintenance.

j. Provisions shall be made to allow the water level to be dropped, and a water or air jet system for cleaning the modules.

I. High Rate Clarification Processes. High rate clarification processes may be approved upon demonstrating satisfactory performance under on-site pilot plant conditions or documentation of full scale plant operation with similar raw water quality conditions as allowed by the state health officer.

AUTHORITY NOTE: Promulgated in accordance with the provisions of R.S. 40:4(A)(8), 40:4.13.D.(1)(2) and 40:5(A)(2)(3)(5)(6)(7)(17).

HISTORICAL NOTE: Promulgated by the Department of Health, Office of Public Health, LR 44:310 (February 2018), effective August 1, 2018.

§177. Filtration Design

A. Rapid Rate Gravity Filters. General design criteria for rapid rate gravity filters is as follows.

1. Pretreatment. The use of rapid rate gravity filters shall require pretreatment.

2. Rate of Filtration. The rate of filtration shall be determined through consideration of such factors as raw water quality, degree of pretreatment provided, filter media, water quality control parameters, and competency of operating personnel. Typical filtration rates range from 2 to 4 gpm/sqft. Maximum filtration rates for plants treating surface waters or ground water under the influence of surface water shall not exceed 3.0 gpm/sqft. For surface water treatment plants or GWUDISW with proposed filtration rates above 3.0 gpm/sqft, data from pilot testing shall be submitted to the state health officer for consideration and approval.

3. Number. Plants employing rapid rate gravity filters shall provide at least two filter units. The filters shall be capable of meeting the plant design capacity at the plants average daily flow of the maximum month with one filter unit removed from service. Where declining rate filtration is provided, the variable aspect of filtration rates, and the number of filters must be considered when determining the design capacity for the filters.

4. Structural Details and Hydraulics. The filter structure shall be designed to provide for:

a. vertical walls within the filter;

PUBLIC HEALTH—SANITARY CODE

- b. no protrusion of the filter walls into the filter media;
- c. head room to permit normal inspection and operation;
- d. minimum depth of filter box of 8.5 feet;
- e. minimum water depth over the surface of the filter media of three feet;
- f. trapped effluent to prevent backflow of air to the bottom of the filters;
- g. prevention of floor drainage in to the filter;
- h. prevention of flooding by providing overflow;
- i. maximum velocity of treated water in pipe and conduits to filters of two feet per second;
- j. cleanouts and straight alignment for influent pipes or conduits where solids loading is heavy, or following lime-soda softening;
- k. washwater drain capacity to carry maximum flow;
- l. handrails or walls around filter banks adjacent to normal walkways; and
- m. construction to prevent cross connections and common walls between potable and non-potable water.

5. Washwater troughs should be constructed to have:

- a. the bottom elevation above the maximum level of expanded media during washing;
- b. a two-inch freeboard at the maximum rate of wash;
- c. the top edge level and all at the same elevation;
- d. spacing so that each trough serves the same number of square feet of filter area;
- e. maximum horizontal travel of suspended particles to reach the trough not to exceed three feet;
- f. means to exclude the loss of media when providing for concurrent air/high rate water backwashing; and
- g. a two-inch freeboard at the main wash water gullet at the maximum rate of wash.

6. Filter Material. The granular filter media shall be in accordance with AWWA B100 and have the following characteristics:

- a. a total depth of not less than 24 inches and generally not more than 30 inches;
- b. a uniformity coefficient of the smallest material not greater than 1.65;
- c. a minimum of 12 inches of media with an effective size range no greater than 0.45 mm to 0.55 mm unless specified otherwise per the following.

i. Anthracite shall have:

(a). an effective size of 0.45 mm - 0.55 mm with uniformity coefficient not greater than 1.65 when used alone;

(b). an effective size of 0.8 mm - 1.2 mm with a uniformity coefficient not greater than 1.7 when used as a cap; and

(c). an effective size for anthracite used as a single media on potable groundwater for iron and manganese removal only shall be a maximum of 0.8 mm (effective sizes greater than 0.8 mm may be approved based upon onsite pilot plant studies or other demonstration acceptable to the state health officer).

ii. Sand shall have:

(a). an effective size of 0.45 mm to 0.55 mm; and

(b). a uniformity coefficient of not greater than 1.65.

iii. High density sand shall have:

(a). an effective size of 0.2 to 0.3 mm;

(b). a uniformity coefficient of not greater than 1.65.

iv. Granular activated carbon (GAC) shall be in accordance with AWWA B604 and the design of shall meet the following:

(a). There shall be provisions for a free chlorine residual and adequate contact time in the water following the filters and prior to distribution (See §177.C and §177.D).

(b). There shall be means for periodic treatment of filter material for control of bacterial and other growth.

(c). Provisions shall be made for frequent replacement or regeneration. Regeneration of GAC shall be in accordance with AWWA B604.

v. Other Media. Other media will be considered based on experimental data and operating experience.

d. Characteristics of support media shall include the following.

i. Torpedo Sand. A three-inch layer of torpedo sand shall be used as a supporting media for filter sand where supporting gravel is used, and shall have:

(a). effective size of 0.8 mm to 2.0 mm; and

(b). uniformity coefficient not greater than 1.7.

ii. Gravel, when used as the supporting media shall consist of cleaned and washed, hard, durable, rounded silica particles and shall not include flat or elongated particles. The coarsest gravel shall be 2.5 inches in size when the gravel rests directly on a lateral system, and shall extend above the top of the perforated laterals. Not less than four layers of gravel shall be provided in accordance with the following size and depth distribution.

Table 175.A.6.e	
Size	Depth
3/32 to 3/16 inches	2 to 3 inches

Size	Depth
3/16 to 1/2 inches	2 to 3 inches
1/2 to 3/4 inches	3 to 5 inches
3/4 to 1 1/2 inches	3 to 5 inches
1 1/2 to 2 1/2 inches	5 to 8 inches

Reduction of gravel depths and other size gradations may be considered upon justification to the state health officer.

7. Filter bottoms and strainer systems. Departures from these standards may be acceptable for high rate filters and for proprietary bottoms. Porous plate bottoms shall not be used where iron or manganese may clog them or with waters softened by lime. The design of manifold-type collection systems shall:

- a. ensure even distribution of washwater and even rate of filtration over the entire area of the filter;
- b. provide the ratio of the area of the final openings of the strainer systems to the area of the filter at 0.003;
- c. provide the total cross-sectional area of the laterals at twice the total area of the final openings;
- d. provide the cross-sectional area of the manifold at 1.5 to 2 times the total area of the laterals;
- e. lateral perforations without strainers shall be directed downward.

8. Filter media wash facilities are required except for filters used exclusively for iron, radionuclides, arsenic or manganese removal. Wash water systems shall be designed with:

- a. water pressure per manufacturer's requirements;
- b. a properly installed vacuum breaker or other approved device to prevent back siphonage if connected to the filtered or finished water system;
- c. rate of flow of 2.0 gallons per minute per square foot of filter area (4.9 m/hr) with fixed nozzles or 0.5 gallons per minute per square foot (1.2 m/hr) with revolving arms if provided.
- d. Air scouring. When provided, general design criteria for air scouring is as follows.
 - i. Air flow for air scouring the filter shall be 3-5 standard cubic feet per minute square foot of filter area (0.9-1.5 m³/min/m²) when the air is introduced in the underdrain; a lower air rate shall be used when the air scour distribution system is placed above the underdrains.
 - ii. When employing concurrent air scour and water back wash a method for avoiding excessive loss of the filter media during backwashing shall be provided.
 - iii. Air scouring shall be followed by a fluidization wash sufficient to re-stratify the media.
 - iv. Air shall be free from contamination.
 - v. Air scour distribution systems should be placed below the media and supporting bed interface; if placed at the interface the air scour nozzles shall be designed to prevent media from clogging the nozzles or entering the air distribution system.

vi. Piping for the air distribution system shall not be flexible hose which will collapse when not under air pressure and shall not be a relatively soft material which may erode at the orifice opening with the passage of air at high velocity.

vii. Air delivery piping shall not pass down through the filter media nor shall there be any arrangement in the filter design which would allow short circuiting between the applied unfiltered water and the filtered water.

viii. The backwash water delivery system must be capable of 15 gallons per minute per square foot of filter surface area (37 m/hr); however, when air scour is provided the backwash water rate must be variable and should not exceed 8 gallons per minute per square foot (20 m/hr) unless operating experience shows that a higher rate is necessary to remove scoured particles from filter media surfaces.

ix. The filter underdrains shall be designed to accommodate air scour piping when the piping is installed in the underdrain.

9. Appurtenances. The following shall be provided for every filter:

- a. a means of sampling influent and effluent water sampling taps;
- b. a meter indicating the instantaneous effluent rate of flow;
- c. where used for surface water, provisions for filtering to waste with appropriate measures for cross connection control;
- d. a flow rate controller capable of providing gradual rate increases when placing the filters back into operation; and
- e. for surface water or systems using ground water under the direct influence of surface water with three or more filters, on-line turbidimeters shall be installed on the effluent line from each filter. All turbidimeters shall consistently determine and indicate the turbidity of the water in NTUs. Each turbidimeter shall report to a recorder that is designed and operated to allow the operator to accurately determine the turbidity at least once every 15 minutes. Turbidimeters on individual filters should be designed to accurately measure low-range turbidities and have an alarm that will sound when the effluent level exceeds regulatory turbidity limits. It is recommended that turbidimeters be placed in a location that also allows measurement of turbidity during filter to waste.

10. Backwash. Provisions shall be made for washing filters as follows.

- a. a minimum rate necessary to provide for a 50 percent expansion of the filter bed shall be provided with a minimum of 15 gpm/sqft. A reduced rate of 10 gallons per minute per square foot (24 m/hr) may be acceptable for full depth anthracite or granular activated carbon filters;
- b. filtered water shall be used for backwashing filters except in the application of GAC filters for removing formed disinfection by-products;

c. washwater pumps shall be in duplicate except in the application of GAC filters or an alternate means of obtaining washwater is available;

d. a washwater regulator or valve on the main washwater line to obtain the desired rate of filter wash with the washwater valves on the individual filters open wide;

e. a flow meter, preferably with a totalizer, on the main washwater line located so that it can be easily read by the operator during the washing process;

f. design to prevent rapid changes in backwash water flow;

g. automated systems shall be adjustable; and

h. appropriate measures for cross-connection control.

B. Rapid Rate Pressure Filters. The normal use of these filters is for iron and manganese removal. For raw water with iron concentration of 2 mg/L or greater consideration should be given to pretreatment prior to filtration. Pressure filters shall not be used in the filtration of surface or other polluted waters or following lime-soda softening.

1. Minimum criteria relative to rate of filtration, structural details and hydraulics, filter media, etc., provided for rapid rate gravity filters also apply to pressure filters where appropriate. At least two filter units shall be provided. The filters shall be capable of meeting the average daily flow of the maximum month with one filter unit removed from service.

2. Rate of Filtration. The rate shall not exceed six gallons per minute per square foot of filter area except where manufacturer's performance studies of the unit have demonstrated to the satisfaction of the state health officer that higher filtration rates are achievable. Consideration shall be given to backwash frequency and deteriorating water quality when selecting the filtration rate.

3. The filters shall be designed to provide for:

a. loss of head gauges on the inlet and outlet pipes of each filter;

b. an easily readable meter or flow indicator on each battery of filters;

c. filtration and backwashing of each filter individually;

d. minimum side wall shell height of five feet for vertical filters. A corresponding reduction in side wall height is acceptable where proprietary bottoms permit reduction of the gravel depth;

e. the top of the washwater collectors to be at least 18 inches above the surface of the media;

f. the underdrain system to efficiently collect the filtered water and to uniformly distribute the backwash water at a rate not less than 15 gallons per minute per square foot of filter area;

g. backwash flow indicators and controls that are easily readable while operating the control valves;

h. an air release valve on the highest point of each filter;

i. an accessible manhole of adequate size to facilitate inspection and repairs for filters 36 inches or more in diameter. Manholes should be at least 24 inches in diameter where feasible;

j. means to observe the wastewater during backwashing; and

k. construction to prevent cross-connection.

C. Diatomaceous Earth Filtration. The use of these filters may be considered for application to surface waters with low turbidity and low bacterial contamination.

1. Conditions of Use. Diatomaceous earth filters are expressly excluded from consideration for the following conditions:

a. bacteria removal;

b. color removal;

c. turbidity removal where either the gross quantity of turbidity is high or the turbidity exhibits poor filterability characteristics; and

d. filtration of waters with high algae counts.

2. Pilot Plant Study. Installation of a diatomaceous earth filtration system shall be preceded by a pilot plant study on the water to be treated.

a. Conditions of the study such as duration, filter rates, head loss accumulation, slurry feed rates, turbidity removal, bacteria removal, etc., must be approved by the state health officer prior to the study.

b. Satisfactory pilot plant results must be obtained prior to preparation of final construction plans and specifications.

c. The pilot plant study must demonstrate the ability of the system to meet applicable drinking water standards at all times.

3. Types of Filters. Pressure or vacuum diatomaceous earth filtration units will be considered for approval. However, the vacuum type is preferred for its ability to accommodate a design which permits observation of the filter surfaces to determine proper cleaning, damage to a filter element, and adequate coating over the entire filter area.

4. Treated water storage capacity in excess of normal requirements shall be provided to:

a. allow operation of the filters at a uniform rate during all conditions of system demand at or below the approved filtration rate, and

b. guarantee continuity of service during adverse raw water conditions without by-passing the system.

5. Number of Units. At least two units shall be provided. Where only two units are provided, each shall be capable of meeting the plant design capacity (normally the projected maximum daily demand) at the approved filtration

rate. Where more than two filter units are provided, the filters shall be capable of meeting the plant design capacity at the approved filtration rate with one filter removed from service.

6. Pre-coating criteria includes the following.

a. Application. A uniform precoat shall be applied hydraulically to each septum by introducing a slurry to the tank influent line and employing a filter-to-waste or recirculation system.

b. Quantity. Diatomaceous earth in the amount of 0.2 pounds per square foot of filter area (0.98 kg/m²) or an amount sufficient to apply a 1/8 inch coating should be used with recirculation.

7. A body feed system to apply additional amounts of diatomaceous earth slurry during the filter run is required to avoid short filter runs or excessive head losses.

a. Rate of body feed is dependent on raw water quality and characteristics and shall be determined in the pilot plant study.

b. Operation and maintenance can be simplified by providing accessibility to the feed system and slurry lines.

c. Continuous mixing of the body feed slurry is required.

8. Filtration criteria includes the following.

a. Rate of Filtration. The recommended nominal rate is 1.0 gallon per minute per square foot of filter area (2.4 m/hr) with a recommended maximum of 1.5 gallons per minute per square foot (3.7 m/hr). The filtration rate shall be controlled by a positive means.

b. Head Loss. The head loss shall not exceed 30 psi (210 kPa) for pressure diatomaceous earth filters, or a vacuum of 15 inches of mercury (51 kPa) for a vacuum system.

c. Recirculation. A recirculation or holding pump shall be employed to maintain differential pressure across the filter when the unit is not in operation in order to prevent the filter cake from dropping off the filter elements. A minimum recirculation rate of 0.1 gallon per minute per square foot of filter area (0.24 m/hr) shall be provided.

d. Septum or Filter Element. The filter elements shall be structurally capable of withstanding maximum pressure and velocity variations during filtration and backwash cycles, and shall be spaced such that no less than one inch is provided between elements or between any element and a wall.

e. Inlet Design. The filter influent shall be designed to prevent scour of the diatomaceous earth from the filter element.

9. Backwash. A satisfactory method to thoroughly remove and dispose of spent filter cake shall be provided (see Subchapter F. §§257-275 of this Part).

10. The following appurtenances shall be provided for every filter:

- a. a means of sampling for raw and filtered water;

- b. loss of head or differential pressure gauge;
- c. rate-of-flow indicator, preferably with totalizer;
- d. a throttling valve used to reduce rates below normal during adverse raw water conditions;
- e. evaluation of the need for body feed, recirculation, and any other pumps, in accordance with §217 of this Part; and
- f. provisions for filtering to waste with appropriate measures for backflow prevention.

D. Slow Sand Filters. The use of these filters shall require prior engineering studies to demonstrate the adequacy and suitability of this method of filtration for the specific raw water supply.

1. Quality of Raw Water. Slow rate gravity filtration shall be limited to waters having maximum turbidities of 10 units and maximum color of 15 units; such turbidity shall not be attributable to colloidal clay. Microscopic examination of the raw water shall be made to determine the nature and extent of algae growths and their potential adverse impact on filter operations.

2. Number. At least two units shall be provided. Where only two units are provided, each shall be capable of meeting the plant design capacity (normally the projected maximum daily demand) at the approved filtration rate. Where more than two filter units are provided, the filters shall be capable of meeting the plant design capacity at the approved filtration rate with one filter removed from service.

3. Structural Details and Hydraulics. Slow rate gravity filters shall be so designed as to provide:

- a. headroom to permit normal movement by operating personnel for scraping and sand removal operations;
- b. adequate access hatches and access ports for handling of sand and for ventilation; and
- c. an overflow at the maximum filter water level.

4. Rates of Filtration. The permissible rates of filtration shall be determined by the quality of the raw water and shall be on the basis of experimental data derived from the water to be treated. The nominal rate may be 45 to 150 gallons per day per square foot of sand area (1.8 - 6.1 m/day), with somewhat higher rates acceptable when demonstrated to the satisfaction of the approving authority.

5. Underdrains. Each filter unit shall be equipped with a main drain and an adequate number of lateral underdrains to collect the filtered water. The underdrains shall be placed as close to the floor as possible and spaced so that the maximum velocity of the water flow in the underdrain will not exceed 0.75 feet per second. The maximum spacing of laterals shall not exceed 3 feet if pipe laterals are used.

6. Filter material criteria shall be as follows.

- a. Filter sand shall be placed on graded gravel layers for a minimum depth of 30 inches.

b. The effective size shall be between 0.15 mm and 0.30 mm. Larger sizes may be considered by the state health officer.

c. The uniformity coefficient shall not exceed 2.5.

d. The sand shall be cleaned and washed free from foreign matter.

e. The sand shall be rebedded when scraping has reduced the bed depth to no less than 19 inches. Where sand is to be reused in order to provide biological seeding and shortening of the ripening process, rebedding shall utilize a "throw over" technique whereby new sand is placed on the support gravel and existing sand is replaced on top of the new sand.

7. Filter Gravel. The supporting gravel should be similar to the size and depth distribution provided for rapid rate gravity filters (see §177.A.6.d.ii of this Part).

8. Depth of Water on Filter Beds. Design shall provide a depth of at least three to six feet of water over the sand. Influent water shall not scour the sand surface.

9. Control Appurtenances. Each filter shall be equipped with:

a. means of sampling influent and effluent water;

b. an indicating loss of head gauge or other means to measure head loss;

c. an indicating rate-of-flow meter. A means of controlling the rate of filtration and limiting the rate of filtration to a maximum rate shall be provided;

d. provisions for filtering to waste with appropriate measures for cross connection control; and

e. an effluent pipe designed to maintain the water level above the top of the filter sand.

10. [Ripening] Slow sand filters shall be operated to waste after scraping or rebedding during a ripening period until the filter effluent turbidity falls to consistently below the regulated drinking water standard established for the system.

E. Direct Filtration. Direct filtration, as used herein, refers to the filtration of a surface water following chemical coagulation and possibly flocculation but without prior settling. The nature of the treatment process will depend upon the raw water quality. A full scale direct filtration plant shall not be constructed without prior pilot studies which are acceptable to the state health officer. In-plant demonstration studies may be appropriate where conventional treatment plants are converted to direct filtration. Where direct filtration is proposed, an engineering report shall be submitted prior to conducting pilot plant or in-plant demonstration studies.

1. Engineering Report

a. In addition to the items considered in §113 of this Part, "Engineering Report", the report shall include a historical summary of meteorological conditions and of raw water quality with special reference to fluctuations in quality, and possible sources of contamination. The

following raw water parameters shall be evaluated in the report:

i. color;

ii. turbidity;

iii. bacterial concentration;

iv. microscopic biological organisms;

v. temperature;

vi. total solids;

vii. general inorganic chemical characteristics; and

viii. additional parameters as required by the state health officer.

b. The report shall also include a description of methods and work to be done during a pilot plant study or, where appropriate, an in-plant demonstration study.

2. Pilot Plant Studies. After approval of the engineering report and pilot plant protocol, a pilot study or in-plant demonstration study shall be conducted. The study must be conducted over a sufficient time to treat all expected raw water conditions throughout the year. The pilot plant filter must be of a similar type and operated in the same manner as proposed for full scale operation. The pilot study must determine the contact time necessary for optimum filtration for each coagulant proposed. The study shall emphasize but not be limited to, the following items:

a. chemical mixing conditions including shear gradients and detention periods;

b. chemical feed rates;

c. use of various coagulants and coagulant aids;

d. flocculation conditions;

e. filtration rates;

f. filter gradation, types of media and depth of media;

g. filter breakthrough conditions;

h. adverse impact of recycling backwash water due to solids, algae, trihalomethane formation and similar problems;

i. length of filter runs;

j. length of backwash cycles;

k. quantities and make-up of the wastewater.

Prior to the initiation of design plans and specifications, a final report including the engineer's design recommendations shall be submitted to the state health officer.

3. Pretreatment. The final coagulation and flocculation basin design should be based on the pilot plant or in-plant demonstration studies augmented with applicable portions of §175.D, "Coagulation" and §175.E, "Flocculation" of this Part.

4. Filtration. Filters shall be rapid rate gravity filters with dual or mixed media. The final filter design shall be

based on the pilot plant or in-plant demonstration studies and all portions of §177.A "Rapid rate gravity filters" of this Part. Pressure filters or single media sand filters shall not be used.

5. Appurtenances. The following shall be provided for every filter:

- a. influent and effluent sampling taps;
- b. an indicating loss of head gauge;
- c. a meter indicating instantaneous rate of flow;
- d. where used for surface water, provisions for filtering to waste with appropriate measures for cross connection control;
- e. measures for providing gradual rate increases when placing the filters back into operation; and
- f. for systems with three or more filters, on-line turbidimeters shall be installed on the effluent line from each filter. All turbidimeters shall consistently determine and indicate the turbidity of the water in NTUs. Each turbidimeter shall report to a recorder that is designed and operated to allow the operator to accurately determine the turbidity at least once every 15 minutes. Turbidimeters on individual filters should be designed to accurately measure low-range turbidities and have an alarm that will sound when the effluent level exceeds 0.3 NTU.

F. Deep Bed Rapid Rate Gravity Filters. Deep bed rapid rate gravity filters, as used herein, generally refers to rapid rate gravity filters with filter material depths equal to or greater than 48 inches. Filter media sizes are typically larger than those listed in §177.A.6.d of this Part.

1. Deep bed rapid rate filters may be considered based on pilot studies pre-approved by the state health officer.

2. The final filter design shall be based on the pilot plant studies and shall comply with all applicable portions of §177.A. of this Part. Careful attention shall be paid to the design of the backwash system which usually includes simultaneous air scour and water backwash at subfluidization velocities.

G. Biologically Active Filters. Biologically active filtration, as used herein, refers to the filtration of surface water (or a ground water with iron, manganese, ammonia or significant natural organic material) which includes the establishment and maintenance of biological activity within the filter media.

1. Objectives of biologically active filtration may include control of disinfection byproduct precursors, increased disinfectant stability, reduction of substrates for microbial regrowth, breakdown of small quantities of synthetic organic chemicals, reduction of ammonia-nitrogen, and oxidation of iron and manganese. Biological activity can have an adverse impact on turbidity, particle and microbial pathogen removal, disinfection practices; head loss development; filter run times and distribution system corrosion. Design and operation should ensure that aerobic conditions are maintained at all times. Biologically active filtration often includes the use of ozone as a pre-oxidant/disinfectant which breaks down natural organic materials into biodegradable organic matter and granular

activated carbon filter media which may promote denser biofilms.

2. Biologically active filters may be considered based on pilot studies pre-approved by the state health officer. The study objectives must be clearly defined and must ensure the microbial quality of the filtered water under all anticipated conditions of operation.

a. The pilot study shall be of sufficient duration to ensure establishment of full biological activity. The pilot study shall establish empty bed contact time, biomass loading, and/or other parameters necessary for successful operation as required by the state health officer.

3. The final filter design shall be based on the pilot plant studies and shall comply with all applicable portions of §177.A. of this Part.

AUTHORITY NOTE: Promulgated in accordance with the provisions of R.S. 40:4(A)(8), 40:4.13.D.(1)(2) and 40:5(A)(2)(3)(5)(6)(7)(17).

HISTORICAL NOTE: Promulgated by the Department of Health, Office of Public Health, LR 44:313 (February 2018), effective August 1, 2018, amended LR 48:1102 (April 2022).

§179. Disinfection

A. Disinfection may be accomplished with gas and liquid chlorine, calcium or sodium hypochlorites, chlorine dioxide, chloramines, ozone, or ultraviolet light. Other disinfecting agents will be considered, providing reliable application equipment is available and testing procedures for a residual are recognized in "Standard Methods for the Examination of Water and Wastewater,". Disinfection is required for all water systems in accordance with §355 and §357 of this Part, other than those public water systems holding a valid disinfection variance in accordance with §361 of this Part.

B. Chlorination. Design criteria for chlorination shall be as follows.

1. Chlorination Equipment Type. Solution-feed gas chlorinators or hypochlorite feeders of the positive displacement type shall be provided. (see §§201-209 "Chemical Application" of this Part).

2. Capacity. The chlorinator capacity shall be sufficient to comply with minimum chlorine residuals required in §355 and §357 of this Part. The equipment shall be of such design that it will operate accurately over the desired feeding range.

3. Standby Equipment. Standby equipment shall be available to replace/repair a critical unit unless an alternative is approved by the state health officer. Spare parts shall be readily available to replace parts subject to wear and breakage. If there is a large difference in feed rates between routine and emergency dosages, a gas metering tube should be provided for each dose range to ensure accurate control of the chlorine feed.

4. Automatic Switch-Over. Automatic switch-over of chlorine cylinders shall be provided to assure continuous disinfection.

5. Eductor. Each eductor shall be selected for the point of application with particular attention given to the quantity of chlorine to be added, the maximum injector water flow,

the total discharge back pressure, the injector operating pressure, and the size of the chlorine solution line. Gauges for measuring water pressure and vacuum at the inlet and outlet of each eductor should be provided.

6. **Injector/Diffuser.** The chlorine solution injector/diffuser shall be compatible with the point of application to provide a rapid and thorough mix with all the water being treated.

C. Criteria for Contact Time and Point of Application

1. Due consideration shall be given to the contact time of the disinfectant in water with relation to pH, ammonia, taste-producing substances, temperature, bacterial quality, disinfection byproduct formation potential and other applicable factors. The disinfectant should be applied at a point which will provide adequate contact time (CT). All basins used for disinfection shall be designed to minimize short circuiting.

2. For treating surface waters and groundwaters under the direct influence of surface water, the system shall be designed to meet the CT standards set in Chapter 11 of this Part.

D. **Residual Chlorine.** Systems shall be designed to meet the minimum disinfectant residual per §355 and §357 of this Part.

E. **Testing Equipment.** Testing equipment used for compliance monitoring shall comply with approved analytical methods set forth in this Part.

F. **Chlorinator Piping.** Design criteria for chlorinator piping shall be as follows.

1. **Cross-Connection Protection.** The chlorinator water supply piping shall be designed to prevent contamination of the treated water supply in accordance with the backflow prevention requirements set forth in §§344 and 346 of this Part.

2. **Pipe Material.** The pipes carrying elemental liquid or dry gaseous chlorine under pressure shall be Schedule 80 seamless steel tubing or other materials recommended by the Chlorine Institute. PVC is not acceptable upstream of the vacuum regulator. Vacuum piping for gaseous chlorine shall be polyethylene tubing or Schedule 80 PVC pipe. Rubber, Schedule 80 PVC, or polyethylene shall be used for chlorine solution piping and fittings.

G. **Chloramination.** Chloramination is an application of ammonia and chlorine at a proper mass ratio of chlorine to ammonia to produce a combined chlorine residual predominantly in form of monochloramine. Proper chlorine to ammonia ratio shall be maintained to prevent the formation of dichloramine and trichloramine which create taste and odor in drinking water.

1. **Type.** The chlorine system shall comply with the applicable requirements of §179.B. Ammonia systems shall supply either anhydrous ammonia, ammonium sulfate or aqua ammonia in compliance with the requirements of §§201-209 “Chemical Application” of this Part.

2. **Capacity.** The ammonia supply system shall have sufficient capacity to comply with minimum disinfectant residuals required in §355 and §357 of this Part. The equipment shall be of such design that it will operate accurately over the desired feeding range.

3. **Standby Equipment.** Standby equipment shall be available to replace/repair a critical unit. Spare parts shall be made available to replace parts subject to wear and breakage.

4. **Injector/Diffuser.** The ammonia injector/diffuser shall be compatible with the point of application to provide a rapid and thorough mix with all the water being treated. If injectors are used, provisions for scale formation shall be considered.

a. Ammonia solution shall be fed through injectors/diffusers made of appropriate material installed per manufacturer’s recommendations for even distribution of the solution. Materials containing copper shall not be used in contact with the ammonia.

5. **Cross-Connection Protection.** The aqua ammonia water supply piping shall be designed to prevent contamination of the treated water supply in accordance with the backflow prevention requirements set forth in §§344 and 346 of this Part.

6. **Pipe Material.** The pipes carrying anhydrous ammonia shall be black iron or stainless steel. Aqua (Aqueous) ammonia or ammonium sulfate piping shall be stainless steel, polyethylene tubing or schedule 80 PVC. Stainless steel, rubber, polyethylene tubing or PVC shall be used for aqueous ammonia solution piping and fittings.

H. Ozone

1. Design considerations include the following.

a. Ozonation systems are generally used for the purpose of disinfection, oxidation and microflocculation.

b. Bench scale studies shall be conducted to determine minimum and maximum ozone dosages for disinfection “CT” compliance and oxidation reactions. More involved pilot studies shall be conducted when necessary to document benefits and DBP precursor removal effectiveness. Consideration shall be given to multiple points of ozone addition. Pilot studies shall be conducted for all surface waters. Particularly sensitive measurements include gas flow rate, water flow rate, and ozone concentration.

c. Following the use of ozone, the application of a disinfectant which maintains a measurable residual will be required in order to ensure bacteriologically safe water is carried throughout the distribution system.

d. Furthermore, because of the more sophisticated nature of the ozone process a higher degree of operator maintenance skills and training is required. The ability to obtain qualified operators must be evaluated in selection of the treatment process. The necessary operator training shall be provided prior to plant startup. An operation and maintenance manual shall be provided and maintained onsite while the ozone unit is in operation.

2. Feed Gas Preparation. General design criteria for feed gas preparation shall be as follows.

a. Feed gas can be air, oxygen enriched air, or high purity oxygen. Sources of high purity oxygen include purchased liquid oxygen; on site generation using cryogenic air separation; or temperature, pressure or vacuum swing (adsorptive separation) technology. For high purity oxygen-feed systems, dryers typically are not required.

i. Air handling equipment on conventional low pressure air feed systems shall consist of an air compressor, water/air separator, refrigerant dryer, heat reactivated desiccant dryer, and particulate filters. Some "package" ozonation systems for small plants may work effectively operating at high pressure without the refrigerant dryer and with a "heat-less" desiccant dryer. The maximum dew point of -76°F (-60°C) will not be exceeded at any time.

b. Air compression. Design criteria for air compression shall be as follows.

i. Air compressors shall be of the liquid-ring or rotary lobe, oil-less, positive displacement type for smaller systems or dry rotary screw compressors for larger systems.

ii. The air compressors shall have the capacity to simultaneously provide for maximum ozone demand, provide the air flow required for purging the desiccant dryers (where required) and allow for standby capacity.

iii. Air feed for the compressor shall be drawn from a point protected from rain, condensation, mist, fog and contaminated air sources to minimize moisture and hydrocarbon content of the air supply.

iv. A compressed air after-cooler and/or entrainment separator with automatic drain shall be provided prior to the dryers to reduce the water vapor.

v. A back-up air compressor must be provided so that ozone generation is not interrupted in the event of a break-down.

c. Air drying. Design criteria for air drying shall be as follows.

i. Dry, dust-free and oil-free feed gas must be provided to the ozone generator. Dry gas is essential to prevent formation of nitric acid, to increase the efficiency of ozone generation and to prevent damage to the generator dielectrics. Sufficient drying to a maximum dew point of -76°F (-60°C) shall be provided at the end of the drying cycle.

ii. Drying for high pressure systems may be accomplished using heatless desiccant dryers only. For low pressure systems, a refrigeration air dryer in series with heat-activated desiccant dryers shall be used.

iii. A refrigeration dryer capable of reducing inlet air temperature to 40°F (4°C) shall be provided for low pressure air preparation systems.

iv. For heat-activated desiccant dryers, the unit shall contain two desiccant filled towers complete with pressure relief valves, two four-way valves and a heater. External type dryers shall have a cooler unit and blowers. The size of the unit shall be such that the specified dew point

will be achieved during a minimum adsorption cycle time of 16 hours while operating at the maximum expected moisture loading conditions.

v. Multiple air dryers shall be provided so that the ozone generation is not interrupted in the event of dryer breakdown.

vi. Each dryer shall be capable of venting "dry" gas to the atmosphere, prior to the ozone generator, to allow start-up when other dryers are "on-line".

d. Air filters. Design criteria for air filters shall be as follows.

i. Air filters shall be provided on the suction side of the air compressors, between the air compressors and the dryers and between the dryers and the ozone generators.

ii. The filter before the desiccant dryers shall be of the coalescing type and be capable of removing aerosol and particulates larger than 0.3 microns in diameter. The filter after the desiccant dryer shall be of the particulate type and be capable of removing all particulates greater than 0.1 microns in diameter, or smaller if specified by the generator manufacturer.

e. Preparation piping. Piping in the air preparation system can be common grade steel, seamless copper, stainless steel or galvanized steel. The piping must be designed to withstand the maximum pressures in the air preparation system.

3. Ozone Generator. Design criteria for ozone generators shall be as follows.

a. Capacity. Design criteria for ozone generator capacity shall be as follows.

i. The production rating of the ozone generators shall be stated in pounds per day and kWhr per pound at a maximum cooling water temperature and maximum ozone concentration.

ii. The design shall ensure that the minimum concentration of ozone in the generator exit gas will not be less than 1 percent (by weight).

iii. Generators shall be sized to have sufficient reserve capacity so that the system does not operate at peak capacity for extended periods of time.

iv. The production rate of ozone generators will decrease as the temperature of the coolant increases. If there is to be a variation in the supply temperature of the coolant throughout the year, then applicable data shall be used to determine production changes due to the temperature change of the supplied coolant. The design shall ensure that the generators can produce the required ozone at maximum coolant temperature.

v. Appropriate ozone generator backup equipment must be provided.

b. Electrical. The generators can be low, medium or high frequency type. Specifications shall require that the transformers, electronic circuitry and other electrical hardware be proven, high quality components designed for ozone service.

c. Cooling. Adequate cooling shall be provided. The cooling water must be properly treated to minimize corrosion, scaling and microbiological fouling of the water side of the tubes. Where cooling water is treated, cross connection control shall be provided to prevent contamination of the potable water supply in accordance with the backflow prevention requirements in §§344 and 346 of this Part.

d. Materials. The ozone generator shell and tubes shall be constructed of Type 316L stainless steel.

4. Ozone Contactors. The selection or design of the contactor and method of ozone application depends on the purpose for which the ozone is being used.

a. Bubble Diffusers. Design criteria for bubble diffusers shall be as follows.

i. Where disinfection is the primary application a minimum of two contact chambers each equipped with baffles to prevent short circuiting and induce countercurrent flow shall be provided. Ozone shall be applied using porous-tube or dome diffusers.

ii. The minimum contact time shall be 10 minutes. A shorter contact time may be approved by state health officer.

iii. The contactor must be kept under negative pressure and sufficient ozone monitors shall be provided to protect worker safety. The secondary enclosure for the ozone contactor shall be open to the atmosphere.

iv. Large contact vessels made of reinforced concrete shall comply with ACI 350. All reinforcement bars shall be covered with a minimum of 2.0 inches of concrete. Smaller contact vessels can be made of stainless steel, fiberglass or other material which will be stable in the presence of residual ozone and ozone in the gas phase above the water level.

v. Where necessary a system shall be provided between the contactor and the off-gas destruct unit to remove froth from the air and return the other to the contactor or other location acceptable to the state health officer. If foaming is expected to be excessive, then a potable water spray system shall be placed in the contactor head space.

vi. All openings into the contactor for pipe connections, hatchways, etc. shall be properly sealed using welds or ozone resistant gaskets such as Teflon or Hypalon.

vii. Multiple sampling ports shall be provided to enable sampling of each compartment's effluent water and to confirm "CT" calculations.

viii. A pressure/vacuum relief valve shall be provided in the contactor and piped to a location where there will be no damage to the destruction unit.

ix. The diffusion system shall work on a countercurrent basis such that the ozone is fed at the bottom of the vessel and water is fed at the top of the vessel.

x. The depth of water in bubble diffuser contactors shall be a minimum of 18 feet. The contactor

should also have a minimum of 3 feet of freeboard to allow for foaming.

xi. All contactors shall have provisions for cleaning, maintenance and drainage of the contactor. Each contactor compartment shall also be equipped with an access hatchway.

xii. Aeration diffusers shall be fully serviceable by either cleaning or replacement.

b. Other Contactors. Other contactors, such as the venturi or aspirating turbine mixer contactor, may be approved by the state health officer provided adequate ozone transfer is achieved and the required contact times and residuals can be met and verified.

5. Ozone Destruction Unit. Design criteria for ozone destruction unit shall be as follows.

a. A system for treating the final off-gas from each contactor shall be provided in order to meet safety and air quality standards. Acceptable systems include thermal destruction and thermal/catalytic destruction units.

b. The maximum allowable ozone concentration in the discharge is 0.1 ppm (by volume).

c. At least two units shall be provided which are each capable of handling the entire gas flow.

d. Exhaust blowers shall be provided in order to draw off-gas from the contactor into the destruct unit.

e. Catalysts shall be protected from froth, moisture and other impurities which may harm the catalyst.

f. The catalyst and heating elements shall be located where they can easily be reached for maintenance.

6. Piping Materials. Only low carbon 304L and 316L stainless steels shall be used for ozone service.

7. Joints and Connections. Design criteria for ozone joints and connections shall be as follows.

a. Connections on piping used for ozone service are to be welded where possible.

b. Connections with meters, valves or other equipment are to be made with flanged joints with ozone resistant gaskets, such as Teflon or Hypalon.

c. A positive closing plug or butterfly valve plus a leak-proof check valve shall be provided in the piping between the generator and the contactor to prevent moisture reaching the generator.

8. Instrumentation. Design criteria for ozone instrumentation shall be as follows.

a. Pressure gauges shall be provided at the discharge from the air compressor, at the inlet to the refrigeration dryers, at the inlet and outlet of the desiccant dryers, at the inlet to the ozone generators and contactors and at the inlet to the ozone destruction unit.

b. Electric power meters shall be provided for measuring the electric power supplied to the ozone generators. Each generator shall have a trip which shuts

down the generator when the wattage exceeds a certain preset level.

c. Dew point monitors shall be provided for measuring the moisture of the feed gas from the desiccant dryers. Because it is critical to maintain the specified dew point, it is recommended that continuous recording charts be used for dew point monitoring which will allow for proper adjustment of the dryer cycle. Where there is potential for moisture entering the ozone generator from downstream of the unit or where moisture accumulation can occur in the generator during shutdown, post-generator dew point monitors shall be used.

d. Air flow meters shall be provided for measuring air flow from the desiccant dryers to each of other ozone generators, air flow to each contactor and purge air flow to the desiccant dryers.

e. Temperature gauges shall be provided for the inlet and outlet of the ozone cooling water and the inlet and outlet of the ozone generator feed gas, and, if necessary, for the inlet and outlet of the ozone power supply cooling water.

f. Water flow meters shall be installed to monitor the flow of cooling water to the ozone generators and, if necessary, to the ozone power supply.

g. Ozone monitors shall be installed to measure zone concentration in both the feed-gas and off-gas from the contactor and in the off-gas from the destruct unit. For disinfection systems, monitors shall also be provided for monitoring ozone residuals in the water. The number and location of ozone residual monitors shall be such that the amount of time that the water is in contact with the ozone residual can be determined.

h. A minimum of one ambient ozone monitor shall be installed in the vicinity of the contactor and a minimum of one shall be installed in the vicinity of the generator. Ozone monitors shall also be installed in any areas where ozone gas may accumulate.

9. Alarms. The following alarm/shutdown systems shall be considered at each installation:

a. dew point shutdown/alarm. This system should shut down the generator in the event the system dew point exceeds -76°F (-60°C);

b. ozone generator cooling water flow shutdown/alarm. This system should shut down the generator in the event that cooling water flows decrease to the point that generator damage could occur;

c. ozone power supply cooling water flow shutdown/alarm. This system should shut down the power supply in the event that cooling water flow decreases to the point that damage could occur to the power supply;

d. ozone generator cooling water temperature shutdown/alarm. This system should shutdown the generator if either the inlet or outlet cooling water exceeds a certain preset temperature;

e. ozone power supply cooling water temperature shutdown/alarm. This system should shutdown the power

supply if either the inlet or outlet cooling water exceeds a certain preset temperature;

f. ozone generator inlet feed-gas temperature shutdown/alarm. This system should shutdown the generator if the feed-gas temperature is above a preset value;

g. ambient ozone concentration shutdown/alarm. The alarm should sound when the ozone level in the ambient air exceeds 0.1 ppm or a lower value chosen by the water supplier. Ozone generator shutdown should occur when ambient ozone levels exceed 0.3 ppm (or a lower value) in either the vicinity of the ozone generator or the contactor; and

h. ozone destruct temperature alarm. The alarm should sound when temperature exceeds a preset value.

10. Safety. Design criteria for ozone safety shall be as follows.

a. The maximum allowable ozone concentration in the air to which workers may be exposed must not exceed 0.1 ppm (by volume).

b. Emergency exhaust fans shall be provided in the rooms containing the ozone generators to remove ozone gas if leakage occurs.

c. A sign shall be posted indicating "No smoking, oxygen in use" at all entrances to the treatment plant. In addition, no flammable or combustible materials shall be stored within the oxygen generator areas.

I. Chlorine Dioxide. When choosing chlorine dioxide, consideration must be given to formation of the regulated byproducts and chlorite.

1. Chlorine Dioxide Generators. Chlorine dioxide generation equipment shall be factory assembled pre-engineered units with a minimum efficiency of 95 percent. The excess free chlorine shall not exceed five percent of the theoretical stoichiometric concentration required. Generators designed or intended to operate outside of this criteria shall require justification and be considered on a case-by-case basis. Generator yield shall be defined as the ratio of chlorine dioxide generated to the theoretical stoichiometric maximum, as presented in EPA's Alternative Disinfectants and Oxidants Guidance Manual, Section 4.2.2 (EPA 815-R-99-014, April 1999).

a. Generators shall be designed, built and certified in compliance to NSF 61.

b. Bench scale testing shall be conducted to determine chlorine dioxide demand and decay kinetics for the specific water being treated in order to establish the correct design dose for required log inactivation compliance (if required), oxidation reactions, and chlorite generation.

c. An operation and maintenance manual (O&M) shall be provided. The O&M shall cover, at a minimum, operating instructions, identification and location of components, maintenance information and checklists; manufacturer's product information (including trouble shooting information, a parts list and parts order form, special tools, spare parts list, etc.) and a chlorine dioxide and chlorite residual monitoring action plan (RMAP). The

RMAP shall identify actions to be taken by properly trained certified operators in the event that the chlorine dioxide residual or chlorite level meet or exceed specified maximum levels at specified testing locations (e.g., generator effluent, treatment units, point-of-entry).

d. Certified operators charged with handling and/or conducting chlorine dioxide and chlorite testing shall be properly trained on the production and testing equipment, the generator O&M manual, and the RMAP. Documentation of training shall be signed by the individual having responsible authority over the operators. Training documentation shall be provided to the OPH District Office and maintained on-site for review during sanitary surveys.

2. Feed and storage facilities. When chlorine gas and sodium chlorite are used feed and storage facilities shall comply with §209.A and §209.C of this Part, respectively. Sodium hypochlorite feed and storage facilities shall comply with §209.D of this Part. All chlorine dioxide feed and storage facilities shall comply with §179.I.5 and §179.I.6 of this Part.

3. Other design requirements shall include the following.

a. The design shall comply with all applicable portions of §179.B, §179.C, and §179.F of this Part.

b. Alarms shall be provided to indicate a lack of chemical (chlorine and sodium chlorite) or motive water flow.

4. Public Notification. Notification of a change in disinfection practices and the schedule for the changes shall be made known to the public; particularly to hospitals, kidney dialysis facilities, and fish breeders, as chlorine dioxide and its byproducts may have similar effects as chloramines.

5. Chlorine Dioxide Feed System. Design criteria for chlorine dioxide feed system shall be as follows.

a. Use fiberglass reinforced vinyl ester plastic (FRP) or high density linear polyethylene (HDLPE) tanks with no insulation.

b. If centrifugal pumps are used, provide Teflon packing material. Pump motors must be totally enclosed, fan-cooled, equipped with permanently sealed bearings, and equipped with double mechanical seals or other means to prevent leakage.

c. Provide chlorinated PVC, vinyl ester or Teflon piping material. Do not use carbon steel or stainless steel piping systems.

d. Provide glass view ports for the reactor if it is not made of transparent material.

e. All chlorite solutions shall have concentrations less than 30 percent. Higher strength solutions are susceptible to crystallization and stratification.

6. Chlorine Dioxide Storage Requirements. Design criteria for chlorine dioxide storage shall be as follows.

a. Chlorine dioxide storage and operating area shall conform to the following.

i. The chlorine dioxide facility shall be physically located in a separate room from other water treatment plant operating areas.

ii. The chlorine dioxide area shall have a ventilation system separate from other operating areas.

iii. Provision shall be made to ventilate the chlorine dioxide facility area and maintain the ambient air chlorine dioxide concentrations below the Permissible Exposure Limit (PEL).

(a). The ventilating fan(s) take suction near the floor, as far as practical from the door and air inlet, with the point of discharge so located as not to contaminate air inlets of any rooms or structures.

(b). Air inlets are provided near the ceiling.

(c). Air inlets and outlets shall be louvered.

(d). Separate switches for the fans are outside and near the entrance of the facility.

iv. There shall be observation windows through which the operating area can be observed from outside the room to ensure operator safety.

v. Manual switches to the light in the operating area shall be located outside the door to the room.

vi. An emergency shutoff control to shut flows to the generator shall be located outside the operating area.

vii. Gaseous chlorine feed to the chlorine dioxide generator shall enter the chlorine dioxide facility area through lines which can only feed to vacuum.

viii. There shall not be any open drains in the chlorine dioxide operating area.

J. Ultraviolet Light. Any Ultraviolet unit installed for treatment of cryptosporidium is required to meet the requirements of the USEPA's 2006 Ultraviolet Disinfection Guidance Manual.

K. Other disinfecting agents. Use of disinfecting agents other than those listed shall be approved by the state health officer prior to preparation of final plans and specifications.

AUTHORITY NOTE: Promulgated in accordance with the provisions of R.S. 40:4(A)(8), 40:4.13.D.(1)(2) and 40:5(A)(2)(3)(5)(6)(7)(17).

HISTORICAL NOTE: Promulgated by the Department of Health, Office of Public Health, LR 44:318 (February 2018), effective August 1, 2018.

§181. Softening

A. Lime or Lime-Soda Process. Design standards for rapid mix, flocculation and sedimentation are in §175 of this Part. Additional consideration must be given to the following process elements.

1. Hydraulics. When split treatment is used, the bypass line should be sized to carry total plant flow, and an accurate means of measuring and splitting the flow shall be provided.

2. **Rapid Mix.** Rapid mix detention times should be instantaneous, but not longer than 30 seconds with adequate velocity gradients to keep the lime particles dispersed.

3. **Stabilization.** Equipment for stabilization of water softened by the lime or lime-soda process is required. (see §189 of this Part).

4. **Sludge Collection.** A means for sludge removal shall be provided in the sedimentation basin.

5. **Sludge Disposal.** Provisions shall be included for proper disposal of softening sludges. (see Subchapter F. §§257-275 of this Part).

B. Cation Exchange Process. Design criteria for cation exchange process shall be as follows.

1. **Pre-treatment requirements.** Iron, manganese, or a combination of the two, should not exceed 0.3 mg/L in the water as applied to the ion exchange resin. Pre-treatment is required when the content of iron, manganese, or a combination of the two, is one milligram per liter or more (see §187 of this Part). Waters having 5 units or more turbidity should not be applied directly to the cation exchange softener.

2. **Design.** The units may be of pressure or gravity type, of either an upflow or downflow design. Automatic regeneration based on volume of water softened shall be used unless manual regeneration is justified and is approved by the state health officer. A manual override shall be provided on all automatic controls.

3. **Exchange Capacity.** The design capacity shall be in accordance with the manufacturer's specifications for hardness removal.

4. **Depth of Resin.** The depth of the exchange resin shall not be less than three feet.

5. **Flow Rates.** The rate of softening shall not exceed seven gallons per minute per square foot of bed area and the backwash rate shall be between six and eight gallons per minute per square foot of bed area. Rate-of-flow controllers or the equivalent shall be installed for the above purposes.

6. **Freeboard.** The freeboard will depend upon the size and specific gravity of the resin and the direction of water flow. Adequate freeboard shall be provided to prevent loss of media during backwashing.

7. **Underdrains and Supporting Gravel.** The bottoms, strainer systems and support for the exchange resin shall conform to criteria provided for rapid rate gravity filters (see §177.A.6 and §177.A.7 of this Part).

8. **Brine Distribution.** Facilities should be included for even distribution of the brine over the entire surface of both upflow and downflow units.

9. **Cross-Connection Control.** Backwash, rinse and air relief discharge pipes shall be installed in such a manner as to prevent any possibility of back-siphonage.

10. **Bypass Piping and Equipment.** Bypass shall be provided around softening units to produce a blended water of desirable hardness. Totalizing meters shall be installed on the bypass line and on each softener unit. The bypass line

shall have a shutoff valve and should have an automatic proportioning or regulating device.

11. **Additional Limitations.** When the applied water contains a chlorine residual, the cation exchange resin shall be a type that is not damaged by residual chlorine.

12. **Sampling Taps.** A means of collecting samples shall be provided for the collection of representative samples. If sample taps are provided, they shall be Smooth-nose type. The taps sampling locations shall be located to provide for sampling of the softener influent, effluent and blended water. The sampling locations for the blended water shall be at least 20 feet downstream from the point of blending.

13. **Brine and Salt Storage Tanks.** Design criteria for brine and salt storage tanks shall be as follows.

a. Salt dissolving or brine tanks and wet salt storage tanks shall be covered and must be corrosion-resistant.

b. The make-up water inlet shall be protected from back-siphonage.

c. Wet salt storage basins shall be equipped with manholes or hatchways for access and for direct dumping of salt from truck or railcar. Openings shall be provided with raised curbs and watertight covers having overlapping edges. Each cover shall be hinged on one side, and shall have locking device.

d. Overflows, where provided, shall be protected with corrosion resistant screens and must terminate with either a turned down bend having a proper free fall discharge or a self-closing flap valve.

e. The salt shall be supported on graduated layers of gravel placed over a brine collection system.

14. **Stabilization.** Refer to §189 of this Part.

15. **Waste Disposal.** Suitable disposal shall be provided for brine waste (see Subchapter F. §§257-275 of this Part).

16. **Construction Materials.** Pipes and contact materials shall be resistant to the aggressiveness of salt. Steel and concrete must be coated with a non-leaching protective coating which is compatible with salt and brine.

17. **Housing.** Bagged salt and dry bulk salt storage shall be enclosed and separated from other operating areas in order to prevent damage to equipment.

AUTHORITY NOTE: Promulgated in accordance with the provisions of R.S. 40:4(A)(8), 40:4.13.D.(1)(2) and 40:5(A)(2)(3)(5)(6)(7)(17).

HISTORICAL NOTE: Promulgated by the Department of Health, Office of Public Health, LR 44:322 (February 2018), effective August 1, 2018.

§183. Anion Exchange Treatment

A. Pre-Treatment Requirements. Iron, manganese or a combination of the two, should not exceed 0.3 mg/L in the water as applied to the ion exchange resin. Pre-treatment is required when a combination of iron and manganese exceeds 0.5 mg/L.

B. Design criteria for anion exchange treatment is as follows.

1. Anion exchange units are typically of the pressure type, down flow design. Automatic regeneration based on volume of water treated shall be used unless manual regeneration is justified and is approved by the state health officer. A manual override shall be provided on all automatic controls.

2. If a portion of the water is bypassed around the units and blended with treated water, the maximum blend ratio allowable must be determined based on the highest anticipated raw water contaminant level. If bypassing is provided, a totalizing meter and a proportioning or regulating device or flow regulating valves shall be provided on the bypass line.

C. Number of Units. At least two units shall be provided. The treatment capacity shall be capable of producing the water at the average daily flow at the maximum month of the plant at a level below the MCL of the contaminant being removed, with one exchange unit out of service.

D. Type of Media. The anion exchange media shall be of the type required to for the contaminant being removed.

E. Flow Rates. The treatment flow rate should not exceed 5 gallons per minute per square foot of bed area (20 cm/minute down flow rate). The backwash flow rate should be approximately 4.0 to 6.0 gallons per minute per square foot of bed area (16 to 24 cm/minute rise rate). The regeneration rate should be approximately 1.0 gallon per minute per square foot of bed area (4 cm/minute rise rate) with a fast rinse approximately equal to the service flow rate.

F. Freeboard. Adequate freeboard shall be provided to accommodate the backwash flow rate of the unit.

G. Miscellaneous Appurtenances. Miscellaneous appurtenances shall include the following.

1. The system shall be designed to include an adequate under drain and supporting gravel system and brine distribution equipment.

2. Sample taps, and brine and salt storage shall be as required in §181.B.12 and §181.B.13 of this Part.

H. Cross Connection Control. Backwash, rinse and air relief discharge pipes shall be installed in such a manner as to prevent any possibility of back-siphonage.

I. Construction Materials. Pipes and contact materials must be resistant to the aggressiveness of salt. Plastic and red brass are acceptable materials. Steel and concrete shall be coated with a non-leaching protective coating which is compatible with salt and brine.

J. Housing. Bagged salt and dry bulk salt storage shall be enclosed and separated from other operating areas in order to prevent damage to equipment.

K. Preconditioning of the Media. Prior to startup of the equipment, the media shall be regenerated with no less than two bed volumes of water containing sodium chloride followed by an adequate rinse.

L. Waste Disposal. Suitable disposal must be provided for brine waste (see Subchapter F. §§257-275 of this Part).

AUTHORITY NOTE: Promulgated in accordance with the provisions of R.S. 40:4(A)(8), 40:4.13.D.(1)(2) and 40:5(A)(2)(3)(5)(6)(7)(17).

HISTORICAL NOTE: Promulgated by the Department of Health, Office of Public Health, LR 44:323 (February 2018), effective August 1, 2018.

§185. Aeration

A. Aeration processes generally are used in two types of treatment applications. One is the transfer of a gas to water (e.g., adding oxygen to assist in iron and/or manganese removal) and is called gas absorption, or aeration. The second is the removal of gas from water (reduce or remove objectionable amounts of carbon dioxide, hydrogen sulfide, etc. or reduce the concentration of taste and odor-causing substances or removal of volatile organic compounds) and is classified as desorption or air stripping. The materials used in the construction of the aerator(s) shall meet NSF/ANSI 61 or be approved by the state health officer.

1. Natural Draft Aeration. Design shall provide:

a. perforations in the distribution pan 3/16 to 1/2 inches in diameter, spaced 1 to 3 inches on centers to maintain a six inch water depth;

b. for distribution of water uniformly over the top tray;

c. discharge through a series of three or more trays with separation of trays not less than 12 inches;

d. loading at a rate of 1 to 5 gallons per minute for each square foot of total tray area (2.5 - 12.5 m/hr);

e. trays with slotted, heavy wire (1/2 inch openings) mesh or perforated bottoms;

f. construction of durable material resistant to aggressiveness of the water and dissolved gases; and

g. protection from insects by 24-mesh screen when used in applications where the water will not be subject to open vessels in downstream treatment processes.

2. Forced or Induced Draft Aeration. Devices shall be designed to:

a. insure adequate counter current of air through the enclosed aerator column;

b. exhaust air directly to the outside atmosphere;

c. include a down-turned air outlet and inlet. Protection from insects by 24-mesh screen when used in applications where the water will not be subject to open vessels in downstream treatment processes;

d. be such that air introduced in the column shall be as free from obnoxious fumes, dust, and dirt as possible;

e. be such that sections of the aerator can be easily reached or removed for maintenance of the interior or installed in a separate aerator room;

f. provide loading at a rate of 1 to 5 gallons per minute for each square foot of total tray area (2.5 - 12.5 m/hr);

g. insure that the water outlet is adequately sealed to prevent unwarranted loss of air;

h. when trays are used, discharge through a series of five or more trays with separation of trays not less than six inches or as approved by the state health officer;

i. provide distribution of water uniformly over the top tray; and

j. be of durable material resistant to the aggressiveness of the water and dissolved gases.

3. Spray Aeration. Design shall provide:

a. a hydraulic head of between 5 - 25 feet;

b. nozzles, with the size, number, and spacing of the nozzles being dependent on the flowrate, space, and the amount of head available;

c. nozzle diameters in the range of 1 to 1.5 inches to minimize clogging; and

d. an enclosed basin to contain the spray. Any openings for ventilation, etc. shall be protected from insects by 24-mesh screen when used in applications where the water will not be subject to open vessels in downstream treatment processes.

4. Pressure Aeration. Pressure aeration shall be used for oxidation and biological filtration purposes only. Filters following pressure aeration must have adequate exhaust devices for release of air. Pressure aeration devices shall be designed to:

a. give thorough mixing of compressed air with water being treated; and

b. provide screened and filtered air, free of obnoxious fumes, dust, dirt and other contaminants.

5. Packed Tower Aeration. Packed tower aeration (PTA) which is also known as air stripping involves passing water down through a column of packing material while pumping air counter-currently up through the packing. PTA is used for the removal of volatile organic chemicals, trihalomethanes, carbon dioxide, and radon.

a. Process design for PTA includes the following.

i. The tower shall be designed to reduce contaminants to below the maximum contaminant level (MCL).

ii. The ratio of the packing height to column diameter should be at least 7:1 for the pilot unit and at least 10:1 for the full scale tower. The type and size of the packing used in the full scale unit shall be the same as that used in the pilot work.

iii. The minimum volumetric air to water ratio at peak water flow should be 25:1 and the maximum should be 80:1. Air to water ratios outside these ranges should not be used without prior approval from the state health officer.

iv. The design shall consider potential fouling problems from calcium carbonate and iron precipitation and from bacterial growth

b. Materials of Construction. The tower shall be constructed of a material that is suitable for contact with the water being treated. Packing materials shall be resistant to the aggressiveness of the water, dissolved gases and cleaning materials and shall be suitable for contact with potable water.

c. Water Flow System. Design of the water flow system includes the following.

i. Water should be distributed uniformly at the top of the tower using spray nozzles or orifice-type distributor trays that prevent short circuiting.

ii. A mist eliminator shall be provided above the water distributor system.

iii. A side wiper redistribution ring shall be provided at least every 10 feet in order to prevent water channeling along the tower wall and short circuiting.

iv. Sample taps shall be provided in the influent and effluent piping.

v. The effluent sump, if provided, shall have easy access for cleaning purposes and be equipped with a drain valve. The drain shall not be connected directly to any storm or sanitary sewer.

vi. A blow-off line should be provided in the effluent piping to allow for discharge of water/chemicals used to clean the tower.

vii. A means of measuring the water flow to each tower shall be provided.

viii. An overflow line shall be provided which discharges 12 to 14 inches above a splash pad or drainage inlet. Proper drainage shall be provided to prevent flooding of the area.

ix. Means shall be provided to prevent flooding of the air blower.

x. The water influent pipe should be supported separately from the tower's main structural support.

d. Air Flow System. Design of the air flow system includes the following.

i. The air inlet to the blower and the tower discharge vent shall be downturned and protected with a non-corrodible 24-mesh screen to prevent contamination from extraneous matter.

ii. The air inlet shall be in a protected location.

iii. A means of ensuring that air is being provided when water is being delivered to the air strippers shall be provided.

e. The following features shall be provided.

i. A sufficient number of access ports with a minimum diameter of 24 inches to facilitate inspection, media replacement, media cleaning and maintenance of the interior.

ii. A method of cleaning the packing material when fouling may occur.

iii. An acceptable alternative treatment shall be available during periods of maintenance and operation interruptions when used for treatment of a primary contaminant. No bypass shall be provided unless specifically approved by the state health officer.

iv. Disinfection application points ahead of the tower to control biological growth.

v. Adequate packing support to allow free flow of water and to prevent deformation with deep packing heights.

6. Other Methods of Aeration. Other methods of aeration may be used if applicable to the treatment needs. Such methods include but are not restricted to spraying, diffused air, cascades and mechanical aeration. The treatment processes shall be designed to meet the particular needs of the water to be treated and are subject to the approval of the state health officer.

7. Protection of Aerators. All aerators except those discharging to lime softening or clarification plants shall be protected from contamination by birds, insects, wind borne debris, rainfall and water draining off the exterior of the aerator.

8. Bypass. A bypass should be provided for all aeration units except those installed to comply with maximum contaminant levels.

9. Redundancy. Redundant equipment shall be provided for units installed to comply with the Safe Drinking Water Act primary contaminants, unless otherwise approved by the state health officer.

AUTHORITY NOTE: Promulgated in accordance with the provisions of R.S. 40:4(A)(8), 40:4.13.D.(1)(2) and 40:5(A)(2)(3)(5)(6)(7)(17).

HISTORICAL NOTE: Promulgated by the Department of Health, Office of Public Health, LR 44:324 (February 2018), effective August 1, 2018.

§187. Iron and Manganese Control

A. Iron and manganese control, as used herein, refers solely to treatment processes designed specifically for this purpose. The treatment process used will depend upon the character of the raw water. The selection of one or more treatment processes must meet specific local conditions as determined by engineering investigations, including chemical analyses of representative samples of water to be treated, and receive the approval of the state health officer. It may be necessary to operate a pilot plant in order to gather all information applicable to the design. Consideration should be given to adjusting pH of the raw water to optimize the chemical reaction.

1. Design elements for removal by oxidation, detention and filtration are as follows.

a. Oxidation. Oxidation may be by aeration, as indicated in §185 of this Part, or by chemical oxidation with chlorine, potassium permanganate, sodium permanganate, ozone or chlorine dioxide.

b. Reaction. A detention time shall be provided following aeration to insure that the oxidation reactions are as complete as possible. The reaction tank/detention basin

shall be designed to prevent short circuiting. If a reaction tank/detention basin is provided, it shall be provided with an overflow, vent and access hatch in accordance with §225.I, §225.J, and §225.K of this Part.

c. Sedimentation. Sedimentation basins shall be provided when treating water with high iron and/or manganese ($\geq 7 \times \text{SMCL}$) content, or where chemical coagulation is used to reduce the load on the filters. Provisions for sludge removal shall be made.

d. Filtration. Filters shall be provided and shall conform to §177 of this Part.

2. For removal by the lime-soda softening process, see §181.A of this Part.

3. Removal by manganese coated media filtration. This process consists of a continuous or batch feed of potassium permanganate to the influent of a manganese coated media filter.

a. Provisions should be made to apply the permanganate as far ahead of the filter as practical and to a point immediately before the filter.

c. An anthracite media cap of at least six inches or more as required by the state health officer shall be provided over manganese coated media.

d. Normal filtration rate shall be based on the manufacturer's performance studies.

e. Sample taps shall be provided:

- i. for the raw water;
- ii. immediately ahead of filtration; and
- iii. at the filter effluent.

4. Removal by Ion Exchange. This process of iron and manganese removal should not be used for water containing more than 0.3 milligrams per liter of iron, manganese or combination thereof. This process is not acceptable where either the raw water or wash water contains dissolved oxygen or other oxidants.

5. Sequestration by Polyphosphates. The total phosphate applied shall not exceed 10 mg/L as phosphate (PO₄). Possible adverse effects on corrosion must be addressed when phosphate addition is proposed for iron sequestering.

a. Feeding equipment shall conform to the requirements of Subchapter A "Chemical Application" §201-§209 of this Part.

b. Polyphosphates shall not be applied ahead of iron and manganese removal treatment.

c. The phosphate feed point shall be located at least five feet ahead of the oxidant feed point.

6. Sequestration by Sodium Silicates. Sodium silicate sequestration of iron and manganese is appropriate only for groundwater supplies prior to air contact. On-site pilot tests are required to determine the suitability of sodium silicate for the particular water and the minimum feed needed. Rapid oxidation of the metal ions such as by chlorine or chlorine

dioxide must accompany or closely precede the sodium silicate addition. Injection of sodium silicate more than 15 seconds after oxidation may cause detectable loss of chemical efficiency. Dilution of feed solutions much below five per cent silica as SiO₂ should also be avoided for the same reason. Sodium silicate treatment may be less effective for sequestering manganese than for iron.

a. Sodium silicate addition is applicable to waters containing up to 2 mg/L of iron, manganese or combination thereof.

b. Chlorine residuals shall be maintained throughout the distribution system to prevent biological breakdown of the sequestered iron.

c. The amount of silicate added shall be limited to 20 mg/L as SiO₂, but the amount of added and naturally occurring silicate shall not exceed 60 mg/L as SiO₂.

d. Feeding equipment shall conform to the requirements of Subchapter A "Chemical Application" §201-§209 of this Part.

e. Sodium silicate shall not be applied ahead of iron or manganese removal treatment.

7. Sampling taps. Smooth-nosed sampling taps shall be provided for control purposes. A means of collecting samples shall be provided for each raw water source, each treatment unit influent and each treatment unit effluent.

8. Testing equipment shall be provided for all plants. Where polyphosphate sequestration is practiced, appropriate phosphate testing equipment shall be provided that meets the requirements of §137.G of this Part.

AUTHORITY NOTE: Promulgated in accordance with the provisions of R.S. 40:4(A)(8), 40:4.13.D.(1)(2) and 40:5(A)(2)(3)(5)(6)(7)(17).

HISTORICAL NOTE: Promulgated by the Department of Health, Office of Public Health, LR 44:325 (February 2018), effective August 1, 2018.

§189. Stabilization

A. Carbon Dioxide Addition. Where liquid carbon dioxide is used, adequate precautions shall be taken to prevent carbon dioxide from entering the plant from the recarbonation process.

1. Consideration shall be given to the installation of a carbon dioxide alarm system with light and audio warning, especially in low areas.

2. Recarbonation tanks shall be located outside or be sealed and vented to the outside with adequate seals and adequate purge flow of air to ensure workers safety.

a. Provisions shall be made for draining the recarbonation basin and removing sludge.

B. Acid Addition. Design elements for acid addition include the following.

1. Feed equipment shall conform to Subchapter A "Chemical Application" §201-§209 of this Part.

2. Adequate precautions shall be taken for operator safety, such as not adding water to the concentrated acid. (see §207 and §209 of this Part).

C. Phosphates. The feeding of phosphates may be applicable for sequestering calcium, for corrosion control, and in conjunction with alkali feed following ion exchange softening.

1. Feed equipment shall conform to Subchapter A "Chemical Application" §201-§209 of this Part.

2. Stock phosphate solution shall be kept covered and disinfected by carrying approximately 10 mg/L free chlorine residual unless the phosphate is not able to support bacterial growth. Phosphate solutions having a pH of 2.0 or less may also be exempted from this requirement by the state health officer.

AUTHORITY NOTE: Promulgated in accordance with the provisions of R.S. 40:4(A)(8), 40:4.13.D.(1)(2) and 40:5(A)(2)(3)(5)(6)(7)(17).

HISTORICAL NOTE: Promulgated by the Department of Health, Office of Public Health, LR 44:326 (February 2018), effective August 1, 2018.

§191. Taste and Odor Control

A. Powdered Activated Carbon. Design elements for powdered activated carbon (PAC) include the following.

1. Continuous agitation or resuspension equipment shall be provided to keep the carbon from depositing in the slurry storage tank.

2. Provision shall be made for adequate dust control.

3. The required rate of feed of carbon in a water treatment plant depends upon the tastes and/or odors involved, but provision should be made for adding from 0.1 milligrams per liter to at least 40 milligrams per liter.

4. Powdered activated carbon shall be handled as a potentially combustible material.

B. Granular Activated Carbon. Replacement of anthracite with granular activated carbon (GAC) may be considered as a control measure for geosmin and methyl isoborneol (MIB) taste and odors from algae blooms. Demonstration studies may be required by the state health officer. See §177.A.6.iv of this Part for application within filters.

C. Copper Sulfate and Other Copper Compounds. Continuous or periodic treatment of water with copper compounds to kill algae or other growths shall be controlled to prevent copper in excess of 1.0 milligrams per liter as copper in the plant effluent or distribution system. Care shall be taken to assure an even distribution of the chemical within the treatment area.

D. For aeration, see §185 of this Part.

E. Ozone. Ozonation can be used as a means of taste and odor control. Adequate contact time shall be provided to complete the chemical reactions involved. Ozone is generally more desirable for treating water with high threshold odors. (See §179.H of this Part)

AUTHORITY NOTE: Promulgated in accordance with the provisions of R.S. 40:4(A)(8), 40:4.13.D.(1)(2) and 40:5(A)(2)(3)(5)(6)(7)(17).

HISTORICAL NOTE: Promulgated by the Department of Health, Office of Public Health, LR 44:327 (February 2018), effective August 1, 2018.

Chapter 2. Public Water System Construction, Operation and Maintenance

Subchapter A. Chemical Application

§201. General Requirements

A. General. Chemicals applied to treat potable drinking water shall meet the requirements of NSF/ANSI Standard 60 as certified by an ANSI-accredited testing agency.

B. Plans and Specifications. Plans and specifications shall be submitted for review and approval, as provided for in Chapter 1, Subchapter A of this Part, and shall include:

1. descriptions of feed equipment, including maximum and minimum feed ranges;
2. location of feeders, piping layout and points of application;
3. storage and handling facilities;
4. operating and control procedures including proposed application rates;
5. description of testing equipment; and
6. description of system including all tanks with capacities, (with drains, overflows, and vents), feeders, transfer pumps, connecting piping, valves, points of application, backflow prevention devices, air gaps, secondary containment, and safety eye washes and showers.

C. Chemical Application. Chemicals shall be applied to the water at such points and by such means as to:

1. assure maximum efficiency of treatment;
2. assure maximum safety to consumer;
3. provide maximum safety to operators;
4. assure satisfactory mixing of the chemicals with the water;
5. provide maximum flexibility of operation through various points of application, when appropriate; and
6. prevent backflow or back-siphonage between multiple points of feed through common manifolds.

D. General equipment design shall be such that:

1. feeders will be able to supply, at all times, the necessary amounts of chemicals at an accurate rate, throughout the range of feed;
2. chemical-contact materials and surfaces are resistant to the aggressiveness of the chemical solution;
3. corrosive chemicals are introduced in such a manner as to minimize potential for corrosion;
4. chemicals that are incompatible are not stored or handled together;

5. all chemicals are conducted from the feeder to the point of application in separate conduits;

6. chemical feeders are as near as practical to the feed point;

7. chemical feeders and pumps shall operate at no lower than 20 percent of the feed range unless two fully independent adjustment mechanisms such as pump pulse rate and stroke length are fitted then the pump shall operate at no lower than 10 percent of the rated maximum; and

8. gravity may be used where practical.

E. For each chemical the information submitted shall include:

1. documentation that the chemical is certified to NSF/ANSI Standard 60;
2. specifications for the chemical to be used;
3. purpose of the chemical;
4. proposed minimum non-zero, average and maximum dosages, solution strength or purity (as applicable), and specific gravity or bulk density;
5. method for independent calculation of amount fed daily; and
6. safety data sheet (SDS).

AUTHORITY NOTE: Promulgated in accordance with the provisions of R.S. 40:4(A)(8), 40:4.13.D.(1)(2) and 40:5(A)(2)(3)(5)(6)(7)(17).

HISTORICAL NOTE: Promulgated by the Department of Health, Office of Public Health, LR 44:327 (February 2018), effective August 1, 2018.

§203. Feed Equipment

A. Feeder Redundancy. Where a chemical feed and booster pump is necessary for the protection of the supply, such as chlorination, coagulation or other essential processes, a standby unit or a combination of units of sufficient size to meet capacity shall be provided to replace the largest unit when out of service.

1. A separate feeder shall be used for each chemical applied.

2. Spare parts shall be available on site for each type of feeder and chemical booster pump to replace parts which are subject to wear and damage.

B. Control. Feeders may be manually or automatically controlled.

1. Automatic controls shall be designed so as to allow override by manual controls.

2. Chemical feed rates shall be proportional to the flow stream being dosed.

3. A means to measure the flow stream being dosed shall be provided in order to determine chemical feed rates.

4. Provisions shall be made for measuring the quantities of chemicals used.

5. Weighing scales:

a. shall be provided for weighing cylinders at all plants utilizing chlorine gas;

b. shall be required for fluoride solution fed from supply drums or carboys;

c. should be provided for volumetric dry chemical feeders;

d. shall be capable of providing reasonable precision in relation to average daily dose; and

e. shall not be required for chlorine gas cylinders when used as a backup or standby source of chlorine gas.

6. Where conditions warrant, for example with rapidly fluctuating intake turbidity, coagulant and coagulant aid addition may be made according to turbidity, streaming current or other sensed parameter.

C. Dry Chemical Feeders. Dry chemical feeders shall:

1. measure chemicals volumetrically (see §203.B.5.c of this Part) or gravimetrically;

2. provide adequate solution/slurry water and agitation of the chemical at the point of placing in solution/slurry; and

3. completely enclose chemicals to reduce emission of dust to the operating room.

D. Positive Displacement Solution Feed Pumps. Positive displacement type solution feed pumps should be used to feed liquid chemicals.

1. Pumps shall be capable of operating at the required maximum rate against the maximum head conditions found at the point of injection.

2. Equipment utilized to readily measure feed rates in the pumped liquid shall be designed to handle the liquid being measured and shall be provided.

3. A pressure relief valve should be provided on the pump discharge line.

E. Siphon Control for Liquid Chemical Feeders. Liquid chemical feeders shall be such that chemical solutions cannot be siphoned or overfed into the water supply, by:

1. assuring discharge at a point of positive pressure;
 2. providing vacuum relief;
 3. providing a suitable air gap, or anti-siphon device;
- or
4. providing other suitable means or combinations as necessary.

F. Cross-connection control shall be provided to assure that:

1. the service water lines discharging to liquid storage tanks shall be properly protected from backflow as required by the state health officer;

2. chemical solutions or slurries cannot be siphoned through liquid chemical feeders into the water supply as required in §203.E of this Part;

3. no direct connection exists between any sewer and a drain or overflow from the liquid chemical feeder, liquid

storage chamber or tank by providing that all drains terminate at least six inches or two pipe diameters, whichever is greater, above the overflow rim of a receiving sump, conduit or waste receptacle;

4. in the absence of other cross connection control measures, separate feeders shall be provided for chemical feed systems that have feed points at both unfiltered and filtered water locations such that all unfiltered water feed points are fed from one feeder, and that all filtered water feed points are fed from another feeder.

G. Location. Chemical feed equipment:

1. shall be readily accessible for servicing, repair, and observation of operation;

2. should be located in a separate room if hazards and dust problems may exist; and

3. should be conveniently located near points of application to minimize length of feed lines.

H. In-plant water supply shall be:

1. ample in quantity and adequate in pressure;
2. provided with means for measurement when preparing specific solution concentrations by dilution;

3. properly treated for hardness, when necessary;

4. properly protected against backflow; and

5. obtained from the finished water supply, or from a location sufficiently downstream of any chemical feed point to assure adequate mixing.

I. Supply and Storage of Chemicals. A minimum of 10 days of chemical supply shall be on site at all times that will allow the facility to satisfy a maximum average day demand for all 10 days. Additional supply of chemicals that will not degrade is recommended. Chemicals for which the EPA has established a threshold quantity for risk management plan purposes need not be stored on site provided the system has a plan in place for effective timely deliveries of such chemicals.

1. Storage space shall:
 - a. be convenient and provide for efficient handling of chemicals;

b. have dry storage conditions; and

c. provide a minimum storage volume of 1.5 truck loads where purchase can only be made by truck load lots.

2. Storage tanks and pipelines for liquid chemicals shall be specified for use with individual chemicals and not used for different chemicals. Offloading areas shall be clearly labeled to prevent accidental cross-contamination.

3. Chemicals shall be stored in covered or unopened shipping containers, unless the chemical is transferred into an approved storage unit.

4. Liquid chemical storage tanks shall:
 - a. have a means to readily determine the volume of liquid retained in the storage tank; and

b. have an overflow and a receiving basin capable of receiving accidental spills or overflows without uncontrolled discharge; a common receiving basin may be provided for each group of compatible chemicals, which provides sufficient containment volume to prevent accidental discharge in the event of failure of the largest tank.

J. Bulk Liquid Storage Tanks. Bulk liquid storage tanks shall comply with the following requirements.

1. A means which is consistent with the nature of the chemical stored shall be provided in a liquid storage tank to maintain a uniform chemical strength. Continuous agitation shall be provided to maintain slurries in suspension.

2. A means to assure continuity of chemicals to treat the water to comply with federal primary drinking water standards and state drinking water regulations shall be provided while servicing a liquid storage tank.

3. A means shall be provided to readily measure the liquid level in the liquid storage tank.

4. Liquid storage tanks shall have a lid. Large liquid storage tanks with access openings shall have such openings curbed and fitted with overhanging covers or, bolted and gasketed manways.

5. Subsurface locations for liquid storage tanks shall:

- a. be free from sources of possible contamination; and
- b. assure positive drainage away from the area for ground waters, accumulated water, chemical spills and overflows.

6. Overflow pipes, when provided, shall:

- a. be turned downward, with the end screened;
- b. have a free fall discharge; and
- c. be located where noticeable.

7. Liquid storage tanks must be vented, but not through vents in common with other chemicals or day tanks. Acid storage tanks shall be vented to the outside atmosphere.

8. Each liquid storage tank shall be provided with a method to be drained.

9. Each liquid storage tank shall be protected against contamination by cross-connections.

10. Liquid storage tanks shall be located and secondary containment provided so that chemicals from equipment failure, spillage or accidental drainage shall not enter the water in conduits, treatment or storage basins. Secondary containment volumes shall be able to hold the volume of the largest storage tank. Piping shall be designed to minimize or contain chemical spills in the event of pipe ruptures.

K. Overfeed Protection. Overfeed protection shall be provided and comply with the following requirements.

1. An LDH-approved overfeed process control and/or procedure shall be provided for liquid chemical feeds. The process control and/or procedure must be in addition to the requirements of §203.E (siphon control) of this Part. When

day tanks are used for overfeed protection, day tanks shall meet requirements of §203.K.3 of this Part.

2. Day tanks shall be provided when bulk storage of fluoride is used.

3. When day tanks are used, all day tanks shall meet all of the following requirements and requirements of §203.J of this Part, except that shipping containers do not require §203.J.6 (overflow pipes) and §203.J.8. (drain method) and day tanks do not require secondary containment.

a. Day tanks should hold no more than a 30 hour supply.

b. Day tanks shall be scale-mounted, or have a calibrated gauge painted or mounted on the side if liquid level can be observed in a gauge tube or through translucent sidewalls of the tank. In opaque tanks, a gauge rod may be used.

c. Except for fluorosilicic acid, hand pumps may be provided for transfer from a shipping container. A tip rack may be used to permit withdrawal into a bucket from a spigot.

d. A means which is consistent with the nature of the chemical solution shall be provided to maintain uniform chemical strength in a day tank. Continuous agitation shall be provided to maintain chemical slurries in suspension.

e. Tanks and tank refilling line entry points shall be clearly labeled with the name of the chemical contained.

f. Filling of day tanks shall not be automated, unless redundancy of controls is provided.

g. Where motor-driven transfer pumps are provided, an automated means to prevent an overflow shall be provided.

L. Feed Lines. Feed lines:

1. should be as short as possible;
2. should be of durable, corrosion-resistant material;
3. be easily accessible throughout the entire length;
4. be readily cleanable;
5. shall be protected from freezing;
6. should slope upward from the chemical source to the feeder when conveying gases;
7. shall be designed consistent with scale-forming or solids depositing properties of the water, chemical, solution or mixtures conveyed; and
8. should be color coded and labeled.

M. Handling. Carts, elevators and other appropriate means shall be provided for lifting chemical containers to minimize excessive lifting by operators.

1. Provisions shall be made for disposing of empty bags, drums, carboys, or barrels by an approved procedure which will minimize exposure to dusts.

2. Provisions shall be made for the proper transfer of dry chemicals from shipping containers to storage bins or

hoppers, in such a way as to minimize the quantity of dust which may enter the room in which the equipment is installed. Control should be provided by use of:

- a. vacuum pneumatic equipment or closed conveyor systems;
 - b. facilities for emptying shipping containers in special enclosures, and/or;
 - c. exhaust fans and dust filters.
3. Provision shall be made for measuring quantities of chemicals used to prepare feed solutions.

N. Housing. Housing of feed equipment shall comply with the following.

1. Floor surfaces shall be smooth and impervious, slip-proof and well drained.
2. Vents from feeders, storage facilities and equipment exhaust shall discharge to the outside atmosphere above grade and remote from air intakes.

AUTHORITY NOTE: Promulgated in accordance with the provisions of R.S. 40:4(A)(8), 40:4.13.D.(1)(2) and 40:5(A)(2)(3)(5)(6)(7)(17).

HISTORICAL NOTE: Promulgated by the Department of Health, Office of Public Health, LR 44:327 (February 2018), effective August 1, 2018.

§205. Chemicals

A. Chemical shipping containers shall be fully labeled to include:

1. chemical name, purity and concentration; and
2. supplier name and address.

B. Chemicals shall meet the appropriate ANSI/AWWA standards and/or be certified to NSF/ANSI Standard 60.

C. The state health officer may require assay of chemicals.

AUTHORITY NOTE: Promulgated in accordance with the provisions of R.S. 40:4(A)(8), 40:4.13(D)(1)(2) and 40:5(A)(2)(3)(5)(6)(7)(17).

HISTORICAL NOTE: Promulgated by the Department of Health, Office of Public Health, LR 44:330 (February 2018), effective August 1, 2018.

§207. Operator Safety

A. Special provisions shall be made for ventilation of chlorine feed and storage rooms.

B. Respiratory protection equipment shall:

1. meet the requirements of the National Institute for Occupational Safety and Health (NIOSH);
2. be available where chlorine gas is handled;
3. shall be stored at a convenient heated location, but not be stored inside any room where chlorine is used or stored; and
4. if compressed air is used shall have at least a 30 minute capacity.

C. Leak detection for chlorine gas. A bottle of concentrated ammonium hydroxide (56 per cent ammonia

solution) shall be available for chlorine leak detection; where ton containers are used, a leak repair kit approved by the Chlorine Institute shall be provided. Where pressurized chlorine gas is present, continuous chlorine leak detection equipment is required and shall be equipped with both an audible alarm and a warning light.

D. Other protective equipment shall be provided as follows.

1. At least one pair of rubber gloves, a dust respirator of a type certified by NIOSH for toxic dusts, an apron or other protective clothing and goggles or face mask shall be provided for each operator on duty.

2. An appropriate deluge shower and eye washing device shall be installed where strong acids and alkalis are used or stored.

3. Other protective equipment should be provided as necessary.

AUTHORITY NOTE: Promulgated in accordance with the provisions of R.S. 40:4(A)(8), 40:4.13.D.(1)(2) and 40:5(A)(2)(3)(5)(6)(7)(17).

HISTORICAL NOTE: Promulgated by the Department of Health, Office of Public Health, LR 44:330 (February 2018), effective August 1, 2018.

§209. Specific Chemicals

A. Chlorine Gas. Chlorinators should be housed in a room separate from but adjacent to the chlorine storage room.

1. Chlorinator rooms should be heated to 60°F, and be protected from excessive heat. Cylinders and gas lines should be protected from temperatures above that of the feed equipment.

2. Both the chlorine gas feed and storage rooms should be located in a corner of the building on the prevailing downwind side of the building and be away from entrances, windows, louvers, walkways, etc.

3. If chlorine gas feed and storage is enclosed, the chlorine gas shall be separated from other operating areas. Both the feed and storage rooms shall be constructed so as to meet the following requirements:

a. a shatter resistant inspection window shall be installed in an interior wall unless secondary containment is provided for chlorine gas;

b. all openings between the rooms and the remainder of the plant shall be sealed;

c. doors shall be equipped with panic hardware, assuring ready means of exit and opening outward only to the building exterior;

d. a ventilating fan with a capacity to complete one air change per minute when the room is occupied; where this is not appropriate due to the size of the room, a lesser rate may be considered;

e. the ventilating fan shall take suction near the floor and as great a distance as is practical from the door and air inlet, with the point of discharge located so as not to contaminate air inlets to any rooms or structures;

f. air inlets with corrosion resistant louvers shall be installed near the ceiling;

g. air intake and exhaust louvers shall facilitate airtight closure;

h. separate switches for the ventilating fan and for the lights shall be located outside and at the inspection window. Outside switches must be protected from vandalism. A signal light indicating ventilating fan operation shall be provided at each entrance when the fan can be controlled from more than one point;

i. vents from chlorinator and storage areas must be screened and discharge to the outside atmosphere, above grade;

j. floor drains are discouraged. Where provided, the floor drains must discharge to the outside of the building and not be connected to other internal or external drainage systems; and

k. provisions should be made to chemically neutralize chlorine gas where feed and/or storage is located near residential or developed areas in the event of any measured chlorine release. The equipment must be sized to treat the entire contents of the largest storage container on site.

4. Chlorine gas not stored in a room shall be:

a. protected from direct sunlight and windblown debris;

b. shielded from public view;

c. located inside a fenced and secure area;

d. secured in a fixed position, and

e. all chlorine pipelines shall be under vacuum with no pressure chlorine lines allowed.

5. Chlorine gas feed systems shall be of the vacuum type and include the following.

a. vacuum regulators on all individual cylinders in service; and

b. service water to injectors/eductors shall be of adequate supply and pressure to operate feed equipment within the needed chlorine dosage range for the proposed system.

6. Pressurized chlorine feed lines shall not carry chlorine gas beyond the chlorinator room.

7. Full and empty cylinders of chlorine gas shall meet the following requirements:

a. housed only in the chlorine storage room or designated area conforming with §209.A.4 of this Part;

b. isolated from operating areas;

c. restrained in position;

d. stored in locked and/or secure rooms separate from ammonia storage; and

e. protected from direct sunlight or exposure to excessive heat.

B. Acids and Caustics. Acids and caustics shall:

1. be kept in closed corrosion-resistant shipping containers or bulk liquid storage tanks; and

2. not be handled in open vessels, but should be pumped in undiluted form to and from bulk liquid storage tanks and covered day tanks or from shipping containers through suitable hoses, to the point of treatment.

C. Sodium chlorite for chlorine dioxide generation. Proposals for the storage and use of sodium chlorite shall be approved by the state health officer prior to the preparation of final plans and specifications. Provisions shall be made for proper storage and handling of sodium chlorite to eliminate any danger of fire or explosion associated with its powerful oxidizing nature.

1. Storage. The storage of sodium chlorite shall comply with the following.

a. Sodium chlorite shall be stored by itself in a separate room and preferably shall be stored in an outside building detached from the water treatment facility. It shall be stored away from organic materials because many materials will catch fire and burn violently when in contact with sodium chlorite.

b. The storage structures shall be constructed of noncombustible materials.

c. If the storage structure shall be located in an area where a fire may occur, water shall be available to keep the sodium chlorite area cool enough to prevent heat induced explosive decomposition of the sodium chlorite.

2. Handling. The criteria for handling of sodium chlorite is as follows.

a. Care should be taken to prevent spillage.

b. An emergency plan of operation should be available for the clean-up of any spillage.

c. Storage drums shall be thoroughly flushed to an acceptable drain prior to recycling or disposal.

3. Feeders. Feeders shall comply with the following requirements.

a. Positive displacement feeders shall be provided.

b. Tubing for conveying sodium chlorite or chlorine dioxide solutions shall be Type 1 PVC, polyethylene or materials recommended by the manufacturer.

c. Chemical feeders may be installed in chlorine rooms if sufficient space is provided or in separate rooms meeting the requirements of §209.A.3 of this Part.

d. Feed lines shall be installed in a manner to prevent formation of gas pockets and shall terminate at a point of positive pressure.

e. Check valves shall be provided to prevent the backflow of chlorine into the sodium chlorite line.

D. Sodium Hypochlorite. Sodium hypochlorite storage and handling procedures should be arranged to minimize the slow natural decomposition process of sodium hypochlorite

either by contamination or by exposure to more extreme storage conditions. In addition, feed rates should be regularly adjusted to compensate for this progressive loss in chlorine content.

1. Storage. The storage of sodium hypochlorite shall comply with the following.

a. Sodium hypochlorite shall be stored in the original shipping containers or in sodium hypochlorite compatible bulk liquid storage tanks.

b. Storage containers or tanks shall be located out of the sunlight in a cool area and shall be vented to the outside of the building when enclosed.

c. Wherever reasonably feasible, stored sodium hypochlorite shall be pumped undiluted to the point of addition. Where dilution is utilized, deionized or softened water should be used.

d. Storage areas, tanks, and pipe work shall be designed to avoid the possibility of uncontrolled discharges.

e. Reusable sodium hypochlorite storage containers shall be reserved for use with sodium hypochlorite only and shall not be exposed to contamination.

2. Feeders. Sodium hypochlorite feeders shall comply with the following.

a. Positive displacement pumps with sodium hypochlorite compatible materials for wetted surfaces shall be used.

b. To avoid air locking in smaller installations, small diameter suction lines shall be used with foot valves and degassing pump heads as required.

c. In larger installations flooded suction shall be used with pipe work arranged to ease escape of gas bubbles.

d. Calibration tubes or mass flow monitors which allow for direct physical checking of actual feed rates shall be provided.

e. Injectors shall be made removable for regular cleaning where hard water is to be treated.

E. Ammonia. Ammonia for chloramine formation may be added to water either as a water solution of ammonium sulfate, or as aqua ammonia, or as anhydrous ammonia (purified 100 percent ammonia in liquid or gaseous form). Special provisions required for each form of ammonia are listed below.

1. Ammonium Sulfate. A water solution is made by addition of ammonium sulfate solid to water with agitation. The tank and dosing equipment contact surfaces should be made of corrosion resistant non-metallic materials. Provision should be made for removal of the agitator after dissolving the solid. The tank should be fitted with an air-tight lid and vented outdoors. The application point should be at the center of treated water flow at a location where there is high velocity movement.

2. Aqua Ammonia (ammonium hydroxide). When the exception criteria in §209.E.2.i of this Part is not met, Aqua ammonia feed pumps and storage shall be enclosed and

separated from other operating areas. The aqua ammonia room shall conform to §209.A.3 of this Part and to the following:

a. corrosion resistant, closed, pressurized tank shall be used for bulk liquid storage and day tanks, vented through inert liquid traps to a high point outside;

b. an incompatible connector or lockout provisions shall be provided to prevent accidental addition of other chemicals to the bulk liquid storage tank(s);

c. the bulk liquid storage tank(s) should be designed to avoid conditions where temperature increases cause the ammonia vapor pressure over the aqua ammonia to exceed atmospheric pressure. Such provisions shall include either:

i. refrigeration or other means of external cooling, and/or;

ii. dilution and mixing of the contents with water without opening the bulk liquid storage tank.

d. An exhaust fan shall be installed to withdraw air from high points in the room and makeup air shall be allowed to enter at a low point.

e. The aqua ammonia feed pump, regulators, and lines shall be fitted with pressure relief vents discharging outside the building away from any air intake and with water purge lines leading back to the headspace of the bulk storage tank.

f. The application point should be placed in a region of rapid, preferably turbulent, water flow.

g. Provisions should be made for easy access for removal of calcium scale deposits from the injector.

h. Provision of a modestly-sized scrubber capable of handling occasional minor emissions should be considered.

i. An exception to the requirement for enclosing aqua ammonia shall be made when aqua ammonia is stored in a manner which satisfies all of the following criteria:

i. protection is provided from direct sunlight and windblown debris;

ii. shielded from public view;

iii. located inside a fenced and secured area; and

iv. secured in a fixed position.

3. Anhydrous Ammonia. Anhydrous ammonia is readily available as a pure liquefied gas under moderate pressure in cylinders or as a cryogenic liquid boiling at -15° Celsius at atmospheric pressure. The liquid causes severe burns on skin contact.

a. When the exception criteria in §209.E.3.i of this Part is not met, anhydrous ammonia storage and feed systems (including heaters where required) shall be enclosed and separated from other works areas and constructed of corrosion resistant materials. Bulk anhydrous ammonia storage tanks holding more than 500 gallons shall not be located in an enclosed area.

b. An emergency air exhaust system, as in §209.A.3 of this Part but with an elevated intake, shall be provided in the ammonia storage room.

c. Leak detection systems shall be provided in all areas through which ammonia is piped.

d. Special vacuum breaker/regulator provisions must be made to avoid potentially violent results of backflow of water into cylinders or storage tanks.

e. Carrier water systems of soft or pre-softened water may be used to transport ammonia to the application point and to assist in mixing.

f. The ammonia injector should use a vacuum eductor or should consist of a perforated tube fitted with a closely fitting flexible rubber tubing seal punctured with a number of small slits to delay fouling by lime or other scale deposits.

g. Provision should be made for the periodic removal of lime or other scale deposits from injectors and carrier piping.

h. Consideration should be given to the provision of an emergency gas scrubber capable of absorbing the entire contents of the largest anhydrous ammonia storage unit whenever there is a risk to the public as a result of potential ammonia leaks.

i. An exception to the requirement for enclosing anhydrous ammonia shall be made when anhydrous ammonia is stored in a manner which satisfies all of the following criteria:

- i. protection is provided from direct sunlight and windblown debris;
- ii. shielded from public view;
- iii. located inside a fenced and secured area, and
- iv. secured in a fixed position.

F. Potassium Permanganate. Design criteria for potassium permanganate is as follows.

1. A source of heated water should be available for dissolving potassium permanganate, and

2. mechanical mixers shall be provided.

G. Fluoride. Sodium fluoride, sodium silicofluoride and fluorosilicic acid shall conform to the applicable AWWA Standards and be certified to NSF/ANSI Standard 60. Other fluoride compounds which may be available shall be approved by the state health officer.

1. Storage. Design criteria for storage of fluoride compounds is as follows.

a. Fluoride chemicals should be isolated from other chemicals to prevent contamination.

b. Compounds shall be stored in covered or unopened shipping containers and should be stored inside a building.

c. Unsealed storage units for fluorosilicic acid should be vented to the atmosphere at a point outside any

building. The vents to atmosphere shall be provided with a corrosion resistant 24 mesh screen.

d. Bags, fiber drums and steel drums should be stored on pallets.

2. Chemical Feed Equipment and Methods. Design criteria for chemical feed and methods for fluoride compounds is as follows.

a. At least two diaphragm operated anti-siphon devices shall be provided on all fluoride saturator or fluorosilicic acid feed systems.

i. one diaphragm operated anti-siphon device shall be located on the discharge side of the feed pump; and

ii. a second diaphragm operated anti-siphon device shall be located at the point of application unless a suitable air gap is provided.

b. A physical break box may be required in high hazard situations where the application point is substantially lower than the metering pump. In this situation, either a dual head feed pump or two separate pumps are required and the anti-siphon device at the discharge side of the pump may be omitted.

c. Scales, loss-of-weight recorders or liquid level indicators, as appropriate, accurate to within five percent of the average daily change in reading shall be provided for chemical feeds.

d. Feeders shall be accurate to within five percent of any desired feed rate.

e. Fluoride compound shall not be added before lime-soda softening or ion exchange softening.

f. The point of application if into a horizontal pipe, shall be in the lower half of the pipe, preferably at a 45 degree angle from the bottom of the pipe and protrude into the pipe one third of the pipe diameter.

g. Except for constant flow systems, a device to measure the flow of water to be treated is required.

h. Water used for sodium fluoride dissolution shall be softened if hardness exceeds 75 mg/L as calcium carbonate.

i. Fluoride solutions shall be injected at a point of continuous positive pressure unless a suitable air gap is provided.

j. The electrical outlet used for the fluoride feed pump should have a nonstandard receptacle and shall be interconnected with the well or service pump, or have flow pacing as allowed by the state health officer,

k. Saturators should be of the upflow type and be provided with a meter and backflow protection on the makeup water line.

1. Consideration shall be given to providing a separate room for fluorosilicic acid storage and feed.

3. Secondary control systems for fluoride chemical feed devices shall be provided as a means of reducing the

possibility for overfeed; these may include flow or pressure switches, break boxes, or other devices.

4. Personal protective equipment as outlined in §207.D of this Part shall be provided for operators handling fluoride compounds. Deluge showers and eye wash devices shall be provided at all fluorosilicic acid installations.

5. Dust control requirements are as follows.

a. Provision shall be made for the transfer of dry fluoride compounds from shipping containers to storage bins or hoppers in such a way as to minimize the quantity of fluoride dust which may enter the room in which the equipment is installed. The enclosure shall be provided with an exhaust fan and dust filter which places the hopper under a negative pressure. Air exhausted from fluoride handling equipment shall discharge through a dust filter to the outside atmosphere of the building.

b. Provision shall be made for disposing of empty bags, drums or barrels in a manner which will minimize exposure to fluoride dusts. A floor drain should be provided to facilitate the washing of floors.

6. Equipment shall be provided for measuring the quantity of fluoride in the water. Such equipment shall be subject to the approval of the state health officer.

H. Activated carbon is a potentially combustible material requiring isolated storage.

1. Storage facilities should be:

a. fire proof; and

b. equipped with explosion-proof electrical outlets, lights and motors in areas of dry handling.

2. Bags of powdered carbon should be stacked in rows with aisles between in such a manner that each bag is accessible for removal in case of fire.

AUTHORITY NOTE: Promulgated in accordance with the provisions of R.S. 40:4(A)(8), 40:4.13.D.(1)(2) and 40:5(A)(2)(3)(5)(6)(7)(17).

HISTORICAL NOTE: Promulgated by the Department of Health, Office of Public Health, LR 44:330 (February 2018), effective August 1, 2018.

Subchapter B. Pumping Facilities

§211. General

A. Pumping facilities shall be designed to maintain the sanitary quality of pumped water.

B. Subsurface pits or pump rooms and inaccessible installations should be avoided.

C. No pumping station shall be subject to flooding, unless critical components are protected from damage or contamination by inundation.

AUTHORITY NOTE: Promulgated in accordance with the provisions of R.S. 40:4(A)(8), 40:4.13.D.(1)(2) and 40:5(A)(2)(3)(5)(6)(7)(17).

HISTORICAL NOTE: Promulgated by the Department of Health, Office of Public Health, LR 44:333 (February 2018), effective August 1, 2018.

§213. Site Protection

A. The station's critical components that could be damaged or contaminated by inundation shall be:

1. elevated to a minimum of two foot above the 100-year flood elevation, or protected to such elevations including the use of a levee system;

2. readily accessible at all times unless permitted to be out of service for the period of inaccessibility;

3. graded around the station so as to lead surface drainage away from the station;

4. protected to prevent vandalism and entrance by animals or unauthorized persons. The pump station should be located within a secure area such as a locked building or fenced area;

5. labeled such that the pumps and valves in the station are tagged to correspond to the maintenance record and for proper identification.

AUTHORITY NOTE: Promulgated in accordance with the provisions of R.S. 40:4(A)(8), 40:4.13.D.(1)(2) and 40:5(A)(2)(3)(5)(6)(7)(17).

HISTORICAL NOTE: Promulgated by the Department of Health, Office of Public Health, LR 44:333 (February 2018), effective August 1, 2018.

§215. Pumping Stations

A. Both raw and finished water pumping stations shall:

1. be of durable construction, fire and weather resistant;

2. have any underground structure waterproofed

3. have all floors slope to a suitable drain in such a manner that the quality of the potable water will not be endangered;

4. provide a suitable outlet for drainage without allowing discharge across the floor, including pumping glands, vacuum air relief valves, etc.

B. A suction well is a component(s) designed to facilitate the suction of water by way of pump excluding intake structures, ground storage tanks and clearwells. Suction wells shall:

1. be watertight;

2. have floors sloped to permit removal of water and settled solids;

3. be covered or otherwise protected against contamination; and

4. have two pumping compartments or other means to allow the suction well to be taken out of service for inspection maintenance or repair.

C. Equipment servicing pump stations shall:

1. provide adequate facilities or other means for servicing or removal of pumps, motors or other heavy equipment; and

2. have openings in floors, roofs or wherever else needed for removal of heavy or bulky equipment.

D. Stairways or ladders shall:

1. be provided between all floors, and in dry pits or compartments which must be entered; and
2. conform to the applicable requirements of the state and local building codes.

AUTHORITY NOTE: Promulgated in accordance with the provisions of R.S. 40:4(A)(8), 40:4.13.D.(1)(2) and 40:5(A)(2)(3)(5)(6)(7)(17).

HISTORICAL NOTE: Promulgated by the Department of Health, Office of Public Health, LR 44:333 (February 2018), effective August 1, 2018.

§217. Pumps

A. Where necessary to meet minimum system requirements such as pressure, at least two pumping units shall be provided. With any pump out of service, the remaining pump or pumps shall be capable of providing the maximum design capacity of that station.

B. The pumping units shall:

1. have ample capacity to supply the peak demand against the required distribution system pressure without dangerous overloading;
2. be driven by prime movers able to meet the maximum horsepower condition of the pumps;
3. be provided with readily available spare parts and tools;
4. be served by control equipment that has proper heater and overload protection for air temperature encountered.

C. Prime water must not be of lesser sanitary quality than that of the water being pumped. Means shall be provided to prevent either backpressure or backsiphonage backflow. When an air-operated ejector is used, the screened intake shall draw clean air from a point at least 10 feet above the ground or other source of possible contamination, unless the air is filtered by an apparatus approved by the state health officer. Vacuum priming may be used.

AUTHORITY NOTE: Promulgated in accordance with the provisions of R.S. 40:4(A)(8), 40:4.13.D.(1)(2) and 40:5(A)(2)(3)(5)(6)(7)(17).

HISTORICAL NOTE: Promulgated by the Department of Health, Office of Public Health, LR 44:334 (February 2018), effective August 1, 2018.

§219. Booster Pumps

A. Booster pumps shall be located or controlled so that:

1. they will not produce negative pressure in their suction lines;
2. pumps taking suction from storage tanks shall be provided adequate net positive suction head;
3. pumps taking suction from ground storage tanks shall be equipped with automatic shutoffs or low pressure controllers as recommended by the pump manufacturer;
4. automatic or remote control devices shall have a range between the start and cutoff pressure which will prevent excessive cycling; and

5. a bypass is available.

B. Inline Booster Pumps. In addition to the other requirements of this section, inline booster pumps shall:

1. be accessible for servicing and repairs;
2. maintain inlet pressure installed in the distribution system as required in §237.A of this Part under all operating conditions;
3. maintain at least 20 psig (140 kPa) in the suction line under all operating conditions with automatic shutoff or low pressure controller, unless otherwise acceptable to the state health officer; and
4. have a bypass.

AUTHORITY NOTE: Promulgated in accordance with the provisions of R.S. 40:4(A)(8), 40:4.13.D.(1)(2) and 40:5(A)(2)(3)(5)(6)(7)(17).

HISTORICAL NOTE: Promulgated by the Department of Health, Office of Public Health, LR 44:334 (February 2018), effective August 1, 2018.

§221. Automatic and Remote Controlled Stations

A. All automatic stations shall:

1. be provided with automatic signaling apparatus which will report when the station is out of service; and
2. be electrically operated and controlled and shall have signaling apparatus of proven performance if remotely controlled.

AUTHORITY NOTE: Promulgated in accordance with the provisions of R.S. 40:4(A)(8), 40:4.13.D.(1)(2) and 40:5(A)(2)(3)(5)(6)(7)(17).

HISTORICAL NOTE: Promulgated by the Department of Health, Office of Public Health, LR 44:334 (February 2018), effective August 1, 2018.

§223. Appurtenances

A. Valves. Each pump shall have:

1. an isolation valve on the intake and discharge side of the pump to permit satisfactory operation, maintenance and repair of the equipment;
2. a positive-acting check valve on the discharge side between the pump and the shut-off valve;
 - a. If foot valves are necessary, they shall have a net valve area of at least 2 1/2 times the area of the suction pipe and they shall be screened.
 - b. Surge relief valves or slow acting check valves if used shall be designed to minimize hydraulic transients.

B. Piping. In general, piping shall:

1. be designed so that the friction losses will be minimized;
2. not be subject to contamination;
3. have watertight joints;
4. be protected against surge or water hammer and provided with suitable restraints where necessary; and

5. be designed such that each pump has an individual suction line or that the lines shall be so manifolded that they will insure similar hydraulic and operating conditions.

C. Gauges and Meters. The station shall have a flow rate indicator and totalizing meter, and a method of recording the total water pumped and station water pressure. Each pump:

1. shall have a standard pressure gauge on its discharge line;

2. shall have a compound gauge on its suction line;

D. Water Seals. Water seals shall not be supplied with water of a lesser sanitary quality than that of the water being pumped. Where pumps are sealed with potable water and are pumping water of lesser sanitary quality, the seal shall:

1. be provided with either an approved reduced pressure principle backflow preventer or a break tank open to atmospheric pressure; and

2. where a break tank is provided, have an air gap of at least six inches or two pipe diameters, whichever is greater, between the feeder line and the flood rim of the tank.

E. Controls. Pumps, their prime movers and accessories, shall be controlled in such a manner that they will operate at rated capacity without dangerous overload. Where two or more pumps are installed, provisions shall be made for alternations.

1. Motors shall be equipped with a non-reversing ratchet or other mechanical means to prevent backspin. If mechanical means are not provided, provisions shall be made to prevent energizing the motor in the event of a backspin cycle.

2. Electrical controls shall be located at least two feet above the 100-year flood elevation, but in no case less than two feet above the ground surface.

3. Equipment shall be provided or other arrangements made to prevent surge pressures from activating controls which switch on pumps or activate other equipment outside the normal design cycle of operation.

F. Standby Power. To ensure continuous service when the primary power has been interrupted, a power supply shall be provided from a standby or auxiliary source where necessary to maintain minimum 20 psig pressure throughout the system based on systems average hourly demand during the peak annual day.

1. If standby power is provided by onsite generators or engines, the fuel storage:

a. shall have a minimum supply of 72 hours; and

b. the fuel line must be designed to protect the water supply from contamination (see §135).

G. When automatic pre-lubrication of pump bearings is necessary and an auxiliary power supply is provided, design shall assure that pre-lubrication is provided when auxiliary power is in use, or that bearings can be lubricated manually before the pump is started.

H. All oil or grease lubricants which come into contact with the potable water shall be listed in NSF/ANSI Standard 60.

AUTHORITY NOTE: Promulgated in accordance with the provisions of R.S. 40:4(A)(8), 40:4.13.D.(1)(2) and 40:5(A)(2)(3)(5)(6)(7)(17).

HISTORICAL NOTE: Promulgated by the Department of Health, Office of Public Health, LR 44:334 (February 2018), effective August 1, 2018.

Subchapter C. Finished Water Storage

§225. General

A. The materials and designs used for finished water storage structures shall provide stability and durability as well as protect the quality of the stored water.

B. Steel structures shall be constructed in accordance with the American Water Works Association (AWWA) standards, incorporated by reference into these rules (see §277 for referenced standards) concerning steel tanks, standpipes, reservoirs, and elevated tanks wherever they are applicable. Other materials of construction are acceptable when properly designed to meet the requirements of this Subchapter.

C. Sizing. The following criteria applies to the sizing of storage facilities.

1. Storage facilities should have sufficient capacity, as determined from engineering studies, to meet domestic demands, and where fire protection is provided, fire flow demands.

2. The minimum storage capacity (or equivalent capacity) for systems not providing fire protection shall be equal to the average daily consumption.

a. This requirement may be reduced when the source and treatment facilities have sufficient capacity with standby power to supplement peak demands of the system.

3. Excessive storage capacity should be avoided to prevent potential water quality deterioration problems.

D. Location of Reservoirs. The following criteria applies to the location of reservoirs.

1. Ground level reservoirs shall be protected from contamination to a point two feet above the 100-year flood elevation requirements and from groundwater infiltration. Sewers, drains, standing water, and similar sources of possible contamination must be kept at least 50 feet from the reservoir. Gravity sewers constructed of water main quality pipe, pressure tested in place without leakage, may be used at distances greater than 20 feet but less than 50 feet.

2. The bottom of ground level reservoirs and standpipes should be placed at the normal ground surface. If the bottom of a storage reservoir shall be below the normal ground surface, at least 50 percent of the water depth must be above grade.

3. The top of a partially buried storage structure shall not be less than two feet above normal ground surface. Clearwells constructed under filters may be exempted from

this requirement when the design provides adequate protection from contamination.

E. Protection from Contamination. All finished water storage structures shall have suitable watertight roofs which exclude birds, animals, insects, and excessive dust. The installation of appurtenances, such as antenna, shall be done in a manner that ensures no damage to the tank, coatings or water quality, or corrects any damage that occurred.

F. Protection from Trespassers. Fencing, locks on access manholes, and other necessary precautions shall be provided to prevent trespassing, vandalism, and sabotage. Consideration should be given to the installation of high strength, cut resistant locks or lock covers to prevent direct cutting of a lock.

G. Drains. No drain on a water storage structure may have a direct connection to a sewer or storm drain. The design shall allow draining the storage facility for cleaning or maintenance without causing loss of pressure in the distribution system.

H. Stored Water Age. Finished water storage designed to facilitate fire flow requirements and meet average daily consumption shall be designed to minimize stagnation and/or stored water age.

1. Consideration shall be given to separate inlet and outlet pipes, mechanical or similar mixing, or other acceptable means to prevent poor water circulation and long detention times that can lead to loss of disinfectant residual, microbial growth, formation of disinfectant byproducts, taste and odor problems, and other water quality problems.

I. Overflow. Water storage structure overflow shall comply with the following.

1. All water storage structures shall be provided with an overflow which is brought down to an elevation between 12 and 24 inches above the ground surface, and discharges over a drainage inlet structure or a splash plate. No overflow may be connected directly to a sewer or a storm drain. All overflow pipes shall be located so that any discharge is visible.

2. Certain pre-stressed concrete tanks having an overflow opening installed on the top or side of the tank shall not be required to have an internal overflow pipe as long as each opening is covered with an "eyelid" that prevents contamination of the water in the tank. The discharge from such overflow openings shall still be required to discharge over a splash plate large enough to prevent erosion of the tank's foundation or any other support structures. Caution shall be taken to ensure that any overflow down the outside of the tank will not affect electrical or cause other safety concerns.

a. When an internal overflow pipe is used on elevated tanks, it should be located in the access tube. For vertical drops on other types of storage facilities, the overflow pipe should be located on the outside of the structure.

b. The overflow for a ground-level storage reservoir shall open downward and be screened with twenty-four

mesh non-corrodible screen. The screen shall be installed within the overflow pipe at a location least susceptible to damage by vandalism.

c. The overflow for an elevated tank shall open downward and be screened with a four mesh, non-corrodible screen to keep out animals or insects. The screen should be installed within the overflow pipe at a location least susceptible to damage by vandalism.

d. The overflow pipe shall be of sufficient diameter to permit waste of water in excess of the filling rate.

J. Access. Finished water storage structures shall be designed with reasonably convenient access to the interior for cleaning and maintenance. At least two (2) manholes shall be provided above the waterline at each water compartment where space permits.

1. Elevated Storage or Dome Roof Structures shall comply with the following.

a. At least one of the access manholes shall be framed at least four inches above the surface of the roof at the opening. They shall be fitted with a solid water tight cover which overlaps the framed opening and extends down around the frame at least two inches, shall be hinged on one side, and shall have a locking device.

b. All other manholes or access ways shall be bolted and gasketed according to the requirements of the state health officer, or shall meet the requirements of Subparagraph a of this Paragraph.

2. Ground Level or Flat Roof Structures shall comply with the following.

a. Each manhole shall be elevated at least 24 inches above the top of the tank or the finished grade of the surrounding ground, whichever is higher.

b. Each manhole shall be fitted with a solid water tight cover which overlaps a framed opening and extends down around the frame at least two inches. The frame shall be at least four inches high. Each cover shall be hinged on one side, and shall have a locking device.

K. Vents. Finished water storage structures shall be vented. The overflow pipe shall not be considered a vent. Open construction between the sidewall and roof is not permissible. The vents:

1. shall prevent the entrance of surface water and rainwater;

2. shall exclude birds and animals;

3. should exclude insects and dust, as much as this function can be made compatible with effective venting;

4. shall, on ground-level structures, open downward with the opening at least 24 inches above the roof and be covered with twenty-four mesh non-corrodible screen. The screen shall be installed within the pipe at a location least susceptible to vandalism;

5. shall, on ground storage tanks, open downward with the opening at least 24 inches above the finished grade of the surrounding ground and be covered with twenty-four

mesh non-corrodible screen. The screen shall be installed within the pipe at a location least susceptible to vandalism; and

6. shall, on elevated tanks and standpipes, open downward, and be fitted with either four mesh non-corrodible screen, or with finer mesh non-corrodible screen in combination with an automatically resetting pressure-vacuum relief mechanism, as required by the state health officer.

L. Roof and Sidewalls. The roof and sidewalls of all water storage structures shall be watertight with no openings except properly constructed vents, manholes, overflows, risers, drains, pump mountings, control ports, or piping for inflow and outflow. Particular attention shall be given to the sealing of roof structures which are not integral to the tank body.

1. Any pipes running through the roof or sidewall of a metal storage structure must be welded, or properly gasketed. In concrete tanks, these pipes shall be connected to standard wall castings which were poured in place during the forming of the concrete. These wall castings should have seepage rings imbedded in the concrete.

2. Openings in the roof of a storage structure designed to accommodate control apparatus or pump columns, shall be curbed and sleeved with proper additional shielding to prevent contamination from surface or floor drainage.

3. Valves and controls should be located outside the storage structure so that the valve stems and similar projections will not pass through the roof or top of the reservoir.

4. The roof of the storage structure shall be well drained. Downspout pipes shall not enter or pass through the reservoir. Parapets, or similar construction which would tend to hold water and snow on the roof, will not be approved unless adequate waterproofing and drainage are provided.

5. The roof of concrete reservoirs with earthen cover shall be sloped to facilitate drainage. Consideration should be given to installation of an impermeable membrane roof covering.

6. Reservoirs with pre-cast concrete roof structures must be made watertight with the use of a waterproof membrane or similar product.

M. The material used in construction of reservoirs shall be acceptable to the state health officer. Porous material, including wood and concrete block, are not suitable for potable water contact applications.

N. Safety must be considered in the design of the storage structure. The design shall conform to applicable laws and regulations of the area where the water storage structure is constructed.

1. Ladders, ladder guards, balcony railings, and safely located entrance hatches shall be provided where applicable.

2. Elevated tanks with riser pipes over eight inches in diameter shall have protective bars over the riser openings inside the tank.

3. Confined space entry requirements shall be considered.

O. Freezing. Finished water storage structures and their appurtenances, especially the riser pipes, overflows, and vents, shall be designed to prevent freezing which will interfere with proper functioning.

1. Equipment used for freeze protection that will come into contact with the potable water shall meet NSF/ANSI Standard 61 or be approved by the state health officer.

2. If a water circulation system is used, it is recommended that the circulation pipe be located separately from the riser pipe.

P. Internal Catwalk. Every catwalk over finished water in a storage structure shall have a solid floor with sealed raised edges, designed to prevent contamination from shoe scrapings and dirt.

Q. Silt Stop. The discharge pipes from water storage structures shall be located in a manner that will prevent the flow of sediment into the distribution system. Removable silt stops should be provided.

R. Grading. The area surrounding a ground-level structure shall be graded in a manner that will prevent surface water from standing within 50 feet of it.

S. Painting and/or cathodic protection. Proper protection shall be given to metal surfaces by paints or other protective coatings, by cathodic protective devices, or by both.

1. Paint systems shall meet NSF/ANSI Standard 61 and be acceptable to the state health officer. Interior paint must be applied, cured, and used in a manner consistent with the NSF/ANSI approval. After curing, the coating shall not transfer any substance to the water which will be toxic or cause taste or odor problems. Prior to placing in service, an analysis for volatile organic compounds is advisable to establish that the coating is properly cured. Consideration should be given to 100 percent solids coatings.

2. Wax coatings for the tank interior shall not be used on new tanks or in the rehabilitation of existing tanks. Old wax coating must be completely removed before using another tank coating.

3. Cathodic protection should be designed and installed by competent technical personnel, and a maintenance contract should be provided.

T. Disinfection. Finished water storage structures shall be disinfected in accordance with AWWA Standard C652-11 (see Table 277).

1. If bacteriological testing for coliform organisms is negative and chlorine residuals are at acceptable distribution system levels, the storage tank may be placed into service. If such testing shows the presence of coliform bacteria, the tank cannot be placed into service and repeat samples shall be taken until two consecutive samples, taken at 24-hour intervals, are negative. The tank shall not be placed into service until the sample results are satisfactory.

2. Disposal of heavily chlorinated water from the tank disinfection process shall be in accordance with Paragraph

4.3.5.1 of AWWA Standard C652-11 or in accordance with the requirements of the Louisiana Department of Environmental Quality (LDEQ) or other state or federal authorities, whichever is stricter.

U. Smooth-nosed sampling tap(s) or similar non-threaded stainless steel sampling taps shall be provided to facilitate collection of water samples for both bacteriological and chemical analyses. The sample tap(s) shall be easily accessible.

AUTHORITY NOTE: Promulgated in accordance with the provisions of R.S. 40:4(A)(8), 40:4.13.D.(1)(2) and 40:5(A)(2)(3)(5)(6)(7)(17).

HISTORICAL NOTE: Promulgated by the Department of Health, Office of Public Health, LR 44:335 (February 2018), effective August 1, 2018.

§227. Treatment Plant Storage

A. The applicable design standards of §225 shall be followed for plant storage.

B. Filter Washwater Tanks. Filter washwater tanks shall be sized, in conjunction with available pump units and finished water storage, to provide the backwash water required by §177.A.10 of this Part. Consideration shall be given to the backwashing of several filters in rapid succession.

C. Clearwell. Clearwell storage should be sized, in conjunction with distribution system storage, to relieve the filters from having to follow fluctuations in water use.

1. When finished water storage is used to provide disinfectant contact time (see §179.C) special attention shall be given to tank size and baffling (see §227.C.2)

2. To ensure adequate disinfectant contact time, sizing of the clearwell should include extra volume to accommodate depletion of storage during the nighttime for intermittently operated filtration plants with automatic high service pumping from the clearwell during non-treatment hours.

3. An overflow and vent shall be provided.

a. A minimum of two clearwell compartments shall be provided.

D. Finished or treated water must not be stored or conveyed in a compartment adjacent to untreated or partially treated water when the two compartments are separated by a single wall, unless approved by the state health officer.

E. Unless otherwise allowed by the state health officer, other treatment plant storage tanks/basins such as detention basins, backwash reclaim tanks, receiving basins and pump wet-wells for finished water shall be designed as finished water storage structures.

AUTHORITY NOTE: Promulgated in accordance with the provisions of R.S. 40:4(A)(8), 40:4.13.D.(1)(2) and 40:5(A)(2)(3)(5)(6)(7)(17).

HISTORICAL NOTE: Promulgated by the Department of Health, Office of Public Health, LR 44:337 (February 2018), effective August 1, 2018.

§229. Hydropneumatic Tank Systems

A. Pressure tanks shall meet ASME code requirements or an alternative approved by the state health officer. Any alternative must be rated to at least 1.5 times the maximum discharge pressure of the pump.

B. Location. The tank shall be located above normal ground surface.

C. System Sizing. The following criteria applies to the sizing of hydropneumatic systems.

1. The capacity of the wells and pumps in a hydropneumatic system shall be at least five times the average daily demand expressed in gallons per minute.

2. The gross volume of the hydropneumatic tank, in gallons, shall be at least ten times the capacity of the largest pump, rated in gallons per minute. For example, a 250 gpm pump shall be a minimum of 2,500 gallon pressure tank, unless other measures (e.g., variable speed drives in conjunction with the pump motors) are provided to meet the maximum demand.

3. Sizing of hydropneumatic storage tanks must consider the need for disinfectant contact time.

D. The hydropneumatic tank(s) shall have bypass piping to permit operation of the system while the tank is being repaired or painted.

E. Appurtenances. Each tank shall have an access manhole, a drain, and control equipment consisting of a pressure gauge, water sight glass, automatic or manual air blow-off, means for adding air, and pressure operated start-stop controls for the pumps.

1. A pressure relief valve shall be installed and be capable of handling the full pumpage rate of flow at the pressure vessel design limit.

2. Where practical the access manhole should be 24 inches in diameter. The water sight glass shall not be mandatory if an automated control to maintain the proper water-to-air ratio in the tank is provided.

AUTHORITY NOTE: Promulgated in accordance with the provisions of R.S. 40:4(A)(8), 40:4.13.D.(1)(2) and 40:5(A)(2)(3)(5)(6)(7)(17).

HISTORICAL NOTE: Promulgated by the Department of Health, Office of Public Health, LR 44:338 (February 2018), effective August 1, 2018.

§231. Distribution System Storage

A. The applicable design standards of §225 of this Part shall be followed for distribution system storage.

B. Pressures. The maximum variation between high and low levels in storage structures providing pressure to a distribution system should not exceed 30 feet. The minimum working pressure in the distribution system shall be 20 psi gauge and the normal working pressure should be approximately 60 to 80 psi gauge. When static pressures exceed 100 psi gauge, pressure reducing devices shall be provided on mains or as part of the meter setting on individual service lines in the distribution system.

C. Drainage. Finished water storage structures which provide pressure directly to the distribution system shall be designed so they can be isolated from the distribution system and drained for cleaning or maintenance without causing a loss of pressure in the distribution system. The storage structure drain shall discharge to the ground surface with no direct connection to a sewer or storm drain.

D. Level Controls. Adequate controls shall be provided to maintain levels in distribution system storage structures. Level indicating devices should be provided at a central location.

1. Pumps should be controlled from tank levels with the signal transmitted by telemetering equipment when any appreciable head loss occurs in the distribution system between the source and the storage structure.

2. Altitude valves or equivalent controls may be required for second and subsequent structures on the system.

3. Overflow and low-level warnings or alarms should be located where they will be under responsible surveillance 24 hours a day.

AUTHORITY NOTE: Promulgated in accordance with the provisions of R.S. 40:4(A)(8), 40:4.13.D.(1)(2) and 40:5(A)(2)(3)(5)(6)(7)(17).

HISTORICAL NOTE: Promulgated by the Department of Health, Office of Public Health, LR 44:338 (February 2018), effective August 1, 2018.

Subchapter D. Distribution System Piping and Appurtenances

§233. General

A. All potable water distribution systems shall be designed, constructed, and maintained so as to prevent leakage of water due to defective materials, improper jointing, corrosion, settling, impacts, freezing, or other causes.

B. Valves and blow-offs shall be provided so that necessary repairs can be made with a minimum interruption of service.

AUTHORITY NOTE: Promulgated in accordance with the provisions of R.S. 40:4(A)(8), 40:4.13.D.(1)(2) and 40:5(A)(2)(3)(5)(6)(7)(17).

HISTORICAL NOTE: Promulgated by the Department of Health, Office of Public Health, LR 44:338 (February 2018), effective August 1, 2018.

§235. Materials

A. Standard and Material Selection. Standard and material selection shall comply with the following.

1. Any solder or flux which is used in the installation or repair of any public water system or any plumbing in a residential or nonresidential facility providing water for human consumption shall be lead free (*i.e.*, shall not contain more than 0.2 percent lead).

2. Any pipe, pipe fitting, plumbing fitting, fixture, and any other appurtenance which is used in the installation or repair of any public water system or any plumbing in a residential or nonresidential facility providing water for human consumption shall be lead free (*i.e.*, shall not contain

more than a weighted average of 0.25 percent lead when used with respect to the wetted surfaces of pipes, pipe fittings, plumbing fittings, fixtures, and any other appurtenances).

3. The lead free requirements referenced in §235.A.1 and 2 of this Subchapter shall not apply to:

a. leaded joints necessary for the repair of existing cast iron pipes;

b. pipes, pipe fittings, plumbing fittings, or fixtures, including backflow preventers, that are used exclusively for nonpotable services such as manufacturing, industrial processing, irrigation, outdoor watering, or any other uses where the water is not anticipated to be used for human consumption; or

c. toilets, bidets, urinals, fill valves, flushometer valves, tub fillers, shower valves, fire hydrants, service saddles, or water distribution main gate valves that are 2 inches in diameter or larger.

B. Water Piping Quality. Quality of the piping materials shall comply with the following:

1. All potable water pipes, pipe related products and materials that join or seal pipes and pipe related products shall be evaluated and listed as conforming with a national consensus product (or material) standard, ASTM, AWWA, NSF/ANSI Standard 61, and/or NSF/ANSI 372.

2. Any solder or flux which is used in the installation or repair of any public water system or any plumbing in a residential or nonresidential facility providing water for human consumption shall be lead free (*i.e.*, shall not contain more than 0.2 percent lead).

3. The lead free requirements referenced in §235.B.2 of this Subchapter shall not apply to:

a. leaded joints necessary for the repair of existing cast iron pipes;

b. pipes, pipe fittings, plumbing fittings, or fixtures, including backflow preventers, that are used exclusively for nonpotable services such as manufacturing, industrial processing, irrigation, outdoor watering, or any other uses where the water is not anticipated to be used for human consumption; or

c. toilets, bidets, urinals, fill valves, flushometer valves, tub fillers, shower valves, fire hydrants, service saddles, or water distribution main gate valves that are 2 inches in diameter or larger.

C. Permeation by Organic Compounds. Where distribution systems are installed in areas contaminated by organic compounds and such organic compounds are detected at levels that are known to pose a health risk:

1. pipe and joint materials which do not allow permeation of the organic compounds shall be used; and

2. non-permeable materials shall be used for all portions of the system including hydrant leads and service connections.

D. Used Materials. Water mains which have been used for the purpose of conveying potable water may be reused provided they meet the materials standard of §235 and have been restored substantially to their original condition.

E. Manufacturer approved transition joints shall be used between dissimilar piping materials.

AUTHORITY NOTE: Promulgated in accordance with the provisions of R.S. 40:4(A)(8), 40:4.13.D.(1)(2) and 40:5(A)(2)(3)(5)(6)(7)(17).

HISTORICAL NOTE: Promulgated by the Department of Health, Office of Public Health, LR 44:338 (February 2018), effective August 1, 2018.

§237. Distribution System Design

A. The system shall be designed to maintain a minimum pressure of 20 psig (140 kPa) at ground level at all points in the distribution system under all conditions of flow.

B. The minimum size of water main which provides for fire protection and serving fire hydrants shall be six-inch diameter. Larger size mains will be required if necessary to allow the withdrawal of the required fire flow while maintaining the minimum residual pressure specified in §237 of this Subchapter.

C. The minimum size of water main in the distribution system where fire protection is not to be provided shall be a minimum of 3 inch diameter. Any departure from minimum requirements shall be justified by hydraulic analysis and future water use, and may be considered only in special circumstances.

D. Dead end mains shall be equipped with a means to provide adequate flushing. No flushing device shall be directly connected to any sewer.

AUTHORITY NOTE: Promulgated in accordance with the provisions of R.S. 40:4(A)(8), 40:4.13.D.(1)(2) and 40:5(A)(2)(3)(5)(6)(7)(17).

HISTORICAL NOTE: Promulgated by the Department of Health, Office of Public Health, LR 44:339 (February 2018), effective August 1, 2018.

§239. Valves

A. Valve spacing shall not exceed one mile except for transmission mains 24 inches or larger.

B. Valve spacing shall not exceed five miles for transmission mains 24 inches or larger.

AUTHORITY NOTE: Promulgated in accordance with the provisions of R.S. 40:4(A)(8), 40:4.13.D.(1)(2) and 40:5(A)(2)(3)(5)(6)(7)(17).

HISTORICAL NOTE: Promulgated by the Department of Health, Office of Public Health, LR 44:339 (February 2018), effective August 1, 2018.

§241. Hydrants

A. Hydrant Leads. The hydrant lead shall be at least as large as the hydrant. For new construction and hydrant replacement, auxiliary valves shall be installed on all hydrant leads.

B. Hydrant Drainage. Where hydrant drains are not plugged, a gravel pocket or dry well shall be provided unless the natural soils will provide adequate drainage.

1. Hydrant drains shall not be connected to sanitary sewers or located within 6 feet of sanitary sewers, storm sewers, or storm drains and where allowed, shall be above the seasonal groundwater table.

AUTHORITY NOTE: Promulgated in accordance with the provisions of R.S. 40:4(A)(8), 40:4.13.D.(1)(2) and 40:5(A)(2)(3)(5)(6)(7)(17).

HISTORICAL NOTE: Promulgated by the Department of Health, Office of Public Health, LR 44:339 (February 2018), effective August 1, 2018.

§243. Air Relief Valves

A. At points in water mains where air can significantly accumulate provisions shall be made to remove the air by means of air relief valves.

B. When used, the open end of an air relief pipe from automatic valves shall be extended to at least one foot above grade and provided with a screened, downward-facing elbow.

C. Discharge piping from air relief valves shall not connect directly to any storm drain, storm sewer, or sanitary sewer.

AUTHORITY NOTE: Promulgated in accordance with the provisions of R.S. 40:4(A)(8), 40:4.13.D.(1)(2) and 40:5(A)(2)(3)(5)(6)(7)(17).

HISTORICAL NOTE: Promulgated by the Department of Health, Office of Public Health, LR 44:339 (February 2018), effective August 1, 2018.

§245. Installation of Water Mains

A. Specifications for installation of water mains shall incorporate the applicable provisions of the AWWA standards and/or manufacturer's recommended installation procedures including those specifications and requirements for bedding, cover and blocking.

B. Installed pipe shall be pressure tested and leakage tested in accordance with the appropriate AWWA Standards.

C. New, cleaned and repaired water mains shall be disinfected in accordance with AWWA Standard C651 (Disinfecting Water Mains) and are subject to the following additional provisions.

1. Water from new water mains shall not be furnished for consumer's use until tests performed by a laboratory certified by the state health officer have shown the new water mains to be free from contamination by coliform bacteria (following EPA approved procedures prescribed in *Standard Methods for the Examination of Water and Wastewater*, Nineteenth Edition).

2. After cutting into or repairing existing mains, the water shall be tested by a laboratory certified by the state health officer for coliform bacteria (following EPA approved procedures prescribed in *Standard Methods for the Examination of Water and Wastewater*, Nineteenth Edition) to determine the effectiveness of the disinfection procedure unless an alternate method is approved by the state health officer. If the direction of flow is unknown, then samples shall be taken on each side of the main break. If samples are E. coli/fecal coliform positive then the state health officer shall be notified. If samples are total coliform positive, then

corrective action must be taken, and daily sampling shall continue until two consecutive samples are negative.

3. Samples shall not be collected from the new facilities until such new facilities have been disinfected as prescribed herein, and the chlorinated water thoroughly flushed from the system until such chlorine measurements are no higher than those generally prevailing in the distribution system.

AUTHORITY NOTE: Promulgated in accordance with the provisions of R.S. 40:4(A)(8), 40:4.13.D.(1)(2) and 40:5(A)(2)(3)(5)(6)(7)(17).

HISTORICAL NOTE: Promulgated by the Department of Health, Office of Public Health, LR 44:340 (February 2018), effective August 1, 2018.

§247. Separation Distances from Contamination Sources

A. Parallel installation. Water mains shall be laid at least 6 feet horizontally from any existing or proposed gravity sanitary or storm sewer, septic tank, or subsoil treatment system. This distance shall be measured edge to edge.

1. In cases where it is not practical to maintain a 6 foot separation, the state health officer may allow deviation on a case-by-case basis, if supported by data from the design engineer.

B. Crossings. Where water mains cross sewers, either above which is the preferred method, or below the sewer:

1. the water main shall be laid to provide a minimum vertical distance of 18 inches between the outside of the water main and the outside of the sewer.

2. there shall be one full length of water pipe so that both joints will be as far from the sewer as possible. Special structural support for the water and sewer pipes may be required by the state health officer.

C. Exception. When it is impossible to obtain the minimum specified separation distances, the state health officer shall specifically approve any variance from the requirements of §247.A and §247.B of this Subchapter and the following methods of installation may be used:

1. Installation of the water main closer to a sewer, provided that the water main is laid in a separate trench or on an undisturbed earth shelf located on one side of the sewer at such an elevation that the bottom of the water main is at least 18 inches above the top of the gravity sewer.

2. The sewer materials shall be water works grade 150 psi (1.0 Mpa) pressure rated pipe meeting AWWA standards or pipe approved by the state health officer and shall be pressure tested to ensure water tightness.

D. Force Mains. There shall be at least a 6 foot horizontal separation between water mains and sanitary sewer force mains. This measurement shall be from edge to edge. There shall be an 18 inch vertical separation at crossings as required in §247 of this Subchapter.

E. Sewer manholes. No water pipe shall pass through or come in contact with any part of a sanitary sewer manhole and shall be located at least 6 feet from sanitary sewer manholes.

AUTHORITY NOTE: Promulgated in accordance with the provisions of R.S. 40:4(A)(8), 40:4.13.D.(1)(2) and 40:5(A)(2)(3)(5)(6)(7)(17).

HISTORICAL NOTE: Promulgated by the Department of Health, Office of Public Health, LR 44:340 (February 2018), effective August 1, 2018.

§249. Surface Water Crossings

A. Above-water crossings or above-grade piping, if present shall be:

1. adequately supported and anchored;
2. protected from vandalism;
3. protected from foreseeable sources of damage;
4. protected from freezing by water velocity, heating trace systems and thermal insulation or other effective method; and
5. shall be placed so as to be accessible for repair or replacement.

B. Underwater crossings if present:

1. shall have over it a minimum cover of five feet unless otherwise approved by the state health officer; and

2. when crossing water courses which are greater than 15 feet in width measured at low flow, the following shall be provided:

a. the pipe shall be of special construction, having flexible, restrained or welded watertight joints;

b. valves shall be provided at both ends of water crossings within one half mile for less than 24 inch mains or within 2.5 miles for 24 inch for larger mains so that the section can be isolated for testing or repair; the valves shall be easily accessible, and not subject to flooding under normal conditions. All other mains, services, taps, hydrants, or other devices located inside of the limits of these isolation valves shall also have easily accessible isolation valve;

c. permanent taps or other acceptable means to allow the use of a small meter to determine leakage and obtain water samples on each side of the valve closest to the supply source. Combination taps for both an air relief valve and a pressure tap are permissible provided the assembly meets the above criteria and the air relief valve can be isolated during the testing of the crossing.

AUTHORITY NOTE: Promulgated in accordance with the provisions of R.S. 40:4(A)(8), 40:4.13.D.(1)(2) and 40:5(A)(2)(3)(5)(6)(7)(17).

HISTORICAL NOTE: Promulgated by the Department of Health, Office of Public Health, LR 44:340 (February 2018), effective August 1, 2018.

§251. Interconnections

A. The approval of the state health officer shall be obtained for interconnections between potable water supplies.

AUTHORITY NOTE: Promulgated in accordance with the provisions of R.S. 40:4(A)(8), 40:4.13.D.(1)(2) and 40:5(A)(2)(3)(5)(6)(7)(17).

HISTORICAL NOTE: Promulgated by the Department of Health, Office of Public Health, LR 44:341 (February 2018), effective August 1, 2018.

§253. Water Services and Plumbing

A. Water services and plumbing shall conform to the applicable provisions of the state *Uniform Construction Code*, LAC 17:I.

B. Where permitted by the water supplier, booster pumps that are used to draw water from a water supply distribution system or are placed in a system to increase the line pressure, shall not reduce the pressure at the customer connection to less than 20 psi (pounds per square inch) gauge.

AUTHORITY NOTE: Promulgated in accordance with the provisions of R.S. 40:4(A)(8), 40:4.13.D.(1)(2) and 40:5(A)(2)(3)(5)(6)(7)(17).

HISTORICAL NOTE: Promulgated by the Department of Health, Office of Public Health, LR 44:341 (February 2018), effective August 1, 2018.

§255. Water Loading Stations

A. Water loading stations present special problems since the fill line may be used for filling both potable water vessels and other tanks or contaminated vessels.

B. For the purposes of preventing contamination of both the public water supply and any potable water vessels being filled, the following shall apply to the use and operation of water loading stations:

1. there shall be no backflow to the public water supply;
2. the piping arrangement shall be such as to prevent contamination from a hauling vessel being transferred to subsequent station users (see Figure 255); and
3. any and all portable hoses used for filling of water containers or other acceptable water vessels:
 - a. shall be fitted with a metal disk at the nozzle of the hose to prevent contact of nozzle with ground or floors.
 - b. shall be protected from dirt and contamination by storage in a tightly enclosed cabinet or acceptable storage container when not in use, and
 - c. shall be disinfected prior to use.

Figure 255. Acceptable Filling Device for Water Loading Station

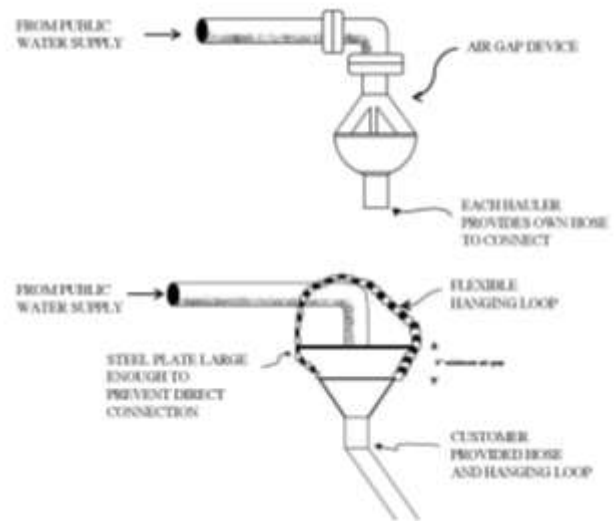

AUTHORITY NOTE: Promulgated in accordance with the provisions of R.S. 40:4(A)(8), 40:4.13.D.(1)(2) and 40:5(A)(2)(3)(5)(6)(7)(17).

HISTORICAL NOTE: Promulgated by the Department of Health, Office of Public Health, LR 44:341 (February 2018), effective August 1, 2018.

Subchapter F. Waste Residuals**§257. General**

A. All waste discharges shall be in accordance with all federal, state and/or local laws and ordinances. The requirements provided here shall, therefore, be considered minimum requirements as federal, state, and/or local water pollution control authorities may have more stringent requirements.

B. Provisions shall be made for proper disposal of water treatment plant wastes such as:

1. sanitary and laboratory wastes;
2. clarification sludge;
3. softening sludge;
4. iron sludge;
5. filter backwash water;
6. backwash sludge; and
7. brines, including softener and ion exchange regeneration wastes and membrane wastes.

C. Some regulatory agencies consider discharge from overflow pipes/outlets as discharge wastes. In locating sewer lines and waste disposal facilities, consideration shall be given to preventing potential contamination of the water supply.

D. Alternative methods of water treatment and chemical use should be considered as a means of reducing waste volumes and the associated handling and disposal problems.

E. Appropriate backflow prevention measures shall be provided on waste discharge piping as needed to protect the public water supply.

AUTHORITY NOTE: Promulgated in accordance with the provisions of R.S. 40:4(A)(8), 40:4.13.D.(1)(2) and 40:5(A)(2)(3)(5)(6)(7)(17).

HISTORICAL NOTE: Promulgated by the Department of Health, Office of Public Health, LR 44:341 (February 2018), effective August 1, 2018.

§259. Sanitary Waste

A. The sanitary waste from water treatment plants, pumping stations, and other waterworks installations shall receive treatment.

B. Waste from these facilities shall be discharged directly to a sanitary sewer system, when available and feasible, or to an adequate on-site waste treatment facility approved by the state health officer.

C. The appropriate federal, state, and local officials should be notified when designing treatment facilities to ensure that the local sanitary sewer system can accept the anticipated wastes.

AUTHORITY NOTE: Promulgated in accordance with the provisions of R.S. 40:4(A)(8), 40:4.13.D.(1)(2) and 40:5(A)(2)(3)(5)(6)(7)(17).

HISTORICAL NOTE: Promulgated by the Department of Health, Office of Public Health, LR 44:342 (February 2018), effective August 1, 2018.

§261. Brine Wastes

A. Waste from ion exchange, demineralization, and membrane plants, or other plants which produce a brine, may be disposed of by controlled discharge to a stream if adequate dilution is available. The Louisiana Department of Environmental Quality (hereinafter, LDEQ) may establish surface water quality requirements including rate of discharge and discharge parameters.

B. Except when discharging to large waterways, a surge tank of sufficient size should be provided to allow the brine to be discharged over a 24-hour period.

C. Where discharging to a sanitary sewer, a holding tank may be required to prevent the overloading of the sewer and/or interference with the waste treatment processes. The effect of brine discharge to sewage lagoons may depend on the rate of evaporation from the lagoons.

AUTHORITY NOTE: Promulgated in accordance with the provisions of R.S. 40:4(A)(8), 40:4.13.D.(1)(2) and 40:5(A)(2)(3)(5)(6)(7)(17).

HISTORICAL NOTE: Promulgated by the Department of Health, Office of Public Health, LR 44:342 (February 2018), effective August 1, 2018.

§263. Precipitative Softening Sludge

A. Sludge from plants using precipitative softening varies in quantity and in chemical characteristics depending on the softening process and the chemical characteristics of the water being softened. Recent studies show that the quantity of sludge produced is much larger than indicated by stoichiometric calculations. Sludge from plants using precipitative softening shall be treated and disposed of as follows.

1. Lagoons. The use of lagoons shall comply with the following.

a. Short term storage lagoons should be designed on the basis of 0.7 acres per million gallons per day per 100 mg/L of hardness removed based on a usable lagoon depth of 5 feet. This should provide about 2 1/2 years storage. At least 2 but preferably more lagoons shall be provided in order to give flexibility in operation. An acceptable means of final sludge disposal shall be provided. Provisions shall be made for convenient cleaning.

b. Long term lagoons should have a volume of at least four times that for short term storage lagoons.

c. The design of both short term and long term lagoons should provide for:

- i. location free from flooding;
- ii. when necessary, dikes, deflecting gutters or other means of diverting surface water so that it does not flow into the lagoons;
- iii. a minimum usable depth of 5 feet;
- iv. adequate freeboard of at least 2 feet;
- v. adjustable decanting device;
- vi. effluent sampling point;
- vii. adequate safety provisions;
- viii. parallel operation; and
- ix. subsurface infiltration may be acceptable if approved by the appropriate reviewing authority/authorities.

2. The application of liquid lime or dewatered sludge to farm land should be considered as a method of ultimate disposal. Approval from the LDEQ shall be obtained if required.

3. Mixing of lime sludge with activated sludge waste as a means of co-disposal.

4. Disposal at a landfill either as a solid or liquid if the landfill can accept such waste, depending on LDEQ requirements.

5. Mechanical dewatering of sludge may be considered. Pilot studies on a particular plant waste are recommended. Mechanical dewatering should be preceded by sludge concentration and chemical pre-treatment.

6. Calcination of sludge may be considered. Pilot studies on a particular plant waste are recommended.

7. Discharge of lime sludge to sanitary sewers should be avoided since it may cause both liquid volume and sludge volume problems at the sewage treatment plant. This method shall be used only when the sewerage system has the capability to adequately handle the lime sludge.

B. Lime sludge drying beds shall not be used as a method of treating and/or disposing of sludge.

AUTHORITY NOTE: Promulgated in accordance with the provisions of R.S. 40:4(A)(8), 40:4.13.D.(1)(2) and 40:5(A)(2)(3)(5)(6)(7)(17).

HISTORICAL NOTE: Promulgated by the Department of Health, Office of Public Health, LR 44:342 (February 2018), effective August 1, 2018.

§265. Alum Sludge

A. Alum sludge can be discharged to a sanitary sewer. However, initiation of this practice shall depend on obtaining approval from the owner of the sanitary sewerage system as well as from the state health officer before final designs are made.

B. Mechanical concentration may be considered. A pilot study is recommended before the design of a mechanical dewatering installation.

C. Freezing changes the nature of alum sludge so that it can be used for fill. Acid treatment of sludge for alum recovery may be a possible alternative.

D. Lagoons. Lagooning may be used as a method of handling alum sludge. Lagoon size can be calculated using total chemicals used plus a factor for turbidity. Lagoons shall be designed to produce an effluent satisfactory to the LDEQ.

1. Lagoons, in addition, should provide for:

- a. a location free from flooding;
- b. where necessary, dikes, deflecting gutters or other means of diverting surface water so that it does not flow into the lagoon;
- c. a minimum usable depth of 5 feet;
- d. adequate freeboard of at least 2 feet;
- e. adjustable decanting device;
- f. effluent sampling point;
- g. adequate safety provisions; and
- h. a minimum of two cells, each with appropriate inlet/outlet structures to facilitate independent filling/dewatering operations.

E. Mechanical dewatering may be used as a method of handling alum sludge.

1. The successful use of mechanical dewatering depends on the characteristics of the alum sludge produced, as determined by site specific studies.

2. Mechanical dewatering shall be preceded by sludge concentration and chemical pre-treatment.

F. Alum sludge may be disposed of by land application either alone, or in combination with other wastes where an agronomic value has been determined, and disposal has been approved by the LDEQ if required.

AUTHORITY NOTE: Promulgated in accordance with the provisions of R.S. 40:4(A)(8), 40:4.13.D.(1)(2) and 40:5(A)(2)(3)(5)(6)(7)(17).

HISTORICAL NOTE: Promulgated by the Department of Health, Office of Public Health, LR 44:342 (February 2018), effective August 1, 2018.

§267. "Red Water" Waste

A. Waste filter wash water from iron and manganese removal plants shall be properly disposed of in accordance with one of the following methods:

1. Sand Filters. The sand filters should have the following features.

a. Total filter area shall be sufficient to adequately dewater applied solids. Unless the filter is small enough to be cleaned and returned to service in 1 day, two or more cells are required.

b. The "red water" filter shall have sufficient capacity to contain, above the level of the sand, the entire volume of wash water produced by washing all of the production filters in the plant, unless the production filters are washed on a rotating schedule and the flow through the production filters is regulated by true rate of flow controllers. Then sufficient volume shall be provided to properly dispose of the wash water involved.

c. Sufficient filter surface area should be provided so that, during any one filtration cycle, no more than 2 feet of backwash water will accumulate over the sand surface.

d. The filter shall not be subject to flooding by surface runoff or flood waters. Finished grade elevation shall be established to facilitate maintenance, cleaning and removal of surface sand as required. Flash boards or other non-watertight devices shall not be used in the construction of filter side walls.

e. The filter media should consist of a minimum of 12 inches of sand, 3 to 4 inches of supporting small gravel or torpedo sand, and 9 inches of gravel in graded layers. All sand and gravel should be washed to remove fines.

f. Filter sand should have an effective size of 0.3 to 0.5 mm and a uniformity coefficient not to exceed 3.5. The use of larger sized sands shall be justified by the designing engineer to the satisfaction of the state health officer.

g. The filter should be provided with an adequate under-drainage collection system to permit satisfactory discharge of filtrate.

h. Provision shall be made for the sampling of the filter effluent.

i. Overflow devices from "red water" filters shall not be permitted.

j. Where freezing is a problem, provisions should be made for freeze protection for the filters during the winter months.

k. "Red water" filters shall comply with the common wall provisions contained in §177 of this Part, which pertain to the possibility of contaminating treated water with unsafe water.

1. The state health officer shall be contacted for approval of any arrangement wherein a separate structure is not provided.

2. Lagoons. The lagoons shall have the following features:

a. be designed with a volume 10 times the total quantity of wash water discharged during any 24-hour period;

b. have a minimum usable depth of 3 feet;

c. have a length 4 times width, and the width at least 3 times the depth, as measured at the operating water level;

d. be designed such that the outlet is located at the end opposite the inlet;

e. have a weir overflow device at the outlet end with weir length equal to or greater than depth;

f. have provisions for the velocity to be dissipated at the inlet end; and

g. subsurface infiltration lagoons shall be acceptable only if approved by the appropriate reviewing authority/authorities.

3. Red water can be discharged to a community sewer. Approval of this method will depend on obtaining approval from the owner of the sewerage system as well as from the state health officer before final designs are made.

a. A surge tank is recommended to prevent overloading of the sewers.

b. Design shall prevent cross connections.

c. There shall be no common walls between potable and non-potable water compartments.

4. Red water may be discharged into surface water. However, the plant must have an NPDES (national pollutant discharge elimination system) permit or other applicable discharge permit from the appropriate regulatory authority/authorities to dispose of backwash water into surface water.

5. Recycling of supernatant or filtrate from "red water" waste treatment facilities to the head end of an iron removal plant shall not be allowed except as approved by the state health officer.

AUTHORITY NOTE: Promulgated in accordance with the provisions of R.S. 40:4(A)(8), 40:4.13.D.(1)(2) and 40:5(A)(2)(3)(5)(6)(7)(17).

HISTORICAL NOTE: Promulgated by the Department of Health, Office of Public Health, LR 44:343 (February 2018), effective August 1, 2018.

§269. Waste Filter Wash Water

A. Backwash water from surface water treatment and lime softening plants should have suspended solids reduced to a level acceptable to the state health officer before being discharged to a backwash reclaim tank and recycled to the head of the plant.

1. The backwash reclaim holding tank shall:

a. contain the anticipated volume of waste water produced by the plant when operating at design capacity;

b. for plants having two filters, have a holding tank that will contain the total waste wash water from both filters calculated by using a 15 minute wash at 20 gallons per minute per square foot;

c. for plants having more than two filters, size the holding tank appropriately depending on the anticipated hours of operation.

B. Spent filter backwash water, thickener supernatant and liquids processes may be allowed by the state health officer to be recycled into the head of the plant, provided that:

1. compliance is achieved under the requirements of Subchapter G (Filter Backwash Recycling) of Chapter 11 (Surface Water Treatment Rule) of Part XII of this code;

2. the recycled water should be returned at a rate of less 10 percent of the instantaneous raw water flow rate entering the plant;

3. the recycled water should not be recycled when the raw water contains excessive algae, when finished water taste and odor problems are encountered, or when disinfection byproduct levels in the distribution system may exceed allowable levels. Particular attention shall be given to the presence of protozoans such as *Giardia* and *Cryptosporidium* concentrating in the waste water stream; and

4. water utilities may need to treat filter waste water prior to recycling to reduce pathogen population and improve coagulation or avoid reclaiming filter wash water given the increased risk to treated water quality.

AUTHORITY NOTE: Promulgated in accordance with the provisions of R.S. 40:4(A)(8), 40:4.13.D.(1)(2) and 40:5(A)(2)(3)(5)(6)(7)(17).

HISTORICAL NOTE: Promulgated by the Department of Health, Office of Public Health, LR 44:344 (February 2018), effective August 1, 2018.

§271. Radioactive Materials

A. Radioactive materials include, but are not limited to:

1. granulated activated carbon (GAC) used for radon removal;

2. radium adsorptive filter media;

3. ion-exchange regeneration waste from radium removal;

4. manganese greensand backwash solids from manganese removal systems;

5. precipitative softening sludges; and

6. reverse osmosis concentrates where radiological constituents are present.

B. The buildup of radioactive decay products of radon shall be considered and adequate shielding, ventilation, and other safeguards shall be provided for operators and visitors.

C. These materials may require disposal as radioactive waste in accordance with Nuclear Regulatory Commission regulations. Necessary approval shall be obtained from the LDEQ prior to disposal of all radioactive wastes if required.

AUTHORITY NOTE: Promulgated in accordance with the provisions of R.S. 40:4(A)(8), 40:4.13.D.(1)(2) and 40:5(A)(2)(3)(5)(6)(7)(17).

HISTORICAL NOTE: Promulgated by the Department of Health, Office of Public Health, LR 44:344 (February 2018), effective August 1, 2018.

§273. Arsenic Waste Residuals

A. Arsenic-bearing wastes, including but not limited to, filter backwash water and sludge, and adsorptive filter media from arsenic treatment facilities may be considered hazardous.

B. Necessary approval from LDEQ must be obtained prior to disposal of arsenic residual wastes if required.

AUTHORITY NOTE: Promulgated in accordance with the provisions of R.S. 40:4(A)(8), 40:4.13.D.(1)(2) and 40:5(A)(2)(3)(5)(6)(7)(17).

HISTORICAL NOTE: Promulgated by the Department of Health, Office of Public Health, LR 44:344 (February 2018), effective August 1, 2018.

§275. Other Approved Methods of Handling Waste

A. LDH, in coordination with other regulatory agencies may review and approve other methods of handling waste that are not specifically discussed in this Subchapter.

AUTHORITY NOTE: Promulgated in accordance with the provisions of R.S. 40:4(A)(8), 40:4.13.D.(1)(2) and 40:5(A)(2)(3)(5)(6)(7)(17).

HISTORICAL NOTE: Promulgated by the Department of Health, Office of Public Health, LR 44:344 (February 2018), effective August 1, 2018.

§277. Standards Reference Table

A. This Section contains the particular volume of standards or the specific standard with the designation, name and the edition of the standards cited within Chapters 1 and 2 of this Part. The particular designation/edition of the standards listed below shall be applied in relation to the citation within Chapter 1 and 2 of this Part.

Standard Designation	Section/Table
Chemicals - Health Effects	201.E.1, 205.B, 209.G, 223.H
NSF/ANSI 61, Drinking Water System Components - Health Effects	169.H.1.c, 169.H.3.c.i, 179.I.1.a, 185.A, 225.O.1, 225.S.1, 235.B.1
NSF/ANSI 372, Drinking Water System Components - Lead Content	235.B.1
Standard Methods for the Examination of Water and Wastewater, 19th edition	179.A, 245.C.1, 245.C.2

AUTHORITY NOTE: Promulgated in accordance with the provisions of R.S. 40:4(A)(8), 40:4.13.D.(1)(2) and 40:5(A)(2)(3)(5)(6)(7)(17).

HISTORICAL NOTE: Promulgated by the Department of Health, Office of Public Health, LR 44:344 (February 2018), effective August 1, 2018.

§279. Organization Reference Table

A. The following is a list by name and address of those agencies, associations, institutes and other entities that are referenced within Chapters 1 and 2 of this Part by name, initials or symbols. Further, other organizations may be listed, for convenience, whose technical and other services are made available as they may relate to the provisions contained within Chapters 1 and 2 of this Part.

ANSI	American National Standards Institute, Inc. 25 West 43rd Street, 4th Floor New York, New York 10036 Tel. (212) 642-4900; Fax (212) 398-0023 www.ansi.org
ASME	American Society of Mechanical Engineers Information Central - Orders/Inquiries P.O. Box 2300 Fairfield, New Jersey 07007-2300 Tel. (800) 843-2763 www.asme.org
ASTM International	American Society for Testing and Materials International 100 Barr Harbor Drive West Conshohocken, Pennsylvania 19428-2959 Tel. (610) 832-9500; Fax (610) 832-9555 www.astm.org
AWWA	American Water Works Association 6666 West Quincy Avenue Denver, Colorado 80235-3098 Tel. (303) 794-7711 or (800) 926-7337; Fax (303) 347-0804
NFPA	National Fire Protection Association 1 Batterymarch Park Quincy, Massachusetts 02169-9101 Tel. (617) 770-3000 or (800) 344-3555; Fax (800) 593-6372 www.nfpa.org
NSF	NSF International 789 N. Dixboro Road P.O. Box 130140 Ann Arbor, Michigan 48113-0140 Tel. (734) 769-8010 or (800) 673-6275; Fax (734) 769-0109 www.nsf.org

AUTHORITY NOTE: Promulgated in accordance with the provisions of R.S. 40:4(A)(8), 40:4.13.D.(1)(2) and 40:5(A)(2)(3)(5)(6)(7)(17).

HISTORICAL NOTE: Promulgated by the Department of Health, Office of Public Health, LR 44:345 (February 2018), effective August 1, 2018.

Standard Designation	Section/Table
ACI 350-06, Code Requirements for Environmental Engineering Concrete Structures	179.H.4.a.iv
ASME Boiler & Pressure Vessel Code - Section VIII - Pressure Vessels - 2017	229.A
ASTM Volume 01.01 Steel—Piping, Tubing, Fittings - June 2017	235.B.1
ASTM Volume 01.02 Ferrous Castings, Ferroalloys - June 2017	235.B.1
ASTM Volume 04.05 Chemical-Resistant Nonmetallic Materials; Vitriified Clay Pipe; Concrete Pipe; Fiber-Reinforced Cement Products; Mortars and Grouts; Masonry; Precast Concrete - June 2017	235.B.1
ASTM Volume 08.04 Plastic Piping Systems - June 2017	235.B.1
AWWA Full Set Standards - June 2017	
Chemicals	205.B, 209.G
Disinfection of Wells	151.A, 169.E.9.c
Disinfection of Water-Storage Facilities	151.A, 225.T, 225.T.2, 225.T3
Disinfecting Water Mains	151.A, 245.C
Granular Activated Carbon	177.A.6.c.iv, 177.A.6.c.iv.d
Granular Filter Material	177.A.6
Pipe and Accessories	235.B.1, 245, 247.C.2
Water Storage Tanks	225.B
Water Wells	169.F.2
EPA Alternative Disinfectants and Oxidants Guidance Manual - 1999	179.I.1
EPA Ultraviolet Disinfection Guidance Manual - 2006	179.H
NIOSH	207.B.1, 207.D.1
NSF/ANSI 60, Drinking Water Treatment	169.H.3.c.i, 201.A,

Chapter 3. Water Quality Standards

§301. Mandatory Water Quality Standards for Public Water Systems

A. Each public water supply shall comply with the maximum contaminant levels, maximum residual disinfectant levels, and treatment technique requirements as prescribed and as applicable in the National Primary Drinking Water Regulations, the Louisiana Total Coliform Rule (Chapter 9 of this Part), the Louisiana Surface Water Treatment Rule (Chapter 11 of this Part), the Louisiana Disinfectants and Disinfection Byproducts Rule (Chapter 13 of this Part), and the Louisiana Lead and Copper Rule (Chapter 17 of this Part). The state health officer, upon determining that a risk to human health may exist, reserves the right to limit exposure to any other contaminant. Further, each public water supply should comply with the National Secondary Drinking Water Regulations. Treatment to remove questionable characteristics shall be approved by the state health officer.

B. Each public water supply shall comply with the monitoring and analytical requirements specified in the National Primary Drinking Water Regulations, the Louisiana Total Coliform Rule (Chapter 9 of this Part), the Louisiana Surface Water Treatment Rule (Chapter 11 of this Part), the Louisiana Disinfectants and Disinfection Byproducts Rule (Chapter 13 of this Part), and the Louisiana Lead and Copper Rule (Chapter 17 of this Part), as applicable.

C. A laboratory certification program has been established to certify commercially and publicly owned laboratories to perform chemistry compliance monitoring analyses for public water systems and other potable water supply systems. Laboratories seeking certification in any chemistry category for which certification is offered must adhere to the rules and regulations governing laboratory certifications as contained in the Department of Health and Hospitals, Office of Public Health's *laboratory certification regulations* (see LAC 48:V.Chapter 80). An annual certification fee will be assessed laboratories seeking certification from the Department of Health and Hospitals, Office of Public Health.

AUTHORITY NOTE: Promulgated in accordance with R.S. 36:254(B)(7), R.S. 40:4(A)(8) and R.S. 40:5(2)(3)(5)(6)(17)(20).

HISTORICAL NOTE: Promulgated by the Department of Health and Hospitals, Office of Public Health, LR 28:1321 (June 2002), amended LR 30:2327 (October 2004), LR 38:2376 (September 2012), LR 38:3232 (December 2012).

§302. Relationship with this Part

A. Effective August 1, 2018, LAC 51:XII.111-191 and §§201-277 of this Part supersede, for any new public water system or any proposed new construction or modification to an existing public water system, any other design provisions in this Chapter.

B. Nothing in this Section shall be construed to allow any exception to compliance with the significant deficiency requirements of §319 of this Part, which is applicable to all public water systems, irrespective of construction date.

AUTHORITY NOTE: Promulgated in accordance with the provisions of R.S. 40:4(A)(8), 40:4.13(D)(1)(2) and 40:5(A)(2)(3)(5)(6)(7)(17).

HISTORICAL NOTE: Promulgated by the Department of Health, Office of Public Health, LR 44:1251 (July 2018).

§303. Variances and/or Exemptions [formerly paragraph 12:002-6]

A. Upon determination that a public water supply is not in compliance with the maximum contaminant levels or treatment technique requirements of the National Primary Drinking Water Regulations, variances and/or exemptions may be issued by the state health officer in accord with Sections 1415 and 1416 of the Safe Drinking Water Act and Subpart K (Variances for Small System) of 40 CFR Part 142.

B. The owner of the public water supply which receives a variance and/or exemption shall fully and timely comply with all the terms and conditions of any compliance and/or implementation schedule specified by the state health officer in conjunction with the issuance of same.

AUTHORITY NOTE: Promulgated in accordance with R.S. 40:4 (A)(8) and R.S. 40:5 (5)(6).

HISTORICAL NOTE: Promulgated by the Department of Health and Hospitals, Office of Public Health, LR 28:1321 (June 2002).

§305. Reserved.

§307. Responsibility of Owner [formerly paragraph 12:003-1]

A. It shall be the duty of the mayor, or the person having responsible charge of a municipally owned water supply, or the legal or natural person owning a public water supply, to take all measures and precautions which are necessary to secure and ensure compliance with this Part of the Code, and such persons shall be held primarily responsible for the execution and compliance with regulations of this Code. A printed copy of this Part of the code shall be kept permanently posted in the office used by the authority owning or having charge of a public water supply.

AUTHORITY NOTE: Promulgated in accordance with R.S. 40:4 (A)(8) and R.S. 40:5 (5)(6).

HISTORICAL NOTE: Promulgated by the Department of Health and Hospitals, Office of Public Health, LR 28:1321 (June 2002).

§309. Plant Supervision and Control [formerly paragraph 12:003-2]

A. All public water supplies shall be under the supervision and control of a duly certified operator as per requirements of the State Operator Certification Act, Act 538 of 1972, as amended (R.S. 40:1141-1151).

AUTHORITY NOTE: Promulgated in accordance with R.S. 40:4 (A)(8), R.S. 40:5 (5)(6), and R.S. 40:1148.

HISTORICAL NOTE: Promulgated by the Department of Health and Hospitals, Office of Public Health, LR 28:1321 (June 2002).

§311. Records [formerly paragraph 12:003-2]

A. Complete daily records of the operation of a public water system, including reports of laboratory control tests and any chemical test results required for compliance

determination, shall be kept and retained as prescribed in the national primary drinking water regulations on forms approved by the state health officer. When specifically requested by the state health officer or required by other requirements of this Part, copies of these records shall be provided to the office designated by the state health officer within 10 days following the end of each calendar month. Additionally, all such records shall be signed by a certified operator in charge of the public water system and made available for review during inspections/sanitary surveys performed by the state health officer.

AUTHORITY NOTE: Promulgated in accordance with R.S. 40:4(A)(8) and 40:5(A)(2)(3)(5)(6)(17)(20).

HISTORICAL NOTE: Promulgated by the Department of Health and Hospitals, Office of Public Health, LR 28:1321 (June 2002), amended LR 30:1195 (June 2004), LR 42:408 (March 2016), amended by the Department of Health, Office of Public Health, LR 43:85 (January 2017).

§313. Reserved.

§315. Security

[formerly paragraph 12:003-5]

A. All public water supply wells, treatment units, tanks, etc., shall be located inside a fenced area that is capable of being locked; said areas shall be locked when unattended. The fence shall be resistant to climbing and at least 6 feet high.

AUTHORITY NOTE: Promulgated in accordance with R.S. 40:4(A)(8) and R.S. 40:5(5)(6).

HISTORICAL NOTE: Promulgated by the Department of Health and Hospitals, Office of Public Health, LR 28:1322 (June 2002).

§317. Water Systems Which Fluoridate/Plan to Fluoridate

A. Public water systems which fluoridate their water supply (or which plan to fluoridate their water supply) shall comply with the applicable requirements of LAC 48:V. Subpart 5 (Fluoridation).

AUTHORITY NOTE: Promulgated in accordance with R.S. 40:4(A)(8), R.S. 40:5(2)(3)(5)(6)(7)(17), and R.S. 40:5.11(G).

HISTORICAL NOTE: Promulgated by the Department of Health and Hospitals, Office of Public Health, LR 36:72 (January 2010).

§319. Significant Deficiencies Identified in Sanitary Surveys

A. The state health officer shall conduct a sanitary survey for all public water systems no less frequently than once every three years for community systems and no less frequently than once every five years for non-community systems.

1. The sanitary survey shall address the following eight specific elements:

- a. source;
- b. treatment;
- c. distribution system;
- d. finished water storage;

- e. pumps, pump facilities, and controls;
- f. monitoring, reporting, and data verification;
- g. system management and operation; and
- h. operator compliance with state requirements.

B. Public water systems shall respond in writing to confirm the correction of significant deficiencies identified in a sanitary survey report no later than 90 days after receipt of the report by the public water system. The public water system's written response shall specify the completed corrective action taken for each significant deficiency or specify a corrective action plan and schedule to address each significant deficiency noted in the sanitary survey report.

C. Upon receipt of the public water system's written response to significant deficiencies identified in a sanitary survey report, the state health officer shall review and approve the public water system's written schedule or shall notify the public water system in writing if the corrective action schedule is unacceptable and will make recommendations to amend the schedule so that the plan can be approved.

D. For all public water systems, except as otherwise specified in this Part, failure to comply with any of the following requirements has been determined by the state health officer to be a significant deficiency and shall be corrected in accordance with §319.B of this Part:

1. §§105.A, 105.B or 105.D of this Part;
2. §135.A of this Part [standby power] for any community water supply and non-community water supply serving a hospital. A standby power supply shall be provided through a dedicated portable or in-place auxiliary power of adequate supply and connectivity;
3. §161.A of this Part [flood protection] for any community water supply. Use of a levee system or flood walls are acceptable for meeting §161.A of this Part;
4. §169.B.2 of this Part [secondary source] for any community water supply and non-community water supply serving a hospital. Connection to another public water supply of sufficient capacity or providing an LDH-approved annual public notice to customers may be considered in lieu of meeting §169.B.2 of this Part;
5. §237.A of this Part [minimum system pressure of 20 psig];
6. §309.A of this Part;
7. there shall be no pathway for contamination into the well casing or discharge piping. The well site grading, the well slab and all well appurtenances including casing, sanitary seal, vent, and drawdown tube shall be maintained to prevent the introduction of contamination into the well casing and discharge piping;
8. every potable water well, and the immediate appurtenances thereto that comprise the well, shall be located at a safe distance from all possible sources of contamination. The state health officer has deemed that due to the horizontal distance to a possible source of pollution

that is currently causing, or may reasonably be expected to cause contamination to be introduced into the water being delivered to consumers, action is necessary to eliminate or mitigate this potential source of contamination;

9. §315.A of this Part;
10. §325.A of this Part;
11. §327.A.15 of this Part;
12. §329.A.6 of this Part;
13. §331.A of this Part;
14. §337.C of this Part;
15. §343.A of this Part;
16. §344 of this Part;

17. general equipment design shall be such that feeders will be able to supply, at all times, the necessary amounts of chemicals at an accurate rate throughout the range of feed;

18. for fluoride only, day tanks shall be provided where bulk storage of liquid chemical is provided, meet all the requirements of §203.J, hold no more than a 30-hour supply, and be scale mounted or have a calibrated gauge painted or mounted on the side if liquid levels can be observed in a gauge tube or through translucent sidewalls of the tank. In opaque tanks, a gauge rod extending above a reference point at the top of the tank, attached to a float can be used. The ratio of the area of the tank to its height shall be such that unit readings are meaningful in relation to the total amount of chemical fed during a day;

19. no drain on a water storage structure shall have a direct connection to a sewer or storm drain. The design shall allow draining the storage facility for cleaning or maintenance without causing loss of pressure in the distribution system;

20. system shall have a monitoring plan that includes a list of all routine compliance samples required on a daily, weekly, monthly, quarterly, and annual basis and identify the sampling location where samples are to be collected. The public water system shall revise and re-submit its monitoring plan if changes to a plant or distribution system require changes to the sampling locations or if any significant changes to the disinfection methods are made. In addition, the public water system shall update and re-submit its monitoring plan when the system's sampling requirements or protocols change;

21. §1503.A.1 of this Part;
22. §1503.C of this Part;

23. storage tanks and pipelines for liquid chemicals shall be specified for use with individual chemicals and shall not be used for different chemicals. Offloading areas shall be clearly labeled to prevent accidental cross-contamination;

24. system shall ensure that no critical water system component is in poor condition or defective;

25. all potable water systems shall be designed, constructed, and maintained so as to prevent leakage of water due to defective materials, improper jointing,

corrosion, settling, impacts, freezing, or other causes. Valves and blow-offs shall be provided so that necessary repairs can be made with a minimum interruption of service; and

26. other condition which is deemed by the state health officer to be a significant deficiency.

AUTHORITY NOTE: Promulgated in accordance with R.S. 40:4(A)(8), 40:13(D)(1)(2) and R.S. 40:5(A)(2)(3)(5)(6)(17)(20).

HISTORICAL NOTE: Promulgated by the Department of Health, Office of Public Health, LR 43:85 (January 2017), amended LR 44:345 (February 2018), effective August 1, 2018, LR 44:1251 (July 2018), effective August 1, 2018, amended LR 48:1102 (April 2022).

§321. Reporting Changes or NPDWR Violations in Public Water Supplies [formerly paragraph 12:005]

A. No person owning, or having by law the management control of any public water supply, shall take or cause to be taken for use for potable purposes, water from any auxiliary source other than a source or sources of water approved by the state health officer, or shall make any change whatsoever which may affect the sanitary quality of such water supply, without first having notified the state health officer.

B. Also, any violation of the National Primary Drinking Water Regulations shall be reported to the state health officer within 48 hours after learning of any violation.

AUTHORITY NOTE: Promulgated in accordance with R.S. 40:4 (A)(8) and R.S. 40:5 (5)(6).

HISTORICAL NOTE: Promulgated by the Department of Health and Hospitals, Office of Public Health, LR 28:1322 (June 2002).

§323. Filtration [formerly paragraph 12:006]

A. All potable water derived from surface waters shall be filtered before distribution. Pressure filters shall not be used as the primary turbidity removal mechanism in the filtration of surface waters. On a case-by-case basis, the Department of Health and Hospitals (DHH) may allow pressure filters to be used as the primary turbidity removal mechanism in systems identified as being a groundwater under the direct influence of surface water (GWUDISW) system.

AUTHORITY NOTE: Promulgated in accordance with R.S. 40:4 (A)(8) and R.S. 40:5 (5)(6).

HISTORICAL NOTE: Promulgated by the Department of Health and Hospitals, Office of Public Health, LR 28:1322 (June 2002), amended LR 28:2514 (December 2002).

§325. Treatment Chemicals and Components [formerly paragraph 12:007]

A. Chemicals used in the treatment of water to be used for potable purposes shall either meet the standards of the American Water Works Association or meet NSF 60 requirements as verified by an ANSI accredited testing agency. System wetted components shall meet NSF 61 as verified by an ANSI accredited testing agency.

AUTHORITY NOTE: Promulgated in accordance with R.S. 40:4 (A)(8) and R.S. 40:5.A. (5)(6).

HISTORICAL NOTE: Promulgated by the Department of Health and Hospitals, Office of Public Health, LR 28:1322 (June 2002), amended by the Department of Health, Office of Public Health, LR 43:86 (January 2017).

§327. Ground Water Supplies
[formerly paragraph 12:008-1]

A. All potable ground water supplies shall comply with the following requirements.

1. [formerly paragraph 12:008-2 Exclusion of Surface Water from Site] The ground surface within a safe horizontal distance of the source in all directions shall not be subject to flooding (as defined in Footnote 4 of §327.A.2 below) and shall be so graded and drained as to facilitate the rapid removal of surface water. This horizontal distance shall in no case be less than 50 feet for potable water supplies.

2. [formerly paragraph 12:008-3 Distances to Sources of Contamination] Every potable water well, and the immediate appurtenances thereto that comprise the well, shall be located at a safe distance from all possible sources of contamination, including but not limited to, privies, cesspools, septic tanks, subsurface tile systems, sewers, drains, barnyards and pits below the ground surface. The horizontal distance from any such possible source of pollution shall be as great as possible, but in no case less than the following minimum distances, except as otherwise approved by the state health officer.

Source	Distance in Feet
Septic tanks	50
Storm or sanitary sewer	50 ¹
Cesspools, outdoor privies, oxidation ponds, subsurface absorption fields, pits, mechanical sewage treatment plants, etc.	100 ²
Another water-well	25 ³
Sanitary landfills, feed lots, manure piles, solid waste dumps and similar installations	100
Drainage canal, ditch or stream	50 ⁴

¹ This distance may be reduced to 30 feet if the sewer is of cast iron with leaded joints or Schedule 40 plastic pipe with water-tight joints.

² For a private water well this distance may be reduced to 50 feet.

³ This minimum distance requirement does not take into consideration the effects of interference from pumping nearby wells in the same aquifer.

⁴ Horizontally measured from the water's edge to the well at the highest water level which may have occurred in a 10-year period.

3. [formerly paragraph 12:008-4 Leakage from Toilets and Sewers] No toilet, sewer, soil pipe or drain shall be located above or where leakage therefrom can reach any water storage basin, reservoir or source of water supply.

4. [formerly paragraph 12:008-5 Pits Near Water Supply] There shall be no unauthorized pits or unfilled spaces below level of ground surface, any part of which is within 50 feet of such water supply, except properly constructed well, pump, or valve pits as covered under §329.A.4 of this Part.

5. [formerly paragraph 12:008-6 Satisfactory Earth Formation above the Water Bearing Stratum] The earth formations above the water-bearing stratum shall be of such character and depth as to exclude contamination of the source of supply by seepage from the surface of the ground.

6. [formerly paragraph 12:008-7 Minimum Depth of Casings and Curbings] All well and spring basin casings or curbings shall extend a safe distance below the ground surface. The minimum depth of casings or curbings shall not be less than 50 feet in the case of public water supplies and not less than 10 feet in the case of private water supplies.

7. [formerly paragraph 12:008-8 Height of Casings and Curbings] In wells with pipe casings, the casings shall project at least 12 inches above ground level or the top of the cover or floor, and the cover or floor shall slope away from the well casing or suction pipe in all directions. Dug well linings shall extend at least 12 inches above the ground surface and cover installed thereon. The cover shall be watertight, and its edges shall overlap and extend downward at least 2 inches over the walls or curbings of such wells. In flood-prone areas the top of the casing shall be at least 2 feet above the highest flood level which may have occurred in a 10-year period, but in no case less than 2 feet above the ground surface.

8. [formerly paragraph 12:008-9 Grouting] The annular space between the well casing and the bore hole shall be sealed with cement-bentonite slurry or neat cement. Community public supply wells shall be cemented to their full depth from the top of the producing aquifer to the ground surface; noncommunity public supply wells shall be cemented from a minimum depth of 50 feet to the ground surface; and private supply wells shall be cemented from a minimum depth of 10 feet to the ground surface.

9. [formerly paragraph 12:008-10 Cover or Floors] Every dug well, spring, or other structure used as a source of potable water, or for the storage of potable water, shall be provided with a watertight cover. Covers and every pump room floor shall be constructed of concrete or similar impervious material, and shall be elevated above the adjacent ground level and sloped to facilitate the rapid removal of water so as to provide drainage from the cover or floor and prevent contamination of the water supply. Such cover or floor shall be constructed so that there are no copings, parapets, or other features which may prevent proper drainage, or by which water can be held on the cover. Concrete floors or cover slabs shall be of such thickness and so reinforced as to carry the load which may be imposed upon it, but in no case less than 4 inches thick.

10. [formerly paragraph 12:008-11 Potable Water Well Seals and Covers] Every potable water well shall be provided with a watertight sanitary well seal at the top of the casing or pipe sleeve. For wells with solid pedestal foundations, the well casing shall project at least 1 inch above the level of the foundation, and a seal between the well casing and the opening in the pump base plate shall be used to effectively seal the base plate to the well casing.

11. [formerly paragraph 12:008-12 Potable Water Well Casing Vents] All potable water well casings shall be vented to atmosphere as provided in §327.A.12 below, with the exception that no vent will be required when single-pipe jet pumps are used.

12. [formerly paragraph 12:008-13 Potable Water Well Vents] All potable water well vents shall be so constructed and installed as to prevent the entrance of contamination. All

vent openings shall be piped water tight to a point not less than 24 inches above the highest flood level which may have occurred in a 10-year period, but in no case less than 24 inches above the ground surface. Such vent openings and extensions thereof shall be not less than 1/2 inch in diameter, with extension pipe firmly attached thereto. The openings of the vent pipes shall face downward and shall be screened to prevent the entrance of foreign matter.

13. [formerly paragraph 12:008-14 Manholes] Manholes may be provided on dug wells, reservoirs, tanks, and other similar water supply structures. Every such manhole shall be fitted with a watertight collar or frame having edges which project at least 2 inches above the level of the surrounding surface, and shall be provided with a solid watertight cover having edges which overlap and project downward at least 2 inches around the outside of the frame. The cover shall be kept locked at all times, except when it is necessary to open the manhole.

14. [formerly paragraph 12:008-15 Well Construction Standards] All wells constructed to serve a potable water supply shall be constructed in accordance with *Louisiana Water Well Rules, Regulations, and Standards*. Drillers of wells to serve a potable water supply will comply with the requirements for licensing of water well drillers under state Act No. 715 of 1980 (R.S. 38:2226, 38:3098-3098.8) which is administered by the Louisiana Office of Public Works.

15. [formerly paragraph 12:008-16 Sampling Tap] All potable water supply wells shall be provided with a readily accessible faucet or tap on the well discharge line at the well for the collection of water samples. The faucet or tap shall be of the smooth nozzle type, shall be upstream of the well discharge line check valve and shall terminate in a downward direction.

16. [formerly paragraph 12:008-17 Disinfection of Wells] All new wells or existing wells on which repair work has been done shall be disinfected before being put into use as prescribed in §353.A of this Part.

AUTHORITY NOTE: Promulgated in accordance with R.S. 40:4 (A)(6)(8) and R.S. 40:5 (3)(5)(6)(9)(17)(20).

HISTORICAL NOTE: Promulgated by the Department of Health and Hospitals, Office of Public Health, LR 28:1322 (June 2002).

§329. Construction and Installation of Pumps [formerly paragraph 12:009-1]

A. All water pumps shall be so constructed and installed as to prevent contamination of the water supply.

1. [formerly paragraph 12:009-2 Hand Pump Head and Base] Every hand-operated pump shall have the pump head closed by a stuffing box or other suitable device to exclude contamination from the water chamber. The pump base shall be of solid one-piece recessed type of sufficient diameter and depth to admit the well casing as hereinafter provided. The top of the casing or sleeve of every well, equipped with such a pump, shall project into the base of the pump at least 1 inch above the bottom thereof and shall extend 12 inches above the level of the platform, well cover, or pump room floor on which the pump rests. The pump shall be fastened to the casing or sleeve. The pumps shall be of the self-priming type.

2. [formerly paragraph 12:009-3 Power Pump] Where pumps or pump motors are placed directly over the well, the pump or motor shall be supported on a base provided therefor. The well casing shall not be used to support pump or motor. This requirement shall not apply to submersible pumps/motors and single-pipe jet pumps/motors. The pump or motor housing shall have a solid watertight metal base without openings to form a cover for the well, recessed to admit the well casing or pump suction. The well casing or pump suction shall project into the base at least 1 inch above the bottom thereof, and at least 1 inch above the level of the foundation on which the pump rests. The well casing shall project at least 12 inches above ground level or the top of the floor.

3. [formerly paragraph 12:009-4] Where power pumps are not placed directly over the well, the well casing shall extend at least 12 inches above the floor of the pump house. In flood-prone areas the top of the casing shall extend at least 2 feet above the highest flood level which may have occurred in a 10-year period, but in no case less than 2 feet above the ground surface. The annular space between the well casing and the suction pipe shall be closed by a sanitary well seal to prevent the entrance of contamination.

4. [formerly paragraph 12:009-5 Well, Pump, Valve, and Pipe Pits] No well head, well casing, pump, or pumping machinery shall be located in any pit, room, or space extending below ground level, or in any room or space above the ground which is walled in or otherwise enclosed so that it does not have drainage by gravity to the surface of the ground, except in accordance with design approved by the state health officer, provided, that this shall not apply to a dug well properly constructed as herein prescribed.

5. [formerly paragraph 12:009-6 Pump House] All pump houses shall be properly constructed to prevent flooding, and shall be provided with floor drainage.

6. [formerly paragraph 12:009-7 Lubrication of Pump Bearings] Well pump bearings shall be lubricated with oil of a safe, sanitary quality or potable water.

7. [formerly paragraph 12:009-8 Priming of Power Pumps] Power pumps requiring priming shall be primed only with potable water.

8. [formerly paragraph 12:009-9 Priming of Hand Pumps] Hand-operated pumps shall have cylinders submerged so that priming shall not be necessary. No pail and rope, bailer, or chain-bucket systems shall be used.

9. [formerly paragraph 12:009-10 Airlift Systems] The air compressor and appurtenances for any airlift system or mechanical aerating apparatus used in connection with a potable ground water supply, shall be installed and operated in accordance with plans and specifications that have been approved as part of a permit issued by the state health officer.

AUTHORITY NOTE: Promulgated in accordance with R.S. 40:4 (A)(8) and R.S. 40:5 (5)(6).

HISTORICAL NOTE: Promulgated by the Department of Health and Hospitals, Office of Public Health, LR 28:1323 (June 2002).

§331. Well Abandonment
[formerly paragraph 12:010]

A. Abandoned water wells and well holes shall be plugged in accordance with the *Louisiana Water Well Rules, Regulations, and Standards*.

AUTHORITY NOTE: Promulgated in accordance with R.S. 40:4 (A)(8) and R.S. 40:5 (3)(5)(6)(9)(17)(20).

HISTORICAL NOTE: Promulgated by the Department of Health and Hospitals, Office of Public Health, LR 28:1324 (June 2002).

§333. Reservoir Sanitation
[formerly paragraph 12:011-1]

A. The state health officer may designate any water body, or a part of any water body, as a reservoir, where, in its use as a water source for public water supply, the control of other uses of the water body, or designated part of the water body, and its watershed, is necessary to protect public health.

1. [formerly paragraph 12:011-2] No cesspool, privy or other place for the deposit or storage of human excrement shall be located within 50 feet of the high water mark of any reservoir, stream, brook, or other watercourse flowing into any reservoir, and no place of this character shall be located within 250 feet of the high water mark of any reservoir or watercourse as above mentioned, unless such receptacle is so constructed that no portion of the contents can escape or be washed into the reservoir or watercourse.

2. [formerly paragraph 12:011-3] No stable, pigpen, chicken house or other structure where the excrement of animals or fowls is allowed to accumulate, shall be located within 50 feet of the high water mark of any reservoir or watercourse as above mentioned, and no structure of this character shall be located within 250 feet of the high water mark of such waters unless provision is made for preventing manure or other polluting materials from flowing or being washed into such waters.

3. [formerly paragraph 12:011-4] Boating, fishing, water skiing and swimming on any reservoir or watercourse as above mentioned shall be prohibited, or otherwise restricted by the state health officer, when it has been determined that the public served by the public water supply using the reservoir as a water source is exposed to a health hazard, and that such prohibitions or restrictions are therefore necessary. In any case, the aforementioned activities shall be prohibited within 100 feet of the water intake point of the public water supply.

4. [formerly paragraph 12:011-5 Industrial Wastes] No industrial waste which may cause objectionable changes in the quality of water used as a source of a public water supply shall be discharged into any lake, pond, reservoir, stream, underground water stratum, or into any place from which the waste may flow, or be carried into a source of public water supply. (Note: This was formerly numbered 12:024.).

AUTHORITY NOTE: Promulgated in accordance with R.S. 40:4 (A)(6)(8)(11) and R.S. 40:5 (3)(5)(6)(9)(17)(20).

HISTORICAL NOTE: Promulgated by the Department of Health and Hospitals, Office of Public Health, LR 28:1324 (June 2002).

§335. Distribution
[formerly paragraph 12:012-1]

A. All potable water distribution systems shall be designed, constructed, and maintained so as to prevent leakage of water due to defective materials, improper jointing, corrosion, settling, impacts, freezing, or other causes. Valves and blow-offs shall be provided so that necessary repairs can be made with a minimum interruption of service.

B.1. Any solder or flux which is used in the installation or repair of any public water system or any plumbing in a residential or nonresidential facility providing water for human consumption shall be lead free (i.e., shall not contain more than 0.2 percent lead). Any pipe, pipe fitting, plumbing fitting, fixture, and any other appurtenance which is used in the installation or repair of any public water system or any plumbing in a residential or nonresidential facility providing water for human consumption shall be lead free (i.e., shall not contain more than a weighted average of 0.25 percent lead when used with respect to the wetted surfaces of pipes, pipe fittings, plumbing fittings, fixtures, and any other appurtenances).

2. Exception. The lead free requirement of Paragraph B.1 above shall not apply to:

a. leaded joints necessary for the repair of existing cast iron pipes;

b. pipes, pipe fittings, plumbing fittings, fixtures and any other appurtenances, including backflow preventers, that are used exclusively for nonpotable services such as manufacturing, industrial processing, irrigation, outdoor watering, or any other uses where the water is not anticipated to be used for human consumption; or,

c. toilets, bidets, urinals, fill valves, flushometer valves, tub fillers, shower valves, service saddles, or water distribution main gate valves that are 2 inches in diameter or larger.

C.1. Water Piping Quality. All potable water pipes, pipe related products and materials that join or seal pipes and pipe related products shall be evaluated and listed as conforming with a national consensus product (or material) standard, ANSI/NSF Standard 61, and NSF/ANSI 372. Any solder or flux which is used in the installation or repair of any public water system or any plumbing in a residential or nonresidential facility providing water for human consumption shall be lead free.

2. Exception. The lead free requirement of Paragraph C.1 above shall not apply to:

a. leaded joints necessary for the repair of existing cast iron pipes;

b. pipes, pipe fittings, plumbing fittings, or fixtures, including backflow preventers, that are used exclusively for nonpotable services such as manufacturing, industrial processing, irrigation, outdoor watering, or any other uses where the water is not anticipated to be used for human consumption; or,

c. toilets, bidets, urinals, fill valves, flushometer valves, tub fillers, shower valves, service saddles, or water distribution main gate valves that are 2 inches in diameter or larger.

D. [formerly paragraph 12:012-3] Where pumps are used to draw water from a water supply distribution system or are placed in a system to increase the line pressure, provision must be made to limit the pressure on the suction side of the pump to not less than 20 psi (pounds per square inch) gauge. Where the use of automatic pressure cut-offs is not possible, such pumps must draw water from a tank, supplied with water from a water distribution system through an air gap that complies with ASME Standard A112.1.2-2004.

E. [formerly paragraph 12:012-4] All public water supplies shall be operated and maintained to provide a minimum positive pressure of 20 psi gauge at all service connections at all times.

AUTHORITY NOTE: Promulgated in accordance with the provisions of R.S. 40:4(A)(8), R.S. 40:5(A)(5)(6), and R.S. 40:1285.8.

HISTORICAL NOTE: Promulgated by the Department of Health and Hospitals, Office of Public Health, LR 28:1325 (June 2002), amended LR 38:2794 (November 2012), effective January 1, 2013, amended by the Department of Health, Office of Public Health, LR 48:1102 (April 2022).

§337. Storage

[formerly paragraph 12:013-1]

A. All finished water storage tanks shall be tightly covered and of watertight construction and made of concrete, steel or other materials approved for this purpose by the state health officer. When located wholly or partly below ground, such storage basins shall be of corrosion resistant materials.

B. [formerly paragraph 12:013-2] Cisterns used for potable water shall be provided with a rain water cut-off, suitable to deflect the first washings of the roof and prevent contamination of the water. Cisterns shall be tightly covered, and screened with 18-mesh wire screen.

C. [formerly paragraph 12:013-3 Vent Openings] Any vent, overflow, or water level control gauge provided on tanks or other structures containing water for any potable water supply shall be constructed so as to prevent the entrance of birds, insects, dust or other contaminating material. Openings or vents shall face downward and shall be not less than 2 feet above the floor of a pump room, the roof or cover of a tank, the ground surface or the surface of other water supply structures.

D. [formerly paragraph 12:013-4 Coatings] Paints or other materials used in the coating of the interior of cisterns, tanks or other containers in which potable water is processed or stored shall be nontoxic to humans and shall be of such composition that the palatability of the water stored or processed shall not be adversely affected. The "Standard for Coating Steel Water Storage Tanks" (AWWA D102-11) published by the American Water Works Association shall be complied with. Determination of acceptability of coatings for potable water applications by the U.S. Environmental Protection Agency may be considered evidence of compliance with this Subsection. (The AWWA Standard can

be obtained from the American Water Works Association, 6666 W. Quincy Ave., Denver, Colo. 80235.)

AUTHORITY NOTE: Promulgated in accordance with R.S. 40:4(A)(8) and R.S. 40:5(5)(6).

HISTORICAL NOTE: Promulgated by the Department of Health and Hospitals, Office of Public Health, LR 28:1325 (June 2002), amended LR 38:2376 (September 2012).

§339. Protection of Suction Pipes [formerly paragraph 12:014-1]

A. All subsurface suction piping, such as that leading from detached wells or reservoirs, shall be protected against the entrance of contamination.

B. [formerly paragraph 12:014-2] Valve boxes shall be provided for valves on buried suction lines. Every such valve box shall project at least 6 inches above the floor if in a room or building, and at least 12 inches above the ground if not enclosed in a building. The top of the box shall be provided with a cover with overlapping edges.

AUTHORITY NOTE: Promulgated in accordance with R.S. 40:4 (A)(8) and R.S. 40:5 (3)(5)(6)(9)(17)(20).

HISTORICAL NOTE: Promulgated by the Department of Health and Hospitals, Office of Public Health, LR 28:1325 (June 2002).

§341. Separation of Water Mains and Sewer Mains [formerly paragraph 12:015]

A. Sewer and water mains shall be laid in separate trenches not less than 6 feet apart horizontally, when installed in parallel. Crossing water and sewer mains shall have a minimum vertical separation of 18 inches. In cases where it is not possible to maintain a 6 foot horizontal separation, the state health officer may allow a waiver of this requirement on a case by case basis if supported by data from the design engineer.

AUTHORITY NOTE: Promulgated in accordance with R.S. 40:4 (A)(6)(8) and R.S. 40:5 (5)(6)(9).

HISTORICAL NOTE: Promulgated by the Department of Health and Hospitals, Office of Public Health, LR 28:1325 (June 2002).

§343. Cross Connections [formerly paragraph 12:016-1]

A. There shall be no physical connection between a public water supply and any other water supply which is not of equal sanitary quality and under an equal degree of official supervision; and there shall be no connection or arrangement by which unsafe water, hazardous fluid or contamination may enter a public water supply system.

B. [formerly paragraph 12:016-2] Water from any potable water supply complying with these requirements may be supplied to any other system containing water of questionable quality only by means of an independent line discharging not less than a distance equal to two times the pipe diameter or 2 inches, whichever is greater, above the overflow level of storage units open to atmospheric pressure or by other methods approved by the state health officer.

AUTHORITY NOTE: Promulgated in accordance with R.S. 40:4 (A)(7)(8) and R.S. 40:5(A). (3)(5)(6)(17)(20).

HISTORICAL NOTE: Promulgated by the Department of Health and Hospitals, Office of Public Health, LR 28:1325 (June

2002), amended by the Department of Health, Office of Public Health, LR 43:86 (January 2017).

§344. Protection of Water Supply/Containment Practices

A. As used in this Section, “mandatory containment practices” means the containment practices prescribed in and required by the state *Uniform Construction Code*, LAC 17:I, including maintenance and testing requirements, and any additional or related requirements of this Part.

B. In order to protect its water supply from potential contamination, each water supplier shall develop and implement a written backflow prevention plan outlining the policies and procedures it will use to verify that its customers comply with mandatory containment practices, and shall make a reasonable effort to ensure that only customers who comply with mandatory containment practices connect or remain connected to its water supply.

C. Unless otherwise directed by the state health officer, a water supplier shall disconnect or refuse to connect customers who:

1. fail to comply with mandatory containment practices; or
2. fail to provide or allow adequate confirmation of such compliance.

D. If a water supplier has a reasonable basis to believe that an unprotected or improperly protected cross connection exists on the premise of any customer not required to comply with mandatory containment practices, the water supplier shall take reasonable steps to perform one or more of the following:

1. confirm that the cross connection on the premise is eliminated or does not exist;
2. confirm that approved fixture isolation backflow protection is installed at the cross connection on the premise in accordance with the fixture isolation practices prescribed in and required by the state *Uniform Construction Code* (LAC 17:I);
3. confirm that approved containment backflow protection is installed; or
4. discontinue water service to the customer.

E. When deemed necessary to protect public health, the state health officer may issue an administrative order or emergency order requiring a water supplier to comply with this Section.

AUTHORITY NOTE: Promulgated in accordance with the provisions of R.S. 40:4(A)(8) and 40:5(A)(2)(3)(5)(6)(17)(20).

HISTORICAL NOTE: Promulgated by the Department of Health and Hospitals, Office of Public Health, LR 38:2795 (November 2012), amended by the Department of Health, Office of Public Health, LR 42:1094 (July 2016).

§345. Connection with Unsafe Water Sources Forbidden [formerly paragraph 12:017]

A. There shall be no cross-connection, auxiliary intake, bypass, inter-connection or other arrangement, including

overhead leakage, whereby water from a source that does not comply with these regulations may be discharged or drawn into any potable water supply which does comply with these requirements. The use of valves, including check or back pressure valves, is not considered protection against return flow, or back-siphonage, or for the prevention of flow of water from an unapproved source into an approved system.

AUTHORITY NOTE: Promulgated in accordance with R.S. 40:4 (A)(7)(8) and R.S. 40:5 (3)(5)(6)(17)(20).

HISTORICAL NOTE: Promulgated by the Department of Health and Hospitals, Office of Public Health, LR 28:1326 (June 2002).

§346. Installer, Repairer, Tester and Maintainer Qualifications for Backflow Prevention Devices and Methods

A. **Installer/Repairer/Maintainer Qualifications.** Backflow preventers shall be installed, repaired and/or maintained by a state Plumbing Board of Louisiana (SPBLA) -licensed plumber who holds an SPBLA water supply protection specialist endorsement on his/her plumbing license pursuant to R.S. 37:1361 et seq., and its implementing regulations (LAC 46:LV.101 et seq.). Backflow preventers associated with a landscape irrigation system may be installed, repaired and/or maintained by a Horticulture Commission of Louisiana-licensed landscape irrigation contractor who holds an SPBLA-issued special water supply protection specialist endorsement in accordance with R.S. 3:3808(P). Backflow preventers located on public property or otherwise under the complete control of the water supplier (for example, water meter and the piping upstream of the water meter, if provided), may be installed, repaired and/or maintained by a backflow prevention assembly repairer who meets the ASSE 5130-2009 (backflow prevention assembly repairer professional qualification standard) or other individuals holding a backflow prevention assembly repairer certificate from a nationally recognized backflow certification organization approved by the state health officer.

B. **Field Tester Qualifications.** Backflow preventers shall be tested by a state Plumbing Board of Louisiana (SPBLA) -licensed plumber who holds an SPBLA water supply protection specialist endorsement on his/her plumbing license pursuant to R.S. 37:1361 et seq., and its implementing regulations (LAC 46:LV.101 et seq.); or, by a backflow prevention assembly tester who meets ASSE 5110-2009 (backflow prevention assembly tester professional qualification standard), or other individuals holding a testing certificate from a nationally recognized backflow certification organization approved by the state health officer. Backflow preventers associated with a landscape irrigation system may be tested by a Horticulture Commission of Louisiana-licensed landscape irrigation contractor who holds an SPBLA-issued special water supply protection specialist endorsement in accordance with R.S. 3:3808(P).

AUTHORITY NOTE: Promulgated in accordance with R.S. 40:4(A)(8) and R.S. 40:5(A)(2)(3)(5)(6)(17)(20).

HISTORICAL NOTE: Promulgated by the Department of Health, Office of Public Health, LR 42:1095 (July 2016).

§347. Connections to Public Water Supply
[formerly paragraph 12:018]

A. All inhabited premises and buildings located within 300 feet of an approved public water supply shall be connected with such supply, provided that the property owner is legally entitled to make such a connection. The state health officer may grant permission to use water from some other source.

AUTHORITY NOTE: Promulgated in accordance with R.S. 40:4 (A)(8) and R.S. 40:5 (5)(6).

HISTORICAL NOTE: Promulgated by the Department of Health and Hospitals, Office of Public Health, LR 28:1326 (June 2002).

§349. Protection during Construction
[formerly paragraph 12:019]

A. All potable water supplies which are hereafter constructed, reconstructed, or extensively altered shall be protected to prevent contamination of the source during construction.

AUTHORITY NOTE: Promulgated in accordance with R.S. 40:4 (A)(8) and R.S. 40:5 (5)(6).

HISTORICAL NOTE: Promulgated by the Department of Health and Hospitals, Office of Public Health, LR 28:1326 (June 2002).

§351. Disinfection of Potable Water Supply Systems
[formerly paragraph 12:020-1]

A. Pipes, pumps, and other parts of water supply systems shall be disinfected when deemed necessary by the state health officer.

AUTHORITY NOTE: Promulgated in accordance with R.S. 40:4 (A)(8) and R.S. 40:5 (5)(6).

HISTORICAL NOTE: Promulgated by the Department of Health and Hospitals, Office of Public Health, LR 28:1326 (June 2002).

§353. Disinfection of New Water Supplies
[formerly paragraph 12:020-2]

A. Pumps, pipes, wells, tanks and other parts of new systems shall be thoroughly disinfected by the use of chlorine or chlorine compounds before being placed in use. The rate of application of chlorine shall be in such proportion to the rate of water entering the pipe or other appurtenances that the chlorine dose applied to the water shall be at least 50 mg/l. Chlorinated water shall be retained long enough to destroy non-spore-forming bacteria. The period shall be at least three hours and preferably longer, as may be directed. After the chlorine treated water has been retained for the required time, the chlorine residual at pipe extremities and at other representative points shall be at least 5 mg/l. If the residual is less than 5 mg/l, the disinfection procedure shall be repeated until a 5 mg/l residual is obtained, as required above.

B. [formerly paragraph 12:020-3] Large storage tanks may be disinfected by washing down the interior of the tank with a chlorine solution having at least 200 mg/l available chlorine and then washing the interior of the tank with potable water and wasting the wash water.

C. [formerly paragraph 12:020-4] Water from new systems, or from new parts of existing systems, shall not be

furnished for consumer's use until tests performed by a laboratory which is certified by the state health officer have shown the new system or new part of the system to be free from contamination by coliform bacteria (following EPA approved procedures prescribed in *Standard Methods for the Examination of Water and Wastewater*, Nineteenth Edition). Samples shall not be collected from the new facilities until such new facilities have been disinfected as prescribed in §353.A above, and the chlorinated water thoroughly flushed from the system.

AUTHORITY NOTE: Promulgated in accordance with R.S. 36:254 (B)(7), R.S. 40:4 (A)(8), and R.S. 40:5 (5)(6).

HISTORICAL NOTE: Promulgated by the Department of Health and Hospitals, Office of Public Health, LR 28:1326 (June 2002).

§355. Mandatory Disinfection
[formerly paragraph 12:021-1]

A. Routine, continuous disinfection is required of all public water systems.

1. Where a continuous chloramination (i.e., chlorine with ammonia addition) method is used, water being delivered to the distribution system shall contain a minimum concentration of 0.5 mg/l of chloramine residual (measured as total chlorine).

2. Where a continuous free chlorination method is used, water being delivered to the distribution system shall contain a minimum concentration of free chlorine residual in accordance with the following table.

Table 355.A.2	
pH Value	Free Chlorine Residual
up to 7.0	0.5 mg/l
7.0 to 8.0	0.6 mg/l
8.0 to 9.0	0.8 mg/l
over 9.0	1.0 mg/l

a. Table 355.A.2 does not apply to systems using chloramines.

b. pH values shall be measured in accordance with the methods set forth in §1105.D. of this Part.

B. All new groundwater systems installed after July 1, 1996 shall provide at least 30 minutes contact time prior to the first customer. It is recommended that all existing systems provide the 30 minutes contact time prior to the first customer. Additions to or extensions of existing systems are exempt from the 30 minutes contact time.

C. Public water systems which use surface water or ground water under the direct influence of surface water shall meet the requirements of applicable Sections of the surface water Treatment rule (LAC 51:XII.Chapter 11) as it pertains to CT and *Giardia*, *Cryptosporidium*, and virus removal/ inactivation/disinfection requirements.

AUTHORITY NOTE: Promulgated in accordance with R.S. 40:4(A)(8)(13) and R.S. 40:5(2)(3)(5)(6)(17)(20).

HISTORICAL NOTE: Promulgated by the Department of Health and Hospitals, Office of Public Health, LR 28:1326 (June 2002), amended LR 28:2514 (December 2002), LR 35:1240 (July 2009), LR 38:2376 (September 2012), LR 42:408 (March 2016), amended by the Department of Health, Office of Public Health, LR 44:1252 (July 2018), effective August 1, 2018.

§357. Minimum Disinfection Residuals
[formerly paragraph 12:021-2]

A. Disinfection equipment shall be operated to maintain disinfectant residuals in each finished water storage tank and at all points throughout the distribution system at all times in accordance with the following minimum levels:

1. a free chlorine residual of 0.5 mg/l; or
2. a chloramine residual (measured as total chlorine) of 0.5 mg/l for those systems that feed ammonia.

AUTHORITY NOTE: Promulgated in accordance with R.S. 40:4(A)(8)(13) and R.S. 40:5(2)(3)(5)(6)(17)(20).

HISTORICAL NOTE: Promulgated by the Department of Health and Hospitals, Office of Public Health, LR 28:1327 (June 2002), amended LR 42:409 (March 2016).

§358. Treatment Technique Requirement

A. Unless holding a valid variance from mandatory disinfection, each public water system using ground water as its source of water supply shall incur a treatment technique violation when it fails to comply with the minimum residual disinfectant concentration (0.5 mg/l free chlorine or total chlorine) in more than 5.0 percent of the samples collected each month from the distribution system for any two consecutive months. Upon the determination that a treatment technique violation has occurred, the public water system shall provide tier 2 public notification in accordance with §1907.

AUTHORITY NOTE: Promulgated in accordance with R.S. 40:4(A)(8)(13) and R.S. 40:5(2)(3)(5)(6)(17)(20).

HISTORICAL NOTE: Promulgated by the Department of Health and Hospitals, Office of Public Health, LR 42:409 (March 2016).

§359. Other Methods of Disinfection
[formerly paragraph 12:021-3]

A. Where chlorination is not used as the primary disinfectant, chlorine or chloramines shall be used as the secondary disinfectant to provide the residuals required in §357.A of this Part. Other methods shall be evaluated on a case-by-case basis by the state health officer.

AUTHORITY NOTE: Promulgated in accordance with R.S. 40:4(A)(8) and R.S. 40:5(5)(6).

HISTORICAL NOTE: Promulgated by the Department of Health and Hospitals, Office of Public Health, LR 28:1327 (June 2002).

§361. Implementation of Disinfection Requirements

A. A public water system not holding a disinfection variance on November 6, 2013 shall comply with the requirements of §355.A, §357, §367.C, and §367.G of this Part on the later of:

1. February 1, 2014; or
2. the expiration date of any additional time for compliance beyond February 1, 2014 granted by the state health officer. A request for additional time may be submitted in writing prior to February 1, 2014 only, and shall provide detailed justification and rationale for the additional time requested. The state health officer may grant such additional time if significant infrastructure

improvements are required to achieve compliance with said requirements.

B. A public water system holding a disinfection variance on November 6, 2013 shall comply with one of the following options by February 1, 2014:

1. implement continuous disinfection that complies with the requirements of §355.A, §357, §367.C, and §367.G of this Part;

2. request additional time for complying with the requirements of §355.A, §357, §367.C, and §367.G of this Part by submitting a written request, if significant infrastructure improvements are required to achieve compliance therewith or extraordinary circumstances exist with regard to the introduction of disinfection to the system. Such written request shall provide detailed justification and rationale for the additional time requested;

3. (This option shall be available only if the public water system's potable water distribution piping is utilized for onsite industrial processes.) notify the state health officer in writing that in lieu of implementing continuous disinfection, the public water system has provided, and will thereafter provide on a quarterly basis, notification to all system users, in a manner compliant with §1907 of this Part, that the system does not disinfect its water. The notification shall state that because the water is not disinfected, the water quality is unknown in regard to the *Naegleria fowleri* amoeba. A public water system selecting this option must sign an acknowledgement form, to be developed by the state health officer, stating that the public water system understands the risks presented by the lack of disinfection and that the public water system maintains responsibility for ensuring the safety of its water for end users; or

4. (This option shall be available only if the public water system's potable water distribution piping is utilized for onsite industrial processes.) request approval of an alternate plan providing water quality and public health protection equivalent to the requirements of §355.A and §357 of this Part. The state health officer may approve such a plan only if it is supported by peer reviewed, generally accepted research and science.

AUTHORITY NOTE: Promulgated in accordance with R.S. 40:4(A)(8)(13) and R.S. 40:5(2)(3)(5)(6)(17)(20).

HISTORICAL NOTE: Promulgated by the Department of Health and Hospitals, Office of Public Health, LR 42:409 (March 2016).

§363. Revocation of Variances
[formerly paragraph 12:021-5]

A. A variance from mandatory disinfection shall be revoked when a public water system has a bacteriological MCL violation. When a variance is revoked, the system shall install mandatory continuous disinfection as stated in §355 of this Part within the times specified in a compliance schedule submitted to and approved by the state health officer. Such schedule shall be submitted within 10 days of receipt of notice of revocation.

B. Except for variances held by qualifying public water systems that comply with §361.B.3 of this Part or receive approval of an alternate plan under §361.B.4 of this Part, any

variance concerning the mandatory disinfection requirements of §355 and/or §357 of this Part held by a public water system as of November 6, 2013 shall be automatically revoked on the later of:

1. February 1, 2014;
2. the expiration date of any additional time for compliance granted by the state health officer under §361.B.2 of this Part; or
3. the denial of a request for approval of an alternate plan submitted under §361.B.4 of this Part.

AUTHORITY NOTE: Promulgated in accordance with R.S. 40:4(A)(8)(13) and R.S. 40:5(2)(3)(5)(6)(17)(20).

HISTORICAL NOTE: Promulgated by the Department of Health and Hospitals, Office of Public Health, LR 28:1327 (June 2002), amended LR 42:409 (March 2016).

§365. Batch Disinfection
[formerly paragraph 12:021-6]

A. The state health officer may allow batch disinfection for emergency purposes. Batch disinfection shall not be considered a method of continuous disinfection.

AUTHORITY NOTE: Promulgated in accordance with R.S. 40:4 (A)(8)(13) and R.S. 40:5 (2)(3)(5)(6)(17)(20).

HISTORICAL NOTE: Promulgated by the Department of Health and Hospitals, Office of Public Health, LR 28:1327 (June 2002).

§367. Disinfectant Residual Monitoring and Record Keeping
[formerly paragraph 12:021-7]

A. Disinfectant Residual Monitoring in Treatment Plant. A public water system shall measure the residual disinfectant concentration in water being delivered to the distribution system at least once per day.

B. Disinfectant Residual Monitoring in Distribution System. A public water system shall measure the residual disinfectant concentration within the distribution system:

1. by sampling at the same points in the distribution system and at the same times that samples for total coliforms are required to be collected by the public water system under this Part;
2. by sampling at an additional number of sites calculated by multiplying 0.25 times the number of total coliform samples the public water system is required under this Part to take on a monthly or quarterly basis, rounding any mixed (fractional) number product up to the next whole number. These additional residual monitoring samples shall be taken from sites in low flow areas and extremities in the distribution system at regular time intervals throughout the applicable monthly or quarterly sampling period; and
3. by sampling at the site that represents the maximum residence time (MRT) in the distribution system at least once per day.

C. A public water system shall increase sampling to not less than daily at any site in the distribution system that has a measured disinfectant residual concentration of less than 0.5 mg/l free chlorine or 0.5 mg/l chloramine residual (measured

as total chlorine) until such disinfectant residual concentration is achieved at such site.

D. The records of the measurement and sampling required under Subsections A and B of this Section shall be maintained on forms approved by the state health officer and shall be retained as prescribed in the national primary drinking water regulations, and shall be made available for review upon request by the state health officer.

E. Each public water system shall submit a monitoring plan to the state health officer for review and approval. The monitoring plan shall be submitted in a format approved by the state health officer and shall include all the total coliform and disinfectant residual monitoring sites required under this Section and §903.A of this Part. All monitoring sites shall be identified along with a 911 street address, a latitude/longitude coordinate, and a brief description of the site location. A public water system in existence as of November 6, 2013 shall submit such a monitoring plan no later than January 1, 2014 and shall update the monitoring plan as requested by the state health officer and/or as monitoring sites change.

F. Chlorine residuals shall be measured in accordance with the analytical methods set forth in §1105.C of this Part.

G. Where a continuous chloramination (i.e., chlorine with ammonia addition) method is used or where water that is provided to customers contains chloramines, a nitrification control plan shall be developed and submitted to the state health officer. A public water system in existence as of November 6, 2013 shall submit and comply with such a nitrification control plan no later than January 1, 2017. The plan shall conform to the guidelines contained in industry standards such as the American Water Works Association's *M56 Manual on Nitrification* and contain at least the following information:

1. at a minimum, the following parameters shall be monitored and recorded in accordance with the following:

a. free ammonia at least once per week in water being delivered to the distribution system (i.e., point of entry) unless an alternate measurement or method is approved by the state health officer;

b. nitrite at least once per quarter and in response to an action level trigger within the distribution system at sites prone to nitrification such as storage tanks and low flow areas;

2. a response plan with expected water quality ranges and action levels to control nitrification and ensure compliance with §357 of this Part.

H. Public water systems utilizing chloramination shall review and update the nitrification control plan required under Subsection G of this Section as requested by the state health officer.

1. In addition, the nitrification control plan and monitoring results shall be retained on-site for a minimum of five years and shall be made available to the state health officer upon request and/or when the public water system fails to comply with §357 of this Part.

AUTHORITY NOTE: Promulgated in accordance with R.S. 40:4(A)(8)(13) and 40:5(2)(3)(5)(6)(17)(20).

HISTORICAL NOTE: Promulgated by the Department of Health and Hospitals, Office of Public Health, LR 28:1327 (June 2002), amended LR 30:1195 (June 2004), LR 42:409 (March 2016).

§369. Water Shall Be Provided
[formerly paragraph 12:022-1]

A. It shall be the duty of the owner or manager of any premises occupied as a residence, hotel, lodging house, tenement house, office building, shop, factory, or waiting room or depot of a railroad or other common carrier to provide a safe supply of potable water for human consumption and for sanitary purposes.

B. [formerly paragraph 12:022-2] In all cases where the owner or owners of the property or premises referred to in this Code shall not reside in the place where the property is situated, or when such property shall belong to an estate, succession or corporation, it shall be the duty of the agent, or representative of the owners thereof, or the persons who shall have charge of said property for the owners thereof, or who shall collect the rent of such premises, if the same is rented, to provide and furnish such premises with a safe and adequate potable water supply. In case such person shall fail or neglect to supply the same to such premises, within 15 days after due notice, he shall be in violation of the provisions of this Part.

C. [formerly paragraph 12:022-3] Each public, parochial and private school shall be provided with a potable water supply which is approved as to source, location, and distribution by the state health officer.

D. [formerly paragraph 12:022-4] It shall be the duty of all employers to supply an adequate, safe, potable water supply for all employees.

E. [formerly paragraph 12:022-5] Wherever a public water supply is available, no other supply shall be furnished for potable purposes to employees in any factory or industrial plant, or other place of business, unless such other supply is approved by the state health officer. If no public water supply is available, the water for potable purposes shall be of safe, sanitary quality approved by the state health officer. If the water supply for industrial or fire protection purposes is obtained entirely or in part from a source not approved for potable purposes, this supply shall be distributed through an independent piping system having no connection with the system carrying potable water. All faucets or other outlets furnishing water which is not safe for potable purposes shall be conspicuously so marked.

AUTHORITY NOTE: Promulgated in accordance with R.S. 40:4 (A)(4)(5)(8)(10) and R.S. 40:5 (2)(3)(5)(6)(16)(17)(20).

HISTORICAL NOTE: Promulgated by the Department of Health and Hospitals, Office of Public Health, LR 28:1327 (June 2002).

§371. Public Drinking Fountains
[formerly paragraph 12:023-1]

A. All public drinking fountains shall be designed and constructed in accordance with the provisions of the Louisiana State Plumbing Code (LSPC). Drinking fountains

and coolers shall be constructed of lead free materials as specified in §335.B of this Part.

B. [formerly paragraph 12:023-2] Water fountains and coolers shall be so constructed that the ice or other refrigerant used for cooling cannot come in contact with the water.

C. [formerly paragraph 12:023-3] Where water coolers or supply tanks used for drinking water are not directly connected to the source of supply, arrangements for filling the containers shall be such as to prevent contamination of the water.

D. [formerly paragraph 12:023-4] The use of a common drinking cup is prohibited.

AUTHORITY NOTE: Promulgated in accordance with the provisions of R.S. 40:4.A(7)(8) and 40:5(5)(6).

HISTORICAL NOTE: Promulgated by the Department of Health and Hospitals, Office of Public Health, LR 28:1328 (June 2002), amended LR 38:2795 (November 2012).

§373. Potable Water Loading Stations
[formerly paragraph 12:024]

A. Portable hoses used for filling water containers shall be provided with a metal disk at the nozzle to prevent contact of nozzle with ground or floors. When not in use, the portable hoses shall be protected from dirt and contamination by storage in a tightly enclosed cabinet and shall have a cap to cover the nozzle.

AUTHORITY NOTE: Promulgated in accordance with R.S. 40:4 (A)(7)(8) and R.S. 40:5 (5)(6).

HISTORICAL NOTE: Promulgated by the Department of Health and Hospitals, Office of Public Health, LR 28:1328 (June 2002).

§375. Issuance of Emergency Boil Notices
[formerly paragraph 12:025]

A. An emergency boil notice, when it is deemed necessary to protect public health, shall be authorized only by the state health officer. Once implemented, said notice may be rescinded or cancelled only by the state health officer.

AUTHORITY NOTE: Promulgated in accordance with R.S. 40:4 (A)(8)(13) and R.S. 40:5. (2)(3)(5)(6)(17)(20).

HISTORICAL NOTE: Promulgated by the Department of Health and Hospitals, Office of Public Health, LR 28:1328 (June 2002).

§377. Adoption by Reference
[formerly paragraph 12:026]

A. The National Primary Drinking Water Regulations, as defined in §101 of this Part, are hereby incorporated by reference into this Part of the sanitary code and shall have the same force and effect of state law as any other Section of this Part just as if they had been fully published herein. Every public water system shall comply with the National Primary Drinking Water Regulations as defined herein. When the National Primary Drinking Water Regulations as defined herein and the state's own rules and/or regulations applicable to public water systems conflict, the state's own rules and/or regulations shall govern [e.g., the Louisiana Total Coliform Rule (Chapter 9 of this Part, formerly

Appendix C) provisions shall govern when any of the federal Total Coliform Rule provisions are found to conflict].

AUTHORITY NOTE: Promulgated in accordance with R.S. 36:254 (B)(7), R.S. 40:4 (A)(8), and R.S. 40:5 (2)(3)(5)(6)(17)(20).

HISTORICAL NOTE: Promulgated by the Department of Health and Hospitals, Office of Public Health, LR 28:1328 (June 2002).

Chapter 4. Community Water System Accountability Rule

§401. Statement of Purpose

A. Pursuant to Act 98 of the 2021 Regular Legislative Session, the LDH-OPH adopts a letter grade schedule for community water systems to provide an accountability process to support drinking water infrastructure sustainability for the citizens of Louisiana.

AUTHORITY NOTE: Promulgated in accordance with R.S. 40:4(A)(8), R.S. 40:5.A.(2)(3)(5)(6)(17)(20) and R.S. 40:5.9.1.D.(1).

HISTORICAL NOTE: Promulgated by the Department of Health, Office of Public Health, LR 48:1102 (April 2022).

§403. General Provisions

A. The requirements established in this Chapter are applicable to community water systems as defined in this Part and under R.S. 40:5.8.

B. For each active community water system (CWS), LDH-OPH shall determine and publish an annual letter grade and score in accordance with this Chapter. The CWS annual letter grade shall be based on the CWS final score calculated in accordance with §407 of this Part using the letter grade schedule standards specified in §405 of this Part.

1. The letter grades and scores published January 1, 2023 are preliminary and shall be finalized and republished no later than May 1, 2023 on the LDH-OPH website. For subsequent years starting in 2024, the final letter grades and scores shall be published on the LDH-OPH website by May 1 each year. The published letter grades and scores are not subject to change after May 1 until the next annual letter grade and score is published.

C. Community water systems shall include their final letter grade and score in their annual Consumer Confidence Report (a.k.a. Annual Water Quality Report) that is posted on the water systems website.

D. For any community system that receives a letter grade of “D” or “F”, LDH-OPH shall give notice to the State Bond Commission, the Louisiana Public Service Commission, Louisiana Legislative Auditor and the Attorney General in accordance with Act 98 of the 2021 Regular Legislative Session.

AUTHORITY NOTE: Promulgated in accordance with R.S. 40:4(A)(8), R.S. 40:5.A.(2)(3)(5)(6)(17)(20) and R.S. 40:5.9.1.D.(1).

HISTORICAL NOTE: Promulgated by the Department of Health, Office of Public Health, LR 48:1102 (April 2022).

§405. Letter Grade Schedule

A. The letter grade and score for community water systems shall be based on the following standards and point deductions.

1. For federal water quality violations history:

a. five points shall be deducted for each maximum contaminant level (MCL) violation incurred during the graded year;

b. five points shall be deducted for each Lead and Copper Rule treatment technique (TT) violation inclusive of failure to install corrosion control treatment or failure to maintain optimal water quality parameters for optimized corrosion control treatment incurred for the last monitoring period; and

c. an additional 10 points shall be deducted for non-compliance with an administrative order issued for MCL or TT violations.

d. the total points deducted for federal water quality violations shall not exceed 30.

2. For state violations history:

a. one point shall be deducted for each chlorine residual violation incurred during the graded year;

b. five points shall be deducted for failure to have a duly-certified operator at a ground water system;

c. ten points shall be deducted for failure to have a duly-certified operator at a surface water system; and

d. five points shall be deducted for a water outage and/or a boil notice issued by the state health officer.

e. the total points deducted for state violations shall not exceed 10.

3. For water system financial sustainability:

a. five points shall be deducted for failure to have and submit a rate study (per §§409 and 411 of this Part) or failure to have implemented an adequate rate (as indicated by the system’s rate study);

b. five points shall be deducted for failure to have a current audit (if applicable);

c. ten points shall be deducted if a fiscal administrator is appointed for the municipality; and

d. five points shall be deducted for circumstances that affect the fiscal control of the community water system.

e. the total points deducted for financial sustainability shall not exceed 10.

4. For operation and maintenance performance history:

a. three points shall be deducted for each unresolved significant deficiency. Such deficiencies shall include lack of cross-connection control, record keeping, maintenance and other applicable deficiencies specified in §319.D of this Part;

PUBLIC HEALTH—SANITARY CODE

b. the total points deducted for operation and maintenance performance history shall not exceed 15.

5. For infrastructure violations:

a. five points shall be deducted for each unresolved significant deficiency. Such deficiencies shall include frequent low water pressure events, no standby power, single source, failed components and other applicable significant deficiencies specified in §319.D of this Part.

b. the total points deducted for infrastructure violations shall not exceed 20.

6. For customer satisfaction:

a. one point shall be deducted for each validated water complaint (per event) concerning water quality or quantity received either by the water system or LDH-OPH for the graded year; or

b. ten points shall be deducted for failure to submit the complaint log by the deadline specified in §411 of this Part;

c. the total points deducted for customer satisfaction shall not exceed 10.

7. For level of secondary contaminants:

a. five points shall be deducted for either iron or manganese detected (LDH-OPH test results) in the finished drinking water above their respective secondary maximum contaminant level (0.3 mg/L for iron and 0.05 mg/L for manganese);

b. the total points deducted for secondary contaminants shall not exceed five.

B. Extra points may be granted and added to the final score of the community water system in accordance with this Subsection.

1. Five points can be granted for having and submitting supporting documentation for any of the following:

- a. an asset management plan;
- b. a storage assessment and maintenance program;
- c. a well assessment and maintenance program;
- d. participation in a capacity development program approved by LDH-OPH; or
- e. participation in a management training program approved by LDH-OPH.

2. The total points added for extra points shall not exceed 10.

AUTHORITY NOTE: Promulgated in accordance with R.S. 40:4(A)(8), R.S. 40:5.A.(2)(3)(5)(6)(17)(20) and R.S. 40:5.9.1.D.(1).

HISTORICAL NOTE: Promulgated by the Department of Health, Office of Public Health, LR 48:1102 (April 2022).

§407. Calculation of Letter Grade and Score

A. The score for each community water system shall be calculated per the following method:

1. Using the Letter Grade Schedule in §405 of this Part, sum the points deducted for each standard specified in §405.A.1-7.b and subtract the total point deduction from 100. Extra points can be added to the final score if granted per §405.B of this Part. See Table 407.A.1 (below) for an example of the grade score calculation.

Grade Standards	Point Deductions
1. Federal Water Quality Violations	0
2. State Violations	2
3. Financial Sustainability	0
4. Operation and Maintenance Performance	3
5. Infrastructure Violations	0
6. Customer Satisfaction	5
7. Level of Secondary Contaminants	5
Total Point Deduction	15
Extra Points	5
Score = 100 – Total Point Deduction + Extra Points (Score = 100 – 15 + 5)	90
Letter Grade	A

B. The letter grade for each community water system shall be assigned based on Table 407.B (below) using the score calculation specified in §407.A.1 of this Part.

Letter Grade	Point Value
A	≥ 90
B	80 - 89
C	70 - 79
D	60 - 69
F	≤ 59

AUTHORITY NOTE: Promulgated in accordance with R.S. 40:4(A)(8), R.S. 40:5.A.(2)(3)(5)(6)(17)(20) and R.S. 40:5.9.1.D.(1).

HISTORICAL NOTE: Promulgated by the Department of Health, Office of Public Health, LR 48:1103 (April 2022).

§409. Financial Sustainability Requirements

A. Community water systems shall have a rate assessment or study performed every 5 years by a qualified entity approved by the state health officer. Qualified entities include, but are not limited to, a Louisiana licensed professional engineer, a certified public accountant (CPA), or the Louisiana Rural Water Association (LRWA).

1. A rate study shall include a rate analysis completion report containing the following:

- a. the completed rate analysis;
- b. the rate analysis summary letter that includes the rate analysis findings and recommendations to maintain sustainability; and
- c. documentation that includes the dates that the rate analysis was presented to the legally responsible person for the community water system and the decision to implement or reject the rate analysis findings.

AUTHORITY NOTE: Promulgated in accordance with R.S. 40:4(A)(8), R.S. 40:5.A.(2)(3)(5)(6)(17)(20) and R.S. 40:5.9.1.D.(1).

HISTORICAL NOTE: Promulgated by the Department of Health, Office of Public Health, LR 48:1104 (April 2022).

§411. Reporting Requirements

A. Community water systems shall submit the following information to LDH-OPH in a format approved by LDH-OPH by January 31 of each year starting 2023 unless specified otherwise in this Section.

1. A rate study performed on or after April 20, 2017 and in accordance with §409.A of this Part along with the current water rates for the community water system and any documentation authorizing and adopting the last rate increase. Unless updated, a rate study is not required to be submitted every year.

2. The last annual report (as submitted to Louisiana Secretary of State) and the prior year financial report for the company owning the community water system, or a prior year audit report (as submitted to the Louisiana Legislative Auditor) for the political subdivision (e.g., municipality) over the community water system.

3. A demonstrated flushing plan with verification of implementation if directed by LDH-OPH to have a flushing program to mitigate poor water quality in the distribution system as required by Louisiana Revised Statutes 40:1281.12.

4. A complaint log containing all water related complaints received by the community water system for the previous calendar year as required by Louisiana Revised Statutes 40:1281.12.

5. The documentation for items listed in §405.B.1 of this Part if the community water system wants to receive extra points per §§405.B and 407.A.1.

AUTHORITY NOTE: Promulgated in accordance with R.S. 40:4(A)(8), R.S. 40:5.A.(2)(3)(5)(6)(17)(20) and R.S. 40:5.9.1.D.(1).

HISTORICAL NOTE: Promulgated by the Department of Health, Office of Public Health, LR 48:1104 (April 2022).

Chapter 5. Civil Penalty Assessment Rule [formerly appendix A]

§501. Statement of Purpose [formerly section 1.1 of paragraph I of appendix A]

A. This rule is intended to be a mechanism to secure rapid and full compliance with the requirements of the state sanitary code and other applicable laws and regulations relative to public water systems providing safe drinking water. It is not intended as a revenue gathering mechanism, and the Safe Drinking Water Program is not dependent upon any level of penalty revenue to balance its budget. It is based on the principle of reasonable enforcement guidelines to be vigorously implemented. As defined by R.S. 40:5.9, penalties may be assessed only on the basis of non-compliance with corrective orders, rather than on the basis of the mere existence of a violation.

AUTHORITY NOTE: Promulgated in accordance with R.S. 40:5.9 (A)(4).

HISTORICAL NOTE: Promulgated by the Department of Health and Hospitals, Office of Public Health, LR 28:1328 (June 2002).

§503. General Provisions [formerly section 2.1 of paragraph II of appendix A]

A. Nothing herein shall be construed to prohibit the state health officer from modifying the contents of an administrative order if changes are warranted to ensure compliance with applicable laws and regulations or to allow for the practical ability to comply with the items so ordered. It is incumbent upon the person to whom the administrative order was issued to submit a written request for order modifications when, for instance, it is realized that compliance cannot be achieved within the time constraints specified in the order due to unforeseen problems or delays such as inclement weather conditions. Such requests shall be considered if the request is received by the state health officer not later than five days before the compliance deadline expires. In order to show proof and date of service, the person requesting any order modifications shall do so by at least one of the following methods:

1. use of the United States Postal Service via certified mail-return receipt requested, registered mail-return receipt requested, or express mail-return receipt requested;

2. transmission by facsimile machine will also be accepted; however, the state health officer shall be deemed not to have officially received a facsimile transmission until such time as the requester has received a written acknowledgment, via facsimile or mail, of receipt from the Office of Public Health. Said acknowledgment of receipt shall state the date when the Office of Public Health actually received the transmission and this date, regardless the sender's transmission date, shall be used in the determination of whether or not the time limit stated above was met. It is the responsibility of the sender to ask the Office of Public Health for a written acknowledgment of receipt of any facsimile transmissions which may be sent to the state health officer;

3. use of a private shipping service, such as United Parcel Service, Federal Express, etc., when such a service can provide a written receipt to the sender stating the date of delivery to the state health officer.

B. [formerly Section 2.2 of Paragraph II of Appendix A] Additionally, nothing herein shall be construed to mandate that the state health officer is required to assess penalties in the event of noncompliance with a provision of an administrative compliance order issued pursuant to R.S. 40:5.9; however, this rule is intended to delineate the procedure for calculating the monetary amount of the civil penalty assessment after the state health officer has decided to assess and impose penalties for noncompliance.

C. [formerly Section 2.3 of Paragraph II of Appendix A] When reference is made to a public water system herein, such reference is limited to an individual public water system uniquely identified by its own Public Water System Identification Number (PWS ID No.).

AUTHORITY NOTE: Promulgated in accordance with R.S. 40:5.9 (A)(4).

HISTORICAL NOTE: Promulgated by the Department of Health and Hospitals, Office of Public Health, LR 28:1329 (June 2002).

**§505. Calculation of Daily Penalties
[formerly section 3.1 of paragraph III of
appendix A]**

A. R.S. 40:5.9(A) authorizes the state health officer to assess a civil penalty up to \$3,000 a day for each day of violation and for each act of violation of a provision of an administrative compliance order.

B. [formerly section 3.2 of paragraph III of appendix A] For purposes of implementation of R.S. 40:5.9, violation of one or more provisions of an administrative compliance order shall be handled as follows.

1. All violations for a given public water system shall be handled as a package (i.e., the statutory maximum daily penalty of \$3,000 per day per violation will be handled as a maximum daily penalty of \$3,000 per day per public water system regardless of the number of individual violations). The daily penalty assessment amount shall be based upon the most serious uncorrected violation. As the level of seriousness classification or the level of culpability associated with the most serious uncorrected violation in the package changes, the daily penalty assessment amount will be recalculated accordingly from that time forward and added to any previously calculated assessment amounts.

2. In lieu of the requirements of §505.B.1 above, the state health officer, at his sole discretion, is authorized to impose a penalty of no less than \$1,000 per day per violation for those public water systems serving more than 10,000 individuals [see Fed. Reg.: April 28, 1999 (Volume 63, Number 81, page 23,367)].

C. [formerly section 3.3 of paragraph III of appendix A] The maximum daily penalty applicable to a particular public water system in violation of one or more of the provisions of an administrative compliance order shall be determined as follows.

1. When a penalty is calculated pursuant to §505.B.1 above, the maximum daily penalty shall be set at \$1 per service connection per day based upon the number of service connections listed on Office of Public Health records on the day the administrative order was first issued, but within the following limitations and restrictions.

a. The maximum daily penalty for public water systems having more than 3,000 service connections shall be \$3,000 per day.

b. The maximum daily penalty for public water systems having less than 30 service connections shall be \$30 per day.

2. When a penalty is calculated pursuant to §505.B.2 above, the maximum daily penalty shall be set at \$1 per service connection per day per violation based upon the number of service connections listed on Office of Public Health records on the day the administrative order was first issued, but within the following limitations and restrictions.

a. The maximum daily penalty for public water systems having more than 3,000 service connections shall be \$3,000 per day per violation.

b. The maximum daily penalty for public water systems having 2,500 service connections (i.e., equivalent to 10,000 individuals served) shall be \$2,500 per day per violation.

D. [formerly section 3.4 of paragraph III of appendix A] Pursuant to §505.B and C above, the exact level of the daily penalty shall be based on the seriousness of the violation and culpability of the owner and/or operator as follows.

1. Using the maximum daily penalty specified in §505.C above as the basis for calculation, 50 percent of the maximum daily penalty amount shall be judged on the seriousness of the violation and the other 50 percent shall be judged on the culpability of the owner and/or operator.

2. The decision regarding the exact penalty assessment amounts for the seriousness of the violation(s) and the accompanying culpability of the owner and/or operator shall be made by the state health officer after considering a staff recommendation based upon the "Accompanying Guidelines to the Civil Penalty Assessment Rule" (Chapter 7 of this Part, formerly Appendix B).

3. When the state health officer utilizes §505.B.2 above as the basis for penalty calculation, the minimum daily penalty assessment amount shall in no case be less than \$1,000 per day per violation after the provisions of §505.D.1 and 2 are applied [see Fed. Reg.: April 28, 1999 (Volume 63, Number 81, page 23,367)].

E. [formerly section 3.5 of paragraph III of appendix A] The duration of non-compliance with a provision of the administrative compliance order shall be determined as follows.

1. Once an administrative order has become final and not subject to further administrative review, the state health officer shall direct staff to conduct an initial investigation for the purpose of determining compliance/non-compliance with the provision(s) of the administrative order. The initial investigation shall be conducted within five working days after the time limit granted for compliance within the administrative order ends. If upon agency investigation it is found that non-compliance still exists, staff will immediately provide a copy of the investigatory report to the person on-site in responsible charge of the public water system which will serve to notify the person to whom the administrative order was issued that the agency has determined that non-compliance still exists and that daily penalty assessments shall begin to accrue immediately from this date forward until such time as the agency has been notified by the public water system that compliance has been achieved. If a representative of the public water system is not present or reasonably available at the time of the agency's investigation, staff shall, on the same day as the investigation, attempt to contact via telephone or facsimile machine the person to whom the administrative order was issued or such other responsible person in the employ of the public water system in order to provide speedy notification of results which are deemed by agency staff to cause the continuance of daily penalty assessments. In the latter case

involving only verbal or electronic communication, agency staff shall, as soon as possible thereafter, transmit a copy of the investigatory report to the person to whom the administrative order was issued by one of the methods of mailing stated in §503.A.1 of this Part.

2. After the agency has conducted the initial investigation, determined that non-compliance with a provision of the administrative order still exists, and has provided a copy of the investigatory report as stated in §505.E.1 above, it then becomes incumbent upon the person to whom the administrative order was issued to notify the agency when compliance has been achieved. In order to show proof and date of service, such notice advising the agency of compliance shall be transmitted to the agency in the same manner as described in §503.A.1, 2, or 3 of this Part. Until such time as the agency has been properly notified of correction, the agency will consider the duration to begin on the date of the initial investigation and will presume that such violation is continuing on a daily basis until such time as the agency has received notification of correction. Once the agency is notified of correction, agency staff shall conduct a follow-up investigation in order to confirm compliance. Such follow-up investigation shall be conducted within 10 working days of agency receipt of the public water system's notice of compliance. If upon agency's follow-up investigation it is found that non-compliance still exists, staff will so advise the public water system in the same manner as done for initial investigations with the exception that the public water system will be advised that previously running daily penalty assessments have and will continue to accrue pending yet additional notification of compliance by the public water system to the agency. When the results of the follow-up investigation confirm that compliance has in fact been achieved, then the date that the agency received notification of compliance from the public water system for the particular provision of the administrative order in question shall be considered the last day of non-compliance for purposes of calculating the duration for non-compliance with this particular provision.

3. The steps described in §505.E.1 or 2 above may continue for an indefinite period of time but shall end once compliance has been confirmed by agency staff unless such violation is found to reoccur while the administrative order is still in effect.

AUTHORITY NOTE: Promulgated in accordance with R.S. 40:5 (6) and R.S. 40:5.9 (A)(4).

HISTORICAL NOTE: Promulgated by the Department of Health and Hospitals, Office of Public Health, LR 28:1329 (June 2002).

§507. Payment of Penalty/Ability to Request Mitigation of Penalty and/or Adjudicatory Hearing

A. [formerly section 4.1 of paragraph IV of appendix A] At the discretion of the state health officer, notice(s) imposing penalty assessments may be issued from time to time subsequent to either initial non-compliance with any provision of the administrative compliance order or subsequent to any continuance or reoccurrence of non-compliance while the administrative compliance order remains effective. Notices of imposition of penalties shall be

served by one of the forms of service described in §503.A.1 of this Part or hand-delivered. Within the notice imposing the penalty assessment, the state health officer will inform the owner and/or operator of the public water system of the ability to apply for mitigation of the penalties imposed and for the opportunity for an adjudicatory hearing on the record relative to contesting the imposition of the penalty assessment. Penalties shall not be imposed upon any person without notice and opportunity for hearing.

B. [formerly section 4.2 of paragraph IV of appendix A] Once a penalty assessment is imposed, it shall become due and payable 35 days after receipt of notice imposing the penalty unless a written application for mitigation or a written request for an adjudicatory hearing on the record relative to contesting the imposition of the penalty assessment is received by the state health officer within 20 days after said notice is served. In order to show proof and date of service, the person applying for mitigation or an adjudicatory hearing shall transmit the written application for mitigation or written request for hearing to the agency in the same manner as described in §503.A.1, 2, or 3 of this Part.

C. [formerly section 4.3 of paragraph IV of appendix A] Upon receipt of a written application for mitigation of such penalty, the state health officer may mitigate the penalty, i.e., upon proof that all of the stipulations in the administrative order have now been complied with or upon agreement to and compliance with a Stipulation and Agreed Order setting out the conditions which will mitigate the penalty. The accompanying guidelines referenced in §505.D.2 of this Part shall also contain guidance for the state health officer when considering the amount of mitigation of the imposed penalty. When the amount of the penalty imposed is from \$1,000 up to \$5,000, the state health officer shall not mitigate the penalty below \$500. When the amount of the penalty imposed is less than \$1000, the state health officer shall not mitigate the penalty below one-half of the imposed penalty amount. The penalty shall become due and payable 35 days after mailing of notice setting forth the final disposition of the application for mitigation, unless:

1. an application for an adjudicatory hearing to contest the disposition is received within 20 days after the date of mailing the disposition notice; or
2. the state health officer specifies a different payment schedule within the disposition notice.

D. [formerly section 4.4 of paragraph IV of appendix A] Upon the timely receipt of a written application requesting an adjudicatory hearing, a hearing on the record relative to contesting the imposition of the penalty assessment may be scheduled by the agency. If after consideration of the record it is found that the issuance of the notice imposing the penalty assessment was not proper as supported by and in accordance with the evidence, the administrative law judge shall have the authority to recommend adjustment of the penalty to comply with any items found to be in error or, if justified, withdrawal of the entire penalty. The penalty shall become due and payable 35 days after mailing of notice of the final decision by the agency, unless the final decision by the agency specifies a different payment schedule within the final decision.

E. [formerly Section 4.5 of Paragraph IV of Appendix A] When a stipulation and agreed order has been proposed by the agency or the administrative law judge, a fixed number of days will be given for response. If the stipulation and agreed order is not signed and returned by the date fixed or if no response is received by the date fixed, this shall result in both the reimposition of the penalty originally imposed as well as the addition of daily penalties not previously counted from the time the order was first violated. Alternatively, failure of a public water system to comply with the conditions of a stipulation and agreed order shall result in both the reimposition of the penalty originally imposed as well as the addition of daily penalties not previously counted from the time the order was first violated.

AUTHORITY NOTE: Promulgated in accordance with R.S. 40:5.9 (A)(4).

HISTORICAL NOTE: Promulgated by the Department of Health and Hospitals, Office of Public Health, LR 28:1330 (June 2002).

§509. Court Appeals
[formerly section 5.1 of paragraph V of appendix A]

A. A person who is aggrieved by a final decision of the agency relative to penalty imposition may petition for judicial review according to the provisions of R.S. 49:964 of the Administrative Procedure Act. Proceedings for review may be instituted by filing a petition in the Nineteenth Judicial District Court, Parish of East Baton Rouge, within 30 days after mailing of notice of the final decision by the agency. Copies of the petition shall be served upon the agency and all parties of record.

AUTHORITY NOTE: Promulgated in accordance with R.S. 40:5.9 (A)(4).

HISTORICAL NOTE: Promulgated by the Department of Health and Hospitals, Office of Public Health, LR 28:1331 (June 2002).

Chapter 7. Accompanying Guidelines to the Civil Penalty Assessment Rule
[formerly Appendix B]

§701. Statement of Purpose
[formerly section 1.1 of paragraph I of appendix B]

A. The purpose of these "Accompanying Guidelines to the Civil Penalty Assessment Rule" (Chapter 7 of this Part) are as follows.

1. This rule is intended to provide guidance for Safe Drinking Water Program staff in making recommendations to the state health officer regarding the exact penalty assessment amounts for the seriousness of the violation(s) and the culpability of the owner and/or operator when it has been determined that a public water system has failed to comply with the directives of an administrative order.

2. Additionally, guidance relative to determining mitigated penalty amounts are also contained herein. Such mitigation guidance is applicable irrespective of the method used in the calculation of penalties, i.e., irrespective of

whether §505.B.1 or 2 of the "Civil Penalty Assessment Rule" (Chapter 5 of this Part) was used.

AUTHORITY NOTE: Promulgated in accordance with R.S. 40:5.9 (A)(4).

HISTORICAL NOTE: Promulgated by the Department of Health and Hospitals, Office of Public Health, LR 28:1331 (June 2002).

§703. Seriousness of Violation
[formerly section 2.1 of paragraph II of appendix B]

A. Pursuant to §505.B and D of the "Civil Penalty Assessment Rule" (Chapter 5 of this Part), the following penalty assessment levels shall apply towards the seriousness of the violation (public health risk) for the various classifications of violations described in §707.A of the "Accompanying Guidelines to the Civil Penalty Assessment Rule" (Chapter 7 of this Part).

1. Imminent threat (high risk) type violations shall be assessed at 100 percent of one-half of the maximum daily penalty amount.

2. Priority threat (moderate risk) type violations shall be assessed at 65 percent of one-half of the maximum daily penalty amount.

3. Non-imminent threat (low risk) type violations shall be assessed at 35 percent of one-half of the maximum daily penalty amount.

AUTHORITY NOTE: Promulgated in accordance with R.S. 40:5.9 (A)(4).

HISTORICAL NOTE: Promulgated by the Department of Health and Hospitals, Office of Public Health, LR 28:1331 (June 2002).

§705. Culpability of the Owner and/or Operator
[formerly section 3.1 of paragraph III of appendix B]

A. Pursuant to §505.B and D of the "Civil Penalty Assessment Rule" (Chapter 5 of this Part), the following penalty assessment levels shall apply towards the culpability (the level of blame for the occurrence and/or continuance of a violation including factors such as attitude as well as the nature and extent of the efforts to comply) of the owner and/or operator for the particular violation for which a seriousness penalty is assessed.

1. Culpability determined to be deliberate or intentional (a willful action or lack of action) shall be assessed at 100 percent of one-half of the maximum daily penalty amount.

2. Culpability determined to be recklessness (wanton disregard of the consequences but proceeded with risk in mind) shall be assessed at 65 percent of one-half of the maximum daily penalty amount.

3. Culpability determined to be negligence (failure to prevent the violation due to indifference, lack of reasonable care, lack of diligence, etc.) shall be assessed at 35 percent of one-half of the maximum daily penalty amount.

4. Culpability determined to be non-existent (those cases where the operator and/or owner has acted reasonably,

but the violation occurred anyway) shall be assessed at 0 percent of one-half of the maximum daily penalty amount, i.e., \$0.

AUTHORITY NOTE: Promulgated in accordance with R.S. 40:5.9 (A)(4).

HISTORICAL NOTE: Promulgated by the Department of Health and Hospitals, Office of Public Health, LR 28:1332 (June 2002).

§707. Classification of Violations
[formerly section 4.1 of paragraph IV of
appendix B]

A. The various types of violations which can occur are classified into three levels of seriousness based upon their public health risk. The three levels of seriousness are defined as follows.

1. *Imminent threat* type violations are defined as those violations considered to be of an acute risk to public health requiring an immediate action or response by the owner and/or operator of a public water system. Imminent threat type violations include, but are not limited to, the following:

- a. exceeding maximum contaminant levels for nitrate;
- b. exceeding the maximum contaminant level for total coliform when fecal coliform or *E. coli* is present in the water distribution system;
- c. occurrence of a water-borne disease outbreak in an unfiltered surface water system or an unfiltered ground water system which is under the direct influence of surface water;
- d. any violation specified by the state health officer as posing an acute risk to human health;
- e. failure to comply with any remedial action(s) ordered in the context of an emergency order issued by the state health officer, such as but not limited to boil notices;
- f. failure to give public notification of an acute violation (Tier 1—Acute) within the time frames allowed by law or duly adopted rule.

2. *Priority threat type violations* are defined as those violations considered to be of a moderate risk to public health but which could result in an acute risk and therefore require an immediate action or response by the owner and/or operator. Priority threat violations include, but are not limited to, the following:

- a. exceeding the maximum contaminant level for total coliform;
- b. failure to comply with a treatment technique requirement;
- c. failure to comply with a variance or exemption schedule;
- d. exceeding the maximum contaminant level for a physical, radiological, or chemical (other than nitrate) contaminant. For the purpose of clarification, a physical contaminant is defined as turbidity, temperature, conductivity, color, taste, or odor;

e. failure to perform compliance monitoring as required for any bacteriological, physical, radiological, or chemical contaminant;

f. failure to utilize either a laboratory certified by the Office of Public Health or an Office of Public Health laboratory which has been certified by EPA for compliance monitoring determination of any bacteriological, physical, radiological, or chemical contaminant in drinking water when such contaminant determination is required by law or duly adopted rule to be analyzed by an EPA or state-certified laboratory;

g. failure to perform proper testing procedures for turbidity, disinfectant residual, temperature, pH, conductivity, alkalinity, calcium, silica, orthophosphate, or any other parameter which is not required to be analyzed in an EPA or state-certified laboratory but the results of which are required to be reported to the state for compliance monitoring determinations;

h. failure to report the results of any test measurement or analysis to the state within the time frame allowed by law or duly adopted rule;

i. failure to comply with any remedial action(s) ordered in the context of a non-emergency order issued by the state health officer;

j. failure to give public notification of a non-acute (Tier 1—Non-Acute) violation within the time frames allowed by law or duly adopted rule.

3. *Non-imminent threat* violations are defined as those violations considered to be of a low risk to public health which do not require an immediate response by the owner and/or operator. These include operational deficiencies, facility deficiencies, and administrative deficiencies. Non-imminent threat type violations include, but are not limited to, the following:

- a. failure to give public notification of a monitoring violation, testing procedure violation, variance grant or existence, or exemption grant or existence (Tier 2) within the time frames allowed by law or duly adopted rule;
- b. failure to comply with an operational or maintenance requirement;
- c. failure to comply with design and construction standards as required by law or duly adopted rule;
- d. failure to submit plans and specifications as required by law or duly adopted rule;
- e. failure to comply with an operator certification requirement;
- f. failure to submit to the state, within the time frames allowed by law or duly adopted rule, a representative copy of each type of public notice distributed, published, posted, and/or made available to the persons served by the system and/or to the news media;
- g. failure to maintain records as prescribed by law or duly adopted rule, such as but not limited to, bacteriological and chemical analyses.

AUTHORITY NOTE: Promulgated in accordance with R.S. 40:5.9 (A)(4).

HISTORICAL NOTE: Promulgated by the Department of Health and Hospitals, Office of Public Health, LR 28:1332 (June 2002).

§709. Mitigation Guidance
[formerly section 5.1 of paragraph V of appendix B]

A. Section 507.C of the "Civil Penalty Assessment Rule" (Chapter 5 of this Part) allows the state health officer to mitigate penalties that have been imposed generally either upon proof that all of the provisions in the administrative compliance order have now been complied with or upon compliance with terms of a stipulation and agreed order. The following guidance will be used by the state health officer upon such mitigation proceedings.

1. When considering mitigation of the imposed penalty upon receipt of written application requesting such mitigation, the state health officer shall have the discretion to reduce the imposed penalty beginning at a reduction rate of 0 percent up to no more than 90 percent. The ordinarily expected mitigation reduction rate shall be 50 percent of the assessed penalty for the first 60 days of assessed penalty and an 80 percent reduction rate for penalties assessed beyond day 60. Using this procedure, if the end result of the calculated mitigated penalty amount is less than the minimum mitigation limits specified in §507.C of the "Civil Penalty Assessment Rule" (Chapter 5 of this Part), the minimum mitigation limits specified therein shall apply.

AUTHORITY NOTE: Promulgated in accordance with R.S. 40:5.9 (A)(4).

HISTORICAL NOTE: Promulgated by the Department of Health and Hospitals, Office of Public Health, LR 28:1333 (June 2002).

Chapter 9. Louisiana Total Coliform Rule
[formerly Appendix C]

§901. Federal Regulations Adopted by Reference
[formerly the preamble paragraph opening Appendix C]

A. The State of Louisiana, Louisiana Department of Health (LDH)-Office of Public Health (OPH) adopts the United States Environmental Protection Agency (USEPA) federal Total Coliform Regulations as published in the *Federal Register*, Volume 54, Number 124 Thursday, June 29, 1989. Pursuant to the definition of *national primary drinking water regulations* and the provisions of §377 of this Part, LDH-OPH adopts by reference the USEPA federal

Revisions to the Total Coliform Rule (RTCR) as published in the *Federal Register* dated February 13, 2013 (Volume 78, Number 30, pages 10346-10363). In addition, under §377 of this Part, LDH-OPH also adopts by reference certain USEPA minor corrections to the federal RTCR as published in the *Federal Register* dated February 26, 2014 (Volume 79, Number 38, pages 10668-10670). In order to clarify the state's discretionary decisions allowed by the federal requirements, the following is offered.

AUTHORITY NOTE: Promulgated in accordance with R. S. 40: 4 (A)(8) and 40:5.A. (3)(5)(6)(17)(20).

HISTORICAL NOTE: Promulgated by the Department of Health and Hospitals, Office of Public Health, LR 28:1333 (June 2002), amended by the Department of Health, Office of Public Health, LR 43:86 (January 2017).

§903. Coliform Routine Compliance Monitoring
[formerly Coliform Routine Compliance Monitoring of Appendix C]

A. Public water systems shall collect routine compliance samples for total coliforms at sites which are representative of water throughout the distribution system in accordance with a monitoring plan approved by the state health officer. Each public water system shall submit a monitoring plan in a format approved by the state health officer. The monitoring plan shall include a minimum number of point of collection (POC) monitoring sites calculated by multiplying 1.5 times the minimum number of samples required to be routinely collected in accordance with Subsection C of this Section, rounding any mixed (fractional) number product up to the next whole number. The monitoring plan shall include the POC monitoring sites for repeat samples required in §905. The monitoring plan shall include a map of the system with each POC sampling site identified along with a 911 street address, a latitude/longitude coordinate, and a brief description of the site location.

B. The water supply must provide suitable taps which draw water directly from the mains or the service lines. Such taps provide for samples which are most representative of the quality of water provided without "interference" which may be caused by plumbing problems within residences or other structures. Use of such taps decreases the chance of "bad samples" resulting in a coliform maximum contaminant level (MCL) violation which requires public notification by the public water supply and an administrative enforcement action by the EPA/DHH against the public water supply.

C. Community systems and non-community systems shall be routinely monitored in accordance with Table 1.

Population Served	Minimum Number of Routine Samples per Month	Population Served	Minimum Number of Routine Samples per Month
25 to 1,000	1	59,001 to 70,000	70
1,001 to 2,500	2	70,001 to 83,000	80
2,501 to 3,300	3	83,001 to 96,000	90
3,301 to 4,100	4	96,001 to 130,000	100
4,101 to 4,900	5	130,001 to 220,000	120
4,901 to 5,800	6	220,001 to 320,000	150
5,801 to 6,700	7	320,001 to 450,000	180
6,701 to 7,600	8	450,001 to 600,000	210
7,601 to 8,500	9	600,001 to 780,000	240

Title 51, Part XII

8,501 to 12,900	10	780,001 to 970,000	270
12,901 to 17,200	15	970,001 to 1,230,000	300
17,201 to 21,500	20	1,230,001 to 1,520,000	330
21,501 to 25,000	25	1,520,001 to 1,850,000	360
25,001 to 33,000	30	1,850,001 to 2,270,000	390
33,001 to 41,000	40	2,270,001 to 3,020,000	420
41,001 to 50,000	50	3,020,001 to 3,960,000	450
50,001 to 59,000	60	3,960,001 or more	480

D. Unless the state health officer specifies otherwise, the public water supply shall collect routine samples at regular time intervals throughout the month and shall alternate routine sampling between all of the approved POC sites. Routine samples shall not be collected from the same POC more than once per calendar month.

E. Special purpose samples (investigative samples) shall not be used to determine compliance with the *Escherichia coli* (*E. coli*) MCL.

AUTHORITY NOTE: Promulgated in accordance with R.S. 40:4(A)(8) and 40:5.A.(2)(3)(5)(6)(17)(20).

HISTORICAL NOTE: Promulgated by the Department of Health and Hospitals, Office of Public Health, LR 28:1333 (June 2002), amended LR 42:410 (March 2016), amended by the Department of Health, Office of Public Health, LR 43:86 (January 2017).

§905. Coliform Repeat Compliance Monitoring [formerly Coliform Repeat Monitoring of Appendix C]

A. If a routine sample is total coliform positive and the public water supply has their own certified laboratory, repeat samples shall be collected by the public water supply within 24 hours of being notified of the positive result. If the State collects and analyzes the samples, repeat samples shall be collected by the state within 24 hours of official notification. At least three repeat compliance samples shall be collected for each routine total coliform positive sample found.

B. For each routine total coliform positive sample, at least one repeat sample shall be collected from the sampling tap where the original total coliform positive sample was taken and at least one repeat sample shall be collected at a tap within five service connections upstream and at least one repeat sample shall be collected at a tap within five service connections downstream of the original sampling site.

C. The repeat samples shall be collected on the same day.

D. In a system with a single service connection, three 100 ml repeat samples shall be collected.

E. If total coliforms are detected in any repeat sample, the system shall collect another set of repeat samples from the same locations within 24 hours of being notified of the positive result. The system shall continue to collect additional sets of repeat samples until either total coliforms are not detected in one complete set of repeat samples or the system determines that a coliform treatment technique trigger under this Part has been exceeded as a result of a repeat sample being total coliform-positive and the State is notified.

AUTHORITY NOTE: Promulgated in accordance with R. S. 40: 4 (A)(8) and R.S. 40:5.A. (3)(5)(6)(17)(20).

HISTORICAL NOTE: Promulgated by the Department of Health and Hospitals, Office of Public Health, LR 28:1334 (June 2002), amended by the Department of Health, Office of Public Health, LR 43:87 (January 2017).

§907. Analytical and Reporting Requirements

A. Compliance samples for total coliform and *Escherichia coli* (*E. coli*) shall be analyzed by a certified microbiology laboratory/drinking water. The microbiology laboratory shall be certified by the state health officer for each method (and associated contaminant(s)) used for compliance monitoring analyses under this Part.

B. Compliance samples shall be analyzed to determine the presence or absence of total coliforms and *E. coli*; a determination of density is not required. If a routine or repeat sample result is positive for total coliform, the sample shall also be analyzed for *E. coli* immediately.

C. For compliance samples, laboratories shall use a State-approved laboratory report that contains the following information:

1. public water system (PWS) name and State-assigned PWS ID number;
2. sample identification number;
3. State-assigned point of collection (POC) site ID No. and POC address;
4. sample type (e.g., routine, repeat, source, replacement, investigative or other special purpose sample);
5. date and time of collection;
6. disinfectant residual (specify free or total and units of measurement);
7. name of sampler/collector;
8. date and time of sample receipt by the laboratory;
9. any deficiency in the condition of the sample;
10. date and time analysis begins;
11. analytical technique/method used;
12. results of analysis;
13. any remarks [quality control failures, etc.]; and
14. name and signature of the analyst performing the analysis.

D. Except for a positive sample(s) which is required under this Part to be reported sooner, compliance sample results shall be reported in a format approved by the state health officer by the tenth day of the following month after the end of the monitoring period.

AUTHORITY NOTE: Promulgated in accordance with R. S. 40: 4 (A)(8) and R.S. 40:5.A. (3)(5)(6)(17)(20)

HISTORICAL NOTE: Promulgated by the Department of Health and Hospitals, Office of Public Health, LR 28:1335 (June 2002), amended by the Department of Health, Office of Public Health, LR 43:87 (January 2017).

**§909. Invalidation of Total Coliform Results
[formerly Invalidation of Total Coliform Results
of Appendix C]**

A. Analysis results may be invalidated under specified conditions, including:

1. the OPH acknowledges improper analysis occurred or background bacteriological interference was present;
2. the OPH determines the contamination is from an internal plumbing problem, not the distribution system;
3. the OPH concludes, and states in writing, that the result is due to some condition not related to water quality. This written conclusion must be signed by an OPH representative and made available to the public and EPA.

AUTHORITY NOTE: Promulgated in accordance with R. S. 40: 4 (A)(8) and R.S. 40:5 (3)(5)(6)(17)(20).

HISTORICAL NOTE: Promulgated by the Department of Health and Hospitals, Office of Public Health, LR 28:1335 (June 2002).

**§911. Treatment Technique Triggers and Maximum
Contaminant Level
[formerly Total Coliform MCL of Appendix C]**

A. The following conditions are considered treatment technique triggers.

1. For systems collecting 40 or more distribution system samples per month, more than 5.0 percent of the monthly samples are total coliform positive.
2. For systems collecting less than 40 distribution system samples per month, two or more samples per month are total coliform positive.
3. Failure to collect every required repeat sample following a total coliform positive sample.
4. An *E.coli* maximum contaminant level (MCL) violation occurs as specified below:
 - a. a coliform-positive original sample that is also positive for *E. coli* is followed by a coliform-positive repeat sample;
 - b. a coliform-positive original sample followed by a coliform-positive repeat sample is also positive for *E. coli*;
 - c. failure to take all repeat samples following an *E. coli* positive routine sample; or
 - d. failure to test for *E. coli* on any repeat total coliform positive sample.

5. A second occurrence of conditions under Paragraph 1, 2 or 3 of this Subsection within a rolling 12-month period.

AUTHORITY NOTE: Promulgated in accordance with R. S. 40: 4 (A)(8) and R.S. 40:5.A. (3)(5)(6)(17)(20).

HISTORICAL NOTE: Promulgated by the Department of Health and Hospitals, Office of Public Health, LR 28:1335 (June

2002), amended by the Department of Health, Office of Public Health, LR 43:88 (January 2017).

§912. Assessment Requirements

A. Assessments shall be conducted in accordance with the requirements of the National Primary Drinking Water Regulations as amended by this Chapter after exceeding any of the treatment technique triggers described in §911 of this Part.

1. A Level 1 assessment shall be conducted if the system exceeds one of the treatment technique triggers described in Paragraph 1, 2, or 3 of §911.A.

a. A Level 1 assessment shall be conducted by an operator or operators holding a current license issued by the state health officer for water production, water treatment and water distribution in the class level (or higher) required for the population served by the system in accordance with the requirements of LAC 48:V.Chapter 73.

2. A Level 2 assessment shall be conducted if the system exceeds one of the treatment technique triggers described in Paragraph 4 or 5 of §911.A.

AUTHORITY NOTE: Promulgated in accordance with R.S. 40:4(A)(8) and R.S. 40:5.A.(2)(3)(5)(6)(17)(20).

HISTORICAL NOTE: Promulgated by the Department of Health, Office of Public Health, LR 43:88 (January 2017).

**§913. Public Notification
[formerly Public Notification of Appendix C]**

A. Public notification (PN) shall be provided in accord with the requirements of the National Primary Drinking Water Regulations, as amended under Chapter 19 of this Part. In accordance with the NPDWRs, public water systems shall provide a Tier 1 PN for an *E. coli* MCL violation, a Tier 2 PN for a treatment technique requirement violation for failure to conduct assessments or corrective actions, and a Tier 3 PN for a monitoring violation or a reporting violation.

1. If a replacement sample cannot be analyzed and give a readable result, the public water supply will be assessed a monitoring violation and must give appropriate public notification.

AUTHORITY NOTE: Promulgated in accordance with R. S. 40: 4 (A)(8) and R.S. 40:5.A. (3)(5)(6)(17)(20).

HISTORICAL NOTE: Promulgated by the Department of Health and Hospitals, Office of Public Health, LR 28:1335 (June 2002), amended LR 35:484 (March 2009), amended by the Department of Health, Office of Public Health, LR 43:88 (January 2017).

Chapter 11. Surface Water Treatment Rule

Subchapter A. General Requirements and Definitions

§1101. General Requirements

A. Although this Chapter is titled the “Surface Water Treatment Rule” (SWTR), it is comprised of the adoption of all the following individual rules:

1. the Louisiana Surface Water Treatment Rule (LSWTR) adopted on March 20, 1991 (see LR 17:271);

2. the May 20, 2000 rule (see LR 26:1036) that repealed obsolete turbidity monitoring rules (these obsolete rules pre-dated the newer turbidity monitoring rules contained in the LSWTR);

3. the Louisiana Interim Enhanced Surface Water Treatment Rule (LIESWTR) adopted on December 20, 2002 (LR 28:2513);

4. the Louisiana Long Term 1 Enhanced Surface Water Treatment Rule (LLT1ESWTR) adopted on July 20, 2009 (LR 35:1239); and

5. the Long Term 2 Enhanced Surface Water Treatment Rule (LT2ESWTR) adopted by reference on September 20, 2012.

a. Pursuant to the definition of *national primary drinking water regulations* (as defined in this Part) and the provisions of §377 of this Part, the Department of Health and Hospitals (DHH) Office of Public Health (OPH) adopts by reference the United States Environmental Protection Agency (USEPA) federal Long Term 2 Enhanced Surface Water Treatment Rule (LT2ESWTR) as published in the *Federal Register* dated January 5, 2006 (Volume 71, Number 3, pages 653-786). In addition, under §377 of this Part, DHH-OPH also adopted by reference certain USEPA technical corrections to the federal LT2ESWTR. The applicable technical corrections were published in the *Federal Register* dated January 30, 2006 (Volume 71, Number 19, page 4968) and in the *Federal Register* dated February 6, 2006 (Volume 71, Number 24, page 6136).

B. For public water systems using surface water or groundwater under the direct influence of surface water (GWUDISW), this Chapter establishes or extends treatment technique requirements in lieu of maximum contaminant levels for the following microbial contaminants: *Giardia lamblia* (cysts), viruses, heterotrophic plate count bacteria, *Legionella*, turbidity, and *Cryptosporidium* oocysts.

C. Each supplier using an approved surface water as its source of water supply shall provide multibarrier treatment necessary to reliably protect users from the adverse health effects of microbiological contaminants and to comply with the requirements and performance standards prescribed in this Chapter.

D. Unless the Department of Health and Hospitals, hereinafter referred to as DHH, determines that a shorter time limit is necessary due to an emergency situation or the finding of a significant deficiency, a supplier shall, within 90 days from the date of notification by DHH that a treatment plant using surface water or GWUDISW as its source of water supply does not meet the requirements of this Chapter, submit for DHH approval a plan and schedule to bring its system into compliance.

E. If the supplier disagrees with the DHH's notification issued pursuant to §1101.D of this Part, then the supplier shall submit in writing reasons and evidence for its disagreement as soon as possible but not later than 30 days from the receipt of the notification unless an extension of time to meet this requirement is requested and granted by the DHH. In cases when DHH's notification involves an emergency situation or the finding of a significant

deficiency, the supplier shall submit in writing reasons and evidence for its disagreement as soon as possible but not later than 14 days from the receipt of such notification.

AUTHORITY NOTE: Promulgated in accordance with R.S. 40:4 (A)(8) and R.S. 40:5 (2)(3)(5)(6)(17)(20).

HISTORICAL NOTE: Promulgated by the Department of Health and Hospitals, Office of Public Health, LR 28:1335 (June 2002), amended LR 28:2514 (December 2002), LR 35:1241 (July 2009), LR 38:2376 (September 2012).

§1102. Relationship with this Part

A. In those instances where the requirements of this Chapter are stricter than or conflict with the requirements of this Part generally, a public water system utilizing surface water or ground water under the direct influence of surface water (GWUDISW) shall comply with the requirements of this Chapter.

AUTHORITY NOTE: Promulgated in accordance with R.S. 40:4(A)(8)(13) and R.S. 40:5(2)(3)(5)(6)(17)(20).

HISTORICAL NOTE: Promulgated by the Department of Health and Hospitals, Office of Public Health, LR 42:411 (March 2016).

§1103. Definition of Terms

A. Words Not Defined. Words not defined in this Chapter shall have the meanings stated in §101 of this Part or other Parts of the Louisiana state sanitary code. When words not defined in this Chapter are defined in both §101 of this Part and in another Part of the Louisiana state sanitary code, the definition contained within §101 of this Part shall be given preference as it pertains to water supplies. Words not defined in any of these source documents shall have the meanings stated in the Merriam-Webster's Collegiate Dictionary-Tenth Edition, as revised.

B. Definitions. Definitions contained in §101 of this Part shall also apply to this Chapter where the following special definitions apply.

Approved Surface Water—a surface water or GWUDISW that has received permit approval from the DHH as a source of water supply for a public water system.

Best Available Technology—for the purpose of this Chapter in relation to the treatment of surface water, means conventional filtration treatment which conforms with all of the requirements of this Chapter.

Calibration_{dra}—to standardize [adjust the instrument response to a National Institute of Standards and Technology (NIST) traceable standard] a disinfectant residual analyzer (such as, but not limited to, a bench top or a continuous monitoring disinfectant residual analyzer using colorimetry or spectrophotometry) by determining the deviation from a NIST traceable standard so as to ascertain and implement the proper correction factors in an attempt to obtain accurate and reliable sample results.

Calibration_{pH}—to standardize (adjust the instrument response to a pH primary standard) a pH meter (such as a bench top or continuous monitoring pH meter) by determining the deviation from a pH primary standard so as to ascertain and implement the proper correction factors in an attempt to obtain accurate and reliable results.

Calibration_r—to standardize (adjust the instrument response to a turbidity primary standard) a turbidimeter (such as a bench top or continuous monitoring turbidimeter) by determining the deviation from a turbidity primary standard so as to ascertain and implement the proper correction factors in an attempt to obtain accurate and reliable sample results.

Calibration_{temp}—to standardize [adjust the instrument response to a NIST traceable standard] a temperature measuring device (such as a thermometer or thermocouple) by determining the deviation from a NIST traceable standard so as to ascertain and implement the proper correction factors in an attempt to obtain accurate and reliable sample results.

Certified Operator—for the purpose of this Chapter, the individual, as examined by the committee of certification and as approved by the state health officer, meeting all requirements of state law and regulation and found competent to operate a treatment plant for a public water system which utilizes surface water or GWUDISW as its source of water supply.

Coagulation—a process using coagulant chemicals and rapid mixing by which colloidal and suspended material are destabilized and agglomerated into settleable and/or filterable flocs.

Comprehensive Performance Evaluation (CPE)—a thorough review and analysis of a treatment plant's performance-based capabilities and associated administrative, operation, and maintenance practices. It is conducted to identify factors that may be adversely impacting a plant's capability to achieve compliance and emphasizes approaches that can be implemented without significant capital improvements. It consists of at least the following components: assessment of plant performance; evaluation of major unit processes; identification and prioritization of performance limiting factors; assessment of the applicability of comprehensive technical assistance; and, preparation of a CPE report.

Conventional Filtration Treatment—a series of treatment processes which includes coagulation, flocculation, sedimentation, and filtration resulting in substantial particulate removal.

Deep Bed Filtration—a process for removing particulate matter from water by passage through porous media exceeding 42 inches in total depth. Underdrain gravels are not to be included.

Diatomaceous Earth Filtration—a process resulting in particulate removal in which a precoat cake of graded diatomaceous earth filter media is deposited on a support membrane (septum) and, while the water is being filtered by passing through the cake on the septum, additional filter media known as body feed is continuously added to the feed water to maintain the permeability of the filter cake.

Direct Filtration Treatment—a series of processes including coagulation, flocculation, and filtration but excluding sedimentation.

Disinfectant Contact Time ("T" in CT calculations)—the time in minutes that it takes for water to move from the point of disinfectant application or a previous point of disinfectant residual measurement to a point before or at the point where residual disinfectant concentration is measured. The point of measurement shall be before or at the first customer. Disinfectant contact time in pipelines is calculated by dividing the internal volume of the pipe by the flow rate through the pipe. Disinfectant contact time with mixing basins and storage reservoirs is determined by tracer studies or an equivalent demonstration to the DHH.

Disinfection—a process which inactivates pathogenic organisms in water by chemical oxidants or equivalent agents.

Disinfection Profile—a summary of *Giardia lamblia* inactivation through the treatment plant. For any system that uses chloramines, ozone, or chlorine dioxide for primary disinfection, this term shall additionally include a summary of virus inactivation through the treatment plant.

Engineering Report—a water treatment technical report prepared by a qualified engineer.

Filter Profile—a graphical representation of individual filter performance, based on continuous turbidity measurements versus time for an entire filter run, from startup to backwash inclusively, that includes an assessment of filter performance while another filter is being backwashed.

Filtration—a process for removing particulate matter from water by passage through porous media.

Flocculation—a process to enhance agglomeration or collection of smaller floc particles into larger, more easily settleable or filterable particles through gentle stirring by hydraulic or mechanical means.

Groundwater under the Direct Influence of Surface Water (GWUDISW)—any water beneath the surface of the ground with significant occurrence of insects or other macroorganisms, algae, or large diameter pathogens such as *Giardia lamblia* or *Cryptosporidium*, or significant and relatively rapid shifts in site specific water characteristics such as turbidity, temperature, conductivity or pH which closely correlate to climatological or surface water conditions. The DHH determination of direct influence may be based on an evaluation of site-specific measurements of water quality and/or documentation of well construction characteristics and geology with field evaluation.

Heterotrophic Plate Count (HPC)—laboratory analytical procedure for estimating the number of live heterotrophic bacteria in water using instrumentation and methods as described in *Standard Methods for the Examination of Water and Wastewater*, 19th Edition. Results of such analysis is reported as "colony-forming units per milliliter" (cfu/ml).

IESWTR—Interim Enhanced Surface Water Treatment Rule.

Legionella—a genus of bacteria, some species of which have caused a type of pneumonia called Legionnaires disease.

Liquids from Dewatering Processes—a stream containing liquids generated from a unit used to concentrate solids for disposal.

LT1ESWTR—Long Term 1 Enhanced Surface Water Treatment Rule.

LT2ESWTR—Long Term 2 Enhanced Surface Water Treatment Rule.

Multibarrier Treatment—a series of water treatment processes that provide for both removal and inactivation of waterborne pathogens.

Nephelometric Turbidity Unit (NTU)—a measurement of the turbidity of water as determined by the comparison of the intensity of light scattered by the sample to the intensity of incident light, using instrumentation and methods described in §1105.B of this Chapter.

Peak Hourly Flow—the maximum flow through a particular disinfection segment over a one hour period during 24 hourly periods in a calendar day.

Pressure Filter—a pressurized vessel containing properly sized and graded granular media.

Primary Standard (Turbidity)—turbidity primary standard.

Qualified Engineer—any engineer who has been registered under the provisions of R.S. 37:681 et seq., and who holds a current certificate issued by the Louisiana Professional Engineering and Land Surveying Board, and who has knowledge and experience in water treatment plant design, construction, operation, and watershed evaluations.

Residual Disinfectant Concentration ("C" in CT calculations)—the concentration of the disinfectant in milligrams per liter (mg/l) in a representative sample of water.

Sedimentation—a process for removal of settleable solids before filtration by gravity or separation.

Slow Sand Filtration—a process involving passage of raw water through a bed of sand at low velocity (less than 0.10 gallons per minute per square foot) resulting in substantial particulate removal by physical and biological mechanisms.

Spent Filter Backwash Water—a stream containing particles that are dislodged from filter media when water is forced back through the filter (backwashed) to clean the filter.

Supplier—for the purpose of this Chapter, means the owner or operator of a public water system.

Surface Water—all water open to the atmosphere and subject to surface runoff.

SWTR—Surface Water Treatment Rule.

SWTR Guidance Manual—U.S. EPA's Guidance Manual for Compliance with the Filtration and Disinfection Requirements for Public Water Systems using Surface Water Sources, March 1991 Edition.

Thickener Supernatant—a stream containing the decant from a sedimentation basin, clarifier or other unit that is used to treat water, solids, or semi-solids from the primary treatment processes.

Turbidity—a measure of the decline of the clarity of water caused by suspended and colloidal matter, such as clay, silt, finely divided organic and inorganic matter, plankton, and other microscopic organisms. It is formally expressed as the optical property that causes light to be scattered and absorbed, rather than transmitted with no change in direction through the sample.

Turbidity Level—the value in NTU obtained by measuring the turbidity of a representative grab sample of water at a specified regular interval of time. If continuous turbidity monitoring is utilized, the turbidity level is the discrete turbidity value at any given time.

Turbidity Primary Standard—a suspension used to calibrate a turbidimeter, such as user-prepared formazin, commercial stock formazin suspensions, or commercial styrene-divinylbenzene suspensions. Such suspensions shall be prepared and used in conformity with the laboratory methods described in §1105.B of this Chapter.

Validation—to determine the degree of deviation of a measuring instrument (such as a bench top or continuous monitoring turbidimeter) from a primary standard by employing less sophisticated or involved means typically employed during a calibration, such as use of a state-approved secondary standard.

Virus—any of a large group of submicroscopic agents (that consist of a RNA or DNA core of genetic material surrounded by a protein coat but no semipermeable membrane) that are capable of growth and multiplication only in living cells and that are infectious to humans by waterborne transmission and that cause various important diseases in humans, including, but not limited to, poliomyelitis, aseptic meningitis, infectious hepatitis, gastroenteritis, etc.

AUTHORITY NOTE: Promulgated in accordance with R.S. 40:4(A)(8), R.S. 40:5(2)(3)(5)(6)(17)(20), and R.S. 40:1148.

HISTORICAL NOTE: Promulgated by the Department of Health and Hospitals, Office of Public Health, LR 28:1336 (June 2002), amended LR 28:2514 (December 2002), LR 30:1195 (June 2004), LR 35:1241 (July 2009), LR 38:2377 (September 2012).

§1105. Analytical Requirements

A. Analysis for total coliform, fecal coliform, or HPC which may be required under this Chapter shall be conducted by a laboratory certified by DHH to do such analysis. Until laboratory certification criteria are developed, laboratories certified for total coliform analysis by DHH are deemed certified for fecal coliform and HPC analysis.

B. Public water systems shall conduct analysis for turbidity in accordance with:

1. SM 2130 B [(Nephelometric Method), *Standard Methods for the Examination of Water and Wastewater*, 19th edition, American Public Health Association (APHA), 800 I Street N.W., Washington, D.C. 20001-3710. Telephone (202)777-2742. Also available from the American Water

PUBLIC HEALTH—SANITARY CODE

Works Association (AWWA) and the Water Environment Federation (WEF)];

2. EPA Method 180.1 [(Nephelometric Method), "Methods for the Determination of Inorganic Substances in Environmental Samples," EPA-600-R-93-100, August 1993. Available from the National Technical Information Service, NTIS PB94-121811. Telephone (800) 553-6847]; or

3. GLI Method 2 [(Great Lakes Instrument Method 2), "Turbidity," November 2, 1982, GLI International, Inc., 9020 West Dean Road, Milwaukee, Wisconsin 53224. Telephone (414) 355-3601].

C. Public water systems shall conduct analysis for applicable residual disinfectant concentrations in accordance with one of the analytical methods in Table 1

Table 1				
Residual	Methodology	Standard Methods ¹	ASTM Methods ²	Other Methods
Free Chlorine	Amperometric Titration	4500-CI D, 4500-CI D-00	D 1253-03	
	DPD Ferrous Titrimetric	4500-CI F, 4500-CI F-00		
	DPD Colorimetric	4500-CI G, 4500-CI G-00		
	Syringaldazine (FACTS)	4500-CI H, 4500-CI H-00		
	On-line Chlorine Analyzer			EPA 334.0 ³
	Amperometric Sensor			ChloroSense ⁴
Total Chlorine	Amperometric Titration	4500-CI D, 4500-CI D-00	D 1253-03	
	Amperometric Titration (low level measurement)	4500-CI E, 4500-CI E-00		
	DPD Ferrous Titrimetric	4500-CI F, 4500-CI F-00		
	DPD Colorimetric	4500-CI G, 4500-CI G-00		
	Iodometric Electrode	4500-CI I, 4500-CI I-00		
	On-line Chlorine Analyzer			EPA 334.0 ³
	Amperometric Sensor			ChloroSense ⁴
Chlorine Dioxide	Amperometric Titration	4500-CIO ₂ C		
	DPD Method	4500-CIO ₂ D		
	Amperometric Titration II	4500-CIO ₂ E, 4500-CIO ₂ E-00		
	Lissamine Green Spectrophotometric			EPA 327.0 Rev 1.1 ⁵
Ozone	Indigo Method	4500-O ₃ B, 4500-O ₃ B-97		

1. All the listed methods are contained in the 18th, 19th, 20th, 21st, and 22nd Editions of *Standard Methods for the Examination of Water and Wastewater*; the cited methods published in any of these editions may be used.

2. Annual Book of ASTM Standards, Vol. 11.01, 2004; ASTM International; any year containing the cited version of the method may be used. Copies of this method may be obtained from ASTM International, 100 Barr Harbor Drive, P.O. Box C700 West Conshohocken, PA 19428-2959.

3. EPA Method 334.0. "Determination of Residual Chlorine in Drinking Water Using an On-line Chlorine Analyzer," August 2009. EPA 815-B-09-013. Available at http://epa.gov/safewater/methods/analyticalmethods_ogwd_w.html.

4. ChloroSense. "Measurement of Free and Total Chlorine in Drinking Water by Palintest ChloroSense," September 2009. Available at <http://www.nemi.gov> or from Palintest Ltd, 21 Kenton Lands Road, PO Box 18395, Erlanger, KY 41018.

5. EPA Method 327.0, Revision 1.1, "Determination of Chlorine Dioxide and Chlorite Ion in Drinking Water Using Lissamine Green B and Horseradish Peroxidase with Detection by Visible Spectrophotometry," USEPA, May 2005, EPA 815-R-05-008. Available online at <http://www.epa.gov/safewater/methods/sourcalt.html>.

D. Public water systems shall conduct analysis for pH using one of the following electrometric methods:

1. SM 4500-H⁺ B (Standard Methods for the Examination of Water and Wastewater, 19th Edition);

2. EPA Method 150.1 ("Methods for Chemical Analysis of Water and Wastes," EPA/600/4-79/020, March 1983. Available from the NTIS, PB84-128677);

3. EPA Method 150.2 ("Methods for Chemical Analysis of Water and Wastes," EPA/600/4-79/020, March 1983. Available from the NTIS, PB84-128677); or

4. ASTM Method D1293-95 [*Annual Book of ASTM Standards*, 1996, Vol. 11.01, American Society for Testing and Materials, 100 Barr Harbor Drive, West Conshohocken, Pennsylvania 19428-2959. Telephone (610) 832-9585. Note: Previous version (ASTM Method D1293-84) is also approved and is located in the *Annual Book of ASTM Standards*, 1994, Vols. 11.01].

E. Public water systems shall conduct analysis for temperature using the following thermometric method:

1. SM 2550 B (Standard Methods for the Examination of Water and Wastewater, 19th Edition).

AUTHORITY NOTE: Promulgated in accordance with R.S. 40:4(A)(8)(13) and 40:5(5)(6)(17)(20).

HISTORICAL NOTE: Promulgated by the Department of Health and Hospitals, Office of Public Health, LR 28:1337 (June 2002), amended LR 28:2516 (December 2002), LR 42:411 (March 2016).

§1107. Calibration/Validation of Turbidimeters

A. General. Calibration_t using a turbidity primary standard shall be done in accord with approved methods listed in §1105.B.

B. Calibration_t of Turbidimeters. Bench top and continuous monitoring turbidimeters shall be calibrated using a turbidity primary standard at a frequency of no less than once every 90 days. The instruments shall be calibrated in accord with the manufacturer's instructions.

C. Validation of Bench Top Turbidimeters. Calibration_t of the bench top turbidimeters shall be validated with state-approved secondary standards each time a sample or set of samples is tested. For turbidity measurements less than

0.2 NTU and the turbidimeter reading is ± 20 percent or more deviation of the state-approved secondary standard, the bench top turbidimeter shall be recalibrated with a turbidity primary standard. For turbidity measurements greater than or equal to 0.2 NTU and the turbidimeter reading is ± 10 percent or more deviation of the state-approved secondary standard, the bench top turbidimeter shall be recalibrated with a turbidity primary standard.

D. Validation of Continuous Monitoring Turbidimeters. Calibration_t of the continuous monitoring turbidimeters shall be validated at least once each week by either using a state-approved secondary standard or determining the turbidity of the water flowing out of the continuous monitoring turbidimeter using a bench top turbidimeter. Follow-up actions based upon the validation method selected are as follows.

1. Validation by Use of a State-Approved Secondary Standard

a. If the state-approved secondary standard is less than 0.2 NTU and the continuous monitoring turbidimeter reading is ± 20 percent or more deviation of the state-approved secondary standard, the continuous monitoring turbidimeter shall be recalibrated with a turbidity primary standard. If the state-approved secondary standard is greater than or equal to 0.2 NTU and the continuous monitoring turbidimeter reading is ± 10 percent or more deviation of the state-approved secondary standard, the continuous monitoring turbidimeter shall be recalibrated with a turbidity primary standard.

2. Validation by Determining the Turbidity of the Water Flowing out of the Continuous Monitoring Turbidimeter Using a Bench Top Turbidimeter

a. For turbidity measurements less than 0.2 NTU and the continuous monitoring turbidimeter reading is ± 20 percent or more deviation from the bench top turbidimeter reading, the continuous monitoring turbidimeter shall be recalibrated with a turbidity primary standard. For turbidity measurements greater than or equal to 0.2 NTU and the continuous monitoring turbidimeter reading is ± 10 percent or more deviation from the bench top turbidimeter reading, the continuous monitoring turbidimeter shall be recalibrated with a turbidity primary standard.

E. Re-Standardization of Secondary Standards. Each time a turbidimeter has been calibrated with a turbidity primary standard, the secondary standards shall be re-standardized. When a secondary standard has been assigned an expiration date by the manufacturer, nothing herein shall be construed as to allow the re-standardization of such secondary standard beyond the expiration date set by the manufacturer.

F. Records of Calibrations/Validations. Records of calibrations/validations on each bench top and continuous monitoring turbidimeter shall be maintained for at least three years, as follows.

1. Records of bench top turbidimeters shall include meter location, meter identification, dates of calibration_t, and the name of the person performing the calibration_t.

2. Records of continuous monitoring turbidimeters shall include meter location (e.g., filter number), unique meter identification (e.g., model and serial number), dates of calibration_t, dates of validation, and the name of the person performing the calibration_t.

G. Records of Re-Standardization of Secondary Standards. Records of any re-standardization of secondary standards shall be maintained for at least three years, as follows.

1. Records of re-standardizations done using bench top turbidimeters shall include the value assigned to the secondary standard, date of assignment, meter identification (e.g., model and serial number) which was used to assign the secondary standard its unique value for such meter, manufacturer's expiration date, and the name of the person performing the re-standardization.

2. Records of re-standardizations done using continuous monitoring turbidimeters shall include the value assigned to the secondary standard, date of assignment, meter location (e.g., filter number), meter identification (e.g., model and serial number) which was used to assign the secondary standard its unique value for such meter, manufacturer's expiration date, and the name of the person performing the re-standardization.

AUTHORITY NOTE: Promulgated in accordance with R.S. 40:4(A)(8) and 40:5 (5)(6)(17)(20).

HISTORICAL NOTE: Promulgated by the Department of Health and Hospitals, Office of Public Health, LR 28:1337 (June 2002), amended LR 28:2517 (December 2002).

§1109. Calibration_{dra}/Validation of Disinfectant Residual Analyzers

A. Validation of Bench Top Disinfectant Residual Spectrophotometers/Colorimeters. The accuracy of bench top spectrophotometers/colorimeters used for disinfectant residual monitoring, particularly for validation of continuous disinfectant residual monitors, shall be determined at a frequency of no less than once every 90 days by use of a NIST traceable standard solution which has been obtained from an approved source (e.g., certificate of analysis by manufacturer). Deviations of ± 10 percent or more shall be cause for calibration_{dra} of the equipment. The instruments shall be calibrated in accord with the manufacturer's instructions. After calibration_{dra} the instrument's accuracy shall be validated prior to return to service.

B. Validation/Standardization Using Other Methods. For approved methods for disinfectant residual analysis other than spectrophotometric/colorimetric methods, validation/standardization of disinfectant residual analyzers shall be performed in accord with procedures outlined in the particular method [see §1105.C].

C. Validation of Continuous Disinfectant Residual Monitors. The accuracy of residual disinfectant measurements from any continuous disinfectant residual

monitor shall be validated weekly. Validation shall be performed by collecting a grab sample from the tubing supplying water to the monitor (e.g., via a tee connection which is normally capped or valved closed) at a location immediately upstream (less than 5 feet) of the continuous disinfectant residual monitor. Such grab sample shall be analyzed using a bench top spectrophotometer/colorimeter which has been calibrated according to §1109.A of this Chapter. If the spectrophotometer/colorimeter reading indicates ± 10 percent or more deviation as compared to the continuous disinfectant residual monitor reading, the cause of the disparity shall be investigated and resolved within five working days. In the meantime, grab samples shall be collected and analyzed every two hours as per §1125.B of this Chapter. The accuracy of residual disinfectant measurements from any replacement instrument shall be validated prior to service or return to service.

D. Records of Calibrations/Validations. Records of calibrations/validations on each bench top spectrophotometer/colorimeter used for disinfectant residual monitoring and on each continuous disinfectant residual monitor shall be maintained for at least three years, as follows.

1. Records of bench top spectrophotometers/colorimeters shall include meter location, meter identification, dates and results of NIST traceable standard solution, dates of calibration_{dra}/validation and the name of the person performing the calibration_{dra}/validation.

2. Records of continuous disinfectant residual monitors shall include meter location, unique meter identification (e.g., model and serial number), dates and results of calibration/validation, and the corrective actions taken when deviations of ± 10 percent or more occur.

AUTHORITY NOTE: Promulgated in accordance with R.S. 40:4(A)(8) and 40:5(5)(6)(17)(20).

HISTORICAL NOTE: Promulgated by the Department of Health and Hospitals, Office of Public Health, LR 28:1338 (June 2002), amended LR 28:2518 (December 2002).

§1110. Calibration_{pH}/Validation of pH Meters

A. pH of water within the water treatment plant shall be conducted using a pH meter having a minimum accuracy of ± 0.2 pH units.

B. Benchtop pH meters used for determining the pH of water within the water treatment plant shall be calibrated at least once each day in accordance with Section 4.a. of SM 4500-H⁺ B (Electrometric pH Method) of the *Standard Methods for the Examination of Water and Wastewater*, 19th Edition, or the manufacturer's specifications.

C. The calibration_{pH} of benchtop pH meters shall be validated with at least one buffer solution each time a series of samples is run and, if necessary, recalibrated in accord with the requirements of Subsection B of this Section.

D. On-line pH meters shall be calibrated_{pH} according to the manufacturer's specifications at a frequency such that the deviation observed between calibrations is typically less than ± 0.2 pH units. The deviation is to be recorded at each

calibration by recording the current process pH both before and after calibration. In no case shall calibrations of on-line pH meters be performed at a frequency of less than once each week.

E. Records of calibrations on each pH meter shall be maintained for at least three years.

AUTHORITY NOTE: Promulgated in accordance with R.S. 40:4(A)(8) and 40:5(5)(6)(17)(20).

HISTORICAL NOTE: Promulgated by the Department of Health and Hospitals, Office of Public Health, LR 30:1195 (June 2004).

§1111. Calibration_{temp}/Validation of Temperature Measuring Devices

A. Water temperature within the water treatment plant shall be measured using a thermometer, thermocouple, or other temperature measuring device having a minimum accuracy of ± 0.5 degrees Celsius (0.5°C).

B. Service thermometers, thermocouples, and other temperature measuring devices used for determining water temperature within the water treatment plant shall be validated at a frequency of once per month using a field thermometer that has been calibrated annually against a NIST certified thermometer. The NIST certified thermometer shall be sent back to the manufacturer for recalibration at least once every three years.

C. Records of validations/calibrations on each temperature measuring device shall be maintained for at least three years.

AUTHORITY NOTE: Promulgated in accordance with R.S. 40:4(A)(8) and 40:5(5)(6)(17)(20).

HISTORICAL NOTE: Promulgated by the Department of Health and Hospitals, Office of Public Health, LR 28:1340 (June 2002, amended LR 28:2518 (December 2002), LR 30:1195 (June 2004).

§1112. Cleaning of Analytical Instrumentation

A. A thorough cleaning of analytical instrumentation (particularly continuous monitoring turbidimeters, disinfectant residual monitors, and pH meters) shall be performed, as necessary, prior to performing any calibration/validation. On a weekly basis, continuous monitoring turbidimeters and continuous disinfectant residual monitors shall be inspected to determine if there is any material or sedimentation in the measuring chambers. Records of such inspection/cleaning shall be kept for at least three years and such records shall include meter location (e.g., model and serial number), dates of cleaning, and the name of the person performing the cleaning.

AUTHORITY NOTE: Promulgated in accordance with R.S. 40:4(A)(8) and 40:5(5)(6)(17)(20).

HISTORICAL NOTE: Promulgated by the Department of Health and Hospitals, Office of Public Health, LR 30:1196 (June 2004).

Subchapter B. Treatment Technique Requirements and Performance Standards

§1113. Treatment Technique Requirements

A. Each supplier using surface water or GWUDISW shall provide multibarrier treatment that meets the requirements of this Chapter and reliably ensures at least:

1. a total of 99.9 percent (3 Log) reduction of *Giardia* cysts through treatment processes including filtration and disinfection;
2. a total of 99.99 percent (4 Log) reduction of viruses through treatment processes including filtration and disinfection;
3. a total of 99 percent (2 Log) removal of *Cryptosporidium* oocysts through treatment processes including filtration;
4. the total reductions to be required by the DHH may be higher and are subject to the source water concentration of *Giardia lamblia*, viruses, and *Cryptosporidium*;
5. the residual disinfectant concentration in the water delivered to the distribution system is not less than 0.5 mg/l free chlorine or 0.5 mg/l total chlorine for more than 4 hours in any 24 hour period; and
6. the residual disinfectant concentration is not less than 0.5 mg/l free chlorine or 0.5 mg/l total chlorine in more than 5.0 percent of the samples collected each month from the distribution system for any two consecutive months.

B. Suppliers meeting the requirements of §§1115 and 1119 shall be deemed to be in compliance with the minimum reduction and removal requirements specified in §1113.A of this Chapter.

C. Section 1117 of this Chapter presents requirements for non-filtering systems. All suppliers which use surface water as a source shall provide filtration. On a case by case basis, systems using GWUDISW may not be required to filter.

AUTHORITY NOTE: Promulgated in accordance with R.S. 40:4(A)(8) and R.S. 40:5(2)(3)(5)(6)(17)(20).

HISTORICAL NOTE: Promulgated by the Department of Health and Hospitals, Office of Public Health, LR 28:1340 (June 2002), amended LR 28:2518 (December 2002), LR 35:1241 (July 2009), LR 42:411 (March 2016).

§1115. Filtration Performance Standards

A. All surface water or GWUDISW utilized by a supplier shall be treated using one of the following filtration technologies unless an alternative process has been approved by the DHH.

1. Conventional Filtration Treatment
2. Direct Filtration Treatment
3. Slow Sand Filtration
4. Diatomaceous Earth Filtration

B. Conventional filtration treatment shall be deemed to be capable of achieving at least 99.7 percent (2.5 Log) removal of *Giardia* cysts, 99 percent (2 Log) removal of *Cryptosporidium* oocysts, and 99 percent (2 Log) removal of viruses when in compliance with operation criteria (Subchapter D of this Chapter) and performance standards (§§1115 and 1119 of this Subchapter). Direct filtration treatment and diatomaceous earth filtration shall be deemed to be capable of achieving at least 99 percent (2 Log) removal of *Giardia* cysts, 99 percent (2 Log) removal of *Cryptosporidium* oocysts, and 90 percent (1 Log) removal of viruses when in compliance with operation criteria (Subchapter D of this Chapter) and performance standards (§§1115 and 1119 of this Subchapter). Slow sand filtration shall be deemed to be capable of achieving at least 99 percent (2 Log) removal of *Giardia* cysts, 99 percent (2 Log) removal of *Cryptosporidium* oocysts, and 99 percent (2 Log) removal of viruses when in compliance with operation criteria and performance standards.

1. Expected minimum removal credits for public water systems are listed in Table 2 of this Chapter along with the corresponding remaining minimum disinfection log inactivation required.

Table 2						
Treatment Methods						
Filtration Method	Expected Minimum Log Removals			Remaining Minimum Disinfection Log Inactivation Required		
	<i>Giardia</i>	<i>Crypto</i>	Virus	<i>Giardia</i>	<i>Crypto</i>	Virus
Conventional	2.5	2.0	2.0	0.5	-0-	2.0
Direct	2.0	2.0	1.0	1.0	-0-	3.0
Slow Sand	2.0	2.0	2.0	1.0	-0-	2.0
Diatomaceous Earth	2.0	2.0	1.0	1.0	-0-	3.0

2. The remaining minimum disinfection log inactivation shall not be less than what is required pursuant to Table 2.

C. Conventional Filtration Treatment or Direct Filtration Treatment shall comply with the following performance standards for each treatment plant.

1. The turbidity level of the filtered water shall be equal to or less than 0.3 NTU in at least 95 percent of the measurements taken each month.

2. Filtered water turbidity shall not exceed 1 NTU at any time.

D. Slow Sand Filtration shall comply with the following performance standards for each treatment plant.

1. The turbidity level of the filtered water shall be less than or equal to 1 NTU in at least 95 percent of the measurements taken each month.

2. The turbidity level of the filtered water shall at no time exceed 5 NTU.

E. Diatomaceous earth filtration shall comply with the following performance standards for each treatment plant.

1. The filtered water turbidity shall be less than or equal to 1 NTU in at least 95 percent of the measurements each month.

F. An alternative to the filtration technologies specified in §1115.A of this Chapter may be used provided the supplier demonstrates to the DHH that the alternative technology: provides a minimum of 99 percent *Giardia* cyst removal, a 99 percent virus removal, and a 99 percent (2 Log) *Cryptosporidium* oocyst removal, and meets the turbidity performance standards established in §1115.C of this Chapter. Such alternative filtration technology, in combination with disinfection treatment, shall be shown to consistently achieve a total of no less than 99.9 percent (3 Log) removal and/or inactivation of *Giardia lamblia* cysts and 99.99 percent (4 Log) removal and/or inactivation of viruses. The demonstration shall be based on the results from a prior equivalency demonstration or a testing of a full scale installation that is treating a water with similar characteristics and is exposed to similar hazards as the water proposed for treatment. A pilot plant test of the water to be treated may also be used for this demonstration if conducted with the approval of the DHH. The demonstration shall be presented in an engineering report prepared by a qualified engineer. Additional reporting for the first full year of operation of a new alternative filtration treatment process approved by the DHH, may be required at DHH discretion. The report shall include results of all water quality tests performed and shall evaluate compliance with established performance standards under actual operating conditions. It shall also include an assessment of problems experienced, corrective actions needed, and a schedule for providing needed improvements.

AUTHORITY NOTE: Promulgated in accordance with R.S. 40:4(A)(8) and 40:5(2)(3)(5)(6)(17)(20).

HISTORICAL NOTE: Promulgated by the Department of Health and Hospitals, Office of Public Health, LR 28:1340 (June 2002), amended LR 28:2519 (December 2002), LR 30:1196 (June 2004), LR 35:1241 (July 2009).

§1117. Non-Filtering Systems

A. General. On a case-by-case basis, DHH may waive filtration requirements for suppliers using GWUDISW. To be considered, non-filtering systems shall conform to the criteria of this Section. All suppliers using surface water shall employ filtration.

B. Source Water Quality to Avoid Filtration

1. To avoid filtration, a system shall demonstrate that either the fecal coliform concentration is less than 20/100 ml and/or the total coliform concentration is less than 100/100 ml in the water prior to the point of disinfectant application in 90

percent of the samples taken during the six previous months. Samples shall be taken prior to blending, if employed.

a. If both fecal and total coliform analysis is performed, only the fecal coliform limit shall be met, under this condition, both fecal and total coliform results shall be reported.

b. Sample analyses methods may be the multiple-tube fermentation technique or the membrane filter technique as described in the *Standard Methods for the Examination of Water and Wastewater*, 19th Edition.

c. Minimum Sampling Frequencies

Population	Samples/Week
≤ 500	1
501-3300	2
3301-10,000	3
10,001-25,000	4
> 25,000	5

d. Also, one coliform sample shall be taken and analyzed each day the turbidity exceeds 1 NTU prior to disinfection.

2. To avoid filtration, the turbidity of the water prior to disinfection cannot exceed 5 NTU based on grab samples collected every four hours (or more frequently) that the system is in operation. Continuous turbidity measurement is allowed provided the accuracy of the turbidity measurements are validated at least weekly in accord with §1107.D of this Chapter. If there is a failure in the continuous turbidity monitoring equipment, the system shall collect and analyze a grab sample every four hours in lieu of continuous monitoring. Systems shall maintain the results of these turbidity measurements for at least three years.

C. Disinfection Criteria to Avoid Filtration

1. To avoid filtration, a system shall demonstrate that it maintains disinfection conditions which inactivate 99.9 percent (3 Log) of *Giardia* cysts and 99.99 percent (4 Log) of viruses everyday of operation except any one day each month. To demonstrate adequate inactivations, the system shall monitor and record the disinfectant used, disinfectant residual at peak hourly flow, disinfectant contact time at peak hourly flow, pH, and water temperature, and use these data to determine if it is meeting the minimum total inactivation requirements of this rule.

a. A system shall demonstrate compliance with the inactivation requirements based on conditions occurring during peak hourly flow. Residual disinfectant measurements shall be taken hourly. Continuous disinfectant residual monitors are acceptable in place of hourly samples provided the accuracy of the disinfectant measurements are validated at least weekly in accord with §1109.B or C, as applicable, of this Chapter. If there is a failure in the continuous disinfectant residual monitoring

equipment, the system shall collect and analyze a grab sample every hour in lieu of continuous monitoring.

b. pH and temperature shall be determined daily for each disinfection sequence prior to or at the first customer.

2. To avoid filtration, the system shall maintain minimum disinfectant residual concentrations in accordance with the requirements of §355 and §357 of this Part. Performance standards shall be as presented in §1119.B and C of this Chapter.

3. To avoid filtration, the disinfection system shall be capable of assuring that the water delivered to the distribution system is continuously disinfected. This requires:

a. redundant disinfection equipment with auxiliary power and automatic start up and alarm; or

b. an automatic shut off of delivery of water to the distribution system when the disinfectant residual level drops below 0.5 mg/l free chlorine residual or 0.5 mg/l chloramine residual (measured as total chlorine).

D. Site Specific Conditions to Avoid Filtration. In addition to the requirement for source water quality and disinfection, systems shall meet the following criteria to avoid filtration: maintain a watershed control program, conduct a yearly on-site inspection, determine that no waterborne disease outbreaks have occurred, comply with the total coliform MCL at least 11 months of the 12 previous months that the system served water to the public and comply on an ongoing basis, comply with Disinfection By-Product (DBP) regulations for total trihalomethanes (TTHM), haloacetic acids (five) [HAA5], bromate, and chlorite, and comply with Maximum Residual Disinfection Level (MRDL) regulations for chlorine, chloramines, and chlorine dioxide.

1. Watershed Control Program. A watershed control program for systems using GWUDISW shall include as a minimum the requirements of the Wellhead Protection Program (WHPP), delineated as follows:

a. specify the duties of state agencies, local governmental entities and public water supply systems with respect to the development and implementation of the WHPP;

b. determine the wellhead protection area (WHPA) for each wellhead as defined in 42 U.S.C.A. 300h-7(e) based on all reasonably available hydrogeologic information, groundwater flow, recharge and discharge and other information the state deems necessary to adequately determine the WHPA;

c. identify within each WHPA all potential anthropogenic sources of contaminants which may have any adverse effect on the health of persons, specifically with the goal of minimizing the potential for contamination of the source water by *Giardia lamblia* cysts, viruses, and *Cryptosporidium* oocysts;

d. describe a program that contains, as appropriate, technical assistance, financial assistance, implementation of control measures, education, training and demonstration projects to protect the water supply within WHPAs from such contaminants;

e. present contingency plans for locating and providing alternate drinking water supplies for each public water system in the event of well or wellfield contamination by such contaminants;

f. consider all potential sources of such contaminants within the expected wellhead area of a new water well which serves a public water system; and

g. provide for public participation.

2. On-Site Inspection. An annual on-site inspection is required to evaluate the watershed control program and disinfection facilities. The system shall be reviewed by a qualified engineer for the systems adequacy for producing safe drinking water. The annual on-site inspection shall include as a minimum:

a. review the effectiveness of the watershed control program;

b. review the physical condition and protection of the source intake;

c. review the maintenance program to insure that all disinfection equipment is appropriate and has received regular maintenance and repair to assure a high operating reliability;

d. review improvements and/or additions made to disinfection processes during the previous year to correct deficiencies detected in earlier surveys;

e. review the condition of disinfection equipment;

f. review operating procedures;

g. review data records to assure that all required tests are being conducted and recorded and disinfection is effectively practiced; and

h. identify any needed improvements in the equipment, system maintenance and operation, or data collection.

3. Sanitary Survey. In addition to the above requirements, a sanitary survey shall be performed every three years for community water systems and every five years for non-community water systems which use GWUDISW without filtration. The sanitary survey shall include:

a. review the condition of finished water storage facilities;

b. determine that the distribution system has sufficient pressure throughout the year;

c. verify that distribution system equipment has received regular maintenance;

d. review cross connection prevention program, including annual testing of backflow prevention devices;

e. review routine flushing program for effectiveness;

f. evaluate the corrosion control program and its impact on distribution water quality;

- g. review the adequacy of the program for periodic storage reservoir flushing;
- h. review practices in repairing water main breaks to assure they include disinfection;
- i. review additions, improvements incorporated during the year to correct deficiencies detected in the initial inspection;
- j. review the operations to assure that any difficulties experienced during the year have been adequately addressed;
- k. review staffing to assure adequate numbers of certified operators are available in accord with LAC 48:V.Chapter 73;
- l. verify that a regular maintenance schedule is followed;
- m. audit systems records to verify that they are adequately maintained; and
- n. review bacteriological data from the distribution system for coliform occurrence, repeat samples and action response.

4. No Disease Outbreaks. To avoid filtration, a system using GWUDISW shall not have been identified as a source of waterborne disease. If such an outbreak has occurred and (in the opinion of DHH) was attributed to a treatment deficiency, the system shall install filtration unless the system has upgraded its treatment to remedy the deficiency to the satisfaction of DHH.

5. Coliform MCL Regulations. To avoid filtration, a system shall have complied with the MCL for Total Coliforms, established in the Total Coliform Rule, for at least 11 out of 12 of the previous months unless DHH determines the failure to meet this requirement was not caused by a deficiency in treatment.

6. DBP Regulations. For a system using GWUDISW to continue using disinfection as the only treatment, the system shall comply with the DBP regulations, including TTHM, HAA5, bromate, and chlorite, as applicable.

7. MRDL Regulations. For a GWUDISW system to continue using disinfection as the only treatment, the system shall comply with the MRDLs for chlorine, chloramines, and chlorine dioxide, as applicable.

AUTHORITY NOTE: Promulgated in accordance with R.S. 40:4(A)(8)(13) and 40:5(2)(3)(5)(6)(17)(20).

HISTORICAL NOTE: Promulgated by the Department of Health and Hospitals, Office of Public Health, LR 28:1341 (June 2002), amended LR 28:2520 (December 2002), LR 35:1242 (July 2009), LR 42:411 (March 2016).

§1119. Disinfection Performance Standards

A. All surface water or GWUDISW utilized by a supplier shall be provided with continuous disinfection treatment sufficient to ensure that the total treatment process provides inactivation of *Giardia* cysts and viruses, in conjunction with the removals obtained through filtration, to meet the reduction requirements specified in §1113 of this Chapter.

B. Except as otherwise specified by this Section and Chapter, disinfection treatment shall comply with the minimum

standards and requirements set forth in §355.A and §357 of this Part.

C. Determination of Inactivation by Disinfection. Minimum disinfection requirements shall be determined by DHH on a case-by-case basis but shall not be less than those required in Table 2 of §1115.B.1 of this Chapter. The desired level of inactivation shall be determined by the calculation of CT values; residual disinfectant concentration ("C") times the contact times ("T") when the pipe or vessel is in operation. Disinfectant contact time shall be determined by tracer studies.

1. The T₁₀ value will be used as the detention time for calculating CTs. T₁₀ is the detention time at which 90 percent of the flow passing through a vessel is retained within the vessel. Systems conducting tracer studies shall submit a plan to DHH for review and approval prior to the study being conducted. The plan shall identify how the study will be conducted, the tracer to be used, flow rates, etc. The plan shall also identify who will actually conduct the study. Tracer studies are to be conducted according to protocol found in standard engineering texts (such as *Levenspiel*), or the methodology in EPA's *Guidance Manual for Compliance with the Filtration and Disinfection Requirements for Public Water Systems using Surface Water Sources*, March 1991 Edition (SWTR Guidance Manual).

2. On a case-by-case basis, alternate empirical methods of calculating T₁₀ as outlined in the SWTR Guidance Manual may be accepted for vessels with geometry and baffling conditions analogous to basins in which tracer studies have been conducted and results have been published in the SWTR Guidance Manual or the literature.

3. Additional tracer studies shall be conducted by the supplier whenever modifications are made which may impact flow distribution, contact time, or disinfectant distribution.

4. CT values utilized in this evaluation shall be those reported in the SWTR Guidance Manual.

AUTHORITY NOTE: Promulgated in accordance with R.S. 40:4(A)(8)(13) and 40:5(2)(3)(5)(6)(17)(20).

HISTORICAL NOTE: Promulgated by the Department of Health and Hospitals, Office of Public Health, LR 28:1341 (June 2002), amended LR 28:2522 (December 2002), LR 35:1242 (July 2009), LR 42:412 (March 2016).

§1121. Design Standards

A. All new treatment and disinfection facilities (and any existing treatment and disinfection facilities which undergo substantial renovation) shall be designed and constructed to meet the existing state sanitary code as modified by the requirements contained herein.

B. All new filtration facilities for surface water or GWUDISW plants (and any likewise existing filtration facilities which undergo substantial renovation) shall be designed such that each individual filter is constructed with filter-to-waste capability.

C. All new filtration and/or clearwell facilities for surface water or GWUDISW plants (and any likewise existing filtration and/or clearwell facilities which undergo substantial renovation) shall be designed to have one combined filter effluent point prior to clearwell storage. If this is not feasible for existing plants, such as when multiple clearwells already exist, each plant going to its own clearwell shall be designed to have a combined filter effluent point prior to that particular plant's clearwell.

AUTHORITY NOTE: Promulgated in accordance with R.S. 40:4 (A)(8) and 40:5 (2)(3)(5)(6)(17)(20).

HISTORICAL NOTE: Promulgated by the Department of Health and Hospitals, Office of Public Health, LR 28:1341 (June 2002), amended LR 28:2522 (December 2002).

Subchapter C. Monitoring Requirements

§1123. Filtration Monitoring

A. Source Water Turbidity Monitoring. Each supplier using surface water or GWUDISW as a source of water supply shall monitor the turbidity level of the raw water source by taking and analyzing no less than one grab sample per day. Continuous turbidity monitoring may be substituted provided the accuracy of the measurements are validated weekly in accord with §1107.D of this Chapter. If there is a failure in the continuous turbidity monitoring equipment, the system shall collect and analyze no less than one grab sample per day. Systems shall maintain the results of raw water turbidity monitoring for at least three years.

B. Settled Water Turbidity Monitoring

1. Each supplier using surface water as its source of water supply should monitor and record settled water turbidity prior to filtration in each individual treatment train at least once every four hours.

2. Each supplier using GWUDISW as its source of water supply should, if filtration is required or otherwise performed, monitor and record settled water turbidity prior to filtration in each individual treatment train at least once every four hours.

C. Combined Filter Effluent Turbidity Monitoring. To determine compliance with the performance standards specified in §§1115 of this Chapter, each supplier using surface water or GWUDISW shall conduct continuous turbidity monitoring of representative samples of the combined filter effluent prior to clearwell storage during all times that the system is in operation. Combined filter effluent turbidity measurements shall be recorded every 15 minutes. The accuracy of the turbidity measurements from the continuous turbidity monitor shall be validated weekly in accord with §1107.D of this Chapter. If there is a failure in the continuous turbidity monitoring equipment, the system shall collect and analyze a grab sample every two hours in lieu of continuous monitoring, but for no more than five working days following the failure of the equipment. Failure to have the continuous monitoring equipment replaced or repaired and put back into continuous service following the five working days allowed herein shall be deemed to constitute a violation of this Chapter. Systems shall

maintain the results of combined filter effluent turbidity monitoring for at least three years.

EXCEPTION: In the case of public water systems using surface water or GWUDISW and serving less than 10,000 individuals, if there is a failure in the continuous turbidity monitoring equipment, the system shall collect and analyze a grab sample every four hours in lieu of continuous monitoring, but for no more than five working days following the failure of equipment. Failure to have the continuous monitoring equipment replaced or repaired and put back into continuous service following the five working days allowed herein shall be deemed to constitute a violation of this Chapter. Systems shall maintain the results of combined filter effluent turbidity monitoring for at least three years.

1. In existing treatment plants which may not have a combined filter effluent point prior to clearwell storage or other design limitations, DHH may, on a case-by-case basis, allow turbidity compliance monitoring to be performed at an alternate sampling point which is determined to be representative of the system's filtered water (in accordance with Section 5.2.1 of the SWTR Guidance Manual). Requests to utilize an alternate turbidity monitoring sampling point for compliance monitoring shall be submitted in writing to DHH for review and approval.

2. In existing treatment plants which do not have a combined filter effluent point prior to clearwell storage, have at least four or more active filters, and which have been approved by DHH (pursuant to §1123.C.1 of this Chapter) to determine compliance with the turbidity performance standards specified in §1115 of this Chapter by using the average of measurements from each filter effluent shall, when there is a failure in the continuous turbidity monitoring equipment, only be required to collect and analyze a grab sample every four hours (in lieu of continuous monitoring and the normal every two hour grab sampling requirement specified in §1123.C of this Chapter), but for no more than five working days following the failure of the equipment. Failure to have the continuous monitoring equipment replaced or repaired and put back into continuous service following the five working days allowed herein shall be deemed to constitute a violation of this Chapter.

D. Slow Sand or Small System Turbidity Monitoring. Suppliers using surface water or GWUDISW and utilizing slow sand filtration or serving fewer than 500 people may reduce turbidity monitoring to one raw water and one combined filter effluent grab sample per day if DHH determines that less frequent monitoring is sufficient to indicate effective filtration performance.

E. Individual Filter Turbidity Monitoring/Additional Actions

1. Monitoring Individual Filters for Turbidity. Public water systems using surface water or GWUDISW as its source of water supply and which utilizes conventional filtration treatment or direct filtration shall conduct continuous turbidity monitoring for each individual filter. Such systems shall record the results of individual filter monitoring every 15 minutes while the

filter is in service. The accuracy of the turbidity measurements from the continuous turbidity monitor shall be validated weekly in accord with §1107.D of this Chapter. If there is a failure in the continuous turbidity monitoring equipment, the system shall conduct grab sampling every four hours in lieu of continuous monitoring, but for no more than five working days following the failure of equipment. Failure to have the continuous monitoring equipment replaced or repaired and put back into continuous service following the five working days allowed herein shall be deemed to constitute a violation of this Chapter. Systems shall maintain the results of individual filter monitoring for at least three years.

a. When a particular water treatment plant is not configured to allow individual filter turbidity monitoring (e.g., Greenleaf Filter Plants) as required under Paragraph 1 of this Subsection, the system shall consult with DHH on a case-by-case basis to obtain approval of a plant specific alternative monitoring plan which is deemed to comply with the intent of individual filter turbidity monitoring, as far as is possible.

2. Triggered Actions Based on Individual Filter Results

a. For a public water system using surface water or GWUDISW and which serves at least 10,000 individuals, refer to §1135.E.1 of this Chapter for additional actions which may be triggered dependent upon the results of individual filter turbidity monitoring. Compliance deadlines for performing such additional actions are also contained in §1135.E.1 of this Chapter.

b. For a public water system using surface water or GWUDISW and which serves less than 10,000 individuals, refer to §1135.F.1 of this Chapter for additional actions which may be triggered dependent upon the results of individual filter turbidity monitoring. Compliance deadlines for performing such additional actions are also contained in §1135.F.1 of this Chapter.

AUTHORITY NOTE: Promulgated in accordance with R.S. 40: 4 (A)(8) and 40: 5 (2)(3)(5)(6)(17)(20).

HISTORICAL NOTE: Promulgated by the Department of Health and Hospitals, Office of Public Health, LR 28:1342 (June 2002), amended LR 28:2522 (December 2002), LR 35:1242 (July 2009).

§1125. Disinfection Monitoring

A. CT Parameters Monitoring. To determine compliance with disinfection inactivation requirements specified in Table 2 of §1115.B.1 of this Chapter, each supplier shall develop and conduct a monitoring program to measure those parameters that affect the performance of the disinfection process. This shall include but not be limited to:

1. temperature of the disinfected water at each residual disinfectant concentration sampling point;
2. pH(s) of the disinfected water (if free chlorine is used as a disinfectant) at each free chlorine residual disinfectant concentration sampling point;
3. the disinfectant contact time(s) at peak hourly flow at each residual disinfectant concentration sampling point;
4. the residual disinfectant concentrations before or at the first customer during peak hourly flow; and

5. if the system uses more than one point of disinfectant application before the first customer, the system must determine the parameters identified in Paragraphs 1-4 of this Subsection for each individual disinfection segment immediately prior to the next point of disinfectant application during peak hourly flow so that a cumulative CT value can be determined before the treated water reaches the first customer.

B. Disinfectant Residual Monitoring at Plant. To determine compliance with the performance standards specified in §1115 or 1119 of this Chapter, the disinfectant residual concentrations of the water being delivered to the distribution system shall be measured and recorded continuously. The accuracy of disinfectant measurements obtained from continuous disinfectant monitors shall be validated at least weekly in accord with §1109.B or C, as applicable, of this Chapter. If there is a failure of continuous disinfectant residual monitoring equipment, grab sampling every two hours shall be conducted in lieu of continuous monitoring, but for no more than five working days following the failure of the equipment. Failure to have the continuous monitoring equipment replaced or repaired and put back into continuous service following the five working days allowed herein shall be deemed to constitute a violation of this Chapter. Systems shall maintain the results of disinfectant residual monitoring for at least 10 years.

C. Small System Disinfectant Residual Monitoring at Plant. Suppliers serving fewer than 3,300 people may collect and analyze grab samples of the water being delivered to the distribution system for disinfectant residual determination each day in lieu of the continuous monitoring, in accordance with Table 4 of this Chapter, provided that any time the residual disinfectant falls below 0.5 mg/l free chlorine or 0.5 mg/l chloramine residual (measured as total chlorine), the supplier shall take a grab sample every two hours until the residual concentrations is equal to or greater than 0.5 mg/l free chlorine or 0.5 mg/l chloramine residual (measured as total chlorine).

Table 4 (Applicable to Systems Serving less than 3,300 Individuals)	
Disinfectant Residual Sampling	
System Population	Samples/Day
#500	1
501-1,000	2
1,001-2,500	3
2,501-3,300	4

D. Disinfectant Residual Monitoring in Distribution System. The residual disinfectant concentrations in the distribution system shall be measured, recorded, and maintained in accordance with §367.B, C, D and E of this Part. A monitoring plan shall be developed, submitted, reviewed, and approved in accordance with §367.E of this Part.

AUTHORITY NOTE: Promulgated in accordance with R.S. 40:4(A)(8)(13) and R.S. 40:5(2)(3)(5)(6)(17)(20).

HISTORICAL NOTE: Promulgated by the Department of Health and Hospitals, Office of Public Health, LR 28:1342 (June 2002), amended LR 28:2523 (December 2002), LR 35:1243 (July 2009), LR 42:412 (March 2016).

§1127. Disinfection Profiling

A. All public water systems using surface water or GWUDISW as its source of water supply and serving at least 10,000 individuals shall perform a disinfection profile of its disinfection practice on a continuous, daily basis. All public water systems using surface water or GWUDISW as its source of water supply and serving less than 10,000 individuals shall perform a disinfection profile of its disinfection practice on a continuous, weekly basis.

1. Any system that meets the criteria of Subsection A of this Section shall perform monitoring on each day [or, in the case of systems serving less than 10,000 individuals, once each week (on the same calendar day)] of operation to determine the total logs of inactivation of *Giardia lamblia* cysts, based upon the CT_{99,9} (3-Log) values in Appendix E of the SWTR Guidance Manual, as appropriate, through the entire treatment plant. Any system that uses chloramines, ozone, or chlorine dioxide for primary disinfection shall additionally calculate the total logs of inactivation of viruses for each day of operation, based upon the CT_{99,99} (4-Log) values in Appendix E of the SWTR Guidance Manual. Systems with more than one point of disinfectant application shall conduct monitoring for each disinfection segment. The following parameters shall be monitored:

a. the temperature of the disinfected water at each disinfectant residual concentration sampling point during peak hourly flow;

b. if the system uses free chlorine, the pH of the disinfected water at each free chlorine residual disinfectant concentration sampling point during peak hourly flow;

c. the disinfectant contact time(s) ("T") at peak hourly flow at each residual disinfectant concentration sampling point using approved mathematical computations as outlined in Appendix C of the SWTR Guidance Manual or using the system's specific curve which is graphed as "Detention Time (T₁₀ in minutes) vs. Flow (in MGD)" (as per the example shown in Figure C-4 of Appendix C of the SWTR Guidance Manual) to determine the contact time based upon flow, subject to the following additional requirements:

i. for systems serving 3,300 persons or more, the disinfectant contact time(s) is to be determined through the use of data developed from actual tracer studies conducted on the system (see Paragraph 1119.C.1). [Theoretical contact time(s) using baffling factors are not to be used for systems serving 3,300 persons or more.];

ii. for systems serving less than 3,300 persons, the disinfectant contact time(s) may be estimated through the use of data developed in a theoretical manner by determining pipeline capacities, treatment basin capacities, clearwell storage capacity, storage tank capacities, etc., and applying the appropriate geometry and baffling factor(s) (see Paragraph 1119.C.2);

d. the residual disinfectant concentration(s) ("C") of the water before or at the first customer during peak hourly flow;

(NOTE: If the treatment plant uses its own finished water for potable purposes, the first customer may be the treatment plant itself.); and

e. if the system uses more than one point of disinfectant application before the first customer, the system must determine the parameters identified in Subparagraphs a-d of this Paragraph for each individual disinfection segment immediately prior to the next point of disinfectant application during peak hourly flow so that a cumulative CT value can be determined before the treated water reaches the first customer.

(NOTE: If the treatment plant uses its own finished water for potable purposes, the first customer may be the treatment plant itself.)

B. In addition, systems subject to the requirements of Subsection A of this Section shall compute their daily or weekly (dependent upon system size, see Subsection A of this Section) total logs of inactivation utilizing a computer spread sheet format/formulas approved by DHH. The system shall retain printed disinfection profile data as daily or weekly (dependent upon system size, see Subsection A of this Section) individual spreadsheets (containing the monitoring data, CT computation, and total log inactivation data) and in monthly/yearly graphical profile form for review as part of sanitary surveys conducted by DHH.

AUTHORITY NOTE: Promulgated in accordance with R.S. 40:4 (A)(8) and R.S. 40: 5 (2)(3)(5)(6)(17)(20).

HISTORICAL NOTE: Promulgated by the Department of Health and Hospitals, Office of Public Health, LR 28:2524 (December 2002), amended LR 35:1243 (July 2009).

§1129. Disinfection Practice Changes

A. Suppliers using surface water or GWUDISW as the source of water supply which decide to make a significant change to its disinfection practice shall submit plans and specifications to DHH for review and approval (in accord with the requirements of §105 of this Part) prior to making such change. Significant changes to disinfection practice are:

1. any changes to the point of disinfection;
2. any changes to the disinfectant(s) used in the treatment plant;
3. any changes to the disinfection process; or
4. any disinfection practice modification which may lower the system's ability to comply with the required minimum log inactivation attributable to disinfection as listed in Table 2 of §1115.B.1 of this Chapter.

AUTHORITY NOTE: Promulgated in accordance with R.S. 40: 4 (A)(8) and R.S. 40: 5 (2)(3)(5)(6)(17)(20).

HISTORICAL NOTE: Promulgated by the Department of Health and Hospitals, Office of Public Health, LR 28:2525 (December 2002), amended LR 35:1244 (July 2009).

Subchapter D. Operation

§1131. Operating Criteria

A. All treatment plants utilizing surface water or GWUDISW shall be operated by certified operators in accord with LAC 48:V.Chapter 73.

B. Filtration facilities shall be operated in accordance with the following requirements.

1. Conventional and direct filtration treatment plants shall be operated at flow rates not to exceed 3 gallons per minute per square foot (gpm/sq ft) for gravity filters. In any instance when pressure filters have been approved by DHH as the primary turbidity removal mechanism (see §323 of this Part), filtration rates shall not exceed 2 gpm/sq ft.

2. Slow sand filters shall be operated at filtration rates not to exceed 0.10 gallons per minute per square foot. The filter bed shall not be dewatered except for cleaning and maintenance purposes.

3. Diatomaceous earth filters shall be operated at filtration rates not to exceed 1.0 gallon per minute per square foot.

4. In order to obtain approval for higher filtration rates than those specified in this Section, the supplier shall demonstrate to DHH that the filters can achieve an equal degree of performance.

5. Filtration rates shall be increased gradually when placing filters back into service following backwashing or any other interruption in the operation of the filter.

6. In any instance when pressure filters have been approved by DHH as the primary turbidity removal mechanism (see §323 of this Part), such filters shall be physically inspected and evaluated annually (not sooner than 120 calendar days from any previous inspection/evaluation) for such factors as media condition, mudball formation, and short circuiting. A written record of the inspection shall be maintained at the treatment plant.

C. Disinfection facilities shall be operated in accordance with the following requirements.

1. A supply of chemicals necessary to provide continuous operation of disinfection facilities shall be maintained as a reserve or demonstrated to be available under all conditions and circumstances.

2. An emergency plan shall be developed prior to and implemented in the event of disinfection failure to prevent delivery to the distribution system of any undisinfected or inadequately disinfected water. The plan shall be posted in the treatment plant or other place readily accessible to the plant operator.

3. System redundancy and changeover systems shall be maintained and kept operational at all times to ensure no interruption in disinfection.

AUTHORITY NOTE: Promulgated in accordance with R.S. 40: 4 (A)(8), R.S. 40: 5 (2)(3)(5)(6)(17)(20) and R.S. 40:1148.

HISTORICAL NOTE: Promulgated by the Department of Health and Hospitals, Office of Public Health, LR 28:2525 (December 2002).

Subchapter E. Reporting

§1133. DHH Notification

A. The supplier shall notify DHH by telephone or other equally rapid means (see Subsection C of this Section) as soon as possible but no later than 24 hours whenever:

1. the turbidity of the combined filter effluent as monitored exceeds 1.0 NTU at any time for conventional filtration treatment or direct filtration treatment;

2. more than two (i.e., three) consecutive four hour monitoring periods of the combined filter effluent show an exceedance of 0.5 NTU for conventional filtration treatment or direct filtration treatment;

3. the turbidity of the combined filter effluent as monitored exceeds 1.0 NTU for slow sand filtration or diatomaceous earth filtration;

4. the turbidity of the combined filter effluent as monitored exceeds the maximum level set by DHH for the particular alternative filtration technology approved by DHH pursuant to §1115.F of this Chapter;

5. the disinfectant residual measured from any sample collected from water being delivered to the distribution system is found to be less than 0.5 mg/l free chlorine or 0.5 mg/l chloramine residual (measured as total chlorine). The notification shall indicate whether the disinfectant residual was restored to at least 0.5 mg/l free chlorine or 0.5 mg/l chloramine residual (measured as total chlorine) within 4 hours;

6. an event occurs which may affect the ability of the treatment plant to produce a safe, potable water including, but not limited to, spills of hazardous materials in the watershed and unit treatment process failures;

7. a waterborne disease outbreak potentially attributable to the water system has occurred and is discovered by the supplier.

B. In accord with the requirement of §321 of this Part, the supplier shall notify DHH by telephone or other equally rapid means (see Subsection C of this Section) as soon as possible but no later than 48 hours whenever:

1. non-compliance with a combined filter effluent turbidity standard occurs during any one particular month, e.g., anytime a minimum number of individual turbidity measurements above the turbidity standard will cause the system to exceed its 5 percent monthly allowance. [For example, in a 30 calendar day month and a plant operating 24 hours per day a total of 180 combined filter effluent turbidity compliance measurements are to be taken per month. Whenever a total of 10 combined filter effluent compliance measurements have been found to exceed 0.3 NTUs, the system is in violation of its treatment technique requirement ($10 \div 180 \times 100 = 5.5$)]

percent) and must notify DHH as soon as possible but not later than 48 hours of the violation.]

C. When the need arises to contact DHH during weekends, state holidays, and other times when DHH offices are closed, the public water system shall contact a DHH representative via BlackBerry® (or equivalent smartphone) by e-mail communication to: "safe.water@la.gov". The e-mail message should provide the name of the public water system, the PWS ID # (for example, PWS ID # 1095009) which has been assigned to identify your water system, the name of the person sending the e-mail communication, and a telephone number (with area code) so that a DHH staff member can in turn speak with whoever sent the e-mail. [In most cases, it is expected that your own district or regional engineer will be returning the call (even when the office is closed) in order to consult directly with you on your problem or situation.]

AUTHORITY NOTE: Promulgated in accordance with R.S. 40:4(A)(8)(13) and 40:5(2)(3)(5)(6)(17)(20).

HISTORICAL NOTE: Promulgated by the Department of Health and Hospitals, Office of Public Health, LR 28:2525 (December 2002), amended LR 35:1244 (July 2009), LR 42:412 (March 2016).

§1135. Monthly Report

A. General. Each supplier with a surface water or GWUDISW treatment facility shall submit a monthly written report on the operation of each facility to the DHH by the tenth day of the following month. Such report shall be signed by a certified operator of the public water system.

B. Combined Filter Effluent Turbidity Results. The monthly report shall include the following results of samples collected from the combined filter effluent (or from an alternate compliance sampling point as approved by DHH on a case-by-case basis).

1. The highest individual turbidity measurement determined within each four hour monitoring period for each day that the system is in operation. Suppliers operating treatment facilities continuously shall report the highest individual turbidity measurement for each of the following four hour monitoring periods:

- a. 12:01 am - 4:00 am;
- b. 4:01 am - 8:00 am;
- c. 8:01 am - 12:00 pm (noon);
- d. 12:01 pm - 4:00 pm;
- e. 4:01 pm - 8:00 pm;
- f. 8:01 pm - 12:00 am (midnight).

NOTE: Suppliers which do not operate their treatment facilities continuously shall utilize these same time periods, as applicable, for reporting purposes. Times when there is no combined filter effluent available for monitoring, such as when the plant is not in operation, shall also be recorded by the supplier and such events shall be clearly identified and reported on the monthly report.

2. The number and percent of turbidity measurements reported under Paragraph 1 of this Subsection which are less than or equal to the performance standard specified for each filtration technology in §1115 of this Chapter, or as required for an alternative filtration technology.

3. The maximum daily raw water turbidity.

4. For public water systems using surface water or GWUDISW which utilize conventional or direct filtration treatment, the monthly report shall advise whether or not combined filter effluent turbidity monitoring has been conducted continuously and whether or not the measurements were recorded every 15 minutes. The monthly report shall also indicate the date and time when there is a failure in the continuous turbidity monitoring equipment or plant out of service as well as the date and time that such equipment/plant was placed back into service.

5. At the special request of the state health officer on a case-by-case basis, the supplier shall also provide an additional report listing the date and value of any other combined filter effluent turbidity measurement recorded by the supplier which exceeded the performance levels specified in §1115 of this Chapter and any corresponding raw water turbidity levels.

C. Disinfection Monitoring Results. The monthly report shall include the following disinfection monitoring results.

1. The date and duration of each instance when the disinfectant residual in water supplied to the distribution system is less than 0.5 mg/l free chlorine or 0.5 mg/l chloramine residual (measured as total chlorine) and when the DHH was notified of the occurrence.

2. The following information on samples taken from the distribution system:

- a. the number of samples where the disinfectant residual is measured; and
- b. the number of measurements where the disinfectant residual is less than 0.5 mg/l free chlorine or 0.5 mg/l chloramine residual (measured as total chlorine).

D. Explanation of Cause of Violation. The monthly report shall include a written explanation of the cause of any violation of performance standards specified in §§1115, 1117, or 1119 and operating criteria specified in §1131 of this Chapter.

E. Individual Filter Turbidity Results/Additional Actions—for Systems Serving at Least 10,000 Individuals

1. For public water systems using surface water or GWUDISW which serve at least 10,000 individuals and utilizes conventional or direct filtration treatment, the monthly report shall advise whether or not individual filter turbidity monitoring has been conducted continuously and whether or not the measurements were recorded every 15 minutes. Such systems shall additionally report individual filter turbidity measurement results taken only if measurements demonstrate one or more of the following four exceedance conditions.

a. For any individual filter that has a measured turbidity level of greater than 1.0 NTU in two consecutive measurements taken 15 minutes apart, the system shall

report the filter number, the turbidity measurement, and the date(s) on which the exceedance occurred. In addition, the system shall either produce a filter profile for the filter within seven days of the exceedance (if the system is not able to identify an obvious reason for the abnormal filter performance) and report that the profile has been produced or report the obvious reason for the exceedance.

b. For any individual filter that has a measured turbidity level of greater than 0.5 NTU in two consecutive measurements taken 15 minutes apart at the end of the first four hours of continuous filter operation after the filter has been backwashed or otherwise taken off-line, the system shall report the filter number, the turbidity, and the date(s) on which the exceedance occurred. In addition, the system shall either produce a filter profile for the filter within seven days of the exceedance (if the system is not able to identify an obvious reason for the abnormal filter performance) and report that the profile has been produced or report the obvious reason for the exceedance.

c. For any individual filter that has a measured turbidity level of greater than 1.0 NTU in two consecutive measurements taken 15 minutes apart at any time in each of three consecutive months, the system shall report the filter number, the turbidity measurement, and the date(s) on which the exceedance occurred. In addition, the system shall conduct a self-assessment of the filter within 14 days of the exceedance and report that the self-assessment was conducted. The self-assessment shall consist of at least the following components: an in-depth evaluation of filter performance, including analysis of historical filtered water turbidity from the filter; development of a filter profile; identification and prioritization of factors limiting filter performance; evaluation of the applicability of corrections; and, preparation of a filter self-assessment report.

d. For any individual filter that has a measured turbidity level of greater than 2.0 NTU in two consecutive measurements taken 15 minutes apart at any time in each of two consecutive months, the system shall report the filter number, the turbidity measurement, and the date(s) on which the exceedance occurred. In addition, the system shall arrange for the conduct of a comprehensive performance evaluation (CPE) by DHH or a third party approved by DHH no later than 30 days following the exceedance and have the evaluation completed and submitted to DHH no later than 90 days following the exceedance. For systems experiencing multiple exceedances, only one CPE is adequate until that CPE has been completed and the appropriate corrective actions taken.

i. This CPE shall be considered a compliance CPE; thus, either or both of the following shall be considered a violation(s) of this Chapter:

(a.) failure to respond in writing to performance-limiting factors identified in the CPE within 45 days after receipt of the report, indicating how and on what schedule the system will address performance-limiting factors noted in the report; or

(b.) failure to correct the performance-limiting factors identified in the CPE within a time schedule acceptable to DHH.

2. When a filter profile/obvious reason, self-assessment, or CPE has been triggered by the turbidity results of an individual filter, the following additional information for such filter shall be reported in the monthly report.

a. Data recorded relative to the occurrence of a failure in the continuous turbidity monitoring equipment for the affected individual filter or filter out of service conditions, the identity of the individual filter, the date and time of such equipment failure or out of service conditions as well as the date and time that the equipment and/or filter was placed back into service.

F. Individual Filter Turbidity Results/Additional Actions—for Systems Serving Less than 10,000 Individuals

1. For public water systems using surface water or GWUDISW which serve less than 10,000 individuals and utilizes conventional or direct filtration treatment, the monthly report shall advise whether or not individual filter turbidity monitoring has been conducted continuously and whether or not the measurements were recorded every 15 minutes. Such systems shall additionally report individual filter turbidity measurement results taken only if measurements demonstrate one or more of the following three exceedance conditions.

a. For any individual filter [or the turbidity of the combined filter effluent (CFE) for systems having only two filters and which monitor the CFE in lieu of monitoring each individual filter] that has a measured turbidity level of greater than 1.0 NTU in two consecutive measurements taken 15 minutes apart, the system shall report the filter number(s), the turbidity measurement(s), and the date(s) on which the exceedance occurred. In addition, the system shall report the cause or obvious reason (if known) for the exceedance.

b. For any individual filter [or the turbidity of the CFE for systems having only two filters and which monitor the CFE in lieu of monitoring each individual filter] that has a measured turbidity level of greater than 1.0 NTU in two consecutive measurements taken 15 minutes apart at any time in each of three consecutive months [unless a CPE as specified in Subparagraph c of this Paragraph was required], the system shall report the filter number(s), the turbidity measurement(s), and the dates on which the exceedances occurred. In addition, the system shall conduct a self-assessment of the filter within 14 days of the last exceedance date (the exceedance which occurred during the third straight month). The self-assessment shall consist of at least the following components: an in-depth evaluation of filter performance, including analysis of historical filtered water turbidity from the filter; development of a filter profile; identification and prioritization of factors limiting filter performance; evaluation of the applicability of

corrections; and, preparation of a filter self-assessment report. The filter self-assessment report shall also include the date that the self-assessment was triggered and the date that the self-assessment was completed. Systems having only two filters and which monitor the CFE in lieu of monitoring each individual filter shall conduct a self- assessment on both filters.

c. For any individual filter [or the turbidity of the CFE for systems having only two filters and which monitor the CFE in lieu of monitoring each individual filter] that has a measured turbidity level of greater than 2.0 NTU in two consecutive measurements taken 15 minutes apart at any time in each of two consecutive months, the system shall arrange for the conduct of a comprehensive performance evaluation (CPE) by DHH or a third party approved by DHH no later than 60 days following the exceedance and have the evaluation completed and submitted to DHH no later than 120 days following the last exceedance date (the exceedance which occurred during the second straight month). For systems experiencing multiple exceedances, only one CPE is adequate until that CPE has been completed and the appropriate corrective actions taken. If a CPE has been completed by DHH or a third party approved by DHH within the 12 prior months or the system and DHH are jointly participating in an ongoing Comprehensive Technical Assistance (CTA) project at the system, a new CPE is not required.

i. This CPE shall be considered a compliance CPE; thus, either or both of the following shall be considered a violation(s) of this Chapter:

(a.) failure to respond in writing to performance-limiting factors identified in the CPE within 45 days after receipt of the report, indicating how and on what schedule the system will address performance-limiting factors noted in the report; or

(b.) failure to correct the performance-limiting factors identified in the CPE within a time schedule acceptable to DHH.

2. When the cause/obvious reason, self-assessment, or CPE has been triggered by the turbidity results of an individual filter [or the turbidity of the CFE for systems having only two filters and which monitor the CFE in lieu of monitoring each individual filter], the following additional information for such filter(s) shall be reported in the monthly report.

a. Data recorded relative to the occurrence of a failure in the continuous turbidity monitoring equipment for the affected individual filter(s) or filter out of service conditions, the identity of the individual filter(s), the date and time of such equipment failure or out of service conditions as well as the date and time that the equipment and/or filter(s) was placed back into service.

AUTHORITY NOTE: Promulgated in accordance with R.S. 40:4(A)(8)(13) and R.S. 40:5(2)(3)(5)(6)(17)(20).

HISTORICAL NOTE: Promulgated by the Department of Health and Hospitals, Office of Public Health, LR 28:2526 (December 2002), amended LR 35:1244 (July 2009), LR 42:412 (March 2016).

§1137. Disinfection Profiling Report

A. Public water systems subject to the requirements of §1127.A of this Chapter shall submit to DHH a printed report on the initial 12 consecutive months of disinfection profiling data [including daily or weekly (dependent upon system size, see §1127.A), individual spreadsheets containing the monitoring data, CT computation, and total log inactivation data] and in monthly/yearly graphical profile form as required under §§1127 of this Chapter. For systems serving at least 10,000 individuals, this disinfection profiling report is due on no later than February 15, 2004. For systems serving less than 10,000 individuals which have not yet submitted a report to DHH, this disinfection profiling report is due on July 20, 2009.

B. On a case-by-case basis, DHH may accept existing operational data in lieu of the requirements of Subsection A of this Section if DHH determines that such data is substantially equivalent to data required to be collected under §1127 of this Chapter. Such data shall be representative of inactivation through the entire treatment plant and not just of certain treatment segments.

C. Following the submittal of the initial 12 consecutive month period report required under Subsection A of this Section, nothing herein shall be construed to prohibit DHH from requiring the public water system to submit a more current disinfection profiling data set on a case-by-case basis (e.g., when a significant change to the disinfection practice is proposed, etc.).

AUTHORITY NOTE: Promulgated in accordance with R.S. 40: 4 (A)(8) and R.S. 40: 5 (2)(3)(5)(6)(17)(20).

HISTORICAL NOTE: Promulgated by the Department of Health and Hospitals, Office of Public Health, LR 28:2527 (December 2002), amended LR 35:1245 (July 2009)

Subchapter F. Public Notification

§1139. Consumer Notification

A. Treatment Technique/Performance Standard Violations. The supplier shall notify persons served by the system whenever there is a failure to comply with the treatment technique requirements specified in §§1113 or 1141, or a failure to comply with the performance standards specified in §§1115, 1117, 1119.A or 1119.C of this Chapter. The notification shall be given in a manner approved by the DHH, and shall include the following mandatory language.

1. "The La. Department of Health and Hospitals (DHH) sets drinking water standards and has determined that the presence of microbiological contaminants are a health concern at certain levels of exposure. If water is inadequately treated, microbiological contaminants in that water may cause disease. Disease symptoms may include diarrhea, cramps, nausea, and possibly jaundice, and any associated headaches and fatigue. These symptoms, however are not just associated with disease-causing organisms in drinking water, but also may be caused by a

number of factors other than your drinking water. DHH has set enforceable requirements for treating drinking water to reduce the risk of these adverse health effects. Treatment such as filtering and disinfecting the water removes or destroys microbiological contaminants. Drinking water which is treated to meet DHH requirements is associated with little to none of this risk and should be considered safe.”

B. Tier 1 Violations. When:

1. an event occurs which may affect the ability of the treatment plant to produce safe, potable water as specified under §1133.A.6 of this Chapter;

2. a waterborne disease outbreak occurs as specified under §1133.A.7 of this Chapter;

3. the combined filter effluent turbidity level exceeds 5.0 NTU; or,

4. other conditions/violations which are deemed by the state health officer, acting personally, as posing an acute risk to human health exist or occur;

5. the public water system shall, unless directed otherwise by the Office of Public Health in writing, furnish a notice to radio and television stations and daily newspapers serving the area as soon as possible but not later than 24 hours after the public water system learns of the violation or situation. The public water system shall also ensure that the actual public notice prepared by the water system is published in a daily or weekly newspaper serving the area as soon as possible but no later than 48 hours after learning of the violation or situation.

EXCEPTION: When furnishing a notice to radio and television stations, newspaper notice, or mailing is deemed not feasible for a non-community water system, continuous posting (in conspicuous places within the area served by the system) and, if available, e-mailing (to students or employees, for example) may be substituted. The notice shall remain posted for a minimum of at least 7 days.

C. Tier 2 Violations. When there is a failure to comply with a treatment technique requirement or performance standard as required in Subsection A of this Section, the public water system shall, unless directed otherwise by the Office of Public Health in writing, provide public notification in a daily or weekly newspaper serving the area as soon as possible but no later than 14 days after the violation or failure. In addition to newspaper notice, a notice shall also be provided to the consumers by direct mail or hand delivery within 30 days after the violation or failure.

EXCEPTION: When furnishing a notice to a newspaper is deemed not feasible for a non-community water system, continuous posting (in conspicuous places within the area served by the system) and, if available, e-mailing (to students or employees, for example) may be substituted. The notice shall remain posted for a minimum of at least 7 days.

D. Tier 3 Violations. The public water system shall notify persons served by the system in the manner approved by DHH whenever there is a failure to comply with the monitoring requirements specified in §§1123 or 1125 of this Chapter or the analytical requirements in §1105 of this Chapter. When there is a failure to comply with these monitoring or analytical

requirements, the public water system shall, unless directed otherwise by the Office of Public Health in writing, provide public notification in a daily or weekly newspaper serving the area within 45 days of the violation or failure. In addition to newspaper notice, a notice shall also be provided to the consumers by direct mail or hand delivery within 90 days after the violation or failure.

EXCEPTION: When furnishing a notice to a newspaper is deemed not feasible for a non-community water system, continuous posting (in conspicuous places within the area served by the system) and, if available, e-mailing (to students or employees, for example) may be substituted. The notice shall remain posted for a minimum of at least 7 days.

E. Systems required to provide public notification shall otherwise be required to comply with the requirements of §1903 of this Part.

AUTHORITY NOTE: Promulgated in accordance with R.S. 40:4(A)(8)(13) and R.S. 40:5(2)(3)(5)(6)(17)(20).

HISTORICAL NOTE: Promulgated by the Department of Health and Hospitals, Office of Public Health, LR 28:2527 (December 2002), amended LR 35:485 (March 2009), LR 35:1246 (July 2009), LR 42:413 (March 2016).

Subchapter G. Filter Backwash Recycling

§1141. Recycling Provisions

A. Applicability. All public water systems having treatment plants which utilize surface water or GWUDISW that employ conventional filtration treatment or direct filtration treatment and that recycle spent filter backwash water, thickener supernatant, or liquids from dewatering processes must meet the requirements in Subsections B through D of this Section.

B. Reporting. A system must notify the Department of Health and Hospitals (DHH) in writing if the system recycles spent filter backwash water, thickener supernatant, or liquids from dewatering processes. This notification must include, at a minimum, the following information:

1. a plant schematic showing the origin of all flows which are recycled (including, but not limited to, spent filter backwash water, thickener supernatant, and liquids from dewatering processes), the hydraulic conveyance used to transport them, and the location where they are re-introduced back into the treatment plant;

2. typical recycle flow in gallons per minute (gpm), the highest observed plant flow experienced in the previous year (gpm), design flow for the treatment plant (gpm), and the DHH-approved operating capacity for the plant where the DHH has made such determinations.

C. Treatment Technique Requirement. Any system that recycles spent filter backwash water, thickener supernatant, or liquids from dewatering processes must return these flows through the processes of a system's existing conventional or direct filtration system as defined

in §1103.B or at an alternate location approved by the DHH.

D. Recordkeeping. The system must collect and retain on file recycle flow information for review and evaluation by DHH as follows:

1. copy of the recycle notification and information submitted to the DHH under Subsection B of Section;
2. list of all recycle flows and the frequency with which they are returned;
3. average and maximum backwash flow rate through the filters and the average and maximum duration of the filter backwash process in minutes;
4. typical filter run length and a written summary of how filter run length is determined;
5. the type of treatment provided for the recycle flow;
6. data on the physical dimensions of the equalization and/or treatment units, typical and maximum hydraulic loading rates, type of treatment chemicals used and average dose and frequency of use, and frequency at which solids are removed, if applicable.

AUTHORITY NOTE: Promulgated in accordance with R.S. 40:4(A)(8) and R.S. 40:5(2)(3)(5)(6)(17)(20).

HISTORICAL NOTE: Promulgated by the Department of Health and Hospitals, Office of Public Health, LR 35:1246 (July 2009).

Chapter 12. Ground Water Rule

§1201. General

A. Pursuant to the definition of *National Primary Drinking Water Regulations* and the provisions of §377 of this Part, the Louisiana Department of Health (LDH) Office of Public Health (OPH) adopts by reference the United States Environmental Protection Agency (USEPA) federal Ground Water Rule (GWR) as published in the *Federal Register* dated November 8, 2006 (Volume 71, Number 216, pages 65650 - 65659). In addition, under §377 of this Part, LDH-OPH also adopted by reference certain USEPA technical corrections to the federal GWR. The applicable technical corrections were published in the *Federal Register* dated November 21, 2006 (Volume 71, Number 224, page 67427).

AUTHORITY NOTE: Promulgated in accordance with R.S. 40:4(A)(8) and R.S. 40:5.A.(2)(3)(5)(6)(17)(20).

HISTORICAL NOTE: Promulgated by the Department of Health, Office of Public Health, LR 43:88 (January 2017).

Chapter 13. Disinfectants and Disinfection Byproducts Rule

Subchapter A. General

§1301. General

A. Pursuant to the definition of *national primary drinking water regulations* and the provisions of §377 of this Part, the Department of Health and Hospitals (DHH) Office of Public Health (OPH) adopts by reference the United States Environmental Protection Agency (USEPA) federal Disinfectants and Disinfection Byproducts Rule (D/DBPR) as

published in the *Federal Register* dated December 16, 1998 (Volume 63, Number 241, pages 69389-69476). In addition, under §377 of this Part, DHH-OPH also adopted by reference certain USEPA technical corrections to the federal D/DBPR. The applicable technical corrections were published in the *Federal Register* dated January 16, 2001 (Volume 66, Number 10, pages 3769-3780) and in the *Federal Register* dated February 12, 2001 (Volume 66, Number 29, page 9903). The regulations in this Chapter are promulgated in order to clarify the state's discretionary decisions allowed by the federal requirements.

B. Pursuant to the definition of national primary drinking water regulations and the provisions of §377 of this Part, the Department of Health and Hospitals (DHH) Office of Public Health (OPH) adopts by reference the United States Environmental Protection Agency (USEPA) federal Stage 2 Disinfectants and Disinfection Byproducts Rule (Stage 2 D/DBPR) as published in the *Federal Register* dated January 4, 2006 (Volume 71, Number 2, pages 388-493). In addition, under §377 of this Part, DHH-OPH also adopted by reference certain USEPA technical corrections to the federal Stage 2 D/DBPR. The applicable technical corrections were published in the *Federal Register* dated January 27, 2006 (Volume 71, Number 18, pages 4644-4645), in the *Federal Register* dated June 29, 2006 (Volume 71, Number 125, page 37168) and in the *Federal Register* dated November 14, 2006 (Volume 73, Number 221, pages 67456-67463).

AUTHORITY NOTE: Promulgated in accordance with R.S. 40:4(A)(8) and 40:5(2)(3)(5)(6)(17)(20).

HISTORICAL NOTE: Promulgated by the Department of Health and Hospitals, Office of Public Health, LR 30:1196 (June 2004), amended LR 38:2377 (September 2012).

Subchapter B. Disinfection Byproduct (DBP) Precursor Control

§1303. Applicability

A. The requirements of this Subchapter shall only be applicable to public water systems whose source of water is surface water or ground water under the direct influence of surface water (GWUDISW) which employ conventional filtration treatment.

AUTHORITY NOTE: Promulgated in accordance with R.S. 40:4(A)(8) and 40:5(2)(3)(5)(6)(17)(20).

HISTORICAL NOTE: Promulgated by the Department of Health and Hospitals, Office of Public Health, LR 30:1196 (June 2004).

§1305. Monthly TOC Monitoring/Reporting

A. Public water systems, meeting §1303.A applicability requirements of this Subchapter, shall submit the results of their paired (source water and treated water) total organic carbon (TOC) samples (which have been collected for compliance determination in accord with the system's approved D/DBPR monitoring plan) to the state health officer monthly for each individual treatment plant. In addition, the result of source water alkalinity sampling

conducted at the same time as the source water TOC sample shall also be submitted to the state health officer monthly for each individual treatment plant. The actual monthly TOC percent removal and the removal ratio (reported to two significant figures past the decimal point) shall be calculated in accord with 40 CFR 141.135(c) and indicated on the form. All results for each particular plant shall be on a report form approved by the state health officer. Such report shall specifically be provided to the OPH District Engineering office which has jurisdictional oversight of the public water system within 10 days following the end of each calendar month.

B. When monthly TOC percent removal calculations performed under Subsection A of this Section result in a negative number (indicative of having a higher level of TOC in treated water than in source water), a "0" percent removal shall be reported for that particular paired sample set instead of the negative number. If this should happen, OPH recommends that an additional paired sample set of TOC samples be collected later in that same month. If the system chooses to collect an additional paired sample set of TOC samples during that same month, the system shall mathematically average the "0" result of the first paired sample set with the result of the second paired sample set and report such average as the monthly TOC percent removal achieved on the monthly TOC report form. If the system does not choose to collect an additional paired sample set of TOC samples during that same month, the system shall report a "0" percent removal achieved on the monthly TOC report form.

C. Plant sites having multiple treatment trains shall perform TOC paired monitoring on each treatment train and report the results of each separate treatment train on its own, individual, and properly identified TOC monthly operating report. The actual monthly TOC percent removal and the removal ratio (reported to two significant figures past the decimal point) for the entire plant site shall be determined by performing a flow-weighted average using the results from each individual treatment train. Flow-weighted averaging shall be based upon the flows at the moment in time that the samples are collected. The percent flow attributed to each treatment train shall be reported and shown in the flow-weighted average calculation formula.

1. On a case-by-case basis, a system may apply to DHH-OPH for approval of the use of a flow-weighted sample composite of all treatment trains in lieu of individual TOC analyses of each individual treatment train. The flow-weighted sample shall be composited by laboratory personnel using aliquots from individual samples collected from each treatment train. Flow-weighted averaging shall be based upon the flows at the moment in time that the samples are collected. Each sample composite shall consist of aliquots from no more than five different treatment trains. Each laboratory report of a sample composite shall identify the specific treatment trains associated with the composited sample.

2. On a case-by-case basis, a system may apply to DHH-OPH for a waiver allowing monitoring of only one treatment train at a facility having multiple treatment trains if the system can demonstrate consistency in TOC sample results between each of the different treatment trains located at the facility. If

such waiver is granted, it shall be stipulated therein that the waiver shall automatically cease if any treatment changes are made which may affect the continued consistency between TOC sample results between the various treatment trains.

AUTHORITY NOTE: Promulgated in accordance with R.S. 40:4(A)(8) and 40:5(2)(3)(5)(6)(17)(20).

HISTORICAL NOTE: Promulgated by the Department of Health and Hospitals, Office of Public Health, LR 30:1196 (June 2004).

§1307. Quarterly TOC Report

A. At the end of each calendar quarter, public water systems, meeting §1303.A applicability requirements of this Subchapter, shall submit a quarterly TOC report to the state health officer for each plant site. Particularly, after

12 consecutive months of TOC compliance monitoring have occurred, the system shall, following the end of each calendar quarter, calculate the running annual TOC removal ratio average using the previous 12 months of monthly TOC removal ratios as the basis. [For example, the report for the fourth calendar quarter of 2004 (required to be submitted no later than January 10, 2005) will consist of the annual average removal ratio determined from the 12 monthly removal ratios reported from each of the then 12 preceding months, i.e., January-December 2004. The report for the first calendar quarter 2005 (required to be submitted no later than April 10, 2005) will consist of the annual average removal ratio determined from the 12 monthly removal ratios reported from each of the then preceding 12 months, i.e., April 2004-March 2005. The report for the second calendar quarter 2005 (required to be submitted no later than July 10, 2005) will consist of the annual average removal ratio determined from the 12 monthly removal ratios reported from each of the then preceding 12 months, i.e., July 2004-June 2005. The report for the third calendar quarter 2005 (required to be submitted no later than October 10, 2005) will consist of the annual average removal ratio determined from the 12 monthly removal ratios reported from each of the then preceding 12 months, i.e., October 2004-September 2005, etc.] The quarterly TOC report shall be on a report form approved by the state health officer. Such report shall specifically be provided to the OPH District Engineering Office which has jurisdictional oversight of the public water system within 10 days following the end of each calendar quarter.

AUTHORITY NOTE: Promulgated in accordance with R.S. 40:4(A)(8) and 40:5(2)(3)(5)(6)(17)(20).

HISTORICAL NOTE: Promulgated by the Department of Health and Hospitals, Office of Public Health, LR 30:1197 (June 2004).

§1309. Step 2 Bench-Scale (Jar) or Pilot-Scale Testing

A. Water systems, meeting §1303.A applicability requirements of this Subchapter, which cannot achieve Step 1 TOC removal requirements at any time following 12 months of paired TOC monitoring, shall submit an application to the state health officer for approval of

alternative minimum (Step 2) TOC removal requirements. Such application shall be submitted within three months of the failure to achieve the Step 1 TOC removal requirements specified in 40 CFR 141.135(b)(2). The application shall include the results of bench-scale (jar) or pilot-scale testing conducted in accordance with the applicable provisions of §377 of this Part, specifically, 40 CFR 141.135(b)(4). The system shall conduct bench-scale (jar) or pilot-scale testing at a frequency of no less than once per calendar quarter for at least one year (beginning from the time of failure to achieve Step 1 TOC removal requirements) so that seasonal changes in raw water quality may be assessed and accounted for.

B. For a system which voluntarily completed 12 months of TOC monitoring prior to the applicable federal compliance date of the rule for the particular system (i.e., performed pre-compliance paired TOC/alkalinity monitoring to determine whether Step 1 TOC removals could be met before the compliance date of the rule) and then determines in the first 12 months after the federal compliance date that it is not able to meet the Step 1 TOC removal requirements and therefore must apply for alternative minimum TOC removal (Step 2) requirements, the state health officer may make the Step 2 requirements retroactive for the purpose of determining compliance.

1. Pursuant to the requirements of Subsection A of this Section, at least one Step 2 TOC bench-scale (jar) or pilot-scale test is required to be performed per calendar quarter. When the state health officer agrees to make the Step 2 TOC removal requirements retroactive in accord with the requirements of Subsection B of this Section, the Step 2 TOC removal requirements shall be applied retroactively by the equivalent calendar quarter. [For example, Step 2 TOC removal requirements determined during the first calendar quarter of 2005 (for applicable surface water systems serving less than 10,000 persons) shall retroactively be applied as the TOC requirement to the first calendar quarter of 2004; Step 2 TOC removal requirements determined during the second calendar quarter of 2005 shall retroactively be applied as the TOC requirement to the second calendar quarter of 2004; Step 2 TOC removal requirements determined during the third calendar quarter of 2005 shall retroactively be applied as the TOC requirement to the third calendar quarter of 2004; and, Step 2 TOC removal requirements determined during the fourth calendar quarter of 2005 shall retroactively be applied as the TOC requirement to the fourth calendar quarter of 2004.]

C. For those systems which may be achieving Step 1 removals during 2002 and 2003 (for applicable systems serving 10,000 or more persons) or during 2004 and 2005 (for applicable systems serving less than 10,000 persons) and then, for whatever reason, all of a sudden cannot achieve Step 1 removals in 2004 or later (for applicable systems serving 10,000 or more persons) or 2006 or later (for applicable systems serving less than 10,000 persons), Step 2 bench-scale (jar) or pilot-scale testing results may then be applied to the three months of the quarter in which the Step 2 bench-scale (jar) or pilot-scale testing is performed and retroactively to the three months of the prior calendar quarter (six months total).

1. The raw water quality characteristics of any Step 2 bench-scale (jar) or pilot-scale testing must be substantially equivalent to the raw water quality characteristics when the problematic Step 1 monitoring was performed. At its discretion, DHH-OPH is authorized to require a system to perform a new Step 2 bench-scale (jar) or pilot-scale testing particularly when it is determined that the Step 1 and Step 2 raw water quality characteristics are not substantially equivalent.

AUTHORITY NOTE: Promulgated in accordance with R.S. 40:4(A)(8) and 40:5(2)(3)(5)(6)(17)(20).

HISTORICAL NOTE: Promulgated by the Department of Health and Hospitals, Office of Public Health, LR 30:1197 (June 2004).

§1311. Alternative Compliance Criteria

A. When a public water system, meeting §1303.A applicability requirements, uses an alternative compliance criteria (ACC) on its monthly TOC monitoring report, the following numbering key shall be employed to identify the specific alternative compliance criteria used.

1. *ACC #1*—source water TOC level is less than 2.0 mg/L.

2. *ACC #2*—treated water TOC level is less than 2.0 mg/L.

3. *ACC #3*—source water TOC is less than 4.0 mg/L and source water alkalinity is greater than 60mg/L (as CaCO₃) and either:

a. the TTHM and HAA5 running annual averages are no greater than 0.040 mg/L and 0.030 mg/L, respectively; or

b. prior to the effective date for compliance, the system has made a clear and irrevocable financial commitment not later than the effective date for compliance to use technologies that will limit the levels of TTHMs and HAA5s to no more than 0.040 mg/L and 0.030 mg/L, respectively.

4. *ACC #4*—the TTHM and HAA5 running annual averages are no greater than 0.040 mg/L, respectively, and the system uses only chlorine for primary disinfection and maintenance of a residual in the distribution system.

5. *ACC #5*—source water specific ultraviolet absorbance (SUVA) prior to any treatment is less than or equal to 2.0 L/mg-m.

6. *ACC #6*—finished water SUVA is less than or equal to 2.0 L/mg-m.

7. *ACC #7*—for systems practicing enhanced softening that cannot achieve the Step 1 TOC removal requirements and softening results in lowering the treated water alkalinity to less than 60 mg/L (as CaCO₃).

8. *ACC #8*—for systems practicing enhanced softening that cannot achieve the Step 1 TOC removal requirements and softening results in removing at least 10 mg/L of magnesium hardness (as CaCO₃).

B. When ACC #6 is utilized, the water samples for dissolved organic carbon (DOC) and ultraviolet absorption at a wavelength of 254 nanometers (UV₂₅₄) shall be collected at a point in the treatment plant after coagulation, flocculation, and sedimentation have occurred as well as at a point prior to the addition of any oxidant or disinfectant to the water. Such samples shall also be collected no later than the point at which samples for combined filter effluent turbidity are collected. If the plant is designed such that these monitoring parameters can not be met, or if ferric salts are used for coagulation in the clarification process, then a source water sample, prior to any treatment, shall be collected for the performance of a "treated-water SUVA jar test." Such "treated-water SUVA jar test" shall simulate actual plant conditions relative to coagulation, flocculation, and sedimentation. No oxidant, disinfectant, or ferric salts shall be employed in this jar test. Plants using ferric salts must replace the ferric with an equivalent amount of alum in the "treated-water SUVA jar test." After coagulation, flocculation, and sedimentation have been simulated in the jar test, samples of the supernatant shall be collected for DOC and UV₂₅₄ determination. The results of such samples are to be used as the basis for calculating the finished water SUVA value under ACC #6.

AUTHORITY NOTE: Promulgated in accordance with R.S. 40:4(A)(8) and 40:5(2)(3)(5)(6)(17)(20).

HISTORICAL NOTE: Promulgated by the Department of Health and Hospitals, Office of Public Health, LR 30:1198 (June 2004).

§1313. Amendment to the Step 1 Required Removal of TOC Matrix Table under 40 CFR 141.135(b)(2) to Clarify ACC #1

A. In order to clarify the requirements for a system to be able to achieve ACC #1, the "Step 1 Required Removal of TOC by Enhanced Coagulation and Enhanced Softening for Subpart H Systems Using Conventional Treatment" matrix table under 40 CFR 141.135(b)(2) is hereby amended to read as follows.

STEP 1 REQUIRED REMOVAL OF TOC BY ENHANCED COAGULATION AND ENHANCED SOFTENING FOR SUBPART H SYSTEMS USING CONVENTIONAL TREATMENT^{1,2}

Source-Water TOC, mg/L	Source-Water Alkalinity, mg/L as CaCO ₃ (in percentages)		
	0-60	>60-120	>120 ³
≥2.0-4.0	35.0	25.0	15.0
>4.0-8.0	45.0	35.0	25.0
>8.0	50.0	40.0	30.0

¹Systems meeting at least one of the conditions in Paragraph (a)(2)(i)-(vi) of 40 CFR 141.135 are not required to operate with enhanced coagulation.

²Softening system meeting one of the alternative compliance criteria in Paragraph (a)(3) of 40 CFR 141.135 are not required to operate with enhanced softening.

³System practicing softening must meet the TOC removal requirements in this column.

AUTHORITY NOTE: Promulgated in accordance with R.S. 40:4(A)(8) and 40:5(2)(3)(5)(6)(17)(20).

HISTORICAL NOTE: Promulgated by the Department of Health and Hospitals, Office of Public Health, LR 30:1198 (June 2004).

§1315. Analytical Requirements for TOC, DOC, and UV₂₅₄

A. All compliance monitoring samples for TOC, DOC, and UV₂₅₄ shall be analyzed in a certified chemical laboratory/drinking water or in an EPA-certified laboratory.

B. In addition to any other applicable analytical requirements, all laboratories in Subsection A of this Section which analyze compliance monitoring samples for TOC, DOC, and UV₂₅₄ shall incorporate the quality assurance (QA) and quality control (QC) procedures contained within "EPA Method 415.3, Revision 1.0" dated June 2003 which is titled "Determination of Total Organic Carbon and Specific UV Absorbance at 254 nm in Source Water and Drinking Water."

C. The effective date of this Section shall be January 1, 2005.

AUTHORITY NOTE: Promulgated in accordance with R.S. 40:4(A)(8) and 40:5(2)(3)(5)(6)(17)(20).

HISTORICAL NOTE: Promulgated by the Department of Health and Hospitals, Office of Public Health, LR 30:1199 (June 2004).

Subchapter C. Chlorite/Chlorine Dioxide

§1317. Monthly Reporting Required

A. If a system uses chlorine dioxide, chlorite monitoring results (daily, monthly, as well as any additional compliance monitoring) and daily chlorine dioxide residual monitoring results (as ClO₂) shall be reported to the state health officer monthly. All results shall be on a report form approved by the state health officer. Such report shall specifically be provided to the OPH district engineering office which has jurisdictional oversight of the public water system within 10 days following the end of each calendar month.

1. Nothing within this Section shall be interpreted to exempt a public water system which uses chlorine dioxide from issuing public notification and consulting with the state health officer as soon as possible but no later than 24 hours after the system learns of an acute violation of the maximum residual disinfectant level (MRDL) for chlorine dioxide.

AUTHORITY NOTE: Promulgated in accordance with R.S. 40:4(A)(8) and 40:5(2)(3)(5)(6)(17)(20).

HISTORICAL NOTE: Promulgated by the Department of Health and Hospitals, Office of Public Health, LR 30:1199 (June 2004).

Subchapter D. Monitoring Plans

§1319. Monitoring Plan Required

A. Each public water system required to perform monitoring under the requirements of this Chapter shall submit a monitoring plan to the state health officer for review and approval. Such monitoring plan shall specifically be provided to the OPH district engineering

office which has jurisdictional oversight of the public water system no later than the effective date of this rule.

B. The monitoring plan shall include a list of all routine samples required on a daily, weekly, monthly, quarterly, and annual basis and identify the sampling location where samples are to be collected.

C. The public water system shall revise and re-submit its monitoring plan if changes to a plant or distribution system require changes to the sampling locations or if any significant changes to the disinfection methods are made. In addition, the public water system shall update and re-submit its monitoring plan when the system's sampling requirements or protocols change.

D. Minor revisions to a system's monitoring plan shall be submitted to the state health officer upon request.

E. The public water system shall maintain a copy of their approved monitoring plan at each treatment plant and at a central location.

AUTHORITY NOTE: Promulgated in accordance with R.S. 40:4(A)(8) and 40:5(2)(3)(5)(6)(17)(20).

HISTORICAL NOTE: Promulgated by the Department of Health and Hospitals, Office of Public Health, LR 30:1199 (June 2004).

Chapter 15. Approved Chemical Laboratories/Drinking Water

Subchapter A. Definitions and General Requirements

§1501. Definitions of Terms

A. Words Not Defined. Words not defined in this Chapter shall have the meanings stated in §101 of this Part or other Parts of the Louisiana state sanitary code. When words not defined in this Chapter are defined in both §101 of this Part and in another Part of the Louisiana state sanitary code, the definition contained within §101 of this Part shall be given preference as it pertains to water supplies. Words not defined in any of these source documents shall have the meanings stated in the Merriam-Webster's Collegiate Dictionary-Tenth Edition, as revised.

B. Definitions. Definitions contained in §101 of this Part shall also apply to this Chapter except where the following special definitions apply.

Analyte—a particular contaminant or value that one is analyzing a water sample for, e.g., temperature, pH, turbidity, disinfectant residual, chlorite, total organic carbon, or UV₂₅₄.

Approved Chemical Laboratory/Drinking Water—a laboratory approved by the state health officer under the requirements of this Chapter to analyze and report compliance monitoring sample results for certain physical and chemical analytes associated with drinking water which are not required to be analyzed in a certified chemical laboratory/drinking water.

AUTHORITY NOTE: Promulgated in accordance with R.S. 40:4(A)(8) and 40:5(2)(3)(5)(6)(17)(20).

HISTORICAL NOTE: Promulgated by the Department of Health and Hospitals, Office of Public Health, LR 30:1199 (June 2004).

§1503. General Requirements

A. Public water systems which provide treatment (other than chlorination) to the water shall provide an approved chemical laboratory/drinking water on-site or make contractual arrangements with an approved chemical laboratory/drinking water off-site to analyze and report results for certain physical and chemical analytes which are not required to be analyzed in a certified chemical laboratory/drinking water.

1. All samples collected for compliance determination shall be either analyzed in a certified chemical laboratory/drinking water or in an approved chemical laboratory/drinking water. Samples collected for compliance determination which are allowed to be analyzed in an approved chemical laboratory/drinking water include the following:

- a. daily chlorite levels (at the point of entry to the distribution system when using chlorine dioxide);
- b. daily fluoride levels;
- c. daily corrosion inhibitor concentrations (orthophosphate and silica);
- d. pH;
- e. calcium;
- f. conductivity;
- g. temperature;
- h. alkalinity;
- i. turbidity;
- j. jar test for ACC #6 (as per §1311.B of this Part);
- k. jar tests for determining optimum coagulant dose (including Step 2 TOC removal per §1309 of this Part); and

1. other drinking water analytes which are not required to be analyzed in a certified chemical laboratory/drinking water under other requirements of this Part or USEPA requirements.

B. In order to ensure an accurate and true representation of the level of an analyte associated with drinking water, the requirements of Subsection A of this Section shall not be construed to allow an approved chemical laboratory/drinking water off-site to perform a physical or chemical determination of an analyte when such analyte cannot be satisfactorily fixed, preserved, or transported (e.g., disinfectant residual levels, etc.).

C. An approved chemical laboratory/drinking water shall perform all analyses using the laboratory methodology specifically required to be used under the provisions of this Part for such analyte.

AUTHORITY NOTE: Promulgated in accordance with R.S. 40:4(A)(8)(13) and 40:5(2)(3)(5)(6)(17)(20).

HISTORICAL NOTE: Promulgated by the Department of Health and Hospitals, Office of Public Health, LR 30:1199 (June 2004), amended LR 42:413 (March 2016).

§1505. Staffing, Equipment, Quality Control and Records

A. There shall be sufficient staff to perform the tests required.

B. There shall be sufficient supplies, equipment and space to perform the required volume of work with optimal accuracy, precision, timeliness and safety.

1. All approved chemical laboratories/drinking water for public water systems that use chlorine dioxide shall be provided with an amperometric titrator with platinum-platinum electrodes capable of measuring chlorite to a minimum accuracy of plus or minus 0.05 mg/L.

2. pH must be conducted using a pH meter with a minimum accuracy of plus or minus 0.2 pH units.

3. Water temperature must be measured using a thermometer or thermocouple with a minimum accuracy of plus or minus 0.5 degrees Celsius (0.5°C).

C. An approved chemical laboratory/drinking water shall ensure that satisfactory provisions are maintained for an instrumentation preventative maintenance program, an acceptable quality control program, and an approved proficiency testing program covering all of the various types of analyses performed.

D. An approved chemical laboratory/drinking water shall ensure that records and reports are satisfactorily maintained and retrievable. Copies of records and reports for any off-site approved chemical laboratory/drinking water shall be filed in a folder identifying the public water system by name as well as its public water system identification number (PWS ID #).

AUTHORITY NOTE: Promulgated in accordance with R.S. 40:4(A)(8) and 40:5(2)(3)(5)(6)(17)(20).

HISTORICAL NOTE: Promulgated by the Department of Health and Hospitals, Office of Public Health, LR 30:1200 (June 2004).

Subchapter B. Procedures to Become an Approved Chemical Laboratory/Drinking Water

§1507. Application and Approval

A. All public water systems which provide treatment (other than chlorination) to the water shall submit a completed "Request for Approved Chemical Laboratory/Drinking Water" form to the state health officer. If the public water system uses one or more off-site laboratories, it shall be the responsibility of the public water system to notify each such off-site laboratory to submit its own completed "Request for Approved Chemical Laboratory/Drinking Water" form to the state health officer.

B. The "Request for Approved Chemical Laboratory/Drinking Water" form shall list all analytes run by the laboratory as well as the associated laboratory methodology. In addition, laboratories holding the status of an approved chemical laboratory/drinking water shall maintain a

readily available list of the names and PWS ID#'s of all public water systems it currently serves.

C. Based upon a satisfactory review of the contents of the submittal (along with a signed statement by any off-site laboratory agreeing to allow unannounced inspections of the laboratory facilities, including any applicable records, by the state health officer), the state health officer shall issue a certificate of approval to the public water system or off-site laboratory granting it the status of a "DHH-OPH Approved Chemical Laboratory/Drinking Water." Each laboratory facility receiving a certificate of approval under this Subsection shall prominently display such certificate.

D. Any correspondence, certificate, advertisement, laboratory results, etc., to or from a "DHH-OPH Approved Chemical Laboratory/Drinking Water" shall state prominently in bold lettering the following statement.

1. This "DHH-OPH Approved Chemical Laboratory/Drinking Water" does not meet the higher criteria required by DHH-OPH to be classified as a "DHH-OPH Certified Chemical Laboratory/Drinking Water;" therefore, any results reported from this laboratory for drinking water parameters which are required to be analyzed in a certified chemical laboratory are officially deemed invalid.

2. Any sample results for a public water system which are officially deemed invalid for failure to have them analyzed in a certified chemical laboratory/drinking water may result in a monitoring violation if replacement samples are not collected and properly analyzed by a certified chemical laboratory/drinking water within the prescribed monitoring period. Any monitoring or analytical violations require public notification as prescribed in §1903 of this Part.

AUTHORITY NOTE: Promulgated in accordance with R.S. 40:4 (A)(8) and R.S. 40:5 (2)(3)(5)(6)(17)(20).

HISTORICAL NOTE: Promulgated by the Department of Health and Hospitals, Office of Public Health, LR 30:1200 (June 2004), amended LR 35:485 (March 2009).

Subchapter C. Consequences of Non-Compliance

§1509. Public Notification

A. If it becomes apparent either through laboratory reporting, on-site visits, or any other means that the "DHH-OPH Approved Chemical Laboratory/Drinking Water" is either intentionally or unintentionally not using or improperly using the required analytical methodology to perform an accurate and precise determination of an analyte associated with drinking water, the "DHH-OPH Approved Chemical Laboratory/Drinking Water's" certificate of approval shall be immediately suspended or revoked by the state health officer, and all public water systems utilizing such laboratory shall provide public notification as prescribed in §1903 of this Part.

AUTHORITY NOTE: Promulgated in accordance with R.S. 40:4(A)(8) and R.S. 40:5(2)(3)(5)(6)(17)(20).

HISTORICAL NOTE: Promulgated by the Department of Health and Hospitals, Office of Public Health, LR 30:1201 (June 2004), amended LR 35:485 (March 2009).

Chapter 17. Lead and Copper Rule

§1701. General

A. Pursuant to a revision of the definition of *National Primary Drinking Water Regulations* published in the May 20, 1994 *Louisiana Register* (LR 20:545), the Department of Health and Hospitals (DHH) Office of Public Health (OPH) initially adopted by reference the United States Environmental Protection Agency's (USEPA) federal Lead and Copper Rule (LCR) as published in the *Federal Register* dated June 7, 1991 (Volume 56, Number 110, pages 26547 through 26564), including the federal Lead and Copper Rule corrections as published in the *Federal Registers* dated July 15, 1991 (Volume 56, Number 135, page 32113) and June 29, 1992 (Volume 57, Number 125, pages 28788 through 28789). Pursuant to another revision of the definition of *National Primary Drinking Water Regulations* published in the May 20, 2000 *Louisiana Register* (LR 26:1037) and the provisions of paragraph 12:026 (now §377), further technical corrections [as published in the *Federal Register* dated June 30, 1994 (Volume 59, Number 125, page 33862 through 33864)] to the federal Lead and Copper Rule were adopted by DHH-OPH. Pursuant to another DHH-OPH revision of the definition of *National Primary Drinking Water Regulations*, published in the October 20, 2004 *Louisiana Register* (LR 30:2326), and the provisions of §377 of this Part, the DHH-OPH adopted by reference the USEPA federal Lead and Copper Rule Minor Revisions (LCRMRs) as published in the *Federal Register* dated January 12, 2000 (Volume 65, Number 8, pages 2003 through 2014) as well as additional technical corrections to the Lead and Copper Rule as published in the *Federal Register* dated June 29, 2004 (Volume 69, Number 124, pages 38855 through 38857). Pursuant to yet another DHH-OPH revision of the definition of the *National Primary Drinking Water Regulations*, published in the *Louisiana Register* (LR 38:2374, September 2012), and the provisions of §377 of this Part, the DHH-OPH adopted by reference the USEPA federal Lead and Copper Rule Short Term Revisions (LCRSTRs) as published in the *Federal Register* dated October 10, 2007 (Volume 72, Number 195, pages 57782 through 57820). The regulations in this Chapter are promulgated in order to clarify the state's discretionary decisions allowed by the federal requirements.

AUTHORITY NOTE: Promulgated in accordance with R.S. 40:4(A)(8) and 40:5(2)(3)(5)(6)(17)(20).

HISTORICAL NOTE: Promulgated by the Department of Health and Hospitals, Office of Public Health, LR 30:2327 (October 2004), amended LR 38:2377 (September 2012).

§1703. Certification of Sampling Sites for Compliance Monitoring

A. Community and non-transient non-community water systems shall complete and submit a DHH-OPH certification form listing each site selected for compliance monitoring and the site's associated tier level (tier 1 sampling site, tier 2 sampling site, or tier 3 sampling site) as well as whether or not

the site is served by a lead service line. The various tier levels are defined in 40 CFR 141.86(a). Such systems shall additionally certify that a materials evaluation of the system was completed as per the requirements of 40 CFR 141.86(a) and shall, based upon such information, indicate whether or not the system has any lead service lines in use. The date of completion of the materials evaluation shall be indicated as well on the certification form. If any lead service lines are in use, an approximate number shall be indicated on the certification form. The certification form referred to in this Section shall be signed by the certified operator of the water system and shall be submitted to the state health officer at least 14 business days prior to the commencement of compliance monitoring. Upon request, a copy of any documents, information, or other data relative to the material evaluation or tier selection shall be provided to the state health officer.

AUTHORITY NOTE: Promulgated in accordance with R.S. 40:4(A)(8) and 40:5(2)(3)(5)(6)(17)(20).

HISTORICAL NOTE: Promulgated by the Department of Health and Hospitals, Office of Public Health, LR 30:2327 (October 2004).

Chapter 19. Public Notification Rule

§1901. General

A. Pursuant to a revision of the state's definition of *National Primary Drinking Water Regulations (NPDWRs)* published in the September 20, 1988 *Louisiana Register* (LR 14:630), the Department of Health and Hospitals (DHH) Office of Public Health (OPH) adopted by reference the United States Environmental Protection Agency's (USEPA) revised Public Notification rule as published in the *Federal Register* dated October 28, 1987 (Volume 52, Number 208, pages 41534 through 41550). These revisions of the federal public notification regulations were as a result of the Safe Drinking Water Act Amendments of 1986 (Pub. L. 99-339 dated June 19, 1986). Technical amendments were made to the public notification regulations in the *Federal Register* dated April 17, 1989 (Volume 54, Number 72, pages 15185 through 15188). These April 17, 1989 federal technical amendments were adopted by DHH-OPH by reference when the state's definition of the *NPDWRs* first included a reference to Part 141 of Title 40 of the July 1, 1997 edition of the *Code of Federal Regulations*. Amendments to a portion of the public notification regulations were also included when DHH-OPH adopted the federal Total Coliform Rule which was published in the *Federal Register* on June 29, 1989 (Volume 54, Number 124, pages 27562 through 27567) by reference. Amendments to a portion of the public notification regulations were also included when DHH-OPH adopted the federal Phase II Rule published in the *Federal Register* on January 30, 1991 (Volume 56, Number 20, pages 3578 through 3597), the federal Lead and Copper Rule published in *Federal Register* on June 7, 1991 (Volume 56, Number 110, pages 26547 through 26564), the federal Phase IIB Rule published in the *Federal Register* on July 1, 1991

(Volume 56, Number 126, pages 30274 through 30281), and the federal Phase V Rule published in the *Federal Register* on July 17, 1992 (Volume 57, Number 138, pages 31838 through 31849) by reference. Amendments to a portion of the federal public notification regulations as per the federal Technical Amendments and Clarifications for Phase I, II and V Rule published in the *Federal Register* on July 1, 1994 (Volume 59, Number 126, pages 34322 through 34325) were also adopted by DHH-OPH by reference when the state's definition of the *NPDWRs* first included a reference to Part 141 of Title 40 of the July 1, 1997 edition of the *Code of Federal Regulations*.

1. The federal public notification regulations were amended once again by the USEPA pursuant to the Safe Drinking Water Act Amendments of 1996 (Pub. L. 104-182 dated August 6, 1996). Pursuant to yet another DHH-OPH revision of the definition of *NPDWRs*, published in the March 20, 2009 *Louisiana Register* (LR 35:486), and the provisions of §377 of this Part, the DHH-OPH adopted by reference the USEPA federal Public Notification Rule as published in the *Federal Register* dated May 4, 2000 (Volume 65, Number 87, pages 25981 through 26049) as well as additional technical corrections to the Public Notification Rule as published in the *Federal Register* dated June 21, 2000 (Volume 65, Number 120, pages 38629 through 38634), the *Federal Register* dated June 30, 2000 (Volume 65, Number 127, pages 40520 through 40522), and the *Federal Register* dated November 27, 2002 (Volume 67, Number 229, pages 70857 through 70858). The regulations in this Chapter are promulgated in order to clarify the state's discretionary decisions allowed by the federal requirements. [As stated in §377 of this Part, be advised that when the *NPDWRs* (as defined in this Part) and the state's own rules and/or regulations applicable to public water systems conflict, then the state's own rules and/or regulations shall govern.]

AUTHORITY NOTE: Promulgated in accordance with R.S. 40:4(A)(8) and 40:5(2)(3)(5)(6)(17)(20).

HISTORICAL NOTE: Promulgated by the Department of Health and Hospitals, Office of Public Health, LR 35:485 (March 2009).

§1903. Public Notification **[Formerly §313]**

A. If a public water system fails to comply with an applicable maximum contaminant level, treatment technique requirement, or analytical requirement as prescribed by this Code or fails to comply with the requirements of any schedule prescribed pursuant to a variance or exemption, or fails to perform any monitoring required by this Code, the public water system shall notify persons served by the system of the failure in a manner prescribed by the *national primary drinking water regulations* (as defined in this Part), §§358, 913, 1139, 1317, 1507, 1509, and the Public Notification Rule (Chapter 19 of this Part), as applicable.

B. In addition, if a public water system fails to report required analytical data to the appropriate office designated by the state health officer within the applicable time limit(s) stipulated by the National Primary Drinking Water Regulations (as defined in this Part), the Louisiana Total Coliform Rule (Chapter 9 of this Part), the Surface Water Treatment Rule (Chapter 11 of this Part), the Disinfectants and Disinfection

Byproducts Rule (Chapter 13 of this Part), or the Approved Chemical Laboratories/Drinking Water Rule (Chapter 15 of this Part), and such data (e.g., turbidity measurements, corrosion control chemical concentrations, etc.) is required to determine a maximum contaminant level or treatment technique requirement prescribed by this Code, the public water system shall be assessed a monitoring violation and must give appropriate public notification.

C. With the exception of Tier 1 public notification which requires a more prompt certification response (see §1905.A), the water supply, within 10 days subsequent to the completion of each public notification shall submit to the state health officer a completed public notification certification form and a representative copy of each type of notice distributed, published, posted and/or made available to the persons served by the supply and/or to the news media.

AUTHORITY NOTE: Promulgated in accordance with R.S. 40:4(A)(8) and 40:5(2)(3)(5)(6)(17)(20).

HISTORICAL NOTE: Promulgated by the Department of Health and Hospitals, Office of Public Health, LR 35:486 (March 2009), amended LR 35:1246 (July 2009), LR 38:2378 (September 2012), LR 42:413 (March 2016).

§1905. Tier 1 Public Notice

A. Delivery. When a Tier 1 public notice is required under the National Primary Drinking Water Regulations, §913, §1139.B, or §1317.A.1 of this Part, and after consultation with the Office of Public Health (see Subsection C of this Section for after-hours contact procedures), the public water system shall, unless directed otherwise by the Office of Public Health in writing, furnish a notice to customers via broadcast media (such as radio and television stations) and daily newspapers serving the area as soon as possible but not later than 24 hours after the public water system learns of the violation or situation. The public water system shall also ensure that the actual public notice prepared by the water system is published in a daily or weekly newspaper serving the area as soon as possible but no later than 48 hours after the violation or failure.

EXCEPTION: When furnishing a notice to radio and television stations, newspaper notice, or mailing is deemed not feasible for a non-community water system, continuous posting (in conspicuous places within the area served by the system) and, if available, e-mailing (to students or employees, for example) may be substituted. The notice shall remain posted for a minimum of at least 7 days.

B. Immediate Certification of Completion of 24 hour Notification. As soon as possible, but not later than 24 hours after providing public notice to the broadcast media and daily newspapers as required under §1905.A, the public water system shall deliver or fax a completed public notice certification form (including a copy of the actual public notice provided) to the Office of Public Health's District Engineering Services Section office which oversees the water system. The purpose of this form is for the water system to confirm to the Office of Public Health that Tier 1 public notice has been

completed. Should the Office of Public Health's District Engineering Services Section office fail to receive the completed public notice certification form within 24 hours after the system should have completed providing the Tier 1 public notice, the Office of Public Health is authorized to issue Tier 1 public notice directly to the broadcast media and newspapers and to take other measures to ensure that the public is notified. The owner or operator of the public water system remains responsible for ensuring that the requirements of this Chapter are met.

C. Consultation/Certification with the Office of Public Health during weekends and state holidays and other times of office closure. Should the need for consultation with and/or the need to provide certification to the Office of Public Health occur during a weekend, state holiday, or other times of state office closure, the public water system shall contact the Office of Public Health's Safe Drinking Water Program via BlackBerry® (or equivalent smartphone) by e-mail communication to: "safe.water@la.gov". Besides stating the need to consult with and/or the need to provide certification to the Office of Public Health, the e-mail message should additionally provide the name of the public water system, the Office of Public Health PWS ID # (for example, PWS ID #1095009) which has been assigned to identify your water system, the name of the person sending the e-mail communication, and a telephone number (with area code) so that a Safe Drinking Water Program staff member can in turn speak with whoever sent the e-mail. [In most cases, it is expected that your own district or regional engineer will be returning the call (even when the office is closed) in order to consult directly with you on your problem or situation.]

AUTHORITY NOTE: Promulgated in accordance with R.S. 40:4(A)(8) and 40:5(2)(3)(5)(6)(17)(20).

HISTORICAL NOTE: Promulgated by the Department of Health and Hospitals, Office of Public Health, LR 35:486 (March 2009), amended by the Department of Health, Office of Public Health, LR 48:1104 (April 2022).

§1907. Tier 2 Public Notice

A. When a Tier 2 public notice is required under the national primary drinking water regulations, §§358, 913 or 1139.C of this Part, the public water system shall, unless directed otherwise by the Office of Public Health in writing, provide public notification in a daily or weekly newspaper serving the area as soon as possible but no later than 14 days after the violation or failure. In addition to newspaper notice, a notice shall also be provided to the consumers by direct mail or hand delivery within 30 days after the violation or failure.

EXCEPTION: When furnishing a notice to a newspaper is deemed not feasible for a non-community water system, continuous posting (in conspicuous places within the area served

by the system) and, if available, e-mailing (to students or employees, for example) may be substituted. The notice shall remain posted for a minimum of at least 7 days.

AUTHORITY NOTE: Promulgated in accordance with R.S. 40:4(A)(8) and 40:5(2)(3)(5)(6)(17)(20).

HISTORICAL NOTE: Promulgated by the Department of Health and Hospitals, Office of Public Health, LR 35:487 (March 2009), amended LR 42:413 (March 2016).

§1909. Tier 3 Public Notice

A. When a Tier 3 public notice is required under the National Primary Drinking Water Regulations, §913, §1139.D, §1507.D.2 or §1509.A of this Part, the public water system shall, unless directed otherwise by the Office of Public Health in writing, provide public notification in a daily or weekly newspaper serving the area as soon as possible but no later than 45 days after the violation or failure. In addition to newspaper notice, a notice shall also be provided to the consumers by direct mail or hand delivery within 90 days after the violation or failure.

EXCEPTION: When furnishing a notice to a newspaper is deemed not feasible for a non-community water system, continuous posting (in conspicuous places within the area served by the system) and, if available, e-mailing (to students or employees, for example) may be substituted. The notice shall remain posted for a minimum of at least 7 days.

AUTHORITY NOTE: Promulgated in accordance with R.S. 40:4(A)(8) and 40:5(2)(3)(5)(6)(17)(20).

HISTORICAL NOTE: Promulgated by the Department of Health and Hospitals, Office of Public Health, LR 35:487 (March 2009).

§1911. Public Notice for Certain Violations of Specific Drinking Water Rules

A. Louisiana Total Coliform Rule. Also refer to §913 of this Part.

B. Surface Water Treatment Rule. Also refer to §1139 of this Part.

C. Disinfectants and Disinfection Byproducts Rule. Also refer to §1317 of this Part.

D. Approved Chemical Laboratories/Drinking Water. Also refer to §§1507 and 1509 of this Part.

AUTHORITY NOTE: Promulgated in accordance with R.S. 40:4(A)(8) and 40:5(2)(3)(5)(6)(17)(20).

HISTORICAL NOTE: Promulgated by the Department of Health and Hospitals, Office of Public Health, LR 35:487 (March 2009), amended LR 35:1246 (July 2009), LR 38:2378 (September 2012).

Title 51
PUBLIC HEALTH—SANITARY CODE
Part XIII. Sewage Disposal

Chapter 1. General
[formerly Chapter 13 Subpart A]

§101. Definitions
[formerly paragraph 13:001]

A. As used in this Part, the terms defined in this Chapter supplement any definitions which may be set forth in law and shall have the following meanings and/or applications, unless the context or use thereof clearly indicates otherwise, or more explicit definitions and/or applications are referenced. Terms not defined or referenced herein shall have the meanings as defined in the other Parts of the sanitary code of the state of Louisiana. In any instance where a term defined herein is also defined in one or more other Parts of this Code, the definition contained in this Part shall be given preference as it pertains to sewage disposal.

Commercial Treatment Facility (designed in accordance with §503)—any treatment facility which is required by the state health officer whenever the use of an individual sewerage system is unfeasible or not authorized.

Community Sewerage System—any sewerage system which serves multiple connections and consists of a collection and/or pumping/transport system and treatment facility.

Conventional Septic Tank System—a septic tank system which consists of a septic tank(s) followed by a subsurface absorption field.

Facility or *Facilities*—any or all of the apparatus and appurtenances associated with a sanitary sewage treatment system, element, or process.

Gravelless Pipe—a proprietary device which may be used in lieu of conventional subsurface absorption field materials when approved by the state health officer.

Individual Mechanical Plant—a treatment facility which provides primary and secondary treatment of sanitary sewage by use of aerobic bacterial action which is sustained by mechanical means.

Individual Sewerage System—any system of piping (excluding the building drain), and/or collection and/or transport system which serves one or more connections, and/or pumping facility, and treatment facility, all located on the property where the sanitary sewage originates; and which utilizes the individual sewerage system technology which is set forth in Chapter 7 Subchapter B of this Part, or a commercial treatment facility which is specifically authorized for use by the state health officer.

Limited Use Sewerage System—a sewerage system which may be authorized by the state health officer for installation or use for a structure or dwelling which is occupied less than four days in a week, and the use of which generates less than 100 GPD of sanitary sewage.

Manufacturer—a person who engages in the business or practice of constructing individual mechanical sewerage treatment systems, and who is responsible for having the system evaluated in compliance with §725.D of this Part.

Outfall Path—the path or course by which effluent leaving the final treatment unit of a community sewerage system or individual sewerage system reaches its ultimate receiving navigable stream or body of water.

Person—any natural person, partnership, corporation, association, governmental subdivision, receiver, tutor, curator, executor, administrator, fiduciary, or representative of another person, or public or private organization of any character.

Premises—any structure or dwelling of any construction whatsoever in which a person may live, work, or congregate.

Sanitary Sewage—any and all human waste and/or domestic waste, the disposal of which requires a sewerage system approved or authorized by the state health officer. Sanitary sewage may include its conveying liquid and/or any other liquid or solid material which may be present therein.

Secondary Treatment Standard—a sewage effluent water quality standard which prescribes a maximum 30-day average concentration of biochemical oxygen demand (5-day basis) of 30 milligrams per liter (mg/l), and a maximum daily concentration of biochemical oxygen demand (5-day basis) of 45 mg/l. The 30-day average concentration is an arithmetic mean of the values for all effluent samples collected in the sampling period. The analyses to be performed for the purpose of determining compliance with these effluent limitations and standards shall be in accordance with the eighteenth edition of the "Standard Methods for the Examination of Water and Wastewater," available from the American Public Health Association 1015 Eighteenth Street NW, Washington, D.C. 20036, except where otherwise specified.

Septic Tank System—an individual sewerage system which consists of a septic tank(s) followed by a process which treats and disposes of the septic tank effluent.

Sewerage System—any system of piping (excluding the building drain and building sewer) and/or collection and/or transport system and/or pumping facility and/or treatment facility, all for the purpose of collecting, transporting, pumping, treating and/or disposing of sanitary sewage.

Subdivision for the purpose of these regulations—

a. the division, or the process or results thereof, of any land into two or more lots, tracts, parcels, or plots, any one of which has an area of less than 3 acres; or

b. the re-subdivision of land heretofore divided into lots, tracts, sites or parcels; provided, however, that minimum lot size restrictions presented in §511.B shall not apply to:

i. a subdivision legally established and recorded prior to July 28, 1967; or

ii. a small parcel of land sold to or exchanged between adjoining property owners, provided that such a sale or exchange does not create additional lots.

c. Note: For the purpose of these regulations, the requirements for wetlands might be more stringent.

Sub-Manufacturer—a person or entity authorized by a licensed manufacturer to construct, or assemble individual sewerage systems, or any portion thereof.

Trailer Coach—any of the various forms of structures which are equipped, or capable of being equipped, with wheels, including, but not limited to, travel trailers, truck coaches or campers, mobile homes, trailers, and/or tent campers, whether capable of moving under its own power or not, and where a person or persons may live, work, or congregate.

Trailer Park—any lot, tract, parcel or plot of land upon which more than one trailer coach is or may be located, and where trailer coach spaces are rented or leased.

AUTHORITY NOTE: The first source of authority for promulgation of the sanitary code is in R.S. 36:258(B), with more particular provisions found in Chapters 1 and 4 of Title 40 of the Louisiana Revised Statutes. This Part is promulgated in accordance with R.S. 40:4(A)(6) and R.S. 40:5(A)(2)(3)(9)(20).

HISTORICAL NOTE: Promulgated by the Department of Health and Hospitals, Office of Public Health, LR 28:1343 (June 2002), amended by the Department of Health, Office of Public Health, LR 43:966 (May 2017).

Chapter 3. General Requirements for Sewerage Disposal **[formerly Chapter 13 Subpart B]**

§301. Plumbing Fixtures **[formerly paragraph 13:002]**

A. All premises shall be provided with plumbing fixtures as prescribed in Part XIV of this Code. Such plumbing fixtures shall be connected to a community sewerage system whenever feasible or to an individual sewerage system which is specifically approved for the premises by the state health officer after it is determined that connection to a community sewerage system is unfeasible and that the installation and operation of an individual sewerage system is not likely to create a nuisance or a public health hazard.

AUTHORITY NOTE: Promulgated in accordance with R.S. 40:4(A)(6) and R.S. 40:5(9)(20).

HISTORICAL NOTE: Promulgated by the Department of Health and Hospitals, Office of Public Health, LR 28:1344 (June 2002).

§303. Responsible Parties **[formerly paragraph 13:003]**

A. A person who owns, operates, manages, or otherwise controls any premises, shall provide for sewage disposal in a manner which is in compliance with this Code.

AUTHORITY NOTE: Promulgated in accordance with R.S. 40:4(A)(6) and R.S. 40:5(9)(20).

HISTORICAL NOTE: Promulgated by the Department of Health and Hospitals, Office of Public Health, LR 28:1344 (June 2002).

§305. Discharges **[formerly paragraph 13:004-1]**

A. A person shall not directly or indirectly discharge, or allow to be discharged, the contents or effluent from any plumbing fixtures, vault, privy, portable toilet, or septic tank, into any road, street, gutter, ditch, water course, body of water, or onto the surface of the ground.

AUTHORITY NOTE: Promulgated in accordance with R.S. 40:4(A)(6) and R.S. 40:5(9)(20).

HISTORICAL NOTE: Promulgated by the Department of Health and Hospitals, Office of Public Health, LR 28:1344 (June 2002).

§307. Installation **[formerly paragraph 13:004-2]**

A. No component part of a sewerage system shall be installed wherever contamination of a ground water supply may occur. The location of any sewerage facility shall not conflict with the placement requirements for a water well which are set forth in Part XII of this Code.

AUTHORITY NOTE: Promulgated in accordance with R.S. 40:4(A)(6) and R.S. 40:5(9)(20).

HISTORICAL NOTE: Promulgated by the Department of Health and Hospitals, Office of Public Health, LR 28:1344 (June 2002).

§308. Outfall Paths

A. In reviewing plans and specifications for a proposed community sewerage system or individual sewerage system, or modifications thereto, the state health officer shall require the system owner to provide evidence of appropriate servitudes or permissions for any portion of the outfall path lying between the boundaries of the system owner's property and the first suitable publicly maintained ditch, canal, or channel forming part of the outfall path, or the ultimate receiving navigable stream or body of water, whichever is encountered first. A publicly maintained ditch, canal, or channel shall be deemed suitable for use as an outfall path unless the public or governmental body maintaining same has explicitly notified the state health officer to the contrary in writing. Notwithstanding any other provision of this code, the state health officer shall not be obligated to review or analyze the suitability or ownership of any portion of an outfall path lying downstream of its confluence with the first suitable publicly maintained ditch, canal, or channel forming a part thereof.

AUTHORITY NOTE: Promulgated in accordance with R.S. 40:4(A)(6) and R.S. 40:5(A)(2)(3)(9)(20).

HISTORICAL NOTE: Promulgated by the Department of Health, Office of Public Health, LR 43:967 (May 2017).

§309. Previous Permits
[formerly paragraph 13:005]

A. Any permits issued, or approval of plans and specifications granted prior to the effective date of the 1998 revisions of this Part shall remain in effect as it relates to the design of the sewerage system, unless the state health officer determines there exists a need for revision of such permits or approvals.

AUTHORITY NOTE: Promulgated in accordance with R.S. 40:4(A)(6) and R.S. 40:5(9)(20).

HISTORICAL NOTE: Promulgated by the Department of Health and Hospitals, Office of Public Health, LR 28:1344 (June 2002).

Chapter 5. Community Sewerage Systems
[formerly Chapter 13 Subpart C]

§501. Permits
[formerly paragraph 13:006]

A. A person shall not construct or operate a community sewerage system, or make a modification of an existing system which changes the system's capacity, effluent quality, point of discharge, hydraulic or contaminant loadings, or operation of the component units of the system without having first obtained a permit from the state health officer. No community sewerage system shall be constructed, or modified to the extent mentioned above, except in accordance with plans and specifications for installation which have been approved as a part of a permit issued by the state health officer prior to the start of construction or modification.

AUTHORITY NOTE: Promulgated in accordance with R.S. 40:4(A)(6) and R.S. 40:5(9)(20).

HISTORICAL NOTE: Promulgated by the Department of Health and Hospitals, Office of Public Health, LR 28:1344 (June 2002).

§503. Plans
[formerly paragraph 13:007]

A. Detailed plans and specifications for the construction or modification of a community sewerage system for which a permit is requested shall be submitted by the person who is the owner, his legal agent or who has responsible charge of the facilities. The review and approval of plans and specifications submitted for issuance of a permit will be made in accordance with the design standards presented in "Recommended Standards for Sewage Works," 1990 Edition, promulgated by the Great Lakes and Upper Mississippi River Board of State Sanitary Engineers and available from Health Education Service, P.O. Box 7126, Albany, New York 12224. Proposals which deviate significantly from the standards must be submitted to the state health officer with supporting documentation.

AUTHORITY NOTE: Promulgated in accordance with R.S. 40:4(A)(6) and R.S. 40:5(9)(20).

HISTORICAL NOTE: Promulgated by the Department of Health and Hospitals, Office of Public Health, LR 28:1344 (June 2002).

§505. Operation and Maintenance
[formerly paragraph 13:008-1]

A. All component facilities of a community sewerage system shall, at all times, be maintained in the same configuration as permitted, in working order and operated efficiently to minimize upsets, discharges of excessive pollutants, bypassing of discharges from the system, and health hazards and nuisances. Operator staffing and training, laboratory and process controls, maintenance during normal periods of equipment downtime, backup equipment, and spare parts shall be provided as needed to maintain continuous compliance with the effluent limitations and standards established for the facility by the state health officer and to avoid any bypass or any overflow from the system.

B. [Formerly paragraph 13:008-2] Community sewerage systems shall be operated and maintained so as to consistently produce effluent water quality meeting the minimum requirements of the secondary treatment standard. Additional effluent standards may be established by the state health officer as needed based upon downstream uses of receiving waters.

C. [Formerly paragraph 13:008-3] The bypass of any raw or partially treated sewage from a community sewerage system is prohibited, except where unavoidable to prevent a potential threat to Public Health and Safety or severe property damage, and where no feasible alternatives to bypass exist. The use of alternatives to bypassing, such as auxiliary treatment facilities, retention of untreated wastes, maintenance during normal periods of equipment downtime, or installation of adequate backup equipment shall be utilized to the maximum extent feasible to avoid bypassing.

AUTHORITY NOTE: Promulgated in accordance with R.S. 40:4(A)(6) and R.S. 40:5(9)(20).

HISTORICAL NOTE: Promulgated by the Department of Health and Hospitals, Office of Public Health, LR 28:1345 (June 2002).

§507. Records
[formerly paragraph 13:009]

A. By request, copies of reports and suitable daily analyses and records of daily operations shall be submitted monthly to the state health officer.

AUTHORITY NOTE: Promulgated in accordance with R.S. 40:4(A)(6) and R.S. 40:5(9)(20).

HISTORICAL NOTE: Promulgated by the Department of Health and Hospitals, Office of Public Health, LR 28:1345 (June 2002).

§509. Land Application
[formerly paragraph 13:010]

A. No sewage sludge, or sewage treatment effluent shall be applied to land for treatment, disposal, irrigation or other purposes without a permit from the state health officer. The Louisiana Department of Environmental Quality should also be contacted regarding other approvals or permits required by that agency for land application projects.

AUTHORITY NOTE: Promulgated in accordance with R.S. 40:4(A)(6) and R.S. 40:5(9)(20).

HISTORICAL NOTE: Promulgated by the Department of Health and Hospitals, Office of Public Health, LR 28:1345 (June 2002).

§511. General Requirements
[formerly paragraph 13:011-1]

A. Connections to Community Sewerage Systems. Where an established community sewerage system (either public or private) is available, and there is ample water supply, all plumbing fixtures within any structure shall be connected to such community sewerage system. Determination by the state health officer of the availability of a community sewerage system shall take into consideration, among other aspects, the separation (both horizontal and vertical) of the structure in question and the sewer main or lateral, political or geographic or legally created boundaries, and the available capacity of the sewer system.

B. [Formerly paragraph 13:011-2] Community Sewerage System Required. Community sewerage systems shall be provided for all new subdivisions and developments where lots are sold or leased. The developer/owner shall be responsible for the provision of adequate sewage treatment and disposal. The use of individual sewerage systems in lieu of a community sewerage system may be authorized and will be considered under the following circumstances.

1. In subdivisions comprised of less than 125 lots, when the developer submits a comprehensive drainage plan as well as a proposal for restrictive covenants which detail requirements for perpetual maintenance of drainage. This requirement shall apply for all new subdivisions and developments.

2. When the total anticipated design flow to the sewerage system does not exceed 1,500 gpd, and where no food service is involved as per §1301.A.2.

3. On large lots, where an area of one acre or more is involved, having a minimum frontage of 125 feet.

4. The installation would be located on a lot, plot or site which has a minimum area of 22,500 square feet, and a minimum frontage of 125 feet.

5. For subdivisions when each and all lots have a minimum area of at least 22,500 square feet and a minimum frontage of 125 feet, except that the 125 foot frontage requirement may be waived for up to 15 percent of the total number of lots in the development if:

a. minimum frontage on each lot in question is not less than 60 feet, and;

b. the width of each lot in question is at least 125 feet.

6. For parishes in which the parish governing authority has enacted and enforces a formal sewage permitting system (requiring approval of individual sewage disposal systems by the state health officer prior to issuance of any parish permits) and when the lots or sites in question meet any of the following criteria:

a. minimum area of 22,500 square feet and a minimum frontage of 80 feet;

b. minimum area of 16,000 square feet and a minimum frontage of 80 feet where an approved individual mechanical plant is to be utilized;

c. minimum area of 12,000 square feet and a minimum frontage of 60 feet where an approved individual mechanical plant is utilized and is followed by 50 feet of modified absorption field (see Chapter 7 Subchapter B, §733.A).

7. Where lots of "record" (i.e., lots created by formal subdivision prior to July 28, 1967) are combined (in accord with the definition of a subdivision) to create a new, larger, single lot, and no re-subdivision of the property is involved. On July 20, 2002 and thereafter, in no case shall the newly created lots have less than 50 feet of frontage or be less than 5,000 square feet in area.

8. For single lots or sites, regardless of size, remaining in substantially developed previously established subdivisions, when, in the opinion of the state health officer, a hazard to the public health will not result.

9. For single lots or sites, regardless of size, when the installation of an individual sewerage system is proposed in order to renovate or replace a pre-existing sewerage system. Such installation may be allowed when, in the opinion of the state health officer, a public health hazard or nuisance will not result. This provision shall apply to the renovation or replacement of pre-existing systems only and shall not be utilized to circumvent other requirements, particularly those relative to minimum lot size for new residences and subdivision development, of this code.

C. [Formerly paragraph 13:011-3] Effective October 20, 2000, this rule applies to new individual sewerage system installations, upgrades and/or modifications to existing systems required as a result of an investigation by the Office of Public Health (OPH) into an allegation that a violation of Part XIII of the Louisiana sanitary code has occurred or is occurring, and has the potential for causing harm or creating a nuisance to the general public (R.S. 40:1154). Such individual sewerage systems with a capacity up to and including 1,500 gpd, that produce treated effluent, and which, by design, do not significantly reduce the amount of off-site effluent, shall be followed by an effluent reduction system constructed as described in Chapter 7 Subchapter B, §§731 and 733 of this Part.

D. [Formerly paragraph 13:011-4] The state health officer may consider for approval, on an individual basis, proposals for developments that are of a unique nature, such as a development over water, or irregular configuration, where individual sewage disposal is proposed, where the development, by its very nature (e.g., where commonly or jointly owned property is involved), is clearly not addressed by the current considerations of this Code.

AUTHORITY NOTE: Promulgated in accordance with R.S. 40:4(A)(6), R.S. 40:5(9)(20), and R.S. 40:1154(A).

HISTORICAL NOTE: Promulgated by the Department of Health and Hospitals, Office of Public Health, LR 28:1345 (June 2002), amended LR 28:1591 (July 2002).

Chapter 7. Individual Sewerage Systems [formerly Chapter 13 Subpart D]

Subchapter A. General Requirements

§701. Permits

[formerly paragraph 13:012-1]

A. A person shall not install, cause to be installed, alter subsequent to installation, or operate an individual sewerage system of any kind without first having obtained a permit from the state health officer. No person shall install, cause to be installed, or alter subsequent to installation an individual sewerage system of any kind except in accordance with the plans and specifications for the installation which have been approved as a part of a permit issued by the state health officer. Such permits shall be issued in a two-stage process in accordance with §701.B and C.

B. [Formerly paragraph 13:012-2] Upon receipt of a request for such permit, and approval of plans and specifications for the proposed individual sewerage system (which shall accompany any such request for permit), a temporary permit, authorizing the installation of said system, may be issued. Any such temporary permit shall be in writing and shall not be issued until, with respect to the property and its surroundings, the state health officer has determined that connection to a community-type sewerage system is not feasible, and that the condition of the soil, drainage patterns, the lot size/dimensions, and other related factors are such that the construction and use of properly designed individual sewerage facilities are not likely to create a nuisance or public health hazard.

C. [Formerly paragraph 13:012-3] A final permit approving the installation, shall be issued only upon verification that the individual sewerage system has been installed in compliance with this code. The verification of such installation shall be determined by means of an on-site inspection conducted by a representative of the state health officer and/or in the form of a completed "Certification by Installer" form submitted to the state health officer by the licensed installer. The installer shall notify the appropriate local Parish Health Unit prior to the installation of an individual sewerage system. The sanitarian shall not issue final approval for this system unless he/she has received a completed and signed certification by installer form. The certification by installer shall be submitted to the state health officer within 15 days after completion of the installation. A final permit shall be issued and provided to the owner/occupant of the premises to be served by the individual sewerage system.

D. [Formerly paragraph 13:012-4] If a consumer currently owns, is contemplating purchasing and having installed, or is an installer of Individual Mechanical Sewage Treatment Plants, that consumer should be made aware that:

1. it has become apparent that the electrical components of Individual Mechanical Sewage Treatment Plants which require connection to a source of electricity may not be properly connected to that electrical source in some cases. Specifically, mechanical sewage treatment plants, using

electrical power may require a properly installed Ground Fault Current Interrupter (GFCI);

2. the Office of Public Health has specific statutory authority and mandates to protect the public health from the improper treatment and disposal of sewage. This office will offer the public consultation with regard to the appropriate sewage treatment system that should be used in a specific application, considering system design for properly treating sewage, sizing for the number of people using the system, location of the system, and other health considerations, as necessary. However, the Office of Public Health does not have the authority to inspect or approve electrical connections, are not qualified in the area of such electrical connections and will not assume responsibility for such electrical safety considerations;

3. accordingly, proper electrical connections must be made to the air pump/blower and/or any other electrical components that are integral parts of an individual mechanical sewage treatment plant, and that a qualified electrician should perform or examine the installation(s) for appropriate wiring and installation, as well as the connection to the ground fault current interrupter.

E. [Formerly paragraph 13:012-5] Permits for the installation of individual sewerage systems shall not be issued for lots within a formal subdivision unless an official recorded plat/property survey has been filed with and subsequently approved for use of individual sewerage systems by the Office of Public Health.

AUTHORITY NOTE: Promulgated in accordance with R.S. 40:4(A)(6) and R.S. 40:5(9)(20).

HISTORICAL NOTE: Promulgated by the Department of Health and Hospitals, Office of Public Health, LR 28:1346 (June 2002).

§703. Plans

[formerly paragraph 13:013-1]

A. The review and approval of plans and specifications for the proposed individual sewerage system shall be made in accordance with the "Regulations Controlling the Design and Construction of Individual Sewage Systems" (See Chapter 7, Subchapter B).

B. [Formerly paragraph 13:013-2] Individual sewerage systems, other than conventional septic tank systems, i.e., septic tanks followed by a subsurface disposal system, including those facilities built in conflict with the state of Louisiana sanitary code, shall comply with all provisions of the Louisiana Department of Environmental Quality Wastewater Discharge Permit. The Louisiana Department of Environmental Quality should be contacted for information regarding wastewater discharge permits. The state health officer may establish other limitations or standards, as needed, in consideration of the water quality of affected surface water bodies and groundwaters.

AUTHORITY NOTE: Promulgated in accordance with R.S. 40:4(A)(6) and R.S. 40:5(9)(20).

HISTORICAL NOTE: Promulgated by the Department of Health and Hospitals, Office of Public Health, LR 28:1347 (June 2002).

§705. Installation of Individual Sewerage Systems
[formerly paragraph 13:014-1]

A. A person who wishes to engage in the business of installing or providing maintenance of individual sewerage systems shall obtain, in accordance with the procedures set forth in §737 of this Part, a license for such activity prior to making any such installations or providing maintenance. Such a license shall not be required, however, for an individual wishing to install an individual sewerage system, other than an individual mechanical plant, for his own private, personal use. Individual mechanical plants shall be installed and maintenance provided by licensed individual sewerage system installers and/or maintenance providers only.

B. [Formerly paragraph 13:014-2] A person installing or providing maintenance of an individual sewerage system and the person who is the owner of the premises shall be responsible for compliance with §§701 and 703.

AUTHORITY NOTE: Promulgated in accordance with R.S. 40:4(A)(6) and R.S. 40:5(9)(20).

HISTORICAL NOTE: Promulgated by the Department of Health and Hospitals, Office of Public Health, LR 28:1347 (June 2002).

§707. Maintenance and Operation
[formerly paragraph 13:015]

A. Individual sewerage systems shall be kept in service and in a serviceable condition sufficient to insure compliance with this code and in order to avoid creating or contributing to a nuisance or a public health hazard.

AUTHORITY NOTE: Promulgated in accordance with R.S. 40:4(A)(6) and R.S. 40:5(9)(20).

HISTORICAL NOTE: Promulgated by the Department of Health and Hospitals, Office of Public Health, LR 28:1347 (June 2002).

§709. Septic Tank Systems
[formerly paragraph 13:016]

A. Where a community-type sewerage system is not available, a septic tank system may be used provided that the requirements of §§511.B, 701, 703.A, and 705 are complied with.

AUTHORITY NOTE: Promulgated in accordance with R.S. 40:4(A)(6) and R.S. 40:5(9)(20).

HISTORICAL NOTE: Promulgated by the Department of Health and Hospitals, Office of Public Health, LR 28:1347 (June 2002).

§711. Individual Mechanical Plants
[formerly 13:017-1]

A. An individual mechanical plant may be used where a community-type system is not available, and where the state health officer determines that a conventional septic tank system (septic tank-absorption field) would not be expected to function properly, and where the requirements of §§511.B, 701, 703.B, and 705 are complied with.

B. [Formerly paragraph 13:017-2] Permits, per the requirements of §701, for the installation of individual mechanical plants, shall not be issued except and unless the manufacturer of the mechanical plant has received a manufacturers license in accordance with the requirements of

§735.A, and has received appropriate certification from DHH/OPH.

AUTHORITY NOTE: Promulgated in accordance with R.S. 40:4(A)(6) and R.S. 40:5(9)(20).

HISTORICAL NOTE: Promulgated by the Department of Health and Hospitals, Office of Public Health, LR 28:1347 (June 2002).

§713. Other Individual Sewerage Systems
[formerly paragraph 13:018-1]

A. Where a person proposes innovative processes or design features other than those described in Chapter 7 Subchapter B of this Part, a limited number of experimental or developmental installations may be approved where: either failure of the installation or insignificant benefits to performance and cost is not expected, based on current engineering data and literature. The total number of such installations shall not exceed three throughout the state and shall be approved under the following conditions.

B. [Formerly paragraph 13:018-2] Each installation shall be installed only in accordance with plans and specifications and testing procedures which have been specifically approved for each installation as a part of a permit issued by the state health officer prior to the installation.

C. [Formerly paragraph 13:018-3] The permit for each installation shall be for a period of one year and may be renewed under the provisions of §713.

D. [Formerly paragraph 13:018-4] Should an innovative process fail, the owner of the premises and the person proposing the innovative process shall upgrade or replace the installation to bring it into compliance with the applicable provisions of this Part.

E. [Formerly paragraph 13:018-5] After the experimental or developmental use of an installation is completed, the permit issued under this Section may be revised to remove the restrictions cited in Subsections 713.B and C if the state health officer determines that the available data show that continued use of the installation will not result in non-compliance with applicable provisions of this Chapter. Such a revision of a permit issued under §713 shall apply only to the individual installation approved under that permit, and should not be construed as being an approval of the system design for other existing or future installations.

F. [Formerly paragraph 13:018-6] Proprietary Devices. Proprietary devices are all devices designed to reduce, process, and treat all or a select portion of wastewater generated within the individual home. This includes water recycle and reuse devices, water conservation devices, composting units, and other devices intended to reduce the volume of waste generated or water consumed. The approval of a proposal to utilize a proprietary device may only be granted by the state health officer.

AUTHORITY NOTE: Promulgated in accordance with R.S. 40:4(A)(6) and R.S. 40:5(9)(20).

HISTORICAL NOTE: Promulgated by the Department of Health and Hospitals, Office of Public Health, LR 28:1347 (June 2002).

Subchapter B. Design and Construction Regulations [formerly Chapter 13 Appendix A]

§715. Septic Tanks

[formerly Section I of Appendix A]

A. [Formerly paragraph A:1.1 of Appendix A] A septic tank is a watertight tank made of steel, concrete or other approved materials in which the settleable solids of sewage settle out and are largely changed into liquids or gases by bacterial decomposition. The remaining residue in the tank is a heavy, black semi-liquid sludge which must be removed from the tank periodically. Although the completely digested sludge contains relatively few disease germs, in cleaning the tank it is impossible to remove the digested sludge without removing some undigested material. Therefore, it is particularly important that the removed sludge be disposed of in a safe manner. There are commercial service companies that will contract for septic tank cleaning and sludge disposal. Such commercial services are controlled by a permit system in accordance with §901 of this Part.

B. [Formerly paragraph A:1.2 of Appendix A] Multiple compartment septic tanks or single chamber septic tanks in series provide more effective treatment than single chamber tanks of the same total capacity; therefore, the use of multiple compartment tanks or single tanks in series is encouraged. However, single chamber septic tanks are acceptable.

C. [Formerly paragraph A:1.3 of Appendix A] The velocity of flow through the tanks must be such that maximum solids and scum retention is achieved. Vertical cylindrical tanks must have horizontal (inlet-to-outlet) separation of at least 24 inches.

1. Tees or baffles must be used at the inlet. The outlet must be designed so as to preclude floating solids from escaping from the tank. The inlet tee or baffle diverts the incoming sewage toward the bottom of the tank without disturbing the scum which forms on the surface of the liquid, and the outlet prevents the surface scum from flowing out of the tank.

D. [Formerly paragraph A:1.4 of Appendix A] The minimum total septic tank liquid capacity required is 2 1/2 times the estimated average daily design flow. Sewage loading criteria for determining the average daily design flow and organic loading are contained in Chapter 15 of this Part. One-bedroom residences may, however, utilize a 500 gallon tank.

NOTE: The minimum allowable total septic tank volume for all applications is 500 gallons.

E. [Formerly paragraph A:1.5 of Appendix A] The distance between the inlet and outlet openings in the tank wall, measured horizontally, shall be not less than 24 inches. The distance between the inlet and outlet shall exceed the width of rectangular and oval-shaped tanks.

F. [Formerly paragraph A:1.6 of Appendix A] The tank shall operate with a liquid depth between a minimum of 30 inches and a maximum of 72 inches measured vertically from the invert of the outlet (overflow level) to the bottom of the tank. Recent septic tank studies have indicated the shallower tank to be more efficient and is therefore preferred.

G. [Formerly paragraph A:1.7 of Appendix A] For tanks having straight vertical sides, the dimension between the top of the tank and the liquid level shall not be less than 15 percent of the liquid depth. In horizontal cylindrical tanks, the volume of the air space above the liquid shall not be less than 15 percent of the liquid capacity. In the latter case, this condition is met if the liquid depth (distance from outlet invert to bottom of tank) is at least 79 percent of the diameter of the tank.

H. [Formerly paragraph A:1.8 of Appendix A] A single tank may be divided into two or more compartments by means of internal partitions. Each compartment shall conform to the dimensions limitations for complete tanks and shall have a liquid capacity of at least 250 gallons. The total liquid capacity shall conform to the requirements for single chamber tanks. No tanks shall have more than three compartments.

I. [Formerly paragraph A:1.9 of Appendix A] The tank shall be constructed of materials which are corrosion resistant and provide a watertight permanent structure. The cover of the tank shall be designed for a dead load of not less than 150 pounds per square foot. Concrete covers must be reinforced with steel and must be not less than 4 inches thick. Metal septic tanks shall comply with the requirements of §715.O. Tanks of other materials such as fiberglass will be reviewed for acceptance on an individual basis. They will be required to comply generally with the basic applicable standards for metal septic tanks.

J. [Formerly paragraph A:1.10 of Appendix A] Access to the septic tank for cleaning and inspection shall be provided by a removable cover or manhole. Both inlet and outlet devices as well as each compartment in multiple compartment tanks must be accessible. Manholes, when used shall be at least 20 inches square or 24 inches in diameter and provided with covers which can be sealed watertight. Septic tanks with removable covers must be provided with an 8-inch inspection hole over the inlet and the outlet.

K. [Formerly paragraph A:1.11 of Appendix A] Either tees or baffles shall be provided at the inlet of the tank and shall extend upward at least 6 inches above the liquid level of the tank. The inlet tee or baffle shall extend downward to at least 6 inches below the liquid level, but it shall not extend below the level of the lower end of the outlet tee or baffle. At least 2 inches of open space shall be provided above the baffle or tee to provide ventilation to the tank through the building plumbing system.

L. [Formerly paragraph A:1.12 of Appendix A] On the outlet side the tee or baffle shall extend downward to a distance below the water surface equal to 40 percent of the liquid depth of tanks with vertical sides and 35 percent of liquid depth of tanks of other shapes as measured to the nearest inch. If a tee or baffle is used in the outlet the upper end shall extend 6 inches above the liquid level.

M. [Formerly paragraph A:1.13 of Appendix A] Inlet and outlet fittings (tees or ells) must be of cast iron, schedule 40 PVC or ABS plastic or other approved material.

N. [Formerly paragraph A:1.14 of Appendix A] The invert of the inlet shall be located at least 2 inches above the invert of the outlet.

O. [Formerly paragraph A:1.15 of Appendix A] Metal septic tanks shall be prefabricated of a minimum of 14 gauge commercial grade steel. Corrosion protection shall, at a minimum, consist of a hot-dipped asphalt coating of at least 0.025-inch thickness properly applied to all surfaces of the new, clean, bare metal.

P. [Formerly paragraph A:1.16 of Appendix A] The location of a septic tank shall comply with minimum distance requirements from water wells, water lines, etc. as contained in Part XII, of this Code.

Q. [Formerly paragraph A:1.17 of Appendix A] The use of septic tanks in series is encouraged. The first tank shall have at least a 500-gallon liquid capacity and all subsequent tanks shall have at least 300-gallon liquid capacities. The total capacity of all tanks in series must comply with the capacities for septic tanks as prescribed in §715.D.

R. [Formerly paragraph A:1.18 of Appendix A] Piping from the house to the septic tank must be such that the waste flow does not disturb the retention of scum and sludge in the tank. To attain this, the inlet piping from the house must have a minimum diameter of four inches and be laid on a slope of at least 1/8 inch per foot. The slope for the last 10 feet of line preceding the septic tank must not exceed 1/4 inch per foot. All plastic piping, excluding perforated pipe, must be a minimum of SDR 35 sewer and drainage pipe or equivalent.

S. [Formerly paragraph A:1.19 of Appendix A] Backfill around septic tanks must be made in thin layers thoroughly tamped in a manner that will not produce undue strain on the tank. Sufficient soil cover can be provided over the top of the septic tank to permit grass growth. However, no other obstruction to access (i.e., concrete slabs, buildings, etc.) shall be allowed.

T. [Formerly paragraph A:1.20 of Appendix A] Septic tanks should be inspected every six years and pumped at least every eight years by a licensed sewage hauler.

U. [Formerly paragraph A:1.21 of Appendix A] Untreated or uncoated metal septic tanks shall not be used.

V. [Formerly paragraph A:1.22 of Appendix A] Abandoned septic tanks (tanks no longer in active use) shall be pumped out by a licensed sewage hauler, then removed or the cover discarded and the tank filled with soil to natural grade. The

contents of the abandoned tank shall not be placed into a newly installed individual sewerage system.

AUTHORITY NOTE: Promulgated in accordance with R.S. 40:4(A)(6) and R.S. 40:5(9)(20).

HISTORICAL NOTE: Promulgated by the Department of Health and Hospitals, Office of Public Health, LR 28:1348 (June 2002).

§717. Septic Tank Effluent [formerly Section II of Appendix A]

A. [Formerly paragraph A:2.1 of Appendix A] There is a common belief that sewage after treatment in a septic tank is pure water, or very nearly so. This is false. The effluent or liquid flowing from the tank is still foul and dangerous. The septic tank cannot be depended upon to remove disease germs. The discharge of the effluent from septic tanks into street gutters, surface ditches, or streams is prohibited.

B. [Formerly paragraph A:2.2 of Appendix A] The treatment level of a septic tank is referred to as primary treatment.

C. [Formerly paragraph A:2.3 of Appendix A] The preferred method of treatment for septic tank effluents is accomplished through the use of soil absorption trenches. Small oxidation ponds or sand filter beds may be used in lieu of absorption trenches only where soil and drainage conditions or available space prevent the use of absorption trenches. The level of treatment of these units is referred to as secondary treatment.

D. [Formerly paragraph A:2.4 of Appendix A] The use of absorption trenches, oxidation ponds and filter beds for the treatment of septic tank effluents is discussed in detail in the following Paragraphs of these standards.

AUTHORITY NOTE: Promulgated in accordance with R.S. 40:4(A)(6) and R.S. 40:5(9)(20).

HISTORICAL NOTE: Promulgated by the Department of Health and Hospitals, Office of Public Health, LR 28:1349 (June 2002).

§719. Absorption Trenches [formerly Section III of Appendix A]

A. [Formerly paragraph A:3.1 of Appendix A] Where soil conditions are satisfactory and sufficient land is available, septic tank effluent shall be disposed of in absorption trenches. This consists of a system of covered gravel (or other approved aggregate) filled trenches into which the septic tank effluent is applied so as to permit the liquid to seep into the soil. By action of microorganisms in the soil, the organic matter is converted into mineral compounds.

B. [Formerly paragraph A.3.2 of Appendix A] A number of variables determine whether an absorption trench is feasible, including: soil porosity (permeability), ground water table, available space, and the rate at which septic tank effluent enters the soil (percolation rate). In general three conditions should be met.

1. The soil percolation rate must be within the acceptable range.

2. The maximum elevation of the ground water table should be at least 2 feet below the bottom of the proposed trench system.

3. Clay formations or other impervious strata should be at a depth greater than 4 feet below the bottom of the trenches.

C. [Formerly paragraph A.3.3 of Appendix A] Unless these conditions are satisfied, the site is unsuitable for a subsurface sewage disposal system, and an alternative method must be utilized.

D. [Formerly paragraph A.3.4 of Appendix A] The acceptability of soil for an absorption trench system and the required size of such a system is currently based upon the "Percolation Test" described below.

1. Three or more tests must be made in separate test holes spaced uniformly over the proposed absorption field site.

2. Dig or bore a hole, with horizontal dimensions of from 4 to 12 inches and vertical sides to the depth of the proposed absorption trench. In order to save time, labor, and volume of water required per test, the holes may be bored with a 4-inch auger.

3. Carefully scratch the bottom and sides of the hole with a knife blade or sharp-pointed instrument in order to remove any smeared soil surfaces and to provide a natural soil interface into which water may percolate. Remove all loose material from the hole.

4. To conduct the test, fill the hole with clear water. This pre-wetting procedure should normally be accomplished on the day prior to the percolation rate measurement. This procedure is to insure that the soil is given ample opportunity to swell and to approach the operating condition of the wet season of the year. Thus, the test should give comparable results in the same soil whether made in a dry or in a wet season.

5. With the exception of sandy soils, percolation rate measurements shall be made on the day following the procedure described under §719.D.4 above. Add water until the liquid depth is at least 6 inches, but not more than 12 inches from a fixed reference point. Measure the drop in water level over a 60-minute period. This drop is used to calculate the percolation rate. Section 1501.B.1 (Figure 1) shows methods of percolation rate measurement. If the drop in liquid depth in the first 30 minutes is less than one inch, it is unnecessary to continue the test for the full 60-minute period.

6. The distance the water falls in 60 minutes in each of the three test holes is recorded. The average drop for the three holes is used to determine the total length of absorption trench from Table 1 below.

Table 1 Absorption Trench Length Requirements for Individual Residences	
Average Water Level Drop in 60 minutes (in inches)	Length (in Feet) of Absorption Trenches Required per Bedroom*
More than 12	72
12	83
11	87
10	91

9	96
8	100
7	104
6	110
5	117
4	127
3	142
Less than 3	Not acceptable for absorption field

NOTE: A minimum of 160 linear feet of field line shall be provided.

*-or per 150 gpd of design flow for non-residential applications.

E. [Formerly paragraph A:3.5 of Appendix A] Many different designs may be used in laying out an absorption trench system. The choice will depend on the size and shape of the available disposal area, the capacity required and the topography of the area.

F. [Formerly paragraph A:3.6 of Appendix A] The septic tank effluent is applied to the absorption field through a system of level bottomed trenches. Conventional field lines are laid on a slope of 2 to 3 inches per 100 feet. Gravelless pipe and other distribution chambers must be laid as close as possible to a slope of 1 inch per 100 feet. A distribution box may be required for equal distribution of the effluent. Section 1501.B.2 and 3 (Figure 2 and 3) show a typical layout of a conventional absorption trench system for flat and sloping areas.

G. [Formerly paragraph A:3.7 of Appendix A] To provide the minimum required backfill depth and earth cover, the depth of the absorption trenches must be a minimum of 18 inches. Additional depth may be needed for contour adjustment for extra backfill under the distribution line or for other design purposes. However, the total depth must not exceed 24 inches.

H. [Formerly paragraph A:3.8 of Appendix A] Careful construction is important in obtaining a satisfactory soil absorption system. Section 1501.B.4 (Figure 4) shows details for absorption trench construction.

I. [Formerly paragraph A:3.9 of Appendix A] Individual trenches shall not be greater than 100 feet in length and not less than 18 inches in width. The center line distance between individual trenches shall be at least 6 feet. In addition, the absorption trenches shall be located at least 10 feet from any dwelling or property line.

J. [Formerly paragraph A:3.10 of Appendix A] The location of the absorption trenches shall comply with minimum distance requirements from water wells, water lines, etc., as contained in Part XII of this Code.

K. [Formerly paragraph A:3.11 of Appendix A] In every case, at least two trenches shall be used.

L. [Formerly paragraph A:3.12 of Appendix A] Trench bottoms must be level to promote even distribution, thereby minimizing premature failure of a portion of the trench. During excavation, attention must be given to the protection of the soil. Care must be taken to prevent sealing of the surface on the bottom and sides of the trench. Trenches should not be excavated when the

soil is wet enough to smear or compact easily. All smeared or compacted surfaces must be raked to a depth of 1 inch and loose material removed before the backfill is placed in the trench.

M. [Formerly paragraph A:3.13 of Appendix A] Conventional field lines shall consist of perforated non-metallic pipe meeting one of the following standards.

PVC sewer pipe and fittings (Thin wall), ASTM D2729-93
Smooth wall polyethylene (PE) pipe, ASTM F810-93, for use in waste disposal absorption fields;
SRP pipe and fittings, ASTM D2852-93.

1. In every case, the minimum acceptable diameter is 4 inches. Although the trench bottom is level, conventional field pipes must be laid on a slope of between 2 to 3 inches per 100 feet to provide even distribution of the liquid throughout the trench.

N. [Formerly paragraph A:3.14 of Appendix A] Where conventional field pipe is used, it must be surrounded by clean graded gravel or rock, broken, hard-burned clay brick or similar material. The bed material may range in size from 1/2 inch to 2.5 inches. The gravel must extend from at least 2 inches above the top of the pipe to at least 6 inches below the bottom of the pipe. The top of the stone should be covered with either untreated building paper, or similar pervious material to prevent the gravel from becoming clogged by the earth backfill [see §1501.B.4 (Figure 4)].

O. [Formerly paragraph A:3.15 of Appendix A] Where gravelless pipe or distribution chambers are used, the fill must be porous soil or sand which allows the passage of water in all directions with a 6-inch layer below the pipe and filled 4 to 6 inches above grade and spread 3 to 4 feet on either side of the trench. Only gravelless pipe or other distribution chambers specifically approved for use in Louisiana by the state health officer may be used. The total length of gravelless distribution products required is the same as for conventional absorption trenches.

P. [Formerly paragraph A:3.16 of Appendix A] For an absorption trench to work properly, it must have access to air, generally through the soil interstices of the backfill. Therefore, the absorption trench should be backfilled with 4 to 12 inches of pervious soil, hand-tamped and then overfilled with about 4 to 6 inches of earth. Care should be taken to avoid compacting of the backfill.

Q. [Formerly paragraph A:3.17 of Appendix A] All of the above listed requirements, with the exception of the protection of water supplies, are aimed at preventing absorption trench clogging and premature failure. In addition, the septic tank should be inspected every six years after installation and pumped, as necessary, to prevent solid overflow to the soil absorption system and subsequent clogging and failure.

R. [Formerly paragraph A:3.18 of Appendix A] Absorption trenches shall not be located:

1. beneath driveways, parking or other paved areas;

2. in areas that may be subjected to passage or parking of heavy equipment or vehicles, or storage of materials;

3. beneath buildings or other structures.

AUTHORITY NOTE: Promulgated in accordance with R.S. 40:4(A)(6) and R.S. 40:5(9)(20).

HISTORICAL NOTE: Promulgated by the Department of Health and Hospitals, Office of Public Health, LR 28:1349 (June 2002).

§721. Oxidation Ponds
[formerly Section IV of Appendix A]

A. [Formerly paragraph A:4.1 of Appendix A] An oxidation pond is a shallow pond designed specifically to treat sewage by natural purification processes under the influence of air and sunlight. The stabilization process consists largely of the interactions of bacteria and algae. Bacteria digest and oxidize the constituents of sewage and render it harmless and odor free. Algae utilize carbon dioxide and other substances resulting from bacterial action and through photosynthesis produce the oxygen needed to sustain the bacteria in the treatment process. During the detention period, the objectionable characteristics of the sewage largely disappear.

B. [Formerly paragraph A:4.2 of Appendix A] The minimum surface area of an oxidation pond must be no less than 400 square feet with a 4 to 5 foot average liquid depth and vertical side walls. This minimum size pond is adequate for design flows of up to 400 gallons/day (gpd). For design flows in excess of 400 gpd, the pond area must be increased to provide sufficient volume (at the 4 foot depth) to hold 30 days worth of flow (a 30-day retention period). For wastes with high BOD loadings, special consideration for increasing pond size must be given.

C. [Formerly paragraph A:4.3 of Appendix A] Section 1501.B.5 (Figure 5) shows a typical layout for a septic tank-oxidation pond system. The actual layout of any pond system will be governed to a great extent by the topography of the particular location. However, an oxidation pond must be located so as to comply with the minimum distance requirements from water wells, lines, etc., as contained in Part XII of this Code. It is also desirable for aesthetic reasons to locate it as far as possible, but at least 50 feet from any dwelling and no less than 20 feet from the property line to water's edge at normal operating line.

D. [Formerly paragraph A:4.4 of Appendix A] As mentioned, the use of the minimum surface area of 400 square feet requires that an oxidation pond be furnished with vertical side walls so that an adequate volume for treatment is provided. Section 1501.B.6 (Figure 6) shows a type of construction utilizing treated timber which under normal soil conditions is acceptable for the vertical side walls of a 20 foot by 20 foot oxidation pond with a 5 foot average water depth. Section 1501.B.7 (Figure 7) shows a similar type of construction utilizing concrete blocks. Either of these designs requires very little maintenance.

E. [Formerly paragraph A:4.5 of Appendix A] Vertical side walls must be of cypress or treated timbers or concrete blocks and so constructed as to provide a permanent structure.

F. [Formerly paragraph A:4.6 of Appendix A] Although not encouraged, a pond may be constructed with sloping sides and earthen levees. Such a design is shown in §1501.B.8 (Figure 8). The design requires a minimum surface area of 625 square feet with a 5 foot liquid depth at the center in order to achieve the required volume. The cost of this design is less than that of the vertical wall ponds referred to above, but more space is needed and routine maintenance requirements such as levee mowing are greater. The slope of the natural earth side walls must not be shallower than one-to-one (45-degree angle) [see §1501.B.8 (Figure 8)].

G. [Formerly paragraph A:4.7 of Appendix A] A septic tank must precede the oxidation pond and must comply with the septic tank requirements presented in these regulations.

H. [Formerly paragraph A:4.8 of Appendix A] The pipe from the septic tank to the pond as well as the outfall pipe from the pond must be at least 4 inches in diameter and placed at a minimum slope of 2 inches per 100 feet. The inlet must extend 4 to 6 feet horizontally into the pond and be directed downward at least 1 1/2 to 2 feet below the liquid surface level. The outlet must extend 4 to 6 feet horizontally into the pond and consist of a tee with the invert set at the operating water level of the pond. One leg of tee must be open and extend above the water level, while the down leg is extended 1 1/2 to 2 feet below the water level. The invert of the pond outlet must be lower than the pond inlet invert [see §1501.B.8 (Figure 8)]. Additionally the invert of the pond inlet must be at least 2 inches lower than the invert of the septic tank outlet.

I. [Formerly paragraph A:4.9 of Appendix A] The pond shall be enclosed by a suitable non-climbable fence to keep out children, pets and livestock. An open type fence (woven wire) is preferable because it will not restrict sunlight and air which are necessary for the treatment. The fence shall be at least 5 feet in height and be provided with a locked gate.

J. [Formerly paragraph A:4.10 of Appendix A] Abandoned oxidation ponds (ponds no longer in active use) shall be dewatered, allowed to dry and then filled with soil to natural grade.

AUTHORITY NOTE: Promulgated in accordance with R.S. 40:4(A)(6) and R.S. 40:5(9)(20).

HISTORICAL NOTE: Promulgated by the Department of Health and Hospitals, Office of Public Health, LR 28:1351 (June 2002).

§723. Sand Filter
[formerly Section V of Appendix A]

A. [Formerly paragraph A:5.1 of Appendix A] Another alternative for the secondary treatment of septic tank effluent is a deep-type sand filter bed. Treatment in a sand filter bed is accomplished by the action of microorganisms in a sand bed in which the suspended solids of the septic tank effluent have been trapped by filtration. It is important that the sand bed remain aerobic throughout the treatment process. This is accomplished by exposing the sand surface to the air as much as possible on a continuous basis. Of course, the best way this

can be done is to place no cover whatsoever over the sand bed. Since this is not aesthetically desirable for homes, a coarse gravel cover of clean, washed gravel, not to exceed 6 inches in depth over the bed is permitted. No other cover is acceptable. A filter bed system is shown in §1501.B.9 (Figure 9).

B. [Formerly paragraph A:5.2 of Appendix A] The sand filter bed is constructed by placing perforated pipe near the bottom of a rectangular area of the required size in a layer of gravel covered by a layer of coarse sand 24 inches deep. On top of this are placed distribution lines (perforated pipe) likewise encased in a layer of gravel [see §1501.B.10 (Figure 10)]. The septic tank effluent is distributed speedily in the gravel cover spreading over the top of the sand seeping slowly and vertically through the sand to the bottom layer of gravel to be carried away in the under drain line.

C. [Formerly paragraph A:5.3 of Appendix A] Sand filter beds are to be constructed with a minimum width of 12 feet and a minimum length of 25 feet. This minimum size filter bed is adequately sized for design flows of up to 400 gpd. For greater design flows, the required length shall be increased by eight feet for each additional 150 gpd or portion thereof.

D. [Formerly paragraph A:5.4 of Appendix A] The bed must be drained completely. This may require the bed to be raised above natural ground level.

E. [Formerly paragraph A:5.5 of Appendix A] To prevent sand infiltration into the underdrain, a layer of graded gravel must be placed over the underdrain line and the entire bottom of the filter bed. All gravel must be clean and washed.

F. [Formerly paragraph A:5.6 of Appendix A] Filter sand shall conform to the following standard specifications.

U.S. Sieve Size	Tyler Screen Size	% Passing (By Weight)
Number 4	Number 4	95-100
	Number 14	60-80
Number 16	Number 28	5-20
Number 50	Number 48	0-5
Number 100	Number 100	0

G. [Formerly paragraph A:5.7 of Appendix A] At least two distribution lines must be provided and they must be sloped 2 inches to 3 inches per 100 feet. The lines must be 4-inch diameter, 20-inch long farm tile, 2 feet to 3-foot lengths of vitrified clay bell-and-spigot sewer pipe laid with open joints, or perforated nonmetallic pipe meeting one of the standards cited in §719.M. The ends of the distribution lines must be half-closed [see §1501.B.10 (Figure 10)].

H. [Formerly paragraph A:5.8 of Appendix A] Underdrain pipe materials are the same as those for the distribution pipe, however, the slope must be no less than 4 inches per 100 feet.

I. [Formerly paragraph A:5.9 of Appendix A] The filter bed must be appropriately protected from surface runoff water.

J. [Formerly paragraph A:5.10 of Appendix A] The filter bed must be located no less than 10 feet from the property line.

K. [Formerly paragraph A:5.11 of Appendix A] The location of the filter bed shall comply with minimum distance requirements from water wells, water lines, etc., as contained in Part XII of this Code.

AUTHORITY NOTE: Promulgated in accordance with R.S. 40:4(A)(6) and R.S. 40:5(9)(20).

HISTORICAL NOTE: Promulgated by the Department of Health and Hospitals, Office of Public Health, LR 28:1352 (June 2002).

*Editor's Note: The address cited in §725.G has changed to:

Department of Health and Hospitals
Office of Public Health
Engineering Services Section
P.O. Box 4489
Baton Rouge, LA 70821-4489

§725. Mechanical Waste Water Treatment Plants [formerly Section VI of Appendix A]

A. [Formerly paragraph A:6.1 of Appendix A] Mechanical wastewater treatment plants are small plants capable of providing primary and secondary treatment of sanitary sewage. All are considered to be aerobic treatment units.

B. [Formerly paragraph A:6.2 of Appendix A] An individual mechanical plant will be permitted where individual sewerage systems would currently be permitted under prevailing rules as set forth in this Part of the state sanitary code. Sewage loading criteria for determining the average daily design flow and organic loading are contained in Chapter 15 of this Part.

C. [Formerly paragraph A:6.3 of Appendix A] An individual mechanical plant will be permitted in lieu of a conventional septic tank system (septic tank/absorption field) only in accordance with the provisions of §511.B of this Code, and where a conventional septic tank system could not be permitted.

D. [Formerly paragraph A:6.4 of Appendix A] Permitted individual mechanical plants shall strictly comply with National Sanitation Foundation International Standard, NSF 40-1996 for Residential Wastewater Treatment Systems (Class I Systems) as revised May 1996 and published by NSF International, P.O. Box 130140, Ann Arbor, Michigan 48113-0140 USA, and as has been approved by the American National Standards Institute, 11 West 42nd Street, New York, New York 10036 as standard ANSI/NSF 40-1996, revised May 28, 1996.

E. [Formerly paragraph A:6.5 of Appendix A] All individual mechanical plants currently approved for installation in Louisiana as of the effective date of these regulations shall not be required to meet the requirements of §725.D until March 1, 2001. Until March 1, 2001, plants shall continue to comply with the standards under which they were approved. Effective March 1, 2001, all plants shall comply with the standard as stated in §725.D.

F. [Formerly paragraph A:6.6 of Appendix A] In addition to evidence of strict compliance with NSF International Standard

NSF 40-1996 (Class I Systems), and ANSI/NSF 40-1996 (Class I Systems), as are specified in §725.D of this Code, the following Department of Health and Hospitals/Office of Public Health (DHH/OPH) requirements shall also apply.

1. Testing/Evaluation (General)

a. All certifications of individual mechanical plants shall be conducted by an American National Standards Institute (ANSI) accredited certification program testing/evaluation facility authorized for such purpose(s). Verification of such certification shall be provided to DHH/OPH, subject to acceptance by DHH/OPH of such verification, as prerequisite to consideration of any individual mechanical (residential) plant for permitting in Louisiana.

b. Evidence of acceptance by DHH/OPH of an ANSI accredited testing/evaluation facility, for purpose of testing/evaluation of individual mechanical (residential) plant(s) for permitting in Louisiana shall be demonstrated upon execution of an appropriate Memorandum of Understanding (MOU), or other, similar contractual instrument, subject to terms and conditions as may be imposed by DHH/OPH—said MOU to be between DHH/OPH and the testing/evaluation facility.

c. Successful completion of testing/evaluation of an individual mechanical (residential) plant in accordance with applicable provisions of this Code, having been properly tested/evaluated and certified by an appropriate facility, shall serve to allow the DHH/OPH authorization of an individual mechanical (residential) plant for permitting purposes in Louisiana for a period not to exceed seven years from the date of such DHH/OPH authorization, or until such time as an appropriate revision to the prevailing testing/evaluation standard for such purposes may become revised. Such authorization of an individual mechanical (residential) plant for permitting purposes in Louisiana shall be in the form of a written license by DHH/OPH to a manufacturer of such individual mechanical (residential) plant(s), subject to compliance with applicable provisions of this Code—such license to be valid for the specified period, annually renewable, and suspendable/revocable by DHH/OPH in accordance with license revocation procedures as specified in §735.F.

2. Licensing

a. In addition to evidence of compliance of an individual mechanical (residential) plant having been properly tested/evaluated and certified by an appropriate facility, certain additional requirements shall serve as a basis for licensing by DHH/OPH of such individual mechanical (residential) plant in Louisiana. These additional requirements shall apply, as appropriate, to the manufacturer and/or manufacturer representative, agent, sub-manufacturer or other associated entity, as appropriate, involved in the manufacture, marketing, sale, installation and/or maintenance of such (any) individual mechanical (residential) plant(s) in Louisiana. Further,

with respect to the testing/evaluation facility which may have certified the individual mechanical plants being in compliance with the testing/evaluation standard contained herein, certain additional requirements, for licensing purposes, shall apply.

b. These additional requirements are specified as follows.

i. Testing/Evaluation Facility Responsibilities

(a). In addition to providing testing/evaluation services with respect to individual mechanical (residential) plants scheduled for manufacture, marketing, sale, installation and maintenance in Louisiana, the testing/evaluation facility shall also serve to provide oversight liaison services both to the manufacturer of the individual mechanical (residential) plant, as well as to DHH/ OPH. However, DHH/OPH communication with the testing facility will be at the OPH Program Manager level, or higher. While it is recognized that the testing/evaluation facility may exercise its fiduciary right to exact such fees or other reimbursement costs as appropriate from a manufacturer (client), under no circumstances may the testing/evaluation facility exact such fees or other reimbursement costs from DHH/OPH in order to compensate for any of these regulatory requirements. Accordingly, the following requirements shall be included in the MOU.

(b). It shall be required that all individual mechanical (residential) plant manufacturers will be inspected annually by the testing/evaluation facility having certified the related individual mechanical (residential) plant and that DHH/OPH shall be, upon request, furnished with copies of all reports of such inspections, which shall include at a minimum the verification (or re-verification) of all "forms" used in the manufacture (or sub-manufacture) of individual mechanical (residential) plants.

(c). It shall be required that a representative number, up to 4 but in, no case more than 10 percent, of all manufacturers authorized sub-manufacturers of individual mechanical (residential) plants will be inspected annually by the testing/evaluation facility having certified the related individual mechanical (residential) plant and that a report shall be retained by the testing/evaluation facility and shall, upon request by DHH/OPH, make such information available to DHH/OPH, which shall include at a minimum the verification of service records for all related individual mechanical (residential) plant installations and availability of stand-by parts.

(d). It shall be required that a representative number of installations in Louisiana, but in no case less than 10, of all individual mechanical (residential) plants manufactured by manufacturers and their respective sub-manufacturers will be inspected annually by the testing/evaluation facility having certified the related individual mechanical (residential) plant and that a report shall be retained by the testing/evaluation facility and shall, upon request by DHH/OPH, make such information available to DHH/OPH, which shall include at a minimum the verification (or re-verification) that individual mechanical (residential) plants and their respective installation(s) are in conformity with the plans and specifications as are reflected in the testing/evaluation report

which was approved for the related individual mechanical (residential) plant.

(e). It shall be required that copies of all inspection/audit reports conducted by a testing/evaluation facility with regard to a client-related manufacturer (or sub-manufacturer) of individual mechanical (residential) plants will be retained by the testing/evaluation facility and shall, upon request by DHH/OPH, make such information available to DHH/OPH upon completion of said report(s).

(f). It shall be required that copies of all reports of non-compliance and/or reports of complaint(s) investigations by a testing/ evaluation facility with respect to a client-related manufacturer (or sub-manufacturer) of individual mechanical (residential) plant(s) will be retained by the testing/evaluation facility and shall, upon request by DHH/OPH, make such information available to DHH/OPH upon completion of said report(s).

(g). It shall be required that any modification(s) to an individual mechanical (residential) plant, once certified by an ANSI accredited testing/evaluation facility, shall be subject to re-evaluation by the testing/evaluation facility and that written acceptance of the change by the ANSI accredited testing/evaluation facility shall be received by the manufacturer prior to incorporating the change; this information also to be transmitted to DHH/OPH.

(h). In the event that the original testing/evaluation facility no longer conducts testings/evaluations and certifications of individual mechanical (residential) plants for a specific manufacturer, it will be the responsibility of the testing/evaluation facility to insure an orderly transfer of the documentation supporting certification to the manufacturer for transmittal to another ANSI accredited testing/evaluation facility at the manufacturers choice.

ii. Manufacturer/Sub-Manufacturer Responsibilities

(a). In addition to other, related requirements of this code as pertain to the manufacture, marketing, sale, installation and maintenance of individual mechanical (residential) plant(s) in Louisiana, the manufacturer (or sub-manufacturer, or installer, as appropriate) of an individual mechanical plant shall also be responsible for insuring compliance with the following.

(b). It shall be required that the manufacturer/sub-manufacturer shall annually inspect at least 10 percent of its authorized installers in Louisiana of certified individual mechanical (residential) plants (products) and shall provide written reports of such inspections, which shall minimally address certain matters specified by DHH/OPH, both to the testing/evaluation facility of record as well as to DHH/OPH.

(c). It shall be required that the manufacturer/sub-manufacturer(s) installers of individual mechanical (residential) plant(s) must maintain a current

list of all sales/installations of individual mechanical (residential) plants and shall, upon request by DHH/OPH, make such information (i.e., name, address of purchaser, date of sale, etc.) available to DHH/OPH.

(d). It shall be required that manufacturers/ sub-manufacturers/installers, as appropriate must provide a minimum two-year service policy to the purchaser of each individual mechanical (residential) plant purchased/ installed at no additional cost, with verification provided to DHH/OPH and the purchaser, of such service policy provision. The initial policy shall contain provisions for four inspection/service visits (scheduled once every six months over the two-year period) during which electrical, mechanical, and other applicable components are inspected, adjusted, and serviced. The initial service policy shall also contain provisions for an effluent quality inspection consisting of a visual assessment of color, turbidity, and scum overflow, and an olfactory assessment for odor.

(e). It shall be required that the manufacturers/sub-manufacturers/installers, as appropriate must make available (subject to the purchaser's right of refusal) an extended service/maintenance agreement with terms comparable to those in the initial service policy, in writing.

(f). The manufacturer/sub-manufacturer shall insure that the individual mechanical (residential) plant and its component parts are properly and easily identified.

(g). The manufacturer/sub-manufacturer shall secure such license(s) as may be required by other, applicable provisions of this code for purpose(s) of manufacture, marketing, sale, installation and/or maintenance of individual mechanical (residential) plant(s) in Louisiana—such license(s) requirement(s) to include, at a minimum as condition of licensure, the verifiable imposition of such insurance, bonding and related requirements as may become stipulated by DHH/OPH for purpose(s) of such related business activities conducted in Louisiana.

(h). Manufacturers shall specifically authorize the ANSI accredited testing/evaluation facility to release to DHH/OPH all of the documentation outlined in terms Subclauses i.(a)-(h) above.

3. Certification

a. Licensing will be based on a two phase certification process, as follows.

i. Initial Certification. Consisting of evidence of successful completion of the herein prescribed testing of an individual mechanical (residential) plant, by the appropriate ANSI accredited testing/evaluation facility conjunctive with an actual onsite physical inspection and audit of all plant manufacturer (company) and sub-manufacturer facilities and production locations by the appropriate ANSI accredited testing facility.

ii. Continuing Certification. Consisting of evidence of an annual re-certification, re-inspection and re-audit by the ANSI accredited testing/evaluation facility of all plant manufacturers (company) and sub-manufacturer facilities and production locations, as well as an evaluation of a representative number (no less than four) of all manufacturers

authorized distributors and plants (units/models) sold and installed, with report(s) of such evidence available to DHH/OPH upon request.

G. [Formerly paragraph A:6.7 of Appendix A] Persons proposing to sell individual mechanical plants for installation in Louisiana shall submit an evaluation report indicating compliance with ANSI/NSF Standard Number 40 and obtain approval from the *Department of Health and Hospitals, Office of Public Health, P.O. Box 60630, New Orleans, LA 70160, prior to selling/installing plants in the state. The compliance evaluation report shall be prepared by an ANSI certified testing laboratory as required in §725.F, and shall include positive identification of all owners, officers, agents, stockholders, contractors, sub-contractors, as may be in any manner or by any means associated with the entity seeking a permit.

1. [Formerly paragraph A.6.7-1 of Appendix A] Upon approval of an evaluation report by the Department of Health and Hospitals, Office of Public Health, the subject individual mechanical plant may be permitted for use in Louisiana. The Office of Public Health will maintain a list of licensed Manufacturers and respective individual mechanical plants permitted for sale/installation in the state.

2. [Formerly paragraph A:6.7-2 of Appendix A] Any alteration or modification of an individual mechanical plant without the certification of the ANSI certified testing laboratory and subsequent approval of DHH-OPH shall constitute a violation of this Section and shall be grounds for suspension/revocation of any permit or license held by each person responsible for such changes, alterations or modifications.

H. [Formerly paragraph A:6.8 of Appendix A] Licenses shall remain valid subject to the following.

1. No person involved with the testing facility either directly or indirectly, may become an owner, partner, or stockholder of any company holding any license to manufacture, submanufacture, install or maintain individual mechanical treatment plants in Louisiana within two years of the approval date of said plant by the Office of Public Health.

2. Should a change of ownership occur, the manufacturer license for such plant shall be rescinded.

3. The licensed Manufacturer shall submit to the Office of Public Health, not later than January 31 of each year, proof that they have secured general liability insurance in an amount of not less than \$1,000,000.

4. The licensed Manufacturer shall be responsible for assuring that their mechanical plants are sold only to licensed submanufacturers and installers in order to prevent the installation of their plants by unauthorized persons.

I. [Formerly paragraph A:6.8-1 of Appendix A] Persons appealing the denial of their application under the Administrative Procedure Act shall post a cost bond prior to the scheduling of such hearing. The plaintiff shall

forfeit the cost bond to the state when said appeal is denied by the hearing officer. The hearing officer is to determine the amount of the cost bond, on a per diem basis. The costs shall include room rental, hearing officer fees, court reporter fees, and transcript costs.

J. [Formerly paragraph A:6.9 of Appendix A] Individual mechanical plants and all components must be installed in compliance with the minimum separation requirements for water wells and appurtenances as required in Part XII of this Code.

K. [Formerly paragraph A:6.9-1 of Appendix A] Individual mechanical plants should be installed at least 10 feet from the property line.

L. [Formerly paragraph A:6.10 of Appendix A] Determination of compliance with NSF Standard Number 40 requirements and/or additional related requirements provided for in this Subchapter shall be the responsibility and sole authority of the state health officer acting through the Office of Public Health.

M. [Formerly Part B paragraph A:6.11 of Appendix A] Warranty/Maintenance/Service Provisions

1. The "Individual Mechanical Plant Initial Warranty Inspection/Service Report" must be submitted to the state health officer after each warranty/maintenance inspection is completed by the maintenance provider, and will become part of the permanent record for each system. A maintenance contract shall be offered to the owner after the initial two-year service contract expires in accordance with National Sanitation Foundation Standard Number 40 relating to Residential Wastewater Treatment Systems, adopted by the Board of Trustees of the National Sanitation Foundation (NSF), Ann Arbor, Michigan, as revised May 1996. The maintenance provider shall notify the state health officer whenever an extended service contract has been negotiated.

2. [Formerly paragraph A:6.12 of Appendix A] The owner is responsible for perpetual maintenance of the sewerage system and components thereof. Proof of perpetual maintenance of the system shall be provided in the form of an extended service contract.

AUTHORITY NOTE: Promulgated in accordance with R.S. 40:4(A)(6) and R.S. 40:5(9)(20).

HISTORICAL NOTE: Promulgated by the Department of Health and Hospitals, Office of Public Health, LR 28:1352 (June 2002).

*Editor's Note: The address cited in §727.C has changed to:

Department of Health and Hospitals
Office of Public Health
Engineering Services Section
P.O. Box 4489
Baton Rouge, LA 70821-4489

§727. Sanitary Pit Privy
[formerly Section VII of Appendix A]

A. [Formerly paragraph A:7.1 of Appendix A] Where a dwelling is not served with water under pressure, water carriage waste systems as covered herein can not be used. In these cases, a pit privy or other non water-borne system is required for excreta disposal.

B. [Formerly paragraph A:7.2 of Appendix A] Pit privies, when used, shall be located so that they will not pollute domestic, private, or public water supplies. To accomplish this, they must be located on the downgrade from water wells and water supply lines and in accordance with the minimum distance requirements as contained in Part XII of this Code. Pit privies must be located at least four feet from any fence, ditch or building to give room for a proper earth mound. They must be housed as separate units and must be located at least 10 feet from the property line.

C. [Formerly paragraph A:7.3 of Appendix A] Details of the construction and maintenance of approved pit privies may be obtained by referring to a pamphlet entitled "Louisiana Type Sanitary Pit Privy" which is available through the *Department of Health and Hospitals, Office of Public Health, P.O. Box 60630, New Orleans, LA 70160.

AUTHORITY NOTE: Promulgated in accordance with R.S. 40:4(A)(6) and R.S. 40:5(9)(20).

HISTORICAL NOTE: Promulgated by the Department of Health and Hospitals, Office of Public Health, LR 28:1355 (June 2002).

§729. Pumping Stations
[formerly Section VIII of Appendix A]

A. [Formerly paragraph A:8.1 of Appendix A] When the elevation of a site prevents the use of gravity flow to convey liquid from one location to another, a pumping station [§1501.B.19 (Figure 22)], consisting of a holding tank, pump(s), piping, electrical controls, and other equipment as necessary, must be provided.

B. [Formerly paragraph A:8.2 of Appendix A] Many manufacturers build pumps, and in some cases complete pump stations, for the special purpose of handling wastewater, either raw, partially treated, or treated. Such specially built pump stations may be used, provided all other code requirements are met.

C. [Formerly paragraph A:8.3 of Appendix A] Pumps utilized in pump stations must be suitable for the specific application proposed. Pumps must be provided with impellers and casings constructed of corrosion resistant materials.

D. [Formerly paragraph A:8.4 of Appendix A] Pumps shall be provided to accommodate required elevation and hydraulic heads and peak flow rates, and be cycled in a manner not to be unduly disruptive to any downstream system.

E. [Formerly paragraph A:8.5 of Appendix A] The pump station holding tank must be constructed of materials suitable for septic tank use in accordance with §715.I and O of this Subchapter. Additionally, molded fiberglass, reinforced polyester (FRP) resin tanks having a minimum wall thickness of 1/4" are also acceptable.

F. [Formerly paragraph A:8.6 of Appendix A] Holding tanks shall be constructed and installed with suitable foundations to prevent settling due to soil

conditions or floating of the tank due to high water table elevations.

G. [Formerly paragraph A:8.7 of Appendix A] Pump station holding tanks shall be constructed and installed so as to be watertight. All wall seams, seams between walls and tank floor, and openings such as for pipes and wiring shall be sealed watertight. Additionally, all holding tank covers and access openings shall be attached in watertight manner by gaskets or grooves and should be sufficiently above the ground, but in no case less than 3 inches above ground, to prevent the entrance of surface runoff water.

H. [Formerly paragraph A:8.8 of Appendix A] The holding tank shall have a minimum diameter or dimension of 24 inches. The cover shall be equipped with an access opening of sufficient size to allow for pump maintenance and removal, but in no case less than 12 inches in diameter or dimension.

I. [Formerly paragraph A:8.9 of Appendix A] Pumps shall be installed in such a manner as to allow for removal and/or maintenance of the pump without necessitating entry into the holding tank by maintenance personnel. Pumps shall be provided with suitable means of quick, convenient disconnection from discharge piping and electrical wiring. Provisions must be made for lifting the pump from the holding tank with minimal exposure to the liquid in the tank.

J. [Formerly paragraph A:8.10 of Appendix A] Suitable level control devices for use in the harsh, corrosive environment encountered, shall be provided to control pump operation. The level controls shall provide for the following functions: "pump off," "pump on," and "high water alarm."

1. [Formerly paragraph A:8.10-2 of Appendix A] All materials utilized within the holding tank, whether above or below water level, shall be constructed of materials resistant to corrosion from the hostile operating environment of the tank.

2. [Formerly paragraph A:8.10-3 of Appendix A] An audible and visual "high water alarm" shall be provided and shall be located in a conspicuous location. A reset button should be provided for the audible signal in a convenient location so that relief can be easily obtained.

3. [Formerly paragraph A:8.10-4 of Appendix A] The "pump off" level shall be set at the minimum elevation as recommended by the specific pump's manufacturer.

4. [Formerly paragraph A:8.10-5 of Appendix A] The "pump on" level shall be set at elevation to provide a minimum working volume of 10 percent of the average daily design flow of the treatment system.

5. [Formerly paragraph A:8.10-6 of Appendix A] The "high water alarm" level shall be set so as to provide for a net storage volume between the "pump on" level and the "high water alarm level" of 10 percent of the average daily design flow of the treatment system.

6. [Formerly paragraph A:8.10-7 of Appendix A] A reserve volume may be provided between the "high water level" and the invert of the inlet pipe to the holding tank, if so desired.

K. [Formerly paragraph A:8.11-1 of Appendix A] All electrical wiring and controls must be appropriate for the applications for which they are used and meet prevailing electrical codes. Due consideration for the exposure to a harsh environment and the need for watertight connections and conduit must be accounted for in all electrical work.

1. [Formerly paragraph A:8.11-2 of Appendix A] Electrical connections to the main panel in the house must be made according to prevailing electrical codes.

2. [Formerly paragraph A:8.11-3 of Appendix A] The pump must be wired for automatic level control with a manual override located at the control panel.

L. [Formerly paragraph A:8.12 of Appendix A] Raw sewage pumps and piping must accommodate the passage of 2-inch solids.

M. [Formerly paragraph A:8.13 of Appendix A] Suction and discharge piping for sewage effluent pumps must conform to the pump manufacturer's recommendations. However, piping should not be less than 1.25 inches in diameter and be capable of withstanding a pressure of 75 psi.

AUTHORITY NOTE: Promulgated in accordance with R.S. 40:4(A)(6) and R.S. 40:5(9)(20).

HISTORICAL NOTE: Promulgated by the Department of Health and Hospitals, Office of Public Health, LR 28:1355 (June 2002).

§731. Effluent Reduction System Requirements for Treated Wastewater [formerly Section IX of Appendix A]

A. [Formerly paragraph A:9.1 of Appendix A] Disinfectants. Where effluent discharges are required to be disinfected, and chlorine is used as the disinfectant, a chlorine contact chamber is required. Calcium hypochlorite, labeled for wastewater disinfection, shall be added in sufficient concentrations to maintain a minimum residual of 0.5 ppm total chlorine in the effluent. In order to achieve the required chlorine contact time, a baffled chlorine contact chamber [§1501.B.11 (Figures 11, 12, 13)] designed to meet the needs for each system with the specified liquid holding capacity shall be used as follows.

Disinfectant Chamber Minimum Liquid Capacity	
Treatment Capacity of Sewerage System	Contact Chamber Liquid Capacity
500 GPD or less	30 gallons
501-750 GPD	45 gallons
751-1000 GPD	60 gallons
1001-1500 GPD	90 gallons

1. Any other disinfectant proposed for use should provide an equivalent level of disinfection.

B. [Formerly paragraph A:9.2 of Appendix A] Pumping Stations. Pumping station, when required, must be constructed of approved materials, and must comply with the applicable provisions of this Code.

C. [Formerly paragraph A:9.3 of Appendix A] Effluent Reduction Systems. Individual sewage systems, with a capacity up to and including 1500 gpd, that produce a treated, off-site effluent, shall include an effluent reducer as part of the overall system [§1501.B.12 (Figure 14)].

D. [Formerly paragraph A:9.4 of Appendix A] Special situations may arise where an individual on-site wastewater treatment system is allowed as per §511.B of this Code, but it is physically impossible to install the required size of the effluent reduction system or the effluent reduction system itself due to lot size or when a limited use sewerage system is installed in a marsh/swamp area or located over water. The size of the effluent reduction system can be reduced to the maximum amount the lot can accommodate or the installation waived with the authorization of the sanitarian parish manager. Written notification of such authorization must be submitted to the sanitarian regional director and a copy attached to the "Application for Permit for Installation of On-Site Wastewater Disposal System" (LHS-47).

E. [Formerly paragraph A:9.5 of Appendix A] All effluent reduction systems shall be installed by a licensed installer. Existing field lines can not be used as the effluent reduction system.

F. [Formerly paragraph A:9.6 of Appendix A] The size of the effluent reduction system installed has to correspond with the recommended size of the sewerage system. For example if a 750 GPD plant is required on the "Application For Permit For Installation of On-Site Wastewater Disposal System" (LHS-47), the applicant may install a 1000 GPD plant, however the size of the effluent reduction system only has to correspond to the minimum size required for a 750 GPD plant.

G. [Formerly paragraph A:9.7 of Appendix A] The sample port for a sewerage system must be installed immediately downstream of the system and in accordance with the appropriate edition and Section of NSF Standard 40, as currently promulgated, as well as the applicable provisions of this Code.

AUTHORITY NOTE: Promulgated in accordance with R.S. 40:4(A)(6), R.S. 40:5(9)(20), and R.S. 40:1154(A).

HISTORICAL NOTE: Promulgated by the Department of Health and Hospitals, Office of Public Health, LR 28:1356 (June 2002).

§733. Effluent Reduction Options
[formerly Section IX of Appendix A]

A. [Formerly paragraph A:9.8-1 of Appendix A] Effluent Reduction Field. This system is installed downstream of a mechanical treatment plant or other sewage treatment system listed in Chapter 7 Subchapter B of this Code that produces an effluent, but does not by design significantly reduce that effluent. The effluent reduction field is essentially a soil absorption field as described in §719 of this Subchapter, but with modification as noted in this Section. Section 1501.B.13 (Figure 15) has a diagram with specifications and cross-sections of the effluent reduction field.

1. [Formerly paragraph A:9.8-2 of Appendix A] If there is not sufficient grade to install the sewerage system and the effluent reduction field with gravity flow to the discharge point,

then a pump station in compliance with applicable provision of this code must be installed.

2. [Formerly paragraph A:9.8-3 of Appendix A] The force of the pumped effluent must be reduced by use of a distribution box, "Tee," or similar appurtenance.

3. [Formerly paragraph A:9.8-4 of Appendix A] The effluent reduction field trenches shall be at least 18 inches wide and between 16 to 24 inches in depth.

4. [Formerly paragraph A:9.8-5 of Appendix A] The bottom of the effluent reduction field must be level.

5. [Formerly paragraph A:9.8-6 of Appendix A] The fill or cover material shall be of porous soil or sand which allows the passage of water in all directions, with sod started on top. Fill should be at least 4 to 6 inches above grade and spread at least 3 to 4 feet on either side of the trench.

6. [Formerly paragraph A:9.8-7 of Appendix A] The effluent reduction field (ERF) must be installed a minimum of 10 feet from any property line. In addition the ERF field location shall comply with the minimum distance requirements from water wells and suction lines, water pressure lines, etc., as contained in Parts XII and XIV of this Code.

7. [Formerly paragraph A:9.8-8 of Appendix A] The minimum length of the effluent reduction field shall be determined by the treatment capacity of the sewerage system.

Treatment Capacity of Sewerage System	Minimum Total Length per Field
500 GPD or less	100 ft
501-750 GPD	150 ft
751-1000 GPD	200 ft
1001-1500 GPD	300 ft

8. [Formerly paragraph A:9.8-9 of Appendix A] If more than one absorption trench is used to provide the minimum required length of the effluent reduction field, the distance between individual trenches must be at least 6 feet with one discharge pipe provided.

9. [Formerly paragraph A:9.8-10 of Appendix A] The pipe from the end of the effluent reduction field to the discharge point must be solid.

10. [Formerly paragraph A:9.8-11 of Appendix A] A backwater valve must be provided at the end of the effluent reduction field whenever the discharge line is less than 12 inches above the ditch flow-line.

11. [Formerly paragraph A:9.8-12 of Appendix A] Each individual trench must not be greater than 100 feet in length. Clam or oyster shells may be substituted for gravel in the effluent reduction field. If used, gravel must be clean, graded and 1/2-inch to 2 1/2 inches in diameter. Other media may be considered for use if determined to have acceptable characteristics and properties. Although it may not be noted in the attached figures (§1501.B.1-19),

the end of the discharge line must have a 1/2 diameter PVC end cap over the lower half of the endpipe, causing longer retention of the effluent and providing greater opportunity for absorption. If the end of the discharge line is more than 2 inches lower than the absorption line, other provisions must be made to cause the effluent to be retained in the reduction field.

12. [Formerly paragraph A:9.8-13 of Appendix A] Gravelless pipe or other distribution chambers may be used in lieu of conventional soil absorption pipe. If gravelless pipe is used, the fill must be porous soil or sand which allows the passage of water in all directions, with a 6-inch layer below the pipe and filled 4 to 6 inches above grade and spread 3 to 4 feet on either side of the trench.

B. [Formerly A:9.9-1 of Appendix A] Rock-Plant Filter. All rock plant filters must be a minimum of 5 feet wide to a maximum of 10 feet wide.

1. [Formerly paragraph A:9.9-2 of Appendix A] The square footage will be determined by the treatment capacity of the sewerage system as follows.

Treatment Capacity of Sewerage System	Rock Plant Filter Size
500 GPD or less	150 square feet
501-750 GPD	225 square feet
751-1000 GPD	300 square feet
1001-1500 GPD	450 square feet

a. Refer to §1501.B.14 (Figures 16 and 17) for a schematic and cross section of a rock plant filter with a sewerage system installation.

2. [Formerly paragraph A:9.9-3 of Appendix A] The rock plant filter (RPF) must be installed a minimum of 10 feet from any property line. In addition, the RPF location shall comply with the minimum distance requirements from water wells and suction lines, water pressure lines, etc., as contained in Parts XII and XIV of this Code.

3. [Formerly paragraph A:9.9-4 of Appendix A] If there is not sufficient grade to install the sewerage system and the rock plant filter with gravity flow to the discharge point, then a pumping station in compliance with applicable provisions of this Part must be installed.

4. [Formerly paragraph A:9.9-5 of Appendix A] In order to prevent backflow, a backwater valve is required whenever the discharge line is less than 12 inches above the ditch flow-line.

5. [Formerly paragraph A:9.9-6 of Appendix A] Only a standard shape bed may be installed with a minimum width of 5 feet and of such length as to provide the required square footage.

6. [Formerly paragraph A:9.9-7 of Appendix A] Plans for any other configuration must be submitted for review and approval to the sanitarian regional director.

7. [Formerly paragraph A:9.9-8 of Appendix A] A liner will be required when the ground water level is within 24 inches of the bottom of the trench.

8. [Formerly paragraph A:9.9-9 of Appendix A] The polyethylene liner may be of more than one layer provided a total thickness of 16 mil is achieved.

9. [Formerly paragraph A:9.9-10 of Appendix A] When a liner is not required, the use of landscape fabric is highly recommended to prevent weed intrusion.

10. [Formerly paragraph A:9.9-11 of Appendix A] The bottom of the bed must be level and be no deeper than 14 inches.

11. [Formerly paragraph A:9.9-12 of Appendix A] A depth of approximately 10 to 12 inches is best.

12. [Formerly paragraph A:9.9-13 of Appendix A] Gravel must be 2-3 inches in diameter and laid to a depth of 12 inches.

13. [Formerly paragraph A:9.9-14 of Appendix A] An 8-inch water level must be maintained. Gravel should fill the filter bed to above surface grade to prevent erosion.

14. [Formerly paragraph A:9.9-15 of Appendix A] The minimum 4-inch perforated inlet pipe must be located no closer than 4 inches from the bottom of the bed and supported by a footing of noncorrosive material, such as concrete or treated timber.

15. [Formerly paragraph A:9.9-16 of Appendix A] The inlet should extend no more than 2 feet into the rock plant bed and must be provided with a "Tee" (with ends capped) extending the width of the bed to within 1 foot of the side walls.

16. [Formerly paragraph A:9.9-17 of Appendix A] The outlet pipe shall also be set in a footing of noncorrosive material (concrete or treated timber) on the bottom of the bed with the same "Tee" and configuration. The outlet must be elbowed up and out [§1501.B.14 (Figure 17)].

17. [Formerly paragraph A:9.9-18 of Appendix A] Do not allow plants to grow within 3 feet of the inlet and outlet of the bed.

18. [Formerly paragraph A:9.9-19 of Appendix A] A levee support system around the perimeter of the filter should be constructed to exclude surface water. The use of landscape timbers for this purpose is acceptable. Other materials, such as concrete, can also be used.

C. [Formerly paragraph A:9.10-1 of Appendix A] Spray Irrigation. The spray irrigation system [§1501.B.15 (Figure 18)] uses an electric pump that distributes the effluent to the yard through sprinkler heads. It is highly recommended for spray irrigation effluent to be chlorinated in a contact chamber, sized according to §731.A, following the treatment unit and preceding discharge. At a predetermined level, a float switch activates a pump that forces the effluent through piping to pop-up or elevated rotating type sprinkler heads. Evaporation and soil infiltration of the dispersed effluent should prevent any run-off from occurring.

1. [Formerly paragraph A:9.10-2 of Appendix A] A pump station system must be sized according to use and comply with the applicable provisions of this Part.

2. [Formerly paragraph A:9.10-3 of Appendix A] The pressure pump must be a minimum of one-half horse power capable of producing a minimum flow of 12 gallons per minute and maintaining 25 pounds per square inch at all sprinkler heads.

3. [Formerly paragraph A:9.10-4 of Appendix A] The pump will be activated by a high/low water switch through an automatic on/off switch. The pump must be deactivated through a low-volume cut off switch.

4. [Formerly paragraph A:9.10-5 of Appendix A] A time cycle device may be used to allow for specific sprinkling times (e.g., nighttime, afternoon). The pump chamber must be of adequate liquid capacity to allow sufficient storage to accommodate the desired time settings.

5. [Formerly paragraph A:9.10-6 of Appendix A] A minimum of three 4-inch type sprinkler heads coded for wastewater effluent, spaced a minimum of 40 feet apart are required.

6. [Formerly paragraph A:9.10-7 of Appendix A] The spray irrigation sprinklers shall comply with American Society of Agricultural Engineers (ASAE) Standard S 398.1 (Procedure for Sprinkler Testing and Performance Reporting).

7. [Formerly paragraph A:9.10-8 of Appendix A] The slope of the land shall be such as to facilitate drainage away from any water well or well suction lines. The edge of the spray and its drainage must be a minimum of 50 feet from any private water well and its associated suction lines and 10 feet from any property line. The edge of the spray and its drainage shall be a minimum 100 foot from public any water supply well and its associated suction lines, if any. In addition, the edge of the spray and its drainage shall be a minimum of 25 feet from any potable water (pressure) lines. As contained in Parts XII and XIV of this Code.

8. [Formerly paragraph A:9.10-9 of Appendix A] Exceptions due to lot size, topography or other constraints may be authorized by the sanitarian parish manager with written notification of such authorization to the sanitarian regional director and a copy attached to the LHS-47.

D. [Formerly paragraph A:9.11-1 of Appendix A] Overland Flow. When the size of the property is 3 acres or more, an overland flow may be utilized [§1501.B.16 (Figure 19)].

1. [Formerly A:9.11-2 of Appendix A] The discharge through perforated pipe must be distributed in such a manner as to confine the effluent on the property owned by the generator.

2. [Formerly A:9.11-3 of Appendix A] The location of the overland discharge must have a permanent vegetative cover.

3. [Formerly A:9.11-4 of Appendix A] The slope of the land shall be such as to facilitate drainage away from any water well or well suction lines. The discharge point and the field of flow shall be a minimum of 50 feet from any private water well and its associated suction lines. The discharge point and the

field of flow shall be a minimum 100 foot from public water supply wells and its associated suction lines, if any. In addition, the discharge point and the field of flow shall be a minimum of 25 feet from any potable water (pressure) lines. As contained in Parts XII and XIV of this Code.

4. [Formerly A:9.11-5 of Appendix A] A header should be used at the end of the discharge line to help disperse the effluent and to discourage channelization. The point of discharge must be such that there is at least a 200 foot flow of effluent over the property of the generator.

5. [Formerly A:9.11-6 of Appendix A] Construction of the system should be such that it is not closer than 20 feet from the property line.

E. [Formerly A:9.12 of Appendix A] Mound System or Subsurface Drip Disposal [§1501.B.17 and 18 (Figures 20 and 21)]. Either can be considered by DHH-OPH on a case to case basis. Plans and specifications must be submitted to DHH-OPH engineering services in consultation with the sanitarian regional director for review and approval prior to construction.

AUTHORITY NOTE: Promulgated in accordance with R.S. 40:4(A)(6) and R.S. 40:5(9)(20).

HISTORICAL NOTE: Promulgated by the Department of Health and Hospitals, Office of Public Health, LR 28:1357 (June 2002).

Subchapter C. Licensing Procedures for Installers and Manufacturers of Individual Sewerage Systems [formerly Chapter 13 Subpart F]

§735. General Procedures [formerly paragraph 13:022-1]

A. **Manufacturer License.** A person who wishes to engage in the business or practice of constructing an individual mechanical sewerage treatment system, and who is responsible for having the system evaluated in compliance with §725.F of this Part, shall first obtain a license for each approved tested design of plant manufactured, from the state health officer.

B. [Formerly paragraph 13:022-2] **Installer License.** A person who wishes to perform installations or maintenance of individual sewerage systems shall first obtain the appropriate type of individual sewerage installer license. Two types of licenses are offered:

1. a basic license for installation and maintenance of facilities other than individual mechanical plants; and

2. a combination license which allows the installation and maintenance of individual mechanical plants as well. A combination license may be obtained only in conjunction with a basic license, and is considered to be a separate license.

C. [Formerly paragraph 13:022-3] Sub-Manufacturer License. A person or entity authorized by a licensed manufacturer to construct, or assemble individual sewerage systems, or any portion thereof, prior to offering such systems for installation in Louisiana, is required to obtain an individual sewerage system sub-manufacturer license.

D. [Formerly paragraph 13:022-4] Application. Applications for an Individual Sewerage System Installer and/or Maintenance Provider License, as well as for Individual Sewerage System Sub-Manufacturer License, may be obtained from the nearest Parish Health Unit. Applications, including any required endorsements or certifications, must be submitted to the Sanitarian Program Administrator—Individual Sewage, Sanitarian Services Section, Office of Public Health. All licenses shall be issued by this office upon successful fulfillment of all application requirements and completion of any required examination(s), and shall be valid throughout the entire state.

E. [Formerly paragraph 13:022-5] Renewal. All licenses expire on January 31 of each year. Applications for renewal including all required endorsements must be received no later than December 1 of each year in order to insure timely renewal. The renewal of a license will be withheld from any applicant who has not complied with the requirements of this Part.

F. [Formerly paragraph 13:022-6] Suspension or Revocation of License. In addition to other remedies provided for by law, a license may be suspended upon determination by the state health officer of non-compliance with the requirements of this code. In the event of suspension, notice shall be given to the licensee having committed said violation(s) that his license has been suspended pending an Administrative Hearing in the matter to determine whether sufficient grounds for revocation exist.

G. [Formerly paragraph 13:022-7] Reinstatement of License. Upon revocation of a license, an installer, maintenance provider, manufacturer, or submanufacturer shall not be eligible for any license for a minimum period of two years from the date of revocation for cause.

AUTHORITY NOTE: Promulgated in accordance with R.S. 40:4(A)(6) and R.S. 40:5(9)(20).

HISTORICAL NOTE: Promulgated by the Department of Health and Hospitals, Office of Public Health, LR 28:1359 (June 2002).

§737. Installer/Maintenance Provider Qualifications

A. For a basic license, the applicant shall submit, along with the license application and evidence of successful completion of an examination, an affidavit certifying that he has obtained, read, and understands the provisions of this Part of the Sanitary Code, including Chapter 7 Subchapter B of this Part, and the requirements for minimum distance to sources of contamination in Part XII and will make installations and/or provide maintenance in compliance therewith. Copies of a standard affidavit form and request for examination form may be obtained from any parish health unit.

B. For a combination license, the applicant shall submit, along with the license application and evidence of successful completion of an examination, an endorsement from the

licensed manufacturer for the brand of plant he wishes to install and/or maintain, specifying that the applicant is qualified to install and/or maintain said plants, in compliance with the requirements of this Code. Applications will not be processed unless accompanied by the required endorsement.

C. For a maintenance license, the applicant shall submit the license application and evidence of successful completion of an examination, an endorsement from the licensed manufacturer for the brands of plants he wishes to maintain, specifying that the applicant is qualified to maintain said plants, in compliance with the requirements of this Code. Licensed manufacturers shall issue such endorsements to any and all individuals who present themselves for training and who meet the manufacturer's minimum standards for competency.

D. All persons seeking to apply for a new license or renewal must, at their own expense, attend and successfully complete a training course approved by the Sanitarian Services Section of the Office of Public Health, Department of Health and Hospitals, as a prerequisite for licensure. This course will be offered at least once annually.

E. All licensees must successfully repeat this training course every five years.

F. A listing of training course dates, times, and locations shall be maintained in the various regional offices by the sanitarian regional directors.

G. In the event an approved training course is not available within 60 days, the sanitarian services section may issue a temporary license provided the applicant meets all of the other requirements cited in this Section and successfully completes an examination administered by the sanitarian regional director. This temporary license shall terminate upon failure to attend the next available approved training course. Applicants who fail to attend the required training course shall not be issued another temporary license, but may reapply for a license upon successful completion of the required training course.

H. Applicants for an installer's, combination, or maintenance license shall submit, along with the license application, proof that they have secured, for at least the duration of the license, general liability insurance in an amount of no less than \$100,000/\$300,000.

AUTHORITY NOTE: Promulgated in accordance with R.S. 40:4(A)(6) and R.S. 40:5(9)(20).

HISTORICAL NOTE: Promulgated by the Department of Health and Hospitals, Office of Public Health, LR 28:1359 (June 2002), amended by the 2005 Regular Session, House Concurrent Resolution No. 1, LR 31:1914 (July 2005).

§739. Sub-Manufacturer Qualifications **[formerly paragraph 13:023-2]**

A. Applicants for a Sub-Manufacturer License shall submit, along with the license application, an endorsement from the manufacturer(s) for the brand(s) of plant(s) he wishes to construct, certifying that he is

qualified to construct said plant(s) properly and in accordance with the requirements of this Code. Applications will not be processed unless accompanied by the required endorsement(s).

B. Applicants for a Sub-Manufacturer License shall submit, along with the license application, proof that they have secured, for at least the duration of the license, general liability insurance in an amount of no less than \$100,000/\$300,000.

AUTHORITY NOTE: Promulgated in accordance with R.S. 40:4(A)(6) and R.S. 40:5(9)(20).

HISTORICAL NOTE: Promulgated by the Department of Health and Hospitals, Office of Public Health, LR 28:1360 (June 2002).

§741. Manufacturer Qualifications
[formerly paragraph 13:023-3]

A. All licensed manufacturers must be in compliance with the requirements of §725.

AUTHORITY NOTE: Promulgated in accordance with R.S. 40:4(A)(6) and R.S. 40:5(9)(20).

HISTORICAL NOTE: Promulgated by the Department of Health and Hospitals, Office of Public Health, LR 28:1360 (June 2002).

Chapter 9. Sewage Hauling

§901. General Requirements
[formerly paragraph 13:019-1]

A. A person shall not engage in the business or practice of hauling the contents of septic tanks, cesspools, vaults, or similar facilities without first obtaining a license from the state health officer. Applications for a license to haul sewage may be obtained from the nearest parish health unit. Applications must be sent to the Sanitarian Program Administrator—Individual Sewage, Sanitarian Services Section. All licenses shall be issued by this office and shall be valid throughout the state.

B. [Formerly paragraph 13:019-2] All licenses expire on June 30 of each new year. Applications for renewal must be received no later than May 1 of each year in order to insure timely renewal. Initial applications received between July 1 and March 30 will receive a license for that fiscal year (July 1 through June 30); those initial applications received after March 30 will receive a license for the remainder of that fiscal year in addition to the next fiscal year.

C. [Formerly paragraph 13:019-3] Upon determination by the state health officer of substantial non-compliance with the requirements of this code with respect to the hauling and/or disposing of the contents of septic tanks, cesspools, vaults, or similar facilities, (not including grease traps), written notice, in compliance with R.S. 49:961, shall be given to the licensee having made said violations that he shall, within 15 working days, present to the notifying office any and all evidence to show compliance with the requirements for retention of the license. In the absence of such evidence, the licensee shall be further notified that his license has been temporarily suspended pending a hearing in the matter to consider whether sufficient grounds for revocation of the license exist. The licensee shall be notified, in writing, of the date of the hearing within seven working days from the date of the notice of suspension. The date for such hearing shall be within 45 working days of the notice of suspension.

D. [Formerly paragraph 13:019-4] Upon revocation of a license, a hauler shall not be eligible to reapply for the same license for a period of two years from the date of revocation for cause.

E. [Formerly paragraph 13:019-5] Disposal of the contents of septic tanks, cesspools, vaults, or similar facilities shall be made in accordance with the arrangements, approved in the permit, for disposal at an approved sewage treatment facility. As a prerequisite to obtaining a license, evidence for such arrangements, including copies of any agreements with cooperating sewage treatment facilities, shall be submitted. The disposal of the contents of septic tanks, cesspools, vaults, or similar facilities into ditches, canals, rivers, lakes, pits, or other surface water courses is prohibited.

F. [Formerly paragraph 13:019-6] No person shall convey or cause to be conveyed through the streets, roads, or public waterways any contents from a septic tank, vault, cesspool, or privy, except in tight enclosed containers, so as not to be offensive to smell or injurious to health.

AUTHORITY NOTE: Promulgated in accordance with R.S. 40:4(A)(6) and R.S. 40:5(9)(20).

HISTORICAL NOTE: Promulgated by the Department of Health and Hospitals, Office of Public Health, LR 28:1360 (June 2002).

Chapter 11. Non-Waterborne Systems

§1101. General Requirements
[formerly paragraph 13:020-1]

A. Non-waterborne systems, such as a pit toilet (or privy), vault, pail, or chemical toilet, incinerator toilet or composting toilet may be used when the state health officer determines that it is impractical or undesirable, i.e., such as water under pressure is not available, either to connect to an existing community-type sewerage system as specified in §511.A or to construct or install a conventional septic tank system or individual mechanical plant and when in the opinion of the state health officer a non-waterborne system will function without creating a health hazard or nuisance.

B. [Formerly paragraph 13:020-2] Non-waterborne systems shall be located a safe distance from any well, spring or other source of water supply and, if possible, upon ground at a lower elevation. Such distances shall conform to the requirements of Part XII of this Code. In soil types or geological formations where sources of water supplies may be polluted, the state health officer may require the use of chemical toilets or concrete vaults in lieu of pit toilets.

C. [Formerly paragraph 13:020-3] Non-waterborne systems shall be properly maintained and operated. The following shall be considered defects in maintenance and operation of such installations:

1. evidence of caving around the edges of the pit;

2. signs of overflow or other evidence that the pit, vault, or pail is full;
3. evidence of light entering the pit except through the seat when the seat cover is raised;
4. seat cover not in place;
5. broken, perforated, or unscreened vent pipes;
6. uncleanliness of any kind in the toilet building.

AUTHORITY NOTE: Promulgated in accordance with R.S. 40:4(A)(6) and R.S. 40:5(9)(20).

HISTORICAL NOTE: Promulgated by the Department of Health and Hospitals, Office of Public Health, LR 28:1361 (June 2002).

Chapter 13. Special Applications **[formerly Chapter 13 Subpart E]**

§1301. General Requirements **[formerly paragraph 13:021]**

A. A number of unique or special situations pose certain problems with respect to sewage disposal. These atypical cases are dealt with as follows.

1. Apartment complexes, condominium complexes, hotels, motels, and other such complexes shall be connected to a community sewerage system. A commercial treatment facility shall be provided when no existing community sewerage system capable of accepting the additional loading exists.

2. Single commercial structures, where less than 1,500 gpd total flow is expected, and where the connection to a community sewerage system to serve other loading sources as well is not required, may utilize either an individual or commercial sewerage system, provided minimum lot size requirements for the use of individual sewerage systems are met.

- a. A commercial treatment facility shall be installed for business establishments where the preparation of food and/or drink is the primary business activity.

3. Treatment facilities for very small trailer parks which contain five trailer spaces or less shall be sized at 400 gallons per day per trailer space.

4. Where a community sewerage system is not available, structures occupied three days per week or less, and located in

a marsh/swamp area or over water, may utilize a limited use sewerage system comprised of the following:

- a. a septic tank system consisting of three septic tanks in series (or an acceptable three-cell or three-compartment tank) followed by an automatic chlorination device/system. The first cell shall have a minimum liquid capacity of 500 gallons. The second and third cells shall each have a minimum liquid capacity of 250 gallons. Each of the three septic tanks (or each compartment of a three-cell tank) shall meet all design, material and construction requirements for septic tanks as described in §715 of this Part. In addition to the construction and material requirements in Chapter 7, Subchapter B, the following restrictions/exceptions shall also apply:
 - i. metal tanks shall not be used;
 - ii. the tank(s) shall be demonstrated to be water-tight;
 - iii. fiberglass tanks shall be adequately coated to prevent deterioration by ultraviolet light;
 - iv. where multiple-compartment single tanks are used, only one access opening, of 6-inch minimum diameter, per cell shall be required; and
 - v. tanks set below the normal high-water level, shall be anchored or otherwise secured against movement;
 - vi. the chlorination system shall be provided with a contact chamber of a minimum of 100 gallons, and shall be equipped with an automatic cutoff to prevent flow from the third septic tank/chamber if the chlorine supply is exhausted. Also, the effluent line from the chlorine contact tank shall be protected against entrance of small animals or other pests by use of a corrosion-resistant flap-type gate, screen, or other means approved by the state health officer.

5. Vessels. Vessels which are permanently moored shall be connected to an approved sewerage system.

5. Vessels. Vessels which are permanently moored shall be connected to an approved sewerage system.

5. Vessels. Vessels which are permanently moored shall be connected to an approved sewerage system.

5. Vessels. Vessels which are permanently moored shall be connected to an approved sewerage system.

5. Vessels. Vessels which are permanently moored shall be connected to an approved sewerage system.

5. Vessels. Vessels which are permanently moored shall be connected to an approved sewerage system.

AUTHORITY NOTE: Promulgated in accordance with R.S. 40:4(A)(6) and R.S. 40:5(9)(20).

HISTORICAL NOTE: Promulgated by the Department of Health and Hospitals, Office of Public Health, LR 28:1361 (June 2002).

Chapter 15. Sewage Loading Criteria [formerly Chapter 13 Appendix B]

§1501. General Requirements

A. See Note (a)

Place	Loading	Daily Average Flow Gallons per Day	Daily Average BOD ₅ Pounds per Day	Design Basis
Apartments		250	0.425	one bedroom
		300	0.52	two bedroom
		400	0.68	three bedroom
Assembly	Note (b)	2	0.0034	per seat
Bowling Alleys (no food service)	Note (b)	75	0.13	per lane
Churches	Note (b)	5	0.0088	per sanctuary seat
Churches (with permitted kitchens)	Note (c)	10	0.017	per sanctuary seat
Country Clubs		50	0.085	per member
Dance Halls	Note (b)	2	0.0034	per person
Drive-In Theaters		5	0.0085	per car space
Factories (no showers)		20	0.051	per employee
Factories (with showers)		35	0.06	per employee
Food Service Operations				
Ordinary Restaurant (not 24 hour)		35	0.12	per seat
24-hour Restaurant		50	0.17	per seat
Banquet Rooms		5	0.017	per seat
Restaurant Along Freeway		100	0.33	per seat
Curb Service (drive-in)		50	0.17	per car space
Bar, Cocktail Lounges, Taverns				
(no food service or very little food service)		25	0.084	per seat
(with regular food service)		35	0.12	per seat
Video Poker Machine		100	0.20	per machine
Fast Food Restaurants		40	0.13	per seat
Hotel/Motel Food Service		45	0.17	per room
Homes/Mobile Homes in Subdivisions		400	0.68	per dwelling
Individual Homes/Mobile Homes (where individual sewage technology is utilized. For each additional bedroom add 100 gpd)		250	0.425	one bedroom
		300	0.51	two bedrooms
		400	0.68	three bedrooms
Hospitals (no resident personnel)	Note (c)	200	0.51	per bed
Institutions (residents)	Note (c)	100	0.25	per person
Municipalities		100	0.17	per person
Mobile Home Parks				
up to 5 trailer spaces		400	0.68	per mobile home space
6 trailer spaces or more		300	0.51	per mobile home space
Motels	Note (b)	100	0.12	per unit
Nursing and Rest Homes	Note (c)	100	0.25	per patient
		100	0.17	per resident employee
Office Buildings		20	0.051	per employee
Recreational Vehicle Dumping Stations				Consult OPH
Recreational Vehicle Parks and Camps		125	0.21	per trailer or tent space
Retail Store		20	0.034	per employee
Schools—Elementary	Note (c)	15	0.038	per pupil
Schools—High and Junior High	Note (c)	20	0.051	per pupil
Retail Fuel Stations (Located on major highways, etc., and whose primary function is to provide fuel and service to motor vehicles)	Note (d)	250	0.43	per individual vehicle fueling point (up to the first four)
		125	0.21	for each additional individual vehicle fueling point
Shopping Centers (no food service or laundries)		0.2	0.00034	per square foot of floor space
Swimming Pool (including employees)		10	0.017	per swimmer

PUBLIC HEALTH—SANITARY CODE

Place	Loading	Daily Average Flow Gallons per Day	Daily Average BOD ₅ Pounds per Day	Design Basis
Showers		20	0.04	per shower
Vacation Cottages		50	0.12	per person
Youth and Recreation Camps	Note (c)	50	0.12	per person
Washing Machines		400	1.34	per machine

1. Note (a) If loading criteria other than presented here are used, they should be justified.
 2. Note (b) Food Service waste not included.
 3. Note (c) Food Service waste included but without garbage grinders.
 4. Note (d) Vehicle fueling points are an arrangement of gasoline or diesel fuel pumps to serve automobiles or other vehicles. For the purposes of these guidelines, a vehicle fueling point is one that serves a vehicle at one time. Food service waste not included.
- Note: Design calculations for sewage treatment facilities must be made based on both hydraulic loading(s) and organic loading(s). Final design of facility to be used upon the larger capacity (size) required by these calculations.

B. Figures

1. Methods of Making Percolation Tests

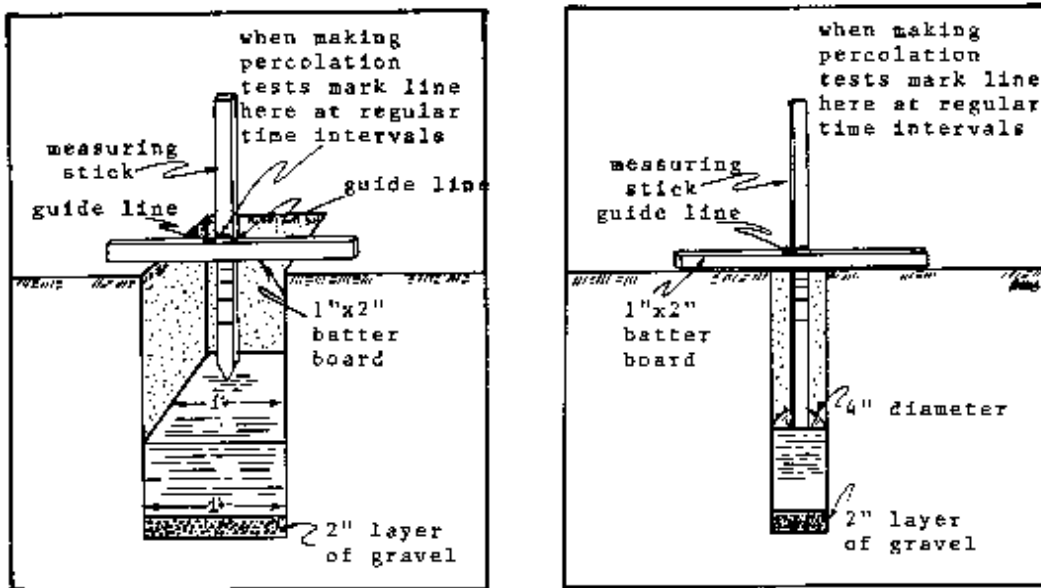

- NOTE: 1. Leave batter board in place, being careful not to move it during tests.
2. Keep measuring stick within guide lines on batter board when each reading is taken.

FIGURE 1
METHODS OF MAKING PERCOLATION TESTS

2. Typical Layout of Absorption Trench

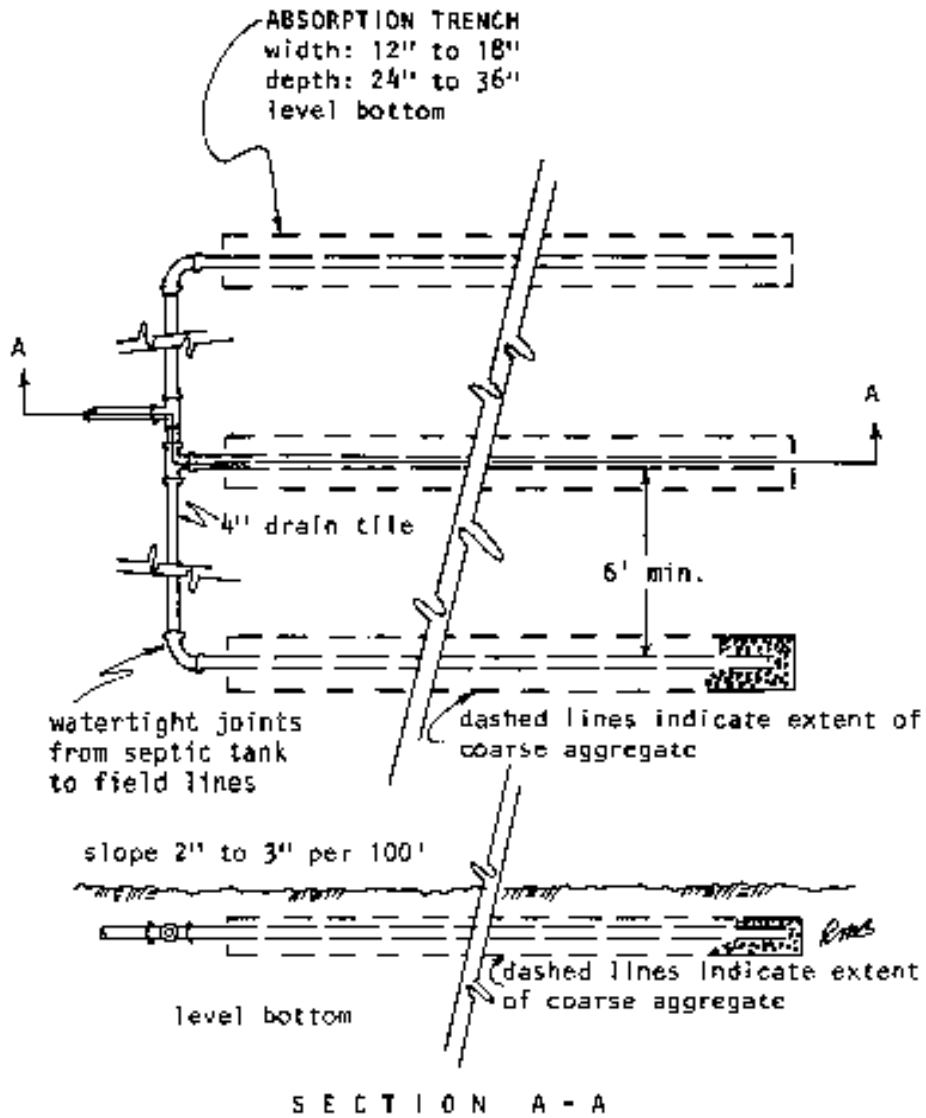

NOTE: See Figure 4 for additional details

FIGURE 2
TYPICAL LAYOUT OF ABSORPTION TRENCH

3. Absorption Field System for Sloping Ground

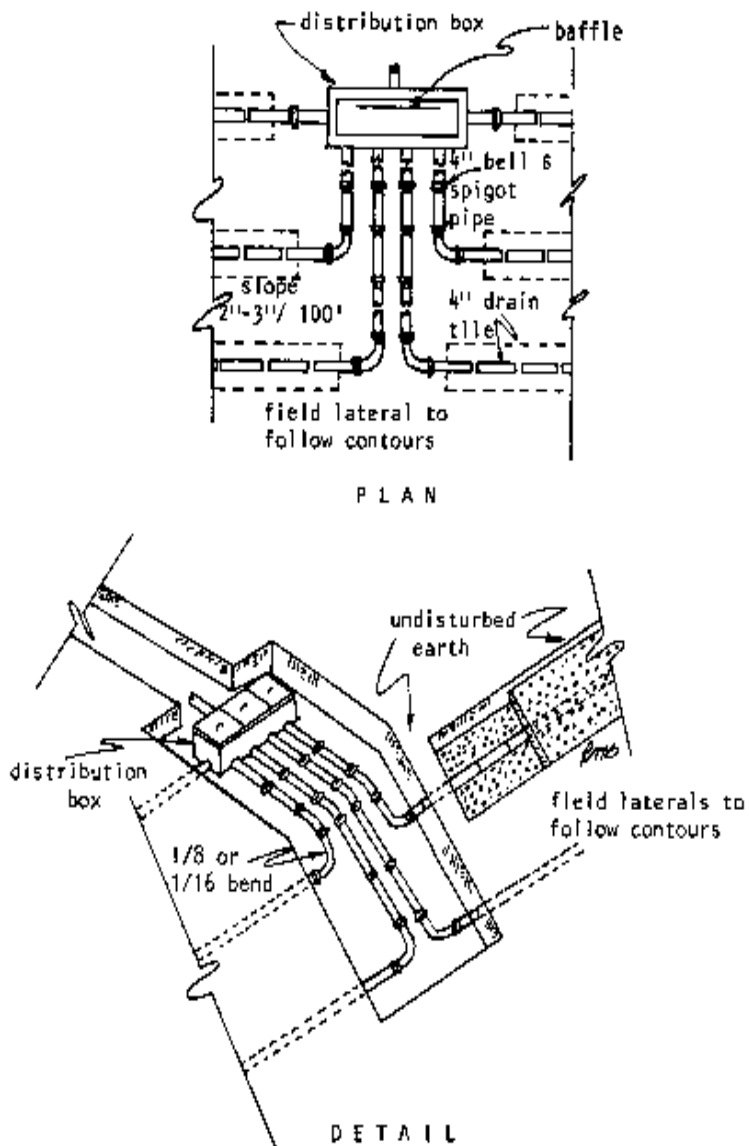

NOTE: See Figure 4 for additional details

FIGURE 3
ABSORPTION FIELD SYSTEM FOR SLOPING GROUND

4. Absorption Trench and Lateral Details

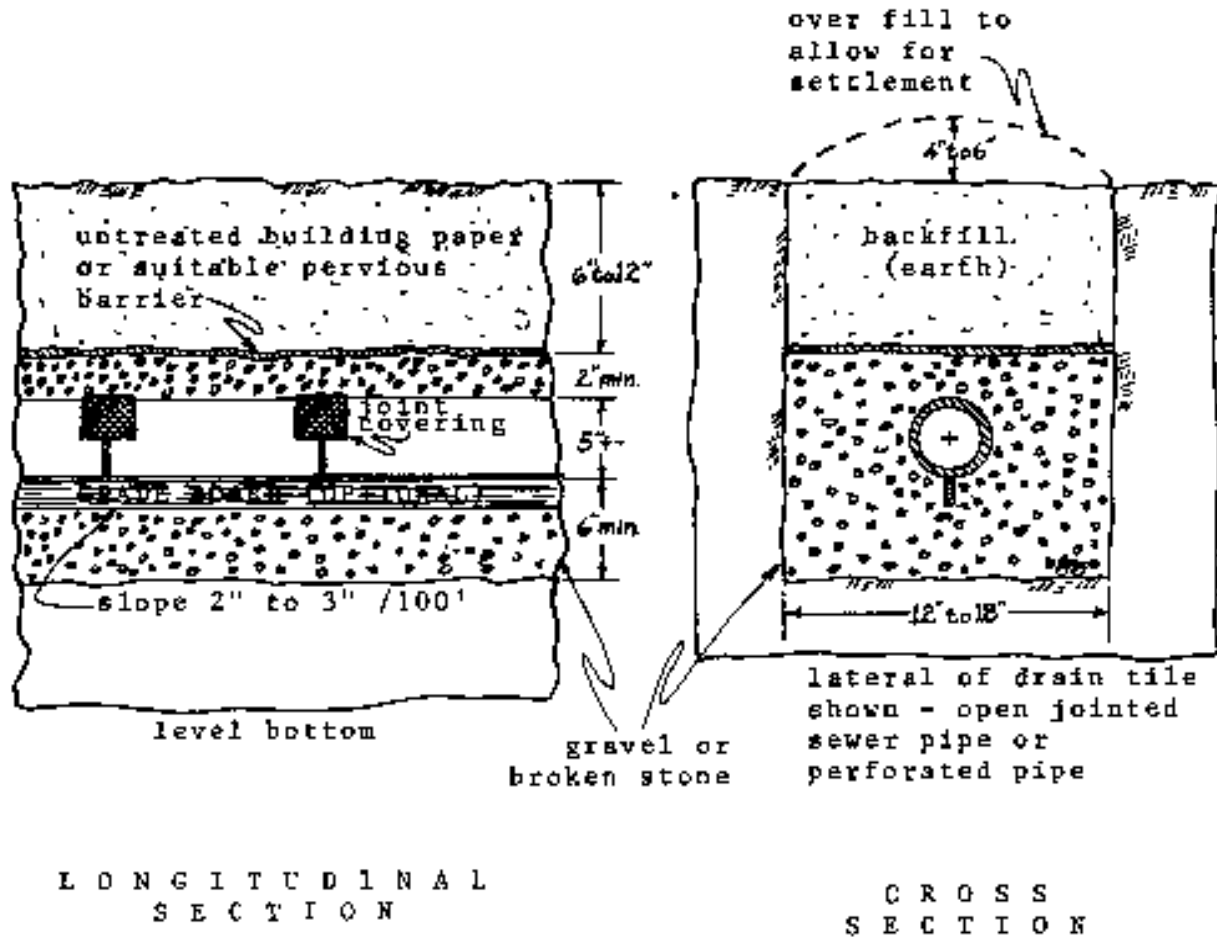

- NOTES: 1. Drain tile laid with joints opened from $\frac{1}{4}$ to $\frac{1}{2}$ inch. Special collars may be used if desired.
2. Asphaltic treated paper for joint covering.

FIGURE 4
ABSORPTION TRENCH AND LATERAL DETAILS

5. Typical Layout: Septic Tank/Oxidation Pond System

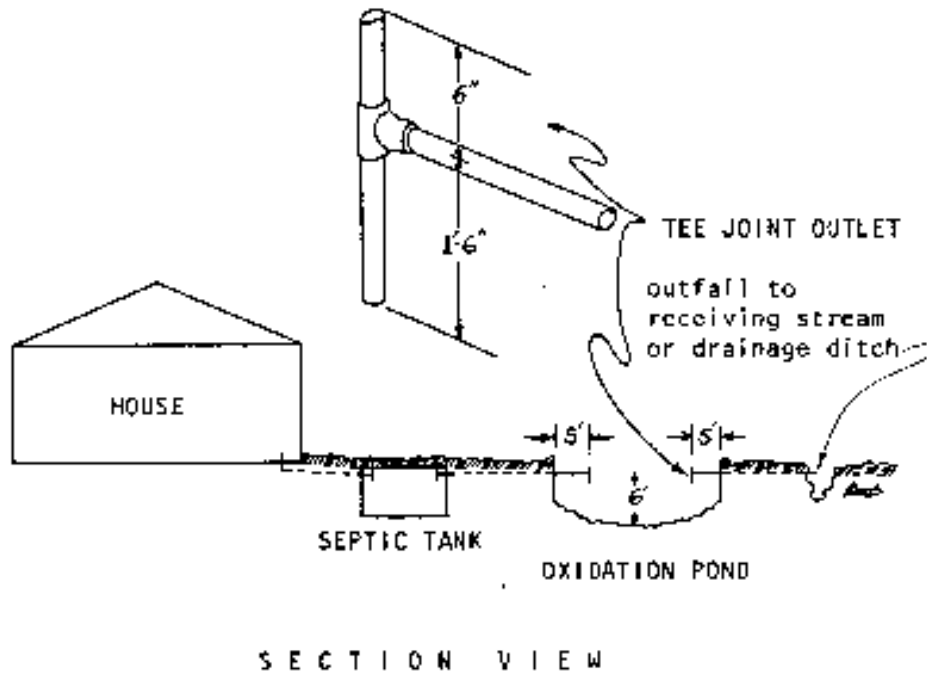
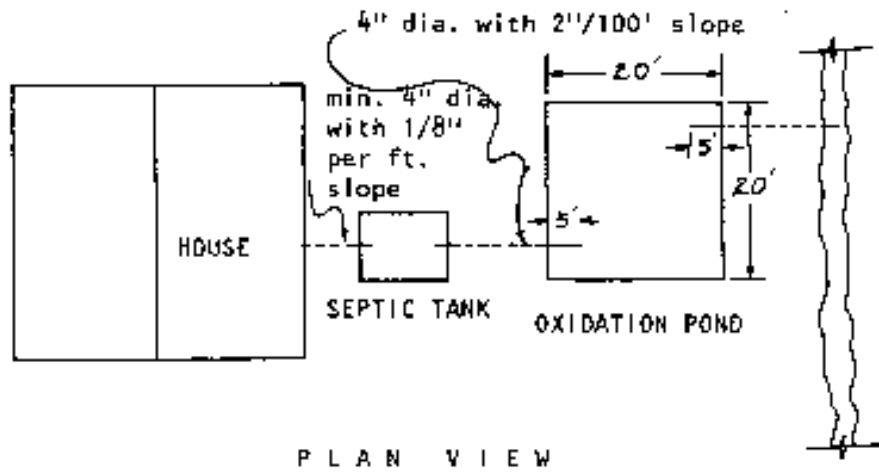

- NOTES: 1. Pond must be enclosed by a suitable fence.
 2. Outlet invert to be at same or lower elevation than inlet invert.
 3. Pond water surface at least 2" below septic tank water surface.

FIGURE 5
 TYPICAL LAYOUT: SEPTIC TANK/OXIDATION POND SYSTEM

6. Oxidation Pond Timber Retaining Wall Details

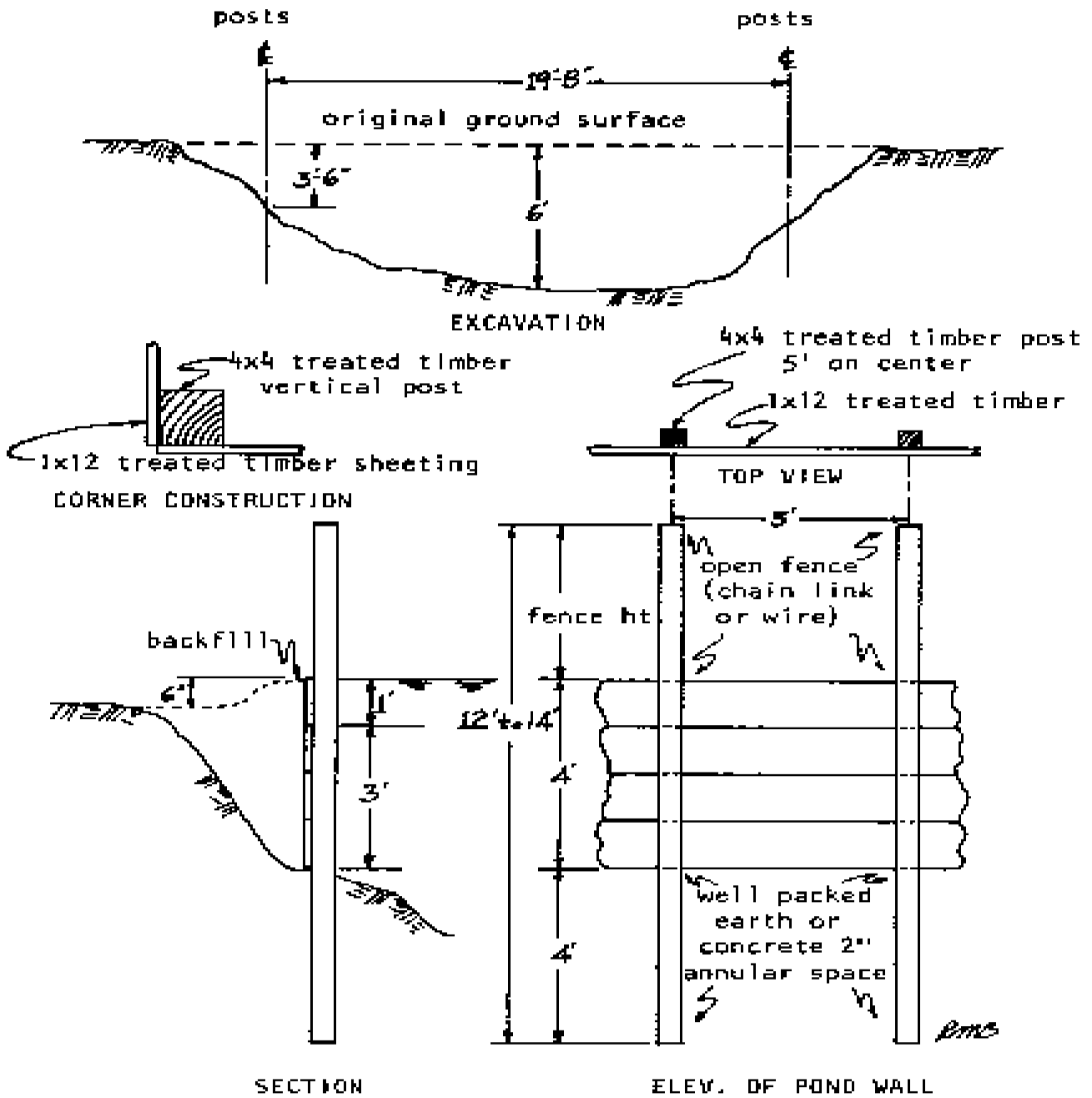

FIGURE 6
OXIDATION POND TIMBER RETAINING WALL DETAILS

7. Oxidation Pond Concrete Block Retaining Wall Details

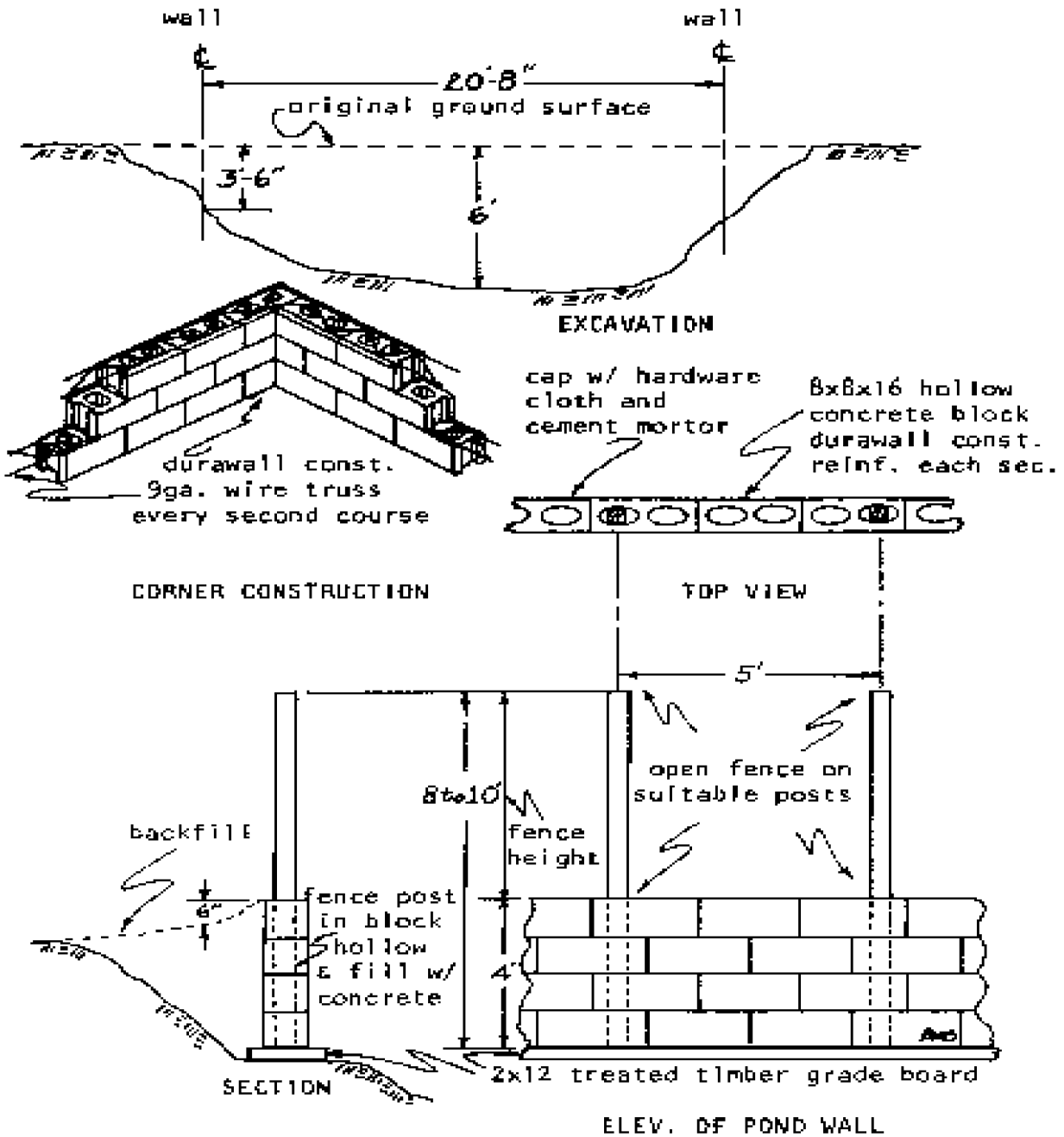

FIGURE 7
OXIDATION POND CONCRETE BLOCK RETAINING WALL DETAILS

8. Leveed Oxidation Pond

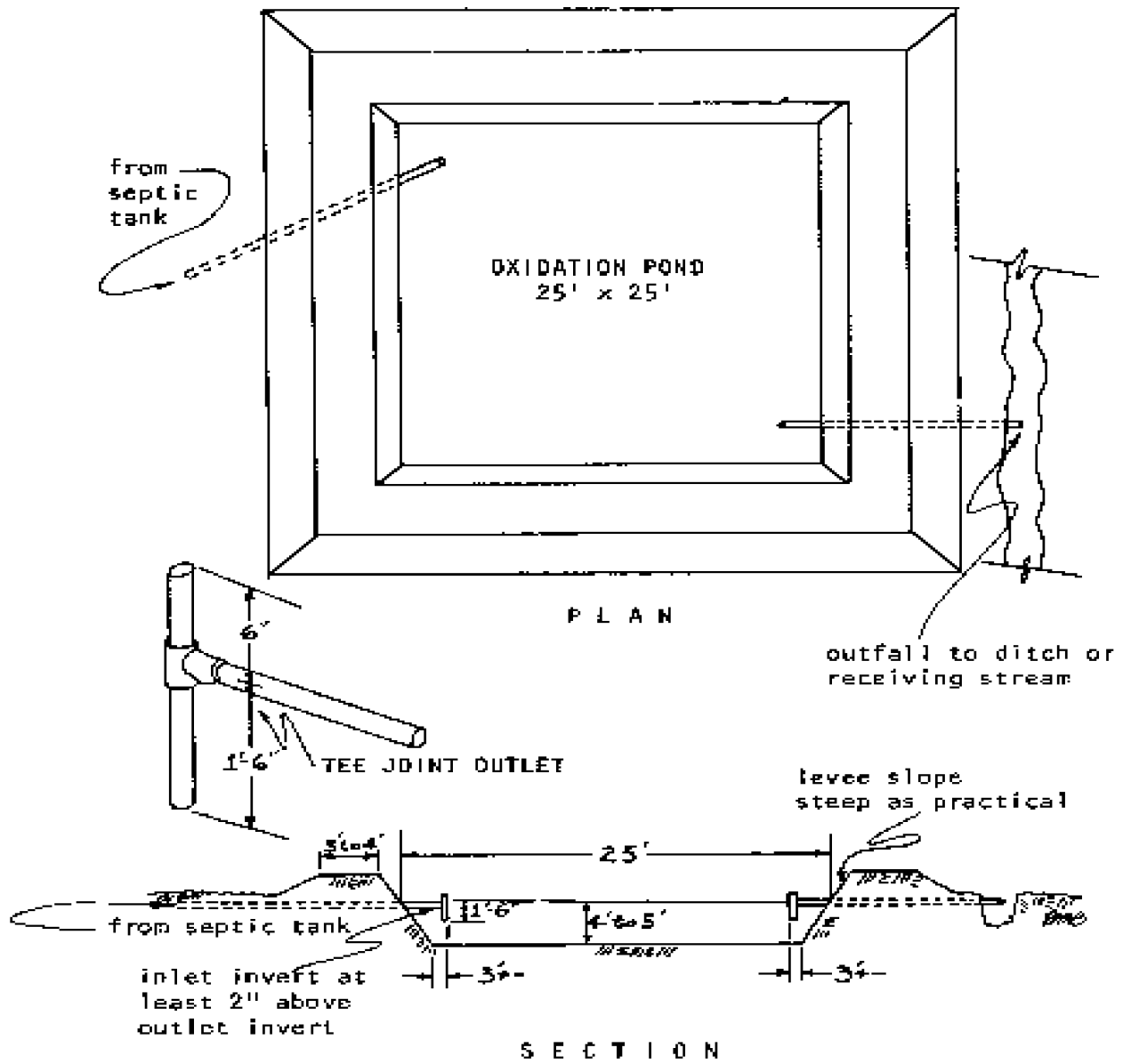
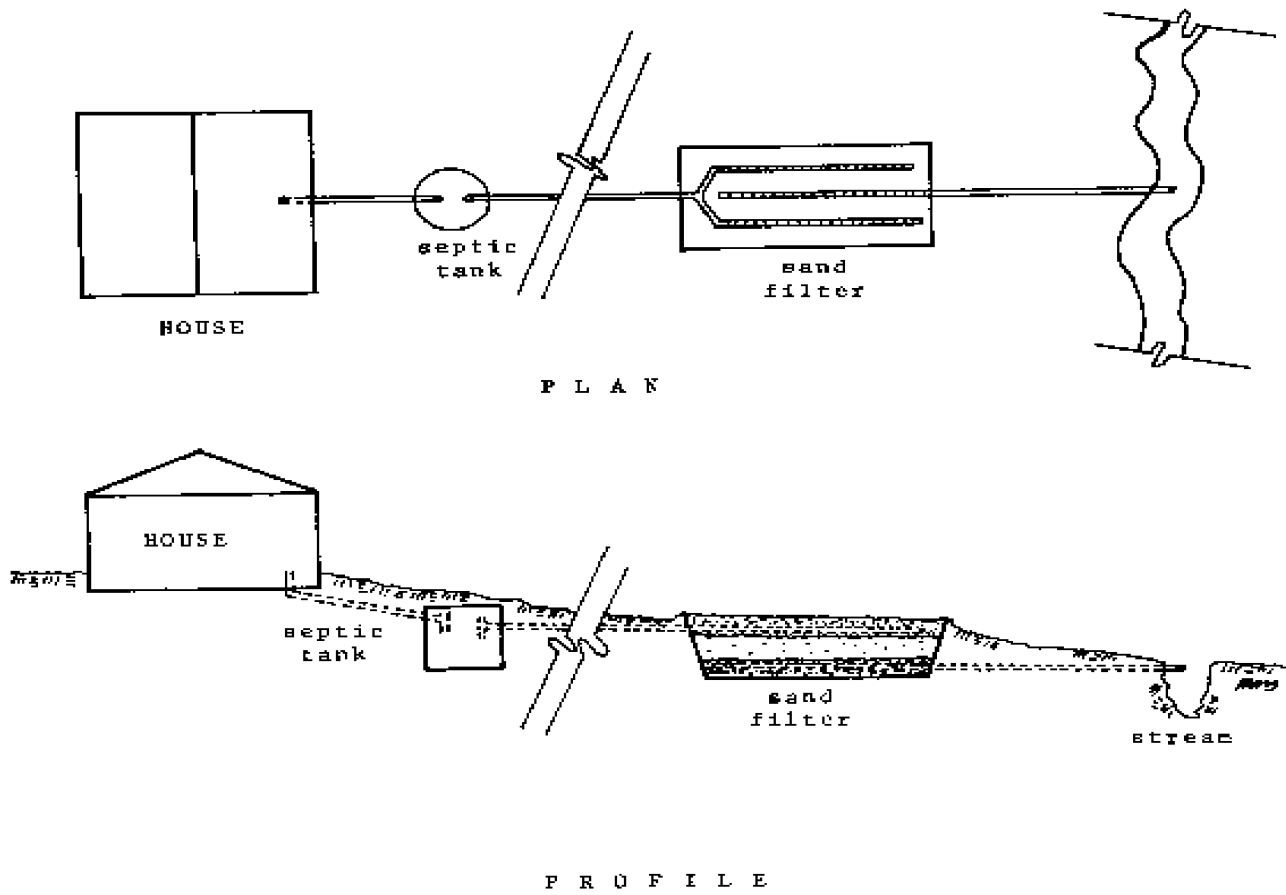

FIGURE 8
LEVEED OXIDATION POND

9. Typical Layout: Septic Tank/Sand Filter Bed System



NOTE: See Figure 10 for additional details

FIGURE 9
TYPICAL LAYOUT: SEPTIC TANK/SAND FILTER BED SYSTEM

10. Sand Filter Bed Details

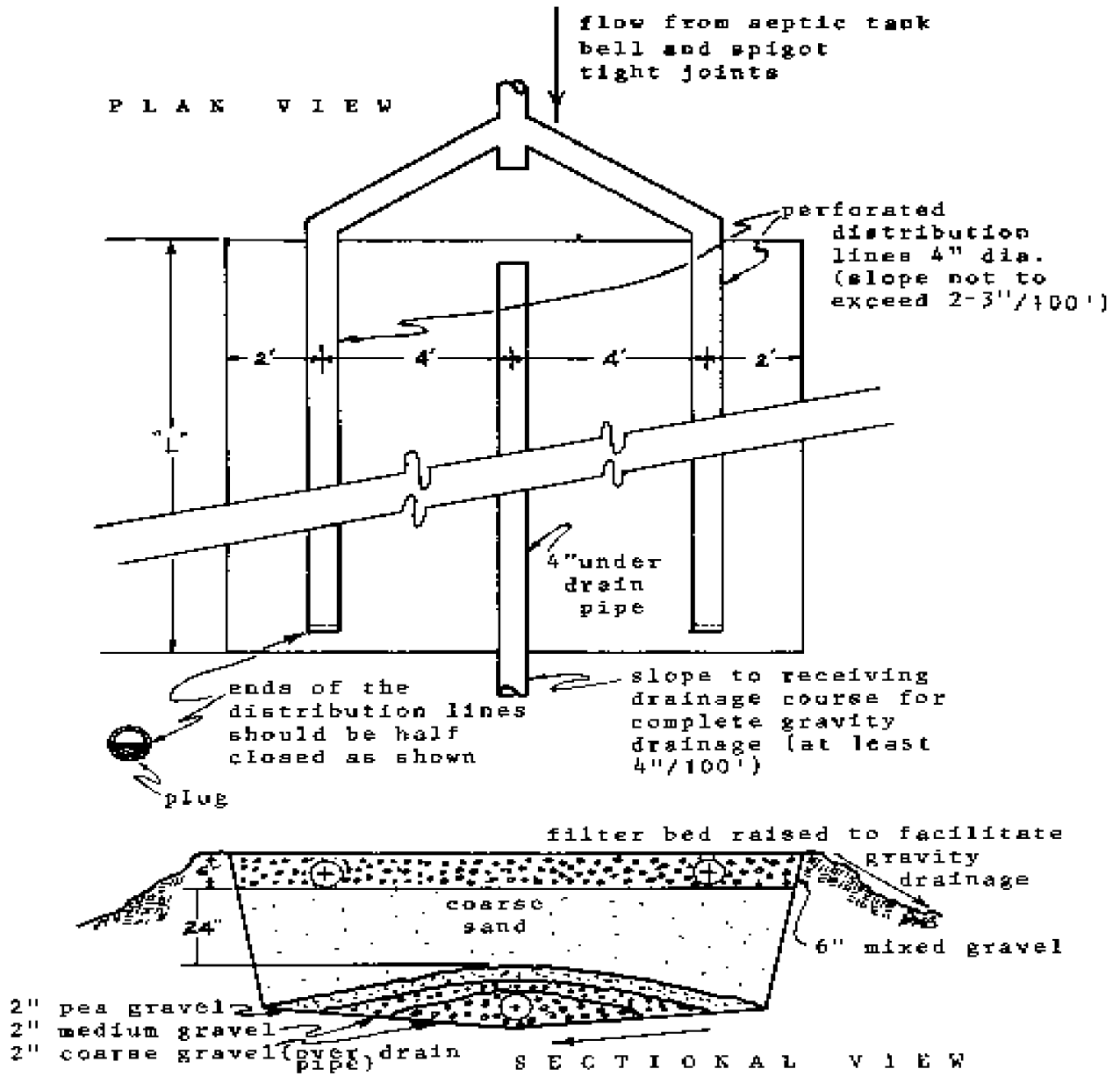

FIGURE 10
SAND FILTER BED DETAILS

11. Chlorinator

CHLORINATOR

STACK FEED CHLORINATORS

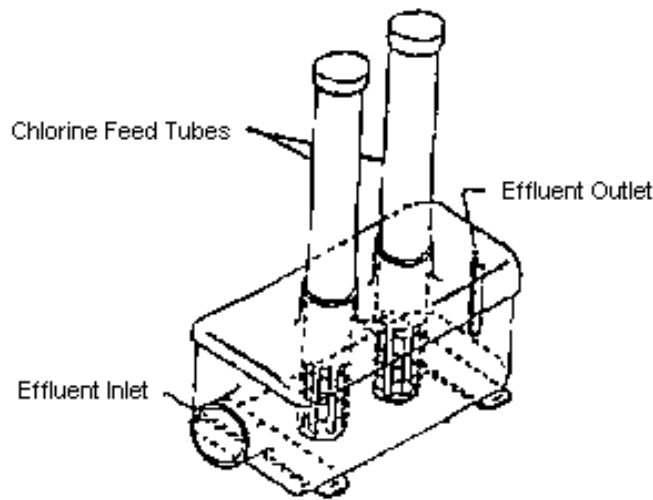

Figure 11

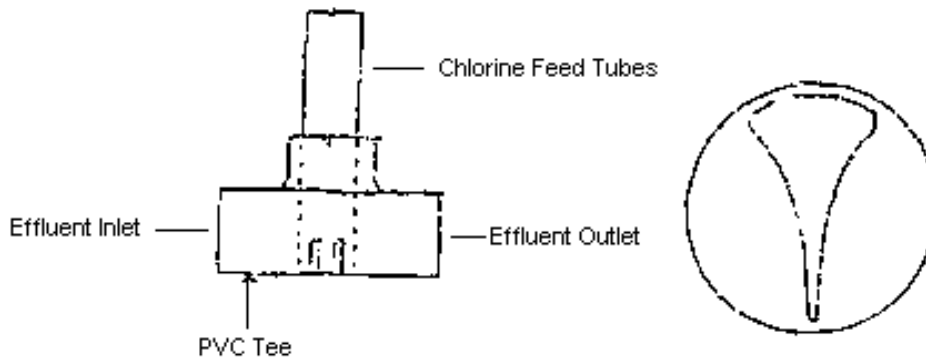

Figure 12

Figure 13

Chlorinators can be purchased premanufactured (as in Figure 11), or can be constructed onsite using the following minimum criteria - (Figure 12) Use a four-inch minimum PVC Tee with a restrictive insert (see Figure 13) to control the effluent flow. This allows the tablets to be contacted by the effluent in proportion to the amount of flow. The insert is cemented onto the PVC Tee with the restriction pointing down.

12. Effluent Reduction Tankage

EFFLUENT REDUCTION TANKAGE

NOTE: ALL RISERS SHALL BE 3 INCHES ABOVE GRADE.

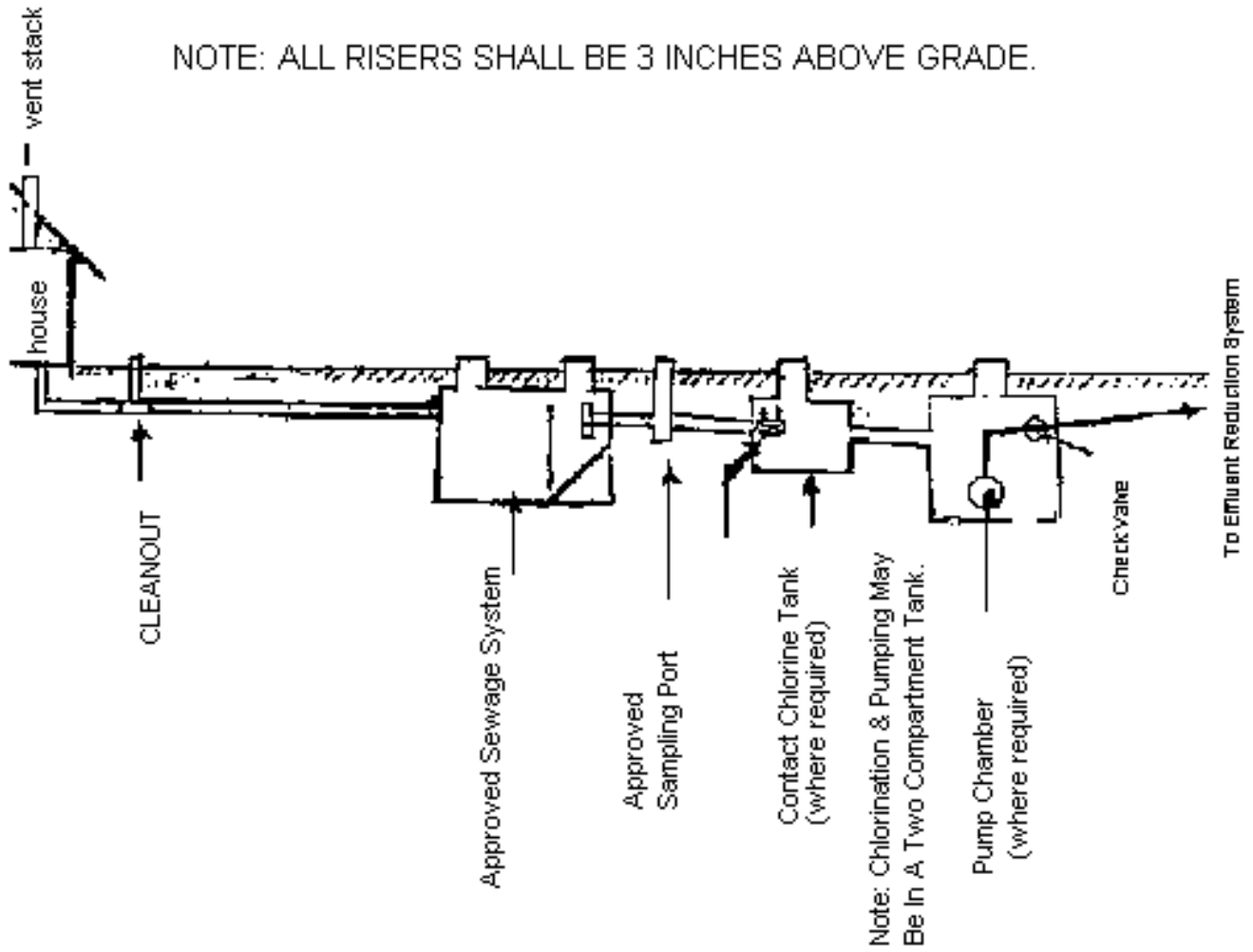

FIGURE 14

13. Effluent Reduction Field

EFFLUENT REDUCTION FIELD

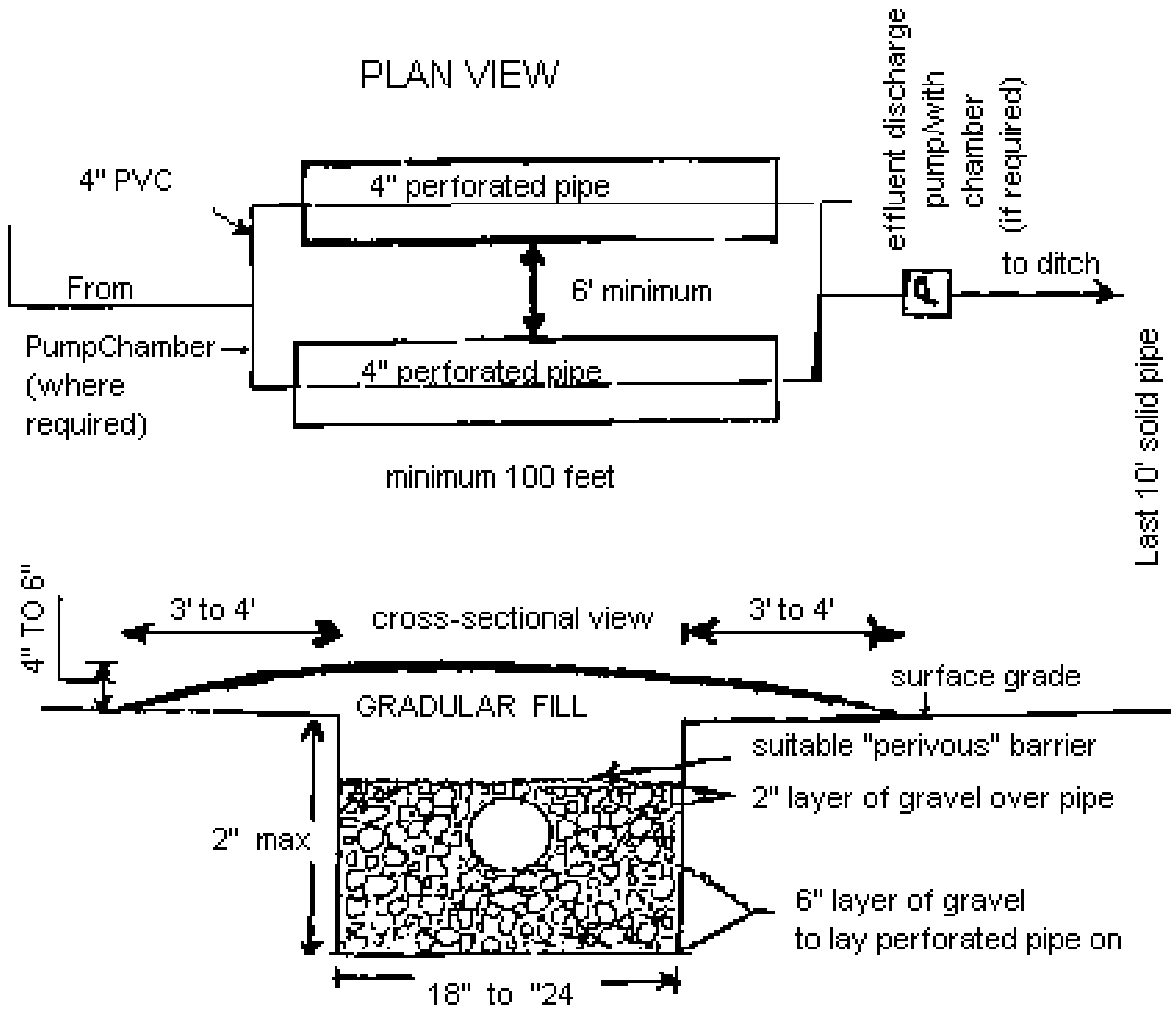

Figure 15

14. Rock Plant

ROCK PLANT

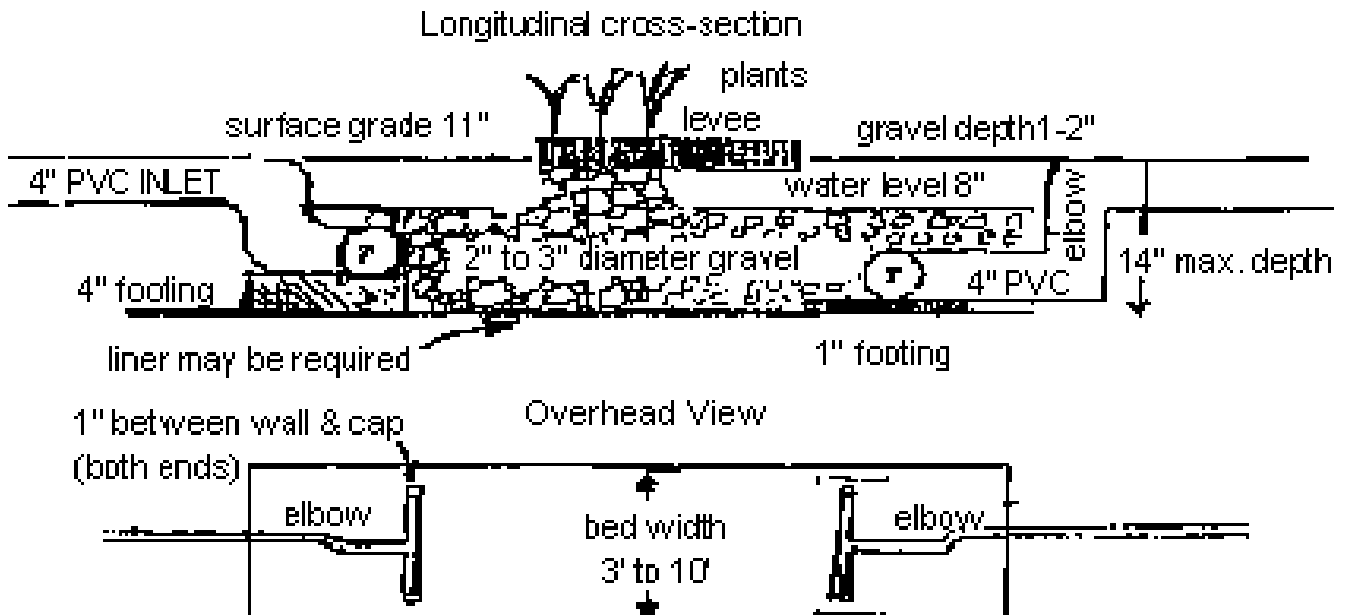
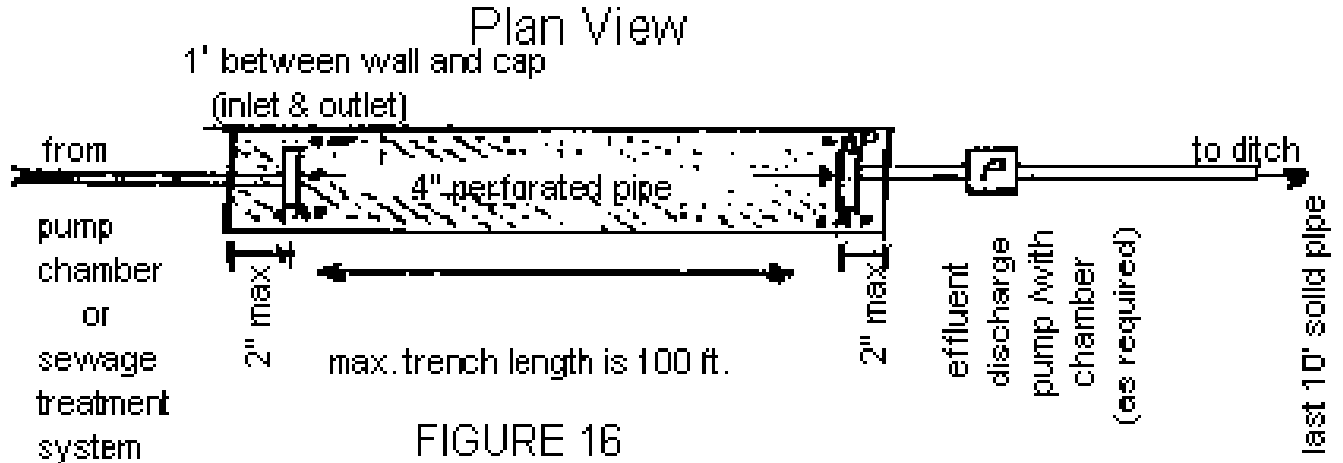

FIGURE 17

15. Spray Irrigation Schematic

SPRAY IRRIGATION SCHEMATIC

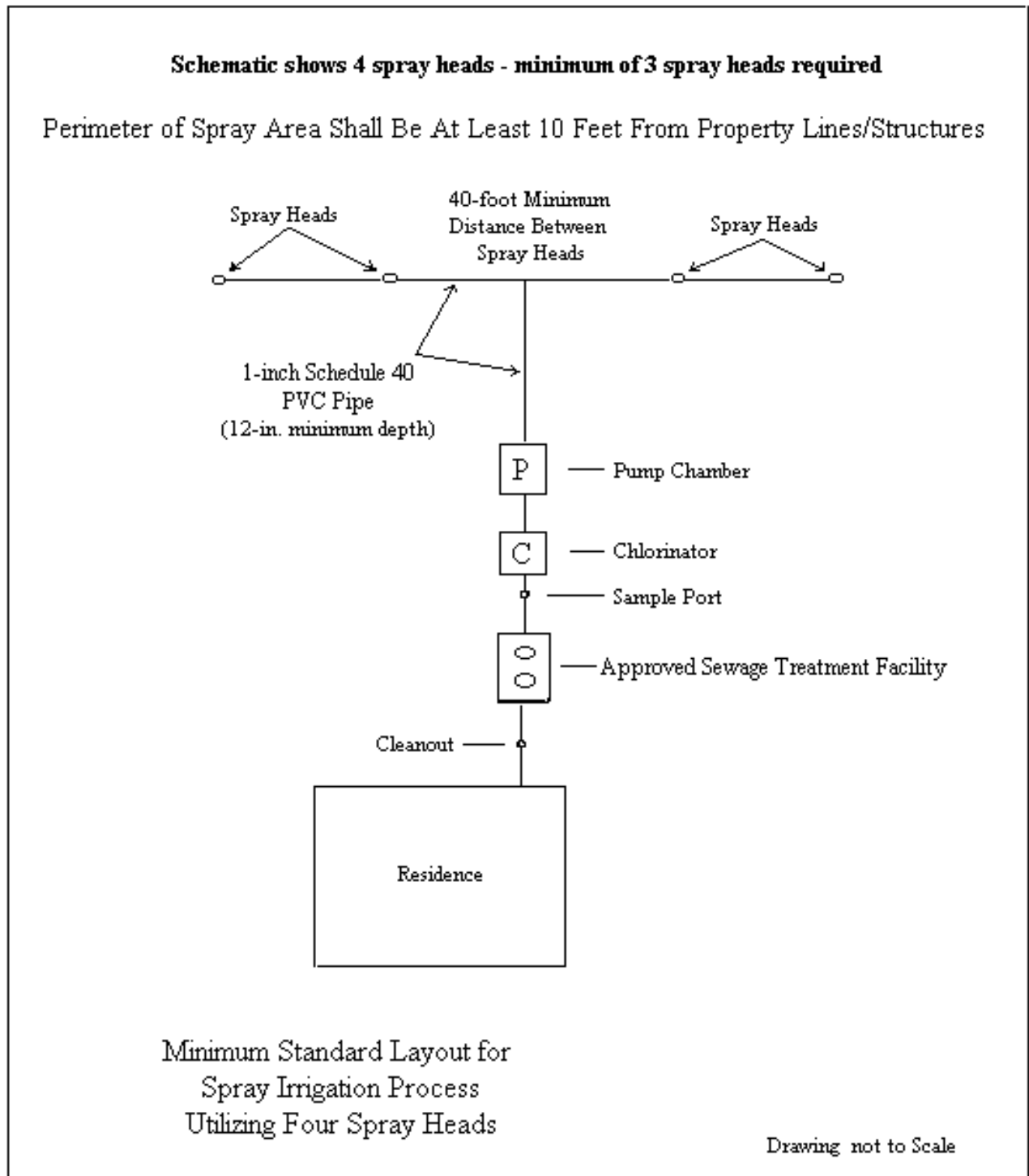

Figure 18

16. Overland Flow

OVERLAND FLOW

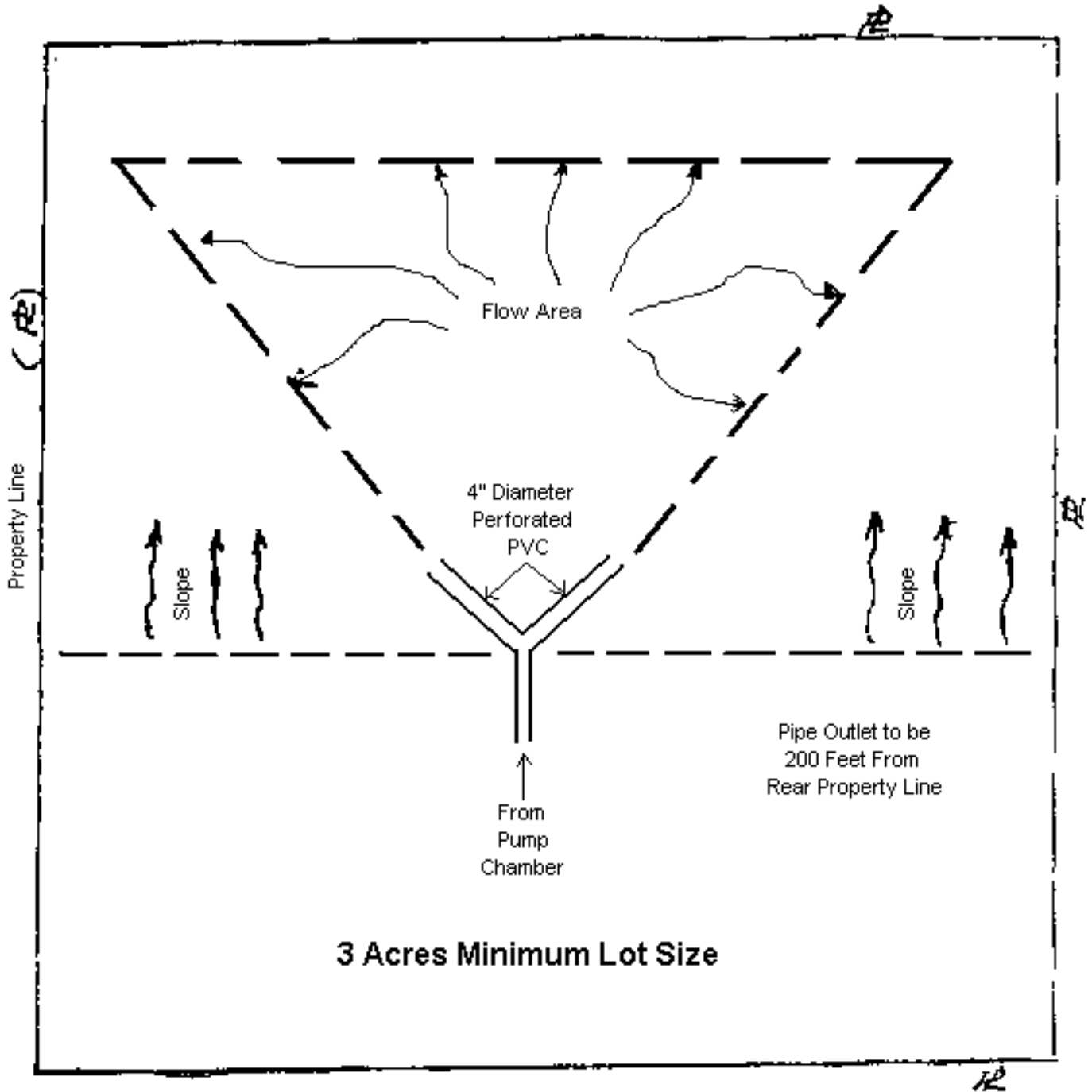
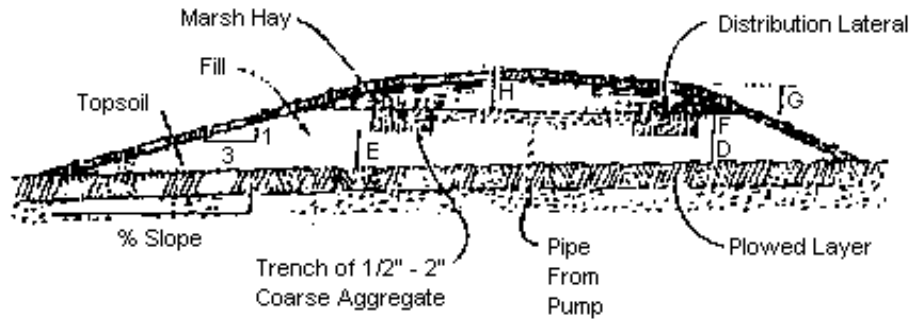

Figure 19

17. Mounds

MOUNDS



Cross Section of Mound System Using 2 Trenches for Absorption Area

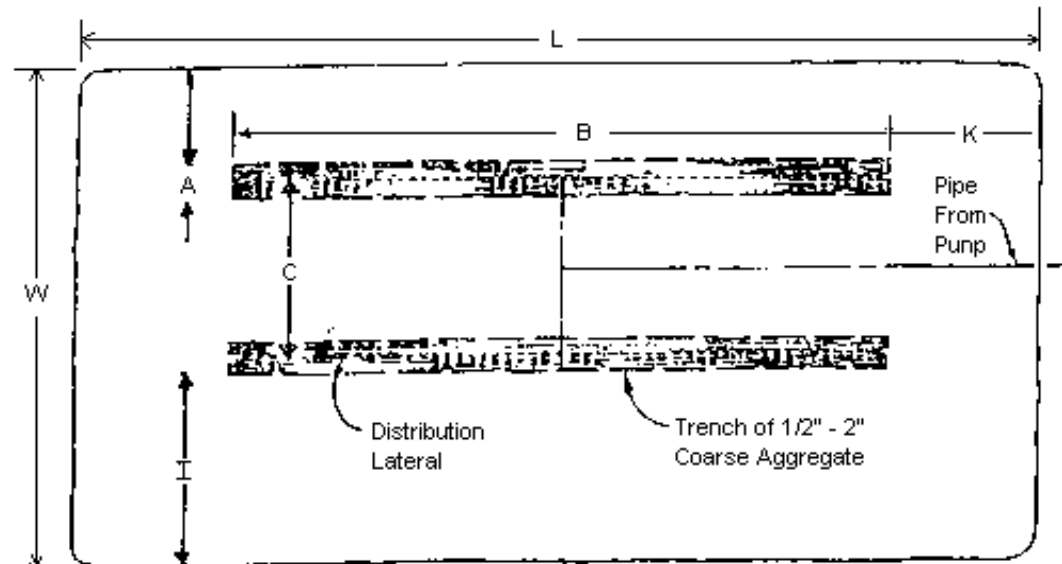

Plan View of Mound System Using 2 Trenches for Absorption Area

Figure 20

NOTE: MUST BE APPROVED BY OPH - ENGINEERING SERVICES
IN CONSULTATION WITH SANITARIAN REGIONAL DIRECTOR

18. Drip Disposal System

DRIP DISPOSAL SYSTEM

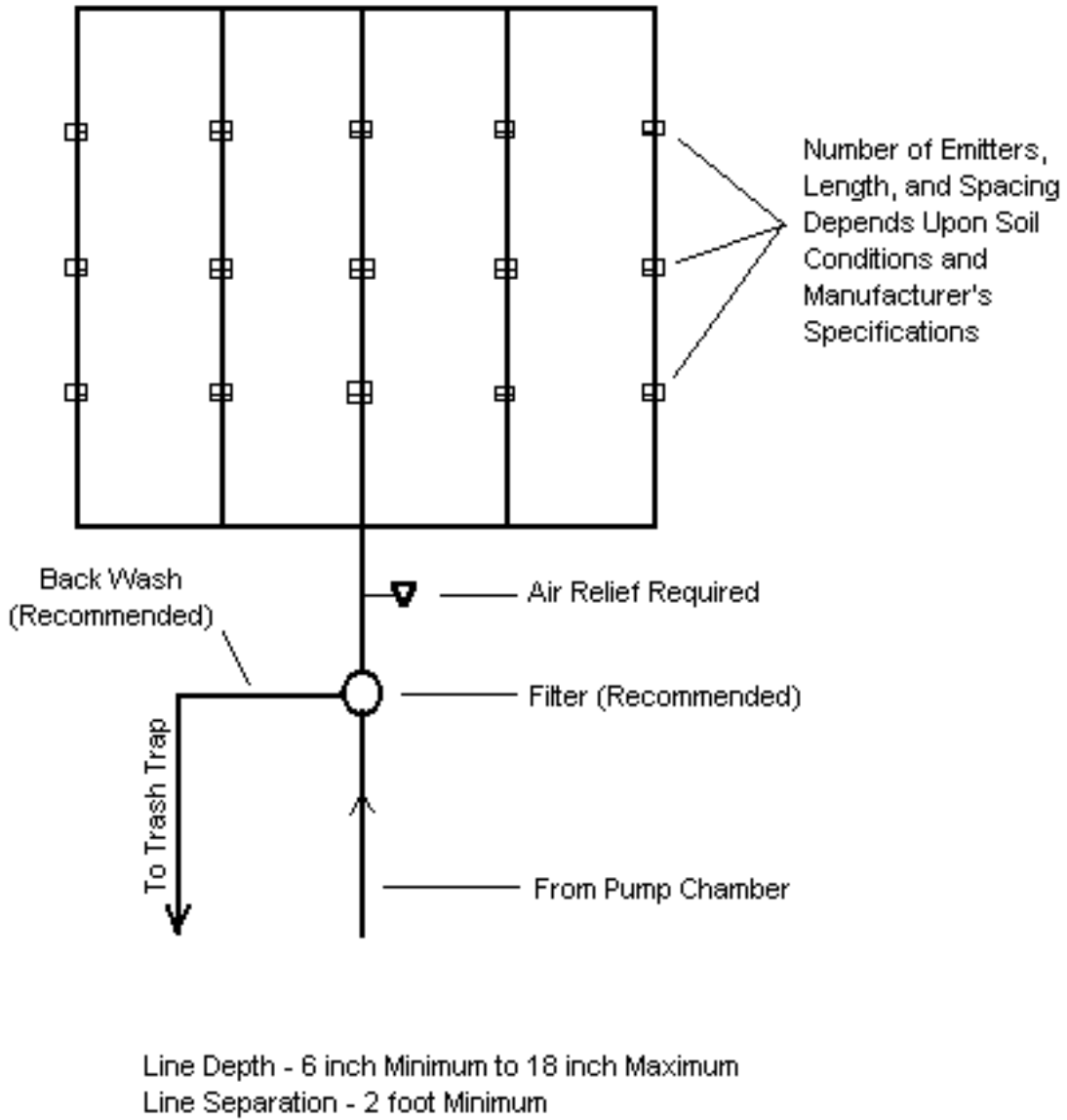
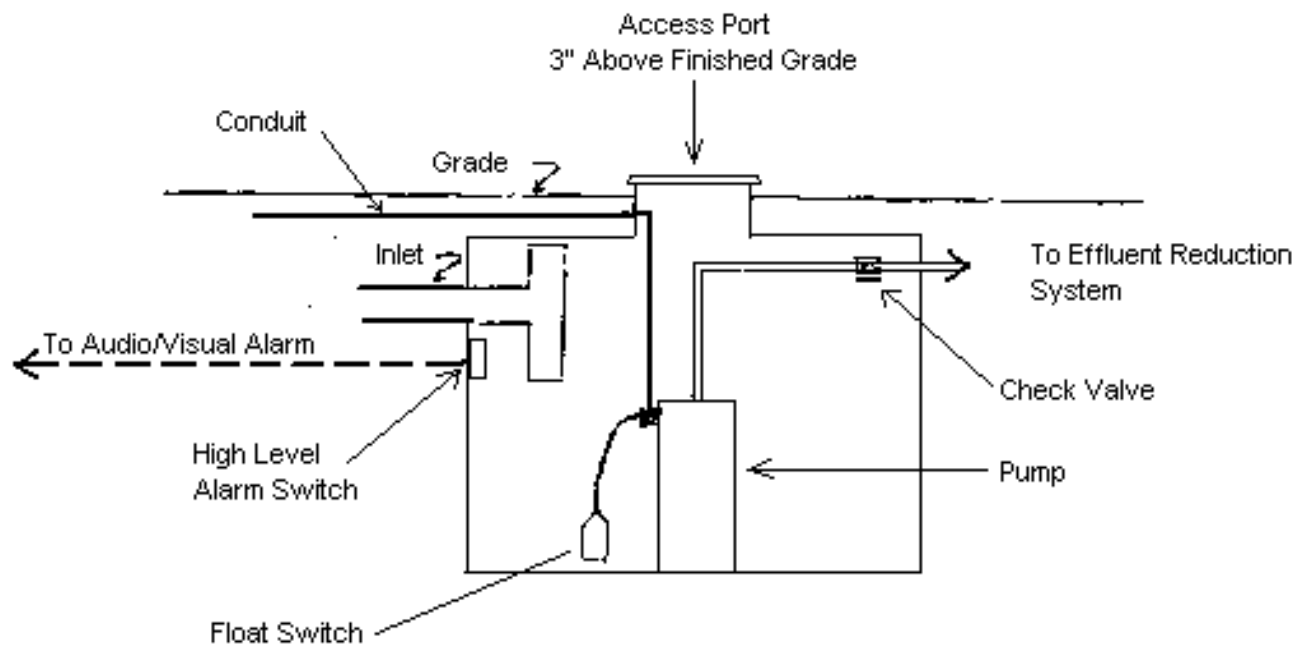

Figure 21

19. Pumping Chamber for Effluent Reduction

PUMPING CHAMBER FOR EFFLUENT REDUCTION



NOTE: Chlorination and Pumping May Be In A Two-Compartment Tank

Figure 22

AUTHORITY NOTE: Promulgated in accordance with R.S. 40:4(A)(6) and R.S. 40:5(9)(20).

HISTORICAL NOTE: Promulgated by the Department of Health and Hospitals, Office of Public Health, LR 28:1362 (June 2002).

Title 51

PUBLIC HEALTH—SANITARY CODE

Part XIV. Plumbing

Editor's Note: As required by Act 836 of the 2014 Regular Legislative Session, Part XIV (Louisiana State Plumbing Code) of the Louisiana State Sanitary Code [LAC 51 (Public Health Sanitary Code)] became null and void on January 1, 2016. In accordance with the Act, the Louisiana State Uniform Construction Code Council (LSUCCC) promulgated new State plumbing regulations through an emergency rule under the State Uniform Construction Code (LAC 17:I). Before January 1, 2016, comprehensive backflow protection/cross connection control regulations designed to protect public health applicable to plumbing were contained in Part XIV (Plumbing) of the State Sanitary Code. Effective January 1, 2016, some of these same backflow protection/cross connection control regulations applicable to plumbing have been adopted by the LSUCCC under the State Uniform Construction Code, particularly within the 2012 International Plumbing Code and within the 2012 International Residential Code (see December 20, 2015 Louisiana Register, Volume 41, page 2545).

Chapter 1. Administration

Subchapter A. General

§101. Title and Adoption of Louisiana State Plumbing Code (LSPC) [formerly paragraph 14:001]

A. The Department of Health and Hospitals, Office of Public Health hereby adopts Part XIV (Plumbing) of the Sanitary Code, state of Louisiana (LAC 51:XIV). "Part XIV (Plumbing) of the Sanitary Code, State of Louisiana" may be cited as the "Louisiana State Plumbing Code", hereinafter referred to as "this code" or "this Part". Any reference or citation to the "Louisiana State Plumbing Code" shall likewise be synonymous to any reference or citation to "Part XIV (Plumbing) of the Sanitary Code, State of Louisiana."

AUTHORITY NOTE: The first source of authority for promulgation of the sanitary code is in R.S. 36:258(B), with more particular provisions found in Chapters 1 and 4 of Title 40 of the Louisiana Revised Statutes. This Part is promulgated in accordance with R.S. 40:4(A)(7) and R.S. 40:5(2)(3)(7)(9)(16)(17)(20).

HISTORICAL NOTE: Promulgated by the Department of Health and Hospitals, Office of Public Health, LR 28:1383 (June 2002), amended LR 38:2795 (November 2012).

§103. Availability [formerly paragraph 14:002]

A. Information concerning purchasing copies of this Part (LAC 51:XIV) may be obtained by contacting the Office of the State Register, P.O. Box 94095, Baton Rouge, LA 70804-9095, telephone (225) 342-5015 or fax (225) 342-0284. This Part is available to be viewed electronically on the Office of the State Register's website at: <http://www.doa.louisiana.gov/osr/osr.htm>.

AUTHORITY NOTE: Promulgated in accordance with R.S. 40:4(A)(7) and R.S. 40:5(2)(3)(7)(9)(16)(17)(20).

HISTORICAL NOTE: Promulgated by the Department of Health and Hospitals, Office of Public Health, LR 28:1383 (June 2002), amended LR 38:2795 (November 2012), repromulgated LR 38:3233 (December 2012).

§105. Effective Date and Edition [formerly paragraph 14:003]

A. Other than those specific portions of this Part pertaining to the implementation of Act No. 362 of the 2011

Regular Session, the remainder of this Part shall become effective on February 20, 2013. Furthermore, the year in which this code becomes effective shall be used to indicate the edition; therefore, the rule being published in the November 20, 2012 *Louisiana Register* may be referred to as the Louisiana State Plumbing Code, 2013 Edition.

AUTHORITY NOTE: Promulgated in accordance with R.S. 40:4(A)(7) and R.S. 40:5(2)(3)(7)(9)(16)(17)(20).

HISTORICAL NOTE: Promulgated by the Department of Health and Hospitals, Office of Public Health, LR 28:1383 (June 2002), amended LR 38:2795 (November 2012).

Subchapter B. Purpose and Scope

§107. Purpose [formerly paragraph 14:004]

A. The purpose of this Chapter is to provide for the administration and enforcement of this code.

AUTHORITY NOTE: Promulgated in accordance with R.S. 40:4(A)(7) and R.S. 40:5(2)(3)(7)(9)(16)(17)(20).

HISTORICAL NOTE: Promulgated by the Department of Health and Hospitals, Office of Public Health, LR 38:2796 (November 2012).

§109. Code Remedial

A. General. This code is hereby declared to be remedial, and shall be construed to secure the beneficial interests and purposes thereof-which are public safety, health and general welfare-by regulating the installation and maintenance of all plumbing.

B. Quality Control. Quality control of materials and workmanship is not within the purview of this code except as it relates to the purpose stated herein.

C. Permitting and Inspection. The inspection or permitting of any building or plan by any jurisdiction, under the requirements of this code shall not be construed in any court as a warranty of the physical condition of such building or the adequacy of such plan. No jurisdiction or any employee thereof shall be liable in tort for damages for any defect or hazardous or illegal condition or inadequacy in such building or plan, nor for any failure of any component of such building, which may occur subsequent to such inspection or permitting.

AUTHORITY NOTE: Promulgated in accordance with R.S. 40:4(A)(7) and R.S. 40:5(2)(3)(7)(9)(16)(17)(20).

HISTORICAL NOTE: Promulgated by the Department of Health and Hospitals, Office of Public Health, LR 38:2796 (November 2012).

§111. Scope

A. Applicability. The provisions of this code shall apply to every plumbing installation, including alterations, repairs, replacement, equipment, appliances, fixtures, fittings and appurtenances.

B. Federal and State Authority. The provisions of this code shall not be held to deprive any federal or state agency, or any applicable governing authority having jurisdiction, of any power or authority which it had on the effective date of the adoption of this code or of any remedy then existing for the enforcement of its orders, nor shall it deprive any individual or corporation of its legal rights provided by law.

C. Appendices. The appendices included in this code are not intended for enforcement unless specifically referenced in the code text, stated in the appendix or specifically included in the adopting ordinance or promulgated regulations.

D. Referenced Standards. Standards referenced in this code shall be considered an integral part of this code without separate adoption. If specific portions of a standard are denoted by code text, only those portions of the standard shall be enforced. Where code provisions conflict with a standard, the code provisions shall be enforced Permissive and advisory provisions in a standard shall not be construed as mandatory.

E. Maintenance. All plumbing systems, both existing and new, and all parts thereof, shall be maintained in a safe and sanitary condition. All devices or safeguards which are required by this code when constructed, altered, or repaired, shall be maintained in good working order. The owner, or his designated agent, shall be responsible for the maintenance of the plumbing system.

AUTHORITY NOTE: Promulgated in accordance with R.S. 40:4(A)(7) and R.S. 40:5(2)(3)(7)(9)(16)(17)(20).

HISTORICAL NOTE: Promulgated by the Department of Health and Hospitals, Office of Public Health, LR 38:2796 (November 2012).

§113. Existing Buildings

A. General. Alterations, repairs or rehabilitation work may be made to any existing plumbing installations without requiring the installations to comply with all the requirements of this code provided that the alteration, repair or rehabilitation work conforms to the requirements of this code for new construction. The plumbing official shall determine the extent to which the existing plumbing installation shall be made to conform to the requirements of this code for new construction.

B. Change of Occupancy Classification. If the occupancy classification of an existing building is changed, the plumbing installation shall be made to comply with this code.

C. Substantial Renovation. If substantial renovation of an existing building or facility is done, the plumbing installation shall be made to comply with this Part.

D. Exemptions from Code for Buildings or Facilities which had Either been Previously Permitted, Licensed or Specifically Approved by the State Health Officer. In accord with LAC 51:I.123 and unless otherwise specifically provided hereinafter, when the construction of buildings and facilities which had either been previously permitted, licensed or specifically approved by the state health officer pursuant to Public Health—Sanitary Code (LAC 51) requirements then in effect, upgrading of such buildings and facilities shall not be required except where:

1. substantial renovation of such buildings or facilities is undertaken; or

2. the ownership thereof or the business located therein changes subsequent to the effective date of this code; or,

a. The text, or a portion thereof, contained in Paragraph 2 of this Subsection above, does not apply when any particular provision of this code allows an exception to such requirement (e.g., see §411.A.1.a of this code). The non-applicable text, or portion thereof, of Paragraph 2 of this Subsection above is limited to what is allowed under the specific exception thereto.

3. a serious health threat exists as determined by the state health officer.

AUTHORITY NOTE: Promulgated in accordance with R.S. 40:4(A)(7) and R.S. 40:5(2)(3)(7)(9)(16)(17)(20).

HISTORICAL NOTE: Promulgated by the Department of Health and Hospitals, Office of Public Health, LR 38:2796 (November 2012).

§115. Special Historic Buildings

A. The provisions of this code relating to the installation, alteration, repair, enlargement, restoration, replacement or relocation of plumbing installations shall not be mandatory for existing buildings or structures identified and classified by the federal, state or local jurisdiction as special historic buildings when such installations are judged by the plumbing official to be safe and in the public interest of health, safety and welfare regarding any proposed installation, alteration, repair, enlargement, restoration, relocation or replacement.

AUTHORITY NOTE: Promulgated in accordance with R.S. 40:4(A)(7) and R.S. 40:5(2)(3)(7)(9)(16)(17)(20).

HISTORICAL NOTE: Promulgated by the Department of Health and Hospitals, Office of Public Health, LR 38:2797 (November 2012).

Subchapter C. Powers and Duties of the Plumbing Official

§117. Authority

A. Pursuant to R.S. 40:4.A(7) the state health officer is required to promulgate this code and pursuant to R.S. 40:5(3) the state health officer has the authority to enforce

this code. Any enforcement action by the state health officer shall be in accordance with Part I of the Sanitary Code, State of Louisiana (LAC 51:I), and/or applicable state laws.

AUTHORITY NOTE: Promulgated in accordance with R.S. 40:4(A)(7) and R.S. 40:5(2)(3)(7)(9)(16)(17)(20).

HISTORICAL NOTE: Promulgated by the Department of Health and Hospitals, Office of Public Health, LR 38:2797 (November 2012).

§119. Right of Entry

A. Whenever necessary to make an inspection to enforce any of the provisions of this code, or whenever the plumbing official has reasonable cause to believe that there exists in any building or upon any premises any condition or code violation which makes such building or premises unsafe, dangerous or hazardous, the plumbing official may enter such building or premises at all reasonable times to inspect the same or to perform any duty imposed upon the plumbing official by this code, provided that if such building or premises is occupied, he shall first present proper credentials and request entry. If such building or premises is unoccupied, he shall first make a reasonable effort to locate the owner or other persons having charge or control of the building or premises and request entry. If such entry is refused, the plumbing official shall have recourse to every remedy provided by law to secure entry.

B. When the plumbing official shall have first obtained a proper inspection warrant or other remedy provided by law to secure entry, no owner or occupant or any other persons having charge, care or control of any building or premises shall fail or neglect after proper request is made as herein provided, to promptly permit entry therein by the plumbing official for the purpose of inspection and examination pursuant to this code.

AUTHORITY NOTE: Promulgated in accordance with R.S. 40:4(A)(7) and R.S. 40:5(2)(3)(7)(9)(16)(17)(20).

HISTORICAL NOTE: Promulgated by the Department of Health and Hospitals, Office of Public Health, LR 38:2797.

§121. Enforcement

A. Upon determination that any plumbing system is in violation of, or not in conformity with, the provisions of this code, the plumbing official may initiate enforcement action in accordance with applicable laws, regulations and/or ordinances.

AUTHORITY NOTE: Promulgated in accordance with R.S. 40:4(A)(7) and R.S. 40:5(2)(3)(7)(9)(16)(17)(20).

HISTORICAL NOTE: Promulgated by the Department of Health and Hospitals, Office of Public Health, LR 38:2797 (November 2012).

§123. Revocation of Permits or Approvals

A. Misrepresentation of Application. The plumbing official may revoke a permit or approval, issued under the provisions of this code, in case there has been any false statement or misrepresentation as to the material fact in the application or plans on which the permit or approval was based.

B. Violation of Code Provisions. The plumbing official may revoke a permit or approval upon determination by the plumbing official that the installation, erection, alteration or repair of the plumbing installation for which the permit or approval was issued is in violation of or not in conformity with, the provisions of this code.

AUTHORITY NOTE: Promulgated in accordance with R.S. 40:4(A)(7) and R.S. 40:5(2)(3)(7)(9)(16)(17)(20).

HISTORICAL NOTE: Promulgated by the Department of Health and Hospitals, Office of Public Health, LR 38:2797 (November 2012).

§125. Unsafe Installations

A. All plumbing installations regardless of type, which are unsafe or which constitute a hazard to human life, health or welfare are hereby declared illegal and shall be abated by repair and rehabilitation or by demolition.

AUTHORITY NOTE: Promulgated in accordance with R.S. 40:4(A)(7) and R.S. 40:5(2)(3)(7)(9)(16)(17)(20).

HISTORICAL NOTE: Promulgated by the Department of Health and Hospitals, Office of Public Health, LR 38:2797 (November 2012).

§127. Requirements Not Covered By Code

A. Any requirements necessary for the strength or stability of an existing or proposed plumbing installation, or for the public safety, health and general welfare, not specifically covered by this code, shall be determined by the plumbing official.

AUTHORITY NOTE: Promulgated in accordance with R.S. 40:4(A)(7) and R.S. 40:5(2)(3)(7)(9)(16)(17)(20).

HISTORICAL NOTE: Promulgated by the Department of Health and Hospitals, Office of Public Health, LR 38:2797 (November 2012).

§129. Alternate Materials and Methods of Construction

A. The provisions of this code are not intended to prevent the use of any material or method of construction not specifically prescribed by this code, provided any such alternate has been approved by the plumbing official. The plumbing official shall approve any such alternate provided he finds that the alternate for the purpose intended is at least the equivalent of that prescribed in this code in quality, strength, effectiveness, durability and safety. The plumbing official shall require that sufficient evidence or proof be submitted to substantiate any claim made regarding its use.

AUTHORITY NOTE: Promulgated in accordance with R.S. 40:4(A)(7) and R.S. 40:5(2)(3)(7)(9)(16)(17)(20).

HISTORICAL NOTE: Promulgated by the Department of Health and Hospitals, Office of Public Health, LR 38:2797 (November 2012).

§131. Permits

A. A person, firm or corporation shall not install, enlarge, alter, repair, improve, remove, convert or replace any plumbing work, or cause the same to be done, without first obtaining a plumbing permit (where such permits are required by state, parish, city or other local laws or ordinances) from the plumbing official. Where such permits

are not available, the property owner, contractor and installer shall be jointly responsible for the installation being in compliance with the requirements of this code.

AUTHORITY NOTE: Promulgated in accordance with R.S. 40:4(A)(7) and R.S. 40:5(2)(3)(7)(9)(16)(17)(20).

HISTORICAL NOTE: Promulgated by the Department of Health and Hospitals, Office of Public Health, LR 38:2798 (November 2012).

§133. Tests

A. The plumbing official may require tests or test reports as proof of compliance. Required tests are to be made at the expense of the owner or his agent, by an approved testing laboratory or other approved agency.

AUTHORITY NOTE: Promulgated in accordance with R.S. 40:4(A)(7) and R.S. 40:5(2)(3)(7)(9)(16)(17)(20).

HISTORICAL NOTE: Promulgated by the Department of Health and Hospitals, Office of Public Health, LR 38:2798 (November 2012).

§135. Variances

A. The plumbing official has the authority and discretion to issue a written variance concerning the application of any provision of this code in any particular case when, in his/her opinion based upon the extenuating circumstances presented, it is determined that the health and safety of the public will not be jeopardized.

NOTE: Refer to §203 of this code for the definition of "plumbing official" and "state health officer". Per these definitions, variances to the requirements of this code may be legally issued only by the state health officer acting personally or by certain individuals that the state health officer personally designates. Once a variance has been issued by the state health officer acting in his capacity as the co-State plumbing official, the co-local plumbing official is not necessarily obliged to agree with the granting of such variance. In accordance with R.S. 40:14, the co-Local plumbing official may decide to deny the request for variance at the local level since local plumbing regulations are allowed to be stricter than state plumbing regulations.

AUTHORITY NOTE: Promulgated in accordance with R.S. 40:4(A)(7) and R.S. 40:5(2)(3)(7)(9)(16)(17)(20).

HISTORICAL NOTE: Promulgated by the Department of Health and Hospitals, Office of Public Health, LR 38:2798 (November 2012).

§137. Violations and Penalties

A. Any person, firm, corporation or agent; contractor; and/or installer who violates a provision of this code shall be subject to enforcement action by the plumbing official in accordance with applicable laws, regulations and/or ordinances.

AUTHORITY NOTE: Promulgated in accordance with R.S. 40:4(A)(7) and R.S. 40:5(2)(3)(7)(9)(16)(17)(20).

HISTORICAL NOTE: Promulgated by the Department of Health and Hospitals, Office of Public Health, LR 38:2798 (November 2012).

§139. Severability

A. If any Section, Subsection, Paragraph, Subparagraph, Clause, Subclause, Division, Sentence, or phrase of this Part is for any reason held to be unconstitutional, such decision

shall not affect the validity of the remaining portions of this Part.

AUTHORITY NOTE: Promulgated in accordance with R.S. 40:4(A)(7) and R.S. 40:5(2)(3)(7)(9)(16)(17)(20).

HISTORICAL NOTE: Promulgated by the Department of Health and Hospitals, Office of Public Health, LR 38:2798 (November 2012).

Chapter 2. Definitions

Subchapter A. General

§201. General

A. **Scope.** For the purpose of this Part, certain abbreviations, terms, phrases, words and their derivatives shall be construed as set forth in this Chapter or the Chapter to which they are unique.

B. **Tense, Gender, and Number.** Words used in the present tense include the future. Words in the masculine gender include the feminine and neuter. Words in the feminine and neuter gender include the masculine. The singular number includes the plural and the plural number includes the singular.

C. **Words Not Defined.** Words not defined herein shall have the meanings stated in the other Chapters of this Part or in other Parts of the Louisiana State Sanitary Code (LAC 51) which are adopted or may be adopted, the codes adopted under the authority of Act 12 of the 2005 First Extraordinary Session, or the American Society of Sanitary Engineering (ASSE) Plumbing Dictionary, Fourth Edition (1988). When words not defined herein are defined in both the Louisiana State Sanitary Code (LAC 51) and in the codes adopted under the authority of Act 12 of the 2005 First Extraordinary Session or in the ASSE's Plumbing Dictionary, Fourth Edition (1988), the definition contained within the Louisiana State Sanitary Code (LAC 51) shall be given preference as it pertains to health and/or health standards. Words not defined in any of these source documents shall have their common usage and meaning as stated in the Merriam-Webster's Collegiate Dictionary-Eleventh Edition, as revised, and other similarly accepted reference texts.

AUTHORITY NOTE: Promulgated in accordance with R.S. 40:4(A)(7) and R.S. 40:5(2)(3)(7)(9)(16)(17)(20).

HISTORICAL NOTE: Promulgated by the Department of Health and Hospitals, Office of Public Health, LR 38:2798 (November 2012).

Subchapter B. Definition of Terms

§203. Definition of Terms

Editor's Note: The text in this Section will be effective on January 1, 2013.

A. Unless otherwise specifically provided herein, the following words and terms used in this Part of the Sanitary Code (LAC 51:XIV) are defined for the purposes thereof as follows.

Access Cover—a removable plate, usually secured by bolts or screws, to permit access to a pipe or pipe fitting for the purposes of inspection, repair or cleaning.

Accessible—having access to but which first may require the removal of a panel, door or similar covering of the item described. See *readily accessible*.

Administrative Authority—see *Plumbing Official*.

Air Break (Drainage System)—a piping arrangement in which a *drain* from a fixture, device, appliance or apparatus discharges indirectly into a sink or other receptor with the *indirect waste pipe* terminating at a point below the *flood-level rim* of the receiving sink or other receptor. An unobstructed horizontal distance of free atmosphere between the outside of the *indirect waste pipe* and the inside of the receiving sink or other receptor must exist so as to allow a *back-flow* of *sewage* to spill over the *flood-level rim* of the receiving sink or other receptor to prevent such *back-flow* from reaching the fixture, device, appliance or apparatus served by the *indirect waste pipe*.

Air Gap (Drainage System)—the unobstructed vertical distance through the free atmosphere between the outlet waste pipe and the *flood-level rim* of the receptacle into which it is discharging.

Air Gap (Water Distribution)—in a *water supply or distribution system*, the unobstructed vertical distance through the free atmosphere between the lowest opening from any pipe or faucet supplying water to a tank, *plumbing fixture* or other device and the *flood-level rim* of the receptacle.

Alternate Designed Plumbing System—a type of *plumbing system* which is not designed in accord with the prescriptive requirements of this code. See Chapter 12 of this Part for special review and approval requirements prior to construction.

Anchors—see *supports*.

And/Or—in a choice of two code provisions, signifies that use of both provisions will satisfy the code requirement and use of either provision is acceptable also.

Anti-Scald Valve—see *scald preventative valve*.

Appurtenance—see *plumbing appurtenance*.

Approved—approved by the *plumbing official* or other authority having jurisdiction.

Area Drain—a receptacle designed to collect surface or rain water from an open area.

Assembly or Assembly Use—in the classification of *plumbing fixtures*, *assembly* applies to *fixtures* used by the *public* attending an event at a theatre, auditorium, stadium, arena, gymnasium or similar facility. See the theaters, auditoriums, stadiums, arenas, and gymnasiums occupancy classification listed in Table 411 of this code.

Automatic Compensating Type Shower Valve—One of three types of valves that compensate for changes in incoming pressure, temperature, or pressure and temperature. The three types of valves are:

a. *Pressure Balancing Type Shower Valve*—a pressure balancing valve (Type P) which senses incoming

hot and cold water pressures and compensates for fluctuations in either hot or cold water to stabilize the outlet temperature.

b. *Thermostatic Type Shower Valve*—a thermostatic balancing valve (Type T) which senses outlet temperature and compensates for fluctuations in either incoming hot and cold water temperatures and/or pressure to stabilize the outlet temperature.

c. *Combination Thermostatic and Pressure Balancing Type Shower Valve*—a combination thermostatic/pressure balancing valve (Type TP) which senses outlet temperature and incoming hot and cold water pressure and compensates for fluctuations in incoming hot and cold water temperatures and/or pressures to stabilize the outlet temperature.

Backflow—the flow of water or other liquids, mixtures, or substances into the distribution pipes of a potable *water supply system* and/or *water distribution system* from any source or sources other than its intended source.

Backflow Connection—any arrangement whereby *backflow* can occur.

Backflow Preventer—a mechanical device which prevents *backflow* of contaminants and pollutants into the potable water supply or distribution system by means of positive check members in addition to atmospheric ports.

Backflow Prevention Assembly—a testable *backflow preventer* which comes assembled from the manufacturer as a complete unit having approved test cocks with shut off valves installed on both the inlet and outlet sides of the *backflow preventer*.

Back Vent—see *individual vent*.

Back Water Valve—a device (check valve) installed in a *drain* or pit or in the sewer or *drainage system* to prevent *sewage* or drainage from backing into low levels through fixtures or devices not installed sufficiently above sewer or *drainage systems*.

Battery of Fixtures—any group of two or more similar adjacent fixtures which discharge into a common horizontal waste or soil branch.

Battery Venting—the horizontal wet venting of a number of individual *fixture drains*, connected horizontally to a *branch soil* or *waste pipe* which is circuit or loop vented.

Beneficial Use—the technologically feasible uses of *reclaimed water* for domestic, municipal, industrial, agricultural, recreational or therapeutic purposes.

Boiler Blow Off—an outlet on a boiler to permit emptying or discharge of sediment.

Branch—any part of the piping system other than a *main*, *riser*, or *stack*.

Branch, Fixture—see *fixture branch*.

Branch, Horizontal—see *horizontal branch*.

Branch Interval—a length of soil or waste stack corresponding in general to a story height, but in no case less than 8 feet (ft) (2438 mm), within which the *horizontal branches* from one floor or story of a building are connected to the *stack*.

Branch Vent—a vent connecting one or more individual vents with a vent stack or stack vent.

Building—any structure built, erected, and framed of component structural parts designed for the housing, shelter, enclosure, or support of persons, animals, or property of any kind.

Building Drain—that part of the lowest piping of a *drainage system* which receives the discharge from *soil pipes* and *waste pipes* inside the walls of the *building* and conveys it to the *building sewer* 3 ft (914 mm) outside the *building* wall.

Building Sewer—that part of the horizontal piping of a *drainage system* which extends from the ends of the *building drain* and which receives the discharge of the *building drain* and conveys it to:

- a. the lateral or main of a community sewerage system;
- b. the inlet connection of the primary treatment device of either an individual sewerage system or a commercial treatment facility; or,
- c. any other point of sewage disposal.

Building Storm Drain—a *building drain* used for conveying rain water, surface water, ground water, subsurface water, condensate, cooling water or other similar discharge to a *building storm sewer*, extending to a point not less than 3 ft (914 mm) outside the building wall.

Building (House) Storm Sewer—the extension from the building storm drain to the public storm sewer or other point of disposal.

Building (House) Subdrain—that portion of a drainage system which cannot drain by gravity into the building storm sewer.

Building (House) Trap—a device, fitting, or assembly of fittings installed in the *building drain* to prevent circulation of air between the *drainage system* of the *building* and the *building sewer*.

Circuit Vent—a *branch vent* that serves two or more *traps* and extends from immediately downstream of the uppermost *fixture connection* of a *horizontal branch* to the *vent stack*.

Code—generally, refers to Part XIV (Plumbing) of the Sanitary Code, state of Louisiana which may be cited as the “Louisiana State Plumbing Code”, herein referred to as “this code” or “this Part”. Any reference or citation to the Louisiana State Plumbing Code shall likewise be synonymous to any reference or citation to Part XIV (Plumbing) of the Sanitary Code, State of Louisiana. In certain instances, use of this term (*code*) may refer to the

entire Louisiana State Sanitary Code (LAC 51) or to certain other Parts of the State Sanitary Code besides Part XIV.

Combination Fixture—a fixture combining one sink and tray or a two or three-compartment sink and/or tray in one unit.

Combination Waste and Vent System—an alternate designed plumbing system of waste piping embodying the horizontal wet venting of one or more sinks, dishwashers, floor sinks, indirect waste receptors, floor drains, or similar applications where the fixtures are not adjacent to walls or partitions. It consists of an enlarged diameter horizontal waste pipe which has been adequately sized to provide for the free movement of air above the flow line of the drain to ensure an adequate vent system. In this non-conventional or non-prescriptive plumbing system [which requires special approval from the state health officer prior to construction (see Chapter 12 of this code)], each trap of each plumbing fixture does not contain an individual vent. This system is different from battery venting in that it is not necessarily constrained by all of the limits prescribed under the battery venting requirements.

Commercial—more suitable for a business or industrial use rather than a *domestic* use. Floor drains, floor sinks, curbed cleaning facilities (with floor drain), hub drains, and commercial dishwashing machines (used in restaurants, for example) are considered *commercial*.

Commercial Treatment Facility—any sewage treatment facility (designed in accordance with LAC 51:XIII.503) which is required by the state health officer whenever the use of an individual sewerage system is unfeasible or not authorized.

Common Vent—a vent connecting at the junction of two *fixture drains* and serving as a vent for both fixtures.

Community Sewerage System—any sewerage system which serves multiple connections and consists of a collection and/or pumping/transport system and sewage treatment facility.

Conductor—see *leader*.

Continuous Vent—a vertical vent that is a continuation of the *drain* to which it connects.

Continuous Waste—a *drain* from two or three fixtures connected to a single *trap*.

Critical Level—the minimum elevation above the *flood-level rim* of the fixture or receptacle served at which a *backflow preventer* device may be installed. The *critical level* marking on a *backflow preventer* device, including but not limited to a *vacuum breaker*, is normally a horizontal line usually stamped on the device by the manufacturer, the location of which has been established by the manufacturer to conform the device to an accepted standard with the goal of having an approved installation of the device to ensure the proper functioning of the device for cross connection control protection purposes. When a *backflow preventer* device does not bear a *critical level* marking, the bottom of the *vacuum*

breaker, combination valve or the bottom of any approved *backflow preventer* device shall constitute the *critical level*.

Cross Connection—any physical connection or arrangement between two otherwise separate piping systems, one of which contains *potable water* and the other, water of unknown or questionable safety, whereby water may flow from one system to the other, the direction of flow depending on the pressure differential between the two systems. See *backflow* and *back-siphonage*.

Crown of Trap—the topmost point of the inside of a *trap's* outlet.

Dead End—a *branch* leading from a *soil*, *waste*, or *vent pipe*, *building drain*, or *building sewer*, which is terminated at a *developed length* of 2 ft (610 mm) or more by means of a plug or other closed fitting.

Depth of Water Seal—the depth of water which would have to be removed from a fully charged *trap* before air could pass through the *trap*.

Developed Length—the length of a pipe along the center line of the pipe and fittings.

Diameter—the nominal diameter as designated commercially, unless otherwise stated.

Domestic—associated with service to mankind and the activities of his home or *private* residence, the household, household affairs, the family, guest rooms of hotels and motels, and patient rooms of hospital and nursing homes and guest rooms of similar institutions. Water for and *liquid waste* from lavatories, water closets, tubs and showers, kitchens, sinks, and home laundries are considered domestic.

Double Offset—two changes of direction installed in succession or series in continuous pipe.

Downspout—see *Leader*.

Drain—any waste pipe or soil pipe which carries *waste* water or waterborne *wastes* in a building *drainage system*.

Drainage Piping—see *Drainage System*.

Drainage System—all the piping within *public* or *private* premises, which conveys *sewage*, rain water, or other liquid wastes to a legal point of disposal, but not including:

- a. the laterals or mains of a community sewerage system;
- b. any *individual sewerage system* or *commercial treatment facility* (beginning at the inlet connection of the primary treatment device and any parts downstream); or,
- c. any *sewage* treatment or disposal plant for any *community sewerage system*.

Durham System—a term used to describe *soil* or *waste* pipe systems where all piping is of threaded pipe, tubing, or other such rigid construction, using recessed drainage fittings to correspond to the types of piping.

Effective Opening—

a. the minimum cross-sectional area of the *water outlet* at the point of water supply discharge or the minimum cross-sectional area of the *liquid waste* outlet at the point of *indirect waste pipe* discharge, measured or expressed in terms of:

- i. diameter of a circle; or,
- ii. if the outlet is not circular, the diameter of a circle of equivalent cross-sectional area.

b. This term is applicable to and mainly used when determining the minimum unobstructed vertical distance through the free atmosphere {*air gap (water distribution)*} required between the *water outlet* and the *flood rim level* of the *fixture* or receptacle into which it is discharging. This term may also be applicable when determining the minimum unobstructed vertical distance through the free atmosphere {*air gap (drainage system)*} required between a *liquid waste* outlet of an *indirect waste pipe* and the *flood rim level* of the *indirect waste receptor*.

Existing Work—a *plumbing system* or any part thereof which has been installed prior to the effective date of this code.

Fixture—see *Plumbing Fixtures*.

Fixture Branch—a water supply pipe between the *fixture* supply and a *main*.

Fixture Drain—the *drain* from the *trap* of a *fixture* to the junction of that *drain* with any other *drain* pipe.

Fixture Supply—a water supply pipe or flexible connector that connects a *fixture* to a *fixture branch*.

Fixture Tail Piece or Connection—a pipe or other connection located between a *fixture* and its *trap*.

Fixture Unit—a quantity in terms of which the load-producing effects on the *plumbing system* of different kinds of *plumbing fixtures* are expressed on some arbitrarily chosen scale. The value assigned for a particular *plumbing fixture* represents the degree to which it is expected to load a *plumbing system* when it is used at the maximum assumed frequency.

Fixture Unit Flow Rate—the total discharge flow in gallons per minute of a single *fixture* divided by 7.5 (gal/ft³) which provides the flow rate of that particular *plumbing fixture* as a unit of flow. *Fixtures* are rated as multiples of this unit of flow. (One gallon per minute equals 0.0631 liters per second.)

Flood-Level Rim—the top edge of the receptacle from which water overflows.

Floor Drain—a *plumbing fixture* for recess in the floor having a floor level strainer intended for the purposes of the collection and disposal of *waste* water used in cleaning the floor and for the collection and disposal of accidental spillage to the floor. This definition does not include *floor sinks* and *indirect waste receptors*.

Floor Sink—a type of *indirect waste receptor* installed as a floor level sink and designed with a removable basket

strainer or beehive strainer for the purpose of receiving the discharge from *indirect waste pipes* only. This classification does not include *floor drains* with floor level strainers only but may include 3-inch (76 mm) drains with floor level strainers which incorporate funnel drains as an integral part thereof.

Flush Tank—a tank located above or integral with water closets, urinals, or similar fixtures for the purpose of flushing the usable portion of the *fixture*. Other than normal atmospheric pressure, the water in the tank is not stored under any other external pressure and the water released from the tank is considered a gravity flush.

Flush Valves—a device located at the bottom of the *flush tank* for the purpose of flushing water closets and similar *fixtures*.

Flushometer Tank—a device integrated within an air accumulation vessel which is designed to discharge a predetermined quantity of water (which has been stored under pressure) to *fixtures* for flushing purposes.

Flushometer Valve—a device which discharges a predetermined quantity of water to *fixtures* for flushing purposes and is actuated by direct water line pressure.

Frostproof Closet—a hopper that has no water in the bowl and has the *trap* and the control valve for its water supply installed below the frost line.

Fueling Points—the number of fueling hoses which may be activated simultaneously while refueling automobiles or other motor vehicles.

Gang Shower—two or more showers in a common area within an institutional building.

Grade_(G)—normally, this references the location of some object in relation to either the floor or ground level elevation.

Grade_(L)—level of achievement attained in school.

Grade_(Q)—a classification or standard of quality of some object or material.

Grade_(S)—the vertical slope (or vertical rise or fall) of a line of pipe in reference to a horizontal plane. In drainage, it is usually expressed as the fall in a fraction of an inch per foot length of pipe or by stating the fall as a percentage of the horizontal distance.

Grease Interceptor—an *interceptor* of less than 125 gallon capacity which is designed and installed so as to separate and retain grease and which is generally installed indoors entirely above *grade_(G)*.

Grease Trap—an *interceptor* of at least 125 gallon capacity which is designed and installed so as to separate and retain grease and which is generally installed below *grade_(G)* outdoors with provisions for above *grade_(G)* accessibility for cleaning purposes.

Hangers—see *supports*.

Horizontal Branch—a *drain pipe* extending laterally from a soil or waste stack or *building drain*, with or without vertical sections or branches, which receives the discharge from one or more *fixture drains* and conducts it to the soil or waste stack or to the *building drain*.

Horizontal Pipe—any pipe or fitting which makes an angle of more than 45 degrees (0.785 rad) with the vertical.

House Drain—see *building drain*.

House Sewer—see *building sewer*.

House Trap—see *building (house) trap*.

Human Consumption—the use of water by humans for drinking, cooking, bathing, showering, hand washing, dishwashing, or maintaining oral hygiene.

Indirect Waste Receptor—a *plumbing fixture* designed specifically to collect and dispose of *liquid waste* received from an *indirect waste pipe* which is connected to other *plumbing fixtures*, plumbing equipment or appliances which are required to discharge to the *drainage system* through either an *air gap (drainage system)* or *air break (drainage system)*. The following type fixtures fall within the classification of *indirect waste receptors*: *floor sinks*, curbed cleaning facilities with floor drain, and standpipe drains with integral *air gaps (drainage system)* or *air breaks (drainage system)*, and may include others when approved as such by the *plumbing official*.

Indirect Waste Pipe—a pipe that does not connect directly with the *drainage system* but conveys *liquid wastes* and then discharges such liquid wastes into an *indirect waste receptor* which is directly connected to the *drainage system*.

Individual Sewerage System—any system of piping (excluding the *building drain* and *building sewer*), and/or collection and/or transport system which serves one or more connections, and/or pumping facility, and treatment facility, all located on the property where the *sewage* originates; and which utilizes the *individual sewerage system* technology which is set forth in LAC 51:XIII.Chapter 7.Subchapter B, or a *commercial treatment facility* which is specifically authorized for use by the *state health officer*.

Individual Vent—a pipe installed to vent an individual *fixture trap* and which connects with the *vent system* above the *fixture* served or terminates in the open air.

Industrial Wastes—*liquid wastes* resulting from the processes employed in industrial establishments and free of fecal matter.

Insanitary—as opposed to *sanitary*; deficient in sanitation; unclean to a degree to be injurious to health; careless or dangerous hygienic conditions; contrary to *sanitary* principles.

Interceptor—an automatic or manual device designed and installed to separate and retain deleterious, hazardous, detrimental, damaging, or undesirable matter from normal wastes for proper disposal, rendering or recycling, and also permits normal *sewage* and *liquid wastes* to discharge into the disposal terminal by gravity.

Journeyman Plumber—a natural *person* who possesses the necessary qualifications and knowledge to install, alter and/or repair *plumbing systems*; is licensed as such by the State Plumbing Board of Louisiana; is supervised by a *master plumber* and is in the employ of an employing entity. [see R.S. 37:1377(B)]

LAC—*Louisiana Administrative Code*.

Laundry Tray—typically, a large and deep 1 or 2 compartment sink used to wash and rinse laundry.

Leader—the water conductor (downspout) from the roof to the building storm drain or other means of disposal.

Lead Free—

- a. in general:
 - i. not containing more than 0.2 percent lead when used with respect to solder and flux; and,
 - ii. not more than a weighted average of 0.25 percent lead when used with respect to the wetted surfaces of pipes, pipe fittings, plumbing fittings, and fixtures.

b. calculation:

- i. The weighted average lead content of a pipe, pipe fitting, plumbing fitting, or fixture shall be calculated by using the following formula:

- (a). For each wetted component, the percentage of lead in the component shall be multiplied by the ratio of the wetted surface area of that component to the total wetted surface area of the entire product to arrive at the weighted percentage of lead of the component. The weighted percentage of lead of each wetted component shall be added together, and the sum of these weighted percentages shall constitute the weighted average lead content of the product. The lead content of the material used to produce wetted components shall be used to determine compliance with Clause a.ii. above. For lead content of materials that are provided as a range, the maximum content of the range shall be used.

Listed—equipment or materials included in a list published by an approved nationally recognized testing laboratory, inspection agency or other organization concerned with product evaluation that maintains periodic inspection of production of *listed* equipment or materials, and whose listing states either that the equipment or material meets nationally recognized standards or has been tested and found suitable for use in a specified manner. The means for identifying *listed* equipment may vary for each testing laboratory, inspection agency, or other organization concerned with product evaluation, some of which do not recognize equipment as *listed* unless it is also labeled. The *plumbing official* should utilize the system employed by the listing organization to identify a *listed* product.

- a. In respect to any solder, flux, pipes, pipe fittings, plumbing fittings, or fixtures which are claimed to be lead free, this defined term (*listed*) shall additionally include the requirement that all such solder, flux, pipes, pipe fittings, plumbing fittings, or fixtures have been certified to be lead

free by an independent American National Standards Institute (ANSI)-accredited third party testing laboratory, inspection agency or other organization concerned with product evaluation.

Liquid Waste—the discharge from any *fixture*, appliance, or appurtenance, in connection with a *plumbing system* which does not receive fecal matter.

Load Factor—the percentage of the total connected *fixture unit* flow rate which is likely to occur at any point in the *drainage system*. It varies with the type of occupancy, the total flow unit above this point being considered, and with the probability factor of simultaneous use.

Local Vent—a *vent pipe* which is independent of and not connected to the normal *sanitary sewer* vent piping system and which also terminates in the outside atmosphere in accord with the requirements of Section 907 of this code. It is in no way interconnected with any other *vent pipe* except that the same type of apparatus may be served by a given vent [e.g., one local vent (properly sized) may serve either multiple indirect waste pipes, multiple bedpan washers, or multiple sterilizer vents serving sterilizing apparatus]. Only one type of apparatus shall be served by a given vent. Connections between local vents and normal sanitary plumbing systems are prohibited.

Loop Vent—same as a *circuit vent* except that it loops back and connects with the *stack vent* instead of the *vent stack*.

Main—the principal artery of any system of continuous piping, to which branches or laterals may be connected.

Main Vent—the principal artery of the venting system, to which the vent branches may be connected.

Manifold—a device wherein multiple individual distribution pipes are commonly connected and supplied with water. Each individual distribution pipe may be provided with a secondary shutoff valve. If provided, such secondary shutoff valve is located between the *manifold* and the individual distribution pipe.

Manifold Individual Distribution Pipe—the specific *water distribution pipe* which delivers water directly from the *manifold* and which terminates at the individual *fixture* water shutoff valve located on the *fixture* side of the wall. This term does not include the fixture supply line from the *fixture* valve to the water connection on the *fixture* itself.

Master Plumber—a natural *person* who possesses the necessary qualifications and knowledge to plan and lay out *plumbing systems*; who supervises *journeyman plumbers* in the installation, alteration and/or repair of *plumbing systems* and who is licensed as such by the State Plumbing Board of Louisiana. [see R.S. 37:1377(A)]

May—the word "*may*" is a permissive term.

Mop Sink—see *service sink*.

Nonpotable Water—in addition to its ordinary meaning, includes water of questionable potability on the discharge side of a *backflow preventer* used to isolate a portion of a

water distribution system from the remainder of the *water distribution system* due to *backflow* connections.

Nuisance—public *nuisance* as known at common law or in equity jurisprudence; and whatever is dangerous to human life or detrimental to health; whatever building, structure, or premises is not sufficiently ventilated, sewerred, drained, cleaned, or lighted, in reference to its intended or actual use; and whatever renders the air or human food or drink or water supply unwholesome.

Offset—a combination of elbows or bends in a line of piping which brings one section of the pipe out of the line but into a line parallel with the other section.

Permit Holder—any *person* required to obtain a permit to do *plumbing* work in accordance with state, parish, city or other local laws or ordinances. (Where such permits are not available, the property owner, contractor and installer shall be jointly responsible for the installation being in compliance with the requirements of this code and, where applicable, may all be considered *permit holders* as the term is used in this code.)

Person—a natural *person*, his heirs, executors, administrators, or assigns; and includes a firm, partnership or corporation, it's or their successors or assigns, the state of Louisiana or any of its political subdivisions, the United States government or any of its political subdivisions and any officer, employee and agent of one of those entities. Singular includes plural; male includes female.

Pitch—see *grade(s)*.

Plumbing—the practice, materials and *fixtures* used in the installation, maintenance, extension and alteration of all piping, *fixtures*, appliances and appurtenances in connection with any of the following: *Sanitary* drainage or storm drainage facilities, the venting system and the *water distribution system*, within or adjacent to any building, structure or conveyance; also the practice and materials used in the installation, maintenance, extension or alteration of medical gas piping, medical vacuum piping, storm water, *liquid waste* or *sewage*, and the *water distribution system* of any premises to their connection with any point of disposal or other acceptable terminal. *Plumbing* does not include the installation, alteration, repair or maintenance of automatic sprinklers and their related appurtenances including standpipes when connected to automatic sprinklers and including the underground or overhead water supply beginning at the outlet of an approved *backflow* prevention device installed under the *plumbing* provisions of this code where water is to be used or is intended for use exclusively for fire protection purposes.

Plumbing Appurtenance—manufactured device, or a prefabricated assembly, or an on-the-job assembly of component parts, which is an adjunct to the basic piping system and *plumbing fixtures*. An appurtenance demands no additional water supply, nor does it add any discharge load to a *fixture* or the *drainage system*. It is presumed that it performs some useful function in the operation,

maintenance, servicing, economy, or safety of the *plumbing system*.

Plumbing Fixtures—are installed receptacles, devices, or appliances which are supplied with water or which receive or discharge liquids or liquid-borne wastes, with or without discharge into the *drainage system* with which they may be directly or indirectly connected.

Plumbing Inspector—see *plumbing official*.

Plumbing Official—the *state health officer* and any individual official, board, department or agency established and authorized by a state, parish, city or other political subdivision created by law to administer and enforce the provisions of this code as adopted or amended. (Note: Since two persons/entities comprise the term *Plumbing Official*, for purposes of this code, the *state health officer* is sometimes referred to as the "co-State Plumbing Official" and the local plumbing jurisdiction is sometimes referred to as the "co-Local Plumbing Official".)

Plumbing System—includes the water-supply and distribution pipes; *plumbing fixtures* and *traps*; *soil*, *waste* and *vent pipes*; *building drains* and *building sewers* including their respective connections, devices and *appurtenances* within the property lines of the premises; water treating or water using equipment; and medical gas and medical vacuum piping and equipment.

Potable Water—water having bacteriological, physical, radiological and chemical qualities that make it safe and suitable for human consumption.

Pressure—the normal force exerted by a homogenous liquid or gas, per unit of area, on the wall of the container.

a. *Pressure, Static*—the pressure existing without any flow.

b. *Pressure, Flowing*—the residual *pressure* in the water supply pipe at the faucet or water outlet while the faucet or water outlet is wide open and flowing.

c. *Pressure, Residual*—the *pressure* available at the fixture or water outlet after allowance is made for *pressure* drop due to friction loss, head, meter and other losses in a system during maximum demand periods.

Private or *Private Use*—in the classification of *plumbing fixtures*, *private* applies to *fixtures* in residences or apartments and similar installations where the *fixtures* are intended for the use of a family or an individual.

Public or *Public Use*—in the classification of *plumbing fixtures*, *public* applies to fixtures in general, toilet rooms of schools, gymnasiums, hotels and motels, airports, bus and railroad stations, office buildings, *public* buildings, stadiums, department and mercantile stores, *public* comfort stations, bars, restaurants, commercial buildings or places to which the *public* is invited or which are frequented by the *public* without special permission or special invitation, and other installations (whether pay or free) where a number of fixtures are installed so that their use is similarly unrestricted.

Reclaimed Water—treated wastewater effluent meeting the requirements of the Louisiana Reclaimed Water Law (R.S. 30:2391 et seq.) that is suitable for a direct *beneficial use* or a controlled use and that is therefore considered a valuable resource.

Readily Accessible—having direct access without the need of removing any panel, door or similar covering of the item described and without requiring the use of portable ladders, chairs, etc. See *Accessible*.

Relief Vent—a vent whose primary function is to provide circulation of air between the *drainage system* and *vent system*.

Residential Buildings—buildings in which families or households live and in which cooking and sleeping accommodations are provided for each family or household unit independently, and in which no area within the building is used or occupied for any other purpose except that such buildings may have central washing facilities, as permitted in Chapter 4.

Return Offset—a double *offset* installed so as to return the pipe to its original alignment.

Revent Pipe—that part of a vent pipe line which connects directly with an individual waste or group of wastes, underneath or in back of the *fixture* and extends either to the *main vent* or *branch vent*. Sometimes called an *individual vent*.

Riser—a water supply pipe which extends vertically one full story or more to convey water to *branches* or *fixtures*.

Roof Drain—a drain installed to receive water collecting on the surface of a roof and to discharge it into the *leader* (downspout).

Roughing-In—the installation of all parts of the *plumbing system* which can be completed prior to the installation of *fixtures*. This includes drainage, water supply, and vent piping, and the necessary *fixture* supports.

Sand Interceptor—an *interceptor* used to remove sand from the *liquid waste* stream.

Sanitary—for or relating to the preservation or restoration of health; associated with measures or equipment for improving conditions that influence health; free from or effective in preventing or checking an agent injurious to health; a water closet, urinal, or similar equipment fitted with appropriate *plumbing* for the purpose of conducting wastewater to a point of collection and treatment prior to discharge.

Sanitary Sewage—see *sewage*.

Sanitary Sewer—a pipe which carries *sewage* and excludes storm, surface and ground water.

Scald-Preventative Valve—a type of valve placed in a water distribution system which is designed to prevent *persons* from being scalded with hot water when using certain types of plumbing fixtures. The valve uses one of the following technologies in its design:

a. a pressure balancing valve which senses incoming hot and cold water pressures and compensates for fluctuations in either to stabilize outlet temperature;

b. a thermostatic valve which senses outlet temperature and compensates for fluctuations in incoming hot and cold water temperatures and pressures to stabilize outlet temperature; or,

c. a combination thermostatic/pressure balancing valve which senses outlet temperature and incoming hot and cold water pressures and compensates for fluctuations in incoming hot and cold water temperatures and pressures to stabilize outlet temperature.

Scupper—an opening in a wall or parapet that allows water to drain from a roof.

Separator—see *interceptor*.

Septic Tank—a watertight receptacle which receives the discharge of a building sewer and is designed and constructed so as to separate solids from the liquid, digest organic matter through a period of detention, and allow the liquid effluent to discharge into soil absorption trenches, an oxidation pond, a deep-type sand filter bed, and/or an effluent reduction option outside of the tank, all as approved and permitted by the state health officer under the requirements of Part XIII (Sewage Disposal) of the Louisiana State Sanitary Code (LAC 51:XIII).

Service Sink (slop/mop sink)—a deep bowl fixture intended for the filling and emptying of buckets or pails. Generally used for janitorial services.

Sewage—any *liquid waste* and/or other waste containing animal or vegetable matter in suspension or solution (and may include liquids containing chemicals in solution), the disposal of which requires a *sewerage system* approved and authorized by the *state health officer*, and may include its conveying liquid and/or other liquid or solid material which may be present therein.

Sewerage System—any system of piping (excluding the *building drain* and *building sewer*) and/or collection and/or transport system and/or pumping facility and/or treatment facility, all for the purpose of collecting, transporting, pumping, treating and/or disposing of *sewage*.

Shall—mandatory requirements.

Should—recommended or advisory procedures or equipment (i.e., not a mandatory requirement).

Side Vent—a *vent pipe* connecting to the drain pipe through a fitting at an angle not greater than 45 degrees (0.785 rad) to the vertical.

Slip Joint—a mechanical type joint used primarily on *fixture traps*. The joint tightness is obtained by compressing a friction type washer such as rubber, nylon, neoprene, lead or special packing material against the pipe by the tightening of a (slip) nut.

Slope—see *grade_(s)*.

Slop Sink—see *service sink*.

Soil Pipe—any pipe which conveys the discharge of water closets or *fixtures* having similar functions, with or without the discharge from other *fixtures*, to the *building drain* or *building sewer*.

Solvent Cement—an adhesive (solvent) or mixture of adhesives which when applied to the surface of pipe and fittings will soften and fuse the plastic resin or compound of resins. Pipes and fittings are then joined causing the surfaces to unite forming a liquid tight joint.

Special Waste Pipe—see Chapter 8 of this code.

Spill-Proof Vacuum Breaker—an assembly consisting of one check valve force-loaded closed and an air inlet valve force-loaded open to atmosphere, positioned downstream of the check valve.

Stack—the vertical *main* of a system of soil, waste or vent piping.

Stack Group—a term applied to the location of *fixtures* in relation to the *stack* so that by means of proper fittings, vents may be reduced to a minimum.

Stack Vent—the extension of a soil or waste *stack* above the highest horizontal *drain* connected to the *stack*. Sometimes called *waste vent* or soil vent.

Stack Venting—a method of venting *fixtures* on a single *branch interval* through the soil or waste *stack*.

State Health Officer—means the legally appointed and/or acting *state health officer* as defined in R.S. 40:2 and includes his/her duly authorized technical representative; however, in the case of variances allowed under Section 105 of this code, this term shall mean the *state health officer* acting personally or any such *person* that the *state health officer* has personally designated to duly sign such variances in his/her behalf.

Storm Drain—see *building storm drain*.

Storm Sewer—a sewer used for conveying rain water, surface water, condensate, cooling water or similar *liquid wastes*.

Subsoil Drain—a *drain* which receives only subsurface or seepage water and conveys it to a place of collection and/or disposal.

Substantial Renovation—

a.i. alterations or repairs made within a 12 month period, costing in excess of 50 percent of the then physical value of the existing building; or

ii. alterations or repairs made within a 12 month period, costing in excess of \$15,000; or

iii. alterations or repairs made involving a change in "occupancy classification" or use of the property.

b. The physical value of the building in Clause a.i of this Paragraph may be established by an appraisal not more than three years old, provided that said appraisal was performed by a certified appraiser or by the tax assessor in the parish where the building is located.

c. The cost of alterations or repairs in Clause a.ii or a.iii of this Paragraph may be established by:

i. an estimate signed by a licensed architect or a licensed general contractor; or

ii. by copies of receipts for the actual costs.

d. The text contained in Subparagraphs a.i - c.ii of this Paragraph continues to apply when any particular portion of this code calls for an additional requirement to the term substantial renovation (e.g., see §411.A.1 of this code).

Sump—a tank or pit which receives *sewage* or *liquid waste*, located below the normal *grade(s)* of the gravity system and which must be emptied by mechanical means.

Supports—devices used for supporting and securing pipe and *fixtures* to walls, ceilings, floors or structural members.

This Code—LAC 51:XIV and synonymous to *this Part*.

This Part—LAC 51:XIV and synonymous to *this code*.

Toe—the point where the interstate highway's exit/entrance ramp meets the intersecting highway.

Trailer Trap—a device, fitting or assembly of fittings installed in the *building sewer* for a *travel trailer* or *mobile/manufactured home* which is used to prevent the circulation of air between the *building sewer* and the *drainage system* of the individual *travel trailer* or *mobile/manufactured home*.

Trap—a fitting or device so designed and constructed as to provide, when properly vented, a liquid seal which will prevent the back passage of air without materially affecting the flow of *sewage* or *waste water* through it.

Trap Primer (drainage type)—an approved device complying with ASSE 1044 designed to deliver a sufficient amount of wastewater to a seldom used *trap* in order that the *trap seal* may be properly maintained.

Trap Primer (potable water supply fed type)—an approved device designed to deliver a sufficient amount of water obtained directly from a potable water pressure pipe to a seldom used *trap* in order that the *trap seal* may be properly maintained.

Trap Seal—the maximum vertical depth of liquid that a *trap* will retain, measured between the *trap's* crown weir and the top of the dip of the *trap*.

Trap Seal Primer Valve—see *trap primer* (potable water supply fed type).

Unstable Ground—earth that does not provide a uniform bearing for the barrel of the sewer pipe between the joints at the bottom of the pipe trench.

Vacuum Breaker—a device which prevents *back-siphonage* of water by admitting atmospheric pressure through ports to the discharge side of the device.

Vent Pipe—see *vent system*.

Vent Stack—a vertical *vent pipe* installed primarily for the purpose of providing circulation of air to and from any part of the *drainage system*.

Vent System—a pipe or pipes installed to provide a flow of air to or from a *drainage system* or to provide a circulation of air within such system to protect *trap seals* from siphonage and back pressure.

Vertical Pipe—any pipe or fitting which is installed in a vertical position or which makes an angle of not more than 45 degrees (0.785 rad) with the vertical.

Wash Rack—a floor or slab area with *floor drain* used for cleaning containers and equipment exposed to organic wastes of food origin.

Waste—see liquid waste and industrial wastes.

Waste Pipe—a pipe which conveys only *liquid waste*, free of fecal matter.

Waste Vent—see *stack vent*.

Water Distribution Pipe—the piping within a building or structure which conveys cold or hot water from the *water service pipe* to the *plumbing fixtures* and other water outlets.

Water Distribution System—the system of pipes that is installed and maintained by the owner or owners on the premises or private property from the discharge side of the meter, the *water main*, or other approved sources of water supply. This system includes the necessary connecting pipes, fittings, control valves, all *appurtenances* connected thereto, and includes fire protection piping if not installed as a separate system.

Water Heater—an appliance for supplying potable hot water for domestic or commercial purposes.

Water Main—the principal artery (or arteries) used for the distribution of *potable water* to consumers by a *water supply system*. For publicly-owned water supply systems (e.g., municipal water supply systems), water mains are normally located on public property, in the street, or in an approved dedicated easement.

Water Outlet—as used in connection with the *water distribution system*, the discharge opening for the water to:

- a. a fixture;
- b. atmospheric pressure (except into an open tank which is part of the water distribution system);
- c. a boiler or heating system; or,
- d. any water-operated device or equipment, but not a part of the *plumbing system*.

Water Riser Pipe—see riser.

Water Service Pipe—the pipe from the *water main*, water meter, *water supply system* or other approved source of water supply, to the building or structure served.

Water Supply System—the system of pipes or other constructed conveyances, structures and facilities through which water is obtained, treated (if necessary) to make it

potable and then distributed (with or without charge) for *human consumption* or other use.

Wet Bar—a bar within a food service establishment at which patrons may walk up to, order, and receive an alcoholic beverage directly from a bartender.

Wet Vent—a vent which receives the discharge from wastes other than water closets.

Yoke Vent—a pipe connecting upward from a soil or waste *stack* to a *vent stack* for the purpose of preventing pressure changes in the *stacks*.

AUTHORITY NOTE: Promulgated in accordance with R.S. 40:4(A)(7), R.S. 40:5(2)(3)(7)(9)(16)(17)(20), and R.S. 40:1299.27.1.

HISTORICAL NOTE: Promulgated by the Department of Health and Hospitals, Office of Public Health, LR 38:2798 (November 2012).

Chapter 3. General Regulations

§301. General

A. Scope. The provisions of this Chapter shall govern the general regulations not specific to other Chapters.

B. Basic Principles. The basic principles of this Subsection are enunciated below as basic goals in environmental sanitation worthy of accomplishment through properly designed, acceptably installed and adequately maintained plumbing systems. Some of the details of plumbing construction must vary, but the basic sanitary and safety principles are the same. The principles may serve to define the intent of this Part and other applicable Parts of the Louisiana State Sanitary Code (LAC 51).

1. Principle Number 1. Buildings, structures and premises intended for human habitation, occupancy, use of employment, or the preparation or processing of food, drinks or other materials for human consumption shall be provided with an adequate, safe and potable water supply through a safe system of piping to all fixtures, appliances, appurtenances, etc.

2. Principle Number 2. Every building having plumbing fixtures installed and intended for human habitation, occupancy or use on premises abutting on a street, alley or easement in which there is a community sewerage system shall have a separate connection with the sewer main.

3. Principle Number 3. A dwelling type building provided with a drainage system, a community sewerage system connection or an individual sewerage system shall have at least one water closet, one bathtub or shower, one lavatory, one kitchen-type sink and an adequate source of hot water for each family unit to meet minimum basic requirements for health, sanitation and personal hygiene. Water heating facilities shall be accessible for emergency maintenance without entering any individual apartment or living unit, except that water heaters may be located within an apartment or living unit when supplying hot water to that unit only. All other buildings, structures or premises intended for human occupancy or use shall be provided with

adequate sanitary facilities as may be required, but not less than one water closet and one lavatory.

4. Principle Number 4. Plumbing fixtures shall be made of smooth nonabsorbent material, shall be free from concealed fouling surfaces, and shall be located in ventilated enclosures.

5. Principle Number 5. Each fixture directly connected to the sanitary drainage system shall be equipped with a water-seal trap.

6. Principle Number 6. No substance which will clog the pipes, produce explosive mixtures, destroy the pipes or their joints or interfere unduly with the sewage disposal process shall be allowed to enter the building drainage system.

7. Principle Number 7. Proper protection shall be provided to prevent contamination of food, water, sterile goods and similar materials by backflow of sewage. When necessary, the fixture, device or appliance should be connected indirectly with the building drainage system.

8. Principle Number 8. No water closet shall be located in a room or compartment which is not properly lighted and ventilated.

9. Principle Number 9. If water closets or other plumbing fixtures are installed in buildings where there is no sewer within a reasonable distance, suitable provision shall be made for disposing of the building sewage by some accepted method of sewage treatment and disposal.

10. Principle Number 10. Where a plumbing drainage system may be subject to backflow of sewage, suitable provisions shall be made to prevent its overflow in the building.

11. Principle Number 11. Plumbing shall be installed with due regard to preservation of the strength of structural members and prevention of damage to walls and other surfaces through fixture usage.

12. Principle Number 12. Sewage or other waste, from a plumbing system, which may be deleterious to surface or subsurface waters shall not be discharged into the ground or into any waterway unless it has first been rendered innocuous through subjection to some acceptable form of treatment.

13. Principle Number 13. Plumbing fixtures, devices, appliances and appurtenances shall be adequately supplied with water in sufficient volume and pressure to enable them to function properly.

14. Principle Number 14. The pipes conveying water to plumbing fixtures, appliances, devices and appurtenances shall be of sufficient size as to supply water at rates that will prevent undue pressure drops at any one fixture, when any other fixture, appliance, device or appurtenance or group is being flushed, operated or used.

15. Principle Number 15. There shall be no direct or indirect cross connections, either existing or potential,

between a safe potable water supply and an unsafe, nonpotable supply.

16. Principle Number 16. Adequate protection shall be provided to prevent possible backflow or back-siphonage of an unsafe or potentially hazardous fluid or material into a safe water supply.

17. Principle Number 17. Piping and connections of the plumbing system shall be of durable materials, free from defects in workmanship and materials, and systems shall be designed and constructed to provide adequate service for a reasonable life under stresses imposed by structural loading, temperature variation, vibration and other conditions.

18. Principle Number 18. Devices for heating and storing water shall be designed and installed to prevent all danger from overheating and explosion and to prevent undue flow of hot water or steam into the cold water supply pipes.

19. Principle Number 19. Refrigerators, coolers, receptacles, sterilizers, vats and similar equipment used for storing or holding foods, beverages, sterile goods and water conditioning equipment, etc., shall discharge into the building drainage system through an indirect waste.

20. Principle Number 20. Water closets, bathtubs, showers, urinals and similar fixtures shall be suitably enclosed and screened for privacy.

21. Principle Number 21. Plumbing systems, including fixtures, shall be maintained in sanitary condition and proper working order.

22. Principle Number 22. Sewage and wastes from plumbing and drainage systems shall be adequately treated and disposed of in accordance with the requirements of the plumbing official.

23. Principle Number 23. No potable water, soil or waste pipe shall be installed or permitted outside of a building, or concealed in outside walls or in any place where they may be subjected to freezing temperatures, unless adequate provision is made to protect them from freezing.

C. Repairs and Alterations. In existing buildings or premises in which plumbing installations are to be altered, repaired, or renovated, necessary deviations from the provisions of this Part may be permitted, provided such deviations conform to the intent of this Part and are approved in writing by the plumbing official.

D. Health or Safety. Wherever compliance with all the provisions of this code fails to eliminate or alleviate a nuisance which may involve health or safety hazards, the owner or his agent shall install such additional plumbing or drainage equipment as may be necessary to abate such nuisance.

E. Workmanship. Workmanship shall conform to generally accepted good practice.

F. Rodent-Proofing. All exterior openings provided for the passage of piping shall be properly sealed with snugly fitting collars of metal or other approved rodent-proof material securely fastened into place. (Also, additional/more

specific requirements which may be applicable can be found at LAC 51:V.305.F, LAC 51:V.305.J, and LAC 51:V.307.C.)

1. Interior openings through walls, floors, and ceilings shall be rodent-proofed as found necessary by the plumbing official.

G. Used Equipment. It shall be unlawful to install used equipment or material for plumbing installations unless it complies with the minimum standards set forth in this code and is approved by the plumbing official.

H. Condemned Equipment. Any plumbing equipment condemned by the plumbing official because of wear, damage, defects, or sanitary hazards shall not be reused for plumbing purposes.

I. Drainage Below Sewer Level. Drainage piping located below the level of the sewer shall be installed in accordance with Chapter 7 of this code.

J. Connections to Drainage System. All plumbing fixtures, drains, appurtenances and appliances used to receive or discharge liquid wastes or sewage shall be directly connected properly to the drainage system of the building or premises, in accordance with the requirements of this code. This Subsection shall not be construed to prevent indirect waste systems provided for in Chapter 8 of this code.

K. Connections to Water Supply. Every plumbing fixture or device or appliance requiring or using water for its proper operation shall be directly or indirectly connected to the water supply system in accordance with the provisions of this code.

AUTHORITY NOTE: Promulgated in accordance with R.S. 40:4(A)(7) and R.S.40:5(2)(3)(7)(9)(16)(17)(20).

HISTORICAL NOTE: Promulgated by the Department of Health and Hospitals, Office of Public Health, LR 38:2806 (November 2012).

§303. Materials

Editor's Note: The text in this Section will be effective on January 1, 2013.

A. Minimum Standards. Materials listed in this Section are applicable to more than one Chapter. Material requirements for specific systems and fixtures are noted in the specific Chapters. Materials listed in this code shall conform at least to the standards cited when used in the construction, installation, alteration, or repair of any part of a plumbing and drainage system, except that the plumbing official shall allow the extension, addition, or relocation of existing soil, waste or vent pipes with materials of like grade^(Q), as permitted by this code.

B. Use of Materials. Where more than one standard is listed, the material shall conform to at least one of the standards cited opposite it. Its use shall be further governed by the requirements imposed in other chapters of the code. Materials not included in the table shall be used only as provided for in §303.A of this code. Materials shall be free of manufacturing defects or damage, however occasioned, which would, or would tend to, render such materials

defective, unsanitary, or otherwise improper to accomplish the purpose of this code.

C. Specifications for Materials. Standard specifications for general materials for plumbing installations are listed in Table 303 of this code, with specific material specifications listed elsewhere in this Part. Products conforming at least to any one of the specifications listed for a given material shall be considered acceptable.

1. Abbreviations used in Table 303 of this code, and with the specific materials as listed elsewhere in this Part refer to standards or specifications as identified below. Addresses and more information for these organizations are listed in Section 1405 of this code.

AGA—American Gas Association.

AHRI—Air-Conditioning, Heating, and Refrigeration Institute.

ANSI—American National Standards Institute, Inc.

ARI—Air Conditioning and Refrigeration Institute (effective January 1, 2008, now AHRI)

APSP—Association of Pool and Spa Professionals [formerly, National Pool and Spa Institute (*NSPI*)]

ASME—American Society of Mechanical Engineers.

ASSE—American Society of Sanitary Engineering.

ASTM—American Society for Testing Materials International.

AWS—American Welding Society.

AWWA—American Water Works Association.

CDA—Copper Development Association, Inc.

CISPI—Cast Iron Soil Pipe Institute.

CAN/CSA—Canadian Standards Association.

FHA-MPS—Federal Housing Administration - Minimum Property Standards.

FMRC—Factory Mutual Research Corporation (approval standards obtained from FM Approvals, LLC)

FS—Federal Specifications

(obtained from the General Services Administration, Federal Supply Service, Specification Section)

MSS—Manufacturers Standardization Society of the Valve and Fittings Industry, Inc.

NFiPA—National Fire Prevention Association.

NSF—NSF International.

PDI—Plumbing and Drainage Institute.

PPFA—Plastic Pipe & Fittings Association.

PPI—Plastics Pipe Institute.

PS—Product Standard

(by the United States Department of Commerce and obtained from the Superintendent of Documents, Government Printing Office)

UL—Underwriters Laboratories, Inc.

2. ASTM standards are issued under fixed designations; the final number shown in Chapter 14 of this code indicates the year of original adoption, or in the case of revision, the year of last revision. "T" indicates Tentative. In the "CS" series of standards, also, the final number indicates the year of issue.

Table 303 General Materials	
Materials	Standards
Cement Lining	AWWA C 104, ANSI A 21.4
Cleanouts	ASME A 112.36.2M
Coal-Tar Enamel and Tape (Protective Coating)	AWWA C 203
Compression Gaskets for Cast Iron Soil Pipe and Fittings	ASTM C 564, CISPI HSN
Couplings used in Cast Iron Systems	ASTM C 564 (Gasket Material Only), CISPI 310, FMRC 1680, ASTM C 1277
Drinking Water Treatment Units Health Effects Aesthetic Effects	NSF 53, NSF 42
Fixed Flow Restrictors	ASSE 1034
Flexible Transition Couplings for Underground Piping Systems	ASTM C 1173
Floor and Trench Drains	ASME A 112.6.3
Grooved and Shouldered Type Joints	AWWA C 606
Handheld Showers (Backflow Prevention Devices)	ASSE 1014
Laboratory Faucet Backflow Preventers	ASSE 1035
Liquid and Paste Fluxes for Soldering of Copper and Copper Alloy Tube	ASTM B 813
Load Bearing, Bonded, Waterproof Membranes for Thin-Set Ceramic Tile and Dimension Stone Installation	ANSI A 118.10
Making Copper Soldered Joints	ASTM B 828
Plastic Toilet (Water Closet) Seats	IAPMO Z 124.5
Reverse Osmosis Drinking Water Treatment Systems	NSF 58
Roof, Deck and Balcony Drains	ASME A 112.6.4
Rubber Gaskets for Concrete Pipe and Manholes	ASTM C 443/C 443M
Rubber Rings for Asbestos Cement Pipe	ASTM D 1869, see §313.E of this code
Rubber and Thermoplastic Elastomers, Test Methods	ASTM D 395, ASTM D 412, 711.D
Solder Metal	ASTM B 32
Supports (Floor-Affixed) for Off-the-Floor Plumbing Fixtures for Public Use	ASME A112.6.1M
Supports(Framing-Affixed) for Off-the-Floor Water Closets with Concealed Tanks	ASME A112.6.2
Wall Hydrants, Frost Resistant, Automatic Draining, Anti-Backflow Type	ASSE 1019

Table 303 General Materials	
Materials	Standards
Plastic Materials	
Acrylics	ASTM D 788
Nylon	ASTM D 789
Polytetrafluoroethylene (PTFE)	ASTM D 4894, ASTM D4895
Plastic Cement And Solvents	
ABS-Solvent Cement	ASTM D 2235, Listed
Joints for IPS PVC Pipe Using Solvent Cement	ASTM D 2672
Making Solvent-Cement Joints with Polyvinyl Chloride (PVC) Pipe and Fittings	ASTM D 2855
Primers for use in Solvent Cemented Joints of Polyvinyl Chloride (PVC) Plastic Pipe and Fittings	ASTM F 656
PVC Solvent Cement	ASTM D 2564, Listed
Solvent Cements for Transition Joints Between Acrylonitrile-Butadiene-Styrene (ABS) and Polyvinyl Chloride (PVC) Non-Pressure Piping Components	ASTM D 3138, see §711.D.4 of this code (Note: This is not an all-purpose solvent cement. Only to be utilized for joining a building drain to a building sewer)
Safe Handling of Solvent Cements used for Joining Thermoplastic Pipe and Fittings	ASTM F 402
Solvent Cements for Chlorinated Polyvinyl Chloride (CPVC) Plastic Pipe and Fittings	ASTM F 493
Plastic Pipe Installation	
Electrofusion Joining Polyolefin Pipe and Fittings	ASTM F 1290, see §621.E of this code
Heat Fusion Joining of Polyethylene Pipe and Fittings	ASTM F 2620, see §621.E of this code
Heat Joining Polyolefin Pipe and Fittings	ASTM D 2657
Underground Installation of Flexible Thermoplastic Sewer pipe	ASTM D 2321
Underground Installation of Thermo-Plastic Pressure Piping	ASTM D 2774
Valves	
Pressurized Fixture Flushing Devices (Flushometers)	ASSE 1037
Metal Sheet	
Brass, sheet	ASTM B 248/B 248M
Copper, sheet	ASTM B 152/B 152M
Lead, sheet	FS QQ-L-201F(2)
Steel Sheet, Zinc-Coated Galvanized by the Hot-Dip Process	ASTM A 653/A 653M
Miscellaneous	
Bare Stainless Steel Welding Electrodes and Rods	AWS A 5.9/A 5.9M
Brazing Filler Metal	AWS A 5.8/A 5.8M

D. Identification of Materials. Each length of pipe and each pipe fitting, trap, fixture and device used in a plumbing system shall be marked in accordance with the approved applicable standard to which it is manufactured.

E. Installation of Materials. All materials used shall be installed in strict accordance with the standards under which the materials are accepted and approved, including the appendices which are related to installation. In the absence of such installation procedures, the manufacturer's published procedures or recommendations shall be followed.

F. Water Piping Quality. All potable water pipes, pipe related products and materials that join or seal pipes and pipe related products shall be evaluated and listed as

conforming with a national consensus product (or material) standard, ANSI/NSF Standard 61, and NSF/ANSI 372. Any solder or flux used in the installation or repair of any plumbing in a residential or nonresidential facility providing water for human consumption shall be lead free.

1. Exception. The lead free requirement of §303.F of this code above shall not apply to:

a. leaded joints necessary for the repair of existing cast iron pipes;

b. pipes, pipe fittings, plumbing fittings, or fixtures, including backflow preventers, that are used exclusively for nonpotable services such as manufacturing, industrial processing, irrigation, outdoor watering, or any other uses where the water is not anticipated to be used for human consumption; or,

c. toilets, bidets, urinals, fill valves, flushometer valves, tub fillers, shower valves, service saddles, or water distribution main gate valves that are 2 inches in diameter or larger.

G. Special Materials. The following apply to several special materials.

1. Lead. See Table 303 of this code. Sheet lead shall be not less than the following:

a. For safe pans - not less than 4 pounds per square foot (psf) [19.5 kilograms/meter² (kg/m²)] coated with an asphalt paint or equivalent.

b. For flashings of vent terminals - not less than 3 psf (14.6 kg/m²).

c. Lead bends and lead traps shall be not less than 1/8-inch (3.18 mm) wall thickness.

d. Any solder or flux which is used in the installation or repair of any plumbing in a residential or nonresidential facility providing water for human consumption shall be lead free (i.e., shall not contain more than 0.2 percent lead). Any pipe, pipe fitting, plumbing fitting, and fixture which is used in the installation or repair of any plumbing in a residential or nonresidential facility providing water for human consumption shall be lead free (i.e., shall not contain more than a weighted average of 0.25 percent lead when used with respect to the wetted surfaces of pipes, pipe fittings, plumbing fittings, and fixtures.).

i. Exception. The lead free requirement of Subparagraph d of this Paragraph shall not apply to:

(a). leaded joints necessary for the repair of existing cast iron pipes;

(b). pipes, pipe fittings, plumbing fittings, or fixtures, including backflow preventers, that are used exclusively for nonpotable services such as manufacturing, industrial processing, irrigation, outdoor watering, or any other uses where the water is not anticipated to be used for human consumption; or,

(c). toilets, bidets, urinals, fill valves, flushometer valves, tub fillers, shower valves, service

saddles, or water distribution main gate valves that are 2 inches in diameter or larger.

2. Copper. See Table 303 of this code. Sheet copper shall be not less than the following:

a. Safe pans - 12 ounces (oz) per square foot (sq ft) (3.7 kg/m²).

b. Vent terminal flashings - 8 oz per sq ft (2.4 kg/m²).

3. Caulking Ferrules. Caulking ferrules shall be manufactured from bronze, wrought copper, or brass and shall be in accordance with Table 303.G.3 of this code below.

Pipe Size (in)	Inside Diameter (in)	Length (in)	Minimum Weight Each
2	2 ¼	4 ½	1 lb 0 oz
3	3 ¼	4 ½	1 lb 12 oz
4	4 ¼	4 ½	2 lb 8 oz

4. Soldering Bushings. Soldering bushings where permitted shall be of red brass in accordance with Table 303.G.4 of this code below.

Pipe Size (In)	Minimum Weight Each
1 1/4	6 oz
1 1/2	8 oz
2	14 oz
2 1/2	1 lb 6 oz
3	2 lb 0 oz
4	3 lb 8 oz

5. Floor Flanges. The following applies to floor flanges.

a. Floor flanges for water closets or similar fixtures shall be not less than 1/8-inch (3.18 mm) thick for brass, 1/4-inch (6.35 mm) thick and not less than 2-inch (51 mm) caulking depth for cast iron or galvanized malleable iron. Flanges shall be of the approved type. Offset closet flanges shall be prohibited, except by approval of the plumbing official. Closet screws and bolts shall be of brass.

b. Flanges shall be soldered to lead bends, or shall be caulked, soldered or threaded to other metal. Plastic flanges shall be joined to plastic closet bends with the approved solvent cement.

6. Cleanouts. The following applies to cleanouts.

a. Cleanouts shall have plugs of brass and shall conform to ASTM A 74. Cleanouts may also have plugs of approved nylon plastic. Plugs may have raised square or countersunk heads except countersunk head shall be used where raised heads may cause a hazard.

b. Cleanout plugs with borosilicate glass systems shall be of borosilicate glass.

7. Nonmetallic Shower Pans. The following applies to non-metallic shower pans.

a. Plasticized polyvinyl chloride (PVC) sheet shall be a minimum of 0.040 inch (1.02 mm) thick, and shall meet the requirements of ASTM D 4551. Sheets shall be joined by solvent welding in accordance with the manufacturer's published recommendations.

b. Non-plasticized chlorinated polyethylene (CPE) sheet shall be a minimum 0.040 inch (1.02 mm) thick and shall meet the requirements of ASTM D 4068. Sheets shall be joined by solvent welding in accordance with the manufacturer's published recommendations.

c. Load bearing, bonded, waterproof membranes for thin-set ceramic tile and dimension stone installation shall meet the requirements of ANSI A 118.10 and shall be installed in accordance with the manufacturer's published recommendations.

d. All shower pan material shall be permanently marked by the manufacturer so as to enable the inspecting authority to determine the acceptability of the material and its identification according to the code. This marking is to be conveniently readable to the inspector when the material is in its installed position.

H. Limitations of Use of Materials. The following applies to limitations on the use of certain materials.

1. Pressure-rated Plastic Pipe and Fittings for Water Service Pipe. The following applies to pressure-rated plastic pipe and fittings for water service pipe.

a. In Tables 303 and 603 of this code, the 4-digit numbers listed under "Materials" column represent the ASTM identification numbers assigned to these materials by the joint ASTM-NSF-PPI committee to assist in quick, easy identification of the materials. The numbers appear as a part of the marking on the pipe and tubing. These and no others are approved.

b. All plastic pipe and fittings approved in this code shall be properly marked as specified by their respective standards. All material shall be installed in accordance with the applicable ASTM standards. No materials shall be commingled within the same system except those which are specifically approved in writing in the respective standards.

c. Existing metallic water service piping used for electrical grounding shall not be replaced with nonmetallic pipe or tubing until other grounding means are provided which are satisfactory to the proper administrative authority having jurisdiction.

2. Plastic Pipe and Fittings for Drain, Wastes and Vents. The following applies to plastic pipe and fittings for drain, wastes and vents.

a. Installations for plumbing drainage, waste and vents both above and below ground, indirect waste and storm drains shall conform to applicable standards listed in Tables 303 and 703 of this code and in conformity with the combustible materials regulations of plumbing in fire rated

assemblies, in concealed spaces, and in plenums as required by the applicable codes adopted under the authority of Act 12 of the 2005 First Extraordinary Session.

b. There shall be no commingling of different materials except through proper adapters. In all cases, approved solvent cement designated for the particular material shall be used.

c. Coextruded pipe with a cellular core and solid wall ABS DWV and PVC DWV plastic pipe shall be IPS Schedule 40 when used for drain, wastes and vents.

3. Stainless Steel Water Tube. Stainless steel water tube and piping shall conform to the standards listed in Table 603 of this code.

4. Plastic Pipe for Drains and Sewers. The following applies to plastic pipe for drains and sewers.

a. Coextruded PVC plastic pipe shall have a pipe stiffness of 25 (PS 25) when used for storm sewers, storm drains, foundation drains, and subsoil drains.

b. Coextruded PVC plastic pipe shall have a pipe stiffness of 50 (PS 50) when used for outside building sewers, storm drains, and storm sewers in accordance with §§705.A, 1101.E, 1103.C and 1103.D of this code.

5. Plastic Piping Components and Related Materials. All plastic plumbing pipes, plastic plumbing piping components and related materials shall be listed as conforming with NSF Standard 14.

AUTHORITY NOTE: Promulgated in accordance with R.S. 40:4(A)(7), R.S. 40:5(2)(3)(7)(9)(16)(17)(20), and R.S. 40:1299.27.1.

HISTORICAL NOTE: Promulgated by the Department of Health and Hospitals, Office of Public Health, LR 38:2807 (November 2012).

§305. Protection of Pipes

A. Breakage and Corrosion. Pipes passing under or through walls shall be protected from breakage. Pipes passing through concrete or cinder walls and floors or other corrosive material shall be protected against external corrosion by a protective sheathing or wrapping or other means that will withstand any reaction from lime and acid of concrete, cinder or other corrosive material. Sheathing or wrapping shall allow for expansion and contraction of piping to prevent any rubbing action. Minimum wall thickness of material is to be 0.025 inch (0.635 mm).

B. Sleeves. The following applies to sleeves.

1. Annular spaces between sleeves and pipes shall be filled or tightly caulked as approved by the plumbing official.

2. Annular spaces between sleeves and pipes in fire rated assemblies shall be filled or tightly caulked in accordance with the applicable codes adopted under the authority of Act 12 of the 2005 First Extraordinary Session.

C. Pipes through Footings or Foundation Walls. A soil pipe, waste pipe, or building drain that passes under a

footing or through a foundation wall shall be provided with a relieving arch, or a pipe sleeve of Schedule 40 pipe shall be built into the masonry wall. Such sleeve shall be two pipe sizes greater than the pipe passing through or as may be approved in writing by the plumbing official.

D. **Minimum Depth of Water Piping Outside of Building.** Water piping outside the building line shall be installed not less than 12 inches (305 mm) deep.

E. **Trench Location.** Trenching installed parallel to footings shall not extend below the 45° (0.785 rad) bearing plane of the footing or wall unless approved by the plumbing official.

F. **Waterproofing of Openings.** Joints at the roof, around vent pipes, shall be made watertight by the use of lead, copper, galvanized steel, aluminum, plastic or other approved flashings or flashing material. Exterior wall openings shall be made watertight.

G. **Pipes in Wood Construction.** Where cutting, notching, or boring occurs within 1 1/2 inches (38 mm) of the face of wooden joists, rafters, or studs, a protective steel plate 1/16-inch (1.59 mm) thick shall be used to protect the piping. The steel plate shall be the full width of the member and shall extend at least 2 inches (51 mm) on each side of the cut, bore, or notch.

1. **Exception.** A protective plate is not required for cast iron, galvanized or black steel, and Grade_(Q) H stainless steel pipe.

AUTHORITY NOTE: Promulgated in accordance with R.S. 40:4(A)(7) and R.S. 40:5(2)(3)(7)(9)(16)(17)(20).

HISTORICAL NOTE: Promulgated by the Department of Health and Hospitals, Office of Public Health, LR 38:2810 (November 2012).

§307. Trenching, Excavation, and Backfill

A. **Support of Piping.** Buried piping shall be supported throughout its entire length.

B. **Open Trenches.** All excavations required to be made for the installation of a building drainage system, or any part thereof within the walls of a building, shall be open trench work and shall be kept open until the piping has been inspected, tested and accepted.

C. **Mechanical Excavation.** Trenches shall be properly graded and tamped to support the load of the pipe installation.

D. **Backfilling.** Adequate precaution shall be taken to insure proper compactness of backfill around piping without damage to such piping. See §705.H of this code.

E. **Tunneling.** Where necessary, pipe may be installed by tunneling, jacking or a combination of both. In such cases, special care shall be exercised to protect the pipe from damage either during installation or from subsequent uneven loading. Where earth tunnels are used, adequate supporting structures shall be provided to prevent future settling or caving. Pipe may be installed in larger conduit which has been jacked through unexcavated portions of the trench.

F. **Single Trench Prohibited.** Water service pipes or any underground water pipes shall not be run or laid in the same trench as the building sewer or drainage piping, except as provided for in Chapters 6 and 7 of this code.

AUTHORITY NOTE: Promulgated in accordance with R.S. 40:4(A)(7) and R.S. 40:5(2)(3)(7)(9)(16)(17)(20).

HISTORICAL NOTE: Promulgated by the Department of Health and Hospitals, Office of Public Health, LR 38:2811 (November 2012).

§309. Structural Safety

A. **General.** In the process of installing or repairing any part of a plumbing and drainage installation, the finished floors, walls, ceilings, tile work or any other part of the building or premises which must be changed or replaced shall be left in a safe structural condition in accordance with the requirements of the applicable codes adopted under the authority of Act 12 of the 2005 First Extraordinary Session.

B. **Cutting, Notching and Boring.** The following applies to cutting, notching and boring.

1. Notches on the ends of joists shall not exceed one-fourth the depth. Holes bored for pipes or cable shall not be within 2 inches (51 mm) of the top or bottom of the joist, and the diameter of any such hole shall not exceed one-third of the depth of the joist. Notches for pipes in the top or bottom of joists shall not exceed one-sixth of the depth and shall not be located in the middle one-third of the span.

2. In exterior walls and bearing partitions, any wood stud may be cut or notched to a depth not exceeding 25 percent of its width. Cutting or notching of studs to a depth not greater than 40 percent of the width of the stud is permitted in nonbearing partitions supporting no loads other than the weight of the partition.

3. A hole not greater in diameter than 40 percent of the stud width may be bored in any wood stud. Bored holes not greater than 60 percent of the width of the stud are permitted in nonbearing partitions or in any wall where each bored stud is doubled provided not more than two such successive double studs are so bored.

4. In no case shall the edge of the bored hole be nearer than 5/8-inch (15.9 mm) to the edge of the stud. Bored holes shall not be located at the same section of stud as a cut or notch.

AUTHORITY NOTE: Promulgated in accordance with R.S. 40:4(A)(7) and R.S. 40:5(2)(3)(7)(9)(16)(17)(20).

HISTORICAL NOTE: Promulgated by the Department of Health and Hospitals, Office of Public Health, LR 38:2811 (November 2012).

§311. Fittings

A. **Change in Direction.** The following applies to the use of fittings in changes of direction of drainage piping.

1. Changes in direction in drainage piping shall be made by the appropriate use of 45° (0.785 rad) wyes, long-or-short-sweep quarter bends, one-sixth, one-eighth, or one-sixteenth bends, or by a combination of these or equivalent fittings. Single and double sanitary tees and quarter bends

may be used in drainage lines only where the direction of flow is from the horizontal to the vertical. A sanitary tee shall not be used on a horizontal drainage line as a takeoff fitting for a vent.

2. Changes in direction in Schedule 40 DWV-PVC and ABS drainage piping shall be made by the appropriate use of 45° (0.785 rad) wyes, quarter bends or long sweep quarter bends, one-sixth, one-eighth, or one-sixteenth bends, or by a combination of these or equivalent fittings. Single and double sanitary tees and quarter bends may be used in drainage lines only where the direction of flow is from the horizontal to the vertical. A sanitary tee shall not be used on a horizontal drainage line as a takeoff fitting for a vent.

B. Short Sweeps. Short sweeps not less than 3-inch diameter may be used in soil and waste lines where the change in direction of flow is from the horizontal to the vertical and may be used for making necessary offsets between the ceiling and the next floor above.

C. Prohibited Fittings. A straight tee branch shall not be used as a drainage fitting. A saddle type fitting or running threads shall not be used in the drainage or vent system. Drainage or vent piping shall not be drilled or tapped unless approved by the plumbing official. A fitting having a hub in the direction opposite to flow shall not be used in the drainage system, unless the pipe is cut by either a saw or snap cutter, which will assure clean, smooth cuts of the pipe. Double sanitary tee pattern fittings shall not receive the discharge of fixtures or appliances with pumping action discharge.

D. Heel or Side Inlet Bend Prohibited. Heel or side inlet quarter bend fittings shall not be used in the drainage or vent system.

F. Obstruction to Flow. A fitting or connection which offers abnormal obstruction to flow shall not be permitted. See §715 of this code.

G. Increases and Reducers. Where different sizes of pipes or pipes and fittings are to be connected, the proper size increasers or reducers or reducing fittings shall be used between the two sizes.

AUTHORITY NOTE: Promulgated in accordance with R.S. 40:4(A)(7) and R.S. 40:5(2)(3)(7)(9)(16)(17)(20).

HISTORICAL NOTE: Promulgated by the Department of Health and Hospitals, Office of Public Health, LR 38:2811 (November 2012).

§313. Types of Joints

A. Tightness. Joints and connections in the plumbing system shall be gastight and watertight for the pressure required by test, with the exceptions of those portions of perforated or open-joint piping which are installed for the purpose of collecting and conveying ground or seepage water to the underground storm drains.

B. Threaded Joints. Threaded joints shall conform to ASME B 1.20.1. All burrs shall be removed, pipe ends shall be reamed or filed out to size of bore, and all chips shall be removed. Pipe-joint cement and sealing compound shall be

used only on male threads and be insoluble and nontoxic. All pipe-joint sealants for use on potable water piping shall be listed and labeled by an approved testing laboratory.

C. Wiped Joints. Joints in lead pipe or fittings, or between lead pipe or fittings and brass or copper pipe, ferrules, solder nipples, or traps, shall be full-wiped joints. Wiped joints shall have an exposed surface on each side of a joint not less than 3/4-inch (19.1 mm) and at least as thick as the material being jointed. Wall or floor flange lead-wiped joints shall be made by using a lead ring or flange placed behind the joints at wall or floor. Joints between lead pipe and cast iron or steel shall be formed by means of a caulking ferrule, soldering nipple, or bushing.

D. Flexible Couplings. Flexible couplings may be used to join plain ends of similar or dissimilar pipes and the flexible coupling shall consist of an approved gasket that is attached to the pipe with special adjustable stainless steel clamps and bolts (see §711.D of this code). The flexible couplings and the approved gasket shall be oil resistant.

E. Precast Joints. Precast collars shall be formed on the spigot and in the bell of the pipe in advance of use. Materials shall be resistant to acids, alkalies and oils, and precast joints shall conform to the requirements of ASTM C 425, and upon installation shall be tested as provided in this code.

F. Cement Mortar Joints and Connections. The following applies to cement mortar joints and connections.

1. Except for repairs and connections to existing lines constructed with such joints, cement mortar joints are prohibited.

2. Where permitted, cement mortar joints shall be made in the following manner: A layer of jute or hemp shall be inserted into the base of the annular joint space and packed tightly to prevent mortar from entering the interior of the pipe or fitting. Not more than 25 percent of the annular space shall be used for jute or hemp. The remaining space shall be filled in one continuous operation with a thoroughly mixed mortar composed of one part cement and two parts sand, with only sufficient water to make the mixture workable by hand. Additional mortar of the same composition shall then be applied to form a one to one slope with the barrel of the pipe. The bell or hub of the pipe shall be swabbed to remove any mortar or other material which may have found its way into such pipe.

G. Burned Lead Joints. Burned (welded) lead joints shall be lapped and the lead shall be fused together to form a uniform weld at least as thick as the lead being jointed.

H. Joints for Plastic Pipe and Fittings. The following applies to joints for plastic pipe and fittings.

1. ABS and PVC pipe and fittings shall be solvent cemented using the proper cement recommended for the particular materials. All pipe cuts shall be square and both pipe and fittings shall be cleaned of all soil, dirt, oil and grease before applying primer or cement. Solvent joints made for pressure applications shall use primers and cements that are in compliance with the applicable ASTM

standards. All solvent joints shall be made in accordance with the applicable ASTM standards and shall be allowed to dry before testing. Should any leak occur on water test, the defective joint shall be replaced. All solvent cements and primers shall comply with requirements of the NSF 14 and shall be labeled to identify the laboratory certifying compliance for the particular cement and primer being used.

2. Plastic pipe and fittings for sewer and water pressure lines may also be joined by use of elastomeric joints when the respective standards for the materials so specify. Joints shall conform to the standards listed in either Table 603 or Table 703 of this code, as applicable, for elastomeric joints.

I. Grooved or Plain End Mechanical Couplings and Fittings. Grooved or plain end mechanical couplings and fittings may be used. Pipe is to be prepared in accordance with manufacturer's specifications.

J. Water Supply and Distribution Systems. Additional provisions for water supply and distribution systems are located in §§619 and 621 of this code.

K. Sanitary Drainage Systems. Additional provisions for sanitary drainage systems are located in 709.

AUTHORITY NOTE: Promulgated in accordance with R.S. 40:4(A)(7) and R.S. 40:5(2)(3)(7)(9)(16)(17)(20).

HISTORICAL NOTE: Promulgated by the Department of Health and Hospitals, Office of Public Health, LR 38:2812 (November 2012).

§315. Use of Joints

A. Threaded Pipe to Cast Iron. Joints between steel, brass, or copper pipe, and cast iron pipe shall be either caulked or threaded, formed as provided in §§313.B and 709.B of this code, or shall be formed with approved adapter fittings.

B. Lead to Cast Iron or Steel. Joints between lead and cast iron or steel pipe shall be formed by means of wiped joints and a caulking ferrule, soldering nipple, or bushing as provided in §313.C of this code.

C. Connection of Dissimilar Metals. There shall be no commingling of materials except through the use of proper dielectric fittings that make different kinds of metal pipe compatible.

D. Welding or Brazing. Brazing or welding shall be performed in accordance with requirements of recognized published standards of practice and by licensed or otherwise qualified mechanics. All brazing on medical gas systems shall be performed by certified installers meeting the requirements of ASME Boiler and Pressure Vessel Code, Section IX, Welding and Brazing Qualifications, or AWS B 2.2/B 2.2M, Brazing Procedure and Performance Qualification, as referenced in Chapter 14 of this code.

E. Slip Joints. In drainage piping, slip joints may be used on both sides of the trap and in the trap seal. Slip joints in water piping may be used on the exposed fixture supply only.

F. Expansion Joints. Expansion joints must be accessible and may be used where necessary to provide for expansion and contraction of the pipes.

G. Mechanically Formed Tee Connections. The following applies to mechanically formed tee connections.

1. Mechanically extracted collars shall be formed in a continuous operation consisting of drilling a pilot hole and drawing out the tube surface to form a collar having a height not less than three times the thickness of the tube wall.

2. The branch shall be notched to conform to the inner curve of the run tube and dimpled to insure that penetration of the branch tube into the collar is of sufficient depth for brazing and that the branch tube does not obstruct the flow in the main line tube.

3. All joints shall be brazed in accordance with 621.D. Soft soldered joints shall not be permitted.

AUTHORITY NOTE: Promulgated in accordance with R.S. 40:4(A)(7) and R.S. 40:5(2)(3)(7)(9)(16)(17)(20).

HISTORICAL NOTE: Promulgated by the Department of Health and Hospitals, Office of Public Health, LR 38:2813 (November 2012).

§317. Anchors, Hangers and Supports

A. General. The following apply to anchors, hangers and supports.

1. Strains and Stresses. Piping in a plumbing system shall be installed without undue strains or stresses and provision shall be made for expansion, contraction, and structural settlement.

2. Material. Anchors, hangers, and supports for pipe shall be of sufficient strength to maintain their proportionate share of the pipe alignment and to prevent sagging. Anchors, hangers or supports shall be of a material which is compatible with the pipe and will not promote galvanic action. Anchors, hangers or supports installed below grade^(g) which may come into contact with the soil shall be of a material which is compatible with the type of soil to which it is exposed to prevent the weakening of the device over time due to corrosion, etc.

3. Attachment. Anchors, hangers and supports shall be securely attached to the building construction.

B. Vertical Piping. The following applies to the support of pipes installed vertically.

1. Attachment. Vertical piping shall be secured at sufficiently close intervals to keep the pipe in alignment and carry the weight of the pipe and contents.

2. Cast Iron Soil Pipe. Cast iron soil pipe shall be supported at the base and at each story level at intervals not exceeding 15 ft (4572 mm).

3. Threaded Pipe. Threaded pipe shall be supported at the base and at not less than every other story at intervals not exceeding 30 ft (9144 mm).

4. Copper Tube. Copper tube shall be supported at each story for piping 1 1/2 inches and over and at not more

than 4 ft (1219 mm) intervals for piping 1 1/4 inches and smaller.

5. **Lead Pipe.** Lead pipe shall be supported at intervals not exceeding 4 ft (1219 mm).

6. **Plastic Pipe.** Plastic piping shall be supported at each story for piping 2 inches or over and not more than 4 foot (1219 mm) intervals for piping 1 1/2 inches or under.

7. **Borosilicate Glass Pipe.** Borosilicate glass pipe shall be supported at every floor for 3-inch, 4-inch and 6-inch diameter vertical runs and at every other floor for sizes 2 inches and smaller. Padded riser clamps with 1/4-inch (6.35 mm) thick elastomeric padding shall be used, restricting sideward as well as downward movement.

C. **Horizontal Piping.** The following applies to the support of pipes installed horizontally.

1. **Supports.** Horizontal piping shall be supported at sufficiently close intervals to keep it in alignment and prevent sagging.

2. **Cast Iron Soil Pipe.** Cast iron soil pipe shall be supported at not more than 5 ft (1524 mm) intervals on 5 ft (1524 mm) lengths and 10 ft (3048 mm) intervals on 10 ft (3048 mm) lengths. Hangers shall be located as near hubs as possible.

3. **Threaded Pipe.** Threaded pipe shall be supported at approximate 12 ft (3658 mm) intervals.

4. **Copper Tubing.** Copper tube shall be supported at approximate 8 ft (2439 mm) intervals for tubing 1-inch and smaller and 10 ft (3048 mm) intervals for tubing 1 1/4 inches and larger.

5. **Lead Pipe.** Lead pipe shall be supported by strips or otherwise for its entire length.

6. **Plastic Pipe.** Plastic piping shall be supported at not more than 4 ft (1219 mm) intervals.

7. **Borosilicate Glass Pipe.** Borosilicate glass pipe shall be supported in horizontal runs every 8 to 10 ft (2438 to 3048 mm), never closer unless there are more than two joints in the 8 to 10 ft (2438 to 3048 mm) section. Padded hangers shall be used, of either the clevis or trapeze type.

D. **Repair or Replacement.** Piping in concrete or masonry walls or footings shall be placed or installed in chases or recesses which will permit access to the piping for repairs or replacement.

E. **Base of Stacks.** The following applies to the support and off-loading of the base of soil, waste and vent stacks.

1. **Supports.** The base of all soil, waste and vent stacks shall be supported to the satisfaction of the plumbing official.

2. **Piping Material.** Other piping material shall be so anchored as to take the load off the stack at the base.

AUTHORITY NOTE: Promulgated in accordance with R.S. 40:4(A)(7) and R.S. 40:5(2)(3)(7)(9)(16)(17)(20).

HISTORICAL NOTE: Promulgated by the Department of Health and Hospitals, Office of Public Health, LR 38:2813 (November 2012).

§319. Tests

A. **Required Tests.** The permit holder shall make the applicable tests prescribed in §§319.B thru 319.E of this Part to assure compliance with the provisions of this code. The permit holder shall give reasonable advance notice to the plumbing official when the plumbing work is ready for tests. The equipment, material, power, and labor necessary for the inspection and test shall be furnished by the permit holder and he is responsible for assuring that the work will withstand the test pressure prescribed in the following tests. All the piping of the plumbing system shall be tested with either water or air. After the plumbing fixtures have been set and their traps filled with water, the entire drainage system shall be submitted to final tests. The plumbing official may require the removal of any cleanouts to ascertain if the pressure has reached all parts of the system.

B. **Drainage and Vent Tests.** The following applies to the testing of drainage and vent systems.

1. A water test shall be applied to the drainage system and vent system either in its entirety or in sections. If applied to the entire system, all openings in the piping shall be tightly closed, except the highest opening, and the system shall be filled with water to point of overflow. If the system is tested in sections, each opening shall be tightly plugged except the highest openings of the section under test, and each section shall be filled with water, but no section shall be tested with less than 10 ft head of water [29.9 kilopascal (kPa)]. In testing successive sections at least the upper 10 ft (3048 mm) of the next preceding section shall be tested, so that no joint or pipe in the building (except the uppermost 10 ft (3048 mm) of the system) shall have been submitted to a test of less than a 10 ft head of water (29.9 kPa). The water shall be kept in the system, or in the portion under test, for at least 15 minutes before inspection starts; the system shall then be tight at all points.

2. An air test shall be made by attaching an air compressor or testing apparatus to any suitable opening and, after closing all other inlets and outlets to the system, forcing air into the system until there is a uniform gage pressure of 5 psi (34.5 kPa) or sufficient to balance a column of mercury 10 inches in height (33.8 kPa). This pressure shall be held without introduction of additional air for a period of at least 15 minutes.

a. **Exception.** Cast iron soil pipe joined with compression gaskets or mechanical couplings shall be tested with 6 psi (41.4 kPa) of air and allowed a 1 psi (6.9 kPa) reduction in pressure or a 2-inch (50.8 mm) drop in the column of mercury in a 15 minute period.

3. The final test of the completed drainage and vent system shall be visual and in sufficient detail to assure that the provisions of this code have been complied with, provided, however, that, for cause, it may be necessary to subject the plumbing to either a smoke or peppermint test. Where the smoke test is preferred, it shall be made by filling

all traps with water and then introducing into the entire system a pungent, thick smoke produced by one or more smoke machines. When the smoke appears at stack openings on the roof, they shall be closed and a pressure equivalent to a 1-inch water column [248.8 Pascal (Pa)] shall be maintained for 15 minutes before inspection starts. Where the peppermint test is preferred, 2 oz (59 mL) of oil of peppermint shall be introduced for each stack.

C. Test of Water Distribution System. Upon the rough-in completion of a section of or the entire water distribution system [e.g., before closing the wall in and, for example, after capping and crimping a copper piping system, after plugging and sealing approved plastic piping such as CPVC, PEX, etc.], it shall be tested and proved tight under a water pressure not less than 200 psi (1379 kPa) for at least 15 minutes. The water used for tests shall be obtained from a potable source of supply.

D. Test of Building Sewer. The following applies to the testing of the building sewer.

1. Gravity sewer tests shall consist of plugging the end of the building sewer at the point of connection with the sewerage system, filling the building sewer with water, testing with not less than a 10 ft (3048 mm) head of water and maintaining such pressure until backfill is completed.

2. Forced sewer tests shall consist of plugging the end of the building sewer at the point of connection with the sewerage system and applying a pressure of 5 psi (34.5 kPa) greater than the pump rating, and maintaining such pressure until backfill is completed.

E. Test of Interior Leaders or Downspouts. Leaders or downspouts and branches within a building shall be tested by water or air in accordance with §319.B.1 or §319.B.2 of this code.

F. Backflow Prevention Devices. Backflow prevention devices shall be tested in accordance with ASSE Series 5000, USC's FCCC & HR's "*Manual of Cross-Connection Control*", or UFL's TREEO's "*Backflow Prevention - Theory and Practice*".

1. The test gauge used in testing backflow prevention devices shall be calibrated at a frequency of at least every 12 months by a factory authorized laboratory to an accuracy of ± 0.2 pounds per square inch differential (psid) (1.378 kPa) for increasing and decreasing pressure differential pressure readings over the scale of 1.0 psid to 15 psid (6.9 kPa to 103.4 kPa). The gauge shall be tested for accuracy in the vertical position with water and at different inlet pressures.

a. The reference source(s) used to verify accuracy shall have a maximum permissible error of ± 0.05 psig (0.344 kPa). Such reference source(s) shall have their calibration traceable to the National Institute of Standards and Technology (NIST).

AUTHORITY NOTE: Promulgated in accordance with R.S. 40:4(A)(7) and R.S. 40:5(2)(3)(7)(9)(16)(17)(20).

HISTORICAL NOTE: Promulgated by the Department of Health and Hospitals, Office of Public Health, LR 38:2814 (November 2012).

§321. Additional General Provisions

A. Additional general provisions are contained in:

1. LAC 51:XIV.Chapter 13, Medical Facilities Plumbing Systems;

2. LAC 51:XIV.Chapter 15, Travel Trailers and Travel Trailer Parks; and,

3. LAC 51:XIV.Chapter 17, Mobile/Manufactured Homes and Mobile/Manufactured Home Parks.

AUTHORITY NOTE: Promulgated in accordance with R.S. 40:4(A)(7) and R.S. 40:5(2)(3)(7)(9)(16)(17)(20).

HISTORICAL NOTE: Promulgated by the Department of Health and Hospitals, Office of Public Health, LR 38:2815 (November 2012).

Chapter 4. Plumbing Fixtures

§401. General

A. Scope. The provisions of this Chapter shall govern the materials, design, installation, and quality of plumbing fixtures.

B. Prohibited Fixtures. Pan, valve, plunger, offset, washout, latrine, frostproof and other water closets having an invisible seal or an unventilated space or having walls which are not thoroughly washed at each discharge, and floor type trough urinals shall be prohibited. Any water closet which might permit siphonage of the contents of the bowl back into the tank shall be prohibited (for example, low down tank type water closets, etc.).

C. Concealed Slip-Joint Connections. Fixtures having concealed slip-joint connections shall be provided with an access panel or utility space so arranged as to make the slip connections accessible for inspection and repair.

D. Limited Access to Waste and Overflow Fittings. When access to waste and overflow fittings cannot be provided as required for slip-joints in §401.C of this code above or when bathtubs are set head-to-head, joints complying with §621.B of this code may be used. In such limited access cases, waste and overflow shall be of the straight-through type with overflow connecting to the tee branch which will allow the fixture, drain, and trap to be cleaned without disturbing concealed joints. Connections shall be inspected prior to concealment.

AUTHORITY NOTE: Promulgated in accordance with R.S. 40:4(A)(7) and R.S. 40:5(2)(3)(7)(9)(16)(17)(20).

HISTORICAL NOTE: Promulgated by the Department of Health and Hospitals, Office of Public Health, LR 38:2815 (November 2012).

§403. Installation

A. Cleaning. Plumbing fixtures shall be installed in a manner to afford easy access for cleaning. Where practical, all pipes from fixtures shall be run to the nearest wall.

B. Joints. Where a fixture comes in contact with a wall or floor, the joint shall be watertight.

C. Wall-Hung Bowls. Wall-hung water closet bowls shall be rigidly supported by a concealed metal supporting

member so that no strain is transmitted to the closet connection.

D. Setting. Fixtures shall be set level and in proper alignment with reference to adjacent walls. No water closet or bidet shall be set closer than 15 inches (381 mm) from its center to any side wall or partition nor closer than 30 inches (762 mm) center-to-center with adjacent fixtures. No urinal shall be set closer than 12 inches (305 mm) from its center to any side wall or partition nor closer than 24 inches (610 mm) center-to-center with adjacent urinal fixtures (see §713 of this code). There shall be a minimum of 21 inches (533mm) of clearance provided between the front of the water closet, lavatory or bidet to any wall, fixture or door.

E. Sanitation. All public toilet room floor surfaces shall be of non-absorbent, impervious material.

AUTHORITY NOTE: Promulgated in accordance with R.S. 40:4(A)(7) and R.S. 40:5(2)(3)(7)(9)(16)(17)(20).

HISTORICAL NOTE: Promulgated by the Department of Health and Hospitals, Office of Public Health, LR 38:2815 (November 2012).

§405. Location of Fixtures

A. Ventilation and Lighting. The following applies to the ventilation and lighting requirements where plumbing fixtures are installed.

1. Means of Ventilation. Every restroom, bathroom or water closet combination shall be provided with ventilation by one or more operable windows opening to the outside of the building, by mechanical exhaust or by other means approved by the administrative authority.

a. Window Opening. When an operable window opening to the outside of the building is used for ventilation, an insect mesh screen shall be installed on such opening.

b. Mechanical Exhaust. Public restrooms, bathrooms or water closet combinations shall be provided with ventilation by mechanical exhaust. When separate facilities for employees or staff of food service establishments, markets and retail food stores are provided, such facilities shall also be provided with ventilation by mechanical exhaust.

i. All restrooms, bathrooms and water closet combinations which are ventilated by mechanical exhaust shall have fixed openings from adjacent room or corridors or from other approved sources, large enough to provide a sufficient inflow of air to make exhaust ventilation effective.

ii. Ventilation ducts from restrooms, bathrooms and water closet combinations shall be exhausted to the outside air or be connected into an independent system that exhausts to the outside air.

2. Combustion Chambers. The combustion chambers of all heaters, heating systems and other fired equipment shall be vented to the atmosphere. Other parts of the heating, cooling and ventilating system shall be so designed, built and maintained as to ensure that the pressure in the space from which combustion air is drawn does not become negative with respect to the atmosphere.

3. Illumination Level. Artificial lighting shall be installed in every restroom, bathroom or water closet combination sufficient to provide an illumination level of at least 10 foot-candles, measured 3 feet off of the floor.

4. Enclosures. Where a water closet is completely enclosed in a room or by walls, such enclosure shall be separately ventilated and lighted.

B. Improper Location. Piping, fixtures or equipment shall not be located in such a manner as to interfere with the normal operation of windows, doors or other exit openings. Toilet rooms for public use shall not open directly into a room for the preparation of food for service to the public.

C. Toilet Facilities for Construction Workers. Toilet facilities, of the type and in the quantity approved by the administrative authority or, in lieu thereof, in accord with the Minimum Requirements for Sanitation in Places of Employment (ANSI Z 4.1), shall be provided and maintained in a sanitary condition for the use of workmen during construction.

AUTHORITY NOTE: Promulgated in accordance with R.S. 40:4(A)(7) and R.S. 40:5(2)(3)(7)(9)(16)(17)(20).

HISTORICAL NOTE: Promulgated by the Department of Health and Hospitals, Office of Public Health, LR 38:2815 (November 2012).

§407. Materials and Performance Standards

A. Plumbing fixtures shall be constructed from approved materials, have smooth impervious surfaces, be free from defects and concealed fouling surfaces. Except as permitted elsewhere in this code, plumbing fixtures and appurtenances shall conform to the standards listed in the following Table (LAC 51:XIV.Table 407).

Table 407 General Fixtures and Accessories	
Materials	Standards
Fixture Fittings	ASME A112.18.1, CSA B125.1
Fixture Fittings, Backflow Protection Devices and Systems	ASME A112.18.3
Fixture Waste Fittings	ASME A112.18.2, CSA B125.2
Flexible Water Connectors (prohibited for use in instances when the supply temperature will exceed 150°F)	ASME A112.18.6, CSA B125.6
Fixtures, Enameled Cast Iron and Steel Plumbing	ASME A112.19.1, CSA B45.2
Fixtures, Non-Vitreous Ceramic (Fireclay)	ASME A112.19.9M
Fixtures, Ceramic Plumbing	ASME A112.19.2, CSA B45.1
Fixtures, Hydraulic Performance for Water Closets and Urinals	ASME A112.19.6
Fixtures, Stainless Steel Plumbing	ASME A112.19.3, CSA B45.4
Fixtures, Porcelain Enameled Formed Steel Plumbing	ASME A112.19.4M
Fixtures, Plumbing (for) Land Use, including Fixtures for Medical and Dental Facilities	FS WW-P-541 E/GEN(1)
Lead, Caulking	FS QQ-L-156
Macerating Toilet Systems	ASME A 112.3.4
Plastic Bathtub and Shower Units	ANSI Z124.1.2
Plastic Lavatories	ANSI Z124.3
Plastic Sinks	IAPMO Z124.6

Table 407 General Fixtures and Accessories	
Materials	Standards
Plastic Water Closet Bowls and Tanks	ANSI Z124.4
Trim for Water Closet Bowls, Tanks and Urinals	ASME A112.19.5
Vitreous China Nonwater Urinals	ASME A112.19.19
Water Hammer Arresters	ASSE 1010

AUTHORITY NOTE: Promulgated in accordance with R.S. 40:4(A)(7) and R.S. 40:5(2)(3)(7)(9)(16)(17)(20).

HISTORICAL NOTE: Promulgated by the Department of Health and Hospitals, Office of Public Health, LR 38:2816 (November 2012).

§409. Water Conservation

A. Plumbing fixtures and plumbing fixture fittings shall conform to the following requirements.

1. New or replacement water closets, urinals, sink faucets, lavatories or shower heads shall not be installed with a flow rate or flush volume in excess of the maximum specified in Table 409 of this code below, when tested in accordance with the provisions of the applicable ASME Standard listed in Table 407 of this code.

Table 409 Maximum Allowable Water Usage For Plumbing Fixtures ¹	
Fixture	Max Usage
Lavatory, private	2.2 gpm at 60 psi
Lavatory, public (metering)	0.26 gallons per metering cycle
Lavatory, public (other than metering)	0.5 gpm at 60 psi
Shower Head/Handheld Shower	2.5 gpm at 60 psi
Sink Faucet	2.2 gpm at 60 psi
Urinals	1.0 gal/flushing cycle
Water Closet	1.6 gal/flushing cycle

NOTES:

1. Maximum allowable water usage for plumbing fixtures and fixture fittings not listed in this table should conform to the applicable ANSI or ASME standard listed in Table 407 of this code. Blowout fixtures, vegetable sprayers, clinical sinks, service sinks, hose bibbs and emergency showers sinks shall be exempted from these limitations.

2. Nonwater Urinals. Nonwater urinals shall be listed and comply with the applicable standard(s) referenced in Table 407. Nonwater urinals shall have a barrier liquid sealant to maintain a trap seal. Nonwater urinals shall permit the uninhibited flow of waste through the urinal to the sanitary drainage system. Nonwater urinals shall be cleaned and maintained in accordance with the manufacturer's instructions after installation. Where nonwater urinals are installed they shall have a water distribution line roughed-in above each urinal location to allow for the installation of approved water-use type urinals in the event of a retrofit.

3. Self-closing metering faucets shall be installed on lavatories intended to serve the transient public, such as those in, but not limited to, service stations, train stations, airports, restaurants, and convention halls. Self-closing metering faucets used on lavatories or other hand-washing fixtures shall provide a flow of water for at least 15 seconds

without the need to reactivate the faucet. Self-closing faucets which are designed to close immediately upon the release of the handle are prohibited for use on lavatories or other type of hand-washing fixtures.

AUTHORITY NOTE: Promulgated in accordance with R.S. 40:4(A)(7) and R.S. 40:5(2)(3)(7)(9)(16)(17)(20).

HISTORICAL NOTE: Promulgated by the Department of Health and Hospitals, Office of Public Health, LR 38:2816 (November 2012).

§411. Minimum Plumbing Fixtures

A. General. The following general requirements are to be used when applying Table 411 of this Part.

1. Restroom Plumbing Fixtures. Notwithstanding the provisions of LAC 51:I.123.A.2, in new construction, substantial renovation or building additions and in changes of occupancy classification or real property ownership, at least the minimum type(s) of rest room plumbing fixtures provided for in this Section shall be installed, and the minimum number of each type of restroom plumbing fixture shall be in accordance with Table 411 of this Part. The term "substantial renovation" as used in this Paragraph includes, but is not limited to, a renovation/operational change which would trigger the need, pursuant to the requirements of Table 411 of this Part, for additional restroom plumbing fixtures to be installed, even if the occupancy classification itself may not have changed.

a. Exception

i. When only a real property ownership change occurs, restroom plumbing fixture upgrades to meet the minimum plumbing fixture requirements contained in this Section and Table 411 of this Part are not to be blindly enforced if the state health officer/Office of Public Health has assurances that the prior or existing business held a food permit (e.g., grocery store, restaurant, etc.) under LAC 51:XXIII and the prospective new business owner agrees, in writing to the state health officer/Office of Public Health, to operate the business in exactly the same manner as the prior or existing business owner (e.g., parents sell a business to their children who will operate the business in exactly the same manner) and there have been no documented complaints, within the past five years, about:

- (a). a lack of toilet room fixtures;
- (b). urination in non-restroom fixtures or floor areas within the building; or
- (c). urination on the outside of the building or the premises or adjoining lots or areas, etc.

ii. This exception to the normal enforcement procedures (i.e., §411.A.1 of this Code) shall not be applicable when a serious health threat to the public exists.

2. Non-Restroom Plumbing Fixtures. Where the construction of buildings and facilities was approved by the state health officer pursuant to Sanitary Code (LAC 51) requirements then in effect, upgrading of such buildings and facilities to comply with the non-restroom plumbing fixture

requirements of Table 411 of this Part shall not be required except where:

a. substantial renovation or building additions are undertaken; or

b. where the occupant or real property ownership thereof or the occupancy classification located therein changes subsequent to the effective date hereof; or

c. where a serious health threat to the public health exists, unless otherwise specifically provided hereinafter.

3. The term "substantial renovation" as used in §411.A.2 of this code includes, but is not limited to, a renovation/operational change which would trigger the need, pursuant to the requirements of Table 411 of this Part, for additional non-restroom plumbing fixtures to be installed, even if the occupant or the occupancy classification itself may not have changed.

4. Except as may be otherwise specifically noted within Table 411 of this Part, the number of occupants of a building shall be determined by the square feet (sq ft) of usable floor space. In determining the usable floor space, the square foot area of permanent structural building components, food service establishment kitchens, toilet rooms, corridors, stairways, vertical shafts and equipment rooms, when necessary for the operation of building utilities only, may be deducted from the total aggregate floor area. The occupant content and the number of required facilities for occupancies other than listed in Table 411 of this Part shall be determined by the plumbing official. Plumbing facilities in the occupancies or tenancies of similar use may be determined by the plumbing official from Table 411 of this Part.

5. In commercial buildings of multiple tenants, common toilet facilities (separate for males and females) for each floor are acceptable in lieu of separate facilities required by this Section only when the applicable building occupant content has common access from within the building. Central facilities shall be installed such that the path of travel to such facilities shall not exceed a distance of 500 feet. The maximum travel distance to the central toilet facilities shall be measured from the main entrance of any store or tenant space. When tenancies, rental units, etc., are to be provided with separate facilities of a partial nature, such facilities are not deductible from the total common facilities required. Tenancies, rental units or other usable areas within a building when separated from the required

toilet facilities by walls or partitions without common access openings (i.e., openings through interior walls or partitions that allow access to the toilet facilities) shall be considered independently from the remainder of the building and shall be provided with separate facilities in accordance with this Chapter regardless of the type of occupancy.

6. In self-storage (mini-warehouse) complexes, facilities shall not be required in each building, but shall be located at the office or entrance and such that the plumbing official determines the intent of the code is satisfied (see Paragraphs 7 and 8 in §411.A of this Code below).

7. In applying the schedule of facilities recorded in Table 411 of this Part, consideration must be given to the accessibility of the fixtures. Conformity purely on a numerical basis may not result in an installation suitable to the need of the individual establishment. For example, multi-storied buildings shall be provided with toilet facilities on each floor based upon the population of the floor. If building is a multi-purpose facility (i.e., a retail fuel station and a retail store, or a retail fuel station and a retail store and a restaurant, or a retail store and retail fuel station, etc.), the occupancy which requires the largest number of fixtures shall apply.

8. Every building and each subdivision thereof intended for public use shall be provided with facilities in accordance with this Chapter. Required facilities shall be directly accessible to the public through direct openings or corridors from the area or areas they are intended to serve. Access to the required toilet facilities for customers shall not pass through areas designated as for employee use only such as kitchens, food preparation areas, storage rooms, closets or similar spaces. Toilet facilities accessible only to private offices shall not be counted to determine compliance with this Chapter. Required facilities shall be free and designated by legible signs for each sex. Pay facilities may be installed when in excess of the required minimum facilities.

9. The toilet room entry door shall not be lockable by a user of the facilities when such room contains multiple water closets (or water closet and urinal fixtures) and the fixtures provided therein are required to meet the minimum number of plumbing fixtures required in accordance with Table 411 of this Part.

10. The "Persons (total)" column included in the following Table 411 below is based upon a 50 percent male to 50 percent female ratio.

Title 51, Part XIV

Table 411 Minimum Plumbing Fixtures [The figures shown are based upon one fixture being the minimum required for the number of persons indicated or any fraction thereof, i.e., if the calculation yields any fraction (no matter how small), the next whole number greater than the fractional number is the minimum fixture requirement]								
Building or Occupancy ¹	Occupant Content ¹	Water Closets (Urinals can be substituted for up to half of the required water closets)		Lavatories ²	Bathrooms, Showers and Miscellaneous fixtures			
Dwelling or Apt. House	Not Applicable	1 for each dwelling or dwelling unit		1 for each dwelling or dwelling unit	Washing machine connection per unit ³ . Bathtub or shower – one per dwelling or dwelling unit. Kitchen sink – one per dwelling or dwelling unit			
Schools: Licensed Pre-School, Day Care or Nursery ²¹	Maximum Daily Attendance	Children (total)	Fixtures	To be provided in the same proportions as the number of water closets required	Kitchen: Children (total)			
		Age 0-4 years		Kitchen:	7-15:			
		1-20	1		3 compartment sink (or approved domestic or commercial dishwashing machine and a 2 compartment sink) ¹²			
		21-40	2	1 in each food preparation and utensil washing area located to permit convenient use by all food and utensil handlers.	16 - up:			
		41-80	3		3 compartment sink (dishwashing machine, if provided, must be a commercial type) ¹²			
		For each additional 40 children over 80, add	1	Caring for Infants:	One laundry tray, service sink, or curbed cleaning facility with floor drain on premises for cleaning of mops/mop water disposal.			
		Age 5 years and above		1 in or adjacent to each diaper changing area but never to be located in a food preparation/storage or utensil washing area.	Caring for Infants:			
		Male	Female		One extra laundry tray, service sink, or similar fixture is required to clean and sanitize toilet training potties immediately after each use. Such fixture shall be dedicate solely for this purpose and shall not be in the food preparation/storage, utensil washing, or dining areas.			
		1-40	1					
		41-80	1					
		81-120	2					
		121-160	2					
		For each additional 40 females over 160, add						
			1					
		For each additional 80 males over 160, add						
			1					
Schools: Elementary and Secondary	Maximum Daily Attendance	Persons (total)	Male	Female	Persons (total)	Male	Female	One drinking fountain for each 3 classrooms, but not less than one each floor
		1-50	2	2	1-120	1	1	
		51-100	3	3	121-240	2	2	
		101-150	4	4	For each additional 120 persons over 240, add			
		151-200	5	5		1	1	
		For each additional 50 persons over 200, add						
			1	1				

PUBLIC HEALTH—SANITARY CODE

<p align="center">Table 411 Minimum Plumbing Fixtures [The figures shown are based upon one fixture being the minimum required for the number of persons indicated or any fraction thereof, i.e., if the calculation yields any fraction (no matter how small), the next whole number greater than the fractional number is the minimum fixture requirement]</p>										
Building or Occupancy ¹	Occupant Content ¹	Water Closets (Urinals can be substituted for up to half of the required water closets)			Lavatories ²			Bathtubs, Showers and Miscellaneous fixtures		
		Persons (total)	Male	Female	Persons (total)	Male	Female	Persons	Fixtures	
Office ⁴ and Public Buildings	100 sq ft per person	Persons (total)	Male	Female	Persons (total)	Male	Female	Drinking Fountains	Persons	Fixtures
(Applies to educational occupancies above the 12th grade _(L))		1-15	1	1	1-15	1	1	1-100	1	
		16-35	1	2	16-35	1	2	101-250	2	
		36-55	2	2	36-60	2	2	251-500	3	
		56-100	2	3	61-125	2	3	No less than one fixture each floor subject to access.		
		101-150	3	4	For each additional 120 persons over 125, add	1	1.5			
		For each additional 100 persons over 150, add	1	1.5						
Common toilet facilities for areas of commercial buildings of multiple tenants ^{5,6,20}	Use the sq ft per person ratio applicable to the single type occupancy(s) occupying the greatest aggregate floor area (Consider separately each floor area of a divided floor)	Persons (total)	Male	Female	Persons (total)	Male	Female	Drinking Fountains	Persons	Fixtures
(Not applicable to do-it-yourself laundries, beauty shops and similar occupancies where persons must remain to receive personal services)		1-50	2	2	1-15	1	1	1-100	1	
		51-100	3	3	16-35	1	2	101-250	2	
		101-150	4	4	36-60	2	2	251-500	3	
		For each additional 100 persons over 150, add	1	1.5	61-125	2	3	501-1000	4	
					For each additional 120 persons over 125, add	1	1.5	Not less than one fixture each floor subject to access.		
Retail Stores ^{4,14,16,18}	200 sq ft per person	Persons (total)	Male	Female	Persons (total)	Male	Female	Drinking Fountains ¹⁸	Persons	Fixtures
		1-35	1	1	1-35	1	1	1-100	1	
		36-55	1	2	36-55	1	2	101-250	2	
		56-80	2	3	56-80	2	3	251-500	3	
		81-100	2	4	81-100	2	4	501-1000	4	
		101-150	2	5	101-150	2	5	Not less than one fixture each floor subject to access.		
		For each additional 200 persons over 150, add	1	1.75	For each additional 200 persons over 150, add	1	1.75			
			Retail Food Markets that also processes or packages meat or other food items: 1 lavatory in each food processing, packaging, and utensil washing area located to permit convenient use by all food and utensil handlers.			All Retail Food Markets: One laundry tray, service sink, or curbed cleaning facility with floor drain on premises for cleaning of mops/mop water disposal.				
						Retail Food Markets that also processes or packages meat or other food items: 3 compartment sink ¹²				

Title 51, Part XIV

Table 411 Minimum Plumbing Fixtures [The figures shown are based upon one fixture being the minimum required for the number of persons indicated or any fraction thereof, i.e., if the calculation yields any fraction (no matter how small), the next whole number greater than the fractional number is the minimum fixture requirement]									
Building or Occupancy ¹	Occupant Content ¹	Water Closets (Urinals can be substituted for up to half of the required water closets)			Lavatories ²			Bathtubs, Showers and Miscellaneous fixtures	
		Persons (total)	Male	Female	Persons (total)	Male	Female	Persons	Fixtures
Restaurants/Food Service Establishments ^{4,11, 16, 17} (If alcoholic beverages are to be served, facilities shall be as required for clubs or lounges- See LAC 51:XXIII.3119.B. 2 for further details)	30 sq ft per person	Persons (total)	Male	Female	Persons (total)	Male	Female	Drinking Fountains ¹⁷	
		1-50	1	1	1-150	1	1	1-100	1
		51-100	2	2	151-200	2	2	101-250	2
		101-200	3	3	201-400	3	3	251-500	3
		201-300	4	4	For each additional 200 persons over 300, add				
		1	2	Kitchen: 1 lavatory in each food preparation and utensil washing area located to permit convenient use by all food and utensil handlers.	1	1	Other Fixtures: One laundry tray, service sink, or curbed cleaning facility with floor drain on premises for cleaning of mops/mop water disposal.		
Clubs, Lounges, and Restaurants/ Food Service Establishments with Club, or Lounge ^{11,16, 17}	30 sq ft per person	Persons (total)	Male	Female	Persons (total)	Male	Female	Drinking Fountains ¹⁷	
		1-25	1	1	1-150	1	1	1-100	1
		26-50	2	2	151-200	2	2	101-250	2
		51-100	3	3	201-400	3	3	251-500	3
		101-300	4	4	For each additional 200 persons over 300, add				
		1	2	Bar: 1 lavatory in each drink preparation area and utensil washing area located to permit convenient use by all drink and utensil handlers.	1	1	Other Fixtures: One laundry tray, service sink, or curbed cleaning facility with floor drain on premises for cleaning of mops/mop water disposal.		
Do it yourself Laundries ⁴	50 sq ft per person	Persons (total)	Male	Female	Persons (total)	Male	Female	One drinking fountain and one service sink.	
		1-50	1	1	1-100	1	1		
		51-100	1	2	101-200	2	2		
Beauty Shops, Barber shops, nail Salons, and Tanning Facilities ⁴	50 sq ft per person	Persons (total)	Male	Female	Persons (total)	Male	Female	One drinking fountain and one service sink or other utility sink.	
		1-35	1	1	1-75	1	1		
		36-75	1	2					

PUBLIC HEALTH—SANITARY CODE

<p align="center">Table 411 Minimum Plumbing Fixtures [The figures shown are based upon one fixture being the minimum required for the number of persons indicated or any fraction thereof, i.e., if the calculation yields any fraction (no matter how small), the next whole number greater than the fractional number is the minimum fixture requirement]</p>									
Building or Occupancy ¹	Occupant Content ¹	Water Closets (Urinals can be substituted for up to half of the required water closets)			Lavatories ²			Bathtubs, Showers and Miscellaneous fixtures	
		Persons (total)	Male	Female	Persons (total)	Male	Female		
Heavy manufacturing ⁷ , warehouses ⁸ , foundries, and similar establishments ^{9,10}	Occupant content per shift, substantiated by owner. Also see §411.B.2 of this code	Persons (total) 1-10 11-25 26-50 51-75 76-100 For each additional 60 persons over 100, add	Male 1 2 3 4 5 1	Female 1 1 1 1 1 0.1	Persons (total) 1-15 16-35 36-60 61-90 91-125 For each additional 100 persons over 125, add Where there is exposure to skin contamination with poisonous, infectious, or irritating materials, provide 1 lavatory for each 15 persons.	Male 1 2 3 4 5 1	Female 1 1 1 1 1 0.1	One drinking fountain for each 75 persons. One shower for each 15 persons exposed to excessive heat or to skin contamination with poisonous, infectious, or irritating material.	
Light manufacturing ⁷ , Light Warehousing ⁸ , and workshops, etc. ^{9,10}	Occupant content per shift, substantiated by owner. Also see §411.B.2 of this code	Persons (total) 1-25 26-75 76-100 For each additional 60 persons over 100, add	Male 1 2 3 1	Female 1 2 3 1	Persons (total) 1-35 36-100 101-200 For each additional 100 persons over 200, add Where there is exposure to skin contamination with poisonous, infectious, or irritating materials, provide 1 lavatory for each 15 persons	Male 1 2 3 1	Female 1 2 3 1	One drinking fountain for each 75 persons. One shower for each 15 persons exposed to excessive heat or to skin contamination with poisonous, infectious, or irritating material.	
Dormitories (For exclusively male or female dorms, the fixtures provided shall be double the amount required for the particular gender in a co-ed dorm)	50 sq ft per person (calculated on sleeping area only)	Persons (total) 1-10 11-30 31-100 For each additional 50 persons over 100, add	Male 1 1 3 1	Female 1 2 4 1	Persons (total) 1-12 13-20 For each additional 30 persons over 20, add	Male 1 2 1	Female 1 2 1	One drinking fountain for each 75 persons. One shower or bathtub for each 8 persons, over 150 persons add 1 shower or bathtub for each additional 20 persons. One laundry tray or washing machine for each 50 persons. Service sinks, 1 for each 100 persons.	
Places of Public Assembly without seats and Waiting Rooms at Transportation Terminals and Stations	70 sq ft per person (calculated from assembly area.) Other areas considered separately (see Office or Public Buildings).	Persons (total) 1-50 51-100 101-200 201-400 For each additional 250 persons over 400, add	Male 2 3 4 5 1	Female 2 3 4 5 2	Persons (total) 1-200 201-400 401-750 Over 750 persons, lavatories for each sex shall be required at a number equal to not less than 1/2 of total of required male water closets and urinals.	Male 1 2 3	Female 1 2 3	Drinking Fountains Persons 1-100 101-350	Fixtures 1 2 Over 350 add one fixture for each 400.

Table 411 Minimum Plumbing Fixtures [The figures shown are based upon one fixture being the minimum required for the number of persons indicated or any fraction thereof, i.e., if the calculation yields any fraction (no matter how small), the next whole number greater than the fractional number is the minimum fixture requirement]									
Building or Occupancy ¹	Occupant Content ¹	Water Closets (Urinals can be substituted for up to half of the required water closets)			Lavatories ²			Bathtubs, Showers and Miscellaneous fixtures	
		Persons (total)	Male	Female	Persons (total)	Male	Female	Persons	Fixtures
Theaters, Auditoriums, Stadiums ¹⁵ , Arenas ¹⁵ , and Gymnasiums	Use the number of seats as basis (For pew or bench type seating, each 18 inches of pew or bench shall equate to one person)	1-50	2	2	1-200	1	1	1-100	1
		51-100	3	3	201-400	2	2	101-350	2
		101-200	4	4	401-750	3	3		
		201-400	5	5					
		For each additional 250 persons over 400, add	1	2	Over 750 persons, lavatories for each sex shall be required at a number equal to not less than 1/2 of total of required male water closets and urinals.			Over 350 add one fixture for each 400.	
Churches, Mosques, Synagogues, Temples, and other places of Worship	Use the number of seats as basis (For pew or bench type seating, each 18 inches of pew or bench shall equate to one person)	1-70	1	1	1-200	1	1	1-100	1
		71-150	2	2	201-400	2	2	101-350	2
		151-500	3	3	401-750	3	3		
			For each additional 500 persons over 500, add	1	1	Over 750 persons, lavatories for each sex shall be required at a number equal to not less than 1/2 of total of required male water closets and urinals.			Over 350 add one fixture for each 400.
Retail Fuel Stations (Along an Interstate highway when the station property is located within 1/2 mile of the nearest toe ¹⁹ of the exit/entrance ramp) ¹⁶	Use the number of Fueling Points ¹³ as the basis	Fueling Points	Male	Female	Fueling Points	Male	Female	Fueling Points	Fixtures
		1-8	1	1	1-12	1	1	1-12	1
		9-12	2	2	13 or more	1	2	13 or more	2
		13 or more	2	3					
Retail Fuel Stations not meeting above criteria ¹⁶	Use the number of Fueling Points ¹³ as the initial basis	Fueling Points	Male	Female	Fueling Points	Male	Female	Fueling Points	Fixtures
		1 or more	1	1	1 or more	1	1	1 or more	1
Other Miscellaneous Buildings or Occupancies ²²									

NOTES:

1. The occupant content and the number of required facilities for occupancies other than listed shall be determined by the plumbing official. Plumbing facilities in the occupancies or tenancies of similar use may be determined by the plumbing official from this table. See §411.A.4 of this Code.

2. Twenty-four linear inches (610 mm) of wash sink or 18 inches (457 mm) of a circular basin, when provided with water outlets for such space, shall be considered equivalent to one lavatory (see §415.H of this Code). In accordance with LAC 51:XVII.109.B, the minimum number of required public or public use lavatories/hand-washing fixtures shall be located within the toilet room.

3. When central washing facilities are provided in lieu of washing machine connections in each living unit, central

facilities shall be located for the building served at the ratio of not less than one washing machine for each 12 living units, but in no case less than two machines for each building of 15 living units or less. See §§415.E.2.b and 415.M.4 of this code.

4. With the exception of retail stores associated with retail fuel stations and/or restaurant/food service establishments associated with retail fuel stations and retail stores that require two or more different food permits (see note #14 below), a single facility consisting of one water closet and one lavatory may be used by both males and females in the following occupancies subject to the building area limitations (see also LAC 51:XXIII.3119):

Occupancy	Total Building Area (sq ft)
Office	1200

PUBLIC HEALTH—SANITARY CODE

Occupancy	Total Building Area (sq ft)
Retail Store (within covered mall)	3500
Laundries (Self-Service)	1400
Beauty Shops, Barber Shops, Tanning Facilities, and Nail Salons	900

Occupancy	Usable Floor Space (sq ft)
Restaurant/Food Service Establishment (excluding retail fuel stations)	500
Retail Store (excluding retail fuel stations)	1500*

*A single facility [normally allowed under Note #4 for a retail store occupancy (excluding retail fuel stations)] does not apply when the conditions of Note #14(a) below exist.

5. Common toilet facilities (separate for males and females) for each floor are acceptable in lieu of separate facilities required by this Section only when the applicable building occupant content has common access from within the building. When tenancies, rental units, etc., are to be provided with separate facilities of a partial nature, such facilities are not deductible from the total common facilities required. See §411.A.5 of this Code.

6. Applicable to small stand-up restaurants and similar occupancies.

7.(a). Light manufacturing is applicable to those manufacturers manufacturing finished products which require no special equipment to handle single finished products but may require special equipment to handle the products when packaged in containers containing multiple products,

(b). Heavy manufacturing is applicable to those manufacturing processes requiring overhead cranes or similar equipment for the movement of raw materials and/or the finished products.

8.(a). Light Storage: Light storage is the storage of items which can be handled without the aid of special handling equipment such as cranes, forklifts or similar equipment,

(b). Heavy Storage: Heavy storage is the storage of items which require special equipment for handling such as cranes, forklifts or similar equipment.

9. For other than industrial areas of the occupancy, see other applicable type occupancies (applicable to facilities provided due to inaccessibility of those in main or initial occupancy).

10. As required by the Minimum Requirements for Sanitation in Places of Employment (ANSI Z 4.1). See §405.C of this Code.

11. If alcoholic beverages are to be served, facilities shall be as required for clubs or lounges; however, this requirement shall not be construed to require a restaurant/food service establishment which serves alcoholic beverages and consists of 500 square feet or less of usable floor space to add any more toilet rooms than the minimum required pursuant to Note #4 above (as long as such small restaurant/food service establishment does not have a wet bar and thus would not fall under the “Club, Lounge, and Restaurants/Food Service Establishments with Club, or Lounge” occupancy classification). See LAC 51:XXIII.3119.

12. At the discretion of the plumbing official, one properly sized grease trap for wastewater from the kitchen utensil washing sink(s), dishwashing machine(s), etc., is also required. See §1005.D of this Code.

13. Fueling point means the number of fueling hoses which may be activated simultaneously while refueling automobiles or other motor vehicles. See §203—*Fueling Point* definition of this Code.

14.(a). A retail store which requires two or more different food permits (e.g., grocery permit, restaurant permit, etc.) under LAC 51:XXIII and has a combined usable floor space of more than 500 square feet shall be required to provide

no less than a minimum of two facilities consisting of one water closet and one lavatory each. See LAC 51:XXIII.3119.

(b). A retail store which requires two or more different food permits under LAC 51:XXIII and has a combined usable floor space of 500 square feet or less shall be allowed to operate with a single facility consisting of one water closet and one lavatory used by both males and females. The allowance to operate with a single facility assumes that a wet bar is not located on the premises. See LAC 51:XXIII.3119.

15.(a). Trough urinals may only be used for stadiums, arenas, and jails, prisons, or other institutions of detention or incarceration. Trough urinals, when used, shall conform to the following requirements: They shall not be less than 6 inches deep and shall be furnished with one piece backs and have strainers with outlets at least 1 1/2 inches in diameter. The washdown pipe shall be perforated so as to flush with an even curtain of water against the back of the urinal. This pipe shall be securely clamped as high as practicable to the back of the urinal. Trough urinals, where so equipped, shall have tanks with a flushing capacity of not less than 1 1/2 gallons of water for each 2 feet of urinal length (see §415.L.4 of this Code).

(b). Trough urinals shall be figured on the basis of one urinal for each 18 inches of length, provided that: 24-inch urinal equals 1 urinal; 36-inch urinal equals 2 urinals; 48-inch urinal equals 2 urinals; 60-inch urinal equals 3 urinals; and a 72-inch urinal equals 4 urinals (see §415.L.4 of this Code).

(c). Privacy screens shall not be required for trough urinals. See §415.L.5.c.i.(a) of this Code.

16. If building is a multi-purpose facility (i.e., a retail fuel station and a retail store, or a retail fuel station and a retail store and a restaurant, or a retail store and retail fuel station, etc.), the occupancy which requires the largest number of fixtures shall apply. See §411.A.7 of this Code.

17. Drinking fountain requirement may be waived if drinking water is dispensed in an approved, sanitary manner in accord with the requirements of Part XXIII of the Louisiana State Sanitary Code (LAC 51:XXIII). Minimally, such Part XXIII facility shall hold a health permit from DHH-OPH which requires a three compartment sink and a hand wash lavatory in the food preparation area. Any Part XXIII permitted-facility not meeting this requirement [such as grocery store serving pre-packaged food items only (equivalent to a retail store)] shall install a publicly accessible drinking fountain(s). See LAC 51:XXIII.3119.

18. Drinking fountains shall not be required in retail stores with 2,000 square feet or less of usable floor space.

19. "Toe" is defined as the point where the Interstate highway's exit/entrance ramp meets the intersecting highway. See §203 of this Code—Toe definition.

20. Central facilities shall be installed such that the path of travel to such facilities shall not exceed a distance of 500 feet. The maximum travel distance to the central toilet facilities shall be measured from the main entrance of any store or tenant space. See §411.A.5 of this Code.

21. For pre-school children, between the ages of 0-4, fixtures shall be size appropriate for the age of the children being cared for (toilets 11 inches maximum height and lavatories 22 inches maximum height), or if standard size fixtures are used, safe, cleanable step aids shall be provided. See LAC 51:XXI.105.C.5.a.

22. Refer to the following Parts of the Louisiana State Sanitary Code (LAC 51) for specific information relative to the number of plumbing fixtures required for these other miscellaneous buildings or occupancies:

Building or Occupancy	Louisiana State Sanitary Code (LAC 51)
Wholesale Seafood Plants (Marine and Freshwater)	Part IX
Campsites	Part XVI
Jails, Prisons and Other Institutions of Detention or Incarceration (See §415.L.4 of this code)	Part XVIII

Building or Occupancy	Louisiana State Sanitary Code (LAC 51)
Hospitals, Ambulatory Surgical Centers, Renal Dialysis Centers	Part XIX
Nursing Homes	Part XX
Temporary Food Service (Festivals or Fairs)	Part XXIII, Chapter 47
Swimming Pools	Part XXIV
Mass Gathering Areas	Part XXV

B. Adjustments to Minimum Facilities. When necessary, the following may be utilized to make adjustments to the minimum facilities requirements.

1. The "Persons (total)" column included in Table 411 of this Part is based upon a 50 percent male to 50 percent female ratio. The plumbing official may make adjustments in the distribution of facilities between male and female when furnished satisfactory data to substantiate a claim that the numbers of male and female fixtures in Table 411 of this code would not provide a satisfactory ratio of facilities based on the male-female ratio for the ultimate users. In any case, where deviation is permitted, in accordance with this Section, the plumbing official may require additional facilities if the data submitted proves to be in error or if changes are made that affect such data, whether it be by the original or later owner or occupants of the building or tenancy.

2. The plumbing official may make adjustments in the occupant content established by Table 411 of this code when, in a particular case, satisfactory data, accompanied by plans, is furnished which substantiates a claim that the occupant content of a particular building or tenancy will, at all times, be less than provided for in the above table. Approval of such data and accompanying claims shall not prevent the plumbing official from requiring additional facilities based on the above table, should changes be made affecting the data or plan upon which the original approval was based whether such changes be made by the original or ultimate owner or building occupant or occupants. The remainder of the facilities' requirements of §411 of this code are not affected by this paragraph.

C. Facilities' Separation. The occupant content established by this code shall not be construed to have any force or effect upon the occupant content requirements of the codes adopted under the authority of Act 12 of the 2005 First Extraordinary Session. The occupant content in this code is established only to calculate the number of plumbing facilities required for a building or for a tenancy within a building when such tenancy is separated from the remainder of the building by walls or partitions or when central facilities would not provide for the satisfactory needs of a tenant's patrons who must remain in a given area to receive the service rendered.

AUTHORITY NOTE: Promulgated in accordance with R.S. 40:4(A)(7) and R.S. 40:5(2)(3)(7)(9)(16)(17)(20).

HISTORICAL NOTE: Promulgated by the Department of Health and Hospitals, Office of Public Health, LR 38:2816 (November 2012), repromulgated LR 39:511 (March 2013), amended LR 41:390 (February 2015).

§413. Fixture Outlets

A. Lavatory Waste Outlets. Lavatories shall have waste outlets not less than 1 1/4-inch diameter. Waste outlets may have open strainers or may be provided with stoppers.

B. Sink Waste Outlets. Sinks shall be provided with waste outlets not less than 1 1/2-inch diameter. Waste outlets may have open strainers or may be provided with stoppers.

C. Strainers and Fixture Outlets. All plumbing fixtures, other than water closets and siphon-action washdown or blowout urinals, shall be provided with strainers having waterway area complying with Table 407 of this code.

D. Overflows. The following applies to overflows for plumbing fixtures.

1. Design. When any fixture is provided with an overflow, the waste shall be so arranged that the standing water in the fixture cannot rise in the overflow when the stopper is closed or remain in the overflow when the fixture is empty.

2. Connection. The overflow pipe from a fixture shall be connected on the house or inlet side of the fixture trap, except that overflows of flush tanks may discharge into the water closets or urinals served by them, but it shall be unlawful to connect such overflows with any other part of the drainage system.

AUTHORITY NOTE: Promulgated in accordance with R.S. 40:4(A)(7) and R.S. 40:5(2)(3)(7)(9)(16)(17)(20).

HISTORICAL NOTE: Promulgated by the Department of Health and Hospitals, Office of Public Health, LR 38:2823 (November 2012).

§415. Fixture Types

A. Commercial Dishwashing Machines. The following applies to commercial dishwashing machines.

1. Protection. Commercial dishwashing machines shall meet the requirements of §§609 and 807.B of this code.

2. Waste Connection. Each unit may be separately trapped or discharge indirectly into a properly trapped and vented fixture. A commercial dishwashing machine shall not be directly connected to a drainage system. When a commercial dishwashing machine is located within 5 feet of a trapped floor drain, the dishwasher waste outlet may be connected directly on the inlet side of a properly vented floor drain trap.

3. Sanitization. Commercial dishwashing machines shall be installed and operated in accord with the manufacturer's recommendations and with the mechanical cleaning and sanitizing requirements contained within Part XXIII (Eating and Drinking Establishments) of the Louisiana State Sanitary Code (LAC 51:XXIII).

4. Flow Pressure. When spray-type dishwashing machines are used in commercial installations, the pressure measured in the final rinse water line shall be at least 15 psi (103 kPa) and not more than 25 psi (172 kPa) when the final rinse spray is operating. A suitable pressure gauge and gage cock shall be provided in a readily accessible location

immediately upstream from the final rinse sprays to permit checking the flow pressure of the final rinse water. If necessary, a permanently installed pressure regulator shall be provided on the final rinse water line in order to maintain the proper water pressure in the line when the final rinse spray is operating.

B. Domestic Dishwashing Machines. The following applies to domestic dishwashing machines.

1. Protection. Domestic dishwashing machines shall meet the requirements of §§609 and 807.B of this code.

2. Waste Connection. Each unit may be separately trapped or discharge indirectly into a properly trapped and vented fixture. A domestic dishwashing machine shall not be directly connected to a drainage system. It may be connected through a wye connection into the tail piece of a sink or into the body of a disposal unit with the flexible dishwasher hose looped up to within 2 inches of the bottom of the counter top.

C. Drinking Fountains. The following applies to drinking fountains.

1. Design and Construction. Drinking fountains shall conform to ASME A 112.19.1 or CSA B45.2 if of enameled cast iron or enameled steel; or ASME A 112.19.2 or CSA B45.1 if of ceramic. Mechanically refrigerated drinking fountains shall also conform to ARI 1010. All drinking fountains shall conform to NSF 61.

2. Protection of Water Supply. Stream projectors shall be so assembled as to provide an orifice elevation as specified by ASME A 112.1.2.

3. Prohibited Location. Drinking fountains shall not be installed in public toilet rooms.

4. Minimum Required Separation from Contamination. Drinking fountain fixtures shall provide a minimum of 18 inches of separation from its water outlet (spigot) to any source of contamination. Combination sink/drinking fountain units shall provide a minimum of 18 inches between the drinking fountain water outlet (spigot) and the nearest outside rim of the sink bowl [or other source(s) of contamination].

a. Exception. This 18 inch minimum separation may only be reduced by the use of a vertical shield made of a smooth, easily cleanable surface that is attached flush with the top surface of the unit and extends to a distance at least 18 inches in height above the drinking fountain water outlet (spigot) level.

b. Prohibited Fixture. Combination sink/drinking fountain units which share the same sink bowl are prohibited except in individual prison cells.

5. Minimum Fixture Requirements. Water dispensing type drinking fountains which connect to the potable water distribution system but require the use of an individual cup or container shall be permitted to substitute for not more than 50 percent of the required number of drinking fountains. Bottled water-type dispensers are prohibited from

counting toward the minimum required number of drinking fountains.

D. Garbage Can Washers. Garbage can washers shall be separately trapped. The receptacle receiving the wash from garbage cans shall be provided with a removable basket or strainer to prevent discharge of large particles into the building drainage system. Any water supply connection shall be protected against backflow by an air gap (water distribution) or an approved backflow prevention device.

E. Floor Drains. The following applies to floor drains.

1. Installation. The installation of floor drains shall comply with the following.

a. Floor drains shall connect into a trap so constructed that it can be readily cleaned and of a size to efficiently serve the purpose for which it is intended. The drain inlet shall be located so that it is, at all times, in full view and accessible.

b. Floor drains shall have a minimum 2-inch diameter drain outlet and connect to a trap no less than 2-inches in diameter.

c. Floor drains subject to backflow shall not be directly connected to the drainage system or shall be provided with a backwater valve.

d. Floor drains shall be provided with removable strainers meeting §807.G.2 of this code, the open area of which shall be not less than two-thirds of the cross-sectional area of the trap to which it connects.

2. Required Locations. Floor drains shall be installed in the following areas:

a. Floor drains shall be installed in all public toilet rooms, etc., (see definition of Public or Public Use in Chapter 2 of this code) and shall be fed (the water seal replenished) by an approved automatic trap priming device meeting the requirements of and installed in accordance with §415.E.4.a, §415.E.4.b, or §415.E.4.c of this code.

i. Exceptions

(a). Floor drains are not required in the toilet rooms serving hotel/motel guest rooms or patient rooms of hospitals and nursing homes.

(b). In existing ground floor construction, the addition of floor drains in public toilet rooms is only required when substantial renovation or fixture additions to the public toilet room(s) occurs which requires the concrete slab to be broken or when a serious health threat to the public exists.

b. In public coin operated laundries and in the central washing facilities of apartment buildings or in rooms containing connections for laundry machines except in one and two family dwellings, the rooms containing the laundry machines shall be provided with adequate floor drains located to readily drain the entire floor area. When such floor drains are not embedded in concrete, the floors shall be properly lined as required by §415.I.2 of this code and the

required floor drains shall meet the design criteria for shower drains in §415.I.1 of this code.

c. Recess rooms located within medical facilities which contain the recessed or concealed portions of sterilizers shall be provided with a minimum of one acceptable floor drain in accordance with §1305.C.2 of this code.

d. Each toilet room and laundry room in the service buildings of travel trailer parks shall be provided with a minimum 2-inch floor drain in accordance with §1509.F of this code.

3. Prohibited Locations. The following applies to prohibited locations of floor drains.

a. No floor drain or other plumbing fixture except electric water heaters shall be installed in a room containing air handling machinery when such room is used as a plenum. When rooms are used as a plenum, equipment drains shall be conveyed through an indirect waste receptor located outside such rooms or other approved point of disposal.

b. Floor drains directly connected to the plumbing system shall not be located in elevator pits.

c. No floor drains shall be permitted in food storage areas unless installed in accordance with §807.A of this code.

d. Floor drains are not permitted in walk-in coolers or freezers unless they are provided with indirect connections to the sanitary sewer located outside the walk-in cooler or freezer.

4. Trap Seal Protection. Floor drain or similar traps shall be regularly and automatically fed (the water seal replenished) by the addition of water, liquid waste, or industrial waste (such as the normal and regular operation of a plumbing fixture or condensate waste draining thereto) into the floor drain or, in lieu thereof, shall be protected by the use of:

a. an ASSE 1018 automatic trap priming device (see §625.D of this code);

b. an electronic potable water supply fed trap priming device meeting ASSE 1044 (see §625.D of this code);

c. a drainage type device meeting ASSE 1044 which captures liquid wastes only from:

i. the tail piece of a lavatory;

ii. the discharge side of the atmospheric vacuum breaker located downstream of a flushometer valve servicing a water closet or a clinical sink (the take off point on the discharge pipe must be at least 4" below the critical level of the vacuum breaker); or,

iii. the refill/hush tube of ballcocks (only on ballcocks that utilize an atmospheric vacuum breaker in accordance with the requirements of §609.C.2 of this code).

d. an ASSE 1072 listed barrier type floor drain trap seal protection device; or,

e. a combination of the methods listed above, i.e., the use of an ASSE 1072 device in addition to the use of either an ASSE 1018 or ASSE 1044 automatic trap priming device.

F. Food Waste Grinder Units. The following applies to food waste grinder units.

1. Separate Connections. Domestic food waste disposal units may be connected and trapped separately from any other fixture or compartment. Units may have either automatic or hand-operated water-supply control. See §609 of this code.

2. Commercial Type Grinders. Food grinders used in commercial buildings shall have an automatic water-supply and shall be provided with not less than 2-inch (51mm) waste line. Each waste line shall be trapped and vented as provided in other Sections of this code (see §1005.K.1 of this code).

G. Laundry Trays. The following applies to laundry trays.

1. Waste Outlets. Each compartment of a laundry tray shall be provided with a waste outlet not less than 1 1/2 inches in diameter.

2. Overflow. Laundry tray overflows shall conform to the requirements of §413.D of this code.

H. Multiple Washsinks. The following applies to multiple washsinks.

1. Circular Type. Each 18 inches (457 mm) of wash sink circumference (circular type), when provided with water outlets for such space, shall be equivalent to one lavatory.

2. Straight-Line Type. Multiple wash sinks of the straight-line type shall have hot and cold combination spouts not closer than 24 linear inches (610 mm) from adjacent similar spouts and each spout shall be considered the equivalent of one lavatory.

I. Shower Compartments. The following applies to shower compartments.

1. Shower. Shower compartments shall conform to Table 415.I of this Part and shall have approved shower pan material or the equivalent thereof as determined by the plumbing official. The pan shall turn up on three sides at least 2 inches (51 mm) above finished curb level. The remaining side shall wrap over the curb. Shower drains shall be constructed with a clamping device so that the pan may be securely fastened to the shower drain thereby making a watertight joint. Shower drains shall have an approved weephole device system to insure constant drainage of water from the shower pan to the sanitary drainage system. There shall be a watertight joint between the shower drain and trap. Shower receptacle waste outlets shall be not less than 2 inches and shall have a removable strainer.

a. Exception. Shower compartments with prefabricated receptors conforming to the standards listed in Table 415.I of this Part, or special use shower compartments for accessible use which comply with the ANSI A117.1 accessibility standard.

Table 415.I Prefabricated Shower Receptor Standards	
Materials	Standards
Plastic Bathtub and Shower Units	ANSI Z124.1.2
Chlorinated Polyethylene (CPE) Sheeting for Concealed Water-Containment Membrane	ASTM D 4068
Polyvinyl Chloride (PVC) Plastic Flexible Concealed Water-Containment Membrane	ASTM D 4551, See §303.G.7 of this code

2. Construction. Floors under shower compartments shall be laid on a smooth and structurally sound base and shall be lined and made watertight with sheet lead, copper or other acceptable materials.

3. Public or Institutional Showers. Floor of public shower rooms shall be drained in such a manner that no waste water from any shower head will pass over floor areas occupied by other bathers.

J. Special Fixtures. The following applies to special fixtures.

1. Water Drain and Connections. Baptistries, ornamental and lily pools, aquaria, ornamental fountain basins and similar constructions when provided with water supplies shall be protected from backsiphonage as required in §609.A and Table 609.F.6 of this code.

2. Approval. Specialties requiring water and waste connections shall be submitted for approval of the plumbing official.

3. Accessible Fixtures. Accessible fixtures shall comply with the requirements of ANSI A117.1.

K. Swimming Pools, Spas, and Hot Tubs. The following applies to swimming pools, spas, and hot tubs.

1. Water Circulation System Components. Water circulation system components and disinfectant equipment for swimming pools, spas or hot tubs shall meet the requirements of NSF 50. [For other swimming pool and spa requirements, also see Part XXIV (Swimming Pools) - Louisiana State Sanitary Code (LAC 51:XXIV)]

2. Suction Fittings. Suction fittings shall conform to ASME A 112.19.8 or APSP 16. Public, Residential Spas shall comply with the standards listed in the following Table 415.K below.

Table 415.K Public and Residential Spas Standards	
Materials	Standards
Public Spas	APSP-2
Residential Spas, Permanently Installed	APSP-3
Residential Spas, Portable	APSP-6

L. Urinals. The following applies to urinals.

1. Automatic Flushing Tank. Tanks flushing more than one urinal shall be automatic in operation and of sufficient capacity to provide the necessary volume to flush and properly cleanse all urinals simultaneously.

2. Urinals Equipped with Automatic Flush Valves. Flushometers shall be as prescribed in §415.N.5 of this code and no valve shall be used to flush more than one urinal.

3. Nonwater Urinals. Nonwater urinals shall conform with LAC 51:XIV.409.A.2.

4. Trough Urinals. Trough urinals may only be used for stadiums, arenas, and jails, prisons, or other institutions of detention or incarceration. Trough urinals, when used, shall conform to the following requirements:

a. Shall not be less than 6 inches deep and shall be furnished with one piece backs and have strainers with outlets at least 1 1/2 inches in diameter.

b. The washdown pipe shall be perforated so as to flush with an even curtain of water against the back of the urinal. This pipe shall be securely clamped as high as practicable to the back of the urinal. Trough urinals, where so equipped, shall have tanks with a flushing capacity of not less than 1 1/2 gallons of water for each 2 feet of urinal length.

c. Trough urinals shall be figured on the basis of one urinal for each 18 inches of length, provided that: 24-inch urinal equals 1 urinal; 36-inch urinal equals 2 urinals; 48-inch urinal equals 2 urinals; 60-inch urinal equals 3 urinals; and a 72-inch urinal equals 4 urinals.

5. Privacy. Privacy walls or partitions shall be provided for each urinal within public use and employee use toilet rooms used by males. Such walls or partitions shall conform to the following:

a. The wall or partition finish surface shall be non-absorbent, smooth, and easily cleanable.

b. The walls or partitions shall begin at a height of not more than 14 inches above the finished floor surface and shall extend not less than 60 inches above the finished floor surface.

c. The walls or partitions shall extend from the wall surface at each side of the urinal a minimum of 18 inches or to a point not less than 6 inches beyond the outermost front lip of the urinal measured from the finished back wall surface, whichever is greater.

i. Exceptions. The following conditions shall constitute an exception (or a partial exception) to the requirement for privacy walls or partitions for each urinal within public use toilet rooms used by males:

(a). toilet rooms having wall-hung trough urinals only (which are currently only allowed in stadiums, arenas, and in jails, prisons, and other places of detention or incarceration);

(b). toilet rooms used by children less than 5 years of age which are located in day care and child-care

facilities and which contain two or more urinals shall be permitted to have one urinal without privacy walls or partitions; or,

(c). toilet rooms located in jails, prisons and other places of detention or incarceration.

M. Washing Machines for Residences. The following applies to washing machines for residences.

1. Protection. Domestic washing machines shall meet the requirements of §609.A of this code.

2. Separate Trap. Each unit shall be separately trapped or discharge indirectly into a properly trapped and vented fixture (see §1001.I of this code).

3. Cross Fittings. Automatic washing machines shall not be connected to a 2-inch or smaller cross-type fitting.

4. Central Facilities. When central washing facilities are provided in lieu of washing machine connections in each living unit, central facilities shall be located for the building served at the ratio of not less than one washing machine for each 12 living units, but in no case less than two machines for each building of 15 living units or less. See §415.E.2.b of this code.

N. Water Closets. The following applies to water closets.

1. Public Use. Water closet bowls for public use including, but not limited to, hotel and motel guest rooms and patient rooms of hospitals and nursing homes shall be of the elongated type.

2. Flushing Device. Water closet gravity, tanks, flushometer tanks and flushometer valves shall have a flushing capacity sufficient to properly flush the water closet bowls to which they are connected.

3. Float Valves. Float valves in water closet tanks shall close tight and provide water to properly refill the trap seal in the bowl.

4. Close-Coupled Tanks. The flush valve seat in close-coupled water closet combinations shall be 1 inch (25.4 mm) or more above the rim of the bowl, so that the flush valve will close even if the closet trapway is clogged. Any closets with flush valve seats below the rim of the bowl shall be so constructed that in case of trap stoppage, water will not flow continuously over the rim of the bowl.

5. Automatic Flush Valve. Flushometers shall be so installed that they will be readily accessible for repairing. When the valve is operated, it shall complete the cycle of operation automatically, opening fully and closing positively under the service pressure. At each operation, the valve shall deliver water in sufficient volume and at a rate that will thoroughly flush the fixture and refill the fixture trap. Means shall be provided for regulating flush valve flow. Not more than one fixture shall be served by a single flush valve.

6. Seats. Water closets shall be equipped with seats of smooth nonabsorbent material. All seats of water closets provided for public use including, but not limited to, hotel and motel guest rooms and patient rooms of hospitals and

nursing homes shall be of the open-front type. Integral water closet seats shall be of the same material as the fixture. The seat contour shall be the same contour as the water closet.

7. Water Closet Compartment. Each water closet utilized by the public or employees shall occupy a separate compartment with walls or partitions and a lockable door enclosing the individual fixture to ensure privacy. Such walls or partitions shall conform to the following:

a. The wall or partition finish surface shall be non-absorbent, smooth, and easily cleanable.

b. The walls or partitions shall begin at a height of not more than 14 inches above the finished floor surface (except when same would be higher than the bowl rim of a child-sized toilet) and shall extend not less than 66 inches above the finished floor surface. For child-sized toilets, the walls or partitions shall begin at a height no higher than the bowl rim of the child-sized toilet.

i. Exceptions. The following conditions shall constitute an exception (or a partial exception) to the requirement for separate compartments for each water closet:

(a). toilet rooms containing only a single water closet (or only a single water closet and lavatory) with a lockable door;

(b). toilet rooms located in day care and child-care facilities which care for children less than 5 years of age and containing two or more water closets shall be permitted to have one water closet without an enclosing compartment; or,

(c). toilet rooms located in jails, prisons and other institutions of detention or incarceration.

O. Whirlpool Bathtubs. The following applies to whirlpool bathtubs.

1. Access. An access panel of sufficient size shall be installed to provide access to the pump for repair and replacement.

2. Pump. When not factory assembled to the tub assembly, the circulation pump shall be accessibly located above the crown weir of the trap. The pump drain line shall be properly graded to assure minimum water retention in the volute after fixture use.

3. Operation. Leak testing and pump operation shall be performed in accordance with manufacturer's recommendations.

4. Hydro-massage Bathtubs. Hydro-massage bathtubs shall comply with ASME A 112.19.7.

5. Whirlpool Bathtub Appliances. Whirlpool bathtub appliances shall comply with ASME A 112.19.7.

6. Suction Fittings. Suction fittings for use in whirlpool bathtubs shall comply with ASME A 112.19.8 or APSP 16.

AUTHORITY NOTE: Promulgated in accordance with R.S. 40:4(A)(7), R.S. 40:5(2)(3)(7)(9)(16)(17)(20), and HCR 4 of the 2008 Regular Session.

HISTORICAL NOTE: Promulgated by the Department of Health and Hospitals, Office of Public Health, LR 38:2823 (November 2012).

§417. Additional Provisions for Plumbing Fixtures

A. Additional provisions for plumbing fixtures are contained in Chapter 13, Medical Facilities Plumbing Systems, of this code.

AUTHORITY NOTE: Promulgated in accordance with R.S. 40:4(A)(7) and R.S. 40:5(2)(3)(7)(9)(16)(17)(20).

HISTORICAL NOTE: Promulgated by the Department of Health and Hospitals, Office of Public Health, LR 38:2827 (November 2012).

Chapter 5. Water Heaters

§501. General

A. Scope. The provisions of this Chapter shall govern the materials, design, and installation of water heaters.

B. Working Pressure Identification. All storage tanks and water heaters shall be clearly and indelibly marked showing the allowable safe working pressure.

C. Water Heater as Space Heater. A water heater may be used as a part of a space heating system if the outlet water temperature of the water heater does not exceed 160°F (71°C) and the potability of the water is maintained throughout the system.

D. Sediment Drains. A suitable water valve or cock, through which sediment may be drawn off or the heater or tank emptied, shall be installed at the bottom of the heater or tank.

E. Location. The following applies to the location of water heaters and/or associated storage tanks.

1. Water heaters and storage tanks shall be so located and connected that they will be accessible for observation, maintenance, servicing and replacement.

2. Gas water heaters in residential garages shall be installed so that all burners and burner ignition devices are located not less than 18 inches above the floor.

3. Gas water heaters shall be located, or reasonably protected, so that they are not subject to physical damage by a moving vehicle.

4. Every attic or furred space in which water heaters and/or storage tanks are installed shall be readily accessible by an opening and passageway as large as the largest piece of equipment and in no case less than 22 x 36 inches (559 x 914 mm) continuous from the opening to the equipment and its controls. The opening to the passageway should be located not more than 20 ft (6096 mm) from the equipment measured along the center line of such passageway. Every passageway shall be unobstructed and shall have solid continuous flooring not less than 24 inches (610 mm) wide from the entrance opening to the equipment. On the control side and on other sides where access is necessary for

servicing of equipment, a level working platform extending a minimum 30 inches (762 mm) from the edge of the equipment with a 36 inch (914 mm) high clear working space shall be provided.

F. Marking. All water heaters and associated storage tanks shall comply with the following marking requirements.

1. Water Heaters. All water heaters shall bear the following, or equal wording on a visible decal or label by the manufacturer:

There shall be installed at time of heater installation a combination temperature and pressure relief valve, selected and located in conformance with the requirements of ANSI Z21.22 or CSA 4.4M.

2. Pressure Marking of Storage Tanks. Any storage tank installed for domestic hot water shall have clearly and indelibly stamped in the metal, or so marked upon a plate welded thereto or otherwise permanently attached, the maximum allowable working pressure. Such markings shall be in an accessible position outside of the tank so as to make inspection or reinspection readily possible. All unlisted storage tanks for domestic hot water shall meet the applicable ASME standards.

AUTHORITY NOTE: Promulgated in accordance with R.S. 40:4(A)(7) and R.S. 40:5(2)(3)(7)(9)(16)(17)(20).

HISTORICAL NOTE: Promulgated by the Department of Health and Hospitals, Office of Public Health, LR 38:2827 (November 2012).

§503. Standards

A. Electric Water Heaters. Electric residential water heaters shall comply with UL 174.

B. Gas Water Heaters. Automatic storage type gas water heaters with inputs of 75,000 Btuh (22 kW), or less shall comply with ANSI Z21.10.1 or CSA 4.1. Circulating tank, instantaneous and large automatic storage type gas water heaters shall comply with ANSI Z21.10.3 or CSA 4.3.

C. Testing and Listing. Water heaters shall be tested and listed by an approved agency.

AUTHORITY NOTE: Promulgated in accordance with R.S. 40:4(A)(7) and R.S. 40:5(2)(3)(7)(9)(16)(17)(20).

HISTORICAL NOTE: Promulgated by the Department of Health and Hospitals, Office of Public Health, LR 38:2828 (November 2012).

§505. Minimum Capacities for Residential Water Heaters

A. Water heaters installed in residential occupancies may be sized in accordance with the following Table 505.

Table 505											
Minimum Capacities For Water Heaters ^{1,2}											
Number of Bathrooms	1 to 1.5			2 to 2.5			3 to 3.5				
Number of Bedrooms	1	2	3	2	3	4	5	3	4	5	6
First Hr Rating Gal.	42	54	54	54	67	67	80	67	80	80	80
Nom. Tank Size, Gal.											
Gas Water Heaters	20	30	30	30	40	40	50	40	50	50	50
Elect. Water Heaters	30	50	50	50	66	66	80	66	80	80	80
Oil Water Heaters	30	30	30	30	30	30	30	30	30	30	30

NOTES:

1. The main criteria for a properly sized water heater is a sufficient first hour rating to meet peak hot water demand. The majority of tank sizes shown in the table will have a first hour rating equal to or greater than the first hour rating indicated. A water heater with a smaller tank size than shown in the table but with a sufficient first hour rating shall be permitted.
2. The first hour rating is found on the "Energy Guide" label.

B. Non-storage and solar water heaters shall be sized with sufficient capacity to meet the appropriate first hour rating shown in Table 505 above.

AUTHORITY NOTE: Promulgated in accordance with R.S. 40:4(A)(7) and R.S. 40:5(2)(3)(7)(9)(16)(17)(20).

HISTORICAL NOTE: Promulgated by the Department of Health and Hospitals, Office of Public Health, LR 38:2828 (November 2012).

§507. Prohibited Installations

A. Water heaters (using solid, liquid or gas fuel) with the exception of those having direct vent systems, shall not be installed in bathrooms and bedrooms or in a closet with access only through a bedroom or bathroom. However, water heaters of the automatic storage type may be installed as replacement in a bathroom, when specifically authorized by the plumbing official, provided they are properly vented and supplied with adequate combustion air.

1. Exception. When a closet, having a weather-stripped solid door with an approved door closing device, has been designed exclusively for the water heater and where all air for combustion and ventilation is supplied from outdoors.

B. Water heaters (using solid, liquid or gas fuel) shall not be installed in a room containing air handling machinery when such room is used as a plenum.

AUTHORITY NOTE: Promulgated in accordance with R.S. 40:4(A)(7) and R.S. 40:5(2)(3)(7)(9)(16)(17)(20).

HISTORICAL NOTE: Promulgated by the Department of Health and Hospitals, Office of Public Health, LR 38:2828 (November 2012).

§509. Connections

A. A shutoff valve shall be provided in the cold water branch line to each water storage tank or each water heater, on the same floor within 3 feet of the heater. Full port ball valve shut-offs on cold water branch lines to 2 inches or full port ball or resilient wedge-type shut-off valves for 2 1/2-inch lines and larger shall be used. The valving shall not interfere or cause a disruption of the cold water supply to the remainder of the cold water system.

B. The method of connecting a circulating water heater to the tank shall assure proper circulation of water through the heater, and permit a safe and useful temperature of water to be drawn from the tank. The pipe or tubes required for the installation of appliances which will draw from the water heater or storage tank shall be subject to the applicable provisions of this code for material and installation.

AUTHORITY NOTE: Promulgated in accordance with R.S. 40:4(A)(7) and R.S. 40:5(2)(3)(7)(9)(16)(17)(20).

HISTORICAL NOTE: Promulgated by the Department of Health and Hospitals, Office of Public Health, LR 38:2828 (November 2012).

§511. Safety Devices

A. Anti-Siphon and Vacuum Relief Devices. Anti-siphon and vacuum relief devices shall be provided and installed in accord with the following.

1. Means acceptable to the plumbing official shall be provided to prevent siphoning of any water heater or tank to which any water heater or tank is connected. A cold water "dip" tube with a hole at the top or a vacuum relief valve installed in the cold water supply line above the top of the heater or tank may be accepted for this purpose.

2. Bottom fed heaters or bottom fed tanks connected to water heaters shall have a vacuum relief valve installed. The vacuum relief valve shall be in compliance with the appropriate requirements of ANSI Z21.22 or CSA 4.4M.

B. Water Temperature Control in Piping from Tankless Heaters. The temperature of water from tankless heaters shall be tempered to 140°F (60°C) when intended for domestic uses. This provision shall not supersede the requirement for protective valves per §623 of this code.

C. Relief Valve. All storage water heaters operating above atmospheric pressure shall be provided with an approved, self-closing (levered) pressure relief valve and temperature relief valve or combination thereof, except for nonstorage instantaneous heaters. Such valves shall be installed in the shell of the water heater tank or may be installed in the hot water outlet, provided the thermo-bulb extends into the shell of the tank. Temperature relief valves shall be so located in the tank as to be actuated by the water in the top one-eighth of the tank served. For installations with separate storage tanks, said valves shall be installed on the tank and there shall not be any type of valve installed between the water heater and the storage tank. There shall not be a check valve or shutoff valve between a relief valve and the heater or tank which it serves. The relief valve shall not be used as a means of controlling thermal expansion (see §623.D of this code).

D. Energy Cutoff Device. All automatically controlled water heaters shall be equipped with an energy cutoff device which will cut off the supply of heat energy to the water tank before the temperature of the water in the tank exceeds 210°F (99°C). This cutoff device is in addition to the temperature and pressure relief valves.

E. Relief Valve Approval. Temperature and pressure relief valves, or combinations thereof, or energy shutoff devices shall bear the label of the AGA or ASME, with a thermosetting of not more than 210°F (99°C) and pressure setting not to exceed the tank or heater manufacturer's rated working pressure. The relieving capacity of these two devices shall each equal or exceed the heat input to the water heater or storage tank.

F. Relief Outlet Waste. The outlet of a pressure, temperature, or other relief valve shall not be directly connected to the drainage system.

G. Heater Over 200,000 Btu/h Input. The relief valve shall have a minimum AGA temperature steam rating of 200,000 Btu (211,000 kJ), shall comply with all construction, testing and installation requirements of ANSI Z21.22 or CSA 4.4M, and shall have minimum 1-inch inlet and outlet pipe size connections. In addition, the temperature relieving element of the valve shall have a water discharge capacity based on 1250 Btu (1319 kJ) for each gallon per hour of water discharged at 30 psi (207 kPa) working pressure and a maximum temperature of 210°F (99°C). This rating must be certified by the valve manufacturer. Also, the pressure relieving element of the valve shall be ASME pressure steam rated. Both the temperature water rating and the ASME pressure steam rating of the combination temperature and pressure relief valve shall be equal to or in excess of the input to the hot water storage tank or storage water heater.

H. Safety Pans and Relief Valve Waste. Safety pans and relief valve waste piping shall comply with the following.

1. When water heaters or hot water storage tanks are installed in remote locations such as suspended ceiling spaces or in attics, the tank or heater shall rest in a galvanized steel or other metal pan of equal corrosive resistance having a thickness at least equal to 0.0276-inch (0.7 mm) galvanized sheet steel.

a. Exception. Electric water heaters may rest in a high impact plastic pan of at least 1/16-inch (1.6 mm) thickness.

2. Safety pans shall be no less than 1 1/2 inches (38mm) deep and shall be of sufficient size and shape to receive all drippings or condensate from the tank or heater. The pan shall be drained by a pipe no less than 1-inch (25.4 mm) diameter.

3. The pan drain shall extend full-size and terminate over a suitably located indirect waste receptor or floor drain or extend to the exterior of the building and terminate no less than 6 inches (152 mm) or more than 24 inches (610 mm) above finish grade_(G).

4. The discharge from the relief valve shall be piped full-size separately to the outside of the building or to an indirect waste receptor so that any discharge can cause no personal injury or property damage and can be readily observed by the building occupants. Relief valve discharge piping shall contain no valves or traps and shall be so graded and connected as to drip to the discharge end of the piping by gravity. When the relief valve discharge is piped to the outside of the building, it shall terminate no less than 6 inches (152 mm) and no more than 24 inches (610 mm) above finish grade_(G).

5. Relief valve discharge piping shall be of those materials listed in §619 or Table 511 of this code, or shall be tested and rated for such use.

Table 511 Relief Valve Materials	
Material(s)	Standard
Water Heater Relief Valve Drain Tubes	ASME A 112.4.1

AUTHORITY NOTE: Promulgated in accordance with R.S. 40:4(A)(7) and R.S. 40:5(2)(3)(7)(9)(16)(17)(20).

HISTORICAL NOTE: Promulgated by the Department of Health and Hospitals, Office of Public Health, LR 38:2828 (November 2012).

§513. Solar Water Heating Systems

A. Solar energy systems used for heating potable water or using an independent medium for heating potable water shall comply with the applicable requirements of this code. The use of solar energy shall not compromise the requirements for cross connection or protection of the potable water distribution system, water service pipe, or water supply system required by this code. Solar energy systems shall also meet the applicable requirements of the state-adopted energy code and the applicable codes adopted under the authority of Act 12 of the 2005 First Extraordinary Session.

B. Definitions. Definitions contained in Chapter 2 of this code shall also apply to this Section except where the following special definitions shall apply.

Active Solar System—a solar water heating system that utilizes an electric pump and controllers to circulate heat transfer fluid through the solar collectors.

Auxiliary Heating Equipment—equipment utilizing energy other than solar, to supplement the output provided by the solar energy system.

Closed Loop System—system where the collector loop heat transfer fluid is enclosed in a piping loop separate from the potable water supply.

Collector Loop—the piping of a collector system in which a *heat transfer fluid* circulates between the *solar collector(s)* and a heat exchanger.

Direct-Circulation System—a system where the *potable water* is heated as a result of being circulated directly through the collectors (these systems are prohibited).

Double Wall Heat Exchanger—a heat exchanger design in which a single failure of any fluid barrier will not cause a cross connection or permit back siphonage of *heat transfer fluid* into the *potable water supply*. Any barrier which fails shall allow the discharge of *heat transfer fluid* and/or *potable water* to the atmosphere at a location visible to the operator or owner.

Drainback System—liquid system that only fills the collector when the temperature differential is appropriate. The water that is circulated through the collectors is stored in a reservoir.

Engineered Solar System—a system designed for a specific building project with drawings and specifications indicating materials to be installed, all as prepared by a person registered or licensed to perform solar design work.

Heat Transfer Fluid—the operating or thermal storage liquid in a mechanical system, including water or other liquid base, and additives at the concentration present under operating conditions used to move heat from one location to another. Refrigerants are not included as *heat transfer fluids*.

Human Consumption—the use of water by humans for drinking, cooking, bathing, showering, hand washing, dishwashing, or maintaining oral hygiene.

IAF—International Accreditation Forum, the world association of Conformity Assessment Accreditation Bodies and other bodies interested in conformity assessment in the fields of management systems, products, services, personnel and other similar programs of conformity assessment. Its primary function is to develop a single worldwide program of conformity assessment which reduces risk for business and its customers by assuring them that accredited certificates may be relied upon. Accreditation assures users of the competence and impartiality of the body accredited.

IAF MLA Signatory—The objective of the *IAF MLA* is to ensure that the personnel certifications granted by signatories of the *IAF MLA* can be recognized by other signatories, increasing the worldwide employability of the certified professionals. Mutual recognition is based on peer evaluations between signatories to ensure each other's personnel certifications are equivalent and that each certified professional can perform the required tasks. Once an accreditation body is a signatory of the *IAF MLA* it is required to recognize the certificates issued by conformity assessment bodies accredited by all other signatories of the *IAF MLA*, with the appropriate scope. Accreditations granted by *IAF MLA* signatories are recognized worldwide based on their equivalent accreditation programs, therefore reducing costs and adding value to business and consumers. Accreditation body members of *IAF* are admitted to the *MLA* only after stringent evaluation of their operations by a peer evaluation team. For a complete list of *IAF* members and signatories visit: http://www.iaf.nu/articles/IAF_MEM_USA_all/112.

IECI—International Electrotechnical Commission.

Indirect-Circulation System—a *closed loop* solar water heating system which prohibits contact between the *heat transfer fluid* and the potable water by the use of a heat exchanger to transfer the collected heat from the heat transfer fluid to the potable water.

ISO—International Organization for Standardization.

ISO/IEC Guide 65—a document that specifies requirements for bodies that operate third-party certifications of products to ensure that those bodies conduct their certification processes in an impartial, reliable, and consistent manner. Conformity to these standards provides assurance that a certification program is of high quality, integrity, and competency, and that it is free of any conflicts of interest, such as financial, commercial, or social influences.

Listed—equipment or materials included in a list published by an approved nationally recognized testing

laboratory, inspection agency or other organization concerned with product evaluation that maintains periodic inspection of production of listed equipment or materials, and whose listing states either that the equipment or material meets nationally recognized standards or has been tested and found suitable for use in a specified manner. The means for identifying listed equipment may vary for each testing laboratory, inspection agency, or other organization concerned with product evaluation, some of which do not recognize equipment as listed unless it is also labeled. The plumbing official should utilize the system employed by the listing organization to identify a listed product.

MLA—Multilateral Recognition Arrangement, to ensure mutual recognition of accredited certification between signatories to the *MLA*, and subsequently acceptance of accredited certification in many markets based on one accreditation.

Potable Water—water having bacteriological, physical, radiological and chemical qualities that make it safe and suitable for *human consumption*.

Potable Water Supply—a publicly owned or privately owned water supply system which purveys *potable water*.

Readily Accessible—having direct access without the need of removing any panel, door or similar covering of the item described and without requiring the use of portable ladders, chairs, etc.

Solar Collector—a device designed to absorb radiation from the sun and transfer this energy to a fluid which passes through the collector.

Solar Water Heating System—any unit or package of components designed to collect, convey, store, and convert the sun's energy for the purpose of heating *potable water*

SRCC—Solar Rating and Certification Corporation

Toxic—a substance that causes injury, illness, or death, especially by chemical means.

C. General. The following general requirements shall be applicable to solar water heating systems.

1. Certification. Solar water heating systems shall be certified to the Solar Rating and Certification Corporation's (SRCC) OG-300 document, 2010 edition (Operating Guidelines and Minimum Standards for Certifying Solar Water Heating Systems) by the SRCC themselves or by listing agencies [such as the International Association of Plumbing and Mechanical Officials (IAPMO)] which are currently accredited as meeting the ISO/IEC Guide 65 by the American National Standards Institute (ANSI) or other IAF MLA signatory accreditation bodies.

2. Installation. Solar water heating systems and appurtenances shall comply with the requirements of this Section, other applicable provisions of this code, and any other applicable requirements of the codes adopted under the authority of Act 12 of the 2005 First Extraordinary Session. All parts of a solar water heating system involving plumbing shall be installed by individuals holding a valid plumber's

license issued by the State Plumbing Board of Louisiana (SPBLA), subject to any exceptions thereto as may be authorized under the SPBLA's law and regulations.

a. Solar water heating systems shall be installed in a manner conforming to this Section, other applicable provisions of this code, applicable standards, and the manufacturers' installation instructions. In instances where this Section, other applicable provisions of this code, applicable standards, or the manufacturers' instructions conflict, the more stringent provisions shall prevail.

3. Maintenance. Solar water heating systems shall be maintained in proper safe and sanitary operating condition, and the owner shall be responsible for maintenance.

a. Access for maintenance and repair shall be provided to solar water heating system equipment, components, valves, etc. Solar water heating equipment and appurtenances shall not obstruct or interfere with the operation of any doors, windows, or other building components requiring operation or access.

4. Safety. Any solar water heating system capable of providing hot water in excess of 140⁰ F (60°C) shall be equipped with a listed tempering valve or temperature-limiting device to limit the temperature of water delivered to the domestic hot water system to a maximum of 140⁰ F (60°C).

a. Solar water heating equipment that could generate a glow, spark, or flame capable of igniting flammable vapors may be installed in a residential garage provided the pilots and burners, heating elements, motors, controllers, or switches are at least 18 inches (457 mm) above the floor level.

D. Solar Water Heating System Design Criteria. Solar water heating system design criteria shall be as follows.

1. Overall System Design. All solar water heating systems shall be of the closed loop type, utilizing an indirect circulation system. Direct circulation systems are prohibited.

a. Solar water heating systems shall have flow directions indicated on system components and piping or shall have flow directions indicated on a diagrammatic representation of the system as installed, permanently affixed to the system hardware in a readily accessible and visible location.

b. The solar water heating system shall be valved to provide for shut-off from the service water supply without interrupting normal cold water service to the residence (see §509.A of this code and apply).

2. Freeze Protection. Solar water heating system components shall be protected from damage resulting by freezing of heat transfer liquids at the lowest ambient temperatures that will be encountered during the operation of the system.

a. Solar water heating systems, where the design requires piping to be drained to protect the system from freezing, or where the heat transfer fluid must be replaced as

part of regular maintenance, shall have all piping pitched toward a designated point in the system to accomplish the intended purpose.

3. Temperature and Pressure. Solar water heating system components (i.e., solar collector, storage tank, heat exchanger, piping) containing pressurized fluids shall be protected against pressures and temperatures exceeding design limitations with a properly installed temperature and pressure (T and P) relief valve. Each section of the system in which excessive temperatures and pressures are capable of developing shall have a T and P relief valve located so that a section cannot be valved off or otherwise isolated from protection by a properly installed a T and P relief valve.

a. Relief valves and its discharge piping and appurtenances shall meet the requirements listed in §§511.E through 511.H.5 of this code.

b. Vacuum relief valves shall be installed at the high point of the solar system for drain back systems unless specifically not required by the system design.

4. Thermal Contraction and Expansion. The solar water heating system design, components and subassemblies shall include adequate provisions for the thermal contraction and expansion of heat transfer fluids and system components that will occur over the design temperature range.

a. Provisions for thermal contraction and expansion within the potable water system shall be installed in accordance with the requirements of §623.D of this code, as it relates to the water being heated for consumer use.

5. Solar Collectors. Collectors that are manufactured as a complete component shall be listed by a recognized third party listing agency. Collectors shall be listed and labeled to show the manufacturer's name, model number, serial number, collector weight, collector maximum allowable temperatures and pressures, and the type of heat transfer fluids that are compatible with the collector. The label shall clarify that these specifications apply only to the collector.

a. Valves shall be installed to allow the solar collectors to be isolated from the remainder of the solar water heating system. Each isolation valve shall be labeled with the open and closed position.

b. Collectors shall be anchored to roof structures or other surfaces in a manner to resist wind, snow, or seismic loadings in compliance with the applicable(s) codes adopted under the authority of Act 12 of the 2005 First Extraordinary Session. Anchors secured to and through a roofing material shall be made in a manner to maintain the water integrity of the roof covering. Roof drainage shall not be impaired by the installation of collectors. Collector panels that are not an integral part of the roofing system shall be installed in a manner so as to preserve the integrity of the roof surface.

6. Heat Exchangers. Heat exchangers used for potable water heating shall protect the potable water system from being contaminated by the heat transfer fluid.

a. Heat exchangers that are of double-walled construction shall be utilized that separate the potable water from the heat transfer fluid by providing a space between the two walls that is vented to the atmosphere. The heat exchanger design shall be such that any failure of a barrier material shall allow the discharge of exchanger fluid and/or potable water to the atmosphere. The discharge location shall be visible to the operator or owner of the system and be located so that no hazards are created by such discharge.

b. Single-walled heat exchangers are prohibited.

7. Heat Transfer Fluid. Heat transfer fluid shall be compatible with all materials in the system. The flash point of the actual heat transfer fluid utilized in a solar water heating system shall be not less than 50°F (10°C) above the design maximum stagnation (no-flow) temperature of the fluid attained in the collector.

a. Only non-toxic fluids shall be utilized as the heat transfer fluid, including additives, such as anti-freeze agents, conditioners, or corrosion inhibitors.

8. Storage or Heat Exchanger Tank Construction. All tanks shall be tested and listed by an approved agency. Pressurized thermal storage units shall be listed and labeled to show the manufacturer's name, model number, serial number, storage unit maximum and minimum allowable operating temperatures and pressures, and the type of heat transfer fluids that are compatible with the storage unit. The label shall clarify that these specifications apply only to the thermal storage unit.

a. Tank covers shall be structurally designed to withstand all anticipated loads and pressures.

b. All devices attached to or within the tank shall be accessible for repair and replacement.

9. Auxiliary Heating System. Auxiliary water heating equipment shall be provided such that the combined system (i.e., solar water heating system and the auxiliary water heating equipment) will provide the same degree of reliability and performance as a conventional water heating system.

a. Auxiliary (non-solar) water heating equipment shall be compatible with the solar system heat output, temperatures, flow rates and fluid types. Auxiliary water heating equipment shall be listed and labeled by a recognized third party listing agency.

b. The piping system shall be provided with valves which can be closed for the purpose of isolating the solar hot water heating system from the auxiliary water heater, thereby permitting operation of the auxiliary water heating system when the solar water heating system is inoperative or being serviced.

c. Auxiliary water heaters shall meet all applicable requirements set forth in this Chapter.

E. Potable Water Supply. The potable water supply shall be protected from an actual or potential cross connection to any nonpotable water piping by having any nonpotable

water piping (e.g., heat transfer fluid piping) color coded/identified in accordance with §607 of this code.

F. Materials. Subject to any additionally limitations below, all plumbing used in the solar water heating system including, but not limited to the collector loop, shall consist of the water distribution pipe, tubing and fittings materials specified in §619 of this code. Such materials shall comply with the standards listed in Table 603 of this code.

1. All hard-drawn copper tubing, in addition to the required incised marking, shall be marked in accordance with Sections 19.3.1 and 19.3.2 of ASTM B88-99 *Standard Specification for Seamless Copper Water Tube*. The colors shall be: Type K, green; Type L, blue. (Please note that Type M is not approved for plumbing uses in Louisiana).

2. Cast-iron fittings up to and including 2 inches in size, when used in connection with piping, shall be galvanized.

3. All malleable iron fittings shall be galvanized.

4. Flexible corrugated water heater connectors of copper or stainless steel shall be limited to 24 inches in length.

5. PEX tubing shall not be installed within the first 18 inches of piping connected to a water heater.

6. In no case shall plastic pipe including, but not limited to chlorinated polyvinyl chloride (CPVC) pipe and fittings, be used in a collector loop.

7. The piping of the collector loop shall be insulated to a minimum R-value of 2.6.

G. Testing. Testing of solar water heating systems and its components shall be performed in accordance with the following.

1. Closed Loop System. Closed loop or other type pressure systems shall be tested at one and one-half times maximum designed operating pressure. All systems shall withstand the test without leaking for a period of not less than 15 minutes.

2. Storage Tanks. Storage tanks associated with solar water heating systems shall be tested in accordance with the following.

a. Pressure type storage tanks shall be tested as prescribed in §513.G.1 of this code above.

b. Non-pressure type storage tanks shall be tested by filling it with water for a period of 24 hours prior to inspection and shall withstand the test without leaking. No tank or portion thereof shall be covered or concealed prior to approval.

H. Abandonment. Every abandoned solar water heating system or part thereof shall be physically disconnected from any remaining part of the plumbing system, drained, and plugged or capped in an approved manner.

AUTHORITY NOTE: Promulgated in accordance with R.S. 40:4(A)(7) and R.S. 40:5(2)(3)(7)(9)(16)(17)(20).

HISTORICAL NOTE: Promulgated by the Department of Health and Hospitals, Office of Public Health, LR 38:2829 (November 2012).

Chapter 6. Water Supply and Distribution

§601. General

A. Scope. The provisions of this Chapter shall govern the materials, design, construction, and installation of water supply and distribution systems.

B. Disinfection of Potable Water System. The plumbing official may require that a potable water system or any part thereof installed or repaired be disinfected in accordance with one of the following methods before it is placed in operation.

1. The system, or part thereof, shall be filled with a solution containing 50 ppm of available chlorine and allowed to stand 6 hours before flushing and returning to service.

2. The system, or part thereof, shall be filled with a solution containing 100 ppm of available chlorine and allowed to stand 2 hours before flushing and returning to service.

3. In the case of a potable water storage tank where it is not possible to disinfect as provided in Paragraph 1 or 2 of §601.B of this code above, the entire interior of the tank shall be swabbed with a solution containing 200 ppm of available chlorine and the solution allowed to stand 2 hours before flushing and returning to service.

4. In the case of potable water filters or similar devices, the dosage shall be determined by the plumbing official.

C. Allowance for Character of Water/Prohibition on the use of Used Piping. The material selected for water supply pipe, tubing, and fittings shall comply with the following.

1. Selection of Materials. When selecting the material and size for water supply pipe, tubing, or fittings, due consideration shall be given to the action of the water on the interior and of the soil, fill or other material on the exterior of the pipe. No material that would produce toxic conditions in a potable water distribution system shall be used for piping, tubing or fittings. Black iron pipe and fittings are prohibited in the water supply, service and distribution system.

2. Used Piping. A piping material that has been used for other than a potable water distribution system shall not be reused in the potable water distribution system.

D. Hot Water Distribution. The hot water supply to any fixture requiring hot water shall be installed on the left side of the fixture unless otherwise specified by the manufacturer.

E. Tests. The water supply and distribution system shall be tested in accordance with §319.C of this code.

F. Water Supply Mandatory. Every building used for human occupancy or habitation in which plumbing fixtures are installed shall be provided with an ample supply of potable water.

AUTHORITY NOTE: Promulgated in accordance with R.S. 40:4(A)(7) and R.S. 40:5(2)(3)(7)(9)(16)(17)(20).

HISTORICAL NOTE: Promulgated by the Department of Health and Hospitals, Office of Public Health, LR 38:2832 (November 2012).

§603. Materials

A. Water service pipe and fittings shall be of materials specified in 613. Water distribution pipe, tubing and fittings shall be of materials specified in §619 of this code. Materials shall comply with the standards listed in the following Table 603.

Table 603 Water Pipe and Fitting Materials	
Materials	Standards
Plastic Water Pipe and Fittings	
ABS and PVC Plastic Tubular Fittings	NSF 24
Chlorinated Poly(vinyl chloride) (CPVC) Plastic Pipe Fittings, Socket-Type Schedule 40	ASTM F 438
Chlorinated Poly(vinyl chloride) (CPVC) Plastic Pipe Fittings, Schedule 80, 2" and Under	ASTM F 439, Listed
Chlorinated Poly (Vinyl Chloride) (CPVC) Plastic Pipe, Schedule 80, 2" and Under	ASTM F 441/F 441M, Listed
Chlorinated Poly (Vinyl Chloride) (CPVC) Plastic Pipe (SDR-PR)	ASTM F 442/F 442M
Chlorinated Poly (Vinyl Chloride) (CPVC) Plastic Hot and Cold Water Distribution Systems	ASTM D 2846/D 2846M, Listed
Cold-Expansion Fittings With Metal Compression-Sleeves for Cross-Linked Polyethylene (PEX) Pipe	ASTM F 2080
Cold Expansion Fittings with PEX Reinforcing Rings for Use with Cross-Linked Polyethylene (PEX) Tubing	ASTM F 1960
Cross-Linked Polyethylene/Aluminum/Cross-Linked Polyethylene (PEX-AL-PEX) Pressure Pipe and Fittings	ASTM F 1281
Cross-Linked Polyethylene (PEX) Plastic Hot-and Cold-Water Distribution System	ASTM F 877, Listed
Cross-Linked Polyethylene (PEX) Tubing	ASTM F 876
Cross-Linked Polyethylene (PEX) Tubing Systems for Pressure	CAN/CSA B 137.5, Listed
Flexible Elastomeric Pressure Joints	ASTM D 3139, See §313.H.1 of this code
Joints for IPS PVC Pipe Using Solvent Cement	ASTM D 2672
Metal Insert Fittings Utilizing a Copper Crimp Ring for SDR9 Cross-linked Polyethylene (PEX) Tubing	ASTM F 180
Plastic Insert Fittings Utilizing a Copper Crimp Ring for SDR9 Cross-linked Polyethylene (PEX) Tubing	ASTM F 2159
Polyethylene/Aluminum/Polyethylene (PE-AL-PE) Composite Pressure Pipe and Fittings	ASTM F 1282
Polyethylene Plastic Pipe & Tubing (PE) Number 2305, 2306, 3306, 3406, 3408, 3608, 4710	ASTM D 2239, ASTM D 2737, Listed, See §303.H.1 of this code
Poly (Vinyl Chloride) (PVC) Plastic Pipe Fittings, Schedule 40	ASTM D 2466
Pressure Rated ABS-Plastic Pipe Number 1210, 2112, 1316	ASTM D 1527, Listed, See §303.H.1 of this code

Table 603 Water Pipe and Fitting Materials	
Materials	Standards
Pressure-rated Polypropylene (PP) Piping Systems	ASTM F 2389
Push Fit Fittings (for use on PEX tubing complying with ASTM F 876 or F877, type K and L hard drawn and annealed copper tubing complying with ASTM B 88 and CPVC tubing complying with ASTM D 2846)	ASSE 1061
PVC Injection Molded Gasketed Fittings for Pressure Applications	CAN/CSA-B137.2, Listed
PVC Plastic Pipe, Number 1120, 1220	ASTM D 1785, ASTM D 2241, Listed, See §303.H.1 of this code
PVC Plastic Pipe Fittings, Schedule 80	ASTM D 2467, Listed
PVC Plastic Pipe Fittings, 4 in. through 12 in.	AWWA C 900
Stainless Steel Clamps for Securing SDR9 Cross-linked Polyethylene (PEX) Tubing to Metal Insert and Plastic Insert Fittings	ASTM F 2098
Threaded Chlorinated Poly (Vinyl Chloride) (CPVC) Plastic Pipe Fittings, Schedule 80, 2" and Under	ASTM F 437, Listed
Ferrous Water Pipe & Fittings	
Cast Iron Castings for Valves, Flanges, and Pipe Fittings	ASTM A 126
Cupola Malleable Iron Fittings	ASTM A 197/A 197M
Ductile-Iron Compact Fittings for Water Service	AWWA C153, ANSI A 21.53
Ductile-Iron Pressure Pipe	ASTM A 377
Ductile-Iron Water Pipe	AWWA C 151, ANSI A 21.51
Ductile-Iron Water Fittings	AWWA C110, ANSI A 21.10
Gray Iron Threaded Fittings, Classes 125 and 250	ASME B 16.4
Malleable Iron Threaded Fittings, Classes 150 and 300	ASME B 16.3
Pipe Nipples for Welded and Seamless Carbon Steel and Austenitic Stainless Steel	ASTM A 733
Steel Couplings, Threaded and Galvanized	ASTM A 865/A 865M
Stainless Steel-Seamless, Welded, and Heavily Cold Worked Austenitic Piping (Types 304/304L & 316/316L only)	ASTM A 312/A 312M
Stainless Steel Tubing for General Service (Types 304/304L & 316/316L only)	ASTM A 269, See §303.H.3 of this code
Stainless Steel-Welded, Un-Annealed Austenitic Tubular Products (Types 304/304L & 316/316L only)	ASTM A 778
Steel Pipe, Hot-Dipped, Zinc-Coated, Welded and Seamless	ASTM A 53/A 53M
Nonferrous Pipe & Fittings Cast Bronze Threaded Fittings, Class 125 and 250	ASME B 16.15
Cast Copper Alloy Solder-Joint Pressure Fittings	ASME B 16.18
Cast Copper Alloy Fittings for Flared Copper Tube	ASME B 16.26
Cast Copper Alloy Pipe Flanges	ASME B 16.24
Pipe Flanges & Flanged Fittings	ASME B 16.5
Pipe Nipples for Brass and Copper	ASTM B 687
Push Fit Fittings (for use on PEX tubing complying with ASTM F 876 or F877, type K and L hard drawn and annealed copper tubing complying with ASTM B 88 and CPVC tubing complying with ASTM D 2846)	ASSE 1061

Table 603 Water Pipe and Fitting Materials	
Materials	Standards
Seamless Brass Tube	ASTM B 135/B 135M
Seamless Copper Pipe	ASTM B 42
Seamless Copper Tube	ASTM B 75
Seamless Copper Water Tube (Types K & L only)	ASTM B 88
Seamless Red Brass Pipe	ASTM B 43
Threadless Copper Pipe (TP)	ASTM B 302
Welded Brass Tube	ASTM B 587
Welded Copper Tube	ASTM B 447
Wrought-Copper and Copper Alloy Solder-Joint Pressure Fittings	ASME B 16.22, For Copper Water Tube
Wrought Seamless Copper and Copper-Alloy Tube	ASTM B 251
Valves-Flanged Threaded, and Welding End	ASME B 16.34

AUTHORITY NOTE: Promulgated in accordance with R.S. 40:4(A)(7) and R.S. 40:5(2)(3)(7)(9)(16)(17)(20).

HISTORICAL NOTE: Promulgated by the Department of Health and Hospitals, Office of Public Health, LR 38:2833 (November 2012).

§605. Quality of Water Supply

A. Potable Water. Potable water shall be used for drinking, culinary, and domestic purposes.

B. Acceptable Sources. Where a public supply of potable water is not available, requirements satisfactory to the governing authority shall be observed.

C. Nonpotable Water. Nonpotable water shall not be supplied to any fixture customarily classified a plumbing fixture and may only be used to supply industrial equipment or other appliances which do not require a potable supply of water and provided such nonpotable water shall not be accessible for drinking, culinary or bathing purposes.

AUTHORITY NOTE: Promulgated in accordance with R.S. 40:4(A)(7) and R.S. 40:5(2)(3)(7)(9)(16)(17)(20).

HISTORICAL NOTE: Promulgated by the Department of Health and Hospitals, Office of Public Health, LR 38:2834 (November 2012).

§607. Identification of Nonpotable Water

A. Color Code Identification. Piping and outlets conveying nonpotable water shall be adequately and durably identified by a distinctive yellow-colored paint so that it is readily distinguished from piping carrying potable water.

1. Exception. Reclaimed Water. Where reclaimed water is piped or used, piping and outlets conveying this particular type of nonpotable water shall be adequately and durably identified by a distinctive purple-colored paint (or, in lieu of paint, the purple color may be manufactured integral to the pipe) so that it is readily distinguished from piping carrying potable water. The color standard and color tolerances of the required purple-color should meet the American Public Works Association's Uniform Color Code, i.e., Pantone Matching System 253, which is further specified in ANSI Z535.1-2006 (R2011) and identified in the ANSI Z535-2011 color chart.)

2. In those instances when it is not feasible to paint the entire length of the nonpotable water pipe, each nonpotable pipe shall be minimally identified with the words "caution: nonpotable water, - do not drink" in black lettering on a band of yellow-colored paint as background to designate that the liquid being conveyed therein is nonpotable. Such identification shall not be concealed by pipe insulation and when insulated the insulation shall be painted the same color as is required for the pipe. Maintenance of all identification shall be the responsibility of the owner. This identification shall be done in accordance with ASME A 13.1. The minimum size of the black letters and the length of the yellow-colored paint field shall conform to the requirements in Table 607.A.2 of this code.

Outside Diameter of Pipe or Covering (Inches)	Minimum Length of Color Field (Inches)	Minimum Size of Letters (Inches)
1/2 to 1 1/4	8	1/2
1 1/2 to 2	8	3/4
2 1/2 to 6	12	1 1/4
8 to 10	24	2 1/2
Over 10	32	3 1/2

3. Within and about buildings and structures, a visible colored identification band shall be provided every 20 feet (6096 mm) but at least once per room, and the wording shall be visible in the normal line of vision from floor level. On straight pipe runs, the visible identification band shall be at intervals sufficient for identification. Arrows shall be used to indicate the direction of normal flow.

4. It is expressly understood that fire protection piping systems, downstream of the backflow preventer, is not considered plumbing, as per the definition of plumbing in Section 203 of this code. Nothing herein shall be construed to prevent, for example, fire protection piping from being painted a red color with white lettering. Likewise, other color combinations may be used for other specific applications in accord with ASME A 13.1.

B. Contents Identification. Where any type of nonpotable water is used, all valves, branch fittings and branch terminals shall be minimally identified by the words "caution: nonpotable water, - do not drink" in black lettering on a yellow background. This identification shall be done in accordance with ASME A 13.1. Besides the caution statement, the contents (i.e., the specific nonpotable liquid) may also be identified on the legend.

C. Overall Exception to this Section (§607 of this code). Pursuant to R.S. 40:4.12, industrial-type facilities listed therein shall not be required to comply with this section (§607 of this code) provided that such facilities have a potable water distribution identification plan in conformity with the requirements of R.S. 40:4.12. The required formal cross-connection control survey of the facility referenced in R.S. 40:4.12 shall be performed by an individual holding a valid cross-connection control surveyor certificate issued under the requirements of ASSE 5120, or other individuals holding a surveyor certificate from a nationally recognized

backflow certification organization approved by the state health officer.

AUTHORITY NOTE: Promulgated in accordance with R.S. 30:2399, R.S. 40:4(A)(7) and R.S. 40:5(2)(3)(7)(9)(16)(17)(20).

HISTORICAL NOTE: Promulgated by the Department of Health and Hospitals, Office of Public Health, LR 38:2834 (November 2012).

§609. Protection of Potable Water Supply

A. Backflow and Back-Siphonage. The potable water supply including, but not limited to, the water supply system, the water service pipe, and the water distribution system shall be protected from backflow and back-siphonage in conformance with the following.

1. **Backflow.** The potable water supply including, but not limited to, the water supply system, the water service pipe, and the water distribution system shall be protected against backflow. Every water outlet shall be protected from backflow, preferably by having the outlet end from which the water flows spaced a distance above the flood-level rim of the receptacle into which the water flows sufficient to provide a "minimum required air gap (water distribution)" as defined in ASME A 112.1.2. Where it is not possible to provide a minimum air gap (water distribution), the water outlet shall be equipped with an accessible backflow preventer complying with §609.B of this code.

2. **Back-Siphonage.** Potable water supply piping, water discharge outlets, backflow prevention devices or similar equipment shall not be so located as to make possible their submergence in any contaminated or polluted liquid or substance.

B. Approval of Devices. Devices for the prevention of backflow or back-siphoning shall comply with the standards listed in Table 609 of this code below. Devices installed in a potable water supply for protection against backflow shall be maintained in good working condition by the person or persons having control of such devices. The plumbing official (or, for containment devices, the water supplier) may inspect such devices and, if they are found to be defective, inoperative, or the wrong application for the cross connection or potential cross connection involved, shall require the repair and/or replacement thereof. Any repair or replacement of a device shall require testing as required under §609.F.9.c of this code.

Materials	Standards
Air Gap Standards	ASME A112.1.2
Backflow Preventers for Beverage Dispensing Equipment	ASSE 1022
Backflow Preventers, Double Check Valve Assembly	ASSE 1015, AWWA C510
Backflow Preventers, Laboratory Faucet	ASSE 1035
Backflow Preventers with Intermediate Atmospheric Vent	ASSE 1012
Backflow Preventers, Double Check Detector Fire Protection Backflow Prevention Assemblies	ASSE 1048

Table 609 Backflow Prevention Devices	
Materials	Standards
Backflow Preventers, Hose Connection	ASSE 1052
Backflow Preventers, Reduced Pressure Detector Fire Protection Assemblies	ASSE 1047
Backflow Preventers, Reduced Pressure Principle Assembly	ASSE 1013, AWWA C511
Field Test Procedures for Backflow Preventer Assemblies	ASSE Series 5000
Manual for the Selection, Installation, Maintenance and Field Testing of Backflow Prevention Devices	CAN/CSA-B64.10
Vacuum Breakers, Anti-Siphon, Pressure Type Assembly (Outdoor Use)	ASSE 1020
Vacuum Breakers-Atmospheric Type	ASSE 1001
Vacuum Breakers (Spill Resistant)	ASSE 1056
Vacuum Breakers, Hose Connection	ASSE 1011
Vacuum Breaker Wall Hydrants, Freeze Resistant Automatic Draining	ASSE 1019
Water Closet Anti-Siphon Fill Valves (Ballcocks)	ASSE 1002

C. Where Required. The following are certain instances wherein backflow prevention devices are required. This list shall not be construed as all instances where a backflow prevention device is required.

1. Flushometer. Flushometer valves shall be equipped with an approved vacuum breaker. The vacuum breaker shall be installed on the discharge side of the flushing valve with the critical level at least 4 inches (102 mm) above the overflow rim of the bowl. Flushometer tanks shall be provided with an approved backflow prevention device installed above the flood-level rim of the fixture.

2. Flush Tanks. Flush tanks shall be equipped with an approved ballcock. The ballcock shall be installed with the critical level of the vacuum breaker at least 1-inch (25.4 mm) above the full opening of the overflow pipe. In cases where the ballcock has no hush tube, the bottom of the water supply inlet shall be installed at least 1-inch (25.4 mm) above the full opening of the overflow pipe. A sheathed ballcock shall be installed on all gravity flush tanks in which the flush valve seat is less than 1-inch (25.4 mm) above the flood-level rim of the bowl.

3. Lawn Sprinklers and Irrigation Piping System. Lawn sprinkler systems and irrigation piping systems shall be equipped with an approved backflow preventer to protect against contamination of the potable water system. The following devices shall be acceptable.

a. Anti-siphon vacuum breakers, reduced pressure zone backflow preventers, and pressure type vacuum breakers equipped with gate or ball valves and test cocks. See §609.F of this code for acceptable types based upon the application.

b. Atmospheric type vacuum breakers shall be installed downstream of the last control valve at least 6 inches (152 mm) above the highest point of usage (i.e., 6

inches (152 mm) above all downstream piping and the highest sprinkler head).

c. All protective devices shall be installed in an accessible location to allow for inspection and maintenance and to isolate the sprinkler system from all other piping in the system.

d. Pressure type vacuum breakers shall be installed at least 12 inches (305 mm) above the highest point of usage (i.e., 12 inches (305 mm) above all downstream piping and the highest sprinkler head).

4. Fixture Valve Outlets with Hose Attachments, Hose Bibbs and Lawn Hydrants. Fixture valve outlets with hose attachments, hose bibbs, and lawn hydrants shall comply with the following.

a. Fixture valve outlets with hose attachments, hose bibbs and lawn hydrants shall be protected against backflow by an air gap (water distribution), a vacuum breaker or other approved back-siphonage backflow preventer on the discharge side of the valve. Back-siphonage backflow preventers may be installed directly on hose outlet connection threads. Vacuum breakers shall be installed at least 6 inches (152 mm) above the highest point of usage.

i. Exception. Water heater drains, boiler drains and washing machine connections shall not be required to be fitted with backflow prevention devices.

b. In areas subject to temperatures of 32°F (0°C) or below, all hose bibb vacuum breakers shall be of such design that the hydrant may be drained without removing the backflow preventer from the hydrant. Regardless of area temperature, hose bibb vacuum breakers shall be designed and installed to prevent total removal from the hose bibb after installation in accordance with the provisions of this code and the manufacturer's instructions.

5. Water Supply to Steam and Hot Water Heating Boilers, Heat Exchangers, Chilled Water Systems, etc. A backflow preventer device which will automatically vent to the atmosphere shall be installed in the water supply line to all steam and hot water space heating boilers, heat exchangers, chilled water systems and similar devices being supplied from the potable water system. Such devices shall prevent back-siphonage and backflow from the heating system into the potable supply lines should the supply pressure fall below the pressure in the heating system. Such devices shall meet the requirements of ASSE 1012 or 1013 and shall bear such identification as is required by the applicable standard. See §609.F of this code for acceptable types based upon the application.

6. Connections to automatic fire sprinkler systems shall be required to meet the minimum requirements as referenced in §609.F of this code.

7. Handheld Showers and Pull-out Spout Type Faucets. Handheld showers and pull-out spout type faucets with integral backflow protection shall comply with ASME A112.18.1, CSA B125.1, or ASME A112.18.3; or, in lieu

thereof, shall require a dedicated deck or wall mounted vacuum breaker.

8. **Portable Cleaning Equipment.** Where the portable cleaning equipment connects to the water distribution system, the water distribution system shall be protected against backflow with an air gap (water distribution), an atmospheric type vacuum breaker, a pressure type vacuum breaker or a reduced pressure principle backflow preventer. See §609.F of this code for acceptable types based upon the application.

9. **Chemical Dispensers.** Where chemical dispensers connect to the water distribution system, the water distribution system shall be protected against backflow with an air gap (water distribution), an atmospheric type vacuum breaker, a pressure type vacuum breaker or a reduced pressure principle backflow preventer. See §609.F of this code for acceptable types based upon the application.

10. **Dental Pump Equipment.** Where dental pumping equipment connects to the water distribution system, the water distribution system shall be protected against backflow with an air gap (water distribution), an atmospheric type vacuum breaker, a pressure type vacuum breaker or a reduced pressure principle backflow preventer. See §609.F of this code for acceptable types based upon the application.

D. **Backflow Preventer Installation.** Backflow preventers shall be installed in accord with the following.

1. **Reduced pressure zone (RPZ) type backflow preventers, and other types of backflow preventers with atmospheric ports and/or test cocks (e.g., atmospheric type vacuum breakers, double check valve assemblies, pressure type vacuum breaker assemblies, etc.), shall not be installed below grade_(G) (in vaults or pits) where the potential for a relief valve, an atmospheric port, or a test cock being submerged exists.**

a. **RPZ type backflow preventers and other types of backflow preventers having an atmospheric discharge port (e.g., backflow preventer with intermediate atmospheric vent) shall be installed such that the lowest point of the atmospheric discharge port's opening shall be a minimum of 12 inches above grade_(G) or platform. When RPZ type backflow preventers and other types of backflow preventers with an atmospheric discharge port (e.g., backflow preventer with intermediate atmospheric vent) are installed in flood-prone areas, the lowest point of the atmospheric discharge port's opening should be installed at least 2-feet above the highest flood level which may have occurred in 10-year period, but in no case less than 2-feet above grade_(G).**

b. **For the purpose of maintenance, double check valve assembly type backflow preventers shall be installed a minimum of 12 inches above grade_(G) or platform.**

2. **Pipe-applied atmospheric type vacuum breakers shall be installed not less than 6 inches (152 mm) above all downstream piping and not less than 6 inches (152 mm) above the flood-level rim of the fixture receptor or device served. Pipe-applied pressure type vacuum breakers shall be installed not less than 12 inches (305 mm) above all**

downstream piping and not less than 12 inches (305 mm) above the flood-level rim of the fixture receptor or device served. Approved deck-mounted vacuum breakers and vacuum breakers within equipment, machinery and fixtures, whether of the atmospheric or spill-proof pressure type, where the critical level is a fixed distance above the potential source of contamination, shall be installed not less than 1-inch (25.4 mm) above the flood-level rim of the fixture receptor device served or source of contamination.

3. **Access, Clearance, and Platform.** Backflow preventer assemblies shall be installed in an accessible location to provide for the required testing, maintenance and repair. A minimum of 1-foot of clearance shall be provided between the lowest portion of the assembly and grade_(G) or platform. Elevated installations exceeding 5-feet above grade_(G) shall be provided with a suitably located permanent platform capable of supporting the general tester, licensed plumber, or any other person authorized in accordance with §§609.F.8 and 609.F.9 of this code to test or repair the assembly.

E. **Reduced Pressure Zone Backflow Preventers.** Reduced pressure zone backflow applications subject to periodic no flow conditions should include a single soft seated spring loaded check valve located immediately upstream of the backflow prevention device to prevent periodic relief valve activation caused by fluctuating supply pressures.

F. **Additional Requirements to Protect the Potable Water Supply [formerly Appendix D - Cross Connection Control].** The following are additional, more specific requirements for the protection of the potable water supply including, but not limited to, the water supply system, the water service pipe, and the water distribution system. For other rules and regulations regarding potable water supply protection, see Part XII (Water Supplies) of the State Sanitary Code of Louisiana (LAC 51:XII).

1. **Purpose.** The purpose of this Subsection is to provide for the protection of the public from the possibility of contamination or pollution by isolating such contaminants or pollutants which could backflow or back-siphon into a potable water supply; to promote the elimination or control of existing cross-connections, actual or potential, between potable water supplies and non-potable systems/sources; and to promote the maintenance of a continuing program of cross-connection control in the State of Louisiana.

2. **Definitions.** Definitions contained in Chapter 2 shall also apply to this Subsection except where the following special definitions shall apply.

Air Gap (Water Distribution)—in a *water supply system* and/or a *water distribution system*, the unobstructed vertical distance through the free atmosphere between the lowest opening from any pipe or faucet supplying water to a tank, *plumbing fixture*, or other device and the *flood-level rim* of the receptacle.

Atmospheric Vacuum Breaker—a device which prevents *back-siphonage backflow* by creating an

atmospheric vent when there is either a negative pressure or sub-atmospheric pressure in a *water supply system* and/or *water distribution system*.

Backflow—the flow of water or other liquids, mixtures, or substances into the distribution pipes of a potable *water supply system* and/or *water distribution system* from any source other than its intended source. See *Back-Pressure Backflow* and *Back-Siphonage Backflow*.

Back-Pressure Backflow—a condition which occurs when the downstream pressure is higher than the supply pressure causing a reversal of the normal direction of flow.

Backflow Preventer—a mechanical device which prevents *backflow* of contaminants and pollutants into a potable water supply or distribution system by means of positive check members in addition to atmospheric ports.

Backflow Prevention Assembly—a testable *backflow preventer* which comes assembled from the manufacturer as a complete unit having approved test cocks with shut off valves installed on both the inlet and outlet sides of the *backflow preventer*.

Backflow Prevention Device—a non-testable backflow preventer.

Back-Siphonage Backflow—a reversal of the normal direction of flow in the pipeline due to a negative pressure (vacuum) being created in the supply line with the *backflow* source subject to atmospheric pressure.

Barometric Loop—a fabricated piping arrangement rising at least 35 feet at its topmost point above the highest *fixture* it supplies. It is utilized in water supply and distribution systems to protect against *back-siphonage backflow*.

By-Pass—any system of piping or other arrangement whereby the water may be diverted around any part or portion of a *water supply system*, *water distribution system* or water treatment facility including, but not limited to, around an installed *backflow preventer*.

Commercial Dishwasher—a mechanical dishwasher that is used in other than domestic applications.

Containment—a method of *backflow* prevention which requires a *backflow* prevention device or method on the *water service pipe* to isolate the customer from the *water main*.

Contamination—the introduction into water of microorganisms, chemicals, toxic substances, wastes or wastewater that makes the water unfit for its intended use.

Cross Connection—any connection or arrangement by means of which contaminants of any kind can be caused to enter the potable *water supply system* or *water distribution system*.

Degree of Hazard—an evaluation of the potential risk to public health if the public were to be exposed to contaminated water caused by an unprotected or inadequately protected cross connection.

Double Check Valve Assembly—an assembly of 2 independently operating spring loaded check valves, with tightly closing shut off valves on each side of the check valves, plus properly located test cocks for the testing of each check valve.

Double Check Valve with Intermediate Atmospheric Vent—a device having two spring loaded check valves separated by an atmospheric vent chamber.

Dual Check Valve—two spring loaded, independently operating check valves without tightly closing shut-off valves and test cocks. Generally employed immediately downstream of the water meter. Not an approved backflow prevention device.

Fixture Isolation—a method of backflow prevention in which a *backflow preventer* is located to correct a *cross-connection* at a fixture located within the premise itself [rather than locating a *backflow preventer* on the *water service pipe* (as is done under *containment*)].

Hose Bibb Vacuum Breaker—a device which is permanently attached to a hose bibb and which acts as an *atmospheric vacuum breaker*.

Human Consumption—the use of water by humans for drinking, cooking, bathing, showering, hand washing, dishwashing, or maintaining oral hygiene.

Master Meter—a water meter serving multiple residential dwelling units or multiple commercial units. Individual units may or may not be sub-metered.

Potable Water—water having bacteriological, physical, radiological and chemical qualities that make it safe and suitable for human consumption.

Potable Water Supply—a publicly owned or privately owned *water supply system* which purveys *potable water*.

Pressure Vacuum Breaker—a device containing one or two independently operated spring loaded check valves and an independently operated spring loaded air inlet valve located on the discharge side of the check or checks. The device includes tightly closing shut-off valves on each side of the check valves and properly located test cocks for the testing of the check valve(s).

Public Water System—a particular type of *water supply system* intended to provide *potable water* to the public having at least fifteen *service connections* or regularly serving an average of at least twenty-five individuals daily at least sixty days out of the year.

Reduced Pressure Principle Backflow Preventer—an assembly consisting of two independently operating approved check valves with an automatically operating differential relief valve located between the two check valves, tightly closing shut-off valves on each side of the check valves plus properly located test cocks for the testing of the check valves and relief valve.

Service Connection—water service pipe.

Water Service Pipe—the pipe from the *water main* and/or water meter, *water supply system* or other approved source of water supply, to the building or structure served.

Water Supplier—a person who owns or operates a *water supply system* including, but not limited to, a person who owns or operates a *public water system*.

Water Supply System—the system of pipes or other constructed conveyances, structures and facilities through which water is obtained, treated to make it *potable* (if necessary) and then distributed (with or without charge) for human consumption or other use.

3. **Air Gaps (Water Distribution).** The provision of air gaps (water distribution) shall be required for backflow prevention in any and all cases where such a measure is the most practical that can be employed. The "minimum required air gap (water distribution)" shall be in accord with ASME A 112.1.2.¹

¹For informational purposes only, ASME A 112.1.2 generally requires a minimum required air gap equal to two times the effective opening (or 3 times the effective opening if affected by a nearby wall). Compliance shall be strictly determined by the provisions contained within the standard itself.

4. **Responsibility of Water Suppliers.** As required by LAC 51:XII.344, each water supplier shall protect the water produced and distributed by its water supply system from potential contamination by ensuring compliance with the containment practices and maintenance/field testing requirements prescribed by this Part or as otherwise directed by the state health officer.

5. **Containment Practices.** Backflow prevention methods or devices shall be utilized as directed by the water supplier or plumbing official to isolate specific water supply system customers from the water supply system's mains when such action is deemed necessary to protect the water supply system against potential contamination caused by backflow of water from that part of the water system owned and maintained by the customer (e.g., the piping downstream of the water meter, if provided).

a. As a minimum, the following types of backflow prevention assemblies or methods shall be installed and maintained by water supply system customers immediately downstream of the water meter (if provided) or on the water service pipe prior to any branch line or connections serving the listed customer types and categories.

Table 609.F.5 (Containment)	
Air Gap	
1. Fire Protection/Sprinkler System utilizing non-potable water as an alternative or primary source of water	
Reduced Pressure Principle Backflow Prevention Assembly	
1. Hospitals, Out-Patient Surgical Facilities, Renal Dialysis Facilities, Veterinary Clinics	
2. Funeral Homes, Mortuaries	
3. Car Wash Systems	
4. Sewage Facilities	
5. Chemical or Petroleum Processing Plants	
6. Animal/Poultry Feedlots or Brooding Facilities	
7. Meat Processing Plants	
8. Metal Plating Plants	

Table 609.F.5 (Containment)	
9. Food Processing Plants, Beverage Processing Plants	
10. Fire Protection/Sprinkler Systems using antifreeze in such system (a detector type assembly is recommended on unmetered fire lines)	
11. Irrigation/Lawn Sprinkler Systems with Fertilizer Injection	
12. Marinas/Docks	
13. Radiator Shops	
14. Commercial Pesticide/Herbicide Application	
15. Photo/X-ray/Film Processing Laboratories	
16. Multiple Commercial Units served by a master meter	
17. Any type of occupancy type or any other facility having one or more Single-walled Heat Exchangers which uses any chemical, additive, or corrosion inhibitor, etc., in the heating or cooling medium	
18. Any type of occupancy type or any other facility having one or more Double-walled Heat Exchangers which use any chemical, additive, or corrosion inhibitor, etc., in the heating or cooling medium and which does not have a path to atmosphere with a readily visible discharge	
19. Premises where access/entry is prohibited	
Pressure Vacuum Breaker Assembly/ Spill Resistant Vacuum Breaker Assembly	
1. Irrigation/Lawn Sprinkler Systems	
Double Check Valve Assembly	
1. Fire Protection/Sprinkler Systems (a detector type double check valve assembly is recommended on unmetered fire lines)	
2. Two residential dwelling units served by a master meter, unless both units are located on a parcel or contiguous parcels of land having the same ownership and neither unit is used for commercial purposes. As used herein, the term "commercial purposes" means any use other than residential.	
3. Three or more residential dwelling units served by a master meter	
4. Multistoried Office/Commercial Buildings (over 3 floors)	
5. Jails, Prisons, and Other Places of Detention or Incarceration	

b. Other Containment Practices - Table 609.F.5 of this code above is not inclusive of all potential contamination sources which may need containment protection. For potential contamination sources not listed in this table, backflow prevention methods or devices shall be utilized in accordance with Table B1 of CAN/CSA B64.10-1994. When a potential contamination source and its associated backflow prevention method or device is not identified in Table 609.F.5 of this code above or Table B1 of CAN/CSA B64.10-1994, backflow prevention methods or devices shall be utilized:

- i. as directed by the plumbing official; or
- ii. as directed by the water supplier.

c. In cases of a discrepancy regarding the particular backflow prevention assembly or method required, the assembly or method providing the higher level of protection shall be required.

6. **Fixture Isolation Practices.** Water supply system customers shall provide and maintain backflow prevention methods or devices as directed by the plumbing official within that part of the water system owned and maintained by the customer (e.g., the piping downstream of the water meter, if provided, or downstream from any containment device) to protect the on-site users of the water system against potential contamination due to backflow.

a. As a minimum, the following types of backflow prevention devices, assemblies or methods shall be employed as appropriate for the following points of usage.

Table 609.F.6¹ (Fixture Isolation)	
Air Gap	
1.	Cooling Towers
2.	Chemical Tanks.
3.	Commercial Dishwashers in commercial establishments
4.	Ornamental Fountains
5.	Swimming Pools, Spas, Hot Tubs (reduced pressure principle backflow preventer also acceptable)
6.	Baptismal Fonts
7.	Animal Watering Troughs
8.	Agricultural Chemical Mixing Tanks
9.	Water Hauling Tanks
Reduced Pressure Principle Backflow Preventers	
1.	Commercial Boilers
2.	Air Conditioning, Chilled Water Systems
3.	Air Conditioning, Condenser Water Systems
4.	Pot-type Chemical Feeders
5.	Swimming Pools, Spas, Hot Tubs (air gap also acceptable)
6.	Irrigation/Lawn Sprinkler Systems with Fertilizer Injection
7.	Photo/X-ray/Film Processing Equipment
8.	Single-walled Heat Exchangers which use any chemical, additive, or corrosion inhibitor, etc., in the heating or cooling medium
9.	Double-walled Heat Exchangers which use any chemical, additive, or corrosion inhibitor, etc., in the heating or cooling medium and which does not have a path to atmosphere with a readily visible discharge
10.	Room(s) or other sub-units of a premise or facility receiving water where access is prohibited
Double Check Valve Assembly	
1.	Food Processing Steam Kettles
2.	Individual Travel Trailer Sites
3.	Single-walled Heat Exchangers which do not use any chemical, additive, or corrosion inhibitor, etc., in the heating or cooling medium
4.	Double-walled Heat Exchangers which do not use any chemical, additive, or corrosion inhibitor, etc., in the heating or cooling medium and which does not have a path to atmosphere with a readily visible discharge
Atmospheric or Pressure Vacuum Breakers	
1.	Laboratory and/or Medical Aspirators
2.	Flushing Rim Bedpan Washers
3.	Garbage Can Washers
4.	Laboratory or Other Sinks with threaded or serrated nozzles
5.	Flushometer Operated Fixtures
6.	Commercial Washing Machines
7.	Irrigation/Lawn Sprinkler Systems
8.	Hose Bibbs
9.	Commercial Dishwashers in commercial establishments
Pressure Vacuum Breakers/Spill Resistant Vacuum Breakers	
1.	Mortuary/Embalming Aspirators
2.	Irrigation/Lawn Sprinkler Systems with Separate Zones

NOTES:

¹See Tables 1307.E and 1307.F of this code for fixture isolation practices in hospital plumbing systems.

b. Other Fixture Isolation Practices - Table 609.F.6 of this code above is not inclusive of all potential contamination sources which may need fixture isolation protection. For potential contamination sources not listed in this table, backflow prevention methods or devices shall be utilized in accordance with Table B1 of CAN/CSA B64.10-1994.

c. When a potential contamination source and its associated backflow prevention method or device is not identified in Table 609.F.6 of this code above or Table B1 of CAN/CSA B64.10-1994, backflow prevention methods or devices shall be utilized as directed by the plumbing official.

d. In cases of a discrepancy regarding the particular backflow prevention device or method required, the device offering the higher level of protection shall be installed. In contested cases, the co-state plumbing official (i.e., the state health officer) shall be consulted to issue a ruling on the particular backflow prevention device or method required, if any.

7. Bypasses. All bypasses shall have the same level of backflow protection as the main water supply line.

8. Installation/Repair. Backflow preventers shall be installed and/or repaired by a State Plumbing Board of Louisiana (SPBLA)-licensed plumber who holds a SPBLA water supply protection specialist endorsement on his/her plumbing license pursuant to LSA - R.S. 37:1361 et seq. and its implementing regulations (LAC 46:LV.101 et seq.); or, for those backflow preventers located on public property or otherwise under the complete control of the water supplier (e.g., water meter and the piping upstream of the water meter, if provided), by a Backflow Prevention Assembly Repairer who meets the ASSE 5130 Professional Qualification Standard or other individuals holding a backflow prevention assembly repairer certificate from a nationally recognized backflow certification organization approved by the state health officer. Backflow preventers associated with a landscape irrigation system may be installed, tested, and repaired by a Horticulture Commission of Louisiana-licensed landscape irrigation contractor who holds a SPBLA-issued special water supply protection specialist endorsement in accord with R.S. 3:3808.P.

9. Maintenance/Field Testing. Backflow prevention assemblies and methods shall be checked and field tested by a Backflow Prevention Assembly Tester who meets ASSE 5110 Professional Qualification Standard, or other individuals holding a testing certificate from a nationally recognized backflow certification organization approved by the state health officer. Testing procedures shall be in accord with the requirements of §319.F of this code.

a. Types of Backflow Preventers to be Field Tested. The following types of backflow prevention assemblies and methods shall be checked and field tested in accordance with the frequency established in §609.F.9.c of this code:

- i. double check valve assemblies;
- ii. reduced pressure principle backflow prevention assemblies;
- iii. pressure vacuum breakers;
- iv. spill resistant vacuum breakers;
- v. air gaps (water distribution) on high hazard applications; and,
- vi. other backflow prevention devices as specified by the plumbing official or water supplier.

NOTE: It is recommended that other types of backflow prevention devices not listed here be visually checked periodically.

b. Any backflow preventer in §609.F.9.a of this code which is found defective shall be repaired by an

individual meeting the qualifications specified in §609.F.8 of this code.

c. Frequency of Field Testing. The backflow prevention assemblies and methods specified in §609.F.9.a of this code shall be field tested:

- i. upon installation;
- ii. when cleaned, repaired, or overhauled;
- iii. when relocated;
- iv. annually;
- v. as required by the plumbing official; and,

vi. as required by the water supplier for assemblies or methods providing containment protection for their water supply system.

d. Owner Responsibilities. The owner of the backflow prevention assemblies shall comply with the following:

i. It shall be the duty of the owner of the backflow prevention assembly to see that these tests are made in a timely manner in accord with the frequency of field testing specified in §609.F.9.c of this code and that devices which are found defective are repaired or replaced in accordance with §609.F.9.b of this code.

ii. The owner shall notify the plumbing official, and/or water supplier in advance when the tests are to be undertaken so that the plumbing official and/or water supplier may witness the tests if so desired.

iii. Upon completion, the owner of a containment assembly or method (see §609.F.5 of this code) shall provide records of such tests, repairs, overhauls, or replacements to the water supplier. Upon completion, the owner of a fixture isolation device, assembly, or method (see §609.F.6 of this code) shall provide records of such tests, repairs, overhauls, or replacements to the plumbing official. In addition, all records shall be kept by the owner of the backflow prevention device or method for at least five years and, upon specific request, shall be made available to the plumbing official, water supplier, and/or the state health officer.

iv. All tests, repairs, overhauls or replacements shall be at the expense of the owner of the backflow preventer.

AUTHORITY NOTE: Promulgated in accordance with R.S. 40:4(A)(7) and R.S. 40:5(2)(3)(7)(9)(16)(17)(20).

HISTORICAL NOTE: Promulgated by the Department of Health and Hospitals, Office of Public Health, LR 38:2835 (November 2012), amended LR 41:394 (February 2015).

§611. Sizing of Water Distribution System

A. Minimum Sizes. The sizing of the water distribution system shall conform to good engineering practice (e.g., see §1805, Appendix B of this code). See §611.C of this code for the minimum required size of fixture branches and individual manifold distribution lines. See §611.D of this code for the minimum required size of fixture supplies and

§611.E of this code for the minimum pressure required at fixture outlets.

B. Calculation of Sizes. When required by the plumbing official, the sizing of the water distribution system shall be calculated by a registered mechanical engineer or other acceptable authority.

C. Size of Fixture Branches and Manifold Individual Distribution Lines. The minimum size of fixture branches or manifold individual distribution lines shall be in accordance with the following Table 611.

Table 611 Minimum Size of Fixture Branches and Individual Manifold Distribution Lines		
Type of Fixture or Device	Fixture Branch Pipe Size (in.)	Individual Manifold Distribution Line Size (in.)
Bathtubs (60" x 32" and smaller)	1/2	1/2
Bathtubs (Larger than 60" x 32")	1/2	1/2
Combination Sink and Tray	1/2	1/2
Drinking Fountain	1/2	1/2
Dishwasher (Domestic)	1/2	1/2
Kitchen Sink, Residential	1/2	1/2
Kitchen Sink, Commercial	3/4	3/4
Lavatory	1/2	1/2
Laundry Tray 1, 2, or 3 Compartments	1/2	1/2 (1 Tray)
Wall Hydrants	1/2	1/2
Shower (Single Head)	1/2	1/2
Sinks (Service, Slop)	1/2	1/2
Sinks Flushing Rim	3/4	3/4
Urinal (Flush Tank)	1/2	1/2
Urinal (Direct Flush Valve)	3/4	3/4
Water Closet (Flushometer Valve Type)	1	1
Water Closet (Gravity or Flushometer Tank Type)	1/2	1/2
Hose Bibbs	1/2	1/2

1. For fixtures not listed in Table 611 of this code above, the minimum fixture branch or manifold individual distribution line may be made the same as for a comparable fixture.

D. Size of Fixture Supply. The fixture supply piping, tubing, or flexible connector shall be sized in accordance with the fixture manufacturer's recommendations but in no case shall the size interfere with the minimum fixture outlet discharge pressure requirements specified in §611.E of this code.

E. Minimum Pressure. Minimum fairly constant service pressure at the point of outlet discharge shall be not less than 8 psi (55.2 kPa) flowing for all fixtures except for direct flush valves, for which it shall be not less than 15 psi (103 kPa) flowing, and except where special equipment is used requiring higher pressure. In determining the minimum pressure, allowance shall be made for the pressure drop due to friction loss in the piping system during maximum demand periods as well as head, meter, and other losses in the system.

F. Auxiliary Pressure, Supplementary Tanks. If the residual pressure in the system is below the minimum allowable at the highest water outlet when the flow in the system is at peak demand, an automatically controlled pressure tank or automatically controlled pump or gravity tank of sufficient capacity shall be installed. Its capacity shall be sufficient to supply sections of the building installation which are too high to be supplied directly from the water main.

G. Low Pressure Cutoff. When a booster pump is used on an auxiliary pressure system, there shall be installed a low-pressure (<15 psi gauge) cutoff on the booster pump to prevent the creation of negative pressures on the suction side of the water system. Other arrangements may be used if found adequate and if approved by the plumbing official.

1. Exception. In the case of fire pumps whose source of water is a potable water system, in lieu of a low-pressure cutoff, a low-suction throttling valve may be installed to sense the pressure in the water supply and automatically send a signal to a valve on the discharge side of the pump. This valve will not close all the way and it will not cutoff the fire pump, but it will modulate (open and close) to throttle back the discharge in an attempt to maintain a relatively constant pressure at the sensing location on the suction side of the pump. This allows the fire pump to keep sending water to the fire while the water supply pressure on the suction side of the pump recovers. Use of this valve protects against negative pressures being created in the potable water main when an uncontrolled fire pump is used. The valve body is to be located in between the pump discharge and discharge check valve with the sensing line connected to the suction side of the pump. The valve shall be set to prevent suction pressure from dropping below 15 psi.

H. Variable Street Pressures. When the street main has a wide fluctuation in pressure, the water distribution system shall be designed for minimum pressure available.

I. Hazard and Noise. Where water pressures are excessive or where required to eliminate water hammer or when deemed necessary by local authorities, approved engineered water hammer arresters or calculated air chambers shall be provided to safeguard the water distribution system against destructive water hammer hazard and noise.

1. Approved engineered mechanical water hammer arresters shall be sized and installed in accordance with PDI-WH201 or ASSE 1010. Where line water pressure exceeds 65 psi (448 kPa) in a water distribution system, the next larger size approved water hammer arrester shall be used. When water pressure exceeds 80 psi (552 kPa), a water pressure reducing valve shall be installed in accordance with §611.J of this code. Any approved engineered mechanical water hammer arrester shall have been tested by a recognized testing laboratory and certified to meet the requirements of the above standard.

2. Where calculated air chambers are installed, they shall be in an accessible place and each air chamber shall be

provided with an accessible means for restoring the air in the event the chamber becomes waterlogged.

J. Water Pressure Reducing Valve or Regulators. The following shall apply relative to water pressure reducing valves or regulators.

1. Where water pressure within a building exceeds 80 psi (552 kPa) static, an approved water pressure regulator conforming to ASSE 1003 with strainer shall be installed to reduce the pressure in the building water distribution piping to 80 psi (552 kPa) static or less, whichever is consistent with good engineering practice. Exceptions to this requirement are service lines to sill cocks and outside hydrants, and main supply risers in tall buildings where pressure from the mains is reduced to 80 psi (552 kPa) or less at the fixture branches or at individual fixtures.

2. The delivery pressure variation shall not exceed 1 psi (6.895 kPa) for every 10 psi (69 kPa) pressure change in the inlet pressure. The reduced pressure fall-off from its no-flow setting shall not exceed 17 psi (117 kPa), and with a difference at this point of 50 psi (345 kPa) between the initial and this reduced flow pressure of 50 psi (345 kPa), the capacity shall be not less than that shown in Table 611.J of this code below.

Nominal Pipe Size (in.)	1/2	3/4	1	1 1/4	1 1/2	2
Average velocity through pipe (ft/s)	10.5	10.0	9.5	9.0	8.5	7.5
Flow(gpm)	9.95	16.65	25.0	42.0	54.8	77.5

3. An integral bypass check valve shall be capable of opening to permit a reverse flow of water through the reducing valve to prevent a buildup of system pressure by thermal expansion of the water with an increase of reduced pressure not exceeding 2 psi (13.8 kPa) above the prevailing initial pressure.

4. The valve shall be designed to remain open to permit uninterrupted water flow in case of valve failure.

5. All regulators and strainers must be so constructed and installed as to permit repair or removal of parts without breaking a pipeline or removing the valve and strainer from the pipeline.

6. Approved valves shall comply with ASSE 1003.

K. Manifold Water Distribution Systems. Manifold water distribution systems shall comply with the following.

1. Hot water and cold water manifolds shall be sized according to Table 611.K of this code below.

Nominal Size ID (Inches)	Velocity ¹	
	4 fps	8 fps
1/2	2	5
3/4	6	11
1	10	20

Table 611.K Maximum Gallons Per Minute (GPM) Available ²		
Nominal Size ID (Inches)	Velocity ¹	
	4 fps	8 fps
1 1/4	15	31
1 1/2	22	44

NOTES:

¹For velocity limitations use manufacturers' recommendations.

²Total gpm is the demand of all outlets.

2. Individual distribution pipe size shall conform to Table 611 of this code or to good engineering practice (e.g., see §1805, Appendix B of this code).

3. Individual fixture shutoff valves shall be installed at the outlet for each fixture. If secondary shutoff valves are used at the manifold, they shall be identified for the fixture being supplied.

4. Piping bundles for manifold systems shall be supported in accordance with Chapter 3. Direction changes and bending radiuses shall be in accordance with manufacturer's recommendations.

AUTHORITY NOTE: Promulgated in accordance with R.S. 40:4(A)(7) and R.S. 40:5(2)(3)(7)(9)(16)(17)(20).

HISTORICAL NOTE: Promulgated by the Department of Health and Hospitals, Office of Public Health, LR 38:2840 (November 2012).

§613. Water Service Pipe and Fittings

Editor's Note: The text in this Section will be effective on January 1, 2013.

A. Materials Underground. Materials for underground water service pipe and lawn sprinkler systems, shall be a minimum Type L copper tube, brass, cast iron pressure pipe, ductile-iron, or pressure-rated plastic as listed in Table 603 of this code. The minimum working pressure of plastic piping installed outside of the foundation walls shall be 160 psi (1103 kPa) at 73°F (23° C), with permanent identification markings. All potable water pipes, pipe fittings, plumbing fittings, or fixtures for underground water service pipe shall be evaluated and listed as conforming to NSF/ANSI 372. Any solder or flux used in the installation or repair of any plumbing including, but not limited to, water service lines in a residential or nonresidential facility providing water for human consumption shall be lead free.

1. Exception. The lead free requirement of §613.A of this code above shall not apply to:

a. leaded joints necessary for the repair of existing cast iron pipes;

b. pipes, pipe fittings, plumbing fittings, or fixtures, including backflow preventers, that are used exclusively for nonpotable services such as manufacturing, industrial processing, irrigation, outdoor watering, or any other uses where the water is not anticipated to be used for human consumption; or,

c. toilets, bidets, urinals, fill valves, flushometer valves, tub fillers, shower valves, service saddles, or water

distribution main gate valves that are 2 inches in diameter or larger.

2. Materials subject to corrosion shall be protected when installed in corrosive soils. Approved fittings shall be used on the water service pipe and the water supply system, except that changes of direction in copper tube (ASTM B 88) may be made with bends having a radius of not less than four diameters of the tube, providing that such bends are made by use of forming equipment which does not deform or create loss in cross-sectional area of the tube. If allowed by the manufacturer, bends of pressure-rated plastic pipe listed in Table 603 of this code shall be installed to conform with the manufacturer's recommendations but in no case shall the bend radius be less than the requirements contained within §§619.A.5 through 619.A.8, as applicable. With the exception of heat fused polypropylene, all other inaccessible water service joints and fittings for plastic pipe below concrete slabs and driveways are prohibited.

B. Water Service Piping. Water service lines shall be sized in accordance with accepted engineering practice (e.g., see §1805, Appendix B of this code), but in no case shall the water service piping be less than 1-inch inside nominal diameter for galvanized ferrous piping or 3/4-inch inside diameter for copper, copper alloy or approved noncorrosive pipe or tube.

C. Service Lines Near Drain or Sewer Line. Except as permitted in §613.D of this code, the underground water service pipe and the building drain or building sewer shall be not less than 5-feet (1524 mm) apart horizontally and shall be separated by undisturbed or compacted earth.

D. Permitted Installation Near Drain or Sewer Line. The water service pipe may be placed in the same trench with the building drain and building sewer provided the following conditions are met:

1. The bottom of the water service pipe, at all points, shall be at least 12 inches (305 mm) above the top of the sewer line at its highest point;

2. The water service pipe shall be placed on a solid shelf excavated at one side of the common trench; and,

3. Any underground water service pipe which must cross a pipe that conveys sewage (e.g., building drains, building sewers, and other piping conveying sewage) shall have a minimum vertical separation of 12 inches (305 mm) between the outside of the water service pipe and the outside of the sewer pipe. The water service pipe should always be installed above the sewer pipe. At crossings, one full length of water pipe shall be located so both joints will be as far from the sewer pipe as possible.

E. Stop and Waste Valves and Devices. Combination stop and waste valves and cocks shall not be installed underground in a water service pipe, water supply system, or a water distribution system. Any fixture or device which incorporates a stop and waste feature is prohibited if the waste opening is underground or in any location that waste water or water-borne contaminants may enter the device or

water supply from the ground or other source by reversal of flow.

F. Private Water Supply. No private supply shall be interconnected with any public water supply.

G. Potable Water (Pressure) Lines Near Soil Absorption Trenches, Sand Filter Beds, Oxidation Ponds, and any Effluent Reduction Option (Effluent Reduction Fields, Rock Plant Filters, Spray Irrigation Systems, Overland Flow Systems, Mound Systems, or Subsurface Drip Disposal Systems). Underground potable water (pressure) lines shall not be located within 25 feet (7.6 m) of any soil absorption trenches, sand filter beds, oxidation ponds, or any effluent reduction option [including, but not limited to effluent reduction fields, rock plant filters, spray irrigation systems (from the edge of the spray and its drainage), overland flow systems (from the discharge point and field of flow), mound systems, or subsurface drip disposal systems - see LAC 51:XIII.733] which have been installed for either the disposal of septic tank effluent or mechanical treatment plant effluent.

H. Potable Water (Pressure) Lines Near Septic Tanks, Mechanical Sewage Treatment Plants, and Pump Stations. Underground potable water (pressure) lines shall not be located within 10 feet (3.0 m) of any septic tank, mechanical sewage treatment plant, or sewage pump station.

I. Potable Water (Pressure) Lines Near Seepage Pit, Cesspool, or Sanitary Pit Privy. Underground potable water (pressure) lines shall not be located within 50 feet (15.2m) of any seepage pit, cesspool, or sanitary pit privy.

J. Reclaimed Water Lines. Reclaimed water lines shall be considered and treated as though they are sewerage lines and shall be installed in accord with the spacing requirements of this Section for the protection of potable water lines.

AUTHORITY NOTE: Promulgated in accordance with R.S. 30:2399, R.S. 40:4(A)(7), R.S. 40:5(2)(3)(7)(9)(16)(17)(20), and R.S. 40:1299.27.1.

HISTORICAL NOTE: Promulgated by the Department of Health and Hospitals, Office of Public Health, LR 38:2841 (November 2012).

§615. Water Pumping and Storage Equipment

A. Pumps and Other Appliances. Water pumps, tanks, filters, softeners, and all other appliances and devices shall be protected against contamination.

B. Drains from Pressure Tanks, Boilers, and Relief Valves. The drains from pressure tanks, boilers, relief valves and similar equipment shall not be directly connected to the drainage system.

C. Cleaning, Painting, Repairing Water Tanks. A potable water supply tank shall not be lined, painted, or repaired with any material which will affect either the taste or the potability of the water supply when the tank is returned to service. Tanks shall be disconnected from the system during such operations, to prevent any foreign fluid or substance from entering the distribution piping.

D. Insufficient Pressure. When the water pressure from the water main (or other approved sources of potable water supply) during flow is insufficient to supply all fixtures freely and continuously, the rate of supply shall be supplemented by a gravity house tank or booster system (see §611.G of this code).

E. Support. All water supply tanks shall be supported in accordance with the applicable codes adopted under the authority of Act 12 of the 2005 First Extraordinary Session or other regulations which apply.

F. Overflow Pipes. Overflow pipes for gravity tanks shall be protected against the entrance of insects and vermin and shall discharge above and within 6 inches (152 mm) of a roof or catch basin. Overflow pipes shall not be valved.

G. Drains. Water supply tanks shall be provided with valved drain lines located at their lowest point and discharged as an indirect waste. Drains for water supply tanks shall be not less than shown in Table 615.G of this code below.

Table 615.G Minimum Drain Size for Water Supply Tanks			
Drain Pipe (in)	Tank Capacity (gal)	Drain Pipe (in)	Tank Capacity (gal)
1	Up to 750	2 1/2	3001 to 5000
1 1/2	751 to 1500	3	5001 to 7500
2	1501 to 3000	4	Over 7500

1. Each drain line shall be equipped with a quick opening valve of the same diameter as the pipe.

H. Gravity and Suction Tank. Tanks used for potable water supply shall be equipped with tight covers which are vermin and rodent proof. Such tanks shall be vented with a return bend vent pipe having an area not less than one-half the area of the feed riser, and the vent opening shall be properly screened.

I. Pressure Tank. Pressure tanks used for supplying potable water shall be equipped with an approved vacuum relief device located on the top of the tank. The air inlet of this device shall be properly screened.

AUTHORITY NOTE: Promulgated in accordance with R.S. 40:4(A)(7) and R.S. 40:5(2)(3)(7)(9)(16)(17)(20).

HISTORICAL NOTE: Promulgated by the Department of Health and Hospitals, Office of Public Health, LR 38:2843 (November 2012).

§617. Water Supply Control

A. Valves Required. An accessible shutoff valve shall be provided on the consumer's premises ahead of the first outlet or branch connection to the service or distribution pipe of each dwelling, dwelling unit and buildings other than dwellings and dwelling units. Full port ball valve shut-offs on lines to 2 inches or full port ball or resilient wedge-type shut-off valves for 2 1/2-inch lines and larger shall be used. When such shutoff valve is located in the service pipe outside the building, it shall be located and accessible in a manufactured, approved, valve box with a readily removable access cover which extends to grade_(G) level. When drain valves are provided for the distribution piping or other

portions of the water distribution system, such drains shall be above grade_(G) or otherwise located to prevent the possibility of backflow into the piping system after the system has been drained.

B. Tank Controls. Supply lines taken from pressure or gravity tanks shall be valved at or near the tank.

C. Controls for Fixtures Within Dwellings and Dwelling Units. Each individual fixture shall have an accessible shutoff valve at each outlet which will permit each fixture to be shut off without interfering with the water supply to any other fixtures. Shutoff valves for each fixture supplied by a manifold distribution system may be located at the manifold in addition to the outlet of the fixture being supplied. The hose bibb or hose connection shutoff valve shall be the only shutoff valve required on washing machine connectors.

1. Shutoff valves to water supply for refrigerators with automatic ice makers shall be accessible on the same floor.

D. Controls for Fixtures in Buildings Other Than Dwellings or Dwelling Units. In all buildings other than dwellings and dwelling units, shutoff valves shall be installed which permit the water supply to all fixtures and equipment in each separate room to be shut off without interference with the water supply to any other room or portion of the building or each individual fixture and piece of equipment shall have a shutoff valve which will permit each fixture and piece of equipment to be shut off without interfering with the water supply to other fixtures or equipment.

1. Each water supply branch line 1 1/2-inch or larger shall have a shutoff valve installed so as to isolate all fixtures and all pieces of equipment supplied by the branch line. The shutoff valve shall be installed in a labeled and accessible location as close to the connection to the supply main and/or riser as practical.

AUTHORITY NOTE: Promulgated in accordance with R.S. 40:4(A)(7) and R.S. 40:5(2)(3)(7)(9)(16)(17)(20).

HISTORICAL NOTE: Promulgated by the Department of Health and Hospitals, Office of Public Health, LR 38:2843 (November 2012).

§619. Water Distribution Pipe, Tubing and Fittings

Editor's Note: The text in this Section will be effective on January 1, 2013.

A. General. Water distribution pipe, tubing and fittings shall comply with the following.

1. Minimum working pressure for plastic hot and cold piping material installed inside of the foundation walls shall be 100 psi (689.5 kPa) at 180°F (82°C), with permanent identification markings.

2. Materials subject to corrosion shall be protected when installed in corrosive soils. Approved fittings shall be used on the water distribution system and the water supply system, except that changes of direction in copper tube (ASTM B 88) may be made with bends having a radius of not less than four diameters of the tube, providing that such bends are made by use of forming equipment which does not

deform or create loss in cross-sectional area of the tube. If allowed by the manufacturer, bends of pressure-rated plastic pipe listed in Table 603 of this code shall be installed to conform with the manufacturer's recommendations but in no case shall the bend radius be less than the requirements contained within §§619.A.5 through 619.A.8 of this code, as applicable.

3. All potable water pipes, pipe fittings, plumbing fittings, or fixtures for the water distribution system shall be evaluated and listed as conforming to NSF/ANSI 372. Any solder or flux which is used in the installation or repair of any plumbing including, but not limited to, water distribution pipes in a residential or nonresidential facility providing water for human consumption shall be lead free.

a. Exception. The lead free requirement of §619.A.3 of this code above shall not apply to:

i. leaded joints necessary for the repair of existing cast iron pipes;

ii. pipes, pipe fittings, plumbing fittings, or fixtures, including backflow preventers, that are used exclusively for nonpotable services such as manufacturing, industrial processing, irrigation, outdoor watering, or any other uses where the water is not anticipated to be used for human consumption; or,

iii. toilets, bidets, urinals, fill valves, flushometer valves, tub fillers, shower valves, service saddles, or water distribution main gate valves that are 2 inches in diameter or larger.

4. All pipes and pipe fittings shall conform to the standards listed in Table 603 of this code. All solder and flux shall conform to the applicable standard(s) listed in Table 303 of this code.

5. Bends of cross-linked polyethylene (PEX) plastic tubing shall be installed to conform to the manufacturer's recommendations but in no case shall the bend radius be less than the following:

a. When bent with the coil-a bending radius equivalent to or greater than 8 times the outside diameter of the tubing shall be maintained. Outside diameter is equal to the inside nominal diameter plus 1/8-inch.

b. When bent against the coil-a bending radius equivalent to or greater than 24 times the outside diameter of the tubing shall be maintained. Outside diameter is equal to the inside nominal diameter plus 1/8-inch.

6. Because the linear expansion rate for cross-linked polyethylene (PEX) tubing is about 1 inch/10°F for each 100 feet (30 m) of tubing, it should not be rigidly anchored to any support in order to allow for freedom of movement during expansion and contraction. When installing long runs of tubing, a longitudinal clearance of 1/8 to 3/16 inch per foot of run should be allowed to accommodate for thermal expansion. PEX tubing, where it passes through concrete or a similar building material which would not allow for freedom of linear expansion, shall be provided with a pipe sleeve of Schedule 40 pipe which shall be built into the

foundation, footing, floor, wall or ceiling. Such pipe sleeve shall be of sufficient inside diameter to allow for the free expansion and contraction of the PEX tubing and to prevent any rubbing action.

7. The maximum recommended spacing between horizontal supports for cross-linked polyethylene (PEX) tubing is 32 inches (813 mm) for nominal tubing diameters from 1/4- inch through 2-inch. It should not be rigidly secured to a joist or stud but should be secured with smooth plastic strap hangers, which permit ease of movement during expansion or contraction. Valve and fixture connections to which PEX pipe is connected shall be rigidly anchored.

8. Bends of chlorinated polyvinyl chloride (CPVC) plastic pipe shall be installed to conform to the manufacturer's recommendations but in no case shall the bend radius be less than the following:

a. A bending radius equivalent to or greater than 18 inches (457 mm) for 1/2 and 3/4-inch inside nominal diameter piping.

b. A bending radius equivalent to or greater than 24 inches (610 mm) for 1-inch inside nominal diameter piping.

B. Materials Above Ground. Materials for water distribution pipes and tubing shall be brass, copper water tube minimum type L (i.e., type M copper is prohibited), stainless steel water pipe or tubing (Types 304/304L and 316/316L only), cast iron pressure pipe, ductile-iron, galvanized steel, pressure-rated polypropylene (PP), chlorinated polyvinyl chloride (CPVC) or cross-linked polyethylene (PEX) plastic pipe or tubing, all to be installed with approved fittings and bends; except that changes in direction in copper tube (ASTM B 88) may be made with bends having a radius of not less than four diameters of the tube, providing that such bends are made by use of forming equipment which does not deform or create a loss in cross-sectional area of the tube. Translucent PEX plastic pipe or tubing, when installed above ground, shall not be exposed to direct or indirect sunlight.

C. Materials Below Ground. Inaccessible water distribution piping under slabs shall be copper water tube minimum type L (i.e., type M copper is prohibited), brass, stainless steel water pipe (types 304/304L and 316/316L only), cast iron pressure pipe, ductile-iron pipe, chlorinated polyvinyl chloride (CPVC), pressure-rated polypropylene (PP) or cross-linked polyethylene (PEX) plastic pipe or tubing, all to be installed with approved joining methods or bends. All copper, brass and stainless steel joints below a building slab shall be brazed and/or welded in accordance with §315.D and §§621.D through 621.G of this code, as appropriate. Heat fused joints for polypropylene shall be made in accordance with §621.E.3 of this code. With the exception of heat fused polypropylene, all other joints and fittings for plastic pipe below a building slab are prohibited. Any material subject to corrosion shall be protected when used in corrosive soils.

D. Valves. Valves shall conform to the standards listed in Table 619.D of this code below.

Materials	Standards
Valves, Bronze Gate, Globe, Angle, Check	MSS SP-80
Valves, Cast Iron	ASTM A 126
Valves, Ball	MSS SP-72. MSS SP-110
Valves, Resilient-Seated Gate	AWWA C509

AUTHORITY NOTE: Promulgated in accordance with R.S. 40:4(A)(7), R.S. 40:5(2)(3)(7)(9)(16)(17)(20), and R.S. 40:1299.27.1.

HISTORICAL NOTE: Promulgated by the Department of Health and Hospitals, Office of Public Health, LR 38:2843 (November 2012).

§621. Joints

Editor's Note: The text in this Section will be effective on January 1, 2013.

A. General. This Section contains provisions applicable to joints specifically for water service and distribution piping. Provisions for those joining methods which are applicable to more than one piping system are contained in Chapter 3 of this code.

B. Soldered Joints. Soldered joints for tubing shall be made with approved fittings (see §621.F of this code). Surfaces to be soldered shall be cleaned bright, all burrs shall be removed and the tubing shall be returned to full bore. The joints shall be properly fluxed and made with approved solder (see Table 303 of this code). All solder and flux used in the installation or repair of water supply systems, water distribution systems, and water service pipe shall be lead free. Soldered joints should not be made closer than 18 inches (457 mm) to an installed plastic-to-metal adapter in the same water line.

1. Exception. The lead free requirement of §621.B of this code above shall not apply to:

a. leaded joints necessary for the repair of existing cast iron pipes;

b. pipes, pipe fittings, plumbing fittings, or fixtures, including backflow preventers, that are used exclusively for nonpotable services such as manufacturing, industrial processing, irrigation, outdoor watering, or any other uses where the water is not anticipated to be used for human consumption; or

c. toilets, bidets, urinals, fill valves, flushometer valves, tub fillers, shower valves, service saddles, or water distribution main gate valves that are 2 inches in diameter or larger.

C. Flared Joints. Flared joints for soft tempered copper water tube shall be made with fittings meeting approved standards. The tubing shall be expanded with a proper flaring tool.

D. Brazed Joints. Brazed joints shall be made in accordance with the provisions of Section 6 of ANSI B31.1. Brazed joints should not be made closer than 18 inches (457 mm) to an installed plastic-to-metal adapter in the same water line.

E. Joints for Plastic Water Service and Water Distribution Pipe and Fittings. Joints for plastic water service and water distribution pipe and fittings shall comply with the following.

1. General. Plastic pipe and fittings for water service piping and water distribution piping may be of the insert type, compression type, solvent cemented (see Table 303 and Section 313.H.1 of this code), heat fused, pressure-lock, or may be hot or cold flared as recommended by the manufacturer or the Plastic Pipe Institute for the particular materials being used. With the exception of heat fused polypropylene, all other joints and fittings for plastic pipe are prohibited on inaccessible water distribution piping under slabs.

2. Polyethylene Water Service. Stiffener inserts used with compression type fittings shall not extend beyond the clamp or nut of the fitting. Pipe shall be cut square, using a cutter designed for plastic pipe and ends shall be chamfered to remove sharp edges. Electro and heat fusion joints for Polyethylene pipe and fittings shall be made in accordance with ASTM F 1290 and ASTM F 2620, respectively. Flared joints shall be permitted where recommended by the manufacturer and made by the use of a tool designed for that operation.

3. Polypropylene Piping and Joints. Heat fused joints for polypropylene pipe and fitting joints shall be made in accordance with ASTM D 2657.

F. Copper Water Pipe and Tubing Joints for copper water pipe and tubing shall be formed either by the appropriate use of approved brass, bronze or wrought copper water fittings, properly soldered or brazed together, or by means of approved flare fittings as provided in §621.C of this code.

G. Stainless Steel Pipe and Joints. Joints and fittings for stainless steel pipe shall be installed in accordance with the manufacturer's installation instructions and approved standards. Welded joints shall be either fusion or resistance welded based on the selection of the base metal. Chemical composition of the filler metal shall comply with AWS A5.9 based on the alloy content of the piping material.

H. Special Joints. The special joints identified below shall comply with the following.

1. Copper Water Tubing or Stainless Steel Tubing to Threaded Pipe Joints. Joints from copper water tubing or stainless steel tubing to threaded pipe shall be formed by the use of bronze or copper adapter fittings. The joint between the copper tube or stainless steel tube and fittings shall be properly soldered or brazed, and the connection between the threaded pipe and the fitting shall be made with a standard pipe size threaded joint.

2. Ground Joint Brass Connections. Ground joint brass connections which allow adjustment of tubing but provide a rigid joint when made up shall not be considered as slip joints.

3. Plastic Pipe to Other Materials. Joints between plastic pipe and other materials shall be formed with proper adaption fittings as furnished by the manufacturer.

4. Unions. Unions in the water service pipe and water distribution system shall be metal-to-metal with ground seats.

AUTHORITY NOTE: Promulgated in accordance with R.S. 40:4(A)(7) R.S. 40:5(2)(3)(7)(9)(16)(17)(20), and R.S. 40:1299.27.1.

HISTORICAL NOTE: Promulgated by the Department of Health and Hospitals, Office of Public Health, LR 38:2845 (November 2012).

§623. Safety Devices

A. Shower Temperature Control Devices.

1. Multiple (gang) Showers. Multiple (gang) showers, when supplied by a single temperature controlled water supply pipe, shall be controlled by a master temperature actuated mixing valve conforming to ASSE 1069, or each shower shall be individually controlled by an automatic compensating scald preventative valve of the pressure balancing, thermostatic or combination pressure balance/thermostatic mixing valve type conforming to ASSE 1016, ASME A 112.18.1 or CSA B125.1. Handle position stops or other limit setting devices shall be provided on such valves and shall be adjusted in accordance with manufacturer's instructions at time of installation to deliver a maximum mixed water outlet temperature of 120°F (48.3° C).

2. Individual Shower and Shower/Bath Combinations. Shower and shower/bath combinations in all buildings shall be provided with an automatic compensating scald preventative valve of the pressure balance, thermostatic, or combination pressure balance/thermostatic mixing valve type which provides scald and thermal shock protection for the rated flow rate of the installed showerhead. These valves shall conform to ASSE 1016, ASME A 112.18.1 or CSA B125.1 and shall be equipped with a means to limit the maximum setting of the valve to 120°F (48.3°C), which shall be field adjusted in accordance with the manufacturer's instructions at the time of installation.

B. Public Lavatory Temperature Control Devices. The temperature of the water delivered from public use lavatories or other public hand-washing fixtures shall be limited to a maximum temperature of 120°F (48.3° C) by a temperature control device that conforms to ASSE 1070.

C. Bathtub and Whirlpool Temperature Control Devices. The temperature of the water delivered from bathtubs and whirlpools shall be limited to a maximum temperature of 120°F (48.3° C) by a temperature control device that conforms to ASSE 1070, except where such protection is otherwise provided for in accordance with §623.A of this code.

Table 623 Temperature Control Device Standards	
Materials	Standards
Automatic Compensating Valves for Individual Shower and Tub-Shower Combinations	ASSE 1016

Table 623 Temperature Control Device Standards	
Materials	Standards
Temperature Actuated Mixing Valves for Hot Water Distribution Systems	ASSE 1017
Automatic Temperature Control Mixing Valves	ASSE 1069
Water Temperature Limiting Devices	ASSE 1070
Plumbing Supply Fittings	ASME A112.18.1, CSA B125.1

D. Thermal Expansion Control. Thermal expansion shall be controlled in accord with the following requirements.

1. If water is heated and stored in a consumer's system and the system has been closed by the installation of a backflow preventer or a pressure reducing valve, a thermal expansion control shall be installed at an accessible location between the checking device and the water heating equipment to limit thermal expansion of the water being heated to not more than 80 psi (552 kPa) static pressure at any fixture on the system. A potable water expansion tank or auxiliary relief valve set at 80 psi (552 kPa) shall be acceptable.

2. The auxiliary relief valve shall be in addition to the water heater safety relief valve. This thermal expansion control device shall be designed and trimmed for repeated operation. The valve shall be a minimum 1/2-inch pipe size, shall be adjustable and calibrated, and shall include a tag describing its function.

AUTHORITY NOTE: Promulgated in accordance with R.S. 40:4(A)(7) and R.S. 40:5(2)(3)(7)(9)(16)(17)(20).

HISTORICAL NOTE: Promulgated by the Department of Health and Hospitals, Office of Public Health, LR 38:2846 (November 2012).

§625. Miscellaneous

A. Drain Cock. All storage tanks shall be equipped with adequate drain cocks.

B. Line Valves. Valves in the water supply distribution system, except those immediately controlling one fixture supply, when fully opened shall have a cross-sectional area at the smallest orifice or opening through which the water flows at least equal to the cross-sectional area of the nominal size of the pipe in which the valve is installed.

C. Water Used for Processing. Water used for cooling of equipment or similar purposes shall not be returned to the potable water distribution system, water service pipe, or water supply system. When discharged to the building drainage system or other point of disposal, the waste water shall be discharged through an air gap (water distribution).

D. Trap Primers Connected Directly to a Potable Water System. Trap primers which connect directly to a potable water system shall comply with the following.

1. Trap primers which are connected directly to a potable water system shall be constructed with integral air gaps. In addition to the integral air gap, additional backflow protection shall be provided by the installation of either an approved air gap device on the discharge line from each trap primer, or by the installation of an approved reduced

pressure principle backflow preventer on the trap primer's individual potable water supply line.

2. Trap primers (and associated air gap device and/or reduced pressure principle backflow preventer) shall be accessible and shall not be concealed by building or other construction.

3. Trap primer drains shall be constructed to completely drain by gravity after each cycle of operation and, in no case, shall the drain be connected to the trap below the top of the trap water seal or trap outlet weir.

4. Trap primer air gaps, when required, shall be located a minimum of 6 inches (152 mm) above the flood level of the floor drain or receptor served.

5. Trap primers which connect to the potable water system shall be connected to the cold water supply in accordance with the manufacturer's recommendations.

6. Separate cutoff valves shall not be installed between a trap primer and its water supply except that a cutoff valve for an individual fixture shall control both the water supply to the trap primer and the individual fixture to assure a constant supply to the primer.

AUTHORITY NOTE: Promulgated in accordance with R.S. 40:4(A)(7) and R.S. 40:5(2)(3)(7)(9)(16)(17)(20).

HISTORICAL NOTE: Promulgated by the Department of Health and Hospitals, Office of Public Health, LR 38:2846 (November 2012).

§627. Water Treatment Units

A. Drinking water treatment units shall meet the requirements of NSF 42 and 53. Units are designed to be used for the reduction of specific contaminants from potable drinking water, such contaminants being considered as potential health hazards or affecting the aesthetic quality characteristics of potable drinking water.

B. Reverse osmosis drinking water treatment systems shall meet the requirements of NSF 58. Systems are designed to be used for the reduction of specific contaminants from potable drinking water supplies considered to be microbiologically safe and of known quality (except that claims for the reduction of filterable cysts may be permitted). Systems covered by this standard are intended for reduction of total dissolved solids (TDS) and other contaminants specified therein.

C. Waste and discharge from reverse osmosis or other types of water treatment units shall enter the drainage system through an air gap (drainage system).

AUTHORITY NOTE: Promulgated in accordance with R.S. 40:4(A)(7) and R.S. 40:5(2)(3)(7)(9)(16)(17)(20).

HISTORICAL NOTE: Promulgated by the Department of Health and Hospitals, Office of Public Health, LR 38:2846 (November 2012).

§629. Additional Water Supply and Distribution Provisions

A. Additional provisions for water supply and distribution are found in the following:

1. LAC 51:XIV.609.F, Cross-Connection Control;
2. LAC 51:XIV.Chapter 13, Medical Facilities Plumbing Systems;
3. LAC 51:XIV.Chapter 15, Travel Trailers and Travel Trailer Parks;
4. LAC 51:XIV.Chapter 16, Mobile/Manufactured Homes and Mobile/Manufactured Home Parks; and,
5. LAC 51:XIV.1805, Appendix B, Sizing of Water Piping System.

AUTHORITY NOTE: Promulgated in accordance with R.S. 40:4(A)(7) and R.S. 40:5(2)(3)(7)(9)(16)(17)(20).

HISTORICAL NOTE: Promulgated by the Department of Health and Hospitals, Office of Public Health, LR 38:2847 (November 2012).

Chapter 7. Sanitary Drainage

§701. General

A. Scope. The provisions of this Chapter shall govern the materials, design, construction, and installation of sanitary drainage systems.

B. Damage to Drainage System, Sewerage System, or Sewage-Treatment Plant. Wastes which are detrimental to, and/or able to cause damage or operational problems to, either the drainage system, the sewerage system, or the functioning of the sewage-treatment plant shall be treated and disposed of in accordance with §703.F, §1005, or an approved pretreatment system as directed by the plumbing official.

C. Individual Sewerage System. Where a community sewerage system is not available, an individual sewerage system shall be of a type that is acceptable and approved by the state health officer. See Chapter 17 of this code.

D. Tests. The sanitary drainage system shall be tested in accordance with §319 of this code.

E. Engineered Systems. Engineered sanitary drainage and venting systems shall conform to the provisions of Chapter 12 of this code.

AUTHORITY NOTE: Promulgated in accordance with R.S. 40:4(A)(7) and R.S. 40:5(2)(3)(7)(9)(16)(17)(20).

HISTORICAL NOTE: Promulgated by the Department of Health and Hospitals, Office of Public Health, LR 38:2847 (November 2012).

§703. Materials

A. General. Pipe, tubing, and fittings for drainage systems shall conform to the standards listed in Table 703 of this code.

B. Specific Type. Standards listed in Table 703 of this code below apply to the specific materials approved for use and, as indicated in the various Sections in this Chapter, as they apply to the drainage system.

C. Aboveground Piping within Buildings and Piping in Raceways or Tunnels. Aboveground piping within buildings

and piping in raceways or tunnels shall comply with the following.

1. Soil and waste piping for drainage systems shall be of cast iron, galvanized steel, type 304 or 316L stainless steel, brass or copper pipe, type DWV copper tube, Schedule 40 plastic piping or borosilicate glass.

2. Vertical soil, waste and vent stacks shall be designed to control expansion and contraction, in accordance with accepted engineering practice, to the satisfaction of the plumbing official.

D. Underground Piping Within Buildings. All underground drains within buildings shall be cast iron soil pipe, type 316L stainless steel, ductile-iron pipe, type DWV copper, heavy schedule borosilicate glass, or Schedule 40 plastic piping. Materials subject to corrosion shall be protected when installed in corrosive soils.

Table 703 Drainage System Materials	
Materials	Standards
Nonmetallic Piping	
Clay Drain Tile	ASTM C 4
Clay Pipe Compression Joints	ASTM C 425
Clay Sewer Pipe	ASTM C 700, Markings shall include ASTM number
Concrete Drain Tile	ASTM C 412/C 412M
Concrete Perforated Pipe	ASTM C 444/C 444M
Concrete Reinforced Culverts	ASTM C 76/C 76M, For storm drains only
Concrete Reinforced Sewer Pipe	ASTM C 361/C 361M, For storm drains only
Concrete Non-reinforced Sewer Pipe	ASTM C 14, For storm drains only
Sewer Manholes Precast Reinforced	ASTM C 478/C 478M
Concrete (Steel Cylinder Type)	FSS-P-381
Plastic Pipe and Fittings	
ABS-DWV Pipe and Fittings	ASTM D 2661, Listed, See §303.H.2 of this code
ABS Sewer Pipe and Fittings (for outside building sewers, storm drains and storm sewers)	ASTM D 2751, See §§705.A, 1101.E, 1103.B, and 1103.D of this code (Installation: ASTM D 2321)
Acrylonitrile-Butadiene-Styrene (ABS) Schedule 40 Plastic Drain Waste, and Vent Pipe with a Cellular Core	ASTM F 628, Listed
Chlorinated Poly (Vinyl Chloride) (CPVC) Pipe and Fittings for Chemical Waste Drainage Systems	ASTM F 2618
Coextruded Composite Pipe	ASTM F 1488, See §§303.H.2, 303.H.4, 705.A, 1101.E, and 1103.B, 1103.D of this code
Coextruded Composite Drain, Waste, and Vent Pipe (DWV)	ASTM F 1499, See §§303.H.2, 303.H.4, 705.A, 1101.E, 1103.B, and 1103.D of this code
Coextruded PVC Plastic Pipe with a Cellular Core	ASTM F 891, See §§303.H.2, 303.H.4, 705.A, 1101.E, 1103.B, and 1103.D of this code
Flexible Elastomeric Non-Pressure Joints	ASTM D 3212, See §303.H of this code
Large Diameter Ribbed PVC Sewer Pipe and Fittings	CAN/CSA-B182.4
Polyolefin Pipe and Fittings for Corrosive Waste Drainage Systems	ASTM F 1412
Polyvinylidene Fluoride (PVDF) Corrosive Waste Drainage Systems	ASTM F1673

Table 703 Drainage System Materials	
Materials	Standards
PVC-DWV Pipe and Fittings	ASTM D 2665, Listed, See §303.H.2 of this code
ABS and PVC Plastic Tube and Tubular Fittings	ASTM F 409
Type PSM PVC Sewer Pipe & Fittings (for outside building sewers, storm drains and storm sewers)	ASTM D 3034, See §705.A, 1101.E, 1103.B, and 1103.D of this code (Installation: ASTM D 2321)
Type PSP PVC Sewer Pipe & Fittings (for outside building sewers, storm drains and storm sewers)	ASTM D 2321, Installation
<u>Ferrous Pipe and Fittings</u> Cast Iron Soil Pipe and Fittings	ASTM A 74, CISPI HS
Cast Iron Hubless Pipe and Fittings	CISPI Std. 301, ASTM A 888
Ductile-Iron Gravity Sewer Pipe	ASTM A 746
Hubless Cast Iron Sanitary System	CISPI Std. 310
Manhole Top Frames and Covers	ASTM A 48/A 48M
Stainless Steel Drainage Systems for Sanitary DWV, Storm, and Vacuum Applications, Above- and Below Ground (Type 304 is prohibited from underground use in these drainage systems)	ASME A112.3.1
<u>Nonferrous Pipe and Fittings</u> Cast Copper Alloy Solder-Joint Drainage Fittings DWV	ASME B 16.23
Cast Copper Alloy Solder Joint Fittings for Sovent Drainage Systems	ANSI B 16.32
Copper Drainage Tube DWV	ASTM B 306
Corrosion-Resistant High-Silicon Iron Castings	ASTM A 518/A 518M
Lead Pipe, Bends and Traps	FS WW-P-325
Welded Copper and Copper Alloy Heat Exchanger Tube	ASTM B 543
Wrought Copper and Wrought Copper Alloy Solder-Joint Drainage Fittings For Plumbing Drainage Waste and Vents	ASME B 16.29
Wrought Copper and Copper Alloy Solder-Joint Fittings for Sovent Drainage Systems	ANSI B 16.43
<u>Glass Pipe</u> Borosilicate Glass Pipe and Fittings for DWV Applications	ASTM C 1053

E. Fittings. Fittings on the drainage system shall be compatible to the type of piping used. Fittings on threaded pipe shall be of the recessed drainage type. See §311 of this code.

F. Acid Soil and Waste Piping. Acid soil and waste piping for drainage systems shall be of a high silicon cast iron complying with ASTM A 518/A 518M, borosilicate glass complying with ASTM C 1053, chlorinated poly (vinyl chloride) (CPVC) complying with ASTM F 2618, polyolefin pipe complying with ASTM F 1412, polyvinylidene fluoride (PVDF) complying with ASTM F 1673, or other materials approved by the plumbing official. Joints shall be made in conformance with the manufacturer's recommendations. Acid soil, waste and vent piping shall not be connected to the conventional plumbing system.

1. Neutralizing Device. In no case shall corrosive liquids, spent acids, or other harmful chemicals which might destroy or injure a drain, sewer, soil or waste pipe, or which might create noxious or toxic fumes, discharge into the plumbing system without being thoroughly diluted or neutralized by passing through a properly constructed and acceptable dilution or neutralizing device (generally, utilizing limestone chips). Such device shall be automatically provided with a sufficient intake of diluting water or neutralizing medium, so as to make its contents noninjurious before being discharged into the soil or sewage system.

AUTHORITY NOTE: Promulgated in accordance with R.S. 40:4(A)(7) and R.S. 40:5(2)(3)(7)(9)(16)(17)(20).

HISTORICAL NOTE: Promulgated by the Department of Health and Hospitals, Office of Public Health, LR 38:2847 (November 2012).

§705. Building Sewer

A. Separate Trenches. The building sewer, when installed in a separate trench from the water service pipe, shall be cast iron sewer pipe, vitrified clay sewer pipe, or plastic piping (minimum SDR 35 or heavier). Joints shall be watertight and rustproof and all material shall be installed according to the manufacturer's recommendations (see §705.H of this code). All pipe and fittings shall bear the manufacturer's name or trademark.

B. Sewer in Filled Ground. A building sewer or building drain installed in unstable fill or unstable ground shall be of cast iron pipe, except that nonmetallic drains may be laid upon an approved continuous supporting system if installed in accordance with §705.A of this code.

C. Sanitary and Storm Sewers. Where separate systems of sanitary drainage and storm drainage are installed in the same property, the sanitary and storm building sewers or drains may be laid side by side in one trench.

D. Old House Sewers and Drains. Old building sewers and building drains may be used in connection with new building or new plumbing and drainage work only when they are found, on examination and test, to conform in all respects to the requirements governing new house sewers. The plumbing official shall notify the owner to make the changes necessary to conform to this code.

E. Cleanouts on Building Sewers. Cleanouts on building sewers shall be located as set forth in §717.B of this code.

F. Minimum Size Building Sewer. No building sewer shall be less than 4 inches in size with the exception of force lines.

G. Backwater Valves. Backwater valves shall comply with the following.

1. Fixture Branches. Backwater valves shall be installed in the branch of the building drain which receives only the discharge from fixtures located below grade^(G). Where fixtures are located below the level of the top of the first upstream manhole, said fixtures shall be protected by a backwater valve.

2. **Material.** Backwater valves shall have all bearing parts of corrosion resistant material. Backwater valves shall comply with ASME A 112.14.1 or CAN/CSA B181.1, CAN/CSA B181.2.

3. **Seal.** Backwater valves shall be so constructed as to insure a mechanical seal against backflow.

4. **Diameter.** Backwater valves, when fully opened, shall have a capacity not less than that of the pipes in which they are installed.

5. **Location.** Backwater valves shall be so installed to be accessible for service and repair.

H. **Installation of Building Sewers.** The installation of building sewers shall comply with the following. [formerly Appendix I - Installation of Building Sewers]

1. **Cast Iron Soil Pipe.** Cast iron soil pipe shall be installed in accord with the following requirements.

a. **Trench Construction.** Pipe shall be installed in as narrow a trench as possible while providing sufficient width for joint assembly.

b. **Bedding.** Pipe shall be installed so that the trench bottom provides support of the pipe barrel. Hub holes and coupling holes shall be provided.

c. **Rock.** When rock larger than 1 1/2 inches (38.1 mm) in diameter is encountered during installation, it shall be removed from the trench bottom and a 6-inch (152.4 mm) layer of selected fill shall be added to provide uniform support.

d. **Backfilling.** Backfill trench following test. When backfilling, care shall be taken to protect the pipe from large rocks, stone, or frozen fill material which could damage the pipe.

2. **Clay Pipe.** Clay pipe shall be installed in accord with the following requirements.

a. **Trench and Material Preparation.** The trench and material preparation for clay pipe shall be as follows:

i. Width of trenches in which clay pipe is to be installed shall be such as to provide adequate space for workmen to place and joint the pipe properly.

ii. Bell holes shall be excavated so that, after placement, only the barrel of the pipe receives bearing pressure from the trench bottom.

iii. Preparation of the trench bottom and placement of the pipe shall be carefully done so that, when in final position, the pipe is true to line and *grade(s)*.

iv. Pipe shall be protected during handling against impact shock and free fall. No pipe shall be used in the work which does not conform to the appropriate ASTM standard.

b. **Pipe Laying and Joining.** The pipe laying and joining of clay pipe shall be as follows:

i. The laying of pipe in finished trenches shall be commenced at the lowest point, with the spigot ends pointing in the direction of flow.

ii. All pipe shall be laid with ends abutting and true to line and *grade(s)*. They shall be carefully centered, so that when laid they will form a sewer with a uniform invert.

iii. Pipe shall be set firmly according to line and *grade(s)*, and, preparatory to making pipe joints, all surfaces of the portion of the pipe to be joined shall be cleaned and dried. The joints shall then be carefully adjusted and filled with the jointing material.

iv. Trenches shall be kept water-free during joining and for a sufficient period thereafter to allow the jointing material to become fully set and completely resistant to water penetration. Trenches shall be backfilled immediately after pipe is laid therein to prevent dislocation of the sewer line or jointing material, except when factory applied flexible compression joints are used.

c. **Testing.** The clay pipe sewer line shall be tested as required in §319 of this code, or as prescribed by the local plumbing official.

3. **Plastic Pipe.** Plastic pipe shall be installed in accord with the following requirements.

a. **Trenching and Supporting.** The trenching and supporting of plastic pipe shall be as follows:

i. **Trenching.** Excavate to desired *grade(s)*. Use template to detect high spots and holes. Fill holes and depressions, tamping thoroughly.

ii. Where trenching conditions are difficult, pipe shall be uniformly supported throughout using treated timber, concrete pad, sand, or select backfill properly tamped.

b. **Laying, Bedding and Backfilling.** The laying, bedding and backfilling of plastic pipe shall be as follows.

i. Lay the pipe line as described. Be sure the pipe is bedded in the selected backfill one-fourth to one-third of the pipe diameter. Under no circumstances should bricks or other supports be used to bring pipe to *grade(s)*.

ii. After pipe is bedded and checked for *grade(s)*, additional selected backfill is placed by shovel at sides and over top of pipe and tamped. By careful tamping at this point, the pipe can support a much greater load and is less likely to be subsequently disturbed or shifted.

iii. Reasonably clean backfill shall be placed 12 inches (305 mm) over the pipe.

iv. The trench may now be backfilled by any conventional means, bulldozer, loader, etc., and the pipe is protected.

AUTHORITY NOTE: Promulgated in accordance with R.S. 40:4(A)(7) and R.S. 40:5(2)(3)(7)(9)(16)(17)(20).

HISTORICAL NOTE: Promulgated by the Department of Health and Hospitals, Office of Public Health, LR 38:2848 (November 2012).

§707. Drainage Piping Installation

A. Horizontal Drainage Piping. Horizontal drainage piping shall be installed at a uniform slope but at slopes not less than permitted in §§707.B through 707.D of this code.

B. Small Piping. Horizontal building drainage piping less than 3-inch diameter shall be installed with a fall of not less than 1/4 inch per foot (21 mm per meter).

C. Large Piping. Horizontal building drains 3-inch diameter or larger shall be installed with a fall of not less than 1/8 inch per foot (10 mm per meter).

D. Minimum Velocity. Where conditions do not permit building drains and sewers to be laid with a fall as great as that specified, then a lesser slope may be permitted provided the computed velocity will be not less than 2 fps (0.61 m/s).

AUTHORITY NOTE: Promulgated in accordance with R.S. 40:4(A)(7) and R.S. 40:5(2)(3)(7)(9)(16)(17)(20).

HISTORICAL NOTE: Promulgated by the Department of Health and Hospitals, Office of Public Health, LR 38:2849 (November 2012).

§709. Joints

A. General. This Section contains provisions applicable to joints specific to sanitary drainage piping. Provisions for those joining methods which are applicable to more than one piping system are contained in Chapter 3 of this code.

B. Caulked Joints. Caulked joints for cast-iron hub-and-spigot soil pipe shall be firmly packed with oakum or hemp and filled with molten lead not less than 1-inch (25.4 mm) deep and extending not more than 1/8 inch (3.18 mm) below rim of hub. No paint, varnish, or other coatings shall be permitted on the jointing material until after the joint has been tested and approved.

C. Joints for Plastic Pipe and Fittings. Refer to §313.H of this code for ABS and PVC joints.

D. Elastomeric Compression Gasket for Cast Iron Soil Pipe. Elastomeric compression gasketed joints for cast iron soil pipe shall comply with the following.

1. A positive-seal one piece elastomeric compression type gasket may be used for joining hub and spigot cast iron soil pipe as an alternate for lead or oakum joints. The joint is formed by inserting an approved gasket in the hub. The inside of the gasket is lubricated and the spigot end of the pipe is pushed into the gasket until seated, thus affecting a positive seal.

2. A positive-seal one piece elastomeric compression-type gasket for joining hub and spigot cast iron soil pipe may be used for drainage and waste systems above and below ground.

3. Compression gaskets for cast iron soil pipe shall be neoprene, marked as such, with ASTM C 564.

E. Hubless Cast Iron Soil Pipe System. Joints for hubless cast iron soil pipe shall comply with the following.

1. Joints for hubless cast iron soil pipe shall be made with an approved gasket and stainless steel retaining sleeve.

2. Stainless steel couplings and gaskets complying with standards listed in Table 303 of this code shall have identifying markers to indicate compliance.

3. Installation of the hubless cast iron soil pipe system shall be in accordance with CISPI 310 or the manufacturer's recommendation.

F. Borosilicate Glass Pipe. Joints for borosilicate glass pipe shall comply with the following.

1. Glass to glass connections shall be made with a bolted compression type stainless steel (300 series) coupling with contoured acid-resistant elastomer compression ring and a fluorocarbon polymer inner seal ring.

2. Joints between glass pipe and other types of piping material shall be made with adapters having a tetrafluoroethylene (TFE) seal and according to manufacturer's recommendations.

3. Caulked joints shall conform with §709.B of this code except that acid resistant rope and acid proof cement may be used.

G. Joints for Ductile-Iron Gravity Sewer Pipe (bell and spigot). Joints in ductile-iron gravity sewer pipe shall be of the push-on joint type using a single oil resistant gasket joint. The gasket and the annular recess in the bell end of the pipe will be designed and shaped so that the gasket is locked in place against displacement. The oil resistant gaskets shall conform to AWWA C111 or ANSI A21.11 and shall comply with the performance requirements of the standard.

AUTHORITY NOTE: Promulgated in accordance with R.S. 40:4(A)(7) and R.S. 40:5(2)(3)(7)(9)(16)(17)(20).

HISTORICAL NOTE: Promulgated by the Department of Health and Hospitals, Office of Public Health, LR 38:2849 (November 2012).

§711. Use of Joints

A. Clay Sewer Pipe. Joints in vitrified clay pipe or between such pipe and other pipe shall be formed as provided in §313.D, §313.E, or §711.D of this code.

B. Concrete Sewer Pipe (for storm drains only). Joints in concrete sewer pipe or between such pipe and metal pipe shall be formed as prescribed in §313.D, §313.E, or §711.D of this code.

C. Cast Iron Soil Pipe. Joints in cast iron pipe shall be either caulked, positive-seal elastomeric compression gasket or a neoprene gasket and stainless steel retaining sleeve, as provided in §§313.B, 709.B, 709.D, and 709.E of this code.

D. PVC Transition Fittings for Dissimilar Pipe in Building Sewers. PVC transition fittings for dissimilar pipe in building sewers shall comply with the following.

1. PVC transition fittings for dissimilar pipe in building sewers shall be installed according to manufacturers' instructions.

2. Joint Sealer Adapter—to adapt cast iron, plastic, fiber, asbestos cement, clay or copper pipe to all makes of dissimilar drain pipes with PVC joint.

3. Flexible Coupling—to adapt any two of the following pipe of the same outside diameter or reducing sizes of any combination of two: clay, concrete, cast iron, steel, copper (DWV), asbestos cement, fiber drain and sewer pipe, plastic drain and sewer pipe.

4. Solvent Cemented Transition Joints Between Acrylonitrile-Butadiene-Styrene (ABS) and Poly Vinyl Chloride (PVC). Solvent cements for use in transition joints between building drains and building sewers (non-pressure applications only) shall comply with ASTM D 3138.

E. Ductile Iron Pipe without Push-On-Joints (plain end). Joints in ductile iron pipe for the building sewer without push-on-joints shall be made with a flexible coupling assembly in accordance with §313.D of this code or in accordance with the manufacturer's instructions.

AUTHORITY NOTE: Promulgated in accordance with R.S. 40:4(A)(7) and R.S. 40:5(2)(3)(7)(9)(16)(17)(20).

HISTORICAL NOTE: Promulgated by the Department of Health and Hospitals, Office of Public Health, LR 38:2850 (November 2012).

§713. Connections between Drainage Piping and Fixtures

A. Connections between drainage piping and floor outlet plumbing fixtures shall be made by means of an approved flange which is attached to the drainage piping in accordance with the provisions of this Chapter. The 4 x 3 closet flange shall be attached to the outside diameter and not to the inside diameter of the drainage piping. The floor flange shall be set on and securely anchored to the building structure.

B. Connections between drainage piping and wall hung water closets shall be made by means of an approved extension nipple or horn adapter.

C. The connection shall be bolted to the flange or carrier using corrosion resisting bolts, screws or assemblies recommended by the manufacturer.

D. An approved gasket, washer, or setting compound shall be used between the fixture and the connection. Use of commercial putty or plaster shall be prohibited as the setting compound.

AUTHORITY NOTE: Promulgated in accordance with R.S. 40:4(A)(7) and R.S. 40:5(2)(3)(7)(9)(16)(17)(20).

HISTORICAL NOTE: Promulgated by the Department of Health and Hospitals, Office of Public Health, LR 38:2850 (November 2012).

§715. Prohibited Joints and Connections

A. Drainage System. Any fitting or connection which has an enlargement, chamber, or recess with a ledge, shoulder, or reduction of pipe area, that offers an obstruction to flow through the drain, is prohibited, except as stated in §727 of this code.

B. Prohibited Fittings or Connections. Fittings or connections that offer abnormal obstruction to flow shall not be used. The enlargement of a 3-inch closet bend or stub to 4 inches shall not be considered an obstruction.

AUTHORITY NOTE: Promulgated in accordance with R.S. 40:4(A)(7) and R.S. 40:5(2)(3)(7)(9)(16)(17)(20).

HISTORICAL NOTE: Promulgated by the Department of Health and Hospitals, Office of Public Health, LR 38:2850 (November 2012).

§717. Cleanouts

A. Material and Design. The bodies of cleanout ferrules shall conform in thickness to that required for pipe and fittings of the same material, and they shall extend not less than 1/4-inch (6.35 mm) above the hub. For new work, the cleanout plug shall be of heavy brass or plastic not less than 1/8-inch (3.18 mm) thick and shall be provided with a raised nut or a recessed socket for removal. Both ferrule and plug shall have ASME standard tapered pipe threads. Heavy lead plugs may be used for repairing a cleanout where necessary. Nylon plastics may be used as an alternate material.

B. Location. The location of cleanouts shall comply with the following:

1. Each horizontal drainage pipe shall be provided with a cleanout at the upstream end of the pipe and in changes of direction over 45° (0.785 rad).

a. Exceptions. The following plumbing arrangements are acceptable in lieu of the upstream cleanout:

i. "P" traps connected to the drainage piping with slip joints or ground joint connections;

ii. "P" traps into which floor drains, shower drains or tub drains with removable strainers discharge;

iii. "P" traps into which the straight through type waste and overflow discharge with the overflow connecting to the branch of the tee;

iv. "P" traps into which residential washing machines discharge;

v. test tees or cleanouts in a vertical pipe above the flood-level rim of the fixtures that the horizontal pipe serves and not more than 4-feet (1219 mm) above the finish floor;

f. cleanout within 6-feet (1829 mm) of the junction of the building drain and the building sewer which may be rodded both ways; and,

g. water closets for the water closet fixture branch only.

2. Each building drain shall be provided with a cleanout within 6-feet (1829 mm) of the junction of the building drain and building sewer.

3. Cleanouts when installed in accordance with §717.B.2 of this code may be either outside the building or when inside the building they shall be above the flood-level rim of the fixtures that the horizontal pipe serves when installed on a soil or waste stack.

4. In addition to the upstream cleanout and the cleanout of the junction of the building drain and building

sewer, cleanouts shall be located along the horizontal piping so that:

a. In pipe 3-inch nominal diameter or less, cleanouts shall be located at not more than 50 ft (15.2 m) intervals; and,

b. In pipe 4 inches nominal diameter through 6 inches nominal diameter, cleanouts shall be located at not more than 80 ft (24.4 m) intervals.

C. Concealed Piping. Cleanouts on concealed piping or piping under a floor slab or piping in a crawl space of less than 24 inches (610 mm) or a plenum of any depth shall be extended through and terminate flush with the finished wall, floor or grade_(G) or may be extended to the outside of the building. Where it is necessary to conceal a cleanout or to terminate a cleanout in an area subject to vehicular traffic, the covering plate, access door or cleanout shall be of the approved type designed and installed for this purpose.

D. Direction of Flow. Cleanouts shall be installed to permit cleaning in the direction of flow. Line cleanouts which may be rodded both ways shall be used whenever practical.

E. Use for New Fixtures Prohibited. Cleanout plugs shall not be used for the installation of new fixtures or floor drains, except where approved in writing by the plumbing official and where another cleanout of equal access and capacity is provided.

F. Trap Cleanouts. Cleanouts for traps shall comply with the following.

1. Each fixture trap, except those cast integrally or in combination with fixtures in which the trap seal is accessible, or except when a portion of the trap is readily removable for cleaning purposes, shall have an accessible brass trap screw of ample size. Cleanout plugs or caps shall be watertight and gastight. Nylon plastics may be used as an alternate material.

2. Cleanouts on the seal of a trap shall be made tight with threaded cleanout plug and approved washer. Where glass traps are required, slip joints or couplings must have a tetrafluoroethylene (TFE) seal.

G. Manholes. Sewer manholes shall be waterproofed, constructed of poured-in-place concrete or precast concrete pipe sections conforming to ASTM C 478. Bottoms shall be concrete poured on stabilized soil or aggregate subbase with inside surfaces sloped a minimum of 2 inches per foot to the pipe flow channel. All pipe connections and joints shall be sealed with approved waterstop or gasket materials and grouted. Manhole top frames and covers shall be Class 30 gray cast iron conforming to ASTM A 48/A 48M, machined for proper fit of covers in frame, coated with coal-tar pitch varnish and not less than 93 percent of the specified weight for each casting. Covers shall have the word "SEWER" cast in large letters. Similar, sealed covers with gaskets and cap screws or bolts shall be used where subject to flooding. See Figure 7 in Section 1807 of this code.

AUTHORITY NOTE: Promulgated in accordance with R.S. 40:4(A)(7) and R.S. 40:5(2)(3)(7)(9)(16)(17)(20).

HISTORICAL NOTE: Promulgated by the Department of Health and Hospitals, Office of Public Health, LR 38:2851 (November 2012).

§719. Size of Cleanouts

A. Pipes Less Than 8-inch Nominal Size. For pipes less than 8-inch nominal size, cleanouts shall be the same nominal size as the pipe to which they are connected.

1. Exceptions

a. Pipes larger than 4-inch nominal size may be served by a 4-inch cleanout;

b. A 1 1/4-inch "P" trap connected with slip joints or ground joint connections may be used to serve 1 1/2-inch pipe; and,

c. A 1 1/2-inch "P" trap connected with slip joints or ground joint connections may be used to serve a 2-inch pipe.

B. Pipes 8 Inches and Larger Nominal Size. For pipes 8 inches and larger nominal size, cleanouts shall comply with the following.

1. Building drains may be served with a 4-inch cleanout.

2. For building sewers 8 inches and larger, manholes shall be provided and located at each change in direction and at intervals of not more than 400 ft (121.9 m). Manholes and manhole covers shall conform to §717.G of this code.

3. Building drains 8-inch nominal size and larger shall have cleanouts located at intervals of not more than 100 ft (30.5 m) and at each change of direction over 45° (0.785 rad).

AUTHORITY NOTE: Promulgated in accordance with R.S. 40:4(A)(7) and R.S. 40:5(2)(3)(7)(9)(16)(17)(20).

HISTORICAL NOTE: Promulgated by the Department of Health and Hospitals, Office of Public Health, LR 38:2851 (November 2012).

§721. Cleanout Clearances

A. Small Pipe. Cleanouts smaller than 3-inches shall be so installed that there is a clearance of not less than 12 inches (305 mm) for the purpose of rodding.

B. Large Pipe. Cleanouts on 3-inch or larger pipes shall be so located that there is a clearance of not less than 18 inches (457 mm) for the purpose of rodding.

AUTHORITY NOTE: Promulgated in accordance with R.S. 40:4(A)(7) and R.S. 40:5(2)(3)(7)(9)(16)(17)(20).

HISTORICAL NOTE: Promulgated by the Department of Health and Hospitals, Office of Public Health, LR 38:2852 (November 2012).

§723. Fixture Units

A. Values for Fixtures. Fixture unit values as given in Table 723.A of this code below designate the relative load weight of different kinds of fixtures which shall be employed in estimating the total load carried by a soil or

PUBLIC HEALTH—SANITARY CODE

waste pipe and shall be used in connection with the tables of sizes for soil, waste, and vent pipes for which the

permissible load is given in terms of fixture units.

Table 723.A Fixture Units Per Fixture or Group				
Fixture Type	Private	Public	Assembly	Minimum Size of Trap (in)
Bathroom group consisting of a 1.6 GPF gravity tank, flushometer tank, or flushometer valve water closet, a small P.O. 1 1/4 lavatory, and a bathtub or shower or a combination bath/shower	6.0	7.0	9.0	
Bathroom group consisting of a 1.6 GPF gravity tank, flushometer tank, or flushometer valve water closet, a large P.O. 1 1/2 lavatory, and a bathtub or shower or a combination bath/shower	7.0	8.0	10.0	
Bathroom group consisting of a greater than 1.6 GPF gravity tank or flushometer valve water closet, a small P.O. 1 1/4 lavatory, and a bathtub or shower or a combination bath/shower	7.0	9.0	11.0	
Bathroom group consisting of a greater than 1.6 GPF gravity tank or flushometer valve water closet, a large P.O. 1 1/2 lavatory, and a bathtub or shower or a combination bath/shower	8.0	10.0	12.0	
Bathtub (with or without overhead shower) or whirlpool attachments (a showerhead over a bathtub or whirlpool bathtub attachments does not increase the fixture value)	2.0	2.0		2
Bidet	1.0			1 1/4
Bidet	2.0	2.0		1 1/2
Clothes Washer, domestic, standpipe	3.0	3.0	3.0	2
Clothes Washer, commercial, pumped waste		See §§723.B and 723.C of this code for methods of computing unit value of fixtures not listed in this table or for rating of devices with intermittent flows.		
Clothes Washer, commercial, gravity waste		See §§723.B and 723.C of this code for methods of computing unit value of fixtures not listed in this table or for rating of devices with intermittent flows.		
Combination sink and tray	3.0	3.0	3.0	1 1/2
Combination sink and tray with food disposal unit	4.0	4.0	4.0	Separate traps 1 1/2
Dental unit or cuspidor		1.0	1.0	1 1/4
Dental lavatory		1.0		1 1/4
Dishwashing machine, domestic (See §§723.B and 723.C of this code for methods of computing unit value of fixtures not listed in this table or for rating of devices with intermittent flows)	2.0	2.0	2.0	1 1/2
Dishwashing machine, commercial		See §§723.B and 723.C of this code for methods of computing unit value of fixtures not listed in this table or for rating of devices with intermittent flows		
Drinking Fountain	0.5	0.5	1.0	1 1/4
Floor drains (Size of floor drain trap shall be determined by the area of the floor to be drained; therefore, for larger trap sizes, see Table 723.B of this code to determine the applicable fixture unit value. If the floor drain receives continuous or semi-continuous flows, utilize §723.C of this code to determine the fixture unit value)	1.0	2.0	2.0	2
Hub drains (When the hub drain is utilized as a direct or an indirect waste receptor for a fixture, any fixture unit value otherwise assigned to the particular fixture draining into the hub drain shall be used. If the hub drain receives continuous or semi-continuous flows, utilize §723.C of this code to determine the fixture unit value)	1.0	2.0	2.0	2
Kitchen sink, domestic	2.0	2.0		1 1/2
Kitchen sink, domestic with food waste grinder and/or dishwasher	3.0	3.0		1 1/2
Lavatory (Lavatories with 1 1/4 or 1 1/2-inch trap have the same load value; larger punch out (P.O.) plugs for the drain hole have greater flow rate)	1.0	1.0	1.0	Small P.O. 1 1/4
Lavatory (Lavatories with 1 1/4 or 1 1/2-inch trap have	2.0	2.0	2.0	Large P.O. 1 1/2

Title 51, Part XIV

Table 723.A Fixture Units Per Fixture or Group				
Fixture Type	Private	Public	Assembly	Minimum Size of Trap (in)
the same load value; larger punch out (P.O.) plugs for the drain hole have greater flow rate)				
Lavatory, barber, beauty parlor	2.0	2.0	2.0	1 1/2
Lavatory, surgeon's		2.0		1 1/2
Laundry tray (1 or 2 compartments)	2.0	2.0	2.0	1 1/2
Mobile/Manufactured Home, trailer trap	15.0			4
Shower stall, domestic	2.0	2.0	2.0	2
Showers (group) per head (See §§723.B and 723.C of this code for methods of computing unit value of fixtures not listed in this table or for rating of devices with intermittent flows)		3.0	4.0	3
Sinks				
Bar, private, above grade	1.0			1 1/2
Clinical, 1.6 GPF		6.0	6.0	3
Clinical, greater than 1.6 GPF		8.0	8.0	3
Curbed Cleaning Facility		3.0	3.0	3
Floor, food service		4.0	4.0	2
Floor, bar service		2.0	2.0	2
Floor, other uses (See §§723.B and 723.C of this code for methods of computing unit value of fixtures not listed in this table or for rating of devices with intermittent flows)				
Pot, scullery, etc. (See §§723.B and 723.C of this code for methods of computing unit value of fixtures not listed in this table or for rating of devices with intermittent flows)		4.0	4.0	1 1/2
Service (trap standard)		3.0	3.0	3
Service ("p" trap)		2.0	2.0	2
Surgeon's		3.0	3.0	1 1/2
Wash, (circular or multiple), normally used for hand washing, each set of faucets		2.0	3.0	Nominal 1 1/2
Wash, (circular or multiple), normally used for hand washing, no faucets (e.g., Superdome hand wash sinks in public toilet rooms)		2.0	3.0	Nominal 1 1/2
Travel Trailer, trailer trap	6.0			4
Urinals				
Exposed trap	2.0	2.0	5.0	1 1/2
Pedestal, siphon jet, blowout, greater than 1.0 GPF	6.0	8.0	10.0	Trap size shall be consistent with fixture type as defined in industry standards
Wall lip, integral trap, 1.0 GPF	2.0	2.0	5.0	Trap size shall be consistent with fixture type as defined in industry standards
Wall lip, integral trap, greater than 1.0 GPF	2.0	2.0	6.0	Trap size shall be consistent with fixture type as defined in industry standards
Washout, greater than 1.0 GPF	2.0	4.0	6.0	Trap size shall be consistent with fixture type as defined in industry standards
Water Closets,				
1.6 GPF Gravity Tank	3.0	4.0	6.0	Trap size shall be consistent with fixture type as defined in industry standards
1.6 GPF Flushometer Tank	3.0	4.0	6.0	Trap size shall be consistent with fixture type as defined in industry standards
1.6 GPF Flushometer Valve	3.0	4.0	6.0	
greater than 1.6 GPF Gravity Tank	4.0	6.0	8.0	Trap size shall be consistent with fixture type as defined in industry standards
greater than 1.6 GPF Flushometer Valve	4.0	6.0	8.0	Trap size shall be consistent with fixture type as defined in industry standards

B. Fixtures Not Listed. Fixtures not listed in Table 723.A of this code above shall be estimated in accordance with Table 723.B of this code below.

Fixture Drain or Trap Size (in)	Fixture-Unit Value
1 1/4 and smaller	1
1 1/2	2
2	3
3	5
4	6

C. Values for Continuous Flow. For a continuous or semi continuous flow into a drainage system, such as from a pump, pump ejector, air conditioning equipment, or similar device, 2 fixture units shall be allowed for each gallon per minute (gpm) of flow (31.7 fixture units for each liter per second of flow).

D. Air Conditioning Units. The condensate or waste from an air conditioning unit shall be classified as a plumbing fixture only if connected to the plumbing system.

AUTHORITY NOTE: Promulgated in accordance with R.S. 40:4(A)(7) and R.S. 40:5(2)(3)(7)(9)(16)(17)(20).

HISTORICAL NOTE: Promulgated by the Department of Health and Hospitals, Office of Public Health, LR 38:2852 (November 2012).

§725. Drainage System Sizing

A. Maximum Fixture Unit Load. The maximum number of fixture units that may be connected to a given size of building sewer, building drain, or horizontal branch of the building drain shall be determined using Table 725.A.1 of this code below. The maximum number of fixture units that may be connected to a given size vertical soil or waste stack, or a horizontal branch connecting to a vertical soil or waste stack, is given in Table 725.A.2 of this code.

Maximum Number of Fixture-Units that may be Connected to Any Portion of the Building Drain or the Building Sewer (Includes branches of the building drain. The minimum size of any building drain serving a water closet shall be 3". No building sewer shall be less than 4 inches in size)				
Diameter of Pipe (in.)	Fall in Inches Per Foot			
	1/16	1/8	1/4	1/2
2	-	-	21	26
3	-	20 (not over two water closets)	27 (not over two water closets)	36 (not over two water closets)
4	-	180	216	250
5	-	390	480	575
6	-	700	840	1,000
8	1,400	1,600	1,920	2,300
10	2,500	2,900	3,500	4,200
12	3,900	4,600	5,600	6,700
15	7,000	8,300	10,000	2,000

Diameter of Pipe (in.) (The minimum size of any branch or stack serving a water closet shall be 3")	Any Horizontal Fixture Branch (Does not include branches of the building drain. 50 percent less for battery vented fixture branches, no size reduction permitted for battery vented branches throughout the entire branch length.)	Maximum Number of Fixture Units that May be Connected to:		
		One Stack of 3 Stories or 3 Intervals Maximum	More Than 3 Stories in Height	
			Total for Stack	Total at One Story or Branch Interval
1 1/4	1	2	2	1
1 1/2	3	4	8	2
2	6	10	24	6
3	20 (not over two water closets)	30 (not over six water closets)	60 (not over six water closets)	16 (not over two water closets)
4	160	240	500	90
5	360	540	1100	200
6	620	960	1900	350
8	1400	2200	3600	600
10	2500	3800	5600	1000
12	3900	6000	8400	1500
15	7000	---	---	---

B. Minimum Size of Soil and Waste Stacks. No soil or waste stack shall be smaller than the largest horizontal branch connected thereto except that a 4x3 water closet connection shall not be considered as a reduction in pipe size. The soil or waste stack shall run undiminished in size from its connection to the building drain to its connection to the stack vent.

C. Future Fixtures. When provision is made for the future installation of fixtures, those provided for shall be considered in determining the required sizes of drain pipes. Construction to provide for such future installation shall be terminated with a plugged fitting or fittings at the stack so as to form no dead end.

D. Underground Drainage Piping. Any portion of the drainage system installed underground or below a basement or cellar shall not be less than 2-inch diameter. In addition, any portion of the drainage system installed underground which is located upstream from a grease trap or grease interceptor as well as the underground horizontal branch receiving the discharge there from shall not be less than 3-inch diameter.

AUTHORITY NOTE: Promulgated in accordance with R.S. 40:4(A)(7) and R.S. 40:5(2)(3)(7)(9)(16)(17)(20).

HISTORICAL NOTE: Promulgated by the Department of Health and Hospitals, Office of Public Health, LR 38:2854 (November 2012).

§727. Offsets in Drainage Piping in Buildings of Five Stories or More

A. Offsets of 45 Degrees or Less. An offset in a vertical stack, with a change of direction of 45° (0.785 rad) or less from the vertical, may be sized as a straight vertical stack. In case a horizontal branch connects to the stack within 2 ft (610 mm) above or below the offset, a relief vent shall be installed in accordance with §931.C of this code, except that when the offset stack is sized for a building drain (see Column 5 in Table 725.A.1 of this code) the relief vent may be omitted.

B. Above Highest Branch. An offset above the highest horizontal branch is an offset in the stack vent and shall be considered only as it affects the developed length of the vent.

C. Below Lowest Branch. In the case of an offset in a soil or waste stack below the lowest horizontal branch, no change in diameter of the stack because of the offset shall be required if it is made at an angle of not greater than 45° (0.785 rad) from the vertical. If such an offset is made at an angle greater than 45° (0.785 rad) from the vertical, the required diameter of the offset and the stack below it shall be determined as for a building drain (See Table 725.A.1 of this code).

D. Offsets of More Than 45 Degrees. A stack with an offset of more than 45° (0.785 rad) from the vertical shall be sized as follows:

1. The portion of the stack above the offset shall be sized as for a regular stack based on the total number of fixture units above the offset;

2. The offset shall be sized as for a building drain (See Column 5 in Table 725.A.1 of this code);

3. The portion of the stack below the offset shall be sized as for the offset or based on the total number of fixture units on the entire stack, whichever is larger (See Column 4 in Table 725.A.2 of this code); and,

4. A relief vent for the offset shall be installed as provided in Chapter 9 of this code and in no case shall a horizontal branch connect within the offset or within 2 feet (610 mm) above or below the offset.

E. Omission of Offset Reliefs. Offset relief vents required by §727.D of this code may be omitted by sizing the stack and its offset one pipe size larger than required for a building drain (See Column 5 in Table 725.A.1 of this code) but in no case shall the entire stack and offset be of less cross-sectional area than that required for a straight stack plus the area of an offset relief vent as provided in §931.B of this code. Omission of relief vents in accordance with this Subsection shall not constitute approval of horizontal branch connections within the offset or within 2 feet (610 mm) above or below the offset. See §727.A of this code for offsets of 45° (0.785 rad) or less.

AUTHORITY NOTE: Promulgated in accordance with R.S. 40:4(A)(7) and R.S. 40:5(2)(3)(7)(9)(16)(17)(20).

HISTORICAL NOTE: Promulgated by the Department of Health and Hospitals, Office of Public Health, LR 38:2855 (November 2012).

§729. Waste Stacks Serving Kitchen Sinks

A. In a one or two family dwelling only in which the waste stack or vent receives the discharge of a kitchen sink and also serves as a vent for fixtures connected to the horizontal portion of the branch served by the waste stack, the minimum size of the waste stack up to the highest sink branch connection shall be 2-inch diameter. Above that point the size of the stack shall be governed by the total number of fixture units vented by the stack.

1. Note: The requirement/allowance under §729.A of this code is only applicable if the requirement of §905.C.1 of this code has been satisfied elsewhere on the building drain. When the requirement of §905.C.1 of this code has not been satisfied elsewhere on the building drain, then the entire waste stack and vent mentioned in §729.A of this code shall be sized to conform to §905.C.1 of this code.

AUTHORITY NOTE: Promulgated in accordance with R.S. 40:4(A)(7) and R.S. 40:5(2)(3)(7)(9)(16)(17)(20).

HISTORICAL NOTE: Promulgated by the Department of Health and Hospitals, Office of Public Health, LR 38:2855 (November 2012).

§731. Sumps and Ejectors

A. Building Drains below Sewer. Building drains which cannot be discharged to the sewer by gravity flow shall be discharged into a tightly covered and vented sump from which the liquid shall be lifted and discharged into the building gravity drainage system by automatic pumping equipment or by any equally efficient method approved by the plumbing official.

B. Check and Gate Valve Required. A check valve and a gate valve shall be installed in the pump or ejector discharge piping between the pump or ejector and the gravity drainage system. Such valve shall be accessibly located above the sump cover required by §731.A of this code, or when the discharge pipe from the ejector is below grade_(G), the valves may be accessibly located outside the sump below grade_(G) in an access pit with removable access cover.

C. Sewage Ejector Sump Construction. Sumps may be constructed of cast iron or monolithically poured reinforced concrete. When concrete sumps are used, a cover attachment ring shall be embedded in the concrete in such a way as to be watertight and gastight. The attachment ring shall be designed to fit the sump cover and allow a gastight and watertight seal to be made. Other engineered sump construction and materials may be accepted by the plumbing official when designed to be watertight and gastight and otherwise meet the requirements of this Section.

D. Venting. The system of drainage piping below the sewer level shall be installed and vented in a manner similar to that of the gravity system.

E. Duplex Equipment. Sumps receiving the discharge of more than six water closets shall be provided with duplex pumping equipment.

F. Vent Sizes. Building sump vents shall be sized in accordance with Table 937.B of this code but shall in no case be sized less than 1 1/2 inches.

G. Separate Vents. Vents from pneumatic ejectors or similar equipment shall be carried separately to the open air as a vent terminal (see §927.A of this code).

H. Connections. Direct connection of a steam exhaust, blowoff, or drip pipe shall not be made with the building drainage system. Waste water when discharged into the building drainage system shall be at a temperature not higher than 140°F (60°C). When higher temperatures exist, proper cooling methods shall be provided.

I. Pumping Station. Pumping stations shall comply with the following.

1. A pumping system shall include the sump pump, sump pit and discharge piping as specified below:

a. Sump Pump. An automatic water pump for the removal of drainage from a sump, pit or low point in a residential, commercial or industrial property. Capacity and head shall be appropriate to anticipated use requirements.

b. Sump Pit. The sump pit shall be not less than 18 inches (457 mm) diameter and 24 inches (610 mm) deep, unless approved by the plumbing official. The pit shall be accessible and located such that all drainage flows into the pit due to gravity. The sump pit may be constructed of tile, concrete, steel, plastic or other approved materials. The pit bottom shall be solid and provide permanent support for the pump. The sump pit shall be fitted with a removable cover adequate to support anticipated loads in the area of use and to prevent refuse from entering the pit.

c. Discharge piping. Discharge piping shall meet the requirements of §731.B of this code.

2. Electrical service outlet when required shall meet the requirements of the NFPA 70 or local codes.

3. Sumps which receive and discharge liquid wastes or raw sewage from plumbing fixtures shall meet the applicable requirements of §731.C of this code.

J. Maximum Effluent Level. The effluent level control, etc., shall be adjusted and maintained to at all times prevent the effluent in the sump from rising to within 2 inches (51 mm) of the invert of the gravity drain inlet into the sump.

K. Ejector Connection to the Drainage System. Pumps when connected to the drainage system shall connect to the building sewer or shall connect to a wye fitting in the building drain a minimum of 10 ft (3048 mm) from the base of any soil stack, waste stack or fixture drain.

L. Macerating Systems. Macerating toilet systems shall comply with ASME A 112.3.4 and shall be installed per the manufacturer's instructions. The outlet piping from the grinder pump shall not be less than 3/4-inch and shall be fitted with a check valve and a full-flow gate or ball valve.

AUTHORITY NOTE: Promulgated in accordance with R.S. 40:4(A)(7) and R.S. 40:5(2)(3)(7)(9)(16)(17)(20).

HISTORICAL NOTE: Promulgated by the Department of Health and Hospitals, Office of Public Health, LR 38:2856 (November 2012).

§733. Repairs to Drainage System via Re-route

A. In the case where it is determined that there is a broken underground drain line including, but not limited to, broken drain lines under the slab of a building, and a drain line re-route is performed, the existing broken underground drain line shall be cut or otherwise disconnected from the entire drainage system. At the point of such cutting or disconnection, the entire circumference of the existing pipe which remains connected to the drainage system shall have a wall thickness of not less than 1/8-inch. The existing pipe which remains connected to the drainage system shall be sealed watertight and gastight using approved plumbing materials and joining/jointing methods, e.g., properly install an approved cap, plug, or cleanout on the cut or disconnected pipe.

AUTHORITY NOTE: Promulgated in accordance with R.S. 40:4(A)(7) and R.S. 40:5(2)(3)(7)(9)(16)(17)(20).

HISTORICAL NOTE: Promulgated by the Department of Health and Hospitals, Office of Public Health, LR 38:2856 (November 2012).

§735. Additional Provisions for Sanitary Drainage

A. Additional provisions for sanitary drainage are found in the following:

1. LAC 51:XIV.705.H, Installation of Building Sewers;

2. LAC 51:XIV.Chapter 13, Medical Facilities Plumbing Systems;

3. LAC 51:XIV.Chapter 15, Travel Trailers and Travel Trailer Parks;

4. LAC 51:XIV.Chapter 16, Mobile/Manufactured Homes and Mobile/Manufactured Home Parks; and

5. LAC 51:XIV.Chapter 17, Sewerage System Regulations.

AUTHORITY NOTE: Promulgated in accordance with R.S. 40:4(A)(7) and R.S. 40:5(2)(3)(7)(9)(16)(17)(20).

HISTORICAL NOTE: Promulgated by the Department of Health and Hospitals, Office of Public Health, LR 38:2856 (November 2012).

Chapter 8. Indirect and Special Wastes

§801. General

A. Scope. The provisions of this Chapter shall govern the materials, design, construction, and installation of indirect and special wastes systems.

B. Tests. The indirect and special waste system shall be tested in accordance with §319 of this code.

AUTHORITY NOTE: Promulgated in accordance with R.S. 40:4(A)(7) and R.S. 40:5(2)(3)(7)(9)(16)(17)(20).

HISTORICAL NOTE: Promulgated by the Department of Health and Hospitals, Office of Public Health, LR 38:2857 (November 2012).

§803. Material and Size

A. The material and size of indirect waste piping shall be in accordance with the provisions applicable to sanitary drainage piping in Chapter 7 of this code. Acid and chemical indirect waste pipes shall be of materials unaffected by the discharge of such wastes.

AUTHORITY NOTE: Promulgated in accordance with R.S. 40:4(A)(7) and R.S. 40:5(2)(3)(7)(9)(16)(17)(20).

HISTORICAL NOTE: Promulgated by the Department of Health and Hospitals, Office of Public Health, LR 38:2857 (November 2012).

§805. Indirect Waste Methods

A. Air gap (drainage system). The air gap (drainage system) between the indirect waste and the building drainage system shall be at least twice the diameter of the effective opening of the indirect waste pipe, but in no case less than 2 inches (51 mm), and shall be provided by extending the indirect waste pipe to an open, accessible floor sink, service sink, floor drain, hub drain or other suitable fixture which is properly trapped and vented. The indirect waste pipe shall terminate a sufficient distance above the flood-level rim of the sink or receptor to provide the minimum required air gap and shall be installed in accordance with other applicable Sections of this code.

B. Air break (drainage system). The air break (drainage system) between the indirect waste and the building drainage system shall be installed such that the level of the lowest outlet located on the fixture, device, appliance or apparatus (to which the indirect waste pipe connects) is above the flood-level rim of the receiving sink or other receptor by a vertical distance of at least twice the diameter of the effective opening of the indirect waste pipe, but in no case less than 2 inches (51 mm). In addition, the indirect waste pipe shall terminate below the flood-level rim of the receiving sink or other receptor a distance equal to not more than one-half (1/2) the diameter of the effective opening of the indirect waste pipe.

AUTHORITY NOTE: Promulgated in accordance with R.S. 40:4(A)(7) and R.S. 40:5(2)(3)(7)(9)(16)(17)(20).

HISTORICAL NOTE: Promulgated by the Department of Health and Hospitals, Office of Public Health, LR 38:2857 (November 2012).

§807. Indirect Waste Connections

A. Food Handling. Establishments engaged in the storage, preparation, selling, serving, processing or other handling of food shall have the waste piping from all food handling equipment indirectly connected to the drainage system through an air gap (drainage system) or air break (drainage system) as specified in §805 of this code. Food handling equipment includes but is not limited to the following: any sink where food is cleaned, peeled, cut up, rinsed, battered, defrosted or otherwise prepared or handled; potato peelers; ice cream dipper wells; refrigerators; freezers; walk-in coolers or freezers; ice boxes; ice making machines; fountain type drink dispensers; rinse sinks; cooling or refrigerating coils; laundry washers; extractors;

steam tables; steam kettles; egg boilers; coffee urns; or similar equipment.

1. Exception. An air gap (drainage system) is the only acceptable method of indirectly connecting any food handling equipment wherein the indirect waste pipe may be under a vacuum.

B. Commercial Dishwashing Machines. Commercial dishwashing machines shall be indirectly connected.

C. Connections. The following types of connections shall be indirect waste connections in accord with the specifications stated below.

1. Water Supply Connections. Drains, overflows or relief lines from the water distribution system shall waste into an indirect waste receptor through an air gap (water distribution).

2. Air Conditioning Unit Connections. Indirect waste connections shall be provided for drains, overflows, or relief lines from air conditioning units.

D. Sterile Materials. Appliances, devices, or apparatus such as stills, sterilizers, and similar equipment, requiring water and waste connections and used for sterile material, shall be indirectly connected or provided with an air gap (drainage system) between the trap and the appliance.

E. Drips. Appliances, devices, or apparatus not regularly classed as plumbing fixtures but which have drips or drainage outlets shall be drained by indirect waste pipes discharging into an open receptacle as provided in §805 of this code.

F. Cleanliness. The sink or receptor receiving indirect wastes shall be water-supplied if the waste stream contains or is expected to contain a sufficient amount of organic matter capable of causing odors or otherwise causing a nuisance due to an insufficient dilution of the waste material discharged into the sink or receptor.

G. Receptors. Waste/plumbing receptors serving indirect waste pipe discharges shall meet the following requirements.

1. Installation. Waste receptors serving indirect waste pipes shall not be installed in any toilet room, nor in any inaccessible or unventilated space such as a closet or storeroom.

2. Strainers and Baskets. Every indirect waste receptor receiving discharge containing particles that would clog the receptor shall be equipped with a basket or other device which shall prevent passage into the drainage system of solids 1/2-inch (12.7 mm) or larger in size. The basket or device shall be removable for cleaning purposes.

3. Splashing. All plumbing receptors receiving the discharge of indirect waste pipes shall be of such shape and capacity as to prevent splashing or flooding. No plumbing fixture which is used for domestic or culinary purposes shall be used to receive the discharge of an indirect waste pipe.

H. Clear Water Wastes. Water lifts, expansion tanks, cooling jackets, sprinkler systems, drip or overflow pans or

similar devices which waste clear water only, shall discharge into the building drainage system through an indirect waste.

I. Hot Water Drainage. A steam pipe shall not connect directly to any part of a drainage system, nor shall any water above 140°F (60°C) be discharged directly into any part of a drainage system.

J. Drinking Fountains. Drinking fountains may be installed with indirect wastes.

K. Swimming Pools. Piping carrying waste water from swimming or wading pools, including pool drainage, backwash from filters, water from scum gutter drains or floor drains which serve walks around pools, shall be installed as an indirect waste utilizing a circulation pump, if necessary, when indirect waste line is below the sewer *grade(s)*.

L. Residential Washing Machines (clothes washers). All residential washing machines shall connect to the building drainage system via an individual indirect waste pipe for each machine using one of the indirect waste methods specified in §805 of this code.

1. Any machines which discharge by gravity shall discharge into an adequately sized individual receptor, such as a floor sink. Such receptor/floor sink shall be properly trapped, vented, and directly connected to the drainage system.

M. Commercial Laundry Machines. All commercial laundry washing machines shall connect to the building drainage system via an individual indirect waste pipe for each machine using one of the indirect waste methods specified in §805 of this code.

1. Any machines which discharge by gravity shall individually discharge into an adequately sized receptor trough/pit or adequately sized individual receptors, such as floor sinks. Such receptor trough/pit or floor sinks shall be properly trapped, vented, and directly connected to the drainage system.

AUTHORITY NOTE: Promulgated in accordance with R.S. 40:4(A)(7) and R.S. 40:5(2)(3)(7)(9)(16)(17)(20).

HISTORICAL NOTE: Promulgated by the Department of Health and Hospitals, Office of Public Health, LR 38:2857 (November 2012).

§809. Limitations

A. The following limitations/requirements shall apply to indirect waste pipes.

1. Indirect waste piping exceeding 2 ft (610 mm) long shall be trapped.

2. The maximum length of the indirect waste to indirect waste receptor shall not exceed 15-feet (4527 mm). Should an indirect waste pipe exceed 15 feet in length, a local vent shall be provided at a maximum of every 15 feet in length.

B. Cleaning. Indirect waste piping shall be so installed as to permit ready access for flushing and cleansing.

AUTHORITY NOTE: Promulgated in accordance with R.S. 40:4(A)(7) and R.S. 40:5(2)(3)(7)(9)(16)(17)(20).

HISTORICAL NOTE: Promulgated by the Department of Health and Hospitals, Office of Public Health, LR 38:2858 (November 2012).

§811. Additional Provisions for Indirect and Special Wastes

A. Additional provisions for indirect and special wastes are found in the following:

1. LAC 51:XIV.Chapter 13, Medical Facilities Plumbing Systems;

2. LAC 51:XIV.Chapter 15, Travel Trailers and Travel Trailer Parks;

3. LAC 51:XIV.Chapter 16, Mobile/Manufactured Homes and Mobile/Manufactured Home Parks; and,

4. LAC 51:XIV.Chapter 17, Sewerage System Regulations;

AUTHORITY NOTE: Promulgated in accordance with R.S. 40:4(A)(7) and R.S. 40:5(2)(3)(7)(9)(16)(17)(20).

HISTORICAL NOTE: Promulgated by the Department of Health and Hospitals, Office of Public Health, LR 38:2858 (November 2012).

Chapter 9. Vents

§901. General

A. Scope. The provisions of this Chapter shall govern the materials, design, construction, and installation of vents.

B. Protection of Trap Seals. The protection of trap seals from siphonage or back pressure shall be accomplished by the appropriate use of soil or waste stacks, vents, revents, back vents, loop vents, circuit or continuous vents or combination thereof, installed in accordance with the requirements of this Chapter and the limitations set forth in §303.H.2 of this code.

C. Tests. The venting system shall be tested in accordance with §319.B of this code.

D. Engineered Systems. Engineered sanitary drainage and venting systems shall conform to the provisions of Chapter 12, Alternate Designed Plumbing Systems, of this code.

AUTHORITY NOTE: Promulgated in accordance with R.S. 40:4(A)(7) and R.S. 40:5(2)(3)(7)(9)(16)(17)(20).

HISTORICAL NOTE: Promulgated by the Department of Health and Hospitals, Office of Public Health, LR 38:2858 (November 2012).

§903. Materials

A. Vents. Pipe, tubing, and fittings for the vent piping system shall comply with the provisions of Chapter 7 of this code.

B. Specific Type. Standards given in Table 703 of this code apply to the specific materials approved for use and as indicated in the various Sections in this Chapter.

C. Piping above Ground. Vent piping shall be of cast iron, galvanized steel, brass or copper pipe, copper tube of a weight not less than that of copper drainage tube Type DWV, and Schedule 40 plastic piping. Vent piping used in acid waste systems shall be of the same material used in the acid soil and waste piping (see §703.F of this code).

D. Piping Underground. Vent piping placed underground shall be of cast iron, copper tube of a weight not less than that of Type DWV, Schedule 40 plastic piping or heavy schedule borosilicate glass, provided that other materials may be used for underground vents when found adequate and installed as directed by the plumbing official. Vent piping used in acid waste systems shall be of the same material used in the acid soil and waste piping (see §703.F of this code). Materials subject to corrosion shall be protected when installed in corrosive soil.

E. Fittings. Fittings shall be compatible to the type of pipe used in the vent system as required by §§903.B, 903.C and 903.D of this code.

1. Vent pipes installed less than 6 inches above the flood-level rim of fixture(s) served shall be installed with approved drainage fittings (i.e., short turn quarter bends shall be prohibited).

AUTHORITY NOTE: Promulgated in accordance with R.S. 40:4(A)(7) and R.S. 40:5(2)(3)(7)(9)(16)(17)(20).

HISTORICAL NOTE: Promulgated by the Department of Health and Hospitals, Office of Public Health, LR 38:2858 (November 2012).

§905. Vent Stacks

A. Installation. A vent stack or main vent shall be installed with a soil or waste stack whenever back vents, relief vents or other branch vents are required in two or more branch intervals. No fixture shall be permitted to drain into any stack above any vent connection.

B. Terminal. The vent stack shall terminate independently above the roof of the building or shall be connected with the extension of the soil or waste stack (stack-vent) at least 6 inches (152 mm) above the flood-level rim of the highest fixture.

C. Main Stack. The main vent stack or stack vent shall comply with the following.

1. Every building in which plumbing is installed shall have at least one main vent stack or stack vent, of not less than 3-inch (76 mm) diameter, for each building drain, when connected separately to a building sewer, septic tank, or other sewage collection and/or disposal system approved by the state health officer. Such vent shall run undiminished in size and as directly as possible from the building drain through to the open air above the roof.

2. The main vent stack in a detached garage or other accessory building where only a washing machine or laundry tray is installed may be 1 1/2 inches (38 mm).

AUTHORITY NOTE: Promulgated in accordance with R.S. 40:4(A)(7) and R.S. 40:5(2)(3)(7)(9)(16)(17)(20).

HISTORICAL NOTE: Promulgated by the Department of Health and Hospitals, Office of Public Health, LR 38:2859 (November 2012).

§907. Vent Terminals

A. Roof Extension. Extensions of vent pipes through a roof shall be terminated at least 6 inches (152 mm) above the roof, except that where a roof is to be used for any purpose other than weather protection, the vent extension shall be run at least 9 feet (2743 mm) above the roof or any structure where people may congregate.

B. Frost Closure. Where there is possibility of frost closure, the vent extension through a roof shall be at least 3-inch diameter. When it is found necessary to increase the size of the vent terminal, the change in diameter shall be made at least 1 foot (305 mm) inside the building.

C. Flashings. The juncture of each vent pipe with the roof line shall be made watertight by proper flashing (see §§303.G.1.b and 303.G.2.b of this code).

D. Flag Poling. Vent terminals shall not be used to support flag poles, TV aerials, or similar items, except when the piping has been anchored to the construction and approved as safe by the plumbing official.

E. Location of Vent Terminal. A vent terminal from a drainage system shall not be located directly beneath any door, window or other fresh air intake opening of the building or of an adjacent building, nor shall any such vent terminal be within 10 feet (3048 mm) horizontally of such an opening unless it is at least 2 feet (610 mm) above the top of such opening.

F. Extensions through Wall. Vent terminals extending through a wall shall terminate at least 6 inches (152 mm) above the roof and the opening shall face upward. Vent terminals shall not terminate under the overhang of the building.

G. Air Admittance Valves for Venting Plumbing Fixtures and Fixture Branches. Air admittance valves are not approved for venting of plumbing fixture traps.

AUTHORITY NOTE: Promulgated in accordance with R.S. 40:4(A)(7) and R.S. 40:5(2)(3)(7)(9)(16)(17)(20).

HISTORICAL NOTE: Promulgated by the Department of Health and Hospitals, Office of Public Health, LR 38:2859 (November 2012).

§909. Vent Grades_(s) and Connections

A. *Grade_(s)*. All vent and branch vent pipes shall be so graded and connected as to drip back to the soil or waste pipe by gravity.

B. Vertical Rise. The vertical rise of vent pipes shall conform with the following.

1. Vertical Rise of Vent for a Horizontal Soil or Waste Pipe. Where vent pipes (including wet vent pipes) connect to a horizontal soil or waste pipe, the vent shall be taken off above the center line of the soil pipe, and the vent pipe shall rise vertically, or at an angle not exceeding 45° (0.785 rad) from the vertical, before offsetting horizontally.

2. Vertical Rise of Vent for a Vertical Soil or Waste Pipe. Where vent pipes connect at or below the lowest fixture connection, to a vertical soil or waste pipe, such vent shall be taken off at an angle not exceeding 45° (0.785 rad) to the vertical to a point at least 6 inches (152 mm) above the flood-level rim of the lowest fixture it is venting before offsetting horizontally.

C. Height Above Fixtures. A connection between a vent pipe and a vent stack or stack vent shall be made at least 6 inches (152 mm) above the flood-level rim of the highest fixture served by the vent. Horizontal vent pipes forming branch vents, relief vents, or loop vents shall be at least 6 inches (152 mm) above the flood-level rim of the highest fixture served.

AUTHORITY NOTE: Promulgated in accordance with R.S. 40:4(A)(7) and R.S. 40:5(2)(3)(7)(9)(16)(17)(20).

HISTORICAL NOTE: Promulgated by the Department of Health and Hospitals, Office of Public Health, LR 38:2859 (November 2012).

§911. Bar and Fountain Sink Traps

A. Traps serving sinks which are part of the equipment of island bars, island soda fountains, island counters and similar equipment need not be conventionally vented when the location and construction of such bars, soda fountains and counters make it impossible to do so. When these conditions exist, traps which are roughed in above the floor shall be vented by extending the vent as high as possible, but not less than the drainboard height and then returning it downward and connecting it to the horizontal sink drain immediately downstream from the vertical fixture drain. The return vent shall be connected to the horizontal branch through a wye-branch fitting and shall, in addition, be provided with a foot vent taken off the vertical fixture vent by means of a wye-branch immediately below the floor and extending to the nearest partition and then through the roof to the open air or may be connected to other vents at a point not less than 6 inches (152 mm) above the flood-level rim of the fixtures served. Vent pipes installed less than 6 inches above the flood-level rim of the sink shall be installed with approved drainage fittings in accordance with §903.E.1 of this code and a minimum slope of 1/4 inch per foot back to the drain shall be maintained. The return bend used under the drainboard shall be a 45-degree, a 90-degree and a 45-degree elbow in the order named. Pipe sizing shall be as elsewhere in this code. The island sink drain, upstream of the returned vent, shall serve no other fixtures. An accessible cleanout shall be installed on the vertical vent pipe under the drainboard and another cleanout should be installed in the vertical portion of the foot vent. (The cleanout recommended on the vertical portion of the foot vent shall be located at least 6 inches above the flood level rim of the sink but not more than 4 feet above the finish floor. Preferably, the vertical portion of the foot vent and its recommended cleanout shall be located on an outside wall with the cleanout accessible outside or, if this is not possible, behind a refrigerator, for example, such that the cleanout access is not aesthetically objectionable to the occupants.) For food service establishments, drainage shall be in accordance with §807.A of this code (see Figure 911.A of this code below).

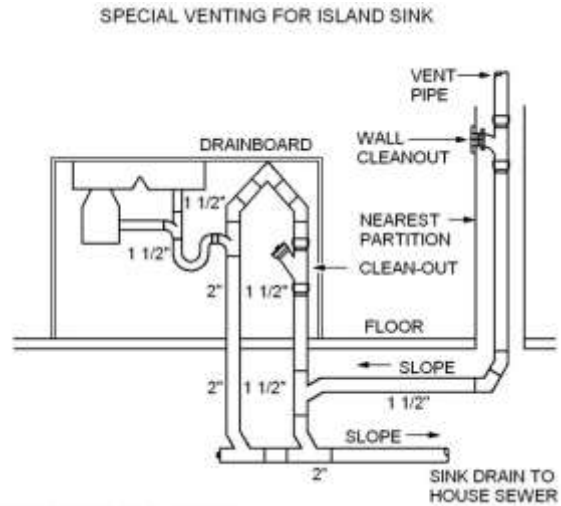

Figure 911.A—Special Venting for Island Sink

AUTHORITY NOTE: Promulgated in accordance with R.S. 40:4(A)(7) and R.S. 40:5(2)(3)(7)(9)(16)(17)(20).

HISTORICAL NOTE: Promulgated by the Department of Health and Hospitals, Office of Public Health, LR 38:2859 (November 2012).

§913. Fixture Vents

A. Distance of Trap from Vent. Each fixture trap shall have a protecting vent so located that the slope and the developed length (see Figures 913.A and 913.C of this code) in the fixture drain from the trap weir to the vent fitting are within the requirements set forth in Table 913.A of this code, except as permitted by §923.A of this code. For water closets or other floor or wall mounted fixtures having an integral trap, the developed length shall be the distance from the internal vent opening to the face of the flange to which the fixture is bolted or otherwise fastened.

Size of Fixture Drain (in)	Size of Trap (in)	Fall (in/ft)	Max. Distance From Trap
1 1/4	1 1/4	1/4	3 ft 6 in
1 1/2	1 1/4	1/4	5ft
1 1/2	1 1/2	1/4	5ft
2	1 1/2	1/4	6ft
2	2	1/4	6ft
3	3	1/8	10ft
4	4	1/8	12ft

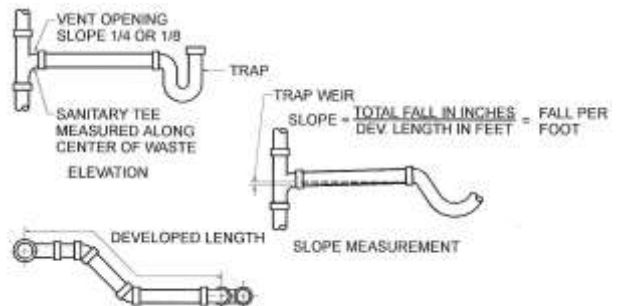

Figure 913.A—Distance of Fixture Trap from Vent

B. Trap Seal Protection. The plumbing system shall be provided with a system of vent piping which will permit the admission or emission of air so that under normal and intended use the seal of any fixture trap shall not be subjected to a pressure differential of more than 1-inch of water (249 Pa).

C. Location of Vent Opening. The internal vent pipe opening from a soil or waste pipe, except for water closets and similar fixtures, shall not be below the top weir of the trap's outlet.

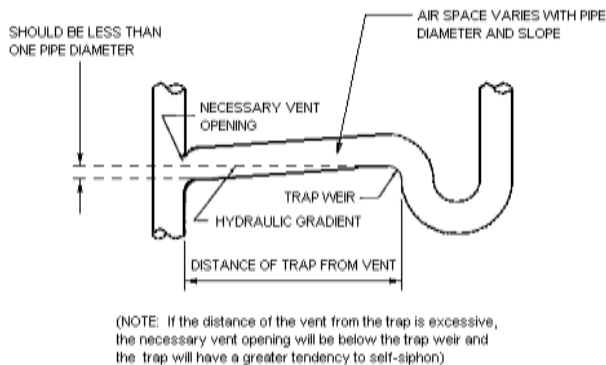

Figure 913.C—Location of Vent Opening

D. Crown Vent. A vent shall not be installed within 2 pipe diameters of the trap weir (see §1001.E.4 of this code).

AUTHORITY NOTE: Promulgated in accordance with R.S. 40:4(A)(7) and R.S. 40:5(2)(3)(7)(9)(16)(17)(20).

HISTORICAL NOTE: Promulgated by the Department of Health and Hospitals, Office of Public Health, LR 38:2860 (November 2012).

§915. Common Vent

A. Individual Vent. An individual vent, installed vertically, may be used as a common vent for two fixture traps when both fixture drains connect with a vertical drain at the same level. Also, see §311.C of this code in regards to double sanitary tee pattern limitations on fixtures or appliances with a pumping action discharge.

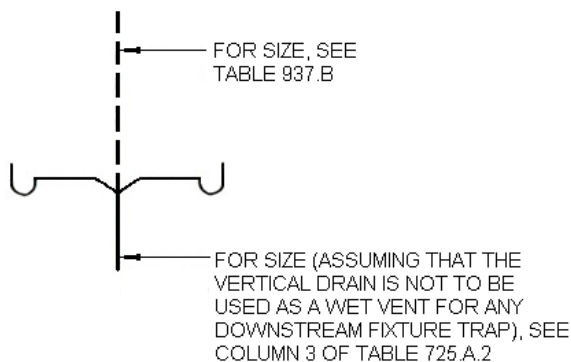

Figure 915.A—Common Vent (Fixtures Connecting at Same Level)

B. Fixtures on Same Floor Connecting at Different Levels in the Stack. A common vent may be used for two fixtures set on the same floor level but connecting at different levels in the stack, provided the vertical drain is one pipe size larger than the upper fixture drain but in no case smaller than the lower fixture drain, whichever is the larger, and that both drains conform to Table 913.A of this code. A minor fixture, such as a lavatory, shall enter the common vent above a major fixture, such as a water closet [i.e., a minor (having less fixture units) over/upstream of a major (having more fixture units) rule]. See Figure 915.A, Figure 915.B, and Section 915.D of this code.

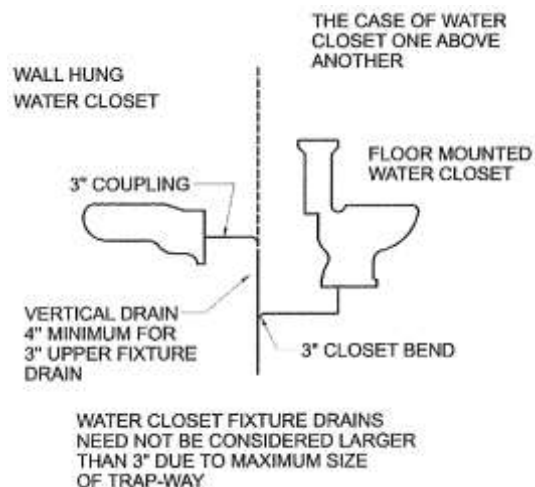

Figure 915.B (1 of 2)—Common Vent (Fixtures Connecting at Different Levels)

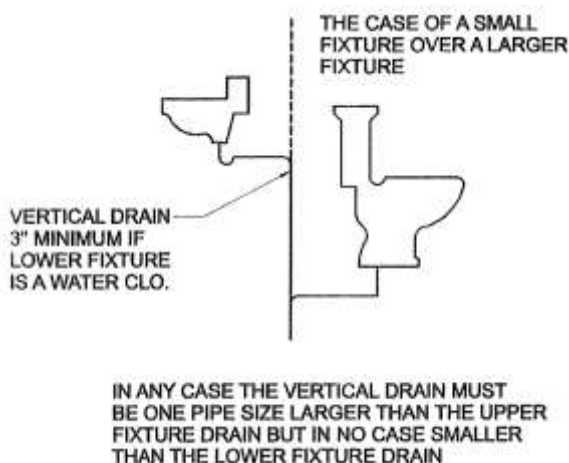

Figure 915.B (2 of 2)—Common Vent (Fixtures Connecting at Different Levels)

C. Distance. The maximum distance allowed between back-to-back or side-by-side fixture traps and their vent, when vented by a "common vent", shall be in accord with the requirements of §913.A of this code. In addition, the following shall apply.

1. Two fixtures set back-to-back, or side-by-side connected to a common horizontal branch within the distance allowed between a trap and its vent may be served with one continuous soil or waste vent-pipe, provided that

each fixture wastes separately into an approved double fitting having inlet openings at the same level. The vent shall be installed in a vertical position at the interconnection of the fixture drains or downstream of the interconnection in accordance with the distance of trap from vent requirements in Table 913.A of this code. See left-hand depiction of Figure 915.C in this code.

2. When not more than two fixtures are set back-to-back or side-by-side, within the distance allowed between a trap and its vent, they may be connected to a common horizontal branch served by a common vertical vent located

between the two fixtures, provided the branch is one pipe size larger than either of the fixture drains, except as permitted by §923.A of this code. This vent shall not serve as a waste for any other fixture. A minor fixture, such as a floor drain, shall enter the common horizontal branch served by a common vertical vent upstream of a major fixture, such as a water closet [i.e., a minor (having less fixture units) over/upstream of a major (having more fixture units) rule]. See right-hand depiction of Figure 915.C in this code.

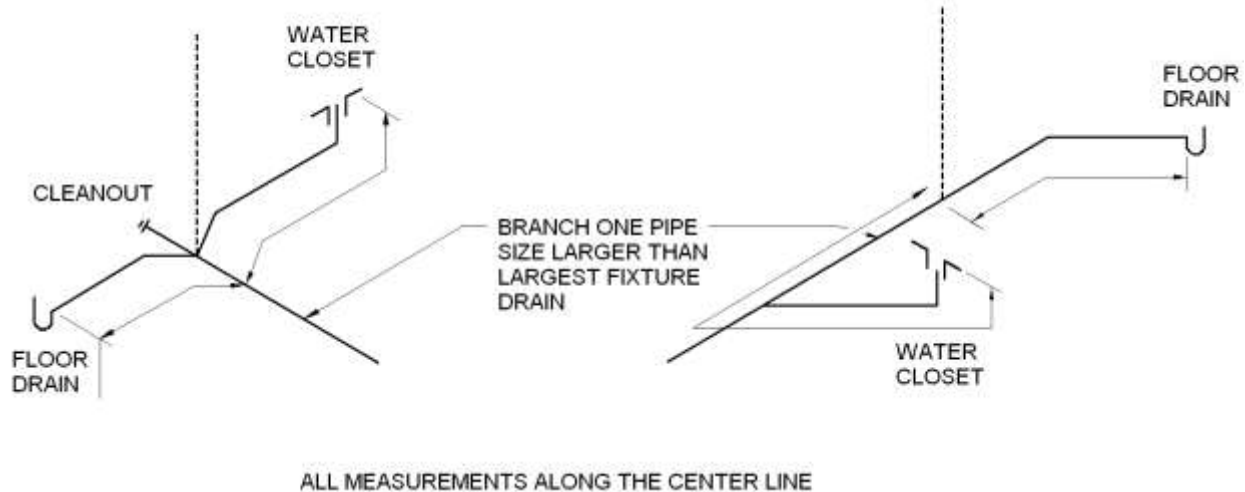

Figure 915.C—Common Vent
(Distance between Trap and Vent)

D. For the purpose of this Section, 3-inch (76 mm) or 4-inch (102 mm) floor or shower drains, up to and including 4-discharge fixture unit (dfu) water closets or pedestal urinals shall be considered as having 3-inch (76 mm) drains. For more than two fixtures on a common horizontal branch, see §925.A (Battery Venting) of this code.

1. Certain water closets and other plumbing fixtures (such as clinical sinks, flushing rim service sinks, etc.), in either public use or assembly use, have ratings exceeding 4 dfu. In such case, the horizontal branch serving such water closets or other plumbing fixtures shall be a minimum of 5-inch (127 mm) in diameter when a common vertical vent is used, as provided in §915.C.2 of this code.

AUTHORITY NOTE: Promulgated in accordance with R.S. 40:4(A)(7) and R.S. 40:5(2)(3)(7)(9)(16)(17)(20).

HISTORICAL NOTE: Promulgated by the Department of Health and Hospitals, Office of Public Health, LR 38:2861 (November 2012).

§917. Vents for Fixture Trap below Trap Weir/Fixtures Entering at Different Levels

A. Hydraulic Gradient. Fixture drains shall be vented within the hydraulic gradient between the top weir of the trap's outlet and the internal opening of the vent connection, but in no case shall the unvented drain exceed the distance provided for in Table 913.A of this code. See §913.C of this code.

B. Different Levels. If any single branch interval has fixtures entering the stack at different vertical levels, the fixtures other than the fixture entering at the highest level shall be individually vented, except as may be otherwise permitted in other Sections of this Chapter. See §§915.B, 921.A, 923.C, and 925.C of this code.

AUTHORITY NOTE: Promulgated in accordance with R.S. 40:4(A)(7) and R.S. 40:5(2)(3)(7)(9)(16)(17)(20).

HISTORICAL NOTE: Promulgated by the Department of Health and Hospitals, Office of Public Health, LR 38:2862 (November 2012).

§919. Wet Venting

A. Single Bathroom Groups. A single bathroom group of fixtures may be installed with the drain from a back vented lavatory serving as a wet vent for a bathtub or shower stall and for the water closet, provided that the wet vent is one pipe size larger than the upper fixture drain but in no case smaller than the lower fixture drain, whichever is the larger, and that both fixture drains conform to Table 913.A of this code. No urinal exceeding 2.0 dfu or washing machine drain shall discharge into any wet vent. A minor fixture, such as a bathtub or shower, shall enter the wet vent/drain pipe upstream of a major fixture, such as a water closet [i.e., a minor (having less fixture units) over/upstream of a major (having more fixture units) rule]. The dry vent servicing the wet vent shall be sized based upon the developed length and

the total fixture units connected thereto in accord with §937.B and Table 937.B of this code. (Note: Per the definition of "wet vent", the wet vent terminates at the connection with the water closet's fixture drain. If the water closet is being vented by a method other than the wet vent, the wet vent terminates where it connects to the stack, the lowest or most downstream fixture drain, or where it connects to a separate horizontal branch line or the building drain, as appropriate.)

B. Double Bath. Bathroom groups back-to-back on the top floor consisting of two bathtubs or shower stalls may be installed on the same horizontal branch with a common vent for the lavatories with no back vent for the water closets, bathtubs or shower stalls, provided that the wet vent is one pipe size larger than the upper fixture drain but in no case smaller than the lower fixture drain, whichever is the larger, and that both fixture drains conform to Table 913.A of this code. No urinal exceeding 2.0 dfu or washing machine drain shall discharge into any wet vent. A minor fixture, such as a bathtub or shower, shall enter the wet vent/drain pipe upstream of a major fixture, such as a water closet [i.e., a minor (having less fixture units) over/upstream of a major (having more fixture units) rule]. The dry vent servicing the wet vent shall be sized based upon the developed length and the total fixture units connected thereto in accord with §937.B and Table 937.B of this code.

NOTE: Per the definition of *wet vent*, the wet vent terminates at the connection with the water closet's fixture drain. If the water closet is being vented by a method other than the wet vent, the wet vent terminates where it connects to the stack, the lowest or most downstream fixture drain, or where it connects to a separate horizontal branch line or the building drain, as appropriate.

C. Multistory Bathroom Groups. On the lower floors of a multistory building, the waste pipe from one or two lavatories may be used as a wet vent for one or two bathtubs or showers provided that:

1. the wet vent and its extension to the vent stack is not less than 2-inch (51 mm) diameter;
2. each water closet below the top floor is individually back vented;
3. the vent stack is sized in accordance with Table 919.C of this code; and,
4. the lowest wet vent shall be sized for the total bathtubs or showers connected to the stack but in no case shall the wet or dry portion of the lowest vent be less than required for the vent stack itself.

Number of Wet Vented Fixtures	Diameter of Vent Stacks (In.)
1 or 2 bathtubs or showers	2
3 to 5 bathtubs or showers	2 1/2
6 to 9 bathtubs or showers	3
10 to 16 bathtubs or showers	4

AUTHORITY NOTE: Promulgated in accordance with R.S. 40:4(A)(7) and R.S. 40:5(2)(3)(7)(9)(16)(17)(20).

HISTORICAL NOTE: Promulgated by the Department of Health and Hospitals, Office of Public Health, LR 38:2862 (November 2012).

§921. Stack Venting

A. Fixture Groups. A single bathroom group of fixtures, consisting of a water closet, lavatory, shower or tub, and a kitchen sink (with disposal and dishwasher) located back-to-back to the bathroom, or two bathrooms back-to-back each consisting of one toilet, lavatory, shower or tub may be installed without individual fixture vents in a one story building or on the top floor of a building provided each fixture drain connects independently to the stack and that the tub and/or shower and water closet enter the stack at the same level and in accordance with the requirements in Table 913.A of this code. The wet vent portion of the stack vent shall be one pipe size larger than the upper fixture drain but in no case smaller than the lower fixture drain, whichever is the larger.

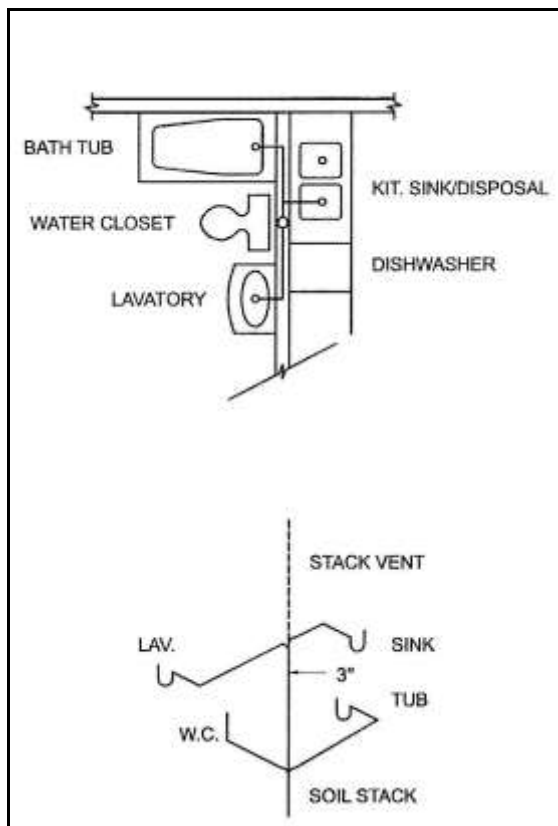

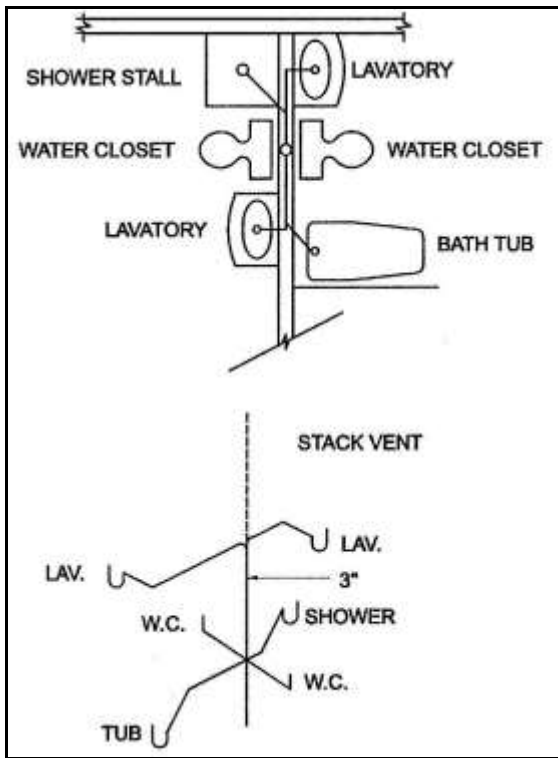

Figure 921.A—Stack Venting

B. Lower Floors. The lower floors of multistoried buildings may also be vented as in §921.A of this code provided that a separate wye and upright one-eighth bend is installed in the stack and that the stack group is installed above the one-eighth bend and that at least a 2-inch (51 mm) diameter vent is installed 6 inches (152 mm) above the flood level of the highest fixture in the stack group. See Figure 921.B of this code below.

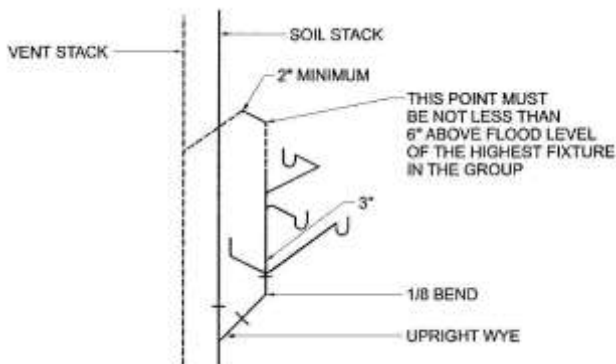

Figure 921.B—Stack Venting Lower Floors

AUTHORITY NOTE: Promulgated in accordance with R.S. 40:4(A)(7) and R.S. 40:5(2)(3)(7)(9)(16)(17)(20).

HISTORICAL NOTE: Promulgated by the Department of Health and Hospitals, Office of Public Health, LR 38:2863 (November 2012).

§923. Individual Fixture Reventing

A. Horizontal Branches. A horizontal waste branch meeting the following criteria shall effectively provide an exception to the need for a revent pipe(s).

1. Provided:
 - a. the horizontal branch is full size throughout its length;
 - b. each fixture drain enters the horizontal branch via a wye and 1/8th bend or a combination wye and 1/8th bend;
 - c. the wastes are connected with a pitch of not more than 1/4 inch per foot (21 mm per meter);
 - d. that a 2-inch "P" trap shall be the minimum for tubs and showers;
 - e. the waste openings in the horizontal branch shall not be less than 1 1/4 inches for lavatories and 1 1/2 inches for a sink; and,
 - f. that one drinking fountain shall be considered as one lavatory; then, without the use of reventing:
 - i. one sink and one lavatory, or one tub, or one shower, or three lavatories within 8 feet (2438 mm) developed length of a main vented line may be installed on a 2-inch horizontal waste branch; or,
 - ii. two lavatories within 5 feet (1524 mm) developed length of a main vented line may be installed on a 1 1/2-inch horizontal waste branch.

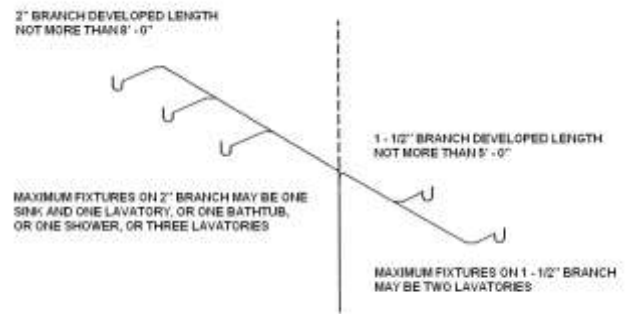

Figure 923.A

B. Where Required. All fixtures discharging downstream from a water closet shall be individually vented.

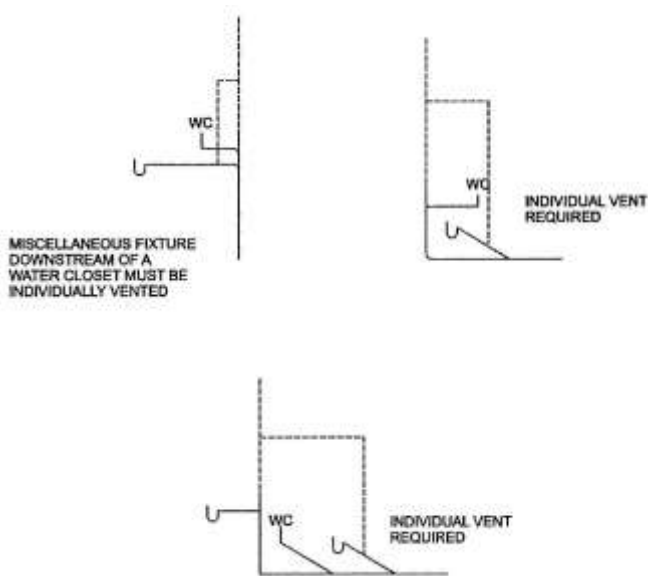

Figure 923.B—Required Individual Vents

C. Limits of Fixture Units Above Bathtubs and Water Closets. Up to a total of three fixture units may be placed on a soil or waste stack on floors above the highest water closet or bathtub connection without the use of a revent pipe(s) provided:

1. the soil or waste stack is not less than 3-inch diameter;
2. the total fixture unit load on the stack does not exceed the limitations of Table 725.A.2 of this code;
3. the largest fixture drain opening into the stack does not exceed the nominal diameter of the trap of the fixture to be connected except as permitted in §923.A of this code. Such opening for multiple fixture connections shall be limited to use on one floor only;
4. each fixture above the highest tub or water closet is no farther from the stack than permitted in Table 913.A of this code; and,
5. all fixtures on lower floors are vented as otherwise required by this Chapter.

AUTHORITY NOTE: Promulgated in accordance with R.S. 40:4(A)(7) and R.S. 40:5(2)(3)(7)(9)(16)(17)(20).

HISTORICAL NOTE: Promulgated by the Department of Health and Hospitals, Office of Public Health, LR 38:2864 (November 2012).

§925. Battery Venting

A. A branch soil or waste pipe of uniform diameter throughout its length, to which are connected in battery a maximum of eight floor-level fixtures [floor outlet water closets, back outlet water closets (provided they connect horizontally into the battery vented section), floor drains, bathtubs, and showers] and which do not exceed 50 percent of the fixture units allowed by column two of Table 725.A.2 of this code, may be vented by a circuit or loop vent system connected downstream of the most upstream fixture drain (between the two uppermost fixture drains). In addition,

battery vented branches on the top floor of a building and serving three or more fixtures shall be provided with a relief vent connected immediately downstream of the first downstream fixture connection of the battery vented section. When a battery vented branch is installed below the uppermost floor of the building, regardless of the number of fixtures served, it shall be provided with a relief vent connected immediately downstream of the first downstream fixture connection of the battery vented section. When lavatories or similar fixtures having a fixture unit rating of four or less and a maximum 2-inch fixture drain discharge from above such branches, each vertical branch shall be provided with a continuous vent. Such fixtures shall be located on the same floor as the battery vented group and the waste from such fixtures is required to enter the battery vented section from the horizontal. Fixtures having fixture unit ratings greater than four shall not discharge into such branch from above unless all fixtures in the battery group are individually vented. Fixtures from an upper floor or from an adjoining or other room(s) or space(s) (other than back-to-back installations, for example, back-to-back to bathrooms) shall not discharge into a battery vented branch. Floor level fixtures, including but not limited to floor drains, discharging downstream from a water closet shall be individually vented (see §925.C.5 of this code). Each fixture drain/trap which is connected to a battery vented soil or waste pipe branch shall conform with the distance of trap from vent requirements in Table 913.A of this code. The developed length distance from the weir of the trap or the flange of the water closet to the battery vented soil or waste pipe branch shall be used to determine compliance with Table 913.A of this code.

1. Exception. The relief vent, connected immediately downstream of the first downstream fixture connection of the battery vented section, may be omitted on a top floor installation of a battery vented section provided a stack vent or vent stack is located downstream of the first downstream horizontal fixture connection.

B. Vent Connections. Any vent or vents on the battery vented section shall be taken off from the vertical or at an angle not exceeding 45 degrees from the vertical in conformity with §909.B.1 of this code.

1. In addition, if a fixture having a fixture unit rating of four or less and a maximum 2-inch fixture drain discharge wastes into either the upper vent or the downstream relief vent of a battery vented section, the wet portion of such vent shall not be smaller than the horizontal battery branch.

a. Exception. The vent branch connection may be taken off horizontally provided it is washed by not more than four fixture units, other than water closets, and the wet portion of the vent is not smaller than the horizontal battery branch.

C. Fixtures Back-to-Back in Battery (see Figure 925.C of this code). Fixtures installed back-to-back in a battery vented system shall comply with the following.

1. A fixture connected to a horizontal branch through a vertical drain and a sanitary tee shall be vented in accordance with §913.A of this code.

2. Back-to-back fixtures connected to a horizontal branch through a single vertical drain shall enter the vertical drain through a sanitary cross, and a common vent for each two fixtures shall be provided. The common vent shall be installed as a continuation of the vertical drain.

3. A fixture connected to a horizontal branch through a wye or combination wye and one-eighth bend installed in a horizontal position need not be individually vented.

4. Back-to-back fixtures connected to a horizontal branch through a double wye or combination double wye and one-eighth bend installed in the horizontal position need not be provided with a common vent at the connection to the horizontal branch, except for the last two fixtures upstream. The vent shall be installed in a vertical position at the interconnection of the fixture drains or downstream of the interconnection in accordance with the distance of fixture trap from vent requirements in Table 913.A of this code.

5. In spite of §§925.C.3 and 925.C.4 of this code, the following floor level fixtures discharging downstream from a water closet shall be individually vented:

- a. floor drains;
- b. bathtubs;
- c. showers;
- d. floor sinks;
- e. curbed cleaning facilities (i.e., floor-level mop sinks); and,
- f. similar type fixtures.

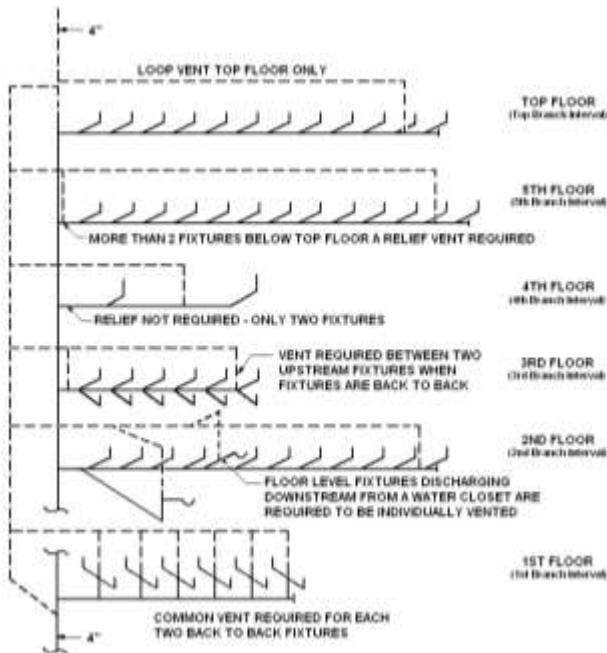

Figure 925.C—Battery Venting

AUTHORITY NOTE: Promulgated in accordance with R.S. 40:4(A)(7) and R.S. 40:5(2)(3)(7)(9)(16)(17)(20).

HISTORICAL NOTE: Promulgated by the Department of Health and Hospitals, Office of Public Health, LR 38:2865 (November 2012).

§927. Pneumatic Ejectors

A. Relief vents from a pneumatic ejector shall be carried separately to the open air.

AUTHORITY NOTE: Promulgated in accordance with R.S. 40:4(A)(7) and R.S. 40:5(2)(3)(7)(9)(16)(17)(20).

HISTORICAL NOTE: Promulgated by the Department of Health and Hospitals, Office of Public Health, LR 38:2866 (November 2012).

§929. Yoke Vents—Stacks of More Than 10 Branch Intervals

A. Soil and waste stacks in buildings having more than 10 branch intervals shall be provided with a yoke vent at each tenth interval installed, beginning with the top floor. The size of the yoke vent shall be equal to the size of the vent stack to which it connects. The lower end of each yoke vent shall connect to the soil or waste stack through a wye below the horizontal branch serving the floor, and the upper end shall connect to the vent stack through a wye not less than 3 feet (914 mm) above the floor and not less than 6 inches above the flood-level rim of the highest fixture served on the floor.

AUTHORITY NOTE: Promulgated in accordance with R.S. 40:4(A)(7) and R.S. 40:5(2)(3)(7)(9)(16)(17)(20).

HISTORICAL NOTE: Promulgated by the Department of Health and Hospitals, Office of Public Health, LR 38:2866 (November 2012).

§931. Offset Vents

A. General. In buildings five or more stories in height, offsets in vertical drainage piping having less than a 45° (0.785 rad) slope shall be vented in accordance with §931.B or §931.C, except as otherwise permitted by §727 of this code.

B. Separate Venting. Such offsets may be vented as two separate soil or waste stacks, namely the stack section below the offset and the stack section above the offset.

C. Offset Reliefs. Such offsets may be vented by installing a relief vent as a vertical continuation of the lower section of the stack or as a side vent connected to the lower section between the offset and next lower fixture or horizontal branch. The upper section of the offset shall be provided with a yoke vent. The diameter of the vents shall be not less than the diameter of the main vent, or of the soil and waste stack, whichever is the smaller.

AUTHORITY NOTE: Promulgated in accordance with R.S. 40:4(A)(7) and R.S. 40:5(2)(3)(7)(9)(16)(17)(20).

HISTORICAL NOTE: Promulgated by the Department of Health and Hospitals, Office of Public Health, LR 38:2866 (November 2012).

§933. Main Vents to Connect at Base

A. All main vents or vent stacks shall connect full size at their base to the building drain within 10 pipe diameters of

the main soil or waste pipe or to the main soil or waste pipe, at or below the lowest fixture branch. All vent pipes shall extend undiminished in size to the vent terminal, or shall be reconnected with the main soil or waste vent.

AUTHORITY NOTE: Promulgated in accordance with R.S. 40:4(A)(7) and R.S. 40:5(2)(3)(7)(9)(16)(17)(20).

HISTORICAL NOTE: Promulgated by the Department of Health and Hospitals, Office of Public Health, LR 38:2866 (November 2012).

§935. Vent Headers

A. Stack vents and vent stacks may be connected into a common vent header at the top of the stacks and then terminate as required by this Chapter. This header shall be sized in accordance with the requirements of Table 937.B of this code, the number of units being the sum of all units on all stacks connected thereto, and the developed length being the longest vent length from the intersection at the base of the most distant stack to the vent terminal as a direct extension of one stack.

AUTHORITY NOTE: Promulgated in accordance with R.S. 40:4(A)(7) and R.S. 40:5(2)(3)(7)(9)(16)(17)(20).

HISTORICAL NOTE: Promulgated by the Department of Health and Hospitals, Office of Public Health, LR 38:2866 (November 2012).

§937. Size and Length of Vents

A. Length of Vent Stacks. The length of the vent stack or main vent shall be its developed length from the lowest

connection of the vent system with the soil stack, waste stack, or building drain to the vent stack terminal, if it terminates separately, or to the connection of the vent stack with the stack vent, plus the developed length of the stack-vent from the connection to the terminal, if the two vents are connected together with a single extension.

B. Size of Stack-Vents, Vent Stacks, Relief Vents, Individual Vents or Branch Vents. The diameter of a stack-vent, vent stack, relief vent, individual vent or branch vent shall not be less than one-half of the diameter of the drain served, but in no case less than 1 1/4 inches, and shall be determined from its length and the total of fixture units connected thereto, as provided in Table 937.B of this code. All water closets vents shall be a minimum of 2 inches in diameter. This shall not be interpreted to allow the alteration or elimination of the need for at least one 3-inch vent stack or stack vent on the building drain as required under §905.C.1 of this code.

C. Size of Battery Vents. The diameter of a battery vent shall be not less than one-half the pipe size of the horizontal waste line it is venting, but in no case less than 1 1/2 inches, and shall be determined from its length and the total of fixture units connected thereto, as provided in Table 937.C of this code. The diameter and horizontal length of a battery vent shall in no case be less than permitted in Table 937.C of this code. (See §925 of this code).

Table 937.B Maximum Length of Vents (ft) (Other than Battery Vents) (See Table 937.C of this Code for Battery Venting)										
Size of Soil or Waste Stack (in)	Fixture Units Connected	Diameter of Vent Required (in)								
		1 1/4	1 1/2	2	2 1/2	3	4	5	6	8
1 1/4	2	30 ft	-	-	-	-	-	-	-	-
1 1/2	8	50 ft	150 ft	-	-	-	-	-	-	-
1 1/2	10	30 ft	100 ft	-	-	-	-	-	-	-
2	12	30 ft	75 ft	200 ft	-	-	-	-	-	-
2	20	26 ft	50 ft	150 ft	-	-	-	-	-	-
2 1/2	42	-	30 ft	100 ft	300 ft	-	-	-	-	-
3	10	-	30 ft	100 ft	200 ft	600 ft	-	-	-	-
3	30	-	-	60 ft	200 ft	500 ft	-	-	-	-
3	60	-	-	50 ft	80 ft	400 ft	-	-	-	-
4	100	-	-	35 ft	100 ft	260 ft	1000 ft	-	-	-
4	200	-	-	30 ft	90 ft	250 ft	900 ft	-	-	-
4	500	-	-	20 ft	70 ft	180 ft	700 ft	-	-	-
5	200	-	-	-	35 ft	80 ft	350 ft	1000 ft	-	-
5	500	-	-	-	30 ft	70 ft	300 ft	900 ft	-	-
5	1100	-	-	-	20 ft	50 ft	200 ft	700 ft	-	-
6	350	-	-	-	25 ft	50 ft	200 ft	400 ft	1300 ft	-
6	620	-	-	-	15 ft	30 ft	125 ft	300 ft	1100 ft	-
6	960	-	-	-	-	24 ft	100 ft	250 ft	1000 ft	-
6	1900	-	-	-	-	20 ft	70 ft	200 ft	700 ft	-
8	600	-	-	-	-	-	50 ft	150 ft	500 ft	1300 ft
8	1400	-	-	-	-	-	40 ft	100 ft	400 ft	1200 ft
8	2200	-	-	-	-	-	30 ft	80 ft	350 ft	1100 ft
8	3600	-	-	-	-	-	25 ft	60 ft	250 ft	800 ft
10	1000	-	-	-	-	-	-	75 ft	125 ft	1000 ft
10	2500	-	-	-	-	-	-	50 ft	100 ft	500 ft
10	3800	-	-	-	-	-	-	30 ft	80 ft	350 ft
10	5600	-	-	-	-	-	-	25 ft	60 ft	250 ft

Table 937.C							
Battery Vent Sizing Table							
Maximum Horizontal Length (ft)							
Soil or waste pipe diam. (in)	Maximum no. Fixture units	Diameter of circuit or loop vent (in)					
		1 1/2	2	2 1/2	3	4	5
2	3	15 ft	40 ft	-	-	-	-
2 1/2	6	10 ft	30 ft	-	-	-	-
3	10	-	20 ft	40 ft	100 ft	-	-
4	80	-	7 ft	20 ft	52 ft	200 ft	-
5	180	-	-	-	16 ft	70 ft	200 ft

AUTHORITY NOTE: Promulgated in accordance with R.S. 40:4(A)(7) and R.S. 40:5(2)(3)(7)(9)(16)(17)(20).

HISTORICAL NOTE: Promulgated by the Department of Health and Hospitals, Office of Public Health, LR 38:2866 (November 2012).

§939. Additional Provisions

A. Additional provisions for vents are contained in Chapter 13, Medical Facilities Plumbing Systems of this code.

AUTHORITY NOTE: Promulgated in accordance with R.S. 40:4(A)(7) and R.S. 40:5(2)(3)(7)(9)(16)(17)(20).

HISTORICAL NOTE: Promulgated by the Department of Health and Hospitals, Office of Public Health, LR 38:2867 (November 2012).

§941. Additional Information

A. Additional information for vents is contained in Chapter 18 (Appendices) and §1807 (Appendix C, Illustrations) of this code. Such additional information in Chapter 18 of this code shall not be construed as superceding any pertinent regulation(s) contained in LAC Chapters 1-17 of this code.

AUTHORITY NOTE: Promulgated in accordance with R.S. 40:4(A)(7) and R.S. 40:5(2)(3)(7)(9)(16)(17)(20).

HISTORICAL NOTE: Promulgated by the Department of Health and Hospitals, Office of Public Health, LR 38:2867 (November 2012).

Chapter 10. Traps

§1001. General

A. Scope. The provisions of this Chapter shall govern the materials and installation of traps.

B. Trap Seal. Each fixture trap shall have a water seal of not less than 2 inches (51 mm) and not more than 4 inches (102 mm), except where a deeper seal is required by the plumbing official for special conditions.

C. Trap Level and Protection. Traps shall be set level with respect to their water seals.

D. Traps Underground. Underground traps, except "P" traps into which floor drains with removable strainers discharge, shall be provided with accessible and removable cleanouts.

E. Prohibited Traps. The following traps (or types of traps) are prohibited from use:

1. a trap which depends for its seal upon the action of movable parts;

2. "S" traps;

a. Exception. Water closets, clinical sinks, urinals and similar fixtures shall be allowed to be "S" trapped if the fixture has an integral trap which is automatically and properly refilled using an approved device.

3. bell traps;

4. crown-vented traps (see §913.D of this code);

5. baffled or partition traps other than stainless steel, glass, plastic or similar corrosion resistant materials;

6. tubular metallic traps of less than 20 gage [0.0320 inch (0.813 mm)] thickness; and,

7. running traps.

a. Exceptions

i. A running trap with cleanout may be allowed on condensate waste lines (see §1305.I of this code).

ii. A running trap may be authorized for certain floor level fixtures installed on a Combination Waste and Vent System when plans and specifications have been specially approved by the state health officer under the requirements of Chapter 12 (Alternate Designed Plumbing Systems) of this code. See guidance for same under §1811.C.4 of this code.

F. Double Trapping. A fixture shall not be double trapped.

1. Exception. Fixtures in mobile/manufactured homes and travel trailers are allowed to be double trapped when a trailer trap is required to be placed in the building sewer/sewer lateral as per §1003.E, §1515.J, §1523.A, §1613.J or §1623.A of this code.

G. Unions (Threaded). Unions may be used in the trap seal and on the inlet side of the trap. Unions shall have metal-to-metal seats.

H. Fixture Trap Required, Location, and Number of Traps Per Fixture. The requirement for a fixture trap and the

number of traps per fixture shall be in conformance with the following.

1. Plumbing fixtures, excepting those having integral traps, shall be separately trapped by a water seal trap, placed as close to the fixture outlet as possible.

2. A combination plumbing fixture may be installed on one trap, if one compartment is not more than 6 inches (152 mm) deeper than the other and the waste outlets are not more than 30 inches (762 mm) apart.

3. One trap may be installed for a set of not more than three single-compartment sinks or laundry trays or three lavatories immediately adjacent to each other in the same room, if the waste outlets are not more than 30 inches (762 mm) apart and the trap is centrally located when three compartments are installed.

I. Distance of Trap Weir from Fixture Outlet. The vertical distance from the fixture outlet to the trap weir, or from the outlet of an integrally trapped water closet or similar fixture to the horizontal piping connecting the fixture to its vent, shall not exceed 24 inches (610 mm).

1. Exception. Washing Machine Pumped Waste Drain. The vertical distance from the vertical standpipe inlet receiving the pumped waste discharge from a washing machine (laundry) to the trap weir shall be a minimum of 30 inches (762 mm) and a maximum of 48 inches (1219 mm), with the vertical standpipe inlet terminating a minimum of 34 inches (864 mm) above finished floor or in accordance with the manufacturer's recommendation.

AUTHORITY NOTE: Promulgated in accordance with R.S. 40:4(A)(7) and R.S. 40:5(2)(3)(7)(9)(16)(17)(20).

HISTORICAL NOTE: Promulgated by the Department of Health and Hospitals, Office of Public Health, LR 38:2867 (November 2012).

§1003. Type and Size of Traps and Fixture Drains

A. Trap Size. The size (nominal diameter) of a trap for a given fixture shall be sufficient to drain the fixture rapidly but in no case less than given in Table 723.A of this code.

B. Relation to Fixture Drains. A trap shall not be larger than the fixture drain to which it is connected.

C. Type of Traps. Traps shall conform with the following requirements.

1. Fixture traps shall be self-cleaning, other than integral traps and drum traps, without partitions or movable parts, except as specifically approved in other Sections of this Chapter.

2. Slip joints may be used on both sides of the trap and in the trap seal.

3. A trap which is integral with the fixture shall have a uniform interior and a smooth waterway.

D. Drum Traps. The use of drum traps shall comply with the following requirements:

1. Drum traps shall be limited to special fixtures wherein the capture of solids (e.g., broken teeth, fillings, etc., from dental cuspidors) is desired so that such solids can be removed before they escape into the downstream drainage system. Drum traps are subject to approval by the plumbing official. The body of the drum trap shall be not less than 4-inch diameter and shall have a water seal of not less than 2 inches (51 mm).

2. The trap screw of the drum trap/drum trap cover shall be one size less than the body of the drum trap's diameter.

E. Trailer Traps. Mobile/manufactured homes and travel trailers shall be provided with a trailer trap in the building sewer/sewer lateral immediately downstream of the mobile/manufactured home or travel trailer drain outlet connection. The trailer trap shall be individually vented and the vent shall be located downstream of the trap at a distance in accord with Table 913.A, Section 913.D and Section 1001.E.4 of this code. Running traps are prohibited for this installation. See diagram under §1523.A or §1623.A of this code.

1. Exception. The trailer trap for a mobile/manufactured home or travel trailer is not required to be provided with an individual vent if the mobile/manufactured home or travel trailer is connected to a park drainage system constructed in accord with §1613.G or §1515.G of this code and the building sewer/sewer lateral is no longer than 30 feet (9144 mm) from the main park drainage sewer main. For this individual vent exception to apply, the building sewer/sewer lateral shall enter the main park drainage sewer main on the horizontal such that an "S" trap or an effective "S" trap is not created. See §§1515.J and 1613.E.1 of this code.

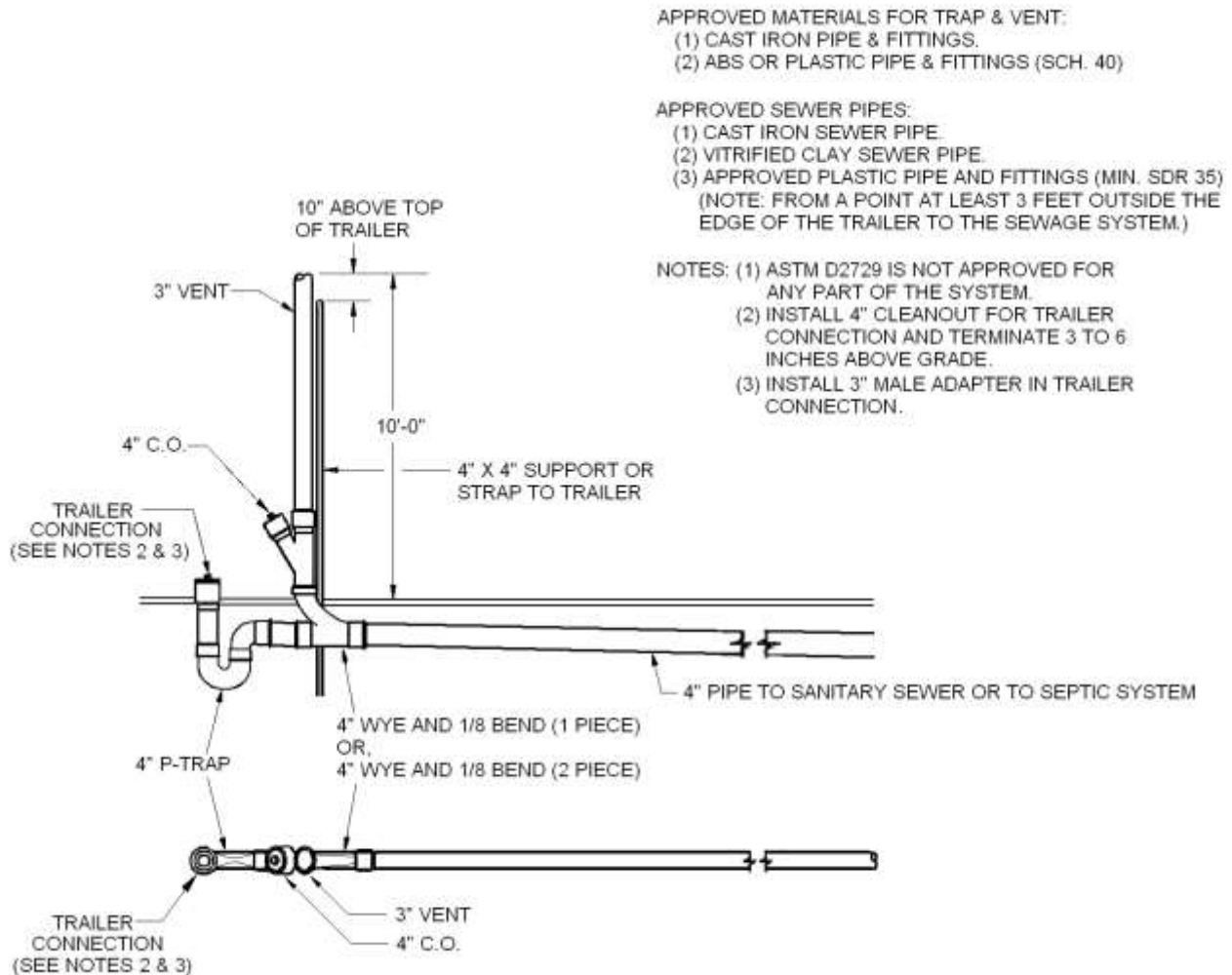

Figure 1003.E—Trailer Trap and Vent

AUTHORITY NOTE: Promulgated in accordance with R.S. 40:4(A)(7) and R.S. 40:5(2)(3)(7)(9)(16)(17)(20).

HISTORICAL NOTE: Promulgated by the Department of Health and Hospitals, Office of Public Health, LR 38:2868 (November 2012).

§1005. Interceptors and Separators

A. When required. Interceptors or separators shall be provided for the proper handling of liquid wastes containing grease, oil, flammable waste, sand, solids or other ingredients harmful to the building drainage system, the sewerage system or sewage treatment plant or processes except when, in the opinion of the plumbing official, they are not necessary.

B. Size and Type. The size, type and location of each interceptor or separator shall be approved by the plumbing official.

C. Type of Waste. No wastes other than those requiring treatment or separation shall be discharged into any interceptor or separator except where otherwise specifically permitted.

D. Grease Traps, Grease Interceptors, and Large Capacity Grease Interceptors. An approved type grease trap, grease interceptor, or large capacity grease interceptor complying with the provisions of this Section shall be installed in the waste line leading from sinks, drains and other fixtures or equipment in establishments such as restaurants, cafes, lunch counters, cafeterias, bars and clubs, hotels, hospitals, sanitariums, factory, school or day care center kitchens, markets, or other establishments where grease may be introduced into the drainage or sewage system in quantities that can affect line stoppage or hinder sewage treatment or the functioning of an individual sewerage system, except when, in the opinion of the plumbing official, they are not necessary.

E. Oil Separators. An oil separator shall be installed in the drainage system section of the system where, in the opinion of the plumbing official, a hazard exists or where oils or other flammables can be introduced or admitted into the drainage system by accident or otherwise.

F. Sand Interceptors. Sand and similar interceptors for heavy solids shall have a water seal of not less than 2 inches (51 mm).

G. Venting Interceptors. Interceptors shall be so designed that they will not become air bound if closed covers are used. Each interceptor shall be properly vented.

H. Accessibility of Interceptors. Each interceptor shall be so installed as to provide ready accessibility to the cover and means for servicing and maintaining the interceptor in working and operating condition. The use of ladders or the removal of bulky equipment in order to service interceptors shall constitute a violation of accessibility.

I. Water Connection. If permitted by the plumbing official, any water connection for cooling or operating an interceptor shall be such that backflow cannot occur.

J. Special Occupancy Provisions. Laundries, bottling plants and slaughter houses shall be provided with an interceptor or separator in conformance with the following.

1. Laundries. Laundries shall be provided with an interceptor as follows.

a. Interceptor. Commercial laundries shall be equipped with an interceptor having a removable wire basket or similar device that will prevent strings, rags, buttons, or other materials detrimental to the sewerage system from passing into the drainage system.

b. Intercepting Basket/Device. The basket or other device shall prevent passage into the drainage system of solids 1/2-inch (12.7 mm) or larger in size. The basket or device shall be removable for cleaning purposes.

2. Bottling Plants. Bottling plants shall discharge their process wastes into an interceptor which will provide for the separation of broken glass or other solids, before discharging liquid wastes into the drainage system.

3. Slaughter House Drains. Slaughtering room drains shall be equipped with separators which shall prevent the discharge into the drainage system of feathers, entrails and other materials likely to clog the drainage system.

K. Food Service. The following special requirements apply to the handling of organic wastes of food origin.

1. Commercial Food-Waste Grinders. Where commercial food-waste grinders are installed, the waste from those units shall discharge through a grease trap of an approved design for this use.

2. Wash Racks. Every wash rack and/or floor or slab used for cleaning containers and equipment exposed to organic wastes of food origin shall be adequately protected against storm or surface water and shall drain or discharge into a grease trap of an approved design for this use.

L. Maintenance. Grease traps, grease interceptors, large capacity grease interceptors, and other types of interceptors and separators shall be maintained in conformance with the following.

1. Grease Traps and Grease Interceptors. Grease traps, grease interceptors, and large capacity grease interceptors shall be maintained in efficient operating condition by periodic removal of the accumulated grease. No such collected grease shall be introduced into any drainage piping or sewerage system.

2. Interceptors and Separators in General. Interceptors and separators of all types shall be maintained in efficient operating condition by periodic removal of accumulated material for which the interceptor or separator has been designed. No such collected material shall be introduced into any drainage piping or sewerage system.

M. Special Type Interceptors/Separators. The plumbing official may require the submittal of drawings and other pertinent information for any interceptor/separator designed for a special or unusual purpose/use.

N. Procedures for Design, Construction and Installation of Interceptors and Separators [formerly Appendix M - Procedures for Design, Construction and Installation of Interceptors and Separators]. The provisions of this Subsection shall apply to the design, construction, installation and testing of interceptors and separators required in accordance with Subsections A - M of §1005 of this code.

1. Definitions. Definitions contained in Chapter 2 of this code shall also apply to this Section except where the following special definitions shall apply.

Bottling Plant Separator—an *interceptor* designed to separate and retain broken glass and other solids.

Grease Interceptor—an *interceptor* of less than 125 gallon capacity which is designed and installed so as to separate and retain grease. Typically identified by flow rate and/or grease capacity and generally installed indoors adjacent to the plumbing fixtures they serve. (See §1005.N.6 of this code for design and sizing requirements.)

Grease Trap—an *interceptor* of at least 125 gallon capacity which is designed and installed to separate and retain grease. Typically identified by liquid holding capacity (volume) and generally installed below $grade_{(G)}$ outdoors with provisions for above $grade_{(G)}$ accessibility for cleaning purposes. (See §1005.N.3 of this code for sizing requirements and §1005.N.4 of this code for design requirements.)

Large Capacity Grease Interceptor—an *interceptor* of at least 125 gallon capacity conforming to ASME A 112.14.3 or PDI-G101 which is designed and installed to separate and retain grease. Generally manufactured to be installed above or below $grade_{(G)}$ either indoors or outdoors. (See §1005.N.3 of this code for sizing requirements and §1005.N.5 of this code for design requirements.)

Laundry Trap—an *interceptor* designed to separate and retain lint, strings, rags, buttons or other similar materials which may be discharged from laundries.

Oil Separator—an *interceptor* designed to separate and retain waste oil and other petroleum products.

Sand Interceptor—an *interceptor* designed to separate and retain sand, gritty material or other types of heavy solids.

Slaughter House Separator—an *interceptor* designed to separate and retain feathers, entrails and other similar substances.

Special Type Separator—an *interceptor* designed to separate and retain deleterious, hazardous or undesirable matter from normal wastes for proper disposal, rendering, or recycling.

2. General Regulations. The following general regulations are applicable to interceptors and separators.

a. Size and Type. The size and type of each interceptor or separator shall be in accordance with the requirements of this Section and shall be approved by the plumbing official.

b. Location. The location of each interceptor or separator shall be approved by the plumbing official.

c. Prior Approval. No interceptor or separator shall be installed until its design, size, location and venting has been approved by the plumbing official.

d. Cleanout on Discharge Line. A two-way cleanout shall be provided on the discharge line immediately downstream of all interceptors.

e. Grease Traps/Grease Interceptors/Large Capacity Grease Interceptors. When it has been determined under §1005.D of this code that a trap or interceptor is required, the following regulations apply to the use of a grease trap or large capacity grease interceptor versus the allowance of the use of a grease interceptor.

i. A grease trap or large capacity grease interceptor shall be required in all instances of new construction or substantial renovation of buildings or facilities. In addition, a grease trap or large capacity grease interceptor shall be required for existing buildings or facilities when a proper installation can be performed without the need to break up a concrete slab.

ii. At the discretion of the plumbing official, a grease interceptor may be allowed in lieu of a grease trap or large capacity grease interceptor when the conditions for a grease trap/large capacity grease interceptor installation do not exist or cannot easily be met. For example, when:

(a). new construction, substantial renovation of buildings or facilities is not being performed and a concrete slab would have to be broken at the existing building or facility for the proper installation of a grease trap;

(b). an outside, unpaved area surrounding the building where a grease trap could be installed is available; however, it is determined that the area is too far away from the plumbing fixtures that the grease trap would be servicing; or,

(c). the installation of a grease trap is unfeasible such as when servicing a kitchen which is located on the upper floors of a multistoried building.

3. Minimum Capacity of Grease Traps and Large Capacity Grease Interceptors. The minimum required capacity of grease traps and large capacity grease interceptors shall be determined based upon the maximum number of persons served during the largest meal period in accordance with the following:

a. General. Grease traps and large capacity grease interceptors should be designed to be large enough to allow the water contained within it to remain cold since only cold water separates grease. In addition, grease traps and large capacity grease interceptors should be designed to be large enough so that they require cleaning at a frequency no more often than once per month.

b. Without Garbage Grinder. The minimum capacity for applications without a garbage grinder shall not be less than 125 gallons below the static water level. This capacity is sufficient to hold the flow from one meal long enough to accomplish proper grease separation when serving up to 50 people during a single meal period. When over 50 people are served during a single meal period, the minimum capacity of the grease trap or large capacity grease interceptor shall be increased beyond 125 gallons based upon at least an additional 2 1/2 gallons per person beginning with the 51st person served and greater.

c. With Garbage Grinder. When a garbage grinder is connected (see §1005.K.1 of this code), the grease trap or large capacity grease interceptor shall have a minimum capacity of no less than 500 gallons below the static water level. This capacity is sufficient to hold the flow from one meal long enough to accomplish proper grease separation when serving up to 50 people during a single meal period. When a garbage grinder is connected and over 50 people are served during a single meal period, the minimum grease trap capacity shall be increased beyond 500 gallons based upon at least an additional 2 1/2 gallons per person beginning with the 51st person served and greater.

d. Alternate Sizing Methods. For informational purposes only, alternate sizing methods may be found in Figures 9, 10, and 11 in Section 1807 of this code.

4. Grease Traps. The following regulations are applicable to the design and installation of grease traps.

a. The minimum required capacity of grease traps shall be determined based upon the maximum number of persons served during the largest meal period in accordance with §1005.N.3 of this code.

b. If a grease trap must be installed within an enclosed building, any access covers shall be gasketed to prevent the intrusion of odors into the building.

c. A one compartment grease trap is acceptable; however, a two compartment, or a one compartment grease trap with a baffle wall between the inlet and outlet, is preferred.

d. The grease trap shall be placed as close to the plumbing fixture(s) discharging greasy waste as possible, but preferably on the outside of the building when feasible.

e. The minimum diameter of the outlet pipe shall not be less than 4 inches.

f. A minimum of one foot of air space shall be provided above the static water level.

g. Venting. The following regulations are applicable to the venting of grease traps:

i. The grease trap outlet shall be properly vented to prevent the trap from siphoning itself out. Any internally vented outlet line shall have the vent terminal extended to within 2 inches of the bottom of the access cover to prevent grease from escaping the grease trap through the open vent terminal.

ii. For those grease traps having a gasketed cover, the grease trap outlet line shall not be allowed to be internally vented. In this case, the outlet line itself shall have a 2-inch vent pipe properly installed.

h. The invert of the grease trap outlet opening, at the point where water exits the grease trap, shall be located at a maximum of 6 inches and a minimum of 4 inches from the floor of the grease trap. This requirement also applies to any intermediate outlets in multi-compartment grease traps. The invert of the inlet shall be at least 3 inches above the invert of the outlet.

i. On unbaffled single compartment grease traps, a 90° ell shall be used on the inlet and shall terminate 6 inches below the static water level. On baffled single compartment grease traps, a baffle wall shall be placed between the inlet and outlet. The inlet shall discharge into the grease trap at a level at least 6 inches below the top of the baffle wall. The baffle wall shall extend from 2 inches below the static water

level to the bottom of the grease trap such that incoming water will have to overflow above the top of the baffle wall in order to reach the outlet.

j. The horizontal distance between the inlet and outlet piping in the grease trap should be sufficient to allow gravity-differential separation to the grease so that it will not escape through the outlet. The minimum horizontal distance shall be 24 inches.

k. Access/Covers. The following regulations are applicable to the access to and the covers for grease traps:

i. Access from the top of the grease trap shall be provided by an easily removable cover above an access opening of at least 20 inches square or 24 inches round. Additional access opening/covers shall be provided as necessary to provide accessibility to each compartment in multi-compartment or multi-baffled arrangements as well as access to both the inlet and outlet. Access opening covers shall be above or at grade_(G) to provide ready accessibility.

ii. Each access cover shall be designed so that it cannot slide, rotate, or flip when properly installed in order that the opening is not unintentionally exposed. (The intention is that a child-resistant cover be provided. Especially for lightweight covers, mechanical fasteners are recommended to augment the safety of and ensure positive closure of the cover.)

l. No water jacketed grease trap shall be approved or installed.

m. Each grease trap shall have an approved water seal of not less than 2 inches in depth or the diameter of its outlet, whichever is greater.

n. Abandoned grease traps shall be pumped and filled as required for abandoned septic tanks in accord with LAC 51:XIII.715.V.

PUBLIC HEALTH—SANITARY CODE

NOTE: IF 3" THIMBLE IS USED AS ILLUSTRATED,
ONE 2" LOCAL VENT MAY BE ELIMINATED

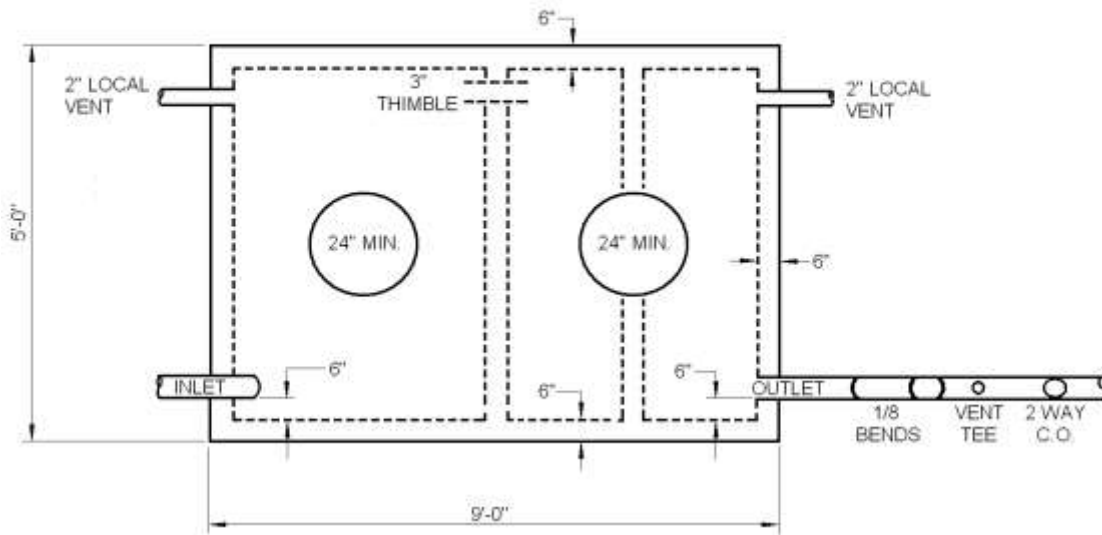

Figure 1005.N.4A (1 of 2)—Grease Trap (top view)

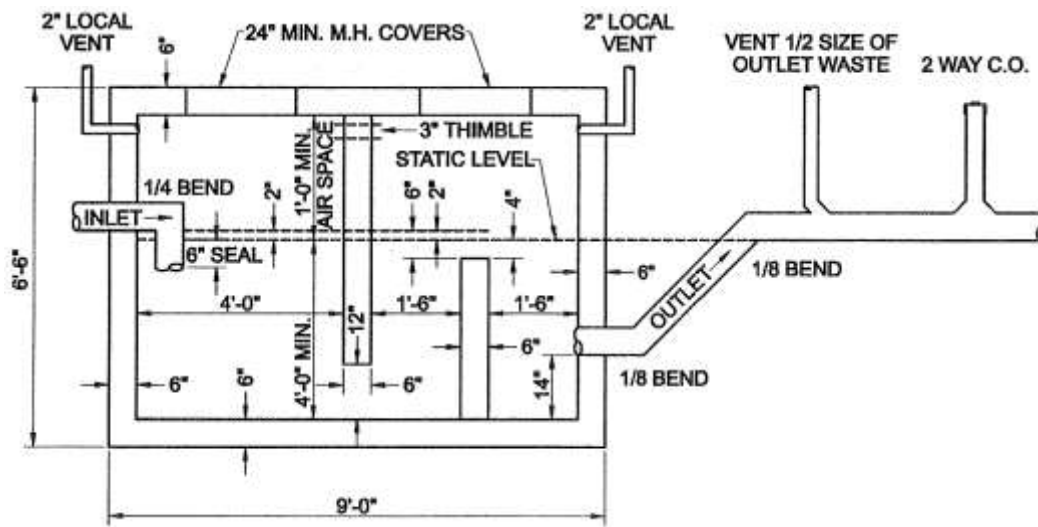
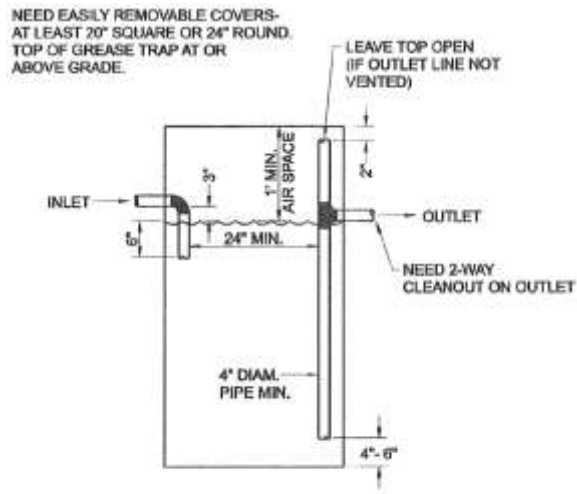

Figure 1005.N.4A (2 of 2)—Grease Trap (side view)



Min. volume below invert of outlet = 125 gallons

- = 2' x 2' x 4' water depth
(would have to be built 2' x 2' x 5' in order to give 1' air space above water line)
- or = 2' x 3' x 3' water depth*
(would have to be built 2' x 3' x 4' in order to give 1' air space above water line)

(* This would be preferred in order to keep inlet & outlet at least 24" apart from each other.)

Figure 1005.N.4B—Grease Trap (sanitary details only)

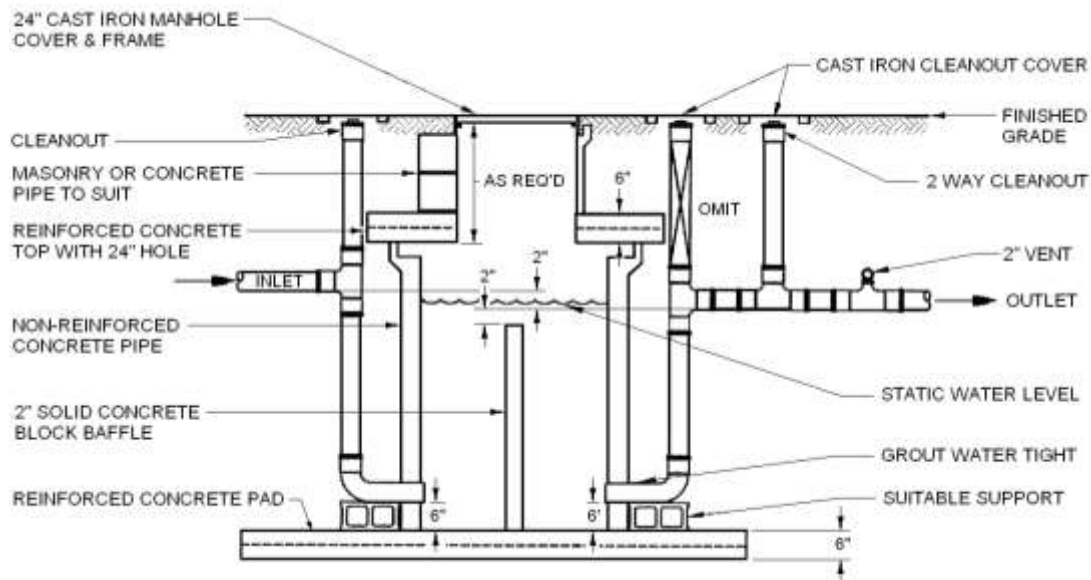

NOTES:

1. THE BOTTOM OF THE INLET PIPE SHALL BE NOT LESS THAN TWO INCHES ABOVE THE BOTTOM OF THE OUTLET PIPE.
2. THE BOTTOM OF THE OUTLET PIPE SHALL BE TWO INCHES ABOVE THE TOP OF THE BAFFLE WALL.
3. TRAP INDICATED ABOVE IS FOR CONCRETE PIPE CONSTRUCTION. ALTERNATE MATERIAL AND METHODS OF INSTALLATION MUST BE SUBMITTED FOR APPROVAL PRIOR TO INSTALLATION.

Figure 1005.N.4C—Grease Trap

5. Large Capacity Grease Interceptors. The following design regulations are applicable to large capacity grease interceptors.

a. Large capacity grease interceptors shall be evaluated, tested, and certified for conformance with ASME A 112.14.3 or PDI-G101.

b. The minimum required capacity of large capacity grease interceptors shall be determined based upon the maximum number of persons served during the largest meal period in accordance with §1005.N.3 of this code.

c. Grease interceptors shall be maintained in efficient operating condition by periodic removal of the accumulated grease. No such collected grease shall be introduced into any drainage piping or sewerage system.

d. Each grease interceptor shall have an approved water seal of not less than 2 inches in depth or the diameter of its outlet, whichever is greater. The grease interceptor outlet shall be properly vented to prevent the trap from siphoning itself out.

6. Grease Interceptors. The following design regulations are applicable to grease interceptors:

a. When specially allowed by the plumbing official pursuant to §1005.N.2.e of this code, an approved type grease interceptor complying with ASME A 112.14.3 or PDI-G101 and the provisions of this Paragraph may be

installed in the waste line leading from sinks, drains and other fixtures or equipment in establishments such as restaurants, cafes, lunch counters, cafeterias, bars and clubs, hotels, hospitals, sanitariums, factory, school or day care center kitchens, markets, or other establishments where grease may be introduced into the drainage or sewerage system in quantities that can affect line stoppage or hinder sewage treatment or the functioning of an individual sewerage system, except when, in the opinion of the plumbing official, they are not necessary.

b. The minimum required size of grease interceptors shall be determined based upon fixture discharge rate (gpm) and grease retention capacity (pounds) in accordance with Figure 1005.N.6 of this code (see also §1005.N.6.h of this code); however, in no case shall a grease interceptor be installed which has an approved rate of flow of less than 20 gallons per minute, except when specially approved by the plumbing official.

c. Each plumbing fixture or piece of equipment connected to a grease interceptor shall be provided with an approved type flow control or restricting device installed in a readily accessible and visible location in the tailpiece or drain outlet of each such fixture. Flow control devices shall be so designed that the flow through such device or devices shall at no time be greater than the rated capacity of the grease interceptors. No flow control device having adjustable or removable parts shall be approved.

d. Each grease interceptor that is rated shall be stamped or labeled by the manufacturer with an indication of its full discharge rate in gallons per minute (gpm). Each grease interceptor allowed to be installed under the provisions of this Paragraph shall have an approved rate of flow which is not less than that given in Table 1005.N.6 of this code based upon the total flow expected in gpm from the total number of connected fixtures (i.e., each grease interceptor shall be rated equal to or greater than the incoming flow). The total capacity, in gallons, from all fixtures discharging into any such grease interceptor shall not exceed two and one-half (2-1/2) times the certified gallon per minute (gpm) flow rate of the grease interceptor as per Table 1005.N.6 of this code.

i. Any grease interceptor installed with the inlet more than 4 feet lower in elevation than the outlet of any fixture discharging into such grease interceptor shall have an approved rate of flow which is not less than 50 percent greater than that given in Table 1005.N.6 of this code.

ii. For the purpose of this Paragraph, the term "fixture" shall mean and include each plumbing fixture, appliance, apparatus or other equipment required to be connected to or discharge into a grease interceptor by any provision of this Paragraph.

e. Each fixture discharging into a grease interceptor shall be trapped and vented in an approved manner. An approved type grease interceptor may be used as a fixture trap for a single fixture when the horizontal distance between the fixture outlet and the grease interceptor does not exceed 4 feet and the vertical tailpipe or drain does not exceed 2 1/2 feet.

f. Grease interceptors shall be maintained in efficient operating condition by periodic removal of the accumulated grease. No such collected grease shall be introduced into any drainage piping or sewerage system.

g. Each grease interceptor shall have an approved water seal of not less than 2 inches in depth or the diameter of its outlet, whichever is greater. The grease interceptor outlet shall be properly vented to prevent the trap from siphoning itself out.

h. When grease interceptors are allowed to be installed by the plumbing official in commercial kitchens, the recommended sizing criteria is provided in Table 1005.N.6 of this code below.

Table 1005.N.6 Grease Interceptors	
Required Rate of Flow Per Minute, Gallons	Grease Retention Capacity, Pounds
20	40
25	50
35	70
50	100

Procedure for Sizing Grease Interceptors		
Steps	Formula	Example
1	Determine cubic content of fixture by multiplying length	A sink 48" long by 24" wide by 12" deep.

Procedure for Sizing Grease Interceptors		
Steps	Formula	Example
	x width x depth.	Cubic content 48 x 24 x 12 = 13,824 cubic inches
2	Determine capacity in gallons. 1 gal = 231 cubic inches	Contents in gallons 13,824 ÷ 231 = 59.8 gallons
3	Determine actual drainage load. The fixture is normally filled to about 75 percent of capacity with water. The items being washed displace about 25 percent of the fixture content, thus actual drainage load = 75 percent of fixture capacity.	Actual Drainage Load 0.75 x 59.8 = 44.9 gallons
4	Determine flow rate and drainage period. In general, good practices dictate a 1-minute drainage period; however, where conditions permit, a 2-minute drainage period is acceptable. Drainage period is the actual time required to completely drain the fixture. Flow rate = Actual Drainage Load ÷ Drainage Period	Calculate flow rate for 1-minute period 44.9 ÷ 1 = 44.9 gpm Flow rate Two-minute period 44.9 ÷ 2 = 22.5 gpm Flow Rate
5	Select interceptor which corresponds to the flow rate calculated. Note: Select next larger size when flow rate falls between two sizes listed.	For 1-minute period, 44.9 gpm requires PDI size "50". For 2-minute period, 22.5 gpm requires PDI size "25".

Figure 1005.N.6

7. Oil Separators. The following regulations are applicable to oil separators.

a. All repair garages and gasoline stations with grease racks or grease pits, and all factories which have oily wastes as a result of manufacturing, storage, maintenance, repair, or testing processes shall be provided with an oil separator which shall be connected to all necessary floor drains. The separation of the vapor compartment shall be independently vented to the outer air. If two or more separation or vapor compartments are used, each shall be vented to the outer air or may connect to a header which is installed at a minimum of 6 inches above the spill line of the lowest floor drain and vented independently to the outer air. The minimum size of a flammable vapor vent shall not be less than 2 inches, and when vented through a sidewall, the vent shall not be less than 10 feet above the adjacent level at an approved location. The interceptor shall be vented on the sewer side and this vent shall not connect to a flammable vapor vent. All oil interceptors shall be provided with gastight cleanout covers which shall be readily accessible. The waste line shall not be less than 3 inches in diameter with a full-size two-way cleanout brought to grade_(G). When an interceptor is provided with an overflow, it shall be provided with an overflow line (not less than 2 inches in diameter) to an approved waste oil tank having a minimum capacity of 550 gallons and meeting the requirements of the appropriate authority. The waste oil from the separator shall flow by gravity or shall be pumped to a higher elevation by an automatic pump. Pumps shall be adequately sized and

accessible. Waste oil tanks shall have a 2-inch minimum pumpout connection at grade_(G) and a 1 1/2-inch minimum vent to atmosphere at an approved location at least 10 feet above grade_(G).

b. Each manufactured oil interceptor that is rated shall be stamped or labeled by the manufacturer with an indication of its full discharge rate in gallons per minute (gpm). The full discharge rate to such an oil interceptor shall be determined at full flow. Each oil interceptor shall be rated equal to or greater than the incoming flow and shall be provided with an overflow line to an underground tank.

i. Oil interceptors not rated by the manufacturer shall have a depth of not less than 2 feet below the invert of the discharge drain. The outlet opening shall have not less than an 18-inch water seal and shall have a minimum capacity as follows:

(a). where not more than three motor vehicles are serviced and/or stored, oil interceptors shall have a minimum capacity of 6 cubic feet, and 1 cubic foot of capacity shall be added for each vehicle up to 10 vehicles; and

(b). above 10 vehicles, the plumbing official shall determine the size of the oil interceptor required. Where vehicles are serviced only and not stored, oil interceptor capacity shall be based on a net capacity of 1 cubic foot for each 100 square feet of surface to be drained into the oil interceptor, with a minimum of 6 cubic feet.

c. A combination oil and sand interceptor may be installed when the design is approved in writing by the plumbing official.

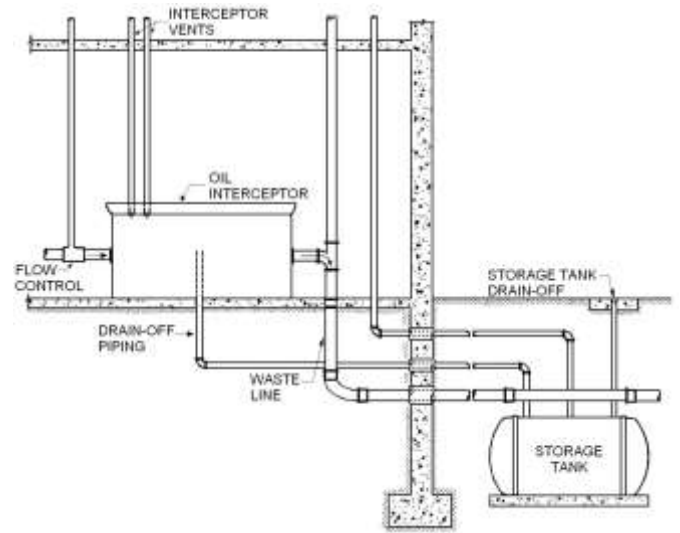

Figure 1005.N.7A—Oil Separator

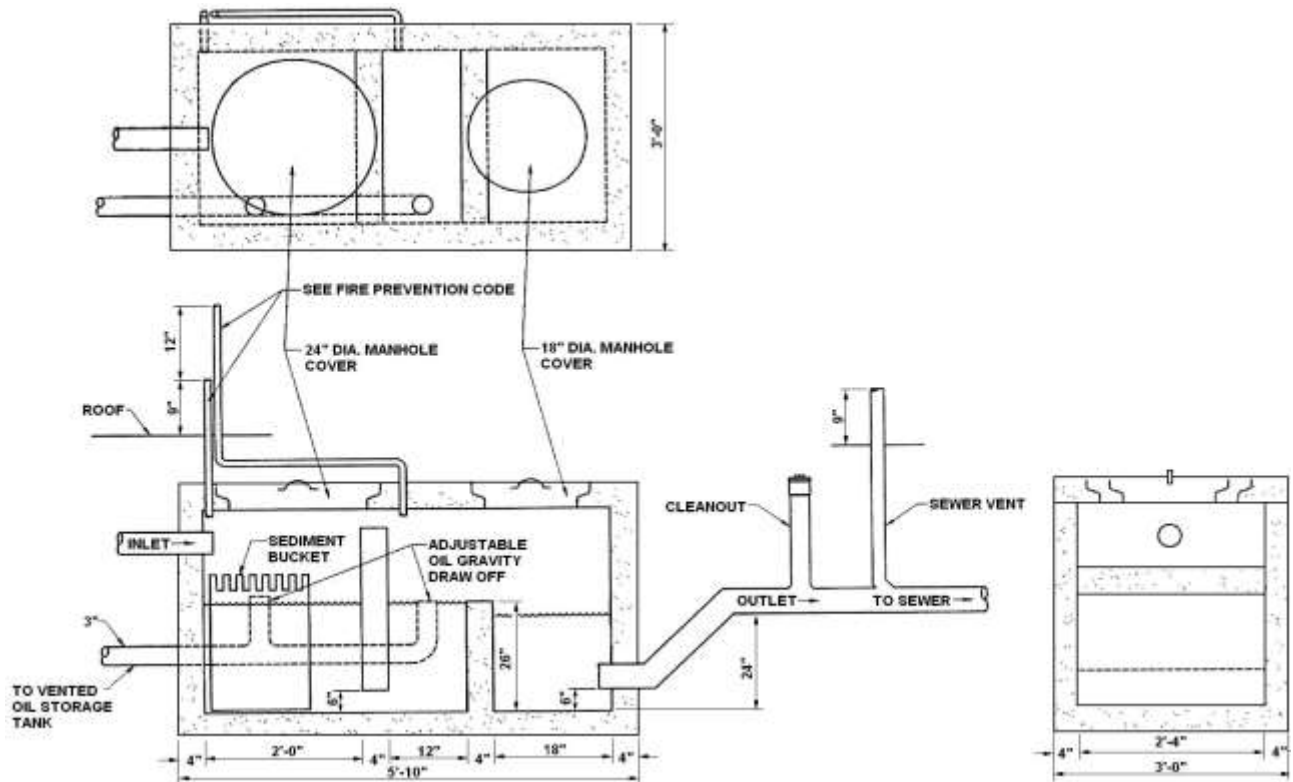

Figure 1005.N.7B—Oil Separator Details

8. Sand Interceptors. The following regulations are applicable to sand interceptors.

a. Multiple floor drains may discharge into one sand interceptor.

b. Sand interceptors shall be built of brick or concrete, prefabricated coated steel, or other watertight material. The sand interceptor shall have an interior baffle for full separation of the interceptor into two sections. The outlet pipe shall be the same size as the inlet, the minimum being 3 inches, and the baffle shall have two openings of the same diameter as the outlet pipe and at the same invert as the outlet pipe. These openings shall be staggered so that there cannot be a straight line flow between any inlet pipe and the outlet pipe. The invert of the inlet pipe shall be no lower than the invert of the outlet pipe.

i. The sand interceptor shall have a minimum dimension of 2-feet square for the net free opening of the inlet screen and a minimum depth under the invert of the outlet pipe of 24 inches.

ii. For each 5 gallons per minute flow or fraction thereof over 20 gallons per minute, the area of the sand interceptor inlet section is to be increased by 1 square foot. The outlet section shall at all times have a minimum area of 50 percent of the inlet sections.

iii. The outlet section shall be covered by a solid removable cover set flush with the finished floor, and the inlet section shall have an open grating set flush with the finished floor and suitable for the traffic in the area in which it is located.

c. Sand and similar interceptors for every solid shall be so designed and located as to be readily accessible for cleaning, shall have a water seal of not less than 6 inches, and shall be vented.

d. Alternate designs for construction or baffling of sand interceptors complying with the intent of this code may be submitted to the plumbing official for approval.

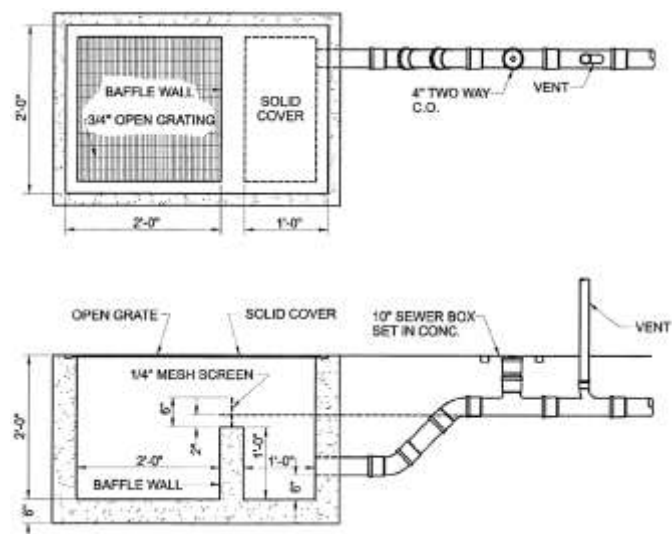

Figure 1005.N.8—Sand Interceptor

9. Laundry Traps. Laundry equipment that does not have integral strainers shall discharge into an interceptor having a wire basket or similar device that is removable for cleaning and that will prevent passage into the drainage system of solids 1/2-inch or larger in maximum dimension, such as string, rags, buttons or other solid materials detrimental to the drainage system. The laundry trap (laundry interceptor/lint trap) and its connection to the drainage system shall conform to the design depicted in Figure 1005.N.9 of this Part. Any modifications of the design shall be approved by the plumbing official. In additions, the size, location and venting of the interceptor shall be approved by the plumbing official.

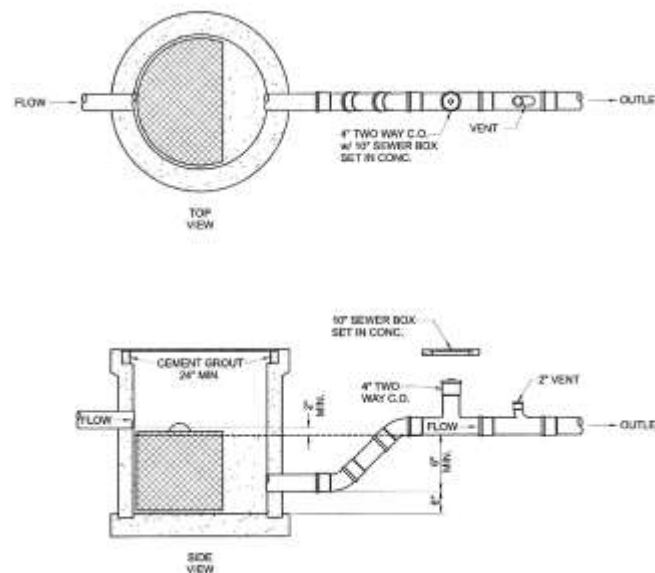

Figure 1005.N.9—Lint Trap (with Non-Corrode Basket)

10. Bottling Separators. Bottling plants shall discharge their process waste water into an interceptor/separator which will provide for the separation of broken glass or other solids before discharging into the drainage system. The design, size, location and venting of the bottling separator shall be approved by the plumbing official.

11. Slaughter House Separators. Slaughtering room drains shall be equipped with separators which shall prevent the discharge into the drainage system of feathers, entrails and other materials likely to clog the drainage system. The design, size, location and venting of the slaughter house separator shall be approved by the plumbing official.

12. Special Type Separators

a. Every fish, fowl and animal slaughter house or establishment and every fish, fowl and meat packing or curing establishment and every soap factory, tallow rendering, fat rendering and hide curing establishment, or any other establishment from which considerable amounts of grease are likely to be discharged into any plumbing system, community sewerage system, commercial treatment facility, or individual sewerage system, shall be connected to and shall drain or discharge into a grease trap meeting the

requirements of this Section and approved by the plumbing official for this use.

b. Interceptors or separators for other special type applications shall not be installed until their design, size, location and venting have been approved by the plumbing official.

AUTHORITY NOTE: Promulgated in accordance with R.S. 40:4(A)(7) and R.S. 40:5(2)(3)(7)(9)(16)(17)(20).

HISTORICAL NOTE: Promulgated by the Department of Health and Hospitals, Office of Public Health, LR 38:2869 (November 2012).

Chapter 11. Storm Drainage

§1101. General

A. Scope. The provisions of this Chapter shall govern the materials, design, construction, and installation of storm drainage.

B. Drainage Required. Roofs, paved areas, yards, courts and courtyards shall be drained into a storm sewer system.

1. Exception. Dumpster pad drains shall connect to the sanitary sewerage system in accordance with LAC 51:XXIII.3307.

C. Prohibited Drainage. Storm water shall not be drained into sewers intended for sewage only.

D. Expansion Joints. Expansion joints or sleeves shall be provided where warranted by temperature variations or physical conditions.

E. Subsoil Drains. Where subsoil drains are placed under the cellar or basement floor or are used to surround the outer walls of a building, they shall be made of open-jointed or horizontally split or perforated clay tile, asbestos cement pipe, or plastic pipe meeting the requirements of Table 703 of this code, not less than 4-inch diameter. When the building is subject to backwater, the subsoil drain shall be protected by an accessibly located backwater valve. Subsoil drains may discharge into a properly trapped area drain or sump. Such sumps do not require vents.

F. Building Subdrains. Building subdrains located below the building storm sewer level shall discharge into a sump or receiving tank, the contents of which shall be automatically lifted and discharged into the building gravity drainage system as required for building sumps.

G. Pumping System. Pumping systems installed to remove contents of collecting sumps shall include the sump pump, pit, and discharge piping as defined below.

1. Sump Pump. An automatic water pump for the removal of drainage from a sump, pit, or low point in a residential, commercial, or industrial property shall be of a capacity and head appropriate to anticipated use requirements.

2. Sump Pit. The sump pit size shall be not less than 18-inch (457 mm) diameter and may be constructed of tile, steel, plastic, cast iron, concrete, or other material accepted by the plumbing official, topped by a removable cover

adequate to support anticipated loads in area of use. The pump floor shall provide permanent support for the pump.

3. Electrical service outlets, when required, shall meet the requirements of NFPA 70 or local codes.

4. Discharge piping shall meet the requirements of §1103.A, §1103.B, §1103.C or §1103.D of this code and shall include a gate valve and a full flow check valve. Size and fittings shall be the same size as, or larger than, pump discharge tapping.

H. Backwater Devices. The installation of backwater devices as protection for fixtures subject to backflow shall be in accordance with requirements of this Part.

I. Tests. The interior leaders and downspouts system shall be tested in accordance with §319.E of this code.

AUTHORITY NOTE: Promulgated in accordance with R.S. 40:4(A)(7) and R.S. 40:5(2)(3)(7)(9)(16)(17)(20).

HISTORICAL NOTE: Promulgated by the Department of Health and Hospitals, Office of Public Health, LR 38:2878 (November 2012).

§1103. Materials

A. Inside Conductors Including Above Ground Storm Drains. Conductors placed within buildings or run in vent or pipe shafts shall be aluminum, cast iron, galvanized steel, galvanized ferrous alloys, brass, copper tubing of a weight not less than that of copper drainage tube Type DWV, copper pipe or Schedule 40 plastic pipe.

B. Building Storm Drains. All building storm drains shall be of materials required for building drains in §§703.C and 703.D of this code.

C. Underground Building Storm Drains. Underground building storm drains, inside the building perimeter, shall be of cast iron soil pipe, ferrous-alloy piping, copper tube Type DWV, or Schedule 40 plastic piping.

D. Building Storm Sewers. The building storm sewer shall be of cast iron soil pipe, vitrified-clay pipe, concrete pipe, or plastic pipe meeting the requirements of Table 703 of this code.

AUTHORITY NOTE: Promulgated in accordance with R.S. 40:4(A)(7) and R.S. 40:5(2)(3)(7)(9)(16)(17)(20).

HISTORICAL NOTE: Promulgated by the Department of Health and Hospitals, Office of Public Health, LR 38:2878 (November 2012).

§1105. Specifications

A. Pipe, tubing, and fittings for storm drainage systems shall conform to the standards listed in Table 703 of this code.

AUTHORITY NOTE: Promulgated in accordance with R.S. 40:4(A)(7) and R.S. 40:5(2)(3)(7)(9)(16)(17)(20).

HISTORICAL NOTE: Promulgated by the Department of Health and Hospitals, Office of Public Health, LR 38:2878 (November 2012).

§1107. Conductors and Connections

A. Protection. Rain water conductors installed along alleyways, driveways, or other locations where they may be exposed to damage shall be protected.

B. Separation of Storm Drainage from Sanitary Sewers. The sanitary sewer and storm drainage systems of a building shall be entirely separate.

C. Floor Drains. Floor drains shall not be connected to a storm drain.

AUTHORITY NOTE: Promulgated in accordance with R.S. 40:4(A)(7) and R.S. 40:5(2)(3)(7)(9)(16)(17)(20).

HISTORICAL NOTE: Promulgated by the Department of Health and Hospitals, Office of Public Health, LR 38:2878 (November 2012).

§1109. Roof Drains

A. Material. Roof drains shall be of an approved corrosion resistant material with adequate strainer area and shall comply with the applicable standards in Table 303 of this code.

B. Strainers. When roof drains are provided they shall have strainers extending not less than 4 inches (102 mm) above the surface of the roof immediately adjacent to the roof drain. Strainers shall have an available inlet area, above roof level, of not less than one and a half times the area of the conductor or leader to which the drain is connected.

C. Flat Decks. Roof drain strainers for use on sun decks, parking decks, and similar areas, normally serviced and maintained, may be of the flat surface type, level with the deck and shall have an available inlet area not less than two times the area of the conductor or leader to which the drain is connected.

D. Roof Drain Flashings. The connection between roofs and roof drains which pass through the roof and into the interior of the building shall be made watertight by the use of proper flashing material.

AUTHORITY NOTE: Promulgated in accordance with R.S. 40:4(A)(7) and R.S. 40:5(2)(3)(7)(9)(16)(17)(20).

HISTORICAL NOTE: Promulgated by the Department of Health and Hospitals, Office of Public Health, LR 38:2878 (November 2012).

§1111. Size of Leaders and Storm Drains

A. Vertical Leaders. Vertical leaders shall be sized for the maximum projected roof area, according to Table 1111.A of this code below. If a vertical offset is 45 degrees or less, the leader can be sized as a vertical pipe. If the offset is greater than 45 degrees, the pipe must be sized as a horizontal pipe.

Table 1111.A Size of Vertical Leaders	
Size of Leader or Conductor ¹ (in)	Maximum Projected Roof Area (sq ft)
2	720
2 1/2	1300
3	2200
4	4600
5	8650

Table 1111.A Size of Vertical Leaders	
Size of Leader or Conductor ¹ (in)	Maximum Projected Roof Area (sq ft)
6	13,500
8	29,000

NOTE:

1. The equivalent diameter of square or rectangular leader may be taken as the diameter of that circle which may be inscribed within the cross-sectional area of the leader. See also §1111.B.2 of this code.

B. Building Storm Drains. Building storm drains shall comply with the following.

1. The size of the building storm drain or any of its horizontal branches having a slope of 1/2-inch or less per foot (41.6 mm/m) shall be based upon the maximum projected roof area to be handled according to Table 1111.B of this code below.

Table 1111.B Size of Horizontal Storm Drains			
Diameter of Drain (in)	Maximum Projected Roof Area for Drains of Various Slopes (sq ft)		
	1/8 in Slope	1/4 in Slope	1/2 in Slope
3	822	1,160	1,644
4	1,880	2,650	3,760
5	3,340	4,720	6,680
6	5,350	7,550	10,700
8	11,500	16,300	23,000
10	20,700	29,200	41,400
12	33,300	47,000	66,600
15	59,500	84,000	119,000

2. Tables 1111.A and 1111.B of this code above are based upon a rate of rainfall of 4 inches (102 mm) per hour. If in any state, city or other political subdivision, the maximum rate of rainfall is more or less than 4 inches (102 mm) per hour, then the figures for roof area shall be adjusted proportionately by dividing the figure by four and multiplying by the maximum rate of rainfall in inches (mm) per hour. See §1111.E of this code.

C. Blockage Avoidance. To avoid stoppages, building drainage piping cannot be reduced in size in the direction of flow throughout its length. i.e., an 8-inch (203-mm) horizontal building storm drain must tie to an 8-inch (203-mm) vertical leader, even if Table 1111.A of this code allows for a smaller size for the vertical leader.

D. Vertical Walls. In sizing roof drains and storm drainage piping, one-half (1/2) of the area of any vertical wall which diverts rain water to the roof shall be added to the projected roof area for inclusion in calculating the required size of vertical leaders and horizontal storm drainage piping.

E. Maximum Rates of Rainfall. Primary roof drain systems shall be designed using Tables 1111.A and 1111.B of this code and adjusted in accordance with §1111.B.2 of this code for the local rainfall for a 60 minute duration and a 100-year return period in Figure 1111.E of this Part. The plumbing official may approve local weather data on the maximum rate of rainfall when available.

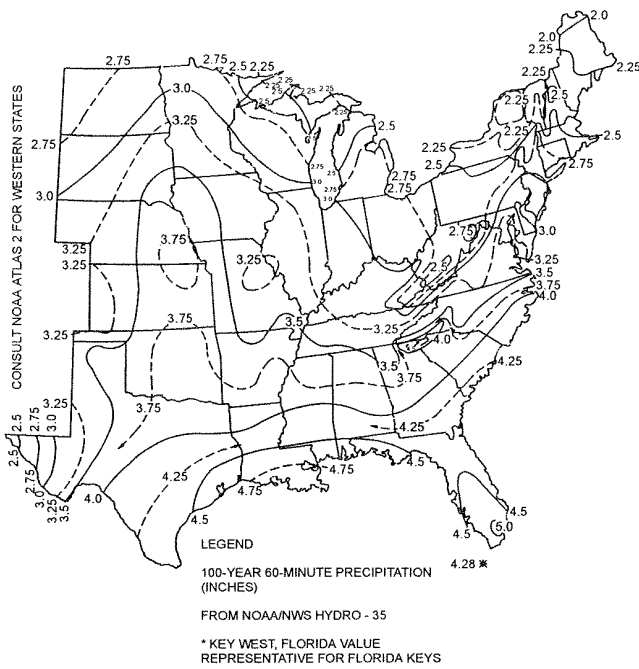

Figure 1111.E—Rainfall Rate for Primary Roof Drains (in./hr.)

F. Parapet Wall Scupper Location. The location of parapet wall roof drainage scuppers and overflow scuppers shall be such that discharge can cause no personal injury or property damage. When neither conductor heads nor gutters are used to catch the water, scupper spouts shall extend past the exterior surface of the building to avoid wetting the building surface.

AUTHORITY NOTE: Promulgated in accordance with R.S. 40:4(A)(7) and R.S. 40:5(2)(3)(7)(9)(16)(17)(20).

HISTORICAL NOTE: Promulgated by the Department of Health and Hospitals, Office of Public Health, LR 38:2879 (November 2012).

§1113. Secondary (Emergency) Roof Drains

A. Secondary Drainage Required. Secondary (emergency) roof drains or scuppers shall be provided where the roof perimeter construction extends above the roof in such a manner that water would be entrapped should the primary drains allow buildup for any reason.

B. Separate Systems Required. Secondary roof drain systems shall have piping and point of discharge separate from the primary system. Discharge shall be above grade_(G) in a location which would normally be observed by the building occupants or maintenance personnel.

C. Maximum Rainfall Rate for Secondary Drains. Secondary (emergency) roof drain systems or scuppers shall be sized based on the flow rate caused by the 100-year 15 minute precipitation as indicated in Figure 1113.C of this Part. The flow through the primary system shall not be considered when sizing the secondary roof drain system.

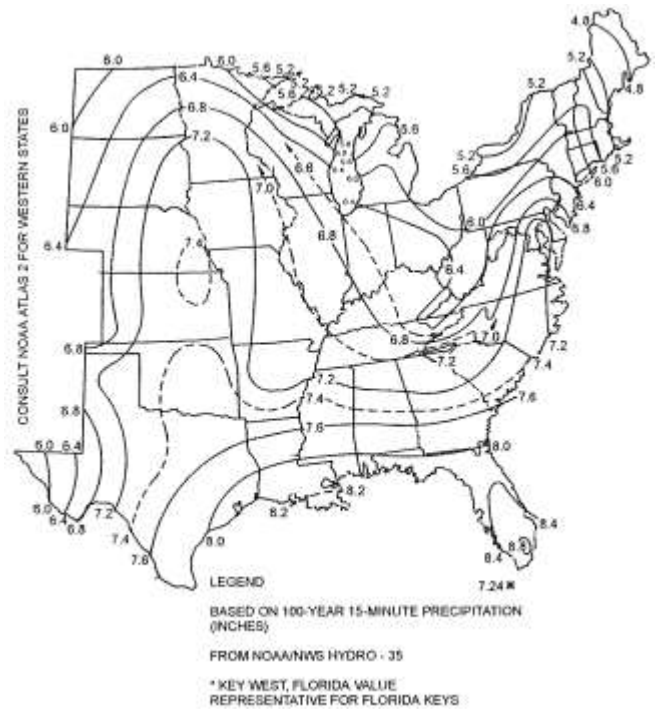

Figure 1113.C—Rainfall Rate for Primary Roof Drains (in./hr.)

AUTHORITY NOTE: Promulgated in accordance with R.S. 40:4(A)(7) and R.S. 40:5(2)(3)(7)(9)(16)(17)(20).

HISTORICAL NOTE: Promulgated by the Department of Health and Hospitals, Office of Public Health, LR 38:2879 (November 2012).

§1115. Values for Continuous Flow

A. Where there is a continuous or semicontinuous discharge into the building storm drain or building storm sewer, as from a pump, ejector, air conditioning plant, or similar device, each gallon per minute of such discharge shall be computed as being equivalent to 24 sq ft (2.23 m²) of roof area, based upon a 4-inch (102 mm) rainfall.

AUTHORITY NOTE: Promulgated in accordance with R.S. 40:4(A)(7) and R.S. 40:5(2)(3)(7)(9)(16)(17)(20).

HISTORICAL NOTE: Promulgated by the Department of Health and Hospitals, Office of Public Health, LR 38:2880 (November 2012).

§1117. Additional Information for Storm Drainage

A. Additional information for storm drainage is contained in Chapter 18 (Appendices) of this code, §1803 (Appendix A - Roof Drain Sizing Method). Such additional information in Chapter 18 shall not be construed as superceding any pertinent regulation(s) contained in Chapters 1-17 of this code.

AUTHORITY NOTE: Promulgated in accordance with R.S. 40:4(A)(7) and R.S. 40:5(2)(3)(7)(9)(16)(17)(20).

HISTORICAL NOTE: Promulgated by the Department of Health and Hospitals, Office of Public Health, LR 38:2880 (November 2012).

Chapter 12. Alternate Designed Plumbing Systems

§1201. General

A. Approval of alternate designed plumbing systems will be considered on an individual basis.

AUTHORITY NOTE: Promulgated in accordance with R.S. 40:4(A)(7) and R.S. 40:5(2)(3)(7)(9)(16)(17)(20).

HISTORICAL NOTE: Promulgated by the Department of Health and Hospitals, Office of Public Health, LR 38:2880 (November 2012).

§1203. Requirements for Approval

A. Plans and Specifications. Plans and specifications for any proposed alternate designed plumbing system shall be submitted to the state health officer for review and approval prior to construction. Such plans and specifications shall be appropriately sealed and signed by a Louisiana Registered Professional Engineer registered in either civil or mechanical engineering.

B. Responsibility of Professional Engineer. The Professional Engineer referenced in §1203.A of this code shall be responsible for:

1. certifying the system design;
2. inspecting the system during installation;
3. certifying that the installed system is in compliance with the approved design specifications;
4. supervising any test(s) performed on the system; and,
5. certifying the results of any required testing.

C. Owner's Notice. Any permits issued for an alternate designed plumbing system shall be issued only after the owner of the building has assured the state health officer in writing that he is aware of the third party notification requirements of §1207 of this code. In addition, any permits issued for work requiring a performance test shall be issued only after the owner of the building has assured the state health officer in writing that he is also aware of the testing requirements of §1205 of this code.

AUTHORITY NOTE: Promulgated in accordance with R.S. 40:4(A)(7) and R.S. 40:5(2)(3)(7)(9)(16)(17)(20).

HISTORICAL NOTE: Promulgated by the Department of Health and Hospitals, Office of Public Health, LR 38:2880 (November 2012).

§1205. Tests

A. General Testing Requirements. The state health officer and/or the local plumbing official may also require tests to be conducted prior to occupancy to assure that the proposed design is satisfactory and complies with the intent of this code. Such tests shall be made in accordance with approved standards, but in the absence of such standards, the state health officer and/or the local plumbing official shall specify the test procedure(s). In general, such tests shall indicate that all fixtures properly discharge when flushed simultaneously with not less than 1-inch (25.4mm) of water

seal left in the trap after testing and that there is no evidence of sewer gas passing through the trap seal.

B. Roughing-In. The roughing-in test shall be as provided for in other Chapters of this code.

C. Tests and Inspection of the Single Stack Discharge and Ventilating Pipe System or any other Single Stack Plumbing System. When a single stack discharge and ventilating pipe system (a specific type of alternate designed plumbing system) or any other single stack plumbing system has been approved by the state health officer under the requirements of this Chapter, the following tests/inspections shall be performed.

1. Performance Test Required. In any building in which fixtures or appliances, other than those specifically provided for in Table 1811.D.5.5A of this code, are to be installed or in existing buildings in which the single stack discharge and ventilating pipe system or any other single stack plumbing system exists and additional fixtures are to be added, the plumbing official shall require and supervise a performance test as hereafter provided.

2. Application and Restrictions. When required in new construction, the system shall successfully pass the test before the building is permitted to be occupied. In existing buildings where piping is added for additional fixtures or appliances, such new piping shall not be placed in service until the performance test is approved. Should the system fail to pass the test, the new construction shall be modified as the plumbing official may direct, or the system shall be reconstructed to meet the requirements of other Chapters of this code, or the added fixtures and appliances shall be removed and all waste and vent pipes permanently closed so as to form no dead ends and all wall and other openings shall be put back in their original or finished condition.

a. Exception. Central washing facilities connected separately to the building drain or sewer in an installation that is otherwise constructed in accordance with other Chapters of this code are exempt from the performance testing prescribed by this Section.

3. Performance Test. Every trap shall retain not less than 1-inch (25.4 mm) of seal when subjected to the appropriate discharge tests given below. These tests are designed to simulate the probable worst conditions in practice. Each test should be repeated three times, the trap being recharged before each test, and the maximum loss of seal in any one test, measured by a dip stick, shall be taken as the significant result. The number of fixtures to be discharged simultaneously when investigating the effect of the flow of water down the stack depends on the number of fixtures and on the frequency with which they are used. The number of fixtures to be discharged simultaneously is given in Table 1811.D.11 of this code.

4. Test for Self-Siphonage. To test for the effect of self-siphonage, the waste fixture shall be filled to overflowing level and discharged in the normal way. The seal remaining in the trap shall be measured when the discharge has finished. This test is most important for wash

basins, but it is not applicable for water closets which shall be flushed in the normal manner.

AUTHORITY NOTE: Promulgated in accordance with R.S. 40:4(A)(7) and R.S. 40:5(2)(3)(7)(9)(16)(17)(20).

HISTORICAL NOTE: Promulgated by the Department of Health and Hospitals, Office of Public Health, LR 38:2880 (November 2012).

§1207. Third Party Notification

A. After installation of any alternate designed plumbing system, the owner shall notify third parties of its existence by having a document recorded in the Clerk of Court's conveyance records in the parish in which such alternate designed plumbing system has been installed. The document so recorded shall reference a prior conveyance record (COB/folio) of the parcel of ground upon which the alternate designed plumbing system is located (e.g., the conveyance recording a previous Act of Sale of the parcel of ground). The document will state that the plumbing of the building located on this particular parcel of ground contains an "alternate designed plumbing system" which cannot be modified in any manner by future owners/lessees without first obtaining an approval of such proposed modifications from the state health officer in accord with the requirements of Chapter 12 (Alternate Designed Plumbing Systems) of this code. Proof of recordation shall be provided to the state health officer and the local plumbing official prior to issuance of a building occupancy permit.

AUTHORITY NOTE: Promulgated in accordance with R.S. 40:4(A)(7) and R.S. 40:5(2)(3)(7)(9)(16)(17)(20).

HISTORICAL NOTE: Promulgated by the Department of Health and Hospitals, Office of Public Health, LR 38:2881 (November 2012).

Chapter 13. Medical Facilities Plumbing Systems [formerly Appendix G—Medical Facilities Plumbing Systems]

§1301. General

A. Scope. The following Subparagraphs provide the scope of this Chapter.

1. The provisions of this Chapter are intended to set out those items of hospital/medical facilities plumbing systems which differ from plumbing systems in other buildings. Special care shall be accorded the hospital plumbing system because of its direct relationship to adequate medical care and the need for added protection for patients and hospital personnel from health hazards.

2. It is understood that hospital/medical facilities plumbing systems shall conform not only to the requirements of this Chapter, but also to the requirements contained in the other Chapters of this code.

3. The provisions of this Chapter shall apply to plumbing installations in clinics, doctors' offices, nursing homes, and other medical facilities, etc., as well as in hospital installations.

B. Definitions. The following words and terms shall, for the purposes of this Chapter and as stated elsewhere in this code, have the meanings shown herein. Refer to Chapter 2 of this code for general definitions.

Aspirator—a fitting or device supplied with water or other fluid under positive pressure which passes through an integral orifice or constriction causing a vacuum. (*Aspirators* are often referred to as suction apparatus, and are similar in operation to an ejector.)

Autoclave—see *sterilizer, pressure*.

Autopsy Table—a *fixture* or table used for post-mortem examination of a body.

Bedpan Hopper—see *clinical sink*.

Bedpan Steamer or *Bedpan Boiler*—a *fixture* used for scalding bedpans or urinals by direct application of steam or boiling water.

Bedpan Washer and Sterilizer—a *fixture* designed to wash bedpans and to flush the contents into the *sanitary drainage system*. It may also provide for emptying, cleaning, and sometimes for steaming bedpans, and for no other purpose.

Bedpan Washer Hose—a device supplied with hot and cold water and located adjacent to a water closet or *clinical sink* to be used for cleansing bedpans.

Clean Utility Room—a workroom, normally located near the nurses' station, designed and equipped to facilitate the heating and refrigeration of food items, placement of an ice machine, and/or the preparation, cleaning and incidental sterilization of the various supplies, instruments, utensils, etc., involved in nursing treatment and care.

Clinical Sink—a *fixture* meeting the design requirements of §1303.B of this code for the rinsing of bedpans and soiled linen. Such fixtures shall have a *trap* size of not less than 3 inches.

Effective Opening—the minimum cross-sectional area of the *water outlet* at the point of water supply discharge or the minimum cross-sectional area of the *liquid waste outlet* at the point of *indirect waste pipe* discharge, measured or expressed in terms of:

- a. diameter of a circle; or,
- b. if the outlet is not circular, the diameter of a circle of equivalent cross-sectional area.

[This term is applicable to and mainly used when determining the minimum unobstructed vertical distance through the free atmosphere {*air gap (water distribution)*} required between the *water outlet* and the *flood rim level* of the *fixture* or receptacle into which it is discharging. This term may also be applicable when determining the minimum unobstructed vertical distance through the free atmosphere {*air gap (drainage system)*} required between a *liquid waste outlet* of an *indirect waste pipe* and the *flood rim level* of the *indirect waste receptor*.]

Medical Facilities—hospitals, ambulatory surgical centers, renal dialysis centers, nursing homes, doctor's offices, clinics, and similar facilities providing medical care.

Nurses' Station—an area in the nursing unit separated from the corridor by counter or desk, designed to permit nurses to record and file each patient's history and progress, observation and control of corridor, preparation of medicines and maintain contact with patients, the hospital and the outside by local and public means of communication.

Scrub Sink—a device usually located in the operating suite to enable operating personnel to scrub their hands prior to the operating procedure. The hot and cold water supply is activated by a knee-action mixing valve or by wrist or pedal control

Soiled Utility Room—a small workroom, normally located near the nurses' station, which is designed and equipped for emptying, cleaning, and sometimes for steaming bedpans and patient urinals, and for no other purpose.

Sterilizer, Boiling Type—a device or *fixture* of the non-pressure design which is used for boiling instruments, utensils, and other equipment in order to disinfect them. Some devices are portable and others are connected to the *plumbing system*.

Sterilizer, Instrument—a device for the sterilization of various instruments.

Sterilizer, Pressure—a device or *fixture* of the pressure vessel design which uses steam under pressure for sterilizing. Also called an *autoclave*.

Sterilizer, Pressure Instrument Washer Sterilizer—a device or *fixture* of the pressure vessel design which both washes and sterilizes instruments during the operating cycle of the device or *fixture*.

Sterilizer, Utensil—a device or *fixture* for the sterilization of utensils used in hospital services.

Sterilizer Vent—a separate pipe or *stack*, indirectly connected to the building *drainage system* at the lower terminal, which receives the vapors from non-pressure sterilizers, or the exhaust vapors from *pressure sterilizers*, and conducts the vapors directly to the outer air. Sometimes called vapor, steam, atmospheric, or exhaust vent.

Sterilizer, Water—a device for sterilizing water and storing sterile water.

Still—a device used in distilling liquids.

AUTHORITY NOTE: Promulgated in accordance with R.S. 40:4(A)(7) and R.S. 40:5(2)(3)(7)(9)(16)(17)(20).

HISTORICAL NOTE: Promulgated by the Department of Health and Hospitals, Office of Public Health, LR 38:2881 (November 2012).

§1303. Fixtures

A. Bedpans. Acceptable flush rim bedpan hoppers (clinical sink), bedpan washers, and/or other acceptable fixtures and equipment shall be provided for the disposing of bedpan contents and the cleansing and disinfection of bedpans in soiled utility rooms.

B. Clinical Sink. A clinical sink shall have an integral trap in which the upper portion of a visible trap seal provides a water surface. The fixture shall be so designed as to permit complete removal of the contents by siphonic or blowout action, or both, and to reseal the trap. A flushing rim shall provide water to cleanse the interior surface. The fixture shall have flushing and cleansing characteristics similar to a water closet.

C. Prohibited Use of Clinical and Service Sinks. A clinical sink serving a soiled utility room shall not be considered as a substitute for, nor shall it be used as, a janitor's service sink. A janitor's service sink shall not be used for the disposal of urine, fecal matter, or other human waste.

D. Ice Prohibited in Soiled Utility Room. Machines for manufacturing ice, or any device for the handling or storage of ice, shall not be located in a soiled utility room. Machines for manufacturing ice, or devices for handling or storage of ice intended for either human consumption or packs, may be located in a clean utility room, floor pantry, or diet kitchen.

E. Sterilizer Equipment Requirements. The following apply to sterilizer equipment.

1. It shall be unlawful to de-scale or otherwise submit the interior of water sterilizers, stills, or similar equipment to acid or other chemical solutions while the equipment is connected to the water or drainage system.

2. New pressure sterilizers and pressure instrument washer-sterilizers hereafter installed shall display, in a location clearly visible at all times, the ASME Standard symbol and data plate.

3. All sterilizer piping and devices necessary for the operation of sterilizers shall be accessible for inspection and maintenance, and shall satisfy the following.

a. Steam supplies to sterilizers, including those connected by pipes from overhead mains or branches, shall be drained to prevent any excess moisture from reaching the sterilizer. The condensate drainage from the steam supply shall be discharged by gravity.

b. Steam condensate return from sterilizers shall not be connected to pressure or vacuum return systems; only gravity returns shall be acceptable. Steam condensate returns from sterilizers shall not be connected to overhead mains or branches.

c. Pressure sterilizers should be equipped with an acceptable means of condensing and cooling the exhaust steam vapors. Nonpressure sterilizers should be equipped with an acceptable device which will automatically control the vapors in a manner so as to confine them within the vessel, or equipped with an acceptable means of condensing and cooling the vapors.

d. Gas fired equipment or apparatus, requiring either water or drainage connections or both, shall meet the standards of the American National Standards Institute.

F. **Special Elevations.** Control valves, vacuum outlets, and devices which protrude from a wall of an opening, emergency, recovery, examining, or delivery room, or in a corridor or other locations where patients may be transported on a wheeled stretcher, shall be so located at an elevation which will preclude bumping the patient or stretcher against the device. When necessary to install at a low elevation, safety precautions should be taken to protect the personnel.

G. **Plumbing in Mental Hospitals.** In mental hospitals, special consideration should be given to piping, controls and fittings of plumbing fixtures as required by the types of mental patients being treated. Pipes or traps should not be exposed, and fixtures should be substantially bolted through walls.

H. **Handwashing Facilities.** Medical facilities, including doctor's offices and clinics, shall be provided with hand washing facilities within each patient examination and treatment room. The hand wash facility shall be provided with hot and cold water delivered via a mixing faucet.

AUTHORITY NOTE: Promulgated in accordance with R.S. 40:4(A)(7) and R.S. 40:5(2)(3)(7)(9)(16)(17)(20).

HISTORICAL NOTE: Promulgated by the Department of Health and Hospitals, Office of Public Health, LR 38:2882 (November 2012).

§1305. Drainage and Venting

A. **Ice Storage Chest Drains.** Any drain serving an ice storage chest or box shall discharge over an indirect waste receptor separate from all other fixture wastes. Each terminal shall discharge through an air gap (drainage system) above the receptor. The end shall be covered with a removable screen of not less than 10 mesh per square inch (15.5 mesh per 1000 sq mm), and if discharging vertically, the terminal shall be cut at an angle of 45° (0.785 rad).

B. **Bedpan Washers and Clinical Sinks.** Bedpan washers and clinical sinks shall be connected to the soil pipe system and vented following the requirements as applied to water closets, except that bedpan washers require additional local vents.

C. **Sterilizer Wastes.** Wastes for sterilizers shall conform with the following.

1. **Indirect Wastes Required.** All sterilizers shall be provided with individual and separate indirect wastes, with air gaps (drainage system) of not less than two diameters of the waste tailpiece. The upper rim of the receptor, funnel, or basket type waste fitting shall be not less than 2 inches (51 mm) below the vessel or piping, whichever is lower. Except as provided in Paragraphs 2 and 4 below of §1305.C, a "P" trap shall be installed on the discharge side of, and immediately below, the indirect waste connection serving each sterilizer.

2. **Recess Room Floor Drain.** Floor drains in a room or area where the sterilizer is recessed shall conform with the following.

a. In all recess rooms containing the recessed or concealed portions of sterilizers, not less than one acceptable

floor drain, connecting to the drainage system, shall be installed in a manner to drain the entire floor area.

b. The recess room floor drain waste and trap shall be a minimum 3-inch (76 mm) diameter. It shall receive the drainage from at least one sterilizer within the recess room to assure maintenance of the floor drain trap seal. The sterilizer drain shall be installed on a branch taken off between the floor drain trap and the drain head. An individual waste trap shall not be required on this type of installation.

3. **Prohibited Connections.** Branch funnel and branch basket type fittings, except as provided in §1305.C.4 of this code below, are prohibited on any new installation or when relocating existing equipment. Existing branch funnel or branch basket type installations shall be provided with an acceptable indirect waste below the branch connections.

4. **Battery Assemblies.** A battery assembly of not more than three sterilizer wastes may drain to one trap, provided the trap and waste are sized according to the combined fixture unit rating, the trap is located immediately below one of the indirect waste connections, the developed distance of a branch does not exceed 8 feet (2438 mm), and the branches change direction through a tee-wye or wye pattern fitting.

5. **Bedpan Steamers, Additional Trap Required.** A trap with a minimum seal of 3 inches (76 mm) shall be provided in a bedpan steamer drain located between the fixture and the indirect waste connection.

6. **Pressure Sterilizer.** Except when an exhaust condenser is used, a pressure sterilizer chamber drain may be connected to the exhaust drip tube before terminating at the indirect waste connection. If a vapor trap is used, it shall be designed and installed to prevent moisture being aspirated into the sterilizer chamber. The jacket steam condensate return, if not connected to a gravity steam condensate return, shall be separately and indirectly wasted. If necessary to cool a high temperature discharge, a cooling receiver, trapped on its discharge side, may serve as the fixture trap.

7. **Pressure Sterilizer Exhaust Condensers.** The drain from the condenser shall be installed with an indirect waste as prescribed in this Part. If condensers are used on pressure sterilizers, the chamber drain shall have a separate indirect waste connection.

8. **Water Sterilizer.** All water sterilizer drains, including tank, valve leakage, condenser, filter and cooling, shall be installed with indirect waste and according to §1305.C.2.a of this code.

9. **Pressure Instrument Washer-Sterilizer.** The pressure instrument washer-sterilizer chamber drain and overflow may be interconnected. Also, they may be interconnected with the condensers. The indirect waste shall follow the provision set forth in this Part.

D. **Aspirators.** In operating rooms, emergency rooms, recovery rooms, delivery rooms, examining rooms, autopsy rooms, and other locations except laboratories, where

aspirators are installed for removing blood, pus, or other fluids, the discharge from any aspirator shall be indirectly connected to the drainage system. The suction line shall be provided with a bottle or similar trap to protect the water supply.

E. Vacuum System Stations. Vacuum system station locations shall be considered from the standpoint of convenience and practical use. The receptacles should be built into cabinets or recesses but shall be visible and readily accessible.

F. Bottle System. Vacuum (fluid suction) systems intended for collecting, removing or disposing of blood, pus or other fluids by the so-called bottle system shall be provided with receptacles, which are equipped with an overflow preventative device, at each vacuum outlet station. Each vacuum outlet station should be equipped with a secondary safety receptacle as an additional safeguard against fluids, other than air entering the vacuum piping systems.

G. Central Disposal System Equipment. All central vacuum (fluid suction) systems shall assure continuous service. Systems equipped with collecting or control tanks shall provide for draining and cleaning of the tanks while the system is in operation. In hospitals or institutions having emergency power provisions, the system shall be capable of remaining in service during the use of emergency power. The exhausts from a vacuum pump used in connection with a vacuum (fluid suction) system shall discharge separately to the outer atmosphere. The exhaust discharge shall not create a nuisance or hazard within, without, around or about the premises. Termination of the exhaust to the atmosphere shall be the same as required for sanitary sewer vents.

H. Central Vacuum and Disposal Systems. Central vacuum and disposal systems shall conform with the following.

1. The waste from a central vacuum (fluid suction) system of the disposal type which is connected to the drainage system, whether the disposal be by barometric lag, collection tanks, or bottles, shall be directly connected to the sanitary drainage system through a trapped waste.

2. The piping of a central vacuum (fluid suction) system shall be of corrosion resistant material having a smooth interior surface. A branch shall not be less than 1/2-inch for one outlet and sized according to the number of vacuum outlets, and a main shall not be less than 1-inch. The pipe sizing shall be increased according to acceptable engineering practices. All piping shall be provided with adequate and accessible cleanout facilities on mains, and branches, and shall be accessible for inspection, maintenance, and replacements.

- I. Condensate Drains for Space Cooling and Heating Systems. The lowest point of a condensate riser or risers shall be trapped and discharged over an indirect waste sink. The trap may be either a "P" or a "running trap" with a cleanout. A branch shall be installed upstream from the condensate drain trap for flushing and resealing purposes.

The condensate drain and trap shall be located above the lowest floor level of the building.

- J. Vent Material. Material for local vents serving bedpan washers and sterilizer vents serving sterilizers shall be sufficiently rust proof, erosion and corrosion resistant to withstand intermittent wetting and drying from steam vapors, to withstand the distilled water solvent action of the steam vapors and to withstand frequent and immediate changes of temperatures.

- K. Vent Connections Prohibited. Connections between local vents serving bedpan washers, sterilizer vents serving sterilizing apparatus and normal sanitary plumbing systems are prohibited. Furthermore, only one type of apparatus shall be served by a given local vent.

- L. Local Vents and Stacks. Local vents and stacks shall comply with the following.

1. Bedpan washers shall be vented to the outer atmosphere by means of one or more local vents. Termination of the vent to the atmosphere shall be the same as required for sanitary sewer vents. The local vent for a bedpan washer shall not be less than a 2-inch diameter pipe. A local vent serving a single bedpan washer may drain to the fixture served.

2. Where bedpan washers are located above each other on more than one floor, a local vent stack may be installed to receive the local vent on the various floors. More than three bedpan washers shall not be connected to a 2-inch local vent stack, six to a 3-inch local vent stack, and 12 to a 4-inch local vent stack. In multiple installations, the connections between a bedpan washer local vent and a local vent stack shall be made by use of the tee or tee-wye sanitary pattern drainage fittings, installed in an upright position.

3. The bottom of the local vent stack, except when serving only one bedpan washer, shall be drained by means of a trapped and vented waste connection to the plumbing sanitary drainage system. The trap and waste shall be the same as the local vent stack.

4. A water supply of not less than 1/4-inch minimum tubing shall be taken from the flush supply of each bedpan washer on the discharge or fixture side of the vacuum breaker (taken off at least 4 inches below the critical level of the vacuum breaker), trapped to form not less than a 3-inch (76 mm) seal, and connected to the local vent stack on each floor. The water supply shall be so installed as to provide a supply of water to the local vent stack for cleansing and drain trap seal maintenance each time a bedpan washer is flushed.

- M. Sterilizer Vents and Stacks. Sterilizer vents and stacks shall comply with the following.

1. Multiple installations of pressure and nonpressure sterilizers shall have their vent connections to the sterilizer vent stack made by means of inverted wye fittings. Such vent connections shall be accessible for inspection and maintenance.

2. The connection between sterilizer vent or exhaust openings and the sterilizer vent stack shall be designed and installed to drain to the funnel or basket type waste fitting. In multiple installations, the sterilizer vent stack shall be drained separately to the lowest sterilizer funnel or basket type waste fitting or receptor.

N. Sterilizer Vent Stack Sizes. Sterilizer vent stack sizing shall comply with the following.

1. The minimum diameter of a sterilizer vent serving a bedpan steamer shall be 1 1/2 inches. Multiple installations shall be sized according to Table 1305.N.1 of this code below.

2. The minimum diameter of a sterilizer vent stack shall be 2 inches when serving a utensil sterilizer, and 1 1/2 inches when serving an instrument sterilizer. Combinations of boiling type sterilizer vent connections shall be based on Table 1305.N.1 of this code below.

3. Sterilizer vent stacks shall be 2 1/2 inches minimum. Those serving combinations of pressure sterilizer exhaust connections shall be sized according to Table 1305.N.2 of this code below.

4. The minimum diameter of a sterilizer vent stack serving an instrument washer-sterilizer shall be 2-inch diameter. Not more than two sterilizers shall be installed on a 2-inch stack, and not more than four on a 3-inch stack.

O. Radioactive Materials. All radioactive materials shall be disposed of in a manner so as not to create a hazard to operation and maintenance personnel of the institution or to the public. Specific permission shall be secured from the proper authority to dispose of any radioactive material to the drainage system.

AUTHORITY NOTE: Promulgated in accordance with R.S. 40:4(A)(7) and R.S. 40:5(2)(3)(7)(9)(16)(17)(20).

HISTORICAL NOTE: Promulgated by the Department of Health and Hospitals, Office of Public Health, LR 38:2883 (November 2012).

§1307. Water Supply

A. Water Service. All hospitals should have dual services installed in a manner to provide an uninterrupted supply of water in case of a water main break, etc.

B. Hot Water Distribution System. Hot water circulating mains and risers should be run from the hot water storage tank to a point directly below the highest fixture at the end of each branch main. Where the building is higher than three stories, each riser shall be circulated. Each main, branch main, riser and branch to a group of fixtures of the water system shall be valved.

C. Vacuum Breaker Installations. The following shall be considered concerning the installation and use of vacuum breakers.

1. For ordinary hose connections, the maximum height at which any hose is to be used shall be treated as its flood level.

2. Where low volume flows might cause leaking or spitting at the vacuum breaker parts, back pressure may be developed by installing an acceptable minimum orifice valve on the discharge side of the vacuum breaker. This shall be in addition to the regular control valve. This type of installation shall be subject to review and acceptance by the plumbing official before installation.

D. Prohibited Water Closet and Clinical Sink Supply. Jet or water supplied orifices, except those supplied by the flush connections, shall not be located in or connected with a water closet bowl or clinical sink. This Subsection shall not prohibit an acceptable bidet installation.

E. Special Equipment, Water Supply Protection. Table 1307.E of this code sets forth the requirements which shall be followed in protecting the water supply for hospital fixtures against backflow or backsiphonage.

F. Clinical, Hydrotherapeutic and Radiological Equipment. All clinical, hydrotherapeutic, radiological, or any equipment, whether mentioned or not, which is water supplied or discharges to the waste system, shall meet the requirements of this Section and other Sections of this Part covering cross connectors, air gaps, vacuum breakers, and check valves. Special equipment and devices found under these classes include those listed in Table 1307.F of this code.

Table 1305.N.1 Stack Sizes for Bedpan Steamers and Boiling Type Sterilizers (in) (Number of connections of various sizes permitted to various sized sterilizer vent stacks)			
Stack Size (in)	Connection Size (in)		
	1 1/2		2
1 1/2 (see note 1)	1	or	0
2	2	or	1
2 (see note 2)	1	and	1
3 (see note 1)	4	or	2
3 (see note 2)	2	and	2
4 (see note 1)	8	or	4
4 (see note 2)	4	and	4

NOTES:

- 1. Total of each size.
- 2. Combination of sizes.

Table 1305.N.2 Stack Sizes for Pressure Sterilizers (in) (Number of connections of various sizes permitted to various sized vent stacks)				
Stack Size (in)	Connection Size (in)			
	3/4	1	1 1/4	1 1/2
1 1/2 (Note 1)	3 or	2 or	1 or	1
1 1/2 (Note 2)	2 and	1		
2 (Note 1)	6 or	3 or	2 or	1
2 (Note 2)	3 and	2		
2 (Note 2)	2 and	1 and	1	
2 (Note 2)	1 and	1 and	1	
3 (Note 1)	15 or	7 or	5 or	3
3 (Note 2)		1 and	2 and	2
	1 and	5 and		1

NOTES:

- 1. Total of each size.
- 2. Combination of sizes.

Table 1307.E Fixtures and Their Water Supply Protection		
Fixtures	Type of protection ¹	Remarks
Aspirators:		
Laboratory	Vacuum breaker	
Portable	Vacuum breaker	
Vacuum system	Vacuum breaker	
Bedpan:		
Washers	Vacuum breaker	
Washer hose	Vacuum breaker	Locate 5 ft above floor.
Boiling type sterilizer	Air gap	Not less than twice the effective opening of the water supply.
Exhaust condenser	Vacuum breaker	
Flush floor drain	Vacuum breaker	Locate 6 ft above floor.
Hose connection	Vacuum breaker	
Pressure instrument:		
Washer-sterilizer	Vacuum breaker	
Pressure sterilizer	Vacuum breaker	
Vacuum systems:		
Cleaning	Air gap or vacuum breaker	
Fluid suction	Air gap or vacuum breaker	

NOTE:

- Where atmospheric vacuum breakers are used, they shall be installed after the last control valve.

G. Condensate Drain Trap Seal. A water supply shall be provided for cleaning, flushing, and resealing the condensate trap. The source of the water supply shall be a refrigerator condenser discharge, a drinking fountain waste, or other acceptable method of flushing and resealing the trap. The water supply shall be not less than 1/2-inch diameter pipe and shall discharge through an air gap not less than twice the diameter of the supply pipe.

H. Valve Leakage Diverter. Each water sterilizer which may be filled with water through directly connected piping shall be equipped with an acceptable leakage diverter and/or bleed-line on the water supply control valve to indicate and conduct any leakage of unsterile water away from the sterile zone.

Table 1307.F Classes of Clinical, Hydrotherapeutic and Radiological Equipment			
Clinical	Hydrotherapeutic	Radiological	Other
Dental cuspidors	Control units	Diagnostic x-ray	Violet ray
Surgical cuspidors	Arm bath	Therapy x-ray	Photographic
Dental (flush rim)	Leg bath	X-ray transformers	developing
lavatories	Tub bath	X-ray oil tank	Film
Sitz bath	Immersion bath	Diffraction	developing
Emergency bath	Shower bath	X-ray developing	Microscopic
Receiving bath	Needle bath		
Prenatal bath	Tank		
Infant bath	Pool		
Prophylaxis	Hose		
Shampoo	Syringe douche		
Massage			

AUTHORITY NOTE: Promulgated in accordance with R.S. 40:4(A)(7) and R.S. 40:5(2)(3)(7)(9)(16)(17)(20).

HISTORICAL NOTE: Promulgated by the Department of Health and Hospitals, Office of Public Health, LR 38:2885 (November 2012).

§1309. Medical Gas and Medical Vacuum Systems

A. Where medical gas and medical vacuum systems are installed, the gas piping, outlets, manifold rooms and storage rooms shall be installed in accordance with all of the requirements of the NFPA 99 by individuals properly licensed by the State Plumbing Board of Louisiana (see LAC 46:LV).

AUTHORITY NOTE: Promulgated in accordance with R.S. 40:4(A)(7) and R.S. 40:5(2)(3)(7)(9)(16)(17)(20).

HISTORICAL NOTE: Promulgated by the Department of Health and Hospitals, Office of Public Health, LR 38:2886 (November 2012).

Chapter 14. Reference Standards

§1401. Scope

A. This Chapter contains the designations, names and edition of standards referenced in this code listed alpha-numerically and the Section numbers where they are referenced.

AUTHORITY NOTE: Promulgated in accordance with R.S. 40:4(A)(7) and R.S. 40:5(2)(3)(7)(9)(16)(17)(20).

HISTORICAL NOTE: Promulgated by the Department of Health and Hospitals, Office of Public Health, LR 38:2886 (November 2012).

§1403. Referenced Standards

A. Products manufactured to those standards which are followed by the word "Listed" are required to be listed regardless of the standards' requirements for listing.

Standard Designation	Section/Table
ANSI A21.4-2008*, Cement-Mortar Lining for Ductile-Iron Pipe and Fittings for Water (same as AWWA C104)	Table 303
ANSI A21.10-2008 (R2012)*, Ductile-Iron and Gray-Iron Fittings (same as AWWA C110)	Table 603
ANSI A21.11-2006*, Rubber Gasket Joints for Ductile-Iron Pressure Pipe and Fittings (same as AWWA C111)	709.G
ANSI A21.51-2009*, Ductile-Iron Pipe, Centrifugally Cast (same as AWWA C151)	Table 603
ANSI A21.53 -2006*, Ductile-Iron Compact Fittings for Water Service (same as AWWA C153)	Table 603
ANSI A117.1-2003*, Standard for Accessible and Usable Buildings and Facilities	415.I.1, 415.I.3
ANSI A118.10-2008, Load Bearing, Bonded, Waterproof Membranes for Thin-Set Ceramic Tile and Dimension Stone Installation	Table 303, 303.G.7.c
ANSI B16.32-1992, Cast Copper Alloy Solder Joint Fittings for Solvent Drainage Systems	Table 703
ANSI B16.43-1982, Wrought Copper and Copper Alloy Solder Joint Fittings for Solvent Drainage Systems	Table 703
ANSI B31.1-55, Code for Pressure Piping	621.D
ANSI Z4.1-1986 (R2005)*, Sanitation in Places of Employment, Minimum Requirement for	405.C, Table 411 - Footnote 13
ANSI Z21.10.1-2009, Gas Water Heaters, Volume 1, Storage Water Heaters with Input Ratings of 75,000 Btu per Hour or Less (same as CSA 4.1)	503.B
ANSI Z21.10.3-2011, Gas Water Heaters Volume III, Storage, with Input Ratings Above 75,000 Btu	503.B

PUBLIC HEALTH—SANITARY CODE

Standard Designation	Section/Table
per Hour, circulating and instantaneous (same as CSA 4.3)	
ANSI Z21.22-1999(R2008)*, Relief Valves for Hot Water Supply Systems (same as CSA 4.4M)	501.F.1, 511.A.2, 511.G
ANSI Z124.1.2-2005*, Plastic Bathtub and Shower Units	Table 407, Table 415.I
ANSI Z124.3-2005*, Plastic Lavatories	Table 407
ANSI Z124.4-2006*, Plastic Water Closet Bowls and Tanks	Table 407
ANSI Z535.1-2006 (R2011), American National Standard for Safety Colors	607.A
APSP 2-1999*, Public Spas	Table 415.K
APSP 3-1999*, Permanently Installed Residential Spas	Table 415.K
APSP 6-1999*, Residential Portable Spas	Table 415.K
APSP 16-2011*, Standard Suction Fittings for Use in Swimming Pools, Wading Pools, Spas, and Hot Tubs (same as ASME A112.19.8)	415.K.2, 415.O.6
ARI 1010-2002, Drinking Fountains and Self-Contained, Mechanically-Refrigerated Drinking-Water Coolers	415.C.1
ASME Boiler and Pressure Vessel Code, Section IX, Welding and Brazing Qualifications, 1998 Edition	315.D
ASME A13.1-2007*, Scheme for the Identification of Piping Systems	607.A.1, 607.A.3, 607.B
ASME A112.1.2-2004*, Air Gaps in Plumbing Systems	415.C.1, 415.C.2, 609.A.1, Table 609, 609.C.7, 609.F.2
ASME A112.3.1-2007*, Stainless Steel Drainage Systems for Sanitary DWV, Storm, and Vacuum Applications, Above- and Below Ground	703.C.1, 703.D, Table 703
ASME A112.3.4-2000*, Macerating Toilet Systems and Related Components	Table 407, 729.C
ASME A112.4.1-2009, Water Heater Relief Valve Drain Tubes	Table 511
ASME A112.6.1M-1997 (R2002)*, Supports for Off-the-Floor Plumbing Fixtures for Public Use (Floor -Affixed)	Table 303
ASME A112.6.2-2000*, Framing-Affixed Supports for Off-the-Floor Water Closets with Concealed Tanks	Table 303
ASME A112.6.3-2001*, Floor Drains	Table 303
ASME A112.6.4-2003 (R2008)*, Roof, Deck, and Balcony Drains (dual roof drain assemblies wherein the inlets of both are enclosed in the same strainer are prohibited)	Table 303
ASME A112.14.1-2003 (R2008)*, Backwater Valves	705.G.2
ASME A112.14.3-2000 (R2004)*, Grease Interceptors	1005.N.1, 1005.N.5.a, 1005.N.6.a
ASME A112.18.1-2005*, Plumbing Fixture Fittings (same as CSA B125.1)	Table 407
ASME A112.18.2-2011, Plumbing Waste Fittings (Same as CSA B125.2)	Table 407
ASME A112.18.3-2002*, Requirements for Backflow Protection Devices and Systems in Plumbing Fixture Fittings	Table 407, 609.C.7
ASME A112.18.6-2009, Flexible Water Connectors (same as CSA B125.6)	Table 407, 509.B
ASME A112.19.1-2008*, Enameled Cast Iron and Enameled Steel Plumbing Fixtures (same as CSA B45.2)	Table 407, 415.C.1
ASME A112.19.2-2008*, Ceramic Plumbing Fixtures (same as CSA B45.1)	Table 407, 415.C.1
ASME A112.19.3-2008*, Stainless Steel Plumbing Fixtures (same as CSA B45.4)	Table 407
ASME A112.19.4M-1994 (R2008)*, Porcelain Enameled Formed Plumbing Fixtures	Table 407
ASME A112.19.5-2011, Trim for Water-Closet	Table 407

Standard Designation	Section/Table
Bowls, Tanks and Urinals (same as CSA B45.15)	
ASME A112.19.6-1995*, Hydraulic Performance Requirements for Water Closets & Urinals	Table 407
ASME A112.19.7-2012, Hydromassage Bathtub Systems (same as CSA B45.10)	415.O.4, 415.O.5
ASME A112.19.8-2007*, Suction Fittings for Use in Swimming Pools, Wading Pools, Spas, and Hot Tubs (same as APSP 16)	415.K.2, 415.O.6
ASME A112.19.9M-1991 (R2002)*, Non-vitreous Ceramic Plumbing Fixtures	Table 407
ASME A112.19.19-2006, Vitreous China Nonwater Urinals	Table 407
ASME A112.36.2M-1991 (R2002)*, Cleanouts	Table 303
ASME B1.20.1-1983 (R2006)*, Pipe Threads, General Purpose (Inch)	313.B
ASME B16.3-2011, Malleable Iron Threaded Fittings, Classes 150 and 300	Table 603
ASME B16.4-2011, Gray Iron Threaded Fittings, Classes 125 and 250	Table 603
ASME B16.5-2009, Pipe Flanges and Flanged Fittings	Table 603
ASME B16.12-2009, Cast-Iron Threaded Drainage Fittings	Table 703
ASME B16.15-2011, Cast Bronze Threaded Fittings, Classes 125 and 250	Table 603
ASME B16.18-2001, Cast Copper Alloy Solder Joint Pressure Fittings	Table 603
ASME B16.22-2001*, Wrought Copper and Copper Alloy Solder Joint Pressure Fittings	Table 603
ASME B16.23-2011, Cast Copper Alloy Solder Joint Drainage Fittings-DWV	Table 703
ASME B16.24-2011, Cast Copper Alloy Pipe Flanges: Class 150, 300, 400, 600, 900, 1500, and 2500	Table 603
ASME B16.26-2006*, Cast Copper Alloy Fittings for Flared Copper Tubes	Table 603
ASME B 16.29-2007*, Wrought Copper and Wrought Copper Alloy Solder Joint Drainage Fittings-DWV	Table 703
ASME B16.34-2009, Valves-Flanged Threaded, and Welding End	Table 603
ASME B16.45-1998 (R2006)*, Cast Iron Fittings for Solvent Drainage Systems	1811.E.3
ASSE 1001-2008*, Performance Requirements for Atmospheric-Type Vacuum Breakers	Table 609
ASSE 1002-2008*, Anti-Siphon Fill Valves for Water Closet Tanks	Table 609
ASSE 1003-2009*, Performance Requirements for Water Pressure Reducing Valves for Domestic Water Distribution Systems	611.J.1, 611.J.6
ASSE 1010-2004*, Performance Requirements for Water Hammer Arresters	Table 407, 611.I.1
ASSE 1011-2004*, Performance Requirements for Hose Connection Vacuum Breakers	Table 609
ASSE 1012-2009*, Performance Requirements for Backflow Preventers with Intermediate Atmospheric Vent	Table 609, 609.C.5
ASSE 1013-2011*, Performance Requirements for Reduced Pressure Principle Backflow Preventers and Reduced Pressure Principle Fire Protection Backflow Preventers	Table 609, 609.C.5
ASSE 1014-2005, Performance Requirements for Backflow Prevention Devices for Hand Held Showers	Table 303
ASSE 1015-2011*, Performance Requirements for Double Check Backflow Prevention Assemblies and Double Check Fire Protection Backflow Prevention Assemblies	Table 609

Standard Designation	Section/Table
ASSE 1016-2011*, Performance Requirements for Automatic Compensating Valves for Individual Showers and Tub/Shower Combinations	Table 623, 623.A.1, 623.A.2
ASSE 1017-2009*, Performance Requirements for Temperature Actuated Mixing Valves for Hot Water Distribution Systems	623.A, Table 623
ASSE 1018-2001*, Performance Requirements for Trap Seal Primer Valves - Potable Water Supplied	415.E.4.a, 625.D.1
ASSE 1019-2011*, Performance Requirements for Vacuum Breaker Wall Hydrants, Freeze Resistant, Automatic Draining	Table 303, Table 609
ASSE 1020-2004*, Pressure Vacuum Breaker Assembly	Table 609
ASSE 1022-2003*, Backflow Preventers for Beverage Dispensing Equipment	Table 609
ASSE 1035-2008*, Performance Requirements for Laboratory Faucet Backflow Preventers	Table 303, Table 609
ASSE 1037-1990, Performance Requirements for Pressurized Flushing Devices (Flushometers) for Plumbing Fixtures	Table 303
ASSE 1043-1992, Performance Standard for Cast Iron Sovent Sanitary Drainage Systems	1811.E.3
ASSE 1044-2001*, Performance Requirements for Trap Seal Primer Devices, Drainage Types and Electronic Types	415.E.4
ASSE 1047-2011*, Performance Requirements for Reduced Pressure Detector Fire Protection Backflow Prevention Assemblies	Table 609
ASSE 1048-2011*, Performance Requirements for Double Check Detector Fire Protection Backflow Prevention Assemblies	Table 609
ASSE 1052-2004*, Performance Requirements for Hose Connection Backflow Preventers	Table 609
ASSE 1056-2001*, Performance Requirements for Spill Resistant Vacuum Breakers	Table 609
ASSE 1061-2011*, Performance Requirements for Push-Fit Fittings (for use on PEX tubing complying with ASTM F 876 or F877, type K and L hard drawn and annealed copper tubing complying with ASTM B 88, and CPVC tubing complying with ASTM D 2846)	Table 603
ASSE 1069-2005*, Performance Requirements for Automatic Temperature Control Mixing Valves	Table 623, 623.A.1
ASSE 1070-2004*, Performance Requirements for Water Temperature Limiting Devices	Table 623, 623.B, 623.C
ASSE 1072-2007, Performance Requirements for Barrier Type Floor Drain Trap Seal Protection Devices	415.E.4
ASSE Series 5000-2009*, Cross-Connection Control Professional Qualifications Standard	319.F, Table 609, 609.F
ASSE 5110-2009, Backflow Prevention Assembly Tester Professional Qualifications Standard (part of ASSE Series 5000, Cross-Connection Control Professional Qualifications Standard)	609.F.9
ASSE 5120-2009, Backflow Prevention Assembly Surveyor Professional Qualifications Standard (part of ASSE Series 5000, Cross-Connection Control Professional Qualifications Standard)	607.C
ASSE 5130-2009, Backflow Prevention Assembly Repairer (part of ASSE Series 5000, Cross-Connection Control Professional Qualifications Standard)	609.F.9
ASTM A48/A48M-2003 (R2008), Standard Specification for Gray Iron Castings	Table 703, 717.G
ASTM A53/A53M-2012, Standard Specification for Pipe, Steel, Black and Hot-Dipped, Zinc-Coated Welded and Seamless	Table 603
ASTM A74-2009, Standard Specification for Cast Iron Soil Pipe and Fittings	303.G.6.a, Table 703
ASTM A126-2004 (R2009), Standard Specification for Gray Iron Castings for Valves,	Table 603, Table 619.D

Standard Designation	Section/Table
Flanges, and Pipe Fittings	
ASTM A197/A197M-2000 (R2011), Standard Specification for Cupola Malleable Iron	Table 603
ASTM A2692010, Standard Specification for Seamless and Welded Austenitic Stainless Steel Tubing for General Service	Table 603
ASTM A312/A312M-2012, Standard Specification for Seamless, Welded, and Heavily Cold Worked Austenitic Stainless Steel Pipes	Table 603
ASTM A377-2003 (R2008)e1, Standard Index of Specifications for Ductile-Iron Pressure Pipe	Table 603
ASTM A518/A518M-1999 (R2008), Standard Specification for Corrosion-Resistant High-Silicon Iron Castings	Table 703, 703.F
ASTM A653/ A653M-2011, Standard Specification for Steel Sheet, Zinc-Coated (Galvanized) or Zinc-Iron Alloy-Coated (Galvannealed) by the Hot-Dip Process	Table 303
ASTM A733-2003 (R2009)e1, Standard Specification for Welded and Seamless Carbon Steel and Austenitic Stainless Steel Pipe Nipples	Table 603
ASTM A746-2009, Standard Specification for Ductile Iron Gravity Sewer Pipe	Table 703
ASTM A778-2001 (R2009)e1, Standard Specification for Welded, Unannealed Austenitic Stainless Steel Tubular Products	Table 603
ASTM A865/A865M-2006, Standard Specification for Threaded Couplings, Steel, Black and Zinc-Coated (Galvanized) Welded and Seamless, for Use in Steel Pipe Joints	Table 603
ASTM A888-2011, Standard Specification for Hubless Cast Iron Soil Pipe and Fittings for Sanitary and Storm Drain, Waste, and Vent Piping Applications	Table 703
ASTM B32-2008, Standard Specification for Solder Metal	Table 303
ASTM B42-2010, Standard Specification for Seamless Copper Pipe, Standard Sizes	Table 603
ASTM B43-2009, Standard Specification for Seamless Red Brass Pipe, Standard Sizes	Table 603
ASTM B75/B75M-2011, Standard Specification for Seamless Copper Tube	Table 603
ASTM B88-2009, Standard Specification for Seamless Copper Water Tube	513.F.1, Table 603, 613.A.1, 619.A.2, 619.B
ASTM B135-2008a, Standard Specification for Seamless Brass Tube	Table 603
ASTM B135-2010, Standard Specification for Seamless Brass Tube	Table 603
ASTM B152/B152M-2009, Standard Specification for Copper Sheet, Strip, Plate and Rolled Bar	Table 303
ASTM B248-2007, Standard Specification for General Requirements for Wrought Copper and Copper- Alloy Plate, Sheet, Strip, and Rolled Bar	Table 303
ASTM B248M-2007, Standard Specification for General Requirements for Wrought Copper and Copper- Alloy Plate, Sheet, Strip, and Rolled Bar Metric	Table 303
ASTM B251-2010, Standard Specification for General Requirements for Wrought Seamless Copper and Copper-Alloy Tube	Table 603
ASTM B251M-2010, Standard Specification for General Requirements for Wrought Seamless Copper and Copper-Alloy Tube Metric	Table 603
ASTM B302-2007, Standard Specification for Threadless Copper Pipe, Standard Sizes	Table 603
ASTM B306-2009, Standard Specification for Copper Drainage Tube (DWV)	Table 703
ASTM B447-2007, Standard Specification for Welded Copper Tube	Table 603

PUBLIC HEALTH—SANITARY CODE

Standard Designation	Section/Table
ASTM B543-2007e1, Standard Specification for Welded Copper and Copper-Alloy Heat Exchanger Tube	Table 703
ASTM B587-2008, Standard Specification for Welded Brass Tube	Table 603
ASTM B687-1999 (R2011), Standard Specification for Brass, Copper, and Chromium-Plated Pipe Nipples	Table 603
ASTM B813-2010, Standard Specification for Liquid and Paste Fluxes for Soldering Applications for Copper and Copper Tube	Table 303
ASTM B828-2002 (R2010), Standard Practice for Making Capillary Joints by Soldering of Copper and Copper Alloy Tube and Fittings	Table 303
ASTM C4-2004 (R2009), Standard Specification for Clay Drain Tile and Perforated Clay Drain Tile	Table 703
ASTM C14-2011, Standard Specification for Non-Reinforced Concrete Sewer, Storm Drain, and Culvert Pipe (Approved for storm drain use only)	Table 703
ASTM C76-2011, Standard Specification for Reinforced Concrete Culvert, Storm Drain, and Sewer Pipe (Approved for storm drain use only)	Table 703
ASTM C76M-2011, Standard Specification for Reinforced Concrete Culvert, Storm Drain, and Sewer Pipe-Metric (Approved for storm drain use only)	Table 703
ASTM C361-2011, Standard Specification for Reinforced Concrete Low-Head Pressure Pipe (Approved for storm drain use only)	Table 703
ASTM C361M-2008, Standard Specification for Reinforced Concrete Low-Head Pressure Pipe-Metric (Approved for storm drain use only)	Table 703
ASTM C412-2011, Standard Specification for Concrete Drain Tile	Table 703
ASTM C412M-2011, Standard Specification for Concrete Drain Tile Metric	Table 703
ASTM C425-2004 (R2009), Standard Specification for Compression Joints for Vitrified Clay Pipe and Fittings	Table 703, 313.E
ASTM C443-2011, Standard Specification for Joints for Concrete Pipe and Manholes, Using Rubber Gaskets	Table 303
ASTM C443M-2011, Standard Specification for Joints for Concrete Pipe and Manholes, Using Rubber Gaskets Metric	Table 303
ASTM C444-2003 (R2009), Standard Specification for Perforated Concrete Pipe	Table 703
ASTM C444M-2003(2009), Standard Specification for Perforated Concrete Pipe Metric	Table 703
ASTM C478-2012, Standard Specification for Precast Reinforced Concrete Manhole Sections	Table 703, 717.G
ASTM C478M-2011, Standard Specification for Precast Reinforced Concrete Manhole Sections Metric	Table 703, 710.7
ASTM C564-2011, Standard Specification for Rubber Gaskets for Cast Iron Soil Pipe and Fittings	Table 303, 709.D.3
ASTM C700-2011, Standard Specification for Vitrified Clay Pipe, Extra Strength, Standard Strength, and Perforated	Table 703
ASTM C1053-2000 (R2010), Standard Specification for Borosilicate Glass Pipe and Fittings for Drain, Waste, and Vent (DWV) Applications	Table 703, 703.F
ASTM C1173-2010e1, Standard Specification for Flexible Transition Couplings for Underground Piping Systems	Table 303
ASTM C1277-2011, Standard Specification for Shielded Couplings Joining Hubless Cast Iron Soil Pipe and Fittings	Table 303

Standard Designation	Section/Table
ASTM D395-2003 (R2008), Standard Test Methods for Rubber Property-Compression Set. See §711.D of this code	Table 303
ASTM D412-2006ae2, Standard Test Methods for Vulcanized Rubber and Thermoplastic Elastomers-Tension. See §711.D of this code	Table 303
ASTM D788-2011, Standard Specification for Poly (Methyl Methacrylate) (PMMA) Molding and Extrusion Compounds	Table 303
ASTM D 789-2007e1, Standard Test Methods for Determination of Solution Viscosities of Polyamide (PA)	Table 303
ASTM D1527-99 (R2005), Standard Specification for Acrylonitrile- Butadiene-Styrene(ABS) Plastic Pipe, Schedules 40 and 80	Table 603
ASTM D1785-2006, Standard Specification for Poly (Vinyl Chloride) (PVC) Plastic Pipe, Schedules 40, 80, and 120	Table 603
ASTM D1869-1995 (R2010), Standard Specification for Rubber Rings for Asbestos-Cement Pipe	Table 303
ASTM D2235-2004 (R2011), Standard Specification for Solvent Cement for Acrylonitrile-Butadiene-Styrene (ABS) Plastic Pipe and Fittings. Listed	Table 303
ASTM D2239-2012, Standard Specification for Polyethylene (PE) Plastic Pipe (SIDR-PR) Based on Controlled Inside Diameter	Table 603
ASTM D2241-2009, Standard Specification for Poly (Vinyl Chloride) (PVC) Pressure-Rated Pipe (SDR-Series). Listed	Table 603
ASTM D2321-2011, Standard Practice for Underground Installation of Thermoplastic Pipe for Sewers and Other Gravity-Flow Applications	Table 303, Table 703
ASTM D2466-2006, Standard Specification for Poly (Vinyl Chloride) (PVC) Plastic Pipe Fittings Schedule 40	Table 603
ASTM D2467-2006, Standard Specification for Poly (Vinyl Chloride) (PVC) Plastic Pipe Fittings, Schedule 80. Listed	Table 603
ASTM D 2564-2004 (R2009)e1*, Standard Specification for Solvent Cements for Poly(Vinyl Chloride)(PVC) Plastic Piping Systems. Listed	Table 303
ASTM D2657-2007, Standard Practice for Heat Fusion Joining of Polyolefin Pipe and Fittings	Table 303
ASTM D2661-2011, Standard Specification for Acrylonitrile Butadiene-Styrene (ABS) Plastic Drain, Waste and Vent Pipe and Fittings. Listed	Table 703
ASTM D2665-2011, Standard Specification for Poly (Vinyl Chloride) (PVC) Plastic Drain, Waste, and Vent Pipe and Fittings. Listed	Table 703
ASTM D2672-1996a (2009)*, Standard Specification for Joints for IPS PVC Pipe Using Solvent Cement	Table 603
ASTM D2737-2012e1, Standard Specification for Polyethylene (PE) Plastic Tubing. Listed	Table 603
ASTM D2751-2005, Standard Specification for Acrylonitrile- Butadiene-Styrene (ABS) Sewer Pipe and Fittings	Table 703
ASTM D2774-2012, Standard Practice for Underground Installation of Thermoplastic Pressure Piping	Table 303
ASTM D2846/D2846M-2009be1, Standard Specification for Chlorinated Poly(Vinyl Chloride)(CPVC) Plastic Hot-and Cold-Water Distribution Systems. Listed	Table 603
ASTM D 2855-1996 (R2010), Standard Practice for Making Solvent-Cemented Joints with Poly (Vinyl Chloride)(PVC) Plastic Pipe and Fittings	Table 303
ASTM D3034-2008, Standard Specification for Type PSM Poly (Vinyl Chloride) (PVC) Sewer Pipe and Fittings	Table 703

Standard Designation	Section/Table
ASTM D-3138-04(2011), Standard Specification for Solvent Cements for Transition Joints Between Acrylonitrile-Butadiene-Styrene (ABS) and Poly(Vinyl Chloride) (PVC) Non-Pressure Piping Components	Table 303, 711.D.4 Note: This is not an all-purpose cement. Only to be utilized for joining an ABS building drain to a PVC building sewer.
ASTM D3139-1998 (R2011), Standard Specification for Joints for Plastic Pressure Pipes Using Flexible Elastomeric Seals. See §313.H.2 of this code	Table 603
ASTM D3212-2007*, Standard Specification for Joints for Drain and Sewer Plastic Pipes Using Flexible Elastomeric Seals	Table 703
ASTM D4068-2009, Standard Specification for Chlorinated Polyethylene (CPE) Sheeting for Concealed Water-Containment Membrane	303.G.7, Table 415.I
ASTM D4551-1996 (2008)e1*, Standard Specification for Poly (Vinyl Chloride) (PVC) Plastic Flexible Concealed Water-Containment Membrane	303.G.7, Table 415.I
ASTM D4894-2007, Standard Specification for Polytetrafluoroethylene (PTFE) Granular Molding and Ram Extrusion Materials	Table 303
ASTM D4895-2010, Standard Specification for Polytetrafluoroethylene (PTFE) Resin Produced From Dispersion	Table 303
ASTM F402-2005 (R2012), Standard Practice for Safe Handling of Solvent Cements, Primers, and Cleaners Used for Joining Thermoplastic Pipe and Fittings	Table 303
ASTM F409-2002 (R2008), Standard Specification for Thermoplastic Accessible and Replaceable Plastic Tube and Tubular Fittings	Table 703
ASTM F437-2009, Standard Specification for Threaded Chlorinated Poly (Vinyl Chloride) (CPVC) Plastic Pipe Fittings, Schedule 80. Listed	Table 603
ASTM F438-2009, Standard Specification for Socket-Type Chlorinated Poly(Vinyl Chloride) (CPVC) Plastic Pipe Fittings, Schedule 40	Table 603
ASTM F439-2011, Standard Specification for Chlorinated Poly (Vinyl Chloride) (CPVC) Plastic Pipe Fittings, Schedule 80. Listed	Table 603
ASTM F441/F 441M-2009, Standard Specification for Chlorinated Poly (Vinyl Chloride) (CPVC) Plastic Pipe, Schedules 40 and 80. Listed	Table 603
ASTM F442/F 442M-2009, Standard Specification for Chlorinated Poly (Vinyl Chloride) (CPVC) Plastic Pipe (SDR-PR)	Table 603
ASTM F493-2010, Standard Specification for Solvent Cements for Chlorinated Poly(Vinyl Chloride)(CPVC) Plastic Pipe and Fittings	Table 303
ASTM F628-2008, Standard Specification for Acrylonitrile- Butadiene-Styrene (ABS) Schedule 40 Plastic Drain, Waste, and Vent Pipe with a Cellular Core. Listed.	Table 703
ASTM F 656-2010*, Standard Specification for Primers for Use in Solvent Cement Joints of Poly(Vinyl Chloride) (PVC) Plastic Pipe and Fittings	Table 303
ASTM F876-2010e1, Standard Specification for Crosslinked Polyethylene (PEX) Tubing	Table 603
ASTM F877-2011a, Standard Specification for Crosslinked Polyethylene (PEX) Plastic Hot and Cold-Water Distribution Systems, Listed	Table 603
ASTM F891-2010, Standard Specification for Coextruded Poly(Vinyl Chloride)(PVC) Plastic Pipe with a Cellular Core	Table 703
ASTM F1281-2011, Standard Specification for Crosslinked Polyethylene/Aluminum/Crosslinked Polyethylene (PEX-AL-PEX) Pressure Pipe	Table 603

Standard Designation	Section/Table
ASTM F1282-2010, Standard Specification for Polyethylene/ Aluminum/Polyethylene (PE-AL-PE) Composite Pressure Pipe	Table 603
ASTM F1290-1998a (R2011), Standard Practice for Electro fusion Joining Polyolefin Pipe and Fittings	Table 303, 621.E.2
ASTM F1412-2009, Standard Specification for Polyolefin Pipe and Fittings for Corrosive Waste Drainage Systems	Table 703, 703.F, 709.C
ASTM F1488-2009e1, Standard Specification for Coextruded Composite Pipe	Table 703
ASTM F1499-2012, Standard Specification for Coextruded Composite Drain, Waste, and Vent Pipe (DWV)	Table 703
ASTM F1673-2010, Standard Specification for Polyvinylidene Fluoride (PVDF) Corrosive Waste Drainage Systems	Table 703, 703.F
ASTM F1807-2011ae1, Standard Specification for Metal Insert Fittings Utilizing a Copper Crimp Ring for SDR9 Cross-linked Polyethylene (PEX) Tubing	Table 603
ASTM F1960-2011e1, Standard Specification for Cold Expansion Fittings with PEX Reinforcing Rings for Use with Cross-linked Polyethylene (PEX) Tubing	Table 603
ASTM F2159-2011, Standard Specification for Plastic Insert Fittings Utilizing a Copper Crimp Ring for SDR9 Cross-linked Polyethylene (PEX) Tubing	Table 603
ASTM F2080-2009, Standard Specification for Cold-Expansion Fittings With Metal Compression-Sleeves for Cross-Linked Polyethylene (PEX) Pipe	Table 603
ASTM F2098-2008, Standard Specification for Stainless Steel Clamps for Securing SDR9 Cross-linked Polyethylene (PEX) Tubing to Metal Insert and Plastic Insert Fittings	Table 603
ASTM F2389-2010, Standard Specification for Pressure-rated Polypropylene (PP) Piping Systems	Table 603, 619.B
ASTM F2618-2009, Standard Specification for Chlorinated Poly (Vinyl Chloride) (CPVC) Pipe and Fittings for Chemical Waste Drainage Systems	Table 703, 703.F
ASTM F2620-2011e1, Standard Practice for Heat Fusion Joining of Polyethylene Pipe and Fittings	Table 303, 621.E
AWS B2.2/B2.2M:2010, Specification for Brazing Procedure and Performance Qualification	315.D
AWS A5.8/A5.8M-2011, Spec. for Filler Metals for Brazing and Braze Welding	Table 303
AWS A5.9/5.9M-2006*, Specification for Bare Stainless Steel Welding Electrodes and Rods	Table 303, 621.G
AWWA C104-2008*, Cement-Mortar Lining for Ductile-Iron Pipe and Fittings for Water (same as ANSI A21.4)	Table 303
AWWA C110-2008 (R2012)*, Ductile-Iron and Gray-Iron Fittings (same as ANSI A21.10)	Table 603
AWWA C111-2006*, Rubber Gasket Joints for Ductile-Iron and Gray-Iron Pressure Pipe and Fittings (same as ANSI A21.11)	709.G
AWWA C151-2009*, Ductile-Iron Pipe, Centrifugally Cast (same as ANSI A21.51)	Table 603
	Table 603
AWWA C203-2009*, Coal-Tar Protective Coatings and Linings for Steel Water Pipelines-Enamel and Tape-Hot-Applied	Table 303
AWWA C509-2009*, Resilient-Seated Gate Valves for Water Service Supply	Table 619.D
AWWA C510-2007*, Double Check Valve Backflow Prevention Assembly	Table 609
AWWA C511-2007*, Reduced Pressure Principle Backflow Prevention Assembly	Table 609
AWWA C606-2011*, Grooved and Shouldered Joints	Table 303

PUBLIC HEALTH—SANITARY CODE

Standard Designation	Section/Table
AWWA C900-2007*, Polyvinyl Chloride (PVC) Pressure Pipe and Fabricated Fittings, 4 In. Through 12 In. (100 mm Through 300 mm), for Water Transmission and Distribution	Table 603
CAN/CSA-B64.10-94, Manual for the Selection, Installation, Maintenance, and Field Testing of Backflow Prevention Devices	Table 609, Table 609.F.5 - Footnote 1, Table 609.F.6 - Footnotes 2 & 3
CAN/CSA-B137.2-2009, PVC Injection-Molded Gasketed Fittings for Pressure Applications. Listed	Table 603
CAN/CSA-B 137.5-2009, Cross-Linked Polyethylene (PEX) Tubing Systems for Pressure Applications. Listed	Table 603
CAN/CSA-B181.1-2006, ABS Drain, Waste, and Vent Pipe and Pipe Fittings	705.G.2
CAN/CSA-B 181.2-2006, PVC Drain, Waste, and Vent Pipe and Pipe Fittings	705.G.2
CAN/CSA-B-182.4-2006, Profile PVC Sewer Pipe and Fittings	Table 703
CDA Copper Sovent Single Stack Plumbing System Design Handbook No. 402/0 (For informational purposes only since is alternate designed plumbing governed under Chapter 12 requirements of this code)	1811.E.3
CDA Copper Tube Handbook (For informational purposes only)	Table 1805.F
CISPI HS 74-86, Standard Specification for Cast Iron Soil Pipe and Fittings for Hub and Spigot Sanitary and Storm Drain, Waste and Vent Piping Applications	Table 703
CISPI HSN 85, Standard Specification for Neoprene Rubber Gaskets for Hub and Spigot Cast Iron Soil Pipe and Fittings	Table 303
CISPI 301-09, Standard Specification for Hubless Cast Iron Soil Pipe and Fittings for Sanitary and Storm Drain, Waste, and Vent Piping Applications	Table 703
CISPI 310-11, Standard Specification for Coupling for use in connection with Hubless Cast Iron Soil Pipe and Fittings for Sanitary and Storm Drain, Waste, and Vent Piping Applications	Table 303, Table 703, 709.E.3
CSA 4.1-2009, Gas Water Heaters, Volume I, Storage Water Heaters with Input Ratings of 75,000 Btu per Hour or Less (same as ANSI Z21.10.1)	503.B
CSA 4.3-2011, Gas Water Heaters Volume III, Storage, with Input Ratings Above 75,000 Btu per Hour, circulating and instantaneous (same as ANSI Z21.10.3)	503.B
CSA 4.4M-1999(R2008)*, Relief Valves for Hot Water Supply Systems (same as ANSI Z21.22)	501.F.1, 511.A.2, 511.G
CSA B45.1-2008, Ceramic Plumbing Fixtures (same as ASME A112.19.2)	Table 407, 415.C.1
CSA B45.2-2008, Enameled Cast Iron and Enameled Steel Plumbing Fixtures (same as ASME A112.19.1)	Table 407, 415.C.1
CSA B45.4-2008, Stainless Steel Plumbing Fixtures (same as ASME A112.19.3)	Table 407
CSA B45.10-2012, Hydromassage Bath tub Systems (same as ASME A112.19.7)	415.O.4, 415.O.5
CSA B45.15-2011, Trim for Water-Closet Bowls, Tanks and Urinals (same as ASME A112.19.5)	Table 407
CSA B125.1-2005, Plumbing Supply Fittings (same as ASME A112.18.1)	Table 407
CSA B125.2-2011, Plumbing Waste Fittings (same as ASME A112.18.2)	Table 407
CSA B125.6-2009, Flexible Water Connectors (same as ASME A112.18.6)	Table 407, 509.B

Standard Designation	Section/Table
FMRC 1680-89, Couplings Used In Hubless Cast Iron Systems for Drain, Waste or Vent, Sewer, Rainwater or Storm Drain Systems Above and Below Ground, Industrial/Commercial and Residential	Table 303
FS QQ-L-156 (1946), Caulking Lead	Table 407
FS QQ-L-201 F(2) (1965) (R1970), Lead Sheet, [AMD 02 (1970)]	Table 303
FS SS-P-381, Concrete Pipe Pressure Reinforced-Prevention Reinforcement Steel	Table 703
FS WW-P-325(44), Pipe, Bends, Traps, Caps, and Plugs; Lead (for Industrial Pressure, and Soil and Waste Applications)	Table 703
FS WW-P-541 E/GEN(1), (1980), Plumbing Fixtures (General Specifications), [AMD 01 (1990)]	Table 407
IAPMO Z124.5-2006, Plastic Toilet (Water Closet) Seats	Table 303
IAPMO Z124.6-2007, Plastic Sinks	Table 407
MSS SP-72-2010, Ball Valves with Flanged or Butt-Welding Ends for General Service	Table 609.D
MSS SP-80-2008, Bronze Gate, Globe, Angle and Check Valves	Table 609.D
MSS SP-110-2010, Ball Valves Threaded, Socket-Welding, Solder Joint, Grooved, and Flared Ends	Table 609.D
NFPA 70-2010 National Electrical Code	731.H.2, 1101.G.3
NFPA 99-2012, Health Care Facilities Code	1302, G105
NFPA1192-2008, Standard on Recreational Vehicles	1501.A, 1601.A
NSF 14-2011*, Plastic Piping System Components and Related Materials	303.H.5, 313.H.1
NSF 24-2010*, Plumbing System Components for Mobile Homes & Recreational Vehicles	Table 603
NSF 42-2010*, Drinking Water Treatment Units-Aesthetic Effects	Table 303, 627.A
NSF 50-2011*, Circulation System Components and Related Materials for Swimming Pools, Spas or Hot Tubs	415.K.1
NSF 53-2011*, Drinking Water Treatment Units-Health Effects	Table 303, 627.A
NSF 58-2006*, Reverse Osmosis Drinking Table Water Treatment Units	Table 303, 627.B
NSF 61-2011*, Drinking Water System Components-Health Effects	303.F, 335.C, 415.C.1
NSF/ANSI 372-2010*, Drinking Water System Components-Lead Content	303.F, 613.A, 619.A.3
PDI-G101-2010, Testing and Rating Procedure for Grease Interceptors with Appendix of Sizing and Installation Data	1005.N.1, 1005.N.5.a, 1005.N.6.a
PDI-WH201-2006, Water Hammer Arresters	611.I.1
SBCCI Standard Building Code, 1994 Edition	203,
UFL's TREEO's "Backflow Prevention - Theory and Practice", 2nd Edition, 2004	319.F
UL 174-2004, Household Electric Storage Tank Water Heaters	503.A
USC's FCCC&HR's "Manual of Cross-Connection Control", Tenth Edition, 2009	319.F

*ANSI designated as an American National Standard

AUTHORITY NOTE: Promulgated in accordance with R.S. 40:4(A)(7) and R.S. 40:5(2)(3)(7)(9)(16)(17)(20).

HISTORICAL NOTE: Promulgated by the Department of Health and Hospitals, Office of Public Health, LR 38:2886 (November 2012).

§1405. Organizations

A. The following is a list by name and address of those agencies, associations, institutes and others that are referred to in this code by name, initials or symbols. Further there are

those listed, for convenience, whose technical and other services are made available to this Part.

AGA	American Gas Association, Inc. 400 North Capitol Street, NW, Suite 450 Washington, D.C. 20001 Tel. (202)824-7000 www.aga.org
AHRI	Air-Conditioning, Heating, and Refrigeration Institute 2111 Wilson Boulevard, Suite 500 Arlington, Virginia 22201 Tel. (703) 524-8800 Fax (703) 562-1942 www.ahrinet.org
ANSI	American National Standards Institute, Inc. 25 West 43 rd Street, 4 th Floor New York, New York 10036 Tel. (212) 642-4900 Fax (212) 398-0023 www.ansi.org
ARI	Air Conditioning & Refrigeration Institute (effective January 1, 2008, now AHRI)
APSP	Association of Pool & Spa Professionals (formerly National Spa and Pool Institute) 2111 Eisenhower Avenue, Suite 500 Alexandria, Virginia 22314-4695 Tel. (703) 838-0083 Fax (703) 549-0493 www.apsp.org
ASME	American Society of Mechanical Engineers Information Central - Orders/Inquiries P.O. Box 2300 Fairfield, New Jersey 07007-2300 Tel. (800) 843-2763 www.asme.org
ASSE	American Society of Sanitary Engineering 901 Canterbury, Suite A Westlake, Ohio 44145 Tel. (440) 835-3040 Fax (440) 835-3488 www.asse-plumbing.org
ASTM International	American Society for Testing and Materials International 100 Barr Harbor Drive West Conshohocken, Pennsylvania 19428-2959 Tel. (610) 832-9500 Fax (610) 832-9555 www.astm.org
AWS	American Welding Society 550 N.W. LeJeune Road Miami, Florida 33126 Tel. (305) 443-9353 Tel. (800) 443-9353 Fax (305) 443-7559 www.aws.org
AWWA	American Water Works Association 6666 West Quincy Avenue Denver, Colorado 80235-3098 Tel. (303) 794-7711 Tel. (800) 926-7337 Fax (303) 347-0804
CDA	Copper Development Association, Inc. 260 Madison Ave. New York, New York, New York 10016 Tel. (212) 251-7200 Fax (212) 251-7234 www.copper.org
CISPI	Cast Iron Soil Pipe Institute 5959 Shallowford Road, Suite 419 Chattanooga, Tennessee 37421 Tel. (423) 892-0137 www.cispi.org

CAN/CSA	Canadian Standards Association 5060 Spectrum Way, Suite 100 Mississauga, Ontario Canada L4W 5N6 Tel. (416) 747-4000 Tel. (800) 463-6727 www.csa.ca
FMRC	Factory Mutual Research Corporation FM Approvals, LLC Approval Standards 1151 Boston-Providence Turnpike, P.O. Box 9102 Norwood, Massachusetts 02062-9102 Tel. (781) 762-4300 Fax (781) 762-9375 www.fmglobal.com
FS	Federal Specifications General Services Administration Federal Supply Service Specification Section 301 7th Street SW, Room 6628 Washington, D.C. 20407 Tel. (202) 619-8925 Fax (202) 619-8985 www.gsa.gov (go to "http://www.gsa.gov/portal/content/100847" for an index of Federal Specifications)
IAPMO	International Association of Plumbing and Mechanical Officials 5001 E. Philadelphia Street Ontario, California 91761-2816 Tel. (909) 472-4100 Fax (909) 472-4150 www.iapmo.org
MSS	Manufacturers Standardization Society of the Valve and Fittings Industry, Inc. 127 Park Street, N.E. Vienna, Virginia 22180-4602 Tel. (703) 281-6613 Fax (703) 281-6671 MSS-hq.org
NFiPA	National Fire Protection Association 1 Batterymarch Park Quincy, Massachusetts 02169-9101 Tel. (617) 770-3000 Tel. (800) 344-3555 Fax (800) 593-6372 www.nfpa.org
NSF	NSF International 789 N. Dixboro Road P.O. Box 130140 Ann Arbor, Michigan 48113-0140 Tel. (734) 769-8010 Tel. (800) 673-6275 Fax (734) 769-0109 www.nsf.org
PDI	Plumbing and Drainage Institute 800 Turnpike Street, Suite 300 North Andover, Massachusetts 01845 Tel. (800) 589-8956 Tel. (978) 557-0720 Fax (978) 557-0721 www.pdionline.org
PPFA	Plastic Pipe & Fittings Association 800 Roosevelt Road, Building C, Suite 312 Glen Ellyn, Illinois 60137-5833 Tel. (630) 858-6540 Fax (630) 790-3095 www.ppfahome.org

PPI	Plastics Pipe Institute A Division of the Plastics Industry, Inc. 105 Decker Court, Suite 825 Irving, Texas 75062 Tel. (469) 499-1044 Fax (469) 499-1063 www.plasticpipe.org (Note: "more PE pipe focus")
UFL's TREEO	University of Florida Center for Training, Research and Education for Environmental Occupations 3900 SW 63 Blvd Gainesville, FL 32608 Tel. (352) 392-9570 x229 Fax (352) 392- www.treeo.ufl.edu/backflow
UL	Underwriters Laboratories, Inc.** 333 Pfingsten Road Northbrook, Illinois 60062-2096 Tel. (847) 272-8800 Fax (847) 272-8129 www.ul.com
**UL Standards available from:	
	IHS Global Engineering Documents 15 Inverness Way East Englewood, Colorado 80112-5776 Tel. (303) 397-7956 Tel. (800) 854-7179 Fax (303) 397-2740 www.global.ihs.com
USC's FCCC&HR	University of Southern California Foundation for Cross-Connection Control and Hydraulic Research Viterbi School of Engineering Kapelian Hall 200 Los Angeles, CA 90089-2531 Tel. (866) 545-6340 Fax (213) 740-8399 www.usc.edu/fccchr

AUTHORITY NOTE: Promulgated in accordance with R.S. 40:4(A)(7) and R.S. 40:5(2)(3)(7)(9)(16)(17)(20).

HISTORICAL NOTE: Promulgated by the Department of Health and Hospitals, Office of Public Health, LR 38:2891 (November 2012).

Chapter 15. Travel Trailers and Travel Trailer Parks [formerly Appendix B—Travel Trailers and Travel Trailer Parks]

§1501. General

A. With the exception of §1523 of this code, the requirements set forth in this Chapter shall apply specifically to all new travel trailer parks, and to additions to existing parks as herein defined, and are to provide minimum standards for sanitation and plumbing installation within these parks, for the accommodations, use and parking of travel trailers. Plumbing installations within travel trailers shall be installed in accordance with NFPA 1192.

AUTHORITY NOTE: Promulgated in accordance with R.S. 40:4(A)(7) and R.S. 40:5(2)(3)(7)(9)(16)(17)(20).

HISTORICAL NOTE: Promulgated by the Department of Health and Hospitals, Office of Public Health, LR 38:2892 (November 2012).

§1503. Definitions

A. Definitions contained in Chapter 2 of this code shall also apply to this Chapter except where the following special definitions shall apply.

Air Lock—a condition where air is trapped in a *drain* or *drain hose* and retards or stops the flow of *liquid waste* or *sewage*.

Center—the longitudinal center line located midway between the right and the left side of a *mobile/manufactured home* or *travel trailer*.

Combination Compartment—a shower stall with or without a door which provides for or includes a water closet. It is sized for occupancy of only one person.

Department Having Jurisdiction—the administrative authority/authorities or other law enforcement agency/agencies having jurisdiction over this Code.

Dependent Travel Trailer—a travel trailer not equipped with a water closet.

Drain Hose—the approved type hose, flexible and easily detachable, used for connecting the *drain outlet* on a *travel trailer* to a *sewer inlet* connection.

Drain Outlet—the lowest end of the main drain of a travel trailer itself to which a *drain hose* is connected.

Independent Mobile/Manufactured Home or Travel Trailer—a *mobile/manufactured home* or *travel trailer* equipped with a water closet and a bath or shower.

Inlet Coupling—the terminal end of the branch water line to which the *mobile/manufactured home* or *travel trailer's* water service connection is made. It may be a swivel fitting or threaded pipe end.

Intermediate Waste Holding Tank—(*travel trailers* only) an enclosed tank for the temporary retention of water-borne waste.

Length—the distance measured from the tip of the hitch to the part farthest to the rear of a *mobile/manufactured home* or *travel trailer*.

Park or Mobile/Manufactured Home Park or Travel Trailer Park—any lot, tract, parcel or plot of land upon which more than one *travel trailer* and/or *mobile/manufactured homes* parked for the temporary or permanent use of a *person* or *persons* for living, working or congregating.

Park Drainage System—the entire system of drainage piping within the *park* which is used to convey *sewage* or other *wastes* from the *mobile/manufactured home* or *travel trailer drain outlet* connection, beginning at its *sewer inlet* connection at the *mobile/manufactured home* or *travel trailer site*, to a *community sewerage system*, a *commercial treatment facility*, or an *individual sewerage system*.

Park Water Distribution System—all of the water distribution piping within the *park*, extending from the water supply system or other source of supply to, but not

including, the *mobile/manufactured home* or *travel trailer's* water service connection, and including branch service lines, *fixture* devices, service buildings and appurtenances thereto.

Service Building—a building housing toilet and bathing facilities for men and women, with laundry facilities.

Sewer Inlet—a sewer pipe connection permanently provided at the *travel trailer* or *mobile/manufactured home* site which is designed to receive *sewage* when a *travel trailer* or a *mobile/manufactured home* is parked on such site. It is considered the upstream terminus of the *park drainage system*.

Sewer Lateral—that portion of the park drainage system extending from the main to the sewer inlet connection at a mobile/manufactured home or travel trailer site.

Trailer Trap—a device, fitting or assembly of fittings installed in the *sewer lateral* for a *travel trailer* or *mobile/manufactured home* which is used to prevent the circulation of air between the *park drainage system* and the drainage system of the individual *travel trailer* or *mobile/manufactured home*.

Travel Trailer—a vehicular unit, mounted on wheels, designed to provide temporary living quarters for recreational, camping, or travel use, of such size or weight as not to require special highway movement permits when towed by a motorized vehicle, and of gross trailer area less than 320 square feet.

Travel Trailer Sanitary Service Station—a sewage inlet with cover, surrounded by a concrete apron sloped inward to the *drain*, and watering facilities to permit periodic washdown of the immediately adjacent area, to be used as a disposal point for the contents of *intermediate waste holding tanks* of *travel trailers*.

Water Service Connection—as used in conjunction with mobile/manufactured homes and travel trailers, the water pipe connected between the inlet coupling of the park water distribution system and the water supply fitting provided on the mobile/manufactured home or travel trailer itself.

AUTHORITY NOTE: Promulgated in accordance with R.S. 40:4(A)(7) and R.S. 40:5(2)(3)(7)(9)(16)(17)(20).

HISTORICAL NOTE: Promulgated by the Department of Health and Hospitals, Office of Public Health, LR 38:2893 (November 2012).

§1505. General Regulations

A. Governing Provisions. Other general provisions of this code shall govern the installation of plumbing systems in travel trailer parks, except where special conditions or construction are specifically defined in this Chapter.

B. Travel Trailer Sites. Travel trailers shall comply with the following when parked in a travel trailer park.

1. Travel trailers shall not hereafter be parked in any travel trailer park unless there are provided plumbing and sanitation facilities installed and maintained in conformity with these regulations. Every travel trailer shall provide a gastight and watertight connection for sewage disposal

which shall be connected to an underground sewage collection system discharging into a community sewerage system, a commercial treatment facility, or an individual sewerage system which has been approved by the state health officer.

2. No dependent travel trailer shall be parked at any time in a space designed and designated for an independent travel trailer unless public toilet and bath facilities are available within 200 ft (61 m) of the dependent travel trailer.

C. Travel Trailer Sanitary Service Station. At least one travel trailer sanitary service station shall be provided in all travel trailer parks that accept any travel trailers having an intermediate waste holding tank.

AUTHORITY NOTE: Promulgated in accordance with R.S. 40:4(A)(7) and R.S. 40:5(2)(3)(7)(9)(16)(17)(20).

HISTORICAL NOTE: Promulgated by the Department of Health and Hospitals, Office of Public Health, LR 38:2893 (November 2012).

§1507. Plans and Specifications

A. The owner or operator of every travel trailer park, before providing areas of space for the use and accommodation of travel trailers, shall make application for a permit (where such permit is required by state, parish, city or other local laws or ordinances) or, regardless of whether or not an actual permit is required, shall file two sets of plans and specifications with the department(s) having jurisdiction for their review and approval. The plans and specifications shall be in detail and shall include/comply with the following:

1. a scaled plot plan of the park, indicating the spaces, area or portion of the park for the parking of travel trailers;
2. the size, location and specification of the park drainage system;
3. the size, location and specification of water supply lines;
4. the size, location and layout of service building (see §1509 of this code);
5. the size, location, specification and layout of the fire protection system, if applicable;
6. a scaled layout of typical trailer sites;
7. applications/submittals shall bear the approval of the local enforcement agencies as to compliance with city or parish plumbing, zoning and health ordinances;
8. plumbing required by this Chapter shall comply with all city, parish and state plumbing and health ordinances and regulations;
9. the issuance of a permit (or an approval of a submittal) shall not constitute approval of any violation of this code or violation of any city or parish ordinance or regulation; and,
10. an approved set of plans and specifications and a copy of the permit (or written approval of a submittal) shall

be kept on the park premises until the final inspection has been made.

AUTHORITY NOTE: Promulgated in accordance with R.S. 40:4(A)(7) and R.S. 40:5(2)(3)(7)(9)(16)(17)(20).

HISTORICAL NOTE: Promulgated by the Department of Health and Hospitals, Office of Public Health, LR 38:2894 (November 2012).

§1509. Service Buildings

A. Each travel trailer park shall have at least one service building to provide necessary sanitation and laundry facilities as specified in §§1509.B through 1509.E of this code. The service building shall be of permanent construction with an interior finish of moisture resistant material which will stand frequent washing and cleaning and the building shall be well-lighted and ventilated at all times.

B. Service Building for Independent Trailers

1. The service building(s) of only independent travel trailer parks shall have a minimum of one water closet, one lavatory, one shower or bathtub for females and one water closet, one lavatory, and one shower or bathtub for males. In addition, at least one laundry tray or clothes washing machine and one drinking fountain shall be provided.

2. The laundry tray or clothes washing machine and drinking fountain shall be located in a common area. None of these fixtures shall be located within any toilet room.

C. Service Building for Dependent Trailers

1. The service building(s) in parks that also accommodate dependent travel trailers shall have a minimum of two water closets, one lavatory, one shower or bathtub for females, and one water closet, one lavatory, one urinal, and one shower or bathtub for males. In addition, at least one laundry tray or clothes washing machine and one drinking fountain located in a common area shall be provided. The above facilities are for a maximum of ten dependent travel trailers. For every ten additional dependent travel trailers (or any fraction thereof) the following additional fixtures shall be provided: One laundry tray or clothes washing machine, one shower or bathtub for each sex, and one water closet for females. Also, one additional water closet for males shall be provided for every 15 additional dependent travel trailers (or any fraction thereof).

2. The laundry tray(s) and/or clothes washing machine(s) and drinking fountain(s) shall be located in a common area. None of these fixtures shall be located within any toilet room.

D. Hot and cold water shall be provided for all plumbing fixtures except water closets, urinals and drinking fountains.

E. Each water closet, tub and/or shower shall be in separate compartments, with self-closing doors on all water closet compartments. The shower stall shall be a minimum of 3 x 3 ft (914 x 914 mm) in area, with a dressing compartment with a stool or bench for females.

F. Floor Drains. A minimum 2-inch floor drain protected by and approved trap primer shall be installed in each toilet room and laundry room (see §415.E of this code).

AUTHORITY NOTE: Promulgated in accordance with R.S. 40:4(A)(7) and R.S. 40:5(2)(3)(7)(9)(16)(17)(20).

HISTORICAL NOTE: Promulgated by the Department of Health and Hospitals, Office of Public Health, LR 38:2894 (November 2012).

§1511. Materials

A. Unless otherwise provided for in this Chapter, all piping fixtures or devices used in the installation of drainage and water distribution systems for travel trailer parks, or parts thereof, shall conform to the quality and weights of materials required by the *Louisiana State Plumbing Code*.

AUTHORITY NOTE: Promulgated in accordance with R.S. 40:4(A)(7) and R.S. 40:5(2)(3)(7)(9)(16)(17)(20).

HISTORICAL NOTE: Promulgated by the Department of Health and Hospitals, Office of Public Health, LR 38:2894 (November 2012).

§1513. General Regulations

A. Unless otherwise provided for in this Chapter, all plumbing fixtures, piping drains, appurtenances and appliances designed and used in a park drainage, water distribution system and service connections shall be installed in conformance with the *Louisiana State Plumbing Code*.

AUTHORITY NOTE: Promulgated in accordance with R.S. 40:4(A)(7) and R.S. 40:5(2)(3)(7)(9)(16)(17)(20).

HISTORICAL NOTE: Promulgated by the Department of Health and Hospitals, Office of Public Health, LR 38:2894 (November 2012).

§1515. Park Drainage System

A. The sewer main and sewer laterals shall be installed in a separate trench not less than 5 feet (1524 mm) from the park water service or distribution system (see §§613.C and 613.D of this code).

B. The minimum size of pipe in any travel trailer park drainage system shall be 4 inches.

C. Each travel trailer shall be considered as 6 fixture units in determining discharge requirements in the design of park drainage and sewage disposal systems.

D. Minimum *grade*(s) for sewers shall be so designed that the flow will have a mean velocity of 2 fps (0.6096 m/s) when the pipe is flowing half full.

E. The discharge of a park drainage system shall be connected to a community sewerage system. Where a community sewerage system is not available, an approved commercial treatment facility or individual sewerage system shall be installed in accord with the requirements of LAC 51:XIII (Sewage Disposal).

F. Manholes and/or cleanouts shall be provided and constructed as required in Chapter 7 of this code. Manholes and/or cleanouts shall be accessible and brought to *grade*(G).

G. When in a travel trailer park (i.e., other than a single travel trailer on its own lot), the sewer main shall be

provided with a minimum 4-inch vent, not more than 5 feet (1524 mm) downstream from its upper trap. Long mains shall be provided with additional relief vents at intervals of not more than 200 feet (61 m) thereafter. These relief vents shall be a minimum of 4 inches and shall be securely supported and extended a minimum of 10 feet (3048 mm) above grade_(G).

H. Branch lines or sewer laterals to individual travel trailers shall be not less than 4-inch diameter.

I. Sewer inlets shall be 4-inch diameter and extend above grade_(G) 3 to 6 inches (76 to 152 mm). Each inlet shall be provided with a gas-tight seal when connected to a trailer and have a gas-tight seal plug for use when not in service.

J. Each trailer site shall be provided with a trailer trap. Sewer laterals over 30 ft (9144 mm) from the main park drainage sewer shall be provided with an individual vent and shall also be provided with a 4-inch cleanout brought to grade_(G). When an individual vent for the sewer lateral/trailer trap is required, it shall be 3-inch minimum (upstream of the clean out fitting) and shall extend not less than 10 inches above the roof of the travel trailer.

K. To provide the shortest possible drain connection between the travel trailer outlet and sewer inlet, all sewer inlets should terminate with reference to the site location of the travel trailer.

L. Drain connections shall slope continuously downward and form no traps. All pipe joints and connections shall be installed and maintained gastight and watertight.

M. No sewage, waste water, or any other effluent shall be allowed to be deposited on the surface of the ground.

N. Testing the Park Drainage System. Upon completion and before covering, the park drainage system shall be subjected to a static water test performed in accordance with §§319.A and 319.B.1 of this code.

AUTHORITY NOTE: Promulgated in accordance with R.S. 40:4(A)(7) and R.S. 40:5(2)(3)(7)(9)(16)(17)(20).

HISTORICAL NOTE: Promulgated by the Department of Health and Hospitals, Office of Public Health, LR 38:2894 (November 2012).

§1517. Water Distribution System

A. General. Every travel trailer site shall be provided with an individual branch water service line delivering potable water. The outlet of the branch water service line shall terminate on the left side of the site of the travel trailer.

B. Minimum Size. Water service lines to each trailer site shall be sized to provide a minimum of 8 gpm (0.505 L/s) at the point of connection with the trailer's water distribution system. All water service lines shall be a minimum of ¾ inch.

C. Backflow. A minimum of a double check valve assembly backflow preventer shall be installed on the water service line to each independent trailer at, or near, the trailer's water service connection. Backflow preventer devices shall meet the requirements of §609.B and Table 609

of this code. Check valves shall be designed and maintained to close drip tight at a reduced pressure of not less than 1 nor more than 5 psi (6.9 to 34.5 kPa). Check valves must be identified with the manufacturer's name and model number.

D. Separate Service Shutoff. A separate service shutoff valve shall be installed in each water service line on the supply side of the backflow preventer device. Per §617.A of this code, such separate shutoff valve shall be a full port ball valve.

E. Water Service Connections. The water service connection from the water service line to the trailer shall be not less than 1/2-inch diameter. A rigid pipe shall not be used. Flexible metal tubing is permitted. Fittings at either end shall be of a quick disconnect type not requiring any special tools or knowledge to install or remove.

AUTHORITY NOTE: Promulgated in accordance with R.S. 40:4(A)(7) and R.S. 40:5(2)(3)(7)(9)(16)(17)(20).

HISTORICAL NOTE: Promulgated by the Department of Health and Hospitals, Office of Public Health, LR 38:2895 (November 2012).

§1519. Travel Trailer Connections

A. Responsibility. When it is evident that there exists, or may exist, a violation of these rules, the owner, operator, lessee, person in charge of the park, or any other person causing a violation shall cause it to be corrected immediately or disconnect the service connection and travel trailer drain connection from the respective park water service line and sewer lateral.

B. Drain Connections. Travel trailer drain connections shall be of approved semi rigid or flexible reinforced hose having smooth interior surfaces of not less than 3-inch inside diameter. Drain connections shall be equipped with a standard quick disconnect screw or clamp type fitting, not less in size than the outlet. Drain connections shall be gastight and no longer than necessary to make the connection between the travel trailer outlet and the trap inlet on the site.

AUTHORITY NOTE: Promulgated in accordance with R.S. 40:4(A)(7) and R.S. 40:5(2), (3), (7), (9), (16), (17), and (20).

HISTORICAL NOTE: Promulgated by the Department of Health and Hospitals, Office of Public Health, LR 38:2895 (November 2012).

§1521. Maintenance

A. All devices or safeguards required by this Chapter shall be maintained in good working order by the owner, operator, or lessee of the travel trailer park or his designated agent.

AUTHORITY NOTE: Promulgated in accordance with R.S. 40:4(A)(7) and R.S. 40:5(2)(3)(7)(9)(16)(17)(20).

HISTORICAL NOTE: Promulgated by the Department of Health and Hospitals, Office of Public Health, LR 38:2895 (November 2012).

§1523. Individual Travel Trailers

A. Individual travel trailers located within previously constructed travel trailer parks shall be provided with a trailer trap in accord with §1003.E of this code.

APPROVED MATERIALS FOR TRAP & VENT:
 (1) CAST IRON PIPE & FITTINGS.
 (2) ABS OR PLASTIC PIPE & FITTINGS (SCH. 40)

APPROVED SEWER PIPES:
 (1) CAST IRON SEWER PIPE.
 (2) VITRIFIED CLAY SEWER PIPE.
 (3) APPROVED PLASTIC PIPE AND FITTINGS (MIN. SDR 35)
 (NOTE: FROM A POINT AT LEAST 3 FEET OUTSIDE THE
 EDGE OF THE TRAILER TO THE SEWAGE SYSTEM.)

NOTES: (1) ASTM D2729 IS NOT APPROVED FOR
 ANY PART OF THE SYSTEM.
 (2) INSTALL 4" CLEANOUT FOR TRAILER
 CONNECTION AND TERMINATE 3 TO 6
 INCHES ABOVE GRADE.
 (3) INSTALL 3" MALE ADAPTER IN TRAILER
 CONNECTION.

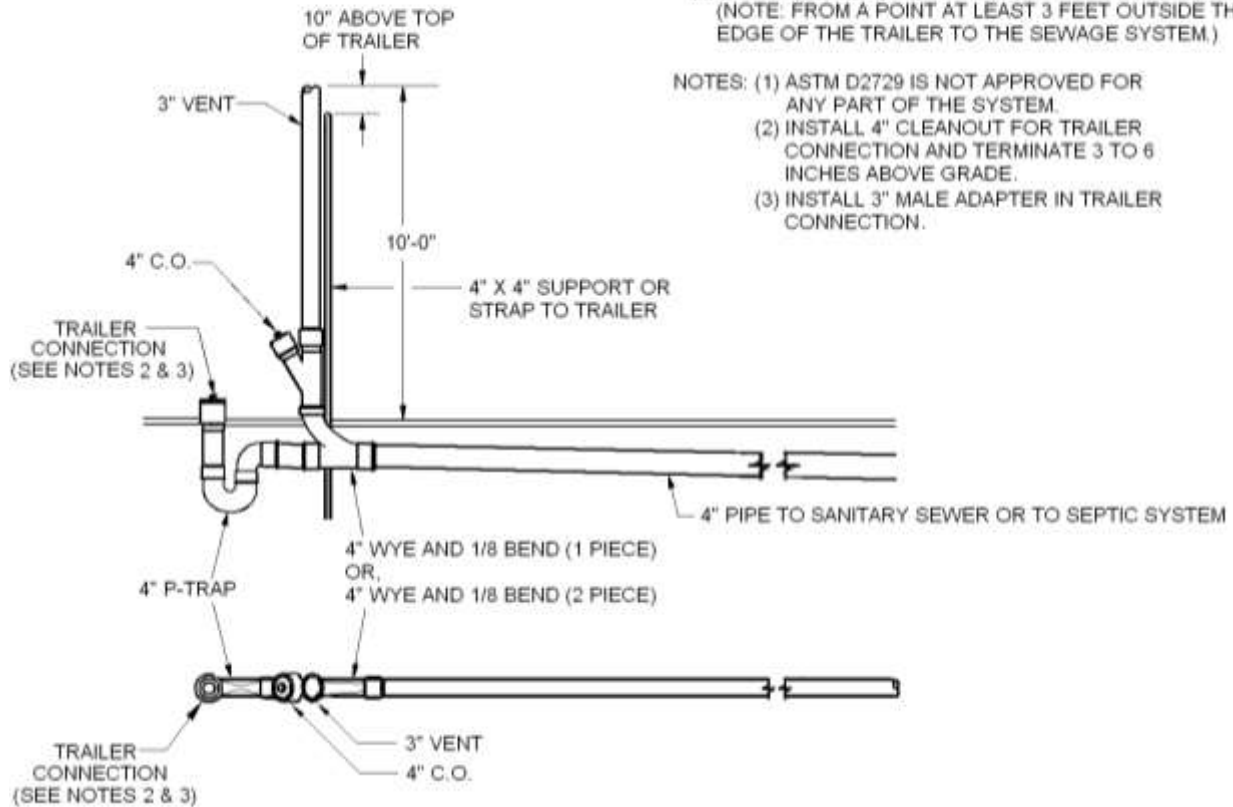

Figure 1523.A—Trailer Trap and Vent

AUTHORITY NOTE: Promulgated in accordance with R.S. 40:4(A)(7) and R.S. 40:5(2)(3)(7)(9)(16)(17)(20).

HISTORICAL NOTE: Promulgated by the Department of Health and Hospitals, Office of Public Health, LR 38:2895 (November 2012).

Chapter 16. Mobile/Manufactured Homes and Mobile/Manufactured Home Parks [formerly Appendix C—Mobile/ Manufactured Homes and Mobile/Manufactured Home Parks]

§1601. Purpose, Application and Scope

A. With the exception of §1623 of this code, the requirements set forth in this Chapter shall apply specifically to all new mobile/manufactured home parks, and to additions to existing parks as herein defined, and are to provide minimum standards for sanitation and plumbing installation within these parks, for the accommodation, use and parking of mobile/manufactured homes. Plumbing installations within mobile/manufactured homes shall be installed in accordance with NFPA 1192.

AUTHORITY NOTE: Promulgated in accordance with R.S. 40:4(A)(7) and R.S. 40:5(2)(3)(7)(9)(16)(17)(20).

HISTORICAL NOTE: Promulgated by the Department of Health and Hospitals, Office of Public Health, LR 38:2896 (November 2012).

§1603. Definitions

A. Definitions contained in Chapter 2 and Section 1503 of this code shall also apply to this Chapter, except where the following special definition shall apply.

Mobile/Manufactured Home—a vehicular, portable structure built on a chassis and designed to be used as a dwelling without a permanent foundation when connected to indicated utilities per NFPA 1192.

AUTHORITY NOTE: Promulgated in accordance with R.S. 40:4(A)(7) and R.S. 40:5(2)(3)(7)(9)(16)(17)(20).

HISTORICAL NOTE: Promulgated by the Department of Health and Hospitals, Office of Public Health, LR 38:2896 (November 2012).

§1605. General Regulations

A. Other general provisions of this code shall govern the installation of plumbing systems in mobile/manufactured home parks, except where special conditions or construction are specifically defined in this Chapter.

B. Mobile/manufactured homes shall not hereafter be parked in any mobile/manufactured home park unless plumbing and sanitation facilities have been installed and maintained in conformity with these regulations. Every mobile/manufactured home shall provide a gastight and watertight connection for sewage disposal which shall be connected to an underground sewage collection system discharging into a community sewerage system, a commercial treatment facility, or an individual sewerage system which has been approved by the state health officer.

AUTHORITY NOTE: Promulgated in accordance with R.S. 40:4(A)(7) and R.S. 40:5(2)(3)(7)(9)(16)(17)(20).

HISTORICAL NOTE: Promulgated by the Department of Health and Hospitals, Office of Public Health, LR 38:2896 (November 2012).

§1607. Plans and Specifications

A. The owner or operator of every mobile/manufactured home park, or the plumbing contractor employed by him before providing areas of space for the use and accommodation of mobile/manufactured homes, shall make application for a permit (where such permit is required by state, parish, city or other local laws or ordinances) or regardless of whether or not an actual permit is required, shall file two sets of plans and specifications with the department(s) having jurisdiction for their review and approval. The plans and specifications shall be in detail and shall include/comply with the following:

1. a scaled plot plan of the park, indicating the spaces, area or portion of the park for the parking of mobile/manufactured homes;
2. size, location and specification of park drainage system;
3. size, location and specification of water supply lines;
4. size, location and layout of service building, if applicable (see §1619 of this code);
5. size, location, specification and layout of the fire protection system, if applicable;
6. a scaled layout of typical mobile/manufactured home sites;
7. applications/submittals shall bear the approval of the local enforcement agencies as to compliance with city or parish plumbing, zoning and health ordinances;
8. plumbing required by this Chapter shall comply with all city, parish and state plumbing and health ordinances and regulations;
9. the issuance of a permit (or an approval of a submittal) shall not constitute approval of any violation of this code or violation of any city or parish ordinance or regulation; and
10. an approved set of plans and specifications and a copy of the permit (or written approval of a submittal) shall be kept on the park premises until the final inspection has been made.

AUTHORITY NOTE: Promulgated in accordance with R.S. 40:4(A)(7) and R.S. 40:5(2)(3)(7)(9)(16)(17)(20).

HISTORICAL NOTE: Promulgated by the Department of Health and Hospitals, Office of Public Health, LR 38:2897 (November 2012).

§1609. Materials

A. Unless otherwise provided for in this Chapter, all piping fixtures or devices used in the installation of drainage and water distribution systems for mobile/manufactured home parks, or parts thereof, shall conform to the quality and weights of materials required by the Louisiana State Plumbing Code.

AUTHORITY NOTE: Promulgated in accordance with R.S. 40:4(A)(7) and R.S. 40:5(2)(3)(7)(9)(16)(17)(20).

HISTORICAL NOTE: Promulgated by the Department of Health and Hospitals, Office of Public Health, LR 38:2897 (November 2012).

§1611. General Regulations

A. Unless otherwise provided for in this Chapter, all plumbing fixtures, piping, drains, appurtenances and appliances designed and used in a park drainage, water distribution system and service connections shall be installed in conformance with the Louisiana State Plumbing Code.

AUTHORITY NOTE: Promulgated in accordance with R.S. 40:4(A)(7) and R.S. 40:5(2)(3)(7)(9)(16)(17)(20).

HISTORICAL NOTE: Promulgated by the Department of Health and Hospitals, Office of Public Health, LR 38:2897 (November 2012).

§1613. Park Drainage System

A. The sewer main and sewer laterals shall be installed in a separate trench not less than 5 feet (1524 mm) from the park water service or distribution system. See §§613.C and 613.D of this code.

B. The minimum size of pipe in any mobile/manufactured home park drainage system shall be 4 inches.

C. Each mobile/manufactured home shall be considered as 15 fixture units in determining discharge requirements in the design of park drainage and sewage disposal systems.

D. Minimum grade_(S) for sewers shall be so designed that the flow will have a mean velocity of 2 fps (0.6096 m/s) when the pipe is flowing half full.

E. The discharge of a park drainage system shall be connected to a community sewerage system. Where a community sewerage system is not available, an approved commercial treatment facility or an individual sewerage system shall be installed in accord with the requirements of LAC 51:XIII (Sewage Disposal).

F. Manholes and/or cleanouts shall be provided and constructed as required in Chapter 7 of this code. Manholes and/or cleanouts shall be accessible and brought to grade_(G).

G. When located in a mobile/manufactured home park (i.e., other than a single mobile/manufactured home on its own lot), the sewer main shall be provided with a minimum 4-inch vent, not more than 5 feet (1524 mm) downstream from its upper trap. Long mains shall be provided with additional relief vents at intervals of not more than 200 feet (61 m) thereafter. These relief vents shall be a minimum of 4 inches and shall be securely supported and extended a minimum of 10 feet (3048 mm) above grade_(G).

H. Branch lines or sewer laterals to mobile/manufactured homes shall be not less than 4-inch diameter.

I. Sewer inlets shall be 4-inch diameter and extend above grade_(G) 3 to 6 inches (76 to 152 mm). Each inlet shall be provided with a gastight seal when connected to a mobile/manufactured home and have a gastight seal plug for use when not in service.

J. Each mobile/manufactured home site shall be provided with a trailer trap. Sewer laterals over 30 ft (9144 mm) from the main park drainage sewer shall be provided with an individual vent and shall also be provided with a 4-inch cleanout brought to grade_(G). When an individual vent for the sewer lateral/trailer trap is required, it shall be 3-inch minimum (upstream of the clean out fitting) and shall extend not less than 10 inches above the roof of the mobile/manufactured home.

K. To provide the shortest possible drain connection between the mobile/manufactured home outlet and sewer inlet, all sewer inlets should terminate in the rear one-third of the mobile/manufactured home as placed on the site.

L. Drain connections shall slope continuously downward and form no traps. All pipe joints and connections shall be installed and maintained gastight and watertight.

M. No sewage, waste water, or any other effluent shall be allowed to be deposited on the surface of the ground.

N. Testing the Park Drainage System. Upon completion and before covering, the park drainage system shall be subjected to a static water test performed in accordance with §§319.A and 319.B.1 of this code.

AUTHORITY NOTE: Promulgated in accordance with R.S. 40:4(A)(7) and R.S. 40:5(2)(3)(7)(9)(16)(17)(20).

HISTORICAL NOTE: Promulgated by the Department of Health and Hospitals, Office of Public Health, LR 38:2897 (November 2012).

§1615. Water Supply and Distribution Systems

A. General. Every mobile/manufactured home site shall be provided with an individual branch water service line delivering potable water. The outlet of the branch water service line shall terminate on the left side of the site of the mobile/manufactured home.

B. Minimum Size. Water service lines to each mobile/manufactured home site shall be sized to provide a minimum of 17 gpm (1.1 L/s) at the point of connection with the mobile/manufactured home's water distribution system. All water service lines shall be a minimum of 3/4-inch.

C. Separate Service Shutoff. A separate service shutoff valve shall be installed in each water service line. Per §617.A of this code, such separate shutoff valve shall be a full port ball valve.

D. Water Service Connections. The water service connection from the water service line to the mobile/manufactured home shall be not less than 1/2-inch diameter. A rigid pipe shall not be used. Flexible metal tubing is permitted. Fittings at either end shall be of a quick disconnect type not requiring any special tools or knowledge to install or remove.

E. Water Supply System Design. The water supply system shall be designed to provide a minimum of 150 gallons (568 L) per day for each mobile/manufactured home, plus such additional volume as may be required for fire protection of the park, service buildings and other community facilities.

AUTHORITY NOTE: Promulgated in accordance with R.S. 40:4(A)(7) and R.S. 40:5(2)(3)(7)(9)(16)(17)(20).

HISTORICAL NOTE: Promulgated by the Department of Health and Hospitals, Office of Public Health, LR 38:2898 (November 2012).

§1617. Mobile/Manufactured Home Connections

A. Responsibility. When it is evident that there exists, or may exist, a violation of these rules, the owner, operator, lessee, person in charge of the park or any other person causing a violation shall cause it to be corrected immediately or disconnect the service connections and mobile/manufactured home drain connection from the respective park water service line and sewer lateral.

B. Drain Connections. Mobile/manufactured home drain connections shall be of approved semi-rigid pipe having smooth interior surfaces of not less than 3-inch inside diameter. Drain connections shall be equipped with a standard quick disconnect screw, clamp type fitting or solvent welder, not less in size than the outlet. Drain connections shall be gastight and no longer than necessary to make the connection between the mobile/manufactured home outlet and the trap inlet on the site.

AUTHORITY NOTE: Promulgated in accordance with R.S. 40:4(A)(7) and R.S. 40:5(2)(3)(7)(9)(16)(17)(20).

HISTORICAL NOTE: Promulgated by the Department of Health and Hospitals, Office of Public Health, LR 38:2898 (November 2012).

§1619. Service Buildings

A. Each mobile/manufactured home park serving travel trailers shall have at least one service building to provide minimum sanitation and laundry facilities in accord with §1509 of this code.

AUTHORITY NOTE: Promulgated in accordance with R.S. 40:4(A)(7) and R.S. 40:5(2)(3)(7)(9)(16)(17)(20).

HISTORICAL NOTE: Promulgated by the Department of Health and Hospitals, Office of Public Health, LR 38:2898 (November 2012).

§1621. Maintenance

A. All devices or safeguards required by this Chapter shall be maintained in good working order by the owner, operator, or lessee of the mobile/manufactured home park or his designated agent.

AUTHORITY NOTE: Promulgated in accordance with R.S. 40:4(A)(7) and R.S. 40:5(2)(3)(7)(9)(16)(17)(20).

HISTORICAL NOTE: Promulgated by the Department of Health and Hospitals, Office of Public Health, LR 38:2898 (November 2012).

§1623. Individual Mobile/Manufactured Homes

A. Individual mobile/manufactured homes located within previously constructed mobile/manufactured home parks shall be provided with a trailer trap in accord with §1003.E of this code.

- APPROVED MATERIALS FOR TRAP & VENT:
 (1) CAST IRON PIPE & FITTINGS.
 (2) ABS OR PLASTIC PIPE & FITTINGS (SCH. 40)

- APPROVED SEWER PIPES:
 (1) CAST IRON SEWER PIPE.
 (2) VITRIFIED CLAY SEWER PIPE.
 (3) APPROVED PLASTIC PIPE AND FITTINGS (MIN. SDR 35)
 (NOTE: FROM A POINT AT LEAST 3 FEET OUTSIDE THE EDGE OF THE TRAILER TO THE SEWAGE SYSTEM.)

- NOTES: (1) ASTM D2729 IS NOT APPROVED FOR ANY PART OF THE SYSTEM.
 (2) INSTALL 4" CLEANOUT FOR TRAILER CONNECTION AND TERMINATE 3 TO 6 INCHES ABOVE GRADE.
 (3) INSTALL 3" MALE ADAPTER IN TRAILER CONNECTION.

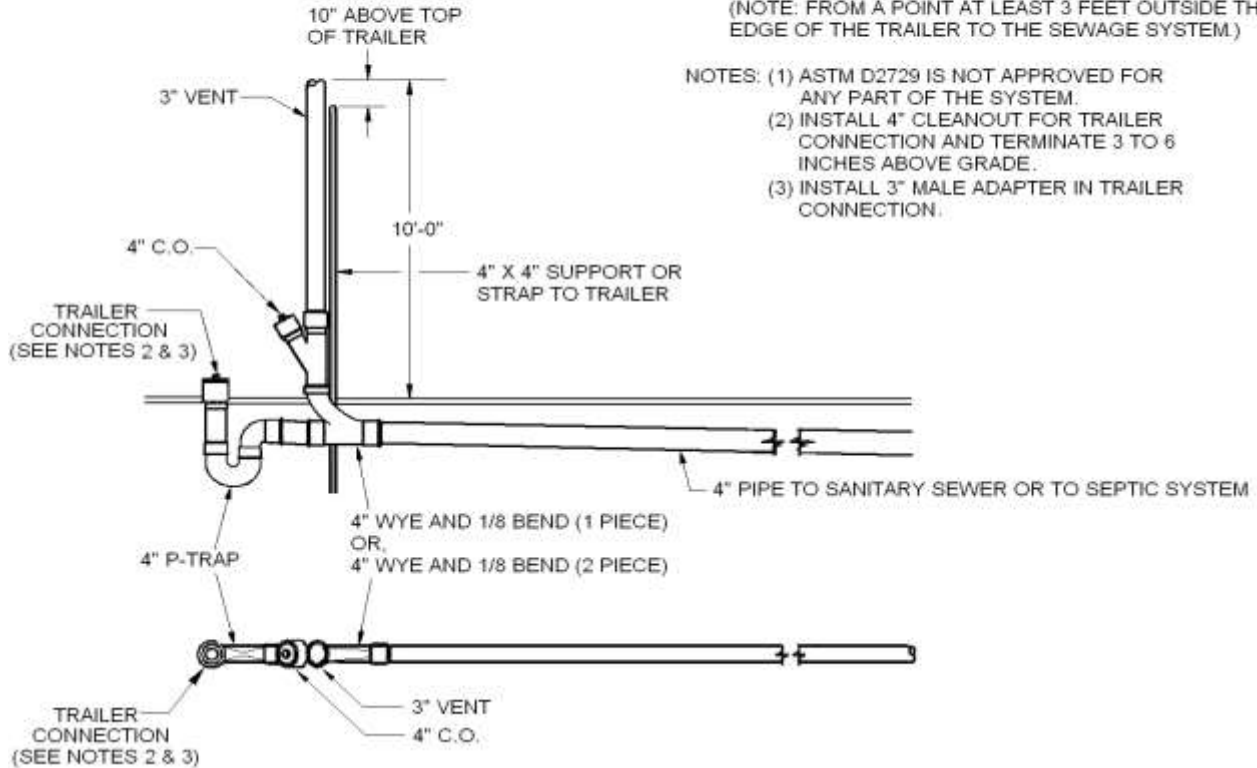

Figure 1623.A—Trailer Trap and Vent

AUTHORITY NOTE: Promulgated in accordance with R.S. 40:4(A)(7) and R.S. 40:5(2)(3)(7)(9)(16)(17)(20).

HISTORICAL NOTE: Promulgated by the Department of Health and Hospitals, Office of Public Health, LR 38:2898 (November 2012).

Chapter 17. Sewerage System Regulations [formerly Appendix E—Private Sewage Disposal]

§1701. General

A. Refer to Part XIII (Sewage Disposal) of the State of Louisiana Sanitary Code (LAC 51:XIII) for applicable sewage disposal regulations.

AUTHORITY NOTE: Promulgated in accordance with R.S. 40:4(A)(7) and R.S. 40:5(2)(3)(7)(9)(16)(17)(20).

HISTORICAL NOTE: Promulgated by the Department of Health and Hospitals, Office of Public Health, LR 38:2899 (November 2012).

Chapter 18. Appendices

§1801. Scope

A. The provisions of the appendices contained in this Chapter are designed for informational purposes only. When the word "shall" is used in one or more provisions of this Chapter, it is advisable to take the provision seriously and as though it were an actual requirement. Doing so will assist in ensuring compliance with the actual requirements of Chapters 1-17.

AUTHORITY NOTE: Promulgated in accordance with R.S. 40:4(A)(7) and R.S. 40:5(2)(3)(7)(9)(16)(17)(20).

HISTORICAL NOTE: Promulgated by the Department of Health and Hospitals, Office of Public Health, LR 38:2899 (November 2012).

§1803. Appendix A—Roof Drain Sizing Method

A. Sizing Example. The following example gives one method of sizing the primary drain system and sizing the scuppers in the parapet walls. This method converts the roof area to an equivalent roof area for a 4-inch rate of rainfall so that Tables 1111.A and 1111.B of this code can be used as printed. The method described in §1111.B.2 of this code converts Tables 1111.A and 1111.B of this part to tables for the rate of rainfall specified for the area.

1. Problem: Given the roof plan in Figure 1803.A.1 of this Part and the site location in Birmingham, Alabama, size the primary roof drain system and size the scuppers, denoting the required head of water above the scupper for the structural engineer.

NOTE: For the purposes of this appendix the following metric conversions are applicable:

- 1 in = 25.4 mm
- 1 ft = 305 mm
- 1 ft² = 0.0929 m²

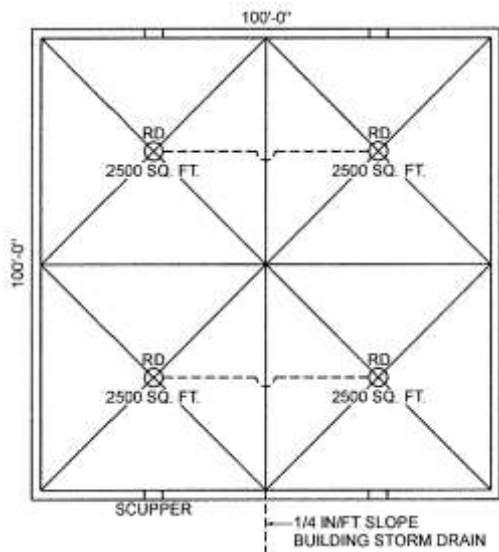

Figure 1803.A.1—Example Roof Plan

2. Solution:

Step a. From Figure 1111.E of this Part, the 100 year 60 minute precipitation is 3.75 inches per hour.

Step b. Each vertical drain must carry 2,500 sq ft of roof area at 3.75 inches per hour of rainfall. To convert to an area for a 4 inch per hour rainfall to enter LAC 51:XIV.Table 1111.A do this:

$$2,500 \div 4 \times 3.75 = 2,344 \text{ sq ft.}$$

Enter LAC 51:XIV.Table 1111.A until you find a diameter pipe that will carry 2,344 sq ft. A minimum 4-inch vertical drain is required.

Step c. Horizontal Drain
2,500 sq ft.

To convert to an area for use in LAC 51:XIV.Table 1111.B do this:

$$2,500 \div 4 \times 3.75 = 2,344 \text{ sq ft}$$

Enter LAC 51:XIV.Table 1111.B until you find a diameter pipe that will carry 2,344 sq ft.

A minimum 4-inch diameter pipe with a 1/4 inch per foot slope will carry 2,650 sq ft. A minimum 4-inch diameter drain on a 1/4 inch per foot slope is required.

Step d. Horizontal Drain
5,000 sq ft.

To convert to an area for use in LAC 51:XIV.Table 1111.B do this:

$$5,000 \div 4 \times 3.75 = 4,688 \text{ sq ft.}$$

Enter LAC 51:XIV.Table 1111.B until you find a diameter pipe that will carry 4,688 sq ft. A 5-inch diameter pipe with a 1/4 inch per foot slope will

carry 4,720 sq ft. A minimum 5-inch diameter drain on a 1/4 inch per foot slope is required.

Step e. Horizontal Drain
10,000 sq ft.

To convert to an area for use in LAC 51:XIV.Table 1111.B do this:

$$10,000 \div 4 \times 3.75 = 9,375 \text{ sq ft.}$$

Enter LAC 51:XIV.Table 1111.B until you find a diameter pipe that will carry 9,375 sq ft. An 8-inch diameter pipe on 1/4 inch per foot slope will carry 16,300 sq ft but a 6-inch will carry only 7,550 sq ft; therefore, use an 8-inch diameter drain on a 1/4 inch per foot slope.

Step f. From Figure 1113.C of this Part, the rate caused by a 100 year 15 minute precipitation is 7.2 inches per hour. The scuppers must be sized to carry the flow caused by a rain fall rate of 7.2 inches per hour.

Step g. Each scupper is draining 2,500 sq ft of roof area. To convert this roof area to an area for use with LAC 51:XIV.Table 1803.A.2 do this:

$$2,500 \div 4 \times 7.2 = 9,375 \text{ sq ft} = 4,500 \text{ sq ft.}$$

Enter LAC 51:XIV.Table 1803.A.2 to find a length and head that will carry 4,500 sq ft or more. From LAC 51:XIV.Table 1803.A.2 a 12-inch wide weir with a 4-inch head carries 6,460 sq ft. Use 12-inch wide x 5-inch high scuppers at four locations. A height of 5 inches is needed to assure an open area above the 4-inch head.

Step h. Notify the structural engineer that the design of the roof structure must account for a height of water to the scupper entrance elevation plus 4 inches for the required head to cause design flow.

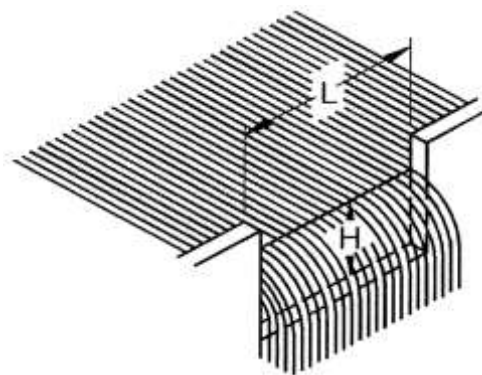

Figure 1803.A.2—Example Scupper

Table 1803.A.2 Scupper Sizing Table Roof Area (Sq ft)							
Head (H) Inches	Length (L) of Weir (Inches)						
	4	6	8	12	16	20	24
1	273	418	562	851	1,139	1,427	1,715
2	734	1,141	1,549	2,365	3,180	3,996	4,813
3	1,274	2,023	2,772	4,270	5,768	7,267	8,766
4	1,845	2,999	4,152	6,460	8,766	11,073	13,381
6	2,966	5,087	7,204	11,442	15,680	19,918	24,160

NOTE: Based on rainfall of 4 inches per hour

AUTHORITY NOTE: Promulgated in accordance with R.S. 40:4(A)(7) and R.S. 40:5(2)(3)(7)(9)(16)(17)(20).

HISTORICAL NOTE: Promulgated by the Department of Health and Hospitals, Office of Public Health, LR 38:2899 (November 2012).

**§1805. Appendix B—Sizing of Water Piping System
[formerly Appendix F—Sizing of Water Piping System]**

A. Scope. This Appendix outlines a procedure for sizing a water piping system. This design procedure is based on the minimum static pressure available from the supply source, the head charges in the system due to friction and elevation, and the rates of flow necessary for operation of various fixtures.

1. Because of the variable conditions encountered in hydraulic design, it is impractical to specify definite and detailed rules for sizing of the water piping system. Accordingly, other sizing or design methods conforming to good engineering practice standards are acceptable alternates to that presented herein.

B. Information Required. Prior to beginning calculations, the following preliminary information shall be measured or otherwise obtained from the water supplier.

1. Static Water Service Pressure/Meter Friction Loss. The minimum daily static water service pressure in the area where the building is to be located shall be measured or otherwise obtained from the water supplier. If the building's water supply is to be metered, obtain information regarding friction loss relative to the rate of flow for meters in the range of sizes likely to be used. Friction loss data can be obtained from most manufacturers of water meters.

C. Estimate of Demand Load Required. Prior to beginning calculations, the following estimates shall be made.

1. Fixture Water Supply Demand. Estimate the water supply demand of the building main and the principal branches and risers of the water distribution system by totaling the corresponding demand for fixtures from the applicable part of Table 1805.C of this code. The Load (in water supply fixture units) listed in Column 1 of Table 1805.C of this code shall be calculated using the load values, in water supply fixture units, obtained from Table 1805.B of this code.

2. Continuous Water Supply Demand. Estimate continuous water supply demands in gallons per minute for lawn sprinklers, air conditioners, etc., and add the sum to the total water supply demand for fixtures. The result is the estimated total water supply demand for the building.

D. Selection of Pipe Size. The selection of the size for the water service pipe, water riser pipes, branch supply lines, etc., shall be calculated using the following procedures.

1. General. Decide the desirable minimum residual pressure that should be maintained at the highest fixture in the water distribution system. If the highest group of fixtures contains flush valves, the pressure for the group should be not less than 15 psi (103.4 kPa) flowing. For flush tank supplies, the available pressure may not be less than 8 psi (55.2 kPa) flowing, except blowout action fixtures may not be less than 25 psi (172.4 kPa) flowing.

2. Pipe Sizing. Pipe sizes may be selected according to the following procedure, except that the sizes selected shall be not less than the minimum required by the Louisiana State Plumbing Code.

a. This water pipe sizing procedure is based on a system of pressure requirements and losses, the sum of which must not exceed the minimum pressure available at the supply source. These pressures are as follows.

i. Pressure required at fixture to produce required flow (see §§611.C, 611.D, and 611.E of this code).

ii. Static pressure loss or gain (due to head) is computed at 0.433 psi per foot (9.8 kPa/m) of elevation change.

(a). Example. Assume that the highest fixture supply outlet is 20 ft (6.1 m) above or below the supply source. This produces a static pressure differential of 20 ft x 0.433 psi/ft (6.1 m x 9.8 kPa/m) which equates to an 8.66 psi (59.8 kPa) loss or an 8.66 psi (59.8 kPa) gain.

iii. Loss through water meter. The friction or pressure loss can be obtained from meter manufacturers.

iv. Loss through taps in water main (see Table 1805.D of this code).

v. Losses through special devices such as filters, softeners, backflow preventers, and pressure regulators. These values must be obtained from the manufacturers.

vi. Loss through valves and fittings (see Tables 1805.E and 1805.F of this code). Losses for these items are calculated by converting to equivalent length of piping and adding to the total pipe length.

vii. Loss due to pipe friction can be calculated when the pipe size, the pipe length and the flow through the pipe are known. With these three items, the friction loss can be determined using Figures 1805.A.1-1805.D of this Part. When using charts, use pipe inside diameter. For piping flow charts not included, use manufacturers' tables and velocity recommendations.

3. Example. The following example is provided to assist one in calculating the proper sizing of the water piping system for a plumbing installation of a building or other structure.

NOTE: For the purposes of this example the following metric conversions are applicable:

1 cfm = 0.4719 L/s	1 ft ² = 0.0929 m ²
1 degree = 0.0175rad	1 psi = 6.895 kPa
1 in = 25.4 mm	1 gpm = 0.0631 L/s

a. Problem. What size copper water pipe, service and distribution will be required to serve a two story factory building having on each floor, back-to-back, two toilet rooms each equipped with hot and cold water? The highest fixture is 21 feet above the street main which is tapped with a 2-inch corporation cock at which point the minimum pressure is 55 psi. In the building basement a 2-inch meter and 3-inch reduced pressure zone backflow preventer with a maximum pressure drop of 9 psi are to be installed. The system is shown by the example diagram (Figure 1805.D.3 of this code). To be determined are the pipe sizes for the service main and the cold and hot water distribution pipes.

b. Solution. A tabular arrangement such as shown in Table 1805.A of this code should first be constructed. The steps to be followed in solving the problem are indicated by the tabular arrangement itself as they are in sequence, Columns 1-10 and Lines a-l.

i. Step i. Perform the following:

(a). Column 1. Divide the system into sections breaking at major changes in elevation or where branches lead to fixture groups. After point B (see Figure 1805.D.3 of this code) separate consideration will be given to the hot and cold water piping. Enter the sections to be considered in the service and cold water piping in Column 1 of the tabular arrangement.

(b). Column 3. According to the method given in §1805.C of this code, determine the gpm of flow to be expected in each section of the system. These flows range from 28.6 to 108 gpm.

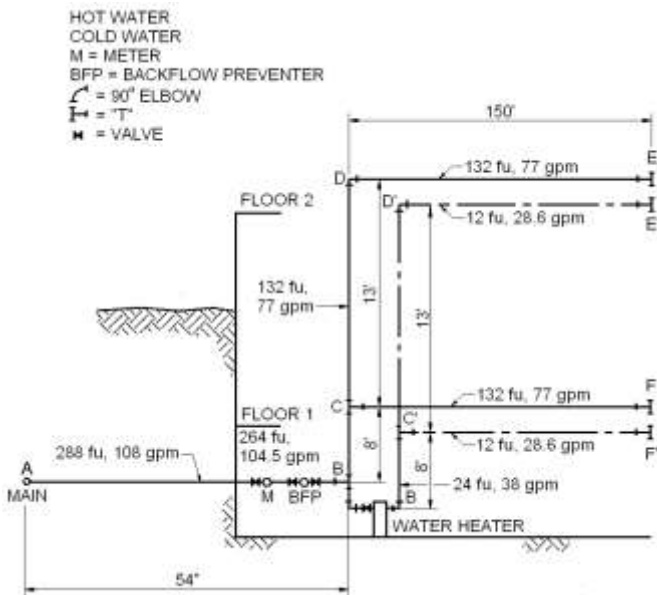

Figure 1805.D.3—Sizing Example

ii. Step ii. Perform the following.

(a). Line "a." Enter the minimum pressure available at the main source of supply in Column 2. This is 55 psi.

(b). Line "b." Determine from §611.E of this code the highest pressure required for the fixtures on system, which is 15 psi, to operate a flushometer valve.

(c). Line "c." Determine the pressure loss for the meter size given or assumed. The total water flow from the main through the service as determined in Step i (above) will serve to aid in the meter selected.

(d). Line "d." Select from Table 1805.D of this code and enter the pressure loss for the tap size given or assumed.

(e). Line "e." Determine the difference in elevation between the main or source of

supply and the highest fixture on the system and multiply this figure, expressed in feet, by 0.433 psi. Enter the resulting psi product on Line "e."

(f). Lines "f," "g," "h." The pressure losses through filters, backflow preventers or other special fixtures must be obtained from the manufacturer or estimated and entered on these lines.

iii. Step iii, Line "i." The sum of (Lines "b" through "h") the pressure requirements and losses which affect the overall system is entered on this line.

iv. Step iv, Line "j." Subtract Line "i" from Line "a." This gives the pressure which remains available from overcoming friction losses in the system. This figure is a guide to the pipe size which is chosen for each section, as the total friction losses through the longest run of pipe.

(a). Exception. When the main is above the highest fixture, the resulting psi must be considered a pressure gain (static head gain) and omitted from the sums of Lines "b"- "h" and added to Line "j."

v. Step v, Column 4. Enter the length of each section from the main to the end of the longest run (at Point E).

vi. Step vi, Column 5. Select a trial pipe size. A rule of thumb is that size will become progressively smaller as the system extends farther from the main source of supply. (Trial pipe size may be arrived at by the following formula: $PSI=j \times 100/\text{total pipe length}$)

EXAMPLE: $PSI = 9.36 \times 100/225 = 4.16$

From main to most remote outlet—Check applicable graph for size for this PSI and GPM.

vii. Step vii, Column 6. Select from Tables 1805.E or 1805.F of this code the equivalent lengths for the trial pipe size of fittings and valves on the section. Enter the sum for each section in Column 6. (The number of fittings to be used in the installation of this piping must be an estimate.)

viii. Step viii. Column 7: Add the figures from Column 4 and Column 6, and enter in Column 7. Express the sum in 100s of feet.

ix. Step ix. Column 8: Select from the applicable figure (Figures 1805.A.1 through 1805.D of this Part) the friction loss per 100 feet of pipe for the gpm flow in a section (Column 3) and trial pipe size (Column 5).

x. Step x. Column 9: Multiply the figures in Columns 7 and 8 for each section and enter in Column 9.

xi. Step xi. Line k: Enter the sum of the values in Column 9. In summing, use only those values associated with the longest run (i.e., don't use the value associated with section CF unless the friction loss for CF by itself is greater than the combined fixture loss of $AB + BC + CD + DE$).

xii. Step xii. Line 1: Subtract Line "k" from Line "j" and enter in Column 10.

PUBLIC HEALTH—SANITARY CODE

(a). The result should always be a positive or plus figure. If it is not, it is necessary to repeat the operation utilizing Columns, 5, 6, 8 and 9 until a balance or near balance is obtained. If the difference between Lines "j" and "k" is positive and large, it is an indication that the pipe sizes are too large and may, therefore, be reduced thus saving materials. In such a case, the operations utilizing Columns 5, 6, 8 and 9 should again be repeated.

sections. Repeating this operation a second time using the same sketch but considering the demand for hot water, it is possible to size the hot water distribution piping. This has been worked up as a part of the overall problem in the tabular arrangement used for sizing the service and cold water distribution piping. It should be noted that consideration must be given the pressure losses from the street main to the water heater (section AB) in determining the hot water pipe sizes.

c. Answer: The final figures entered in Column 5 become the design pipe size for the respective

Table 1805.A Recommended Tabular Arrangement for Use in Solving Pipe Sizing Problems											
Column		1	2	3	4	5	6	7	8	9	10
Line		Description	Lbs. per square inch (psi)	Gal. per min. through section	Length of section (ft)	Trial pipe size (in)	Equivalent length of fittings and valves (ft)	Total equivalent length col.4 and col.6 (100 ft)	Friction loss per 100' of trial size pipe (psi)	Friction loss in equivalent length col.8 x col.7 (psi)	Excess pressure over friction losses (psi)
a	Service and cold water distribution piping (NOTE 1)	Minimum pressure available at main	55.00								
b		Highest pressure required at a fixture (§611.E of this code)	15.00								
c		Meter loss 2" meter	11.00								
d		Tap in main loss 2" tap (Table F103A of this code)	1.61								
e		Static head loss 21 x 0.43 psi	9.03								
f		Special fixture loss- backflow preventer	9.00								
g		Special fixture loss-Filter	0.00								
h		Special fixture loss-Other	0.00								
i		Total overall losses and requirements (sum of lines b-h)	45.64								
j		Pressure available to overcome pipe friction (line a minus lines b to h)	9.36								
	Designation pipe section (from diagram)	FU									
		AB	288	108.0	54	2 ½	12	0.66	3.6	2.38	
		BC	264	104.5	8	2 ½	2.5	0.105	3.2	0.34	
		CD	132	77.0	13	2 ½	8	0.21	1.9	0.40	
	Cold water distribution piping	CF (NOTE 2)	132	77.0	150	2 ½	12	1.62	1.9	3.08	
		DE	132	77.0	150	2 ½	14.5	1.645	1.9	3.12	
k	Total pipe friction losses (cold)									6.24	
l	Difference (line "j" minus line "k")							9.36	-6.24	=	3.12
	Pipe section (from diagram)	FU									
		AB'	288	108.0	54	2 ½	9.6	0.64	3.3	2.1	
		B'C'	24	38.0	8	2	9.0	0.17	1.4	0.24	
		C'D'	12	28.6	13	1 ½	5	0.18	3.2	0.58	
	Hot Water Distribution Piping	C'F' (NOTE 3)	12	28.6	150	1 ½	14	1.64	3.2	5.25	
		D'E'	12	28.6	150	1 ½	7	1.57	3.2	5.02	
k	Total pipe friction losses (hot)									7.94	
l	Difference (line "j" minus line "k")							9.36	-7.94	=	1.42

NOTES:

- To be considered as pressure gain for fixtures below main (consider separately omit from "j" and add to "j").

Title 51, Part XIV

2. Consider separately, in Line "k" use CF's Column 9 friction loss only if it is a greater friction loss than the sum of Column 9 friction losses of AB+BC+CD+DE.

Table 1805.B					
Load Values Assigned to Fixtures ¹					
Fixture	Occupancy	Type of Supply Control	Load Values, in Water Supply Fixture Units		
			Cold	Hot	Total
Bathroom group	Private	Flush tank	2.7	1.5	3.6
Bathroom group	Private	Flush valve	6.0	3.0	8.0
Bathtub	Private	Faucet	1.0	1.0	1.4
Bathtub	Public	Faucet	3.0	3.0	4.0
Bidet	Private	Faucet	1.5	1.5	2.0
Combination fixture	Private	Faucet	2.25	2.25	3.0
Dishwashing machine	Private	Automatic	-	1.4	1.4
Drinking fountain	Offices, etc.	3/8" valve	0.25	-	0.25
Kitchen sink	Private	Faucet	1.0	1.0	1.4
Kitchen sink	Hotel, Restaurant	Faucet	3.0	3.0	4.0
Laundry trays (1 to 3)	Private	Faucet	1.0	1.0	1.4
Lavatory	Private	Faucet	0.5	0.5	0.7
Lavatory	Public	Faucet	1.5	1.5	2.0
Service sink	Offices, etc.	Faucet	2.25	2.25	3.0
Shower head	Public	Mixing valve	3.0	3.0	4.0
Shower head	Private	Mixing valve	1.0	1.0	1.4
Urinal	Public	1" flush valve	10.0	-	10.0
Urinal	Public	3/4" flush valve	5.0	-	5.0
Urinal	Public	Flush tank	3.0	-	3.0
Washing machine (8 lbs.)	Private	Automatic	1.0	1.0	1.4
Washing machine (8 lbs.)	Public	Automatic	2.25	2.25	3.0
Washing machine (15 lbs.)	Public	Automatic	3.0	3.0	4.0
Water closet	Private	Flush valve	6.0	-	6.0
Water closet	Private	Flush tank	2.2	-	2.2
Water closet	Public	Flush valve	10.0	-	10.0
Water closet	Public	Flush tank	5.0	-	5.0
Water closet	Public or Private	FlushometerTank	2.0	-	2.0

NOTE:

1. For fixtures not listed, loads should be assumed by comparing the fixture to ones listed using water in similar quantities and at similar rates. The assigned loads for fixtures with both hot and cold water supplies are given for separate hot and cold water loads and for total load, the separate hot and cold water loads being three-fourths of the total load for the fixture in each case.

Table 1805.C					
Table for Estimating Demand					
Supply Systems Predominantly for Flush Tanks			Supply Systems Predominantly for Flush Valves		
Load	Demand		Load	Demand	
(Water Supply Fixture Units)	(Gallons per Minute)	(Cubic Feet per Minute)	(Water Supply Fixture Units)	(Gallons per Minute)	(Cubic Feet per Minute)
1	3.0	0.041104	-	-	-
2	5.0	0.0684	-	-	-
3	6.5	0.86892	-	-	-
4	8.0	1.06944	-	-	-
5	9.4	1.256592	5	15.0	2.0052
6	10.7	1.430376	6	17.4	2.326032
7	11.8	1.577424	7	19.8	2.646364
8	12.8	1.711104	8	22.2	2.967696
9	13.7	1.831416	9	24.6	3.288528
10	14.6	1.951728	10	27.0	3.60936
11	15.4	2.058672	11	27.8	3.716304
12	16.0	2.13888	12	28.6	3.823248
13	16.5	2.20572	13	29.4	3.930192
14	17.0	2.27256	14	30.2	4.037136
15	17.5	2.3394	15	31.0	4.14408
16	18.0	2.40624	16	31.8	4.241024
17	18.4	2.459712	17	32.6	4.357968
18	18.8	2.513184	18	33.4	4.464912
19	19.2	2.566656	19	34.2	4.571856
20	19.6	2.620128	20	35.0	4.6788
25	21.5	2.87412	25	38.0	5.07984

PUBLIC HEALTH—SANITARY CODE

Table 1805.C Table for Estimating Demand					
Supply Systems Predominantly for Flush Tanks			Supply Systems Predominantly for Flush Valves		
Load	Demand		Load	Demand	
30	23.3	3.114744	30	42.0	5.61356
35	24.9	3.328632	35	44.0	5.88192
40	26.3	3.515784	40	46.0	6.14928
45	27.7	3.702936	45	48.0	6.41664
50	29.1	3.890088	50	50.0	6.684
60	32.0	4.27776	60	54.0	7.21872
70	35.0	4.6788	70	58.0	7.75344
80	38.0	5.07984	80	61.2	8.181216
90	41.0	5.48088	90	64.3	8.595624
100	43.5	5.81508	100	67.5	9.0234
120	48.0	6.41664	120	73.0	9.75864
140	52.5	7.0182	140	77.0	10.29336
160	57.0	7.61976	160	81.0	10.82808
180	61.0	8.15448	180	85.5	11.42964
200	65.0	8.6892	200	90.0	12.0312
225	70.0	9.3576	225	95.5	12.76644
250	75.0	10.0260	250	101.0	13.50168
275	80.0	10.6944	275	104.5	13.96956
300	85.0	11.3628	300	108.0	14.43744
400	105.0	14.0364	400	127.0	16.97736
500	124.0	16.57632	500	143.0	19.11624
750	170.0	22.7256	750	177.0	23.66136
1000	208.0	27.80544	1000	208.0	27.80544
1250	239.0	31.94952	1250	239.0	31.94952
1500	269.0	35.95992	1500	269.0	35.95992
1750	297.0	39.70296	1750	297.0	39.70296
2000	325.0	43.446	2000	325.0	43.446
2500	380.0	50.7984	2500	380.0	50.7984
3000	433.0	57.88344	3000	433.0	57.88344
4000	535.0	70.182	4000	525.0	70.182
5000	593.0	79.27224	5000	593.0	79.27224

Table 1805.D Loss of Pressure through Taps and Tees in Pounds Per Square Inch (psi)							
Gallons per Minute	Size of Tap or Tee (In)						
	5/8	3/4	1	1 1/4	1 1/2	2	3
10	1.35	0.64	0.18	0.08	-	-	-
20	5.38	2.54	0.77	0.31	0.14	-	-
30	12.1	5.72	1.62	0.69	0.33	0.10	-
40	-	10.2	3.07	1.23	0.58	0.18	-
50	-	15.9	4.49	1.92	0.91	0.28	-
60	-	-	6.46	2.76	1.31	0.40	-
70	-	-	8.79	3.76	1.78	0.55	0.10
80	-	-	11.5	4.90	2.32	0.72	0.13
90	-	-	14.5	6.21	2.94	0.91	0.16
100	-	-	17.94	7.67	3.63	1.12	0.21
120	-	-	25.8	11.0	5.23	1.16	0.30
140	-	-	35.2	15.0	7.12	2.20	0.41
150	-	-	-	17.2	8.16	2.52	0.47
160	-	-	-	19.6	9.30	2.92	0.54
180	-	-	-	24.8	11.8	3.62	0.68
200	-	-	-	30.7	14.5	4.48	0.84
225	-	-	-	38.8	18.4	5.6	1.06
250	-	-	-	47.9	22.7	7.00	1.31
275	-	-	-	-	27.4	7.70	1.59
300	-	-	-	-	32.6	10.1	1.88

Table 1805.E Allowance in Equivalent Length of Pipe for Friction Loss in Valves and Threaded Fittings								
Fitting or Valve	Pipe Sizes (in)							
	1/2	3/4	1	1 1/4	1 1/2	2	2 1/2	3
45° elbow	1.2	1.5	1.8	2.4	3.0	4.0	5.0	6.0
90° elbow	2.0	2.5	3.0	4.0	5.0	7.0	8.0	10.0
Tee, run	0.6	0.8	0.9	1.2	1.5	2.0	2.5	3.0
Tee, branch	3.0	4.0	5.0	6.0	7.0	10.0	12.0	15.0
Gate valve	0.4	0.5	0.6	0.8	1.0	1.3	1.6	2.0
Balancing valve	0.8	1.1	1.5	1.9	2.2	3.0	3.7	4.5
Plug-type cock	0.8	1.1	1.5	1.9	2.2	3.0	3.7	4.5
Check valve, swing	5.6	8.4	11.2	14.0	16.8	22.4	28.0	33.6
Globe valve	15.0	20.0	25.0	35.0	45.0	55.0	65.0	80.0
Angle valve	8.0	12.0	15.0	18.0	22.0	28.0	34.0	40.0

Table 1805.F Allowance in Equivalent Length of Tube for Friction Loss in Valves and Fittings ¹ (ft) (Copper Water Tube)								
Fitting or valve	Tube Sizes (in)							
	1/2	3/4	1	1 1/4	1 1/2	2	2 1/2	3
45° elbow (wrought)	0.5	0.5	1.0	1.0	2.0	2.0	3.0	4.0
90° elbow (wrought)	0.5	1.0	1.0	2.0	2.0	2.0	2.0	3.0
Tee, run (wrought)	0.5	0.5	0.5	0.5	1.0	1.0	2.0	-
Tee, branch (wrought)	1.0	2.0	3.0	4.0	5.0	7.0	9.0	-
45° elbow (cast)	0.5	1.0	2.0	2.0	3.0	5.0	8.0	1.0
90° elbow (cast)	1.0	2.0	4.0	5.0	8.0	11.0	14.0	18.0
Tee, run (cast)	0.5	0.5	0.5	1.0	1.0	2.0	2.0	2.0
Tee, branch (cast)	2.0	3.0	5.0	7.0	9.0	12.0	16.0	20.0
Compression Stop	13.0	21.0	30.0	-	-	-	-	-
Globe valve	7.5	10.0	12.5	53.0	66.0	90.0	33	40
Gate valve	0.5	0.25	1.0	1.0	2.0	2.0	2.0	2.0

NOTE:

1. From "Copper Tube Handbook" by Copper Development Association, Inc.

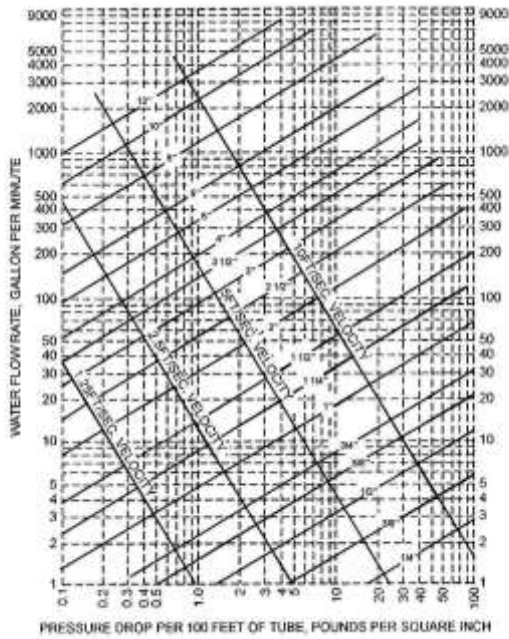

Figure 1805.A.1—Friction Loss in Smooth Pipe¹
(Type K, ASTM B88 Copper Tubing)

NOTE:

1. This chart applies to smooth new copper tubing with recessed (Streamline) soldered joints and to the actual sizes of types indicated on the diagram.

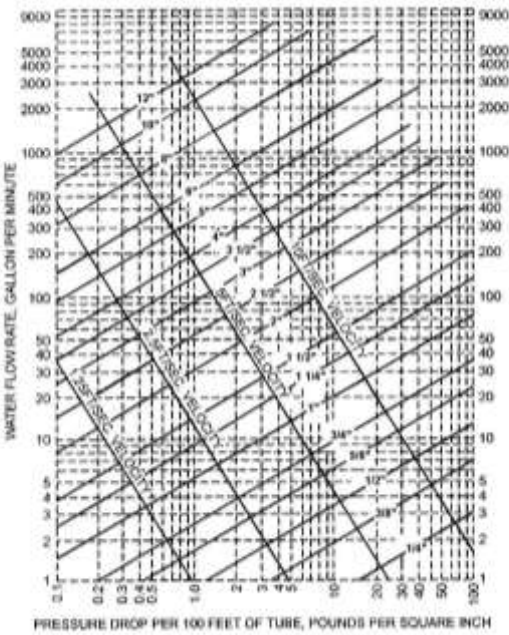

Figure 1805.A.2—Friction Loss in Smooth Pipe¹
(Type L, ASTM B88 Copper Tubing)

NOTE:

1. This chart applies to smooth new copper tubing with recessed (Streamline) soldered joints and to the actual sizes of types indicated on the diagram.

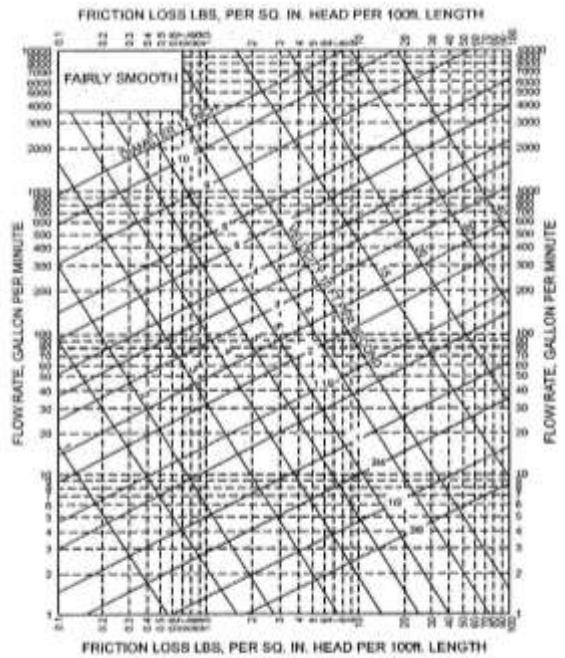

Figure 1805.B—Friction Loss in Fairly Smooth Pipe¹

NOTE:

1. This chart applies to new steel (fairly smooth) pipe and to actual diameters of standard-weight pipe.

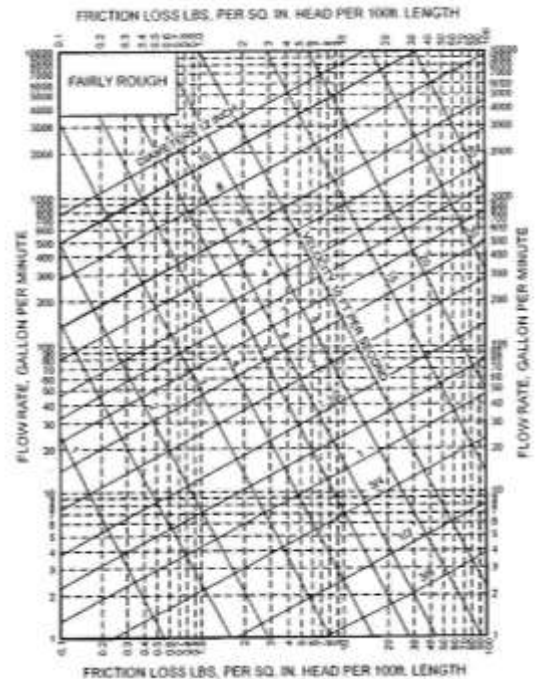
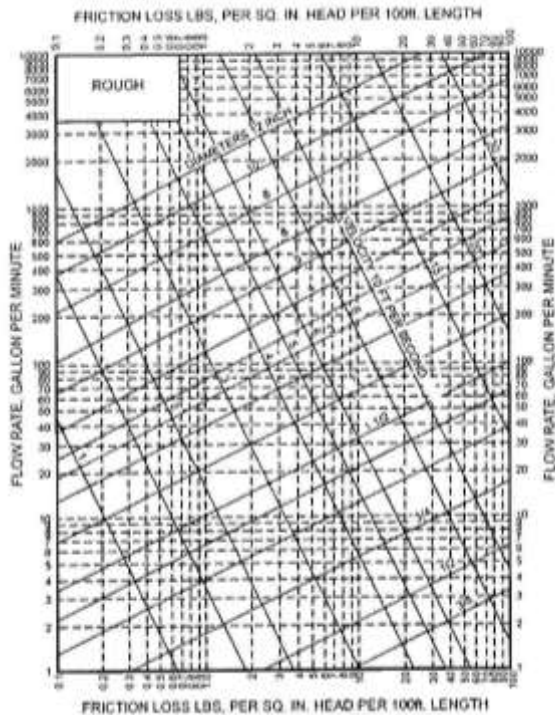

Figure 1805.C—Friction Loss in Fairly Rough Pipe¹

NOTE:

1. This chart applies to fairly rough pipe and to actual diameters which in general will be less than the actual diameters of the new pipe of the same kind.

Figure 1805.D—Friction Loss In Rough Pipe¹



NOTE:

1. This chart applies to very rough pipe and existing pipe and to their actual diameters.

AUTHORITY NOTE: Promulgated in accordance with R.S. 40:4(A)(7) and R.S. 40:5(2)(3)(7)(9)(16)(17)(20).

HISTORICAL NOTE: Promulgated by the Department of Health and Hospitals, Office of Public Health, LR 38:2900 (November 2012).

§1807. Appendix C—Illustrations
[formerly Appendix J—Illustrations]

A. The following figures have been included to aid in interpreting this code. The figures are not to be construed as superseding the written text, but merely to illustrate. The various methods indicated diagrammatically do not limit other configurations of design of plumbing, soil, waste and vent systems, water piping, accessories, etc., when in compliance with the written text. It is further suggested that the users of these illustrations refer to the appropriate Sections and standards regarding any of the figures to avoid misunderstanding.

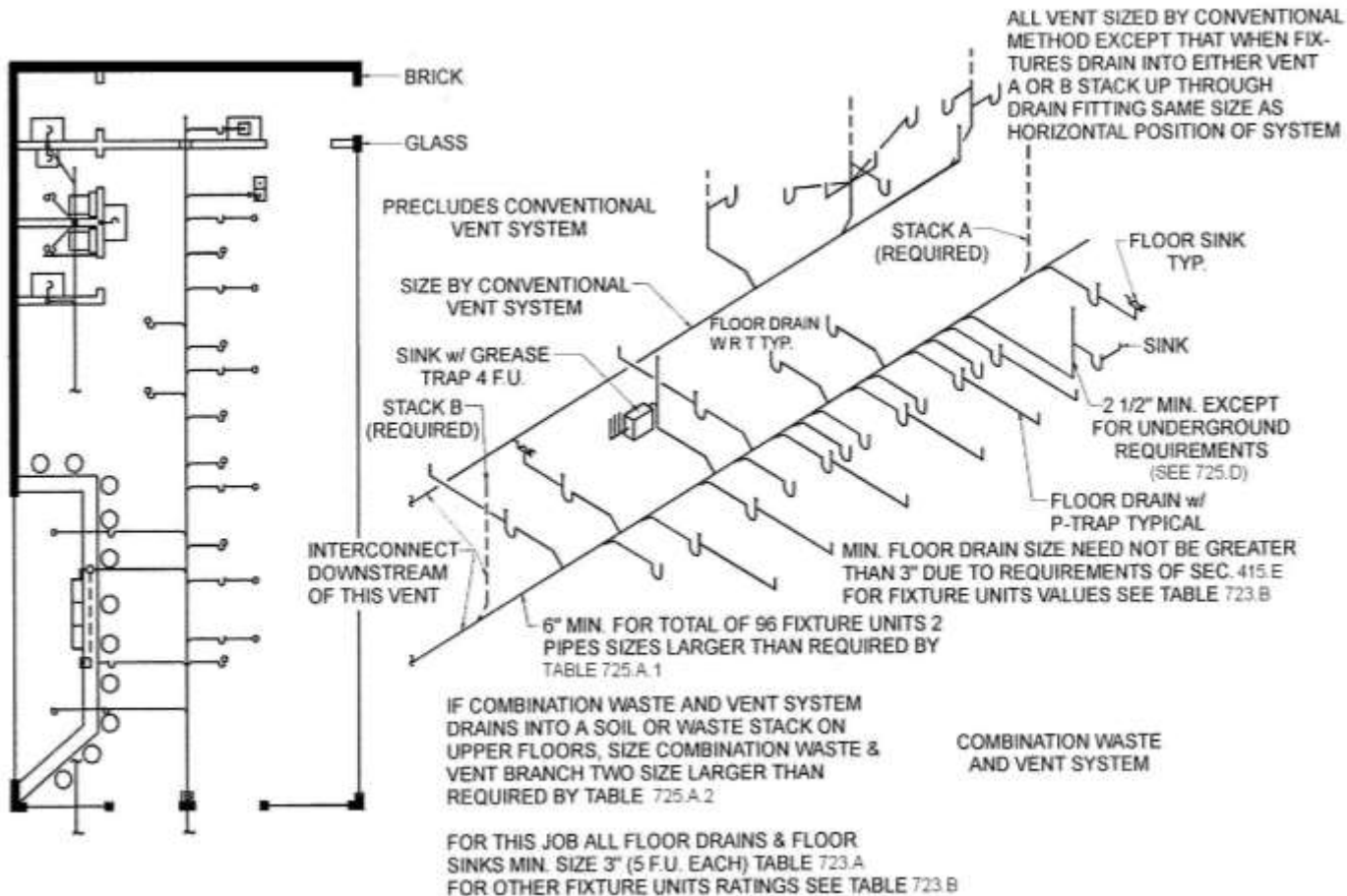

Figure 1—Combination Waste and Vent System

NOTE: A combination waste and vent system is considered an alternate designed plumbing system and requires special approval of the plans and specifications, etc., by the state health officer prior to construction. Refer to the provisions contained in Chapter 12 of this code for any alternate designed plumbing system.

EXAMPLES OF DISTANCES PERMITTED IN A COMBINATION WASTE AND VENT SYSTEM

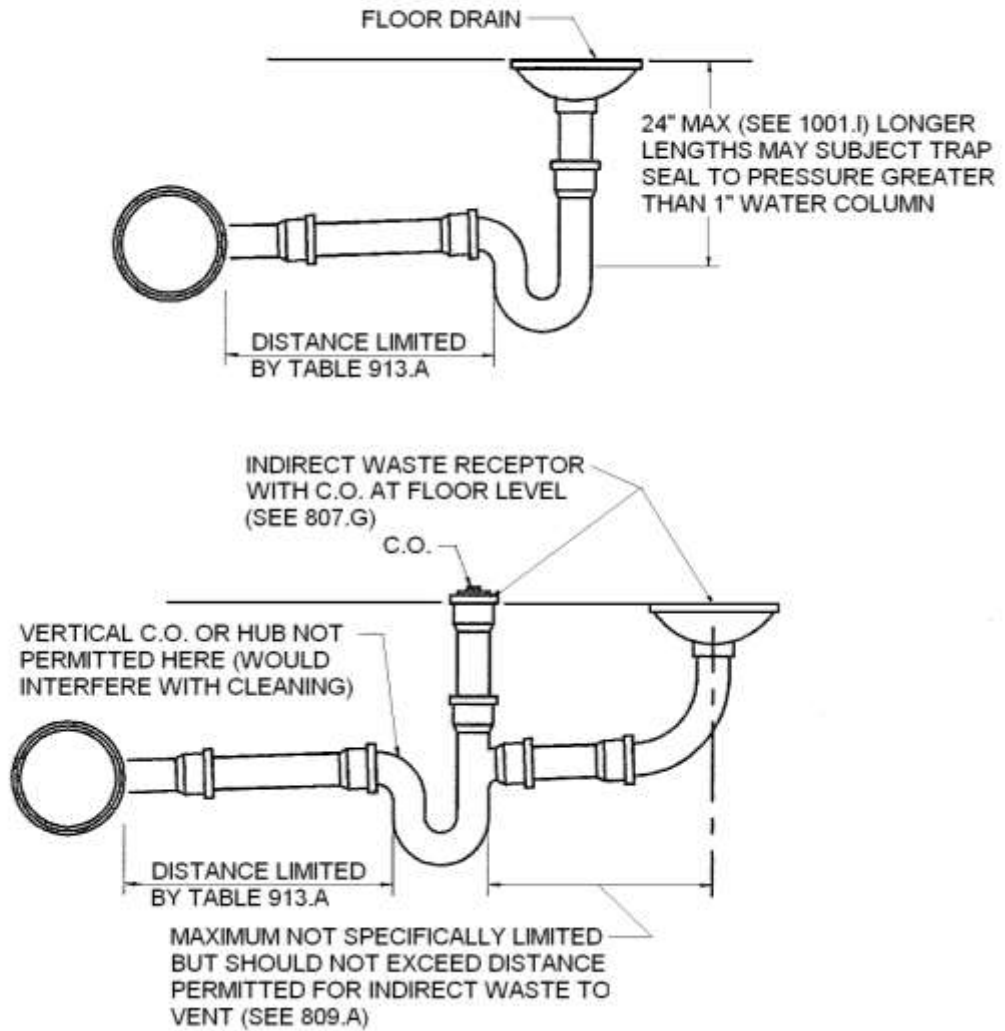

Figure 2—Distances Permitted in a Combination Waste and Vent System

NOTE: A combination waste and vent system is considered an alternate designed plumbing system and requires special approval of the plans and specifications, etc., by the state health officer prior to construction. Refer to the provisions contained in Chapter 12 of this code for any alternate designed plumbing system.

D

Figure 3—Bathtub and Chemical Mixing Tank Illustrations

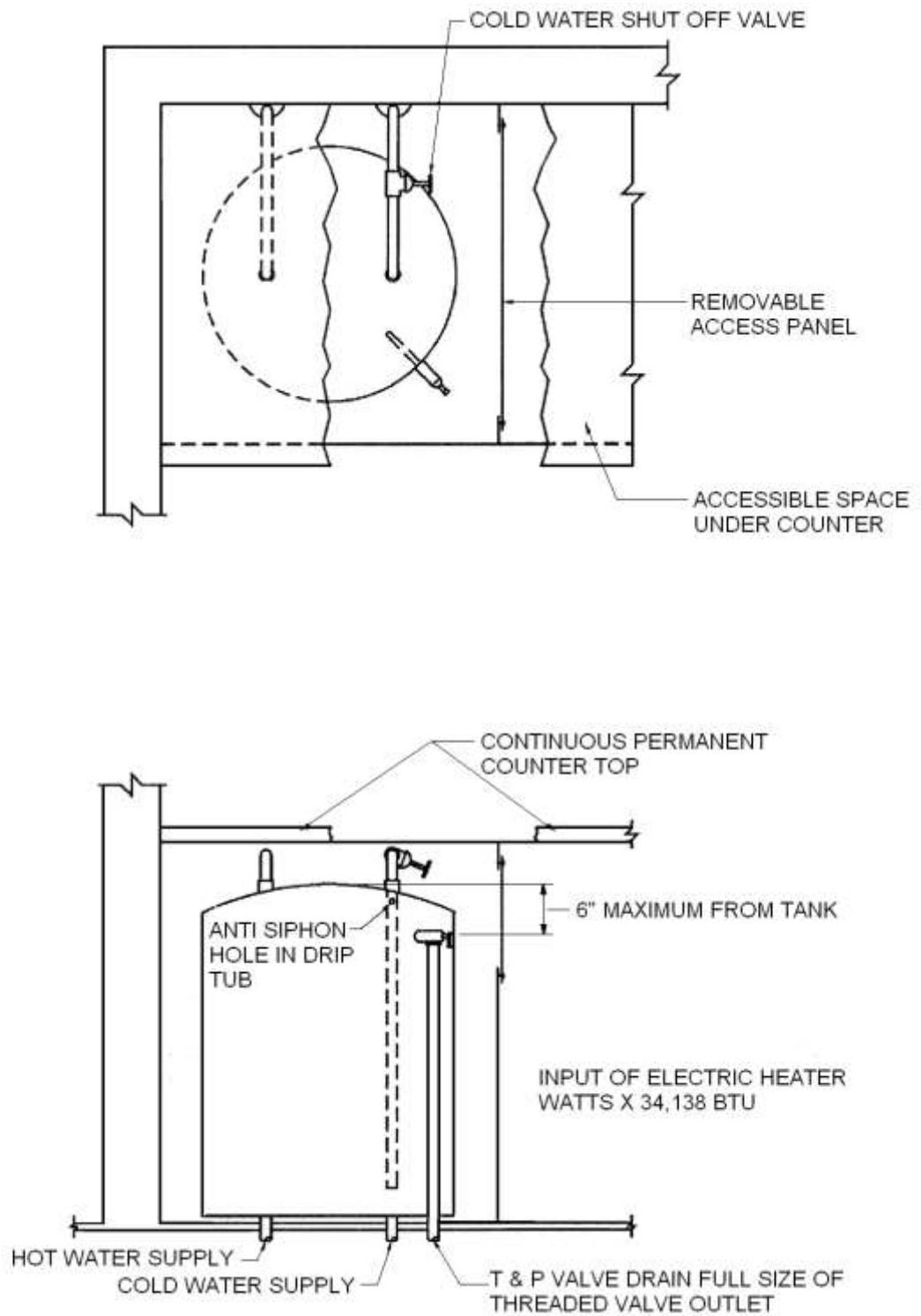

Figure 4—Access to Built-In Water Heater

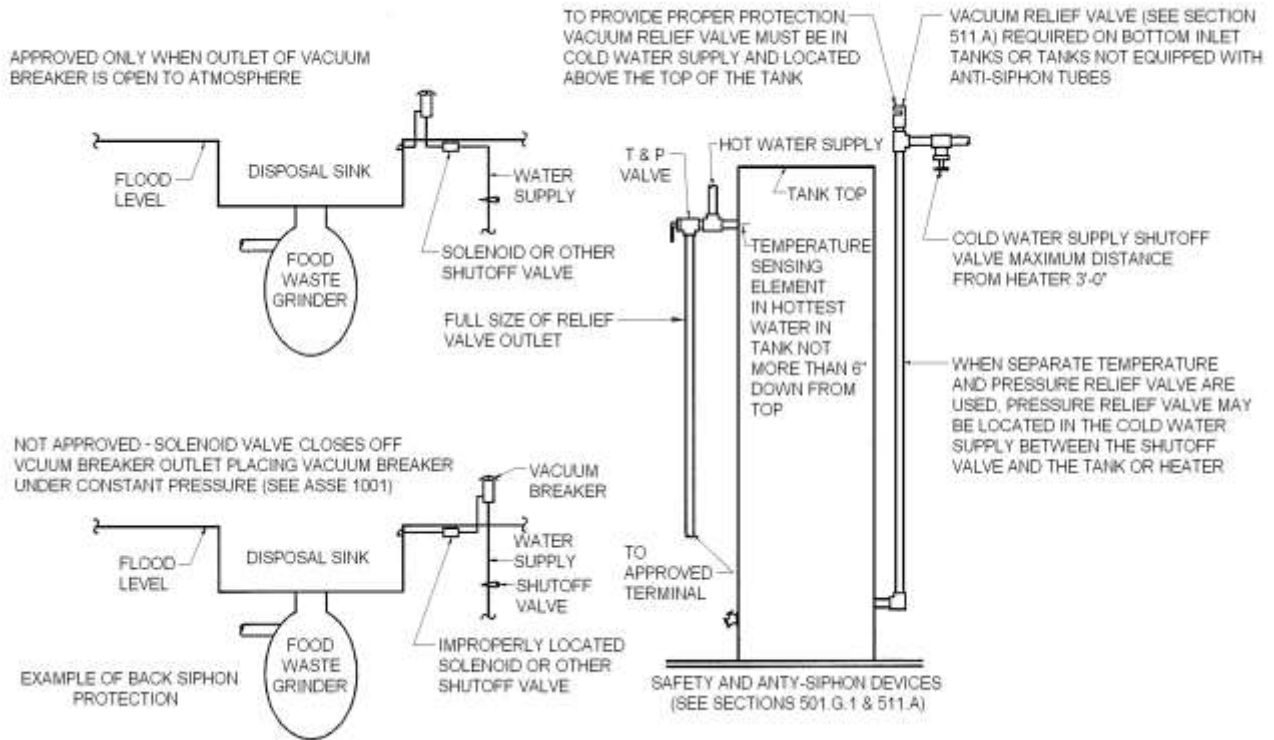
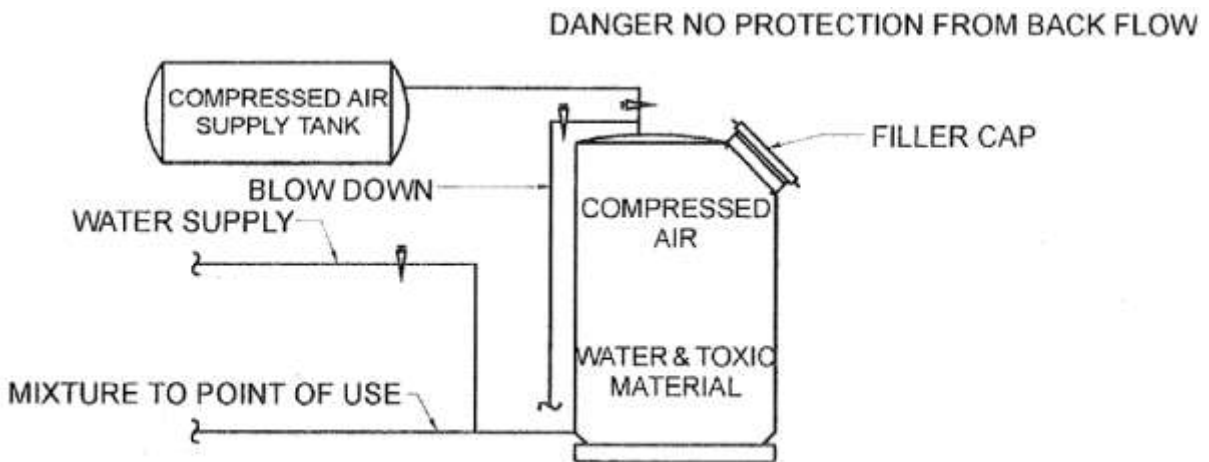

Figure 5—Examples of Back Siphon Backflow Protection



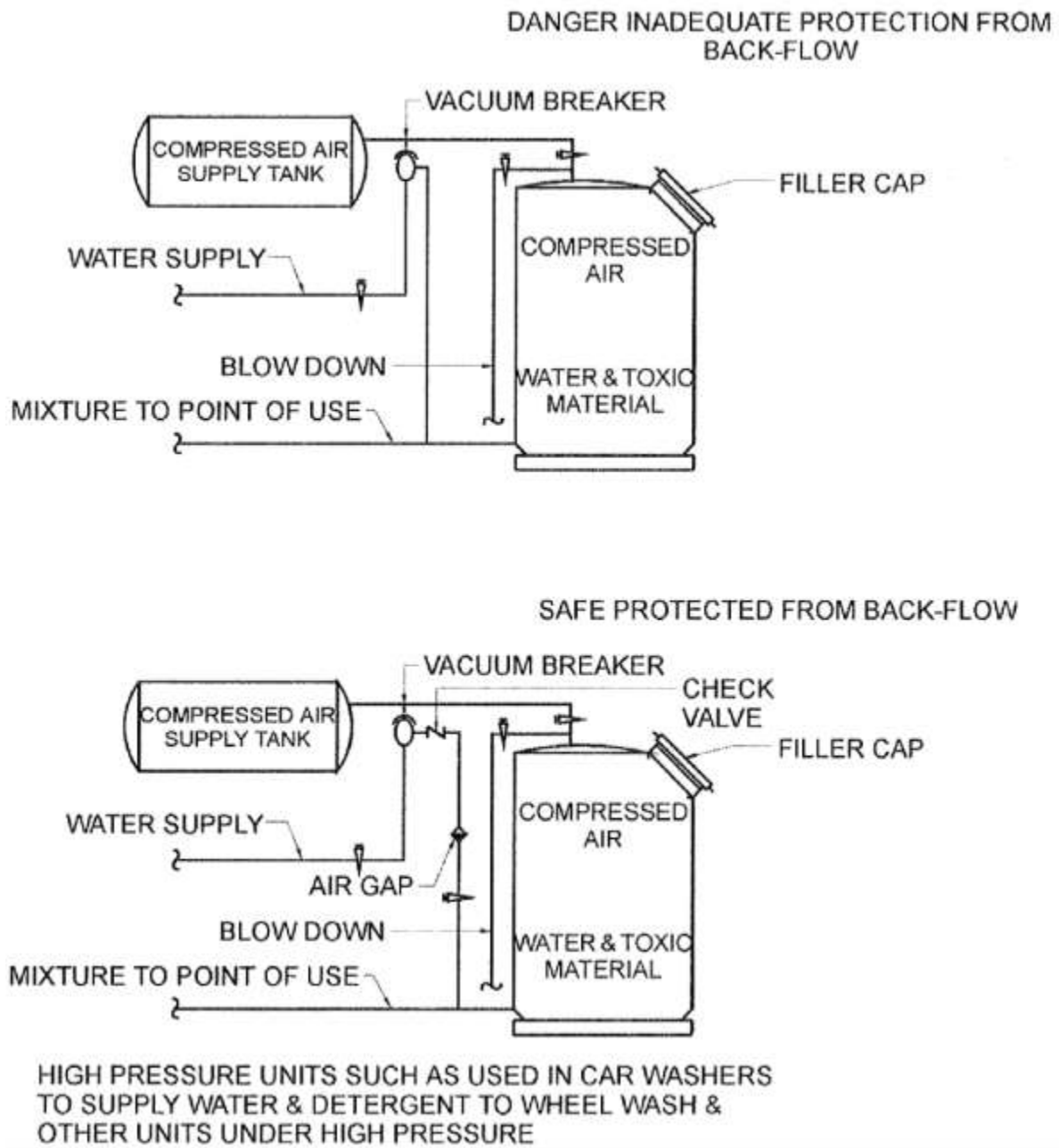

Figure 6—Examples of Proper and Improper Backflow Protection

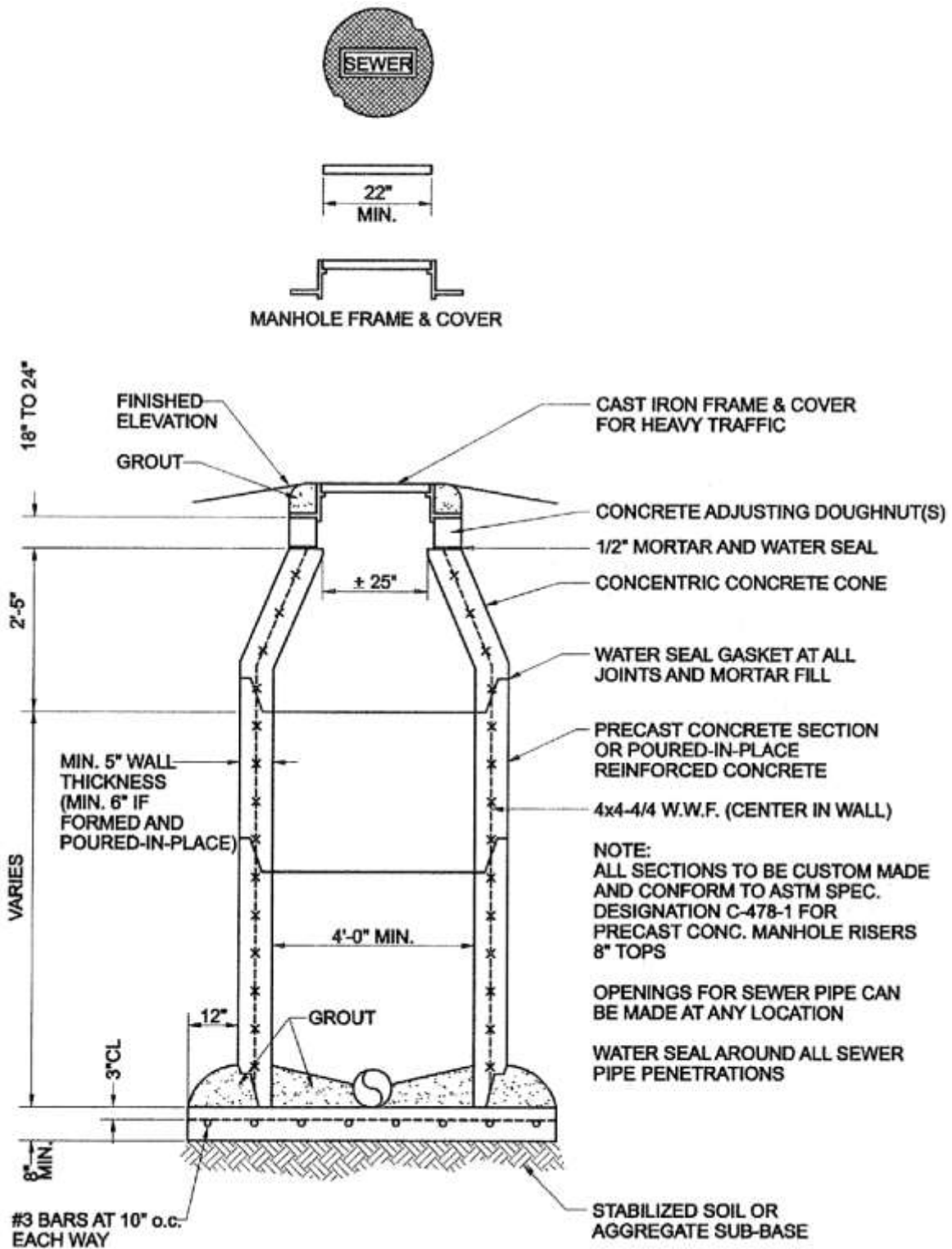

Figure 7—Typical Sewer Manhole

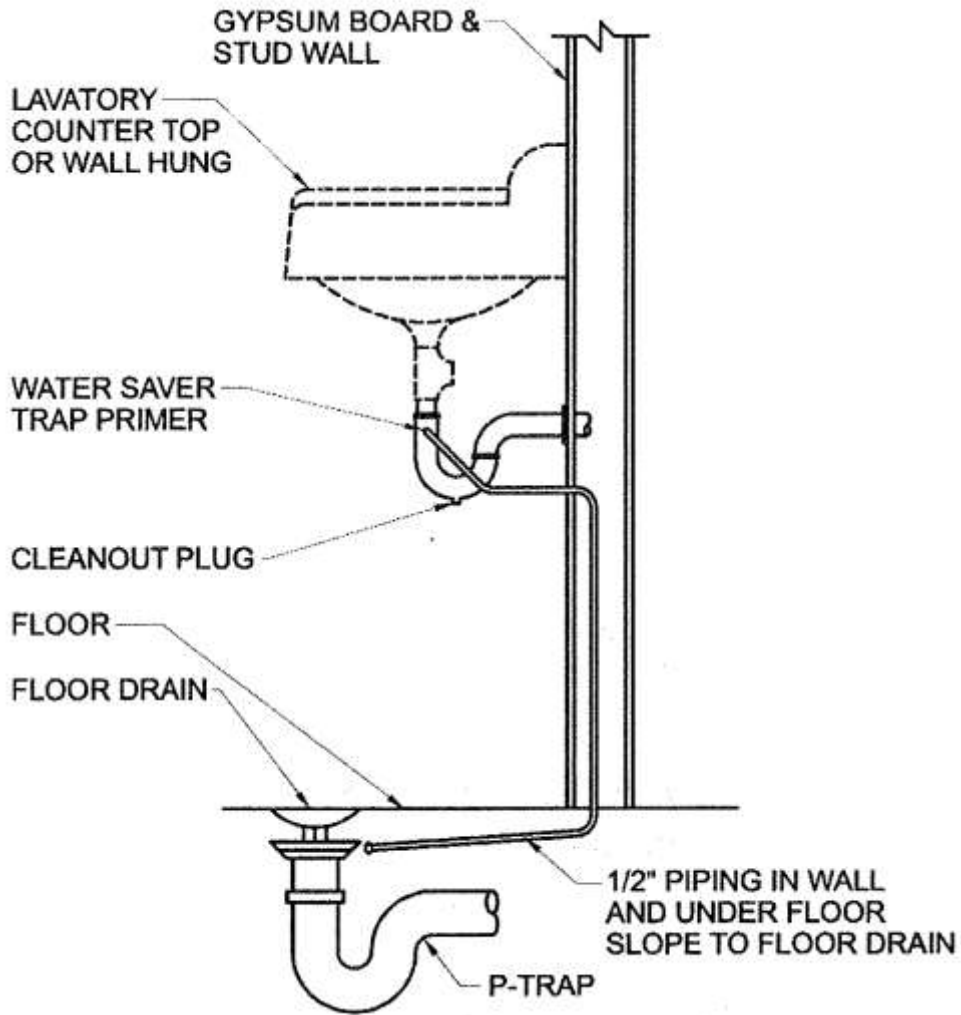

Figure 8—Floor Drain Trap Primer Detail

Alternate Grease Trap Sizing Formula								
Number of Meals Per Peak Hour ¹	x	Waste Flow Rate ²	x	Retention Time ³	x	Storage Factor ⁴	=	Intercept or Size (liquid Capacity)
1. Meals Served at Peak Hour								
2. Waste Flow Rate								
a. With dishwashing machine						6 gallon (22.7 L) flow		
b. Without dishwashing machine						5 gallon (18.9 L) flow		
c. Single service kitchen						2 gallon (7.6L) flow		
d. Food waste disposer						1 gallon (3.8L) flow		
3. Retention Times								
Commercial kitchen waste dishwasher						2.5 hours		
Single service kitchen single serving						1.5 hours		
4. Storage Factors								
Fully equipped commercial kitchen						8 hour operation: 1.0		
						16 hour operation: 2.0		
						24 hour operation: 3.0		
Single Service Kitchen						1.5		

Figure 9—Alternate Grease Trap Sizing Formula

Grease Trap Minimum Capacity WITHOUT Garbage Grinder					
Retail Food Usable Square Footage (ft ²) ¹	Institutions Estimated People or Meals Served ²	Grease Trap Size (gallons)	Retail Food Usable Square Footage (ft ²) ¹	Institutions Estimated People or Meals Served ²	Grease Trap Size (gallons)
Less than 1,001	Up to 50		125	10,401-10,600	
1,001-1,200	51-60	150	10,601-10,800	531-540	1,350
1,201-1,400	61-70	175	10,801-11,000	541-550	1,375
1,401-1,600	71-80	200	11,001-11,200	551-560	1,400
1,601-1,800	81-90	225	11,201-11,400	561-570	1,425
1,801-2,000	91-100	250	11,401-11,600	571-580	1,450
2,001-2,200	101-110	275	11,601-11,800	581-590	1,475
2,201-2,400	111-120	300	11,801-12,000	591-600	1,500
2,401-2,600	121-130	325	12,001-12,200	601-610	1,525
2,601-2,800	131-140	350	12,201-12,400	611-620	1,550
2,801-3,000	141-150	375	12,401-12,600	621-630	1,575
3,001-3,200	151-160	400	12,601-12,800	631-640	1,600
3,201-3,400	161-170	425	12,801-13,000	641-650	1,625
3,401-3,600	171-180	450	13,001-13,200	651-660	1,650
3,601-3,800	181-190	475	13,201-13,400	661-670	1,675
3,801-4,000	191-200	500	13,401-13,600	671-680	1,700
4,001-4,200	201-210	525	13,601-13,800	681-690	1,725
4,201-4,400	211-220	550	13,801-14,000	691-700	1,750
4,401-4,600	221-230	575	14,001-14,200	701-710	1,775
4,601-4,800	231-240	600	14,201-14,400	711-720	1,800
4,801-5,000	241-250	625	14,401-14,600	721-730	1,825
5,001-5,200	251-260	650	14,601-14,800	731-740	1,850
5,201-5,400	261-270	675	14,801-15,000	741-750	1,875
5,401-5,600	271-280	700	15,001-15,200	751-760	1,900
5,601-5,800	281-290	725	15,201-15,400	761-770	1,925
5,801-6,000	291-300	750	15,401-15,600	771-780	1,950
6,001-6,200	301-310	775	15,601-15,800	781-790	1,975
6,201-6,400	311-320	800	15,801-16,000	791-800	2,000
6,401-6,600	321-330	825	16,001-16,200	801-810	2,025
6,601-6,800	331-340	850	16,201-16,400	811-820	2,050
6,801-7,000	341-350	875	16,401-16,600	821-830	2,075
7,001-7,200	351-360	900	16,601-16,800	831-840	2,100
7,201-7,400	361-370	925	16,801-17,000	841-850	2,125
7,401-7,600	371-380	950	17,001-17,200	851-860	2,150
7,601-7,800	381-390	975	17,201-17,400	861-870	2,175
7,801-8,000	391-400	1,000	17,401-17,600	871-880	2,200
8,001-8,200	401-410	1,025	17,601-17,800	881-890	2,225
8,201-8,400	411-420	1,050	17,801-18,000	891-900	2,250
8,401-8,600	421-430	1,075	18,001-18,200	901-910	2,275
8,601-8,800	431-440	1,100	18,201-18,400	911-920	2,300
8,801-9,000	441-450	1,125	18,401-18,600	921-930	2,325
9,001-9,200	451-460	1,150	18,601-18,800	931-940	2,350
9,201-9,400	461-470	1,175	18,801-19,000	941-950	2,375
9,401-9,600	471-480	1,200	19,001-19,200	951-960	2,400
9,601-9,800	481-490	1,225	19,201-19,400	961-970	2,425
9,801-10,000	491-500	1,250	19,401-19,600	971-980	2,450
10,001-10,200	501-510	1,275	19,601-19,800	981-990	2,475
10,201-10,400	511-520	1,300	19,801-20,000	991-1,000	2,500

¹ Retail establishments expected to serve more meals than estimated by usable sq ft shall install the larger size grease trap.

² Estimated # of people or meals served is the # of persons or meals served during the largest meal period.

Figure 10—Grease Trap Sizing Chart (Without Garbage Grinder)

Grease Trap Minimum Capacity WITH Garbage Grinder					
Retail Food Usable Square Footage (ft ²) ¹	Institutions Estimated People or Meals Served ²	Grease Trap Size (gallons)	Retail Food Usable Square Footage (ft ²) ¹	Institutions Estimated People or Meals Served ²	Grease Trap Size (gallons)
Less than 1,001	Up to 50		500	10,401-10,600	
1,001-1,200	51-60	525	10,601-10,800	531-540	1,725
1,201-1,400	61-70	550	10,801-11,000	541-550	1,750
1,401-1,600	71-80	575	11,001-11,200	551-560	1,775
1,601-1,800	81-90	600	11,201-11,400	561-570	1,800
1,801-2,000	91-100	625	11,401-11,600	571-580	1,825

PUBLIC HEALTH—SANITARY CODE

Grease Trap Minimum Capacity WITH Garbage Grinder					
Retail Food Usable Square Footage (ft ²) ¹	Institutions Estimated People or Meals Served ²	Grease Trap Size (gallons)	Retail Food Usable Square Footage (ft ²) ¹	Institutions Estimated People or Meals Served ²	Grease Trap Size (gallons)
2,001-2,200	101-110		650	11,601-11,800	
2,201-2,400	111-120	675	11,801-12,000	591-600	1,875
2,401-2,600	121-130	700	12,001-12,200	601-610	1,900
2,601-2,800	131-140	725	12,201-12,400	611-620	1,925
2,801-3,000	141-150	750	12,401-12,600	621-630	1,950
3,001-3,200	151-160	775	12,601-12,800	631-640	1,975
3,201-3,400	161-170	800	12,801-13,000	641-650	2,000
3,401-3,600	171-180	825	13,001-13,200	651-660	2,025
3,601-3,800	181-190	850	13,201-13,400	661-670	2,050
3,801-4,000	191-200	875	13,401-13,600	671-680	2,075
4,001-4,200	201-210	900	13,601-13,800	681-690	2,100
4,201-4,400	211-220	925	13,801-14,000	691-700	2,125
4,401-4,600	221-230	950	14,001-14,200	701-710	2,150
4,601-4,800	231-240	975	14,201-14,400	711-720	2,175
4,801-5,000	241-250	1,000	14,401-14,600	721-730	2,200
5,001-5,200	251-260	1,025	14,601-14,800	731-740	2,225
5,201-5,400	261-270	1,050	14,801-15,000	741-750	2,250
5,401-5,600	271-280	1,075	15,001-15,200	751-760	2,275
5,601-5,800	281-290	1,100	15,201-15,400	761-770	2,300
5,801-6,000	291-300	1,125	15,401-15,600	771-780	2,325
6,001-6,200	301-310	1,150	15,601-15,800	781-790	2,350
6,201-6,400	311-320	1,175	15,801-16,000	791-800	2,375
6,401-6,600	321-330	1,200	16,001-16,200	801-810	2,400
6,601-6,800	331-340	1,225	16,201-16,400	811-820	2,425
6,801-7,000	341-350	1,250	16,401-16,600	821-830	2,450
7,001-7,200	351-360	1,275	16,601-16,800	831-840	2,475
7,201-7,400	361-370	1,300	16,801-17,000	841-850	2,500
7,401-7,600	371-380	1,325	17,001-17,200	851-860	2,525
7,601-7,800	381-390	1,350	17,201-17,400	861-870	2,550
7,801-8,000	391-400	1,375	17,401-17,600	871-880	2,575
8,001-8,200	401-410	1,400	17,601-17,800	881-890	2,600
8,201-8,400	411-420	1,425	17,801-18,000	891-900	2,625
8,401-8,600	421-430	1,450	18,001-18,200	901-910	2,650
8,601-8,800	431-440	1,475	18,201-18,400	911-920	2,675
8,801-9,000	441-450	1,500	18,401-18,600	921-930	2,700
9,001-9,200	451-460	1,525	18,601-18,800	931-940	2,725
9,201-9,400	461-470	1,550	18,801-19,000	941-950	2,750
9,401-9,600	471-480	1,575	19,001-19,200	951-960	2,775
9,601-9,800	481-490	1,600	19,201-19,400	961-970	2,800
9,801-10,000	491-500	1,625	19,401-19,600	971-980	2,825
10,001-10,200	501-510	1,650	19,601-19,800	981-990	2,850
10,201-10,400	511-520	1,675	19,801-20,000	991-1,000	2,875

- 1 Retail establishments expected to serve more meals than estimated by usable sq ft shall install the larger size grease trap.
- 2 Estimated # of people or meals served is the # of persons or meals served during the largest meal period.

Figure 11—Grease Trap Sizing Chart (With Garbage Grinder)

AUTHORITY NOTE: Promulgated in accordance with R.S. 40:4(A)(7) and R.S. 40:5(2)(3)(7)(9)(16)(17)(20).

HISTORICAL NOTE: Promulgated by the Department of Health and Hospitals, Office of Public Health, LR 38:2907 (November 2012).

§1809. Appendix D—Vacuum Drainage Systems [formerly Appendix K—Vacuum Drainage Systems]

A. System. A vacuum drainage system shall comply with the following.

1. General. Since a vacuum drainage system is considered an alternate designed plumbing system, the

requirements of Chapter 12 of this code shall apply and such systems shall be considered on an individual basis.

2. System Design. Vacuum drainage systems shall be designed in accordance with manufacturer's specifications. The system arrangement, including piping, tank assemblies, vacuum pump assembly and other components necessary for proper function of the system shall be in accordance with manufacturer's specifications. In general, vacuum drainage systems may be considered for approval by the state health officer for use on handling island display refrigerator/freezer condensate wastes in grocery stores. Such wastes from display refrigerators/freezers handling meat or dairy products or other products containing fats, grease or oils shall discharge, in an approved manner, through an approved

grease trap prior to discharge into the sanitary sewer system. Also, any food items stored below any portion of a vacuum drainage system (for example, in-the-ceiling vacuum waste piping located above food shelves or food preparation areas) shall be protected from potential contamination by adequate shielding to intercept any potential drips (in accord with LAC 51:XXIII.1503.A.6). Vacuum drainage systems for liquid wastes from other types of plumbing fixtures, such as sinks, water closets, etc., are discouraged. A standby emergency generator, permanently wired to automatically operate the vacuum pump motor upon lost of the normal power source, should be installed to ensure continuous operation of a vacuum drainage system.

3. Plans and specifications. Plans and specifications for such systems shall be designed by a Louisiana Registered Professional Engineer registered in either civil or mechanical engineering and submitted to the state health officer for review and approval prior to installation.

B. Fixtures. Gravity type fixtures used in vacuum drainage systems shall comply with Chapter 4 of this code.

C. Drainage Fixture Units. The drainage fixture load of gravity drainage systems which discharge into or receive discharge from vacuum drainage systems shall be based upon values in Chapter 7 of this code.

D. Water Supply Fixture Units. Water supply fixture load shall be based upon values in Table 1805.B of this code. The load requirement of a vacuum type water closet shall be determined per manufacturer's specifications.

E. Traps and Cleanouts. Gravity type fixtures shall be provided with traps and cleanouts in accordance with Chapters 7 and 10 of this code.

F. Materials. Vacuum drainage pipe, fitting and valve materials shall be as specified by the vacuum drainage system manufacturer and as listed in this Part.

G. Tests and Demonstrations. After completion of the entire system installation, the system shall be subjected to a vacuum test of 19 inches of mercury (64 kPa) and shall be operated to function as required by the state health officer and/or the local plumbing official and the manufacturer. Tests shall be witnessed by the state health officer and/or the local plumbing official. The results of such tests shall be submitted to the state health officer and the local plumbing official.

H. Written Instructions. Written instructions for the operations, maintenance, safety and emergency procedures shall be provided to the building owner and shall be available for inspection by the state health officer and the local plumbing official at any time.

AUTHORITY NOTE: Promulgated in accordance with R.S. 40:4(A)(7) and R.S. 40:5(2)(3)(7)(9)(16)(17)(20).

HISTORICAL NOTE: Promulgated by the Department of Health and Hospitals, Office of Public Health, AUTHORITY NOTE: Promulgated in accordance with R.S. 40:4(A)(7) and R.S. 40:5(2)(3)(7)(9)(16)(17)(20).

HISTORICAL NOTE: Promulgated by the Department of Health and Hospitals, Office of Public Health, LR 38:2917 (November 2012).

§1811. Appendix E—Alternate Designed Plumbing Systems
[formerly Appendix L—Alternate Designed Plumbing Systems]

A. General. Pursuant to the requirements of Chapter 12 of this code, the approval of alternate designed plumbing systems shall be considered on an individual basis.

1. Scope. The provisions of this appendix shall assist in governing the materials, design and installation of non-prescriptive plumbing systems, also known as alternate designed plumbing systems. In accord with the requirements of Chapter 12 of this code, any one of the systems mentioned in this appendix shall be designed by a Louisiana registered professional engineer registered in either civil or mechanical engineering. Any alternate designed plumbing system shall not be installed until the plans and specifications have been reviewed and approved by the state health officer, pursuant to the requirements of Chapter 12 of this code.

2. General System Provisions. Discharge pipe systems shall comprise the minimum of pipe work necessary to carry away the foul water from the building quickly and quietly, with freedom from nuisance or risk of injury to health.

B. Definitions

Discharge Pipe—a pipe which conveys the discharges from *plumbing fixtures* or appliances.

Discharge Unit—a unit so chosen that the relative load-producing effect of *plumbing fixtures* can be expressed as multiples of that unit. The *discharge unit* rating of a *fixture* depends on its rate and duration of discharge and on the interval between discharges. It is not a simple multiple of a rate of flow and is a different method of assessment than the *fixture unit* applicable to other Chapters of this Part and the two (*fixture unit* and *discharge unit*) cannot be interchanged.

Fixture Tail Piece or Connection—see definition under §203 of this code.

Ventilating Pipe—a pipe provided to facilitate the circulation of air within the system and to protect *trap seals* from excessive pressure fluctuation.

C. Combination Waste and Vent System. A combination waste and vent system is an alternate designed plumbing system; thus, the requirements of Chapter 12 of this code apply to any combination waste and vent system. Combination waste and vent systems shall conform with the following.

1. Approval. Plans and specifications for each combination waste and vent system shall be submitted to the state health officer for review and approval. Written approval of such plans and specifications shall be obtained before any installation is started.

2. Limits. The following limits shall be applied to any combination waste and vent system.

a. A combination waste and vent system is limited to dishwashers, floor sinks, indirect waste receptors, floor drains or similar fixtures which waste at or below floor level and where the fixtures are not adjacent to walls or partitions thus making it impractical to provide conventional venting. It consists of the installation of waste piping in which the trap of the fixture is not individually vented.

b. Caution must be exercised to exclude appurtenances delivering large quantities of water or sewage such as pumps, etc., in a combination waste and vent system in order that adequate venting will be maintained. Water closets, clinical sinks, and urinals shall not waste into a combination waste and vent system. Sinks, lavatories, etc., that waste above floor level should not be allowed to waste into a combination waste and vent system.

3. Dishwashers. Dishwashers, three-compartment sinks and other scullery sinks in commercial buildings shall drain through a grease interceptor sized in accordance with this code and they shall only then be allowed to discharge into the combination waste and vent system via a floor sink through an air gap (drainage system) or air break (drainage system). The purpose of this requirement is to keep grease out of the combination waste and vent system since such a system is not self-scouring due to the over-sized piping required.

4. General Design. The general design elements of a combination waste and vent system shall be as follows.

a. Every waste pipe and trap in this system shall be at least two pipe sizes larger than the conventional plumbing size required in Chapter 7 of this code, and at least two pipe sizes larger than any fixture tail piece or connection. In addition, the fixture tail piece or connection itself shall remain normal size in order to limit the rate of flow and amount of wastewater allowed to enter the horizontal combination waste and vent waste pipe. In order to maintain a continuous vent space above the liquid waste within the horizontal waste pipe, all fixtures shall waste into the horizontal combination waste and vent waste pipe from the horizontal only. The fixture drain length to the horizontal combination waste and vent waste pipe shall be limited by Table 913.A of this code. Floor sinks shall be connected through a running trap two pipe sizes larger than the sink outlet. A vertical cleanout extension shall be provided on the top of the inlet side of the running trap and shall be accessible at floor level for rodding out the trap and fixture drain. Floor sink and waste piping from the floor sink to the trap shall be sized for the total fixture units draining thereto, based on Table 723.B of this code, but in no case shall the line be less than 2-inch (51 mm) waste pipe when piping is underground. In addition, the length of such piping should not exceed the distance permitted for indirect waste to vent (see §809.A.2, and Figure 2 in Section 1807 of this code).

b. A vent shall be provided at the upstream end of each branch, washed over or under by the last fixture on the branch. No vent shall take off from the horizontal waste

branch at an angle of less than 45 degrees (0.785 rad) from the horizontal unless washed by a fixture. A vent shall be located at all points where branches intersect. A vent shall be located downstream from all fixtures in the system, in addition to the upstream vent, separating the combination waste and vent system from all other systems in the building. All vents in a combination waste and vent system shall be provided with an accessible above-grade^(g) cleanout. Line cleanouts for horizontal waste piping shall be provided as required in Chapter 7 of this code. Drainage fixture pattern fittings shall be provided for all vent piping below the level of 6 inches (152 mm) above the flood-level rim of the highest fixture connection. No fixtures other than those permitted in §1811.C.2 of this code shall discharge into any branch or portion of this system. See Figures 6 and 7 in Section 1807 of this code.

c. Caution shall be used in the design of the system to assure that the vertical distance from fixture or drain outlet to trap weir does not exceed 24 inches (610 mm). Long runs shall be provided with additional relief vents located at intervals of not more than 100 ft (30.5 m) to equalize pressure in the system.

5. Size of Vents. The size of vents shall be in accordance with requirements of §937.B and Table 937.B of this code, but the internal cross-sectional area of the vent shall be not less than one-half of the internal cross-sectional area of the waste pipe served (normally, measured in square inches), except that the vents shall be the same size as the waste branch to a point at least 6 inches (152 mm) above the flood-level rim of the highest fixture connected before reduction, in accordance with Table 937.B of this code.

6. Receptor Drain Size. Indirect waste receptors shall be sized for the fixture units draining thereto, regardless of other requirements of this code.

D. Single Stack Discharge and Ventilating Systems

1. Approval. The purpose of this Subsection is to make provisions for the design and installation of a single stack discharge and ventilating plumbing system which is not otherwise allowed in this code. In accord with Chapter 12 of this code, the plumbing official shall require that the owner submit necessary plans and specifications to the state health officer by a Louisiana Registered Professional Engineer registered in either civil or mechanical engineering.

2. Tests. The single stack discharge and ventilating system shall be tested in accordance with §1205.C of this code.

3. General. The following general provisions are applicable to single stack discharge and ventilating systems.

a. Trap Function. To prevent exchange of air between the discharge pipe system and the inside of the building, a trap having an adequate water seal shall be provided for each fixture (see §1811.D.4 of this code). The discharge piping system shall be so designed as to retain adequate water seals in all traps under normal pressure fluctuations caused by discharge from fixtures (see §1205.C

of this code). For design purposes, the effects of the flow of water in the branch connecting the fixture to the stack, and the flow of water down the stack, shall be considered separately. See §§1811.D.3.b and 1811.D.3.c of this code below.

b. Seal Loss (Branch Effect). Seal losses produced by flow in a branch depend on the following:

i. the design of the fixture (funnel shaped fixtures increase the chance of self-siphonage); and,

ii. the length and fall (slope or gradient) and the diameter of the pipe.

(a). Branch effects are not affected by the height of the building and they can therefore be controlled by limiting the length and the fall of the branch.

c. Seal Loss (Stack Effect). Seal losses produced by flow down the stack depend on the following:

i. the flow load (which depends on the number of fixtures connected to the stack and the frequency with which they are used);

ii. the diameter of the stack; and,

iii. the height of the stack.

(a). Excessive seal losses can be prevented by choosing a size of stack appropriate to the height of the building and to the number of fixtures connected to it.

d. Fixture Layout. Where the layout of fixtures is suitable, careful design and installation can lead to considerable economies in pipework by eliminating the need for separate ventilating pipes (see §1811.D.6 of this code). Where these requirements cannot be followed, traps shall be ventilated by pipes of adequate size as described in §1811.D.7 of this code.

e. System Design. Consideration shall be given in design to the following points which, in addition to being good general practice, will also obviate trouble from the foaming of detergents.

i. Where practicable, all fixtures shall be connected to one main stack which is at least 4 inches in diameter except for one story buildings where a 3-inch stack may be satisfactory (see §1811.D.6 and Table 1811.D.5.5B of this code).

ii. Where sinks are connected to a separate stack, the stack shall be larger than normal (a minimum of 4- inch diameter for buildings over five stories) and connected directly to the building drain.

iii. For over two sinks, stacks shall be (when one sink is over another on separate floor levels) a minimum of 2 1/2-inch diameter.

iv. The interconnection of stacks is not permitted except when fixtures below such interconnection are vented as required elsewhere in this code.

v. For buildings more than five stories high, ground floor fixtures shall be connected separately to the building

drain, and vented back into the main discharge stack above the fixtures on the floor above, or the vent shall be connected with a main ventilating stack when such stack is required by Table 1811.D.6C of this code.

vi. Bends and offsets in vertical stacks are prohibited.

f. Jointing and Support. The selection of materials, their jointing and support shall be in consideration of the effects of possible settlement, thermal movement, and corrosion (see §1811.D.9 of this code). Some materials may require protection against mechanical damage.

g. Access. There shall be adequate provision for access to pipework, and the embedding of joints in the structure shall be avoided (see §§1811.D.8 and 1811.D.10 of this code).

4. Traps. Traps shall meet the following requirements.

a. General. The entry of foul air from the drainage system into the building is prevented by the installation of suitable traps which are of self-cleansing design. A trap which is not an integral part of a fixture shall be attached to and immediately beneath the fixture outlet and the bore of the trap shall be smooth and uniform throughout.

b. Diameters. The internal diameters of traps shall be not less than those given in Table 1811.D.4 of this code.

Table 1811.D.4 Minimum Internal Diameters of Traps	
Type of Domestic Appliance	Min. Internal Diameter (in.)
Lavatory	1 1/4
Sink	1 1/2
Bathtub	1 1/2 or 2 ¹
Shower	2
Wash tub	1 1/2
Kitchen waste disposal unit (tubular trap is essential)	1 1/2

NOTE:

1. See Figures 1811.D.5.4A, 1811.D.5.4B, and Table 1811.D.5.5A of this code.

c. Depth of Seals. Traps of water closets shall have a minimum water seal of 2 inches (51 mm); traps of other fixtures shall have a minimum water seal of 3 inches (76 mm) for pipes up to and including 2 inches in diameter and 2-inch minimum water seal for pipes over 2 inches in diameter.

5. Discharge Pipes. Discharge pipes shall meet the following requirements.

a. Diameters. The internal diameter of a horizontal discharge pipe (fixture drain) shall normally be that of the trap to which it is attached, and in no case less, except that no fixture drain shall be less than 1 1/2-inch diameter.

b. Branch Gradients. The fall or slope of discharge pipes shall be adequate to drain the pipe efficiently and in no case less than shown in Table 1811.D.5.5C of this code (see §1811.D.5.e of this code).

PUBLIC HEALTH—SANITARY CODE

c. Bends, Branches and Offsets. All bends, branches and offsets shall be of easy radius and there shall be no restriction in the bore of the pipe.

d. Prevention of Cross Flow. To prevent water closet discharge from backing up a bath waste line, the latter shall be connected to the stack with its center line either at, above, or at least 8 inches (203 mm) below the center line of the water closet branch (see Figure 1811.D.5.4A of this code). Where this cannot be achieved, a parallel branch may be used (see Figure 1811.D.5.4B of this code). Alternatively, the level of the water closet branch connection may be modified as above by dotted lines in Figure 1811.D.5.4B of this code.

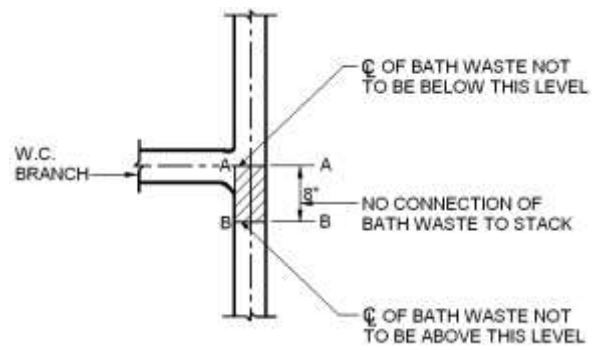
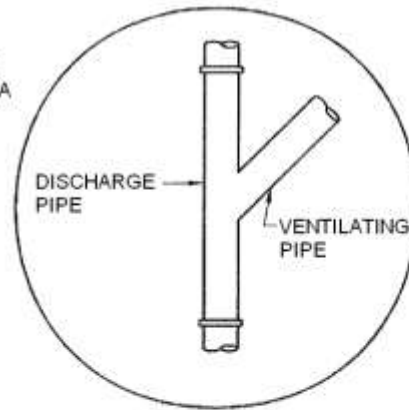
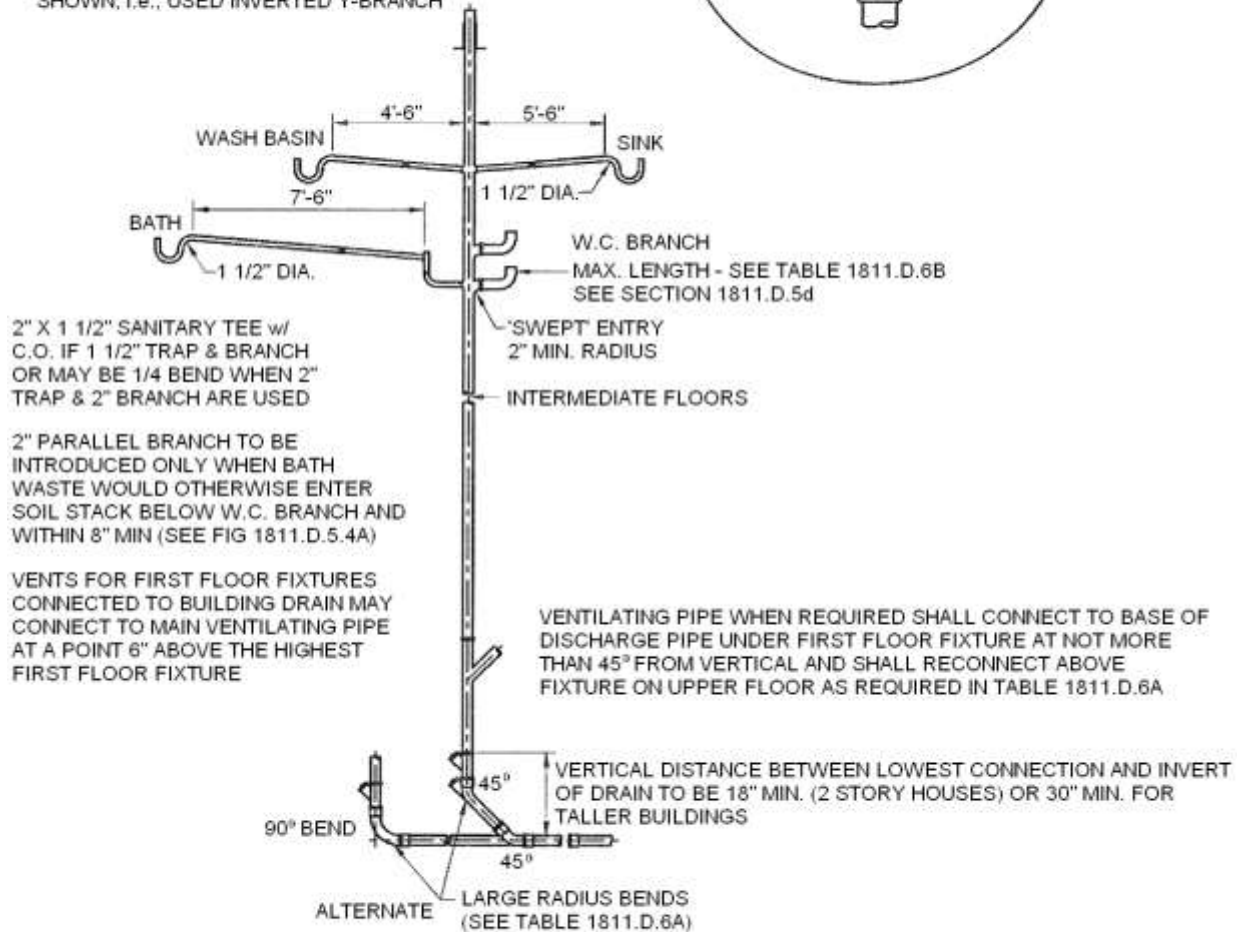

Figure 1811.D.5.4A

VENTILATION PIPES CONNECTING TO THE DISCHARGE STACK AT INTERMEDIATE LEVELS SHALL CONNECT IN A DOWNWARD DIRECTION 45° FROM THE VERTICAL



ON TOP FLOOR ONLY ABOVE HIGHEST FIXTURE BRANCH VENT FITTING TO BE REVERSE OF THAT SHOWN, i.e., USED INVERTED Y-BRANCH



1. FOR DEPTH OF TRAP SEALS SEE SECTION 1811.D.4
2. NO OFFSETS ARE PERMITTED BELOW THE CONNECTION OF THE TOPMOST FITTING OF THE STACK.
3. FALL OF BRANCH DISCHARGE PIPE VARIES WITH LENGTH.

Figure 1811.D.5.4B

e. Pipe Capacities. Discharge unit values for plumbing fixtures are given in Table 1811.D.5.5A of this code. For other fixtures the discharge unit value shall be taken as that given in Table 1811.D.5.5A of this code for a fixture with the same diameter trap with a comparable use interval. Where other use intervals are expected, the appropriate discharge unit value may be determined since the values given in Table 1811.D.5.5A of this code show that the discharge unit value is inversely proportional to the use interval, i.e., if the use interval is doubled, then the discharge unit value is halved. The discharge unit values of all fixtures contributing to flow in a pipe shall be added and the appropriate pipe size (and fall or slope) chosen from Table 1811.D.5.5B of this code for vertical stacks or Table 1811.D.5.5C of this code for the building drain or its horizontal branches.

f. Waste Disposal Units. Special precautions are necessary where kitchen or food waste disposal units are connected to the discharge pipe system. The discharge pipe from such a unit shall connect directly to the main discharge pipe without intermediate connection with any other discharge pipe. Tubular traps shall always be used and any instructions as to installation given by the manufacturer shall be observed. To avoid hot grease being carried into discharge pipes and drains, where it might build up and cause blockage, waste disposal units shall always be automatically flushed with cold water in order to solidify grease before it enters the drainage system.

ventilation pipes may be required (see §1811.D.7 of this code). It may be worthwhile to consider over sizing the discharge pipes to reduce the ventilating pipework required.

Table 1811.D.5.5C			
Maximum Number of Discharge Units Connected to Building Drain or Building Sewer ^{1,2}			
Nominal Internal Diameter of Pipe (in.)	Slope or Fall Per Foot (in.)		
	1/8	1/4	1/2
2	—	10	26
3	40	100	230
4	30	430	1,050
5	780	1,500	3,000
6	2,000	3,500	7,500

NOTES:

- Discharge pipes sized by this method give the minimum size necessary to carry the expected flow load. Separate ventilation pipes may be required (see §1811.D.7 of this code). It may be worthwhile to consider over sizing the discharge pipes to reduce the ventilating pipework required.
- Building sewer sizes start at 4 inches.

6. Design of Pipe Systems for Dwellings. The design of a single stack discharge and ventilating system for dwellings shall conform with the following.

a. General. In dwellings only, the choice and layout of fixtures and their waste pipes may follow the recommendations for simplified systems as provided in this Subsection. Simplified systems for other types of buildings may be possible but are not provided for in this Part.

b. Design of Single Branches and Fittings. The design of single branches and fittings shall comply with the following.

i. Branch discharge waste pipes (fixture drains) serving plumbing fixtures shall have a uniform shallow fall or slope and the inlet to the stack shall be of a sanitary pattern and have a sweep of not less than 1-inch (25.4 mm) radius. Any horizontal change of direction in a fixture drain shall be of long radius and vertical changes of direction are prohibited.

ii. Water closet branch inlets to the stack shall be swept in the direction of flow with a radius at the invert of not less than 2 inches (51 mm). Entries at 45 degrees (0.785 rad) from the vertical are considered equivalent.

Table 1811.D.5.5A		
Plumbing Fixture Discharge Unit Values		
Type Fixture	Intervals between use in minutes	Discharge unit values
Tank Type W.C.	20	15
Sink	25	8
Wash Basin	25	3
Bathtub	75	8
Shower Stall	75	4
Garbage Disposal	25	4
1 fixture group consisting of 1 W.C., 1 Sink, 1 Tub and 1 Lavatory		20

Table 1811.D.5.5B	
Maximum Number of Discharge Units Allowed on Vertical Stacks ^{1,2}	
Nominal Internal Diameter of Pipe (in.)	Discharge Units
2	20 (No W.C.)
3	200 (No W.C.)
4	850
5	2700
6	6500

NOTES:

- The capacity of a vertical discharge pipe (stack) is limited by the need to preserve a large air core to prevent excessive pressure fluctuation. The flow capacity of a stack may therefore be less than that of a pipe of the same diameter laid at a steep fall.
- Discharge pipes sized by this method give the minimum size necessary to carry the expected flow load. Separate

Table 1811.D.6A		
Design of Single Branches and Fittings		
Component	Design Requirements	Possible Problem
Bend at foot of stack	Bend to be of "large radius", i.e., 6-inch minimum root radius or, if adequate vertical distance is available, two "large radius" 45 bends are to be preferred. Vertical distance between lowest branch connection and invert of drain to be at least 18 inches for a two story house and 30 inches for taller dwellings. Where this distance cannot be achieved, ground floor	Back pressure at lowest branch, foaming of detergents

Table 1811.D.6A Design of Single Branches and Fittings		
Component	Design Requirements	Possible Problem
	fixtures shall be connected directly to the building drain and vented as provided for in other Chapters of this Part (see Figure 1811.D.5.4B of this code).	
W.C. branch connection to stack	Water closet connections shall be swept in the direction of flow with radius at the invert of not less than 2 inches. Fittings in other materials shall have the same sweep as cast iron fittings. The length of unvented water closet is closet branches shall be limited by the diameter of the branch piping: 6 ft for 3-inch diameter, 10 ft for 4-inch diameter.	Induced siphonage at lower level in the stack when water closet is discharged
Lavatory waste 1 1/4-inch trap and 1 1/2-inch minimum waste pipe. Lavatories with 1 1/2-inch P.O. plugs may be installed as provided for sink waste.	"P" traps shall be used. The maximum fall of the waste pipe shall not exceed the hydraulic gradient of the pipe. For the maximum distance between the stack and trap weir see Table 1811.D.6B of this code. Any bends on plan shall be of not less than 3-inch radius at the center line. Waste pipes longer than the recommended maximum length shall be vented. As an alternative, 2-inch diameter waste pipes may be used so long as the hydraulic gradient is not exceeded, but additional maintenance may be necessary to maintain the bore.	Self-siphonage
Bath waste 1 1/2-inch trap and 1 1/2-inch waste pipe	"P" traps shall be used (a 2-inch parallel branch, when required shall not be considered a violation of requirements of other Sections of this Part, when its vertical length does not exceed 12 1/2 inches, and the center line of the parallel branch is not more than 12 1/2 inches from the stack). Owing to the flat bottom of a bath, the trailing discharge normally refills the trap and the risk of self-siphonage is much reduced. Waste pipes 7 ft 6 in. long at a fall or slope of 1/4 in./ft have been used successfully. Position of entry of bath waste into stack to be as shown in Figure 1811.D.5.4A of this Part.	Self-siphonage
Sink Waste 1 1/2-inch trap and 1 1/2-inch waste	"P" traps shall be used. Owing to the flat bottom of a sink, the trailing	Self-siphonage

Table 1811.D.6A Design of Single Branches and Fittings		
Component	Design Requirements	Possible Problem
pipe	discharge normally refills the trap and the risk of self-siphonage is much reduced. Fall or slope of 1/4 in./ft shall be maintained. For maximum length, see Table 1811.D.6B of this code. A sink with 1 1/2-inch tail piece may be drained with a 2-inch horizontal branch not exceeding 8 feet in length. When a 2-inch branch is used, the trap outlet shall connect to a 2 x 1 1/2 inches reducing fitting. An opening into the branch larger than 1 1/2 inches will not be permitted except for a cleanout.	

NOTE:

1. Where the length or fall of the discharge pipe serving a waste fixture is greater than the recommended maximum in this table, the discharge pipe shall preferably be vented (see §1811.D.7 of this code) or a larger diameter discharge pipe shall be used. This may have a maximum length of 10 ft.

Table 1811.D.6B Distance From Trap Weir to Stack or Other Ventilating Pipe	
Minimum Size of Fixture Drain (in.)	Distance Trap to Stack or Vent
1 1/2-inch fixture drains required for lavatories with 1 1/4-inch traps	4 ft 6 in.
1 1/2	5 ft 6 in. (Other than bath waste)
2	7 ft 6 in. (For bathtubs see Table 1811.D.6A of this code)

c. Design of Main Pipework

i. Design details for stacks of various diameters are given below. The choice of design will depend on the space taken up by the pipes and the ease with which they can be accommodated in the building.

ii. An offset in the stack above the topmost connection to the stack has little effect on the performance of the system. Offsets below the topmost connection should be avoided lest extra ventilating pipes be necessary to maintain adequate water seals.

d. 3-Inch Stacks. 3-inch stacks in a single stack system are limited to fixtures other than water closets and to fixtures with maximum drain sizes of 2 inches.

e. 4-Inch Stacks. For details of ventilating pipes see Table 1811.D.6C of this code.

f. 5-Inch Stacks with No Vents (Single Stack System). Suitable for buildings up to 12 stories high where the stack serves one group of fixtures on each floor, or up to

10 stories high where the stack serves up to two groups of fixtures on each floor.

g. 6-Inch Stacks with No Vents (Single Stack System). Suitable for buildings up to at least 20 stories high with not more than two groups of fixtures on each floor.

Table 1811.D.6C Ventilating Pipes Required for Various Loading Conditions 4-inch Discharge Stack		
Number of stories	Stack serving one group on each floor (Each group consists of a water closet, a bath, a basin and a sink. Where dwellings contain more fixtures it may be necessary to provide additional vents)	Stack serving two groups ¹ on each floor
Flats (Each complete living unit is on one floor), 1 to 5	No separate venting required	No separate venting required
6-11	2-inch vent stack connected to the discharge stack on alternate floors	2-inch vent stack connected to the discharge stack on alternate floors
12-15	2-inch vent stack connected to the discharge stack on each floor	2-inch vent stack connected to the discharge stack on each floor
16-20	2 1/2-inch vent stack connected to the discharge stack on each floor	3-inch vent stack connected to the discharge stack on each floor
Maisonettes (Each complete living unit occupies space on two floors, with baths on one floor of the unit), 1 to 4	Single stack system	Single stack system
5-8	Single stack system	2-inch vent stack connected to the discharge stack on alternate (bathroom) floors
9-15	2-inch vent stack connected to the discharge stack on alternate (bathroom) floors	2-inch vent stack connected to the discharge stack on alternate (bathroom) floors
16-20	2 1/2-inch vent stack connected to the discharge stack on alternate (bathroom) floors	3-inch vent stack connected to the discharge stack on alternate (bathroom) floors

7. Ventilating Pipes. Ventilating pipes shall comply with the following.

a. General. The purpose of a ventilating pipe is to maintain equilibrium of pressure within the system and thus prevent the destruction of trap seals by siphonage or compression. It will also assist in preventing undue accumulation of foul air by facilitating air movement in the pipe system.

b. Installation. Ventilating pipes shall be so installed that there is a continuous fall back into the discharge pipe system to prevent any possibility of a waterlock or trap preventing the free movement of air through the ventilating

system and to minimize the risk of internal corrosion. Short turn fittings in the pipework shall be avoided.

c. Branch Vents. Branch ventilating pipes may be connected to a main ventilating pipe or be carried upward either individually or in combination with one another. Such connections shall be above the flood level of the highest fixture served.

d. Sizes. The diameter of a branch ventilating pipe or of a ventilating stack shall be as given in Table 1811.D.7 of this code. For extremely long ventilating stacks, a larger diameter pipe shall be used. See Note 1 in Table 1811.D.7 of this code.

e. Arrangement. A branch ventilating pipe, when required, shall be connected to the individual fixture discharge pipe (fixture drain) not less than 3 inches (76 mm) from the crown weir of the trap. A fixture may be connected to the bottom of a fixture vent, or at the base of a main ventilating stack to assure its being kept clear.

f. Purpose. The purpose of the ventilating pipes is to reduce the pressure fluctuations in the discharge stack by allowing air to enter the stack. Where venting is necessary, therefore, it is often convenient to do so by cross connecting the ventilating stack and the discharge stack directly, preferably above the highest fixtures as appropriate. To prevent cross flow into the ventilating stack, the branch ventilating pipe shall slope upward from the discharge stack at an angle of not less than 45 degrees (0.785 rad) from the horizontal until it reaches a point 6 inches (152 mm) above the flood level rim of the highest fixture serving the floor, at which point it may run at a horizontal angle until connecting with the vertical vent.

Table 1811.D.7 Branch Ventilation Pipe or Ventilating Stack	
Diameter of branch discharge pipe or discharge stack, D (in.)	Diameter of Ventilating Pipe (When the vent length exceeds the length of the discharge stack, the vent shall be at least one pipe size larger than required by this table except for individual fixture vents)
Smaller than 3	2/3 D
3 to 4 inclusive	2 in.
Larger than 4	1/2 D

g. Discharge Point. The outlet of every ventilating pipe system to the open air shall be at such a height and position as will effectively prevent the entry of foul air into the building (see §907 of this code).

8. Pipe Chases and Enclosures, Etc. Pipework enclosures, e.g., ducts, casings, etc., shall be of adequate size and shall have access provisions for maintenance, painting, testing and cleaning. They shall be constructed appropriately for fire resistance in accordance with requirements of the applicable codes adopted under the authority of Act 12 of the 2005 First Extraordinary Session.

9. Choice of Materials. Materials shall conform to the applicable requirements of other Sections and Chapters of this code. Fittings used in the construction of single stack

plumbing systems shall in no case be designed with inlet radii less than provided for in this Subsection.

10. Access to Interior of Pipework. Sufficient access shall be provided to enable all pipework to be tested and to provide reasonable access for cleaning and other necessary maintenance. All access points for clearing purposes shall be carefully sited to allow the entry of clearing apparatus or the insertion of testing apparatus and, where these are in ducts, consideration shall be given to the other services accommodated in the duct.

11. Simultaneous Discharge. The system of discharge pipes shall be capable of withstanding satisfactorily the effects of the probable maximum simultaneous discharge of fixtures which will occur in practice. The number of fixtures to be discharged together to simulate this effect is given in Table 1811.D.11 of this code.

a. For example, for a block of flats nine stories high with the stack serving one water closet, one lavatory, one sink and one bath on each floor, the test discharge is one water closet, one lavatory and one sink simultaneously discharged on each floor (i.e., 27 fixtures discharged simultaneously). Where the stack serves two water closets, two lavatories and two sinks on each floor, the test discharge is one water closet, one lavatory and two sinks simultaneously discharged on each floor (i.e., 36 fixtures discharged simultaneously). For the purpose of this test, baths are ignored as their use is spread over a period and consequently they do not add materially to the normal peak flow on which Table 1811.D.11 of this code is based. Where a stack serves baths only, the number to be discharged simultaneously in a discharge should be taken to be the same as for sinks.

b. All traps shall be fully charged and the appropriate combination of fixtures discharged simultaneously. Trap seals shall be measured at the end of the discharge. The worst conditions occur when fixtures on the upper floor are discharged. A reasonable test, therefore, would be to discharge up to one water closet, one lavatory and one sink from the top of the building, distributing any additional fixtures along the stack.

Table 1811.D.11 Number of Fixtures to be Discharged Simultaneously for Testing Stability of Trap Seals				
Number of fixtures of each kind on the stack	Water Closet	Wash Basin	Kitchen Sink	Misc. (ea. Type)
1-9	1	1	1	1
10-18	1	1	2	2
19-26	2	2	3	3
27-50	2	3	3	3
51-78	3	4	4	4
79-100	3	5	5	4

i. When the miscellaneous fixture is a washer drain, omit one sink from test for each washer drain, except when washers only are connected to the stack.

ii. For washing machine drains (no washers connected) test shall be conducted with hoses connected to

both the hot and cold water supply out lets and with outlets fully opened. (This is in lieu of discharge from washers.) Test should be of 5 minutes duration, one-half of one cup of liquid detergent shall be dispensed into the washer drain pipe at approximately one-third cup per minute along with the water during the last 3 minutes of each test.

E. Single Stack Plumbing System.

1. Approval. The purpose of this Subsection is to make provisions for the design and installation of a single stack plumbing system which is not otherwise allowed in this code. In accord with Chapter 12 of this code, the plumbing official shall require that the owner submit necessary plans and specifications to the state health officer by a Louisiana Registered Professional Engineer registered in either civil or mechanical engineering. In general, single stack plumbing systems may be considered for approval by the state health officer for use on the upper floors of hotel and motel guest rooms but shall not be considered for condominium or apartment complexes.

2. Tests. Single stack plumbing systems shall be tested in accordance with §1205.C of this code.

3. Solvent Single Stack Plumbing System. Copper solvent systems shall be designed and installed in accordance with design criteria contained in the Copper Development Association (CDA) Handbook No. 402/0. Cast iron solvent systems shall be designed and installed in accordance with design criteria contained in ASSE 1043. Cast iron fittings shall meet ASME B16.45. Other materials shall meet standards and specifications listed in Table 703 of this code for drain, waste and vent pipe and fittings.

F. Appendix References. Additional provisions for Alternate Designed Plumbing Systems are contained in Figures 6 and 7 of Section 1807 of this code.

AUTHORITY NOTE: Promulgated in accordance with R.S. 40:4(A)(7) and R.S. 40:5(2)(3)(7)(9)(16)(17)(20).

HISTORICAL NOTE: Promulgated by the Department of Health and Hospitals, Office of Public Health, LR 38:2917 (November 2012).

§1813. Metric Conversions

A. For convenience, the following may be used to convert English units of measurement to Metric units of measurement.

Table 1813.A			
Unit of Measure	STARTING WITH the English unit of measurement	MULTIPLY BY	TO GET the Metric unit of measurement
Length	inches	25.4	mm
	ft	0.3048	m
Area	sq in	645.16	mm ²
	sq ft	0.0929	m ²
Volume	cu in	0.01639	L
	cu ft	28.3169	L
	gal	3.785	L
Mass	lb	0.4536	kg
Mass/unit length	plf (lb/ft)	1.4882	kg/m
Mass/unit area	psf (lb/sq ft)	4.882	kg/m ²
Mass density	pcf (lb/cu ft)	16.02	kg/m ³

PUBLIC HEALTH—SANITARY CODE

Table 1813.A			
Unit of Measure	STARTING WITH the English unit of measurement	MULTIPLY BY	TO GET the Metric unit of measurement
Force	lb	4.4482	N
Force/unit length	plf (lb/ft)	14.5939	N/m
Pressure	psi	6.895	kPa
	psf (lb/sq ft)	47.88	Pa
	in. of Hg @ 60°F	3.37685	kPa
stress, modulus of elasticity	psi	6.895	kPa
	psf (lb/sq ft)	47.88	Pa
Second moment of area	In ⁴	416,231	Mm ⁴
Section modulus	In ³	16,387.064	mm ³
Temperature	°F-32	5/9	°C
	°F + 459.67	5/9	K
Energy, work, quantity of heat	kWh	3.6	MJ
	Btu	1055	J
	ft •lb (force)	1.3558	J
Power	ton (refrig)	3.517	kW
	Btu/s	1.0543	kW
	hp (electric)	745.7	W
	Btu/h	0.2931	W

Table 1813.A			
Unit of Measure	STARTING WITH the English unit of measurement	MULTIPLY BY	TO GET the Metric unit of measurement
Thermal conductance (U value)	Btu/ft ² • h • °F	5.6783	W/m ² • K
Thermal resistance (R value)	Ft ² • h • °F/Btu	0.1761	M ² • K/W
Flow	gpm	0.0631	L/s
	cfm	0.4719	L/s
Illuminance	foot-candle (lm/sq ft)	10.76	lx (lux)
Velocity (speed)	mph	0.447	m/s
Plane angle	°(angle)	0.01745	rad

AUTHORITY NOTE: Promulgated in accordance with R.S. 40:4(A)(7) and R.S. 40:5(2)(3)(7)(9)(16)(17)(20).

HISTORICAL NOTE: Promulgated by the Department of Health and Hospitals, Office of Public Health, LR 38:2924 (November 2012).

Title 51
PUBLIC HEALTH—SANITARY CODE
Part XV. Hotels, Lodging Houses, Boarding Houses

Chapter 1. General

§101. Definitions
[formerly paragraph 15:001]

A. Unless otherwise specifically provided herein, the following words and terms used in this Part of the sanitary code and all other Parts which are adopted or may be adopted are defined for the purpose thereof as follows.

Boarding House—a building or group of buildings where persons are supplied with, and charged for, sleeping accommodations and meals for fixed periods of time.

Hotel—a building where transient guests are usually received without stipulated engagement as to the duration of their stay and are supplied with, and charged for, lodging or meals or both, and such services and attention as are necessarily incident to the use of such places as a temporary abode. This definition includes motels.

Lodging House—a building or group of buildings where persons are supplied with, and charged for, sleeping accommodations but not meals.

Proprietor—a person as defined in Part I, who owns or operates a hotel, lodging house or boarding house.

AUTHORITY NOTE: The first general authority for promulgation of the sanitary code is in R.S. 36:258 (B), with more particular provisions found in Chapters 1 and 4 of Title 40 of the Louisiana Revised Statutes. This Part is promulgated in accordance with the specific provisions of R. S. 40: 4 (A)(5) and R.S. 40: 5.

HISTORICAL NOTE: Promulgated by the Department of Health and Hospitals, Office of Public Health, LR 28:1384 (June 2002).

§103. Permits
[formerly paragraph 15:002-1]

A. Any person operating a hotel, lodging house or boarding house must obtain a permit from the state health officer.

B. [Formerly paragraph 15:002-2] Such permits are non-transferable.

AUTHORITY NOTE: Promulgated in accordance with R.S. 40: 4 (A)(5) and R.S. 40:5.

HISTORICAL NOTE: Promulgated by the Department of Health and Hospitals, Office of Public Health, LR 28:1384 (June 2002).

§105. Plans and Specifications
[formerly paragraph 15:003]

A. Any person constructing, expanding, or renovating a hotel, lodging house or boarding house shall submit plans to and acquire approval of the state health officer.

AUTHORITY NOTE: Promulgated in accordance with R.S. 40: 4 (A)(5) and R.S. 40:5.

HISTORICAL NOTE: Promulgated by the Department of Health and Hospitals, Office of Public Health, LR 28:1384 (June 2002).

§107. Water Supply
[formerly paragraph 15:004]

A. Enough potable water under pressure to supply a minimum of 50 gallons per person per day shall be provided for drinking, cooking and washing purposes. Water supplied to hotels, lodging houses and boarding houses shall conform to the requirements of Part XII of this Code.

B. [Formerly paragraph 15:005] Required Reports. Where a water treatment process is employed, accurate and complete daily reports on the report on the operation thereof shall be kept and submitted at monthly intervals to the state health officer in the parish in which the water supply is located, on a form prescribed by the state health officer.

1. [Formerly paragraph 15:006] Any failure of adequate treatment, change in treatment, process or equipment, or any change in source of water supply, shall be reported immediately to the state health officer.

AUTHORITY NOTE: Promulgated in accordance with R.S. 40: 4 (A)(5) and R.S. 40:5.

HISTORICAL NOTE: Promulgated by the Department of Health and Hospitals, Office of Public Health, LR 28:1384 (June 2002).

§109. Drinking Utensils
[formerly paragraph 15:007]

A. Two types of drinking utensils are acceptable: single-service and multi-use. Single-service utensils are preferable. Multi-use utensils are acceptable, so long as they are washed, rinsed and sanitized between uses in accordance with Part XXIII of this Code.

B. [Formerly paragraph 15:008] Single-service utensils shall meet the requirements of §§2115, 2503, and 2517 of Part XXIII of this Code.

C. [Formerly paragraph 15:009] The use of a communal drinking cup is prohibited. If drinking fountains are provided, they shall meet the requirements of 14:172 of Part XIV of this Code.

AUTHORITY NOTE: Promulgated in accordance with R.S. 40: 4 (A)(5) and R.S. 40:5.

HISTORICAL NOTE: Promulgated by the Department of Health and Hospitals, Office of Public Health, LR 28:1384 (June 2002).

§111. Linen Requirements
[formerly paragraph 15:010]

A. Hotels, lodging houses, and boarding houses shall furnish each guest with clean bed linen and individual towels in each room occupied by such guest, and also in the public lavatories and wash rooms of such places. Clean sheets and pillow slips shall be provided for the bed, bunk, or cot to be occupied by such guest. Sheets shall be of sufficient width and length to completely cover the mattress and spring. At least one lavatory with a supply of soap shall be provided in each toilet room. Hotels should change all such linen daily. Lodging houses and boarding houses should change all such linen at least weekly. All towels, sheet and pillow slips used by one guest shall be washed, sanitized and dried before being furnished to another guest. The use of communal towels in public places is prohibited.

AUTHORITY NOTE: Promulgated in accordance with R.S. 40: 4 (A)(5) and R.S. 40:5.

HISTORICAL NOTE: Promulgated by the Department of Health and Hospitals, Office of Public Health, LR 28:1384 (June 2002).

§113. Eating and Beverage Facilities
[formerly paragraph 15:011]

A. Eating and/or beverage facilities shall obtain a separate permit from the state health officer, having shown themselves to be in compliance with the appropriate Parts of this Code, viz. XII, XIII, XIV and XXIII.

AUTHORITY NOTE: Promulgated in accordance with R.S. 40: 4 (A)(5) and R.S. 40:5.

HISTORICAL NOTE: Promulgated by the Department of Health and Hospitals, Office of Public Health, LR 28:1385 (June 2002).

§115. Swimming Facilities
[formerly paragraph 15:012]

A. Swimming facilities shall meet the requirements of Part XXIV of this Code.

AUTHORITY NOTE: Promulgated in accordance with R.S. 40: 4 (A)(5) and R.S. 40:5.

HISTORICAL NOTE: Promulgated by the Department of Health and Hospitals, Office of Public Health, LR 28:1385 (June 2002).

§117. Sewage Disposal
[formerly paragraph 15:013]

A. Approved toilet and sewage disposal facilities shall be provided. Toilets, toilet rooms, and methods of sewage disposal shall conform to the requirements of Parts XIII and XIV of this Code.

AUTHORITY NOTE: Promulgated in accordance with R.S. 40: 4 (A)(5) and R.S. 40:5.

HISTORICAL NOTE: Promulgated by the Department of Health and Hospitals, Office of Public Health, LR 28:1385 (June 2002).

§119. Garbage Disposal
[formerly paragraph 15:014]

A. Garbage shall be deposited in watertight containers and either covered at all times or otherwise protected from animals, flies, and other insects. The contents shall be

removed as often as necessary to prevent decomposition and overflow, and disposed of in accordance with the applicable regulations, including Part XXVII of this Code.

AUTHORITY NOTE: Promulgated in accordance with R.S. 40:4(A)(5) and R.S. 40:5.

HISTORICAL NOTE: Promulgated by the Department of Health and Hospitals, Office of Public Health, LR 28:1385 (June 2002), repromulgated LR 29:1098 (July 2003).

§121. Employee Health
[formerly paragraph 15:015]

A. The requirements of Part I, §117 and Part II, §501 shall be met.

AUTHORITY NOTE: Promulgated in accordance with R.S. 40: 4 (A)(5) and R.S. 40:5.

HISTORICAL NOTE: Promulgated by the Department of Health and Hospitals, Office of Public Health, LR 28:1385 (June 2002).

§123. Dampness and Noxious Odors Prohibited
[formerly paragraph 15:016]

A. No person shall rent, let, hire out, or allow to be used for a place of sleeping or residence, any portion or apartment of any building, wherein the floor is damp by reason of water from the ground, or which is impregnated or penetrated by an offensive gas or smell prejudicial to health.

AUTHORITY NOTE: Promulgated in accordance with R.S. 40: 4 (A)(5) and R.S. 40:5.

HISTORICAL NOTE: Promulgated by the Department of Health and Hospitals, Office of Public Health, LR 28:1385 (June 2002).

§125. Ice Requirements
[formerly paragraph 15:017]

A. When ice is provided, it shall be of the same bacteriological quality as approved drinking water and shall be handled in compliance with §1907 of Part XXIII of this Code.

AUTHORITY NOTE: Promulgated in accordance with R.S. 40: 4 (A)(5) and R.S. 40:5.

HISTORICAL NOTE: Promulgated by the Department of Health and Hospitals, Office of Public Health, LR 28:1385 (June 2002).

§127. Pest Control
[formerly paragraph 15:018]

A. The walls, ceilings and floors throughout any hotel, lodging house or boarding house shall be kept clean, insect and rodent free (meeting the requirements of Part V of this Code) and in good repair.

AUTHORITY NOTE: Promulgated in accordance with R.S. 40: 4 (A)(5) and R.S. 40:5.

HISTORICAL NOTE: Promulgated by the Department of Health and Hospitals, Office of Public Health, LR 28:1385 (June 2002).

§129. Ventilation Requirements
[formerly paragraph 15:019]

A. Sleeping rooms shall be ventilated by natural or artificial means or both, and also provided with heating facilities. The combustion chambers of all heaters, heating

systems, and other fired equipment shall be vented to the atmosphere. Other parts of the heating, cooling, and ventilating system shall be so designed, built, and maintained as to ensure that the pressure in the space from which combustion air is drawn does not become negative with respect to the atmosphere.

AUTHORITY NOTE: Promulgated in accordance with R.S. 40: 4 (A)(5) and R.S. 40:5.

HISTORICAL NOTE: Promulgated by the Department of Health and Hospitals, Office of Public Health, LR 28:1385 (June 2002).

**§131. Illumination Requirements
[formerly paragraph 15:020]**

A. All rooms shall be provided with adequate illumination to provide:

1. minimum of 10 foot-candles in stairways and halls at an elevation 30 inches above the floor; and
2. a minimum of 30 foot-candles over the areas used for sleeping, reading, cooking and bathing.

AUTHORITY NOTE: Promulgated in accordance with R.S. 40: 4 (A)(5) and R.S. 40:5.

HISTORICAL NOTE: Promulgated by the Department of Health and Hospitals, Office of Public Health, LR 28:1385 (June 2002).

**§133. Responsibility of the Proprietor
[formerly paragraph 15:021-1]**

A. It shall be the duty of the proprietor or person in charge of each establishment to which this Part applies to see that all regulations herein are observed.

B. [Formerly paragraph 15:021-2] The proprietors of all hotels, lodging houses and boarding houses shall keep a record of all guests, noting the name and address of each occupant; date of arrival; and date of departure. This record shall be open during normal operating hours to inspection by the state health officer whenever there is a threat to the public health.

AUTHORITY NOTE: Promulgated in accordance with R.S. 40: 4 (A)(5) and R.S. 40:5.

HISTORICAL NOTE: Promulgated by the Department of Health and Hospitals, Office of Public Health, LR 28:1385 (June 2002).

Title 51
PUBLIC HEALTH—SANITARY CODE
Part XVI. Campsites

Chapter 1. General

§101. Definitions
[formerly paragraph 16:001]

A. Unless otherwise specifically provided herein, the following words and terms used in this Part of the sanitary code, and all other Parts which are adopted or may be adopted, are defined for the purposes thereof as follows.

Camp—any structure used temporarily or occasionally as a dwelling; not used as a residence.

Campsite—a parcel of land or place where cabins, cottages, huts, travel trailers and/or truck coaches or campers, mobile homes and/or trailers, tent campers, tents, and similar structures are erected, parked, maintained, when such place is designed to be used as a temporary abode for camping purposes. This definition includes, but is not limited to, any recreational, educational, tourist, sectarian, work lodging, squatter, or youth camps, and places where camping is allowed without benefit of habitational units, whether a fee is charged for the use thereof or not. This definition does not include private, single family camps.

Comfort Station—a permanent or semi-permanent structure including at least a toilet and lavatory.

Day Camp—an organized campsite that does not provide facilities for overnight use.

Disposal Site—a place or site in or on any camp where refuse materials are routinely disposed of by incineration, landfill, compost, or other disposal method approved by the Louisiana Department of Natural Resources.

Food Service Establishment—defined in Part XXIII of this Code.

Garbage—all putrescible animal and vegetable wastes resulting from the handling, preparation, cooking, and consumption of food, and all animal offal and carcasses of dead animals.

Mobile Home and/or Trailer—a unit used for living or sleeping purposes, equipped with wheels used for the purpose of transporting said unit from place to place whether by motor power or other means (see *travel trailer*).

Natural Swimming Area—all artificial and natural lakes, reservoirs, creeks, ponds, and streams, together with shores, associated buildings, equipment and appurtenances, if used by human beings for swimming or bathing purposes.

Permanent Structure—a building and appurtenance owned and/or operated by camp management for living, dining, sleeping, toilet, bathing, shelter, toolshed, storage, assembly, infirmary, or stable, so constructed as to be immovable and permanent.

Permit—a written document issued by the state health officer giving a designated person permission to operate a specific organized camp.

Primitive Camp—a campsite established for tent camping only, in which accommodations might include toilet and refuse disposal facilities.

Resident Camp—a campsite where one or more permanent or semi-permanent structures are established or maintained as living or sleeping quarters with or without centralized food preparation and food service facilities.

Sanitary Stations—a sewage inlet with cover, surrounded by a concrete apron sloped inward to the drain, and watering facilities to permit periodic wash-down of the immediately adjacent area, to be used as a disposal point for the contents of sewage holding tanks of self-contained travel trailers and/or truck coaches or campers, mobile homes and/or trailers, and tent campers.

Semi-Permanent Structure—any building, tent, structure, or trailer and appurtenances owned and/or operated by camp management for sleeping, living, dining, toilet, bathing, kitchen, tool shed, storage, assemble, infirmary, or animal shelter, etc., so constructed as to be movable, and/or easily disassembled, and not permanent in nature.

Service Building—a permanent or semi-permanent structure of building, housing at least toilet, bathing, and lavatory facilities for both sexes.

Squatter—one who settles or locates on land without legal claim or without the expressed consent of the owner or person in charge of the land.

Tent Camper—any vehicular portable structure built on a chassis, designed as a temporary dwelling for travel, recreation, or vacation use, with or without kitchen equipment, toilet, and lavatory facilities constructed so that the sides and top may be raised an/or extended when parked and lowered and/or retracted while being transported.

Tent Camper Space—a plot of ground with a camp, marked and designated for the accommodation of one tent camper.

Tent Site—a plot of ground, within a campsite, marked and designed for the accommodation of one privately-owned tent.

Toilet—a water closet or privy.

Travel Trailer—a vehicular unit, mounted on wheels, designed to provide temporary living quarters for recreational, camping, or travel use, of such size or weight as not to require special highway movement permits when

towed by a motorized vehicle, and of gross trailer area less than 320 square feet.

a. Self-Contained. Travel trailer having sleeping accommodations, kitchen sink, and other food preparation equipment, a water flushed or chemical toilet, lavatory and/or bathing facilities, and normally a sewage holding tank for retaining wastes.

b. Non Self-Contained. Travel trailer having sleeping accommodation usually kitchen facilities only and is dependent on a service building.

Travel Trailer Space—a plot of ground, within a camp, marked and designated for the accommodation of one travel trailer, mobile home, or mobile home trailer.

Truck Coach or Camper—a portable structure without chassis or wheels built for transport by truck, designed as a temporary dwelling for travel, recreation and vacation use.

a. Self-Contained. Truck coach or camper having sleeping accommodations, kitchen sink, and other food preparation equipment, water flushed or chemical toilet, lavatory and/or bathing facilities, and normally having a sewage holding tank for retaining liquid wastes.

b. Non Self-Contained. Truck coach or camper containing sleeping accommodations with or without sink and food preparation equipment, and dependent on a service building.

Truck Coach/Camper Space—a plot of ground, within a camp, marked and designated for the accommodation of one truck coach or truck camper.

AUTHORITY NOTE: The first source of authority for promulgation of the sanitary code is in R.S. 36:258(B), with more particular provisions found in Chapters 1 and 4 of Title 40 of the Louisiana Revised Statutes. This Part is promulgated in accordance with the specific provisions of R.S. 40:4(A)(4) and R.S. 40:5.

HISTORICAL NOTE: Promulgated by the Department of Health and Hospitals, Office of Public Health, LR 28:1386 (June 2002), repromulgated LR 29:1098 (July 2003), LR 38:2925 (November 2012).

Chapter 3. Plans Review

§301. New Construction or Major Alterations [formerly paragraph 16:002]

A. No new campsite shall hereafter be constructed nor shall major alterations be made to existing campsites without the prior written approval of, and unless in accordance with plans and specifications approved in advance by, the state health officer.

B. [Formerly paragraph 16:103] Said plans and specifications shall include, at least, the following:

1. a vicinity map showing the project location;
2. a plot plan showing:
 - a. property lines;
 - b. the location and width of roads;

c. the number, location, and dimensions of all travel trailer spaces, tent camper spaces, and tent sites;

d. the number, size, type, and location of all permanent and/or semi-permanent structures and facilities;

e. the location of any water supply and sewage disposal system;

f. the location of water and sewer lines;

3. plans and specifications for any sewage collection and/or treatment systems which must be in accordance with the requirements of Part XIII of this Code;

4. plans and specifications for any water supply systems, which must be in accordance with the requirements of Part XII of this Code;

5. plans and specifications for any swimming pool, which must be in accordance with the requirement of Part XXIV of this Code;

6. plans and specifications for any central food preparation and/or food service buildings, including kitchen floor plan, kitchen layout and type of equipment, dining area, rest room for kitchen workers, storage areas, and plumbing (including riser diagrams) which must be in accordance with the requirements of Part XIV of this Code.

AUTHORITY NOTE: Promulgated in accordance with R.S. 40:4(A)(4) and R.S. 40:5.

HISTORICAL NOTE: Promulgated by the Department of Health and Hospitals, Office of Public Health, LR 28:1387 (June 2002).

Chapter 5. Permits and Inspections

§501. Requirements for Permits [formerly paragraph 16:004]

A. No person shall operate a campsite in Louisiana without first receiving approval from the state health officer. Such permit shall not be issued until all pertinent requirements of this Code are met.

B. [Formerly paragraph 16:005] The permit to operate a campsite shall expire on the first day of January next following the date of issue. The permit shall not be reissued if there are violations of this Code in the camp.

C. [Formerly paragraph 16:006] A permit may be revoked by the state health officer if he finds that the campsite for which the permit is issued, is operated, maintained, or occupied in violation of this code. The permit shall be reissued when such violations are corrected.

D. [Formerly paragraph 16:007] Permits shall be conspicuously posted in the office of the campsite permitted and shall not be transferable from one person to another.

E. [Formerly paragraph 16:043] The state health officer may waive some of the requirements of this Part for primitive campsites.

AUTHORITY NOTE: Promulgated in accordance with R.S. 40:4(A)(4) and R.S. 40:5.

HISTORICAL NOTE: Promulgated by the Department of Health and Hospitals, Office of Public Health, LR 28:1387 (June 2002).

§503. Authority to Enter and Inspect Campsites
[formerly paragraph 16:008]

A. The state health officer shall have authority to enter any campsite subject to the code at any reasonable time for the purpose of inspection and enforcement of these regulations. The state health officer shall be given access to all parts of the establishment affected by this code and be furnished any information necessary to make the inspection complete.

AUTHORITY NOTE: Except as may be limited by the provisions of R.S. 40:5 (21) and R.S. 40:8 this Section is promulgated in accordance with R. S. 40:4(A)(4).

HISTORICAL NOTE: Promulgated by the Department of Health and Hospitals, Office of Public Health, LR 28:1387 (June 2002).

Chapter 7. Location, Access, Water Supply and Swimming Facilities

§701. Location and Access
[formerly paragraph 16:009]

A. Campsites shall be located on a well-graded and well-drained site, not subject to flooding, and so located that its drainage will not endanger any private or public water supply.

AUTHORITY NOTE: Promulgated in accordance with R.S. 40:4(A)(4) and R.S. 40:5.

HISTORICAL NOTE: Promulgated by the Department of Health and Hospitals, Office of Public Health, LR 28:1388 (June 2002).

§703. Water Supply
[formerly paragraph 16:010]

A. Water supplies shall conform with the requirements of Part XII of this Code.

AUTHORITY NOTE: Promulgated in accordance with R.S. 40:4(A)(4) and R.S. 40:5.

HISTORICAL NOTE: Promulgated by the Department of Health and Hospitals, Office of Public Health, LR 28:1388 (June 2002).

§705. Swimming Facilities
[formerly paragraph 16:011]

A. Where swimming facilities are provided, such as swimming pools or other types of swimming areas, they shall conform with the requirements of Part XXIV of this Code.

AUTHORITY NOTE: Promulgated in accordance with R.S. 40:4(A)(4) and R.S. 40:5.

HISTORICAL NOTE: Promulgated by the Department of Health and Hospitals, Office of Public Health, LR 28:1388 (June 2002).

*Editor's Note: The address cited in §901.E has changed to:
Louisiana State Fire Marshal
8181 Independence Blvd.
Baton Rouge, LA 70806

Chapter 9. Sleeping, Area, Grounds, Facilities and Maintenance of Campsites

§901. Campsite Requirements
[formerly paragraph 16:012]

A. All permanent and/or semi-permanent structures (except tents and trailers) in any campsite shall be located such that the minimum distance between them is 40 feet. The minimum distance between any permanent and/or semi-permanent tent and/or trailer and any other such tent and/or trailer and/or between those and any other permanent and/or semi-permanent structure shall be 20 feet.

B. [Formerly paragraph 16:113] All living and/or sleeping quarters shall be structurally sound and shall provide protection to the occupants against the elements of the weather.

C. [Formerly paragraph 16:114] All living and/or sleeping quarters shall be properly ventilated by one or more methods including, but not limited to the following: windows, air conditioning, or forced air ventilation. Living and/or sleeping quarters which have no outside opening shall not be permitted in any campsite.

D. [Formerly paragraph 16:115] In all living and/or sleeping quarters the combustion chambers of all heaters, heating systems, and other fired equipment shall be vented to the atmosphere. Other parts of the heating, cooling and ventilating system shall be so designed, built, operated, and maintained as to ensure that the pressure in the space from which combustion air is drawn does not become negative with respect to the atmosphere.

E. [Formerly paragraph 16:116] All cooking stoves, heaters, heating systems, and other fired equipment shall be designed, built, operated, and maintained in accordance with the regulations of the *Louisiana State Fire Marshal, State Office Building, Room 211, 325 Loyola Avenue, New Orleans, LA 70112.

F. [Formerly paragraph 16:117] All campsites shall have each space and/or site for tents, travel trailers, truck coach or camper, sand tent campers clearly marked and designated.

G. [Formerly paragraph 16:118] In all campsites, all travel trailers, truck coaches or campers, mobile homes, and/or trailers, tent campers, and tent shall be located at least 20 feet apart.

H. [Formerly paragraph 16:119] Doubling or allowing more than one travel trailer, truck coach or camper, mobile home and/or trailer, tent camper, or tent per site at the same time is prohibited.

I. [Formerly paragraph 16:020] The number of sleepers per permanent structure of all camps shall be such that each sleeper is provided with at least 48 square feet or floor space.

J. [Formerly paragraph 16:021] Where electricity is provided, a minimum of 10 foot-candles of lighting (measured 3 feet above the floor) shall be provided in all areas inside of all permanent or semi-permanent structures. Privies may be exempted from this requirement by the state health officer.

K. [Formerly paragraph 16:022] All permanent and semi-permanent structures used for living and/or sleeping purposes in all campsites shall be provided with cleanable walls, floors, and ceilings; and these shall be kept clean and in good repair at all times.

L. [Formerly paragraph 16:023] Unassigned.

M. [Formerly paragraph 16:024] Food service operations, except individual or groups of individuals preparing their own meals, shall be operated in accordance with the regulations of Part XXIII of this Code.

AUTHORITY NOTE: Promulgated in accordance with R. S. 40:4(A)(4) and R. S. 40:5.

HISTORICAL NOTE: Promulgated by the Department of Health and Hospitals, Office of Public Health, LR 28:1388 (June 2002).

Chapter 11. Sanitary Toilet and Bathing Facilities at Campsites

§1101. Requirements for Toilets and Bathing Houses at Campsites [formerly paragraph 16:025]

A. Toilet, lavatory, and bathing (shower or tub) facilities shall be provided for all campers (persons), not living in self contained units, in accordance with the requirements of the following Subparagraphs. Bathing facilities need not be provided in primitive camps or in day camps.

1. At least one water closet, toilet, pit privy, or chemical toilet shall be provided for each 15 persons or less, complete with sanitary toilet tissue. Pit privies and/or chemical toilets are not permitted if a camp or the actual inhabited area of a campsite is within 300 feet of a public line main or lateral. In such case plumbing fixtures shall be connected to the public sewer main or lateral, provided that such sewer main or lateral is adequate to serve such premises, and provided the property owner is legally entitled to make such a connection.

2. Urinals shall be provided at the rate of one for each 30 males.

3. Separate bathing (shower) facilities, with hot and cold running water, shall be provided for male and female campers at the rate of one showerhead for each 15 persons of the same sex.

4. Hand-washing facilities with running water, soap, and sanitary towels, such as roll-type or single-service paper towels, or air dryers shall be provided in every toilet room.

In areas where pit privies or chemical toilets may be the principal toilet facilities, hand-washing facilities consisting of cold running water and soap shall be provided outside the toilet facilities.

5. The use of common towels is prohibited.

B. [Formerly paragraph 16:026] Toilet rooms and bathing houses shall be located at a distance no greater than 200 feet away from all living and sleeping quarters.

C. [Formerly paragraph 16:027] The floors of toilet rooms and bathing houses shall be disinfected daily by the use of sanitizing solutions or equivalent bactericidal chemicals approved by the state health officer.

D. [Formerly paragraph 16:028] Pit privies shall be constructed to conform with the requirements of Part XIII of this Code.

E. [Formerly paragraph 16:029] Pit privies shall not be located within 100 feet of any kitchen, mess hall, or dining area.

F. [Formerly paragraph 16:030] All plumbing installations, including design, materials, construction, operation, and maintenance, shall be in accordance with the requirements of Part XIV of this Code.

G. [Formerly paragraph 16:031] The final disposition of all water borne human wastes, including but not limited to, those from restrooms, kitchens, lavatories, bathrooms, bath houses, toilets, urinals, showers, tubs, washing machines, and wash stands, shall be in accordance with the requirements of Part XIII of this Code.

H. [Formerly paragraph 16:032] All permanent and/or semi-permanent buildings, and all travel coaches and/or campers, mobile homes and/or trailers, and tent campers equipped with kitchens, baths, or toilet facilities shall be connected only to an approved sewerage system, designed, constructed, operated, and maintained in accordance with the requirements of Parts XIII and XIV of this Code.

I. [Formerly paragraph 16:033] A sanitary station, meeting the requirements of the state health officer, shall be provided in all campsites that accept self-contained travel trailers, truck coaches and/or campers, mobile homes and/or trailers, tent campers, or any other portable units which include a sewage holding tank.

AUTHORITY NOTE: Promulgated in accordance with R. S. 40:4(A)(4) and R. S. 40:5.

HISTORICAL NOTE: Promulgated by the Department of Health and Hospitals, Office of Public Health, LR 28:1388 (June 2002), repromulgated LR 29:1098 (July 2003).

Chapter 13. General Sanitary Requirements

§1301. Housekeeping [formerly paragraph 16:034]

A. All dwellings shall meet the requirements of Part V of this Code, shall be kept clean, free of insects and rodents, and well repaired. All outside openings shall be effectively screened against insects.

B. [Formerly paragraph 16:035] The entire premises of all camps shall be kept free of accumulations of refuse and debris.

C. [Formerly paragraph 16:036] All articles of bedding shall be kept clean and in good repair. Mattress covers shall be furnished in all sleeping quarters provided by the camp. When furnished by the camp, clean linen shall be provided to each occupant upon arrival and at least weekly thereafter.

AUTHORITY NOTE: Promulgated in accordance with R. S. 40:4(A)(4) and R. S. 40:5.

HISTORICAL NOTE: Promulgated by the Department of Health and Hospitals, Office of Public Health, LR 28:1389 (June 2002).

§1303. Garbage and Refuse
[formerly paragraph 16: 037]

A. Garbage and refuse shall be handled and disposed of in accordance with the requirements of Part XXVII of this Code and the Louisiana Department of Environmental Quality.

AUTHORITY NOTE: Promulgated in accordance with R.S. 40:4(A)(5) and R.S. 40:5.

HISTORICAL NOTE: Promulgated by the Department of Health and Hospitals, Office of Public Health, LR 28:1389 (June 2002), repromulgated LR 29:1098 (July 2003).

§1305. Disease Control
[formerly paragraph 16:038]

A. Control of diseases shall be in accordance with the requirements of Part II of this Code.

AUTHORITY NOTE: Promulgated in accordance with R. S. 40:4(A)(4) and R. S. 40:5.

HISTORICAL NOTE: Promulgated by the Department of Health and Hospitals, Office of Public Health, LR 28:1389 (June 2002).

*Editor's Note: The address cited in §1307.A has changed to:
Louisiana Department of Agriculture and Forestry
P.O. 3596
Baton Rouge, LA 70821-3596

§1307. Insects and Rodents
[formerly paragraph 16:039]

A. Extermination methods used to control insects and rodents shall be in accordance with the regulations of the *Louisiana Department of Agriculture and Forestry, P.O. Box 16390-A, Baton Rouge, LA 70893.

AUTHORITY NOTE: Promulgated in accordance with R. S. 40:4(A)(4) and R. S. 40:5.

HISTORICAL NOTE: Promulgated by the Department of Health and Hospitals, Office of Public Health, LR 28:1389 (June 2002).

§1309. Other Animals
[formerly paragraph 16:040]

A. No dogs cats, or other domestic animals shall be permitted to run at large within the limits of campgrounds.

B. [Formerly paragraph 16:041] It shall be the duty of the owner or person in charge of the camp to report, to the state health officer, bites to humans caused by dogs, cats, bats, or any other type of warm blooded domestic or wild animal.

C. [Formerly paragraph 16:042] Horses, dogs or other domestic animals or pets shall not be permitted in swimming areas or in areas used for waterfront activities.

AUTHORITY NOTE: Promulgated in accordance with R. S. 40:4(A)(4) and R. S. 40:5.

HISTORICAL NOTE: Promulgated by the Department of Health and Hospitals, Office of Public Health, LR 28:1389 (June 2002).

Title 51

PUBLIC HEALTH—SANITARY CODE

Part XVII. Public Buildings, Schools, and Other Institutions

Chapter 1. General Requirements for Public Buildings

§101. Definitions

A. Unless otherwise specifically provided herein, the following words and terms used in this Part of the Sanitary Code, and all other Parts which are adopted or may be adopted, are defined for the purposes thereof as follows.

Institution or *Institutional Building*—a building or buildings housing an organization, foundation, or other entity dedicated to education, culture, or other public service [e.g., public or private schools (nursery schools, trade schools, colleges, or universities), hospitals, nursing homes, jails, and mortuaries].

LSPC—Louisiana State Plumbing Code, i.e., Part XIV (Plumbing) of this Code (LAC 51:XIV).

Public Building—any structure that is owned, leased, or principally used by a government agency for public business, meetings, or other group gatherings, or other building to which the general public has reasonably free access [e.g., including, but not limited to, every public and government building, school (kindergarten, nursery school, trade school, college, or university), office building, store, commercial building, enclosed shopping center, theater, lecture hall, auditorium, hotel, restaurant, boarding house, nursing home, hospital, airport building, bus depot, railroad depot, and other places where people congregate, etc.].

Readily Accessible—having direct access without the need of removing any panel, door or similar covering of the item described and without requiring the use of portable ladders, chairs, etc.

State Health Officer—see definition in Part I, Section 101.B of this Code and apply it in this Part.

Substantial Renovation—see definition in Part I, Section 101.B of this Code and apply it in this Part.

AUTHORITY NOTE: The first source of authority for promulgation of the sanitary code is in R.S. 36:258(B), with more particular provisions found in Chapters 1 and 4 of Title 40 of the Louisiana Revised Statutes. This Part is promulgated in accordance with R.S. 40:4(A)(10) and R.S. 40:5(2)(3)(4)(5)(16)(17)(19)(21).

HISTORICAL NOTE: Promulgated by the Department of Health and Hospitals, Office of Public Health, LR 37:2165 (July 2011), amended LR 38:2925 (November 2012).

§103. Lighting, Heating, and Ventilation Requirements for Public Buildings [Formerly §101]

A. Every public and government building in this state, including, but not limited to every school (kindergarten,

nursery school, trade school, college or university), office building, store, commercial building, enclosed shopping center, theater, lecture hall, auditorium, hotel, restaurant, boarding house, nursing home, hospital, airport building, bus depot, railroad depot, and other places where people congregate, shall be adequately lighted, heated, and ventilated, in accordance with the requirements of this Chapter, and shall otherwise conform to all other requirements of this Part.

B. Every indoor area traversed by people, including halls, stairways, and toilet rooms, shall a minimum of 10 foot-candles of illumination measured at a level 3 feet above the floor.

C. The combustion chambers of all heaters, heating systems, and other fired equipment shall be vented to the atmosphere. Other parts of the heating, cooling, and ventilating system shall be so designed, built, and maintained as to ensure that the pressure in the space from which combustion air is drawn does not become negative with respect to the atmosphere.

AUTHORITY NOTE: Promulgated in accordance with R.S. 40:4(A)(10) and R.S. 40:5(2)(3)(4)(5)(16)(17)(19)(21).

HISTORICAL NOTE: Promulgated by the Department of Health and Hospitals, Office of Public Health, LR 28:1390 (June 2002), amended LR 37:2165 (July 2011).

§105. Plans and Specifications [Formerly §103]

A. No person shall construct any new facilities for any state agency, or construct any new institutional buildings, or make additions or substantial renovations to such existing facilities until plans and specifications therefore have been submitted to, and approved in writing by, the state health officer. Institutions include, but are not limited to the following (whether public or private):

1. schools (nursery schools, trade schools, colleges, or universities);
2. hospitals;
3. nursing homes;
4. jails; and
5. mortuaries.

AUTHORITY NOTE: Promulgated in accordance with R.S. 40:4(A)(10) and R.S. 40:5(2)(3)(4)(5)(16)(17)(19)(21).

HISTORICAL NOTE: Promulgated by the Department of Health and Hospitals, Office of Public Health, LR 28:1390 (June 2002), amended LR 37:2166 (July 2011).

§107. Drinking Water Provisions
[Formerly §103]

A. Drinking water, processed in accordance with Part XII of this Code, shall be made available to all occupants of all public buildings.

B. Drinking fountains shall be provided in public buildings and institutions in the quantities shown in Table 411 of the Louisiana State Plumbing Code (LSPC). Said drinking fountains shall be constructed and installed in accordance with the requirements of §415.C of the LSPC.

C. The use of receptacles for handling and storing drinking water other than bottled water approved by the state health officer is prohibited, except in emergencies, as approved by the state health officer.

D. Drinking Utensils. The use of a drinking cup in common is prohibited. Two types of drinking utensils are acceptable: single-service and multi-use. Single-service utensils are preferable, but multi-use utensils are acceptable so long as they are washed, rinsed and sanitized between uses in accordance with Part XXIII of this Code. Single-service utensils shall meet the requirements of §§2115, 2503, and 2517 of Part XXIII of this Code.

AUTHORITY NOTE: Promulgated in accordance with R.S. 40:4(A)(10) and R.S. 40:5(2)(3)(4)(5)(16)(17)(19)(21).

HISTORICAL NOTE: Promulgated by the Department of Health and Hospitals, Office of Public Health, LR 28:1390 (June 2002), amended LR 37:2166 (July 2011), amended LR 38:2925 (November 2012), repromulgated LR 38:3233 (December 2012).

§109. Plumbing and Sewage Disposal Requirements
[Formerly §107]

A. All public buildings shall be provided with sewage disposal facilities and plumbing in compliance with the provisions of Parts XIII and XIV of this Code.

B. Toilet rooms shall be provided in all public buildings for use by the general public. Facilities for hand-washing and cleaning purposes shall be located in these places and shall be provided with soap, mechanical hand-drying devices or disposable paper towels, and toilet paper. In addition, said toilet rooms shall meet the requirements of the following Sections, and those of Part XIV of this Code. Showers, if provided, shall meet the requirements of Part XIV of this Code.

C. The site of all public buildings shall be well drained, such that no water will collect.

AUTHORITY NOTE: Promulgated in accordance with R.S. 40:4(A)(10) and R.S. 40:52(3)(4)(5)(16)(17)(19)(21).

HISTORICAL NOTE: Promulgated by the Department of Health and Hospitals, Office of Public Health, LR 28:1390 (June 2002), repromulgated LR 29:1099 (July 2003),

§111. Housekeeping Requirements
[Formerly §109]

A. Public buildings shall be kept clean. Sweeping, vacuuming and mopping should be done when the building is free of occupants, if possible. Sweeping shall be done in such a manner as to minimize the spread of dust. Mops shall

be cleaned after use and before storage in a well ventilated area. Vacuum cleaners should be equipped with a High Efficiency Particulate Air (HEPA) filter that is maintained per manufacturer's specifications.

B. No absorbent floor covering shall be used in assembly halls, dining rooms, halls and stairways. Any carpeting installed in such areas shall be made of non-absorbent fibers.

C. Garbage and trash shall not be allowed to accumulate anywhere on the premises except in containers designed and maintained in accordance with Part XXVII of this Code. Garbage and other discarded putrid materials shall be stored in impervious cans with tight fitting covers. Oily rags and other materials subject to spontaneous combustion shall be stored in tightly covered metal containers. Other trash shall be stored in non-combustible containers.

D. Garbage cans shall be washed weekly or more often if residues accumulate or odors become offensive. Said washing shall be done on a concrete or other impervious surface sloping toward a drain so that none of the wash water escapes the controlled area. Any liquid wastes from compacting garbage or trash shall be disposed of as sewage. Said drain shall be equipped with a strainer and shall be connected to a sanitary sewage treatment system which meets the requirements of Part XIII of this Code. If this area is located outdoors, methods shall be used to prevent rainwater and surface water runoff from entering the sewerage system, such as elevating the cleaning pad/compacting area, curbing the cleaning pad/compacting area, enclosing and/or covering the cleaning pad/compacting area such that the surrounding parking lot, street, or ground area, etc., is not allowed to drain into the sewerage system. If the discharge of cleaning or compacting contains fats, oils, or grease, such drain shall first discharge into a grease trap or oil interceptor (designed in accord with Part XIV of this Code), as appropriate, before connecting to the sewerage system.

E. Spitting in or about any public building is prohibited.

AUTHORITY NOTE: Promulgated in accordance with R.S. 40:4(A)(10) and R.S. 40:5(2)(3)(4)(5)(16)(17)(19)(21).

HISTORICAL NOTE: Promulgated by the Department of Health and Hospitals, Office of Public Health, LR 28:1391 (June 2002), repromulgated LR 29:1099 (July 2003), amended LR 37:2166 (July 2011).

Chapter 3. Special Sanitary
Requirements for Schools and Other
Institutions

§301. Toilet Rooms in Schools and Other Institutions
[formerly paragraph 17:021]

A. For primary schools, and other special types of institutions with classrooms, for children through 12 years of age, separate boys' and girls' toilet room doors shall not be further than 200 feet from any classroom doors. For secondary schools, and other special types of institutions with classrooms, for persons of secondary school age, separate boys' and girls' toilet room doors shall not be further than 400 feet from any classroom door. In multi-storied

buildings, there shall be boys' and girls' toilet rooms on each floor, having the number of plumbing fixtures as specified in Part XIV of this Code for the classroom population of that floor.

B. The state health officer may require additional or alternate facilities as necessary to serve persons with special needs.

AUTHORITY NOTE: Promulgated in accordance with R.S. 40:4(A)(10) and R.S. 40:5(2)(3)(4)(5)(16)(17)(19)(21).

HISTORICAL NOTE: Promulgated by the Department of Health and Hospitals, Office of Public Health, LR 28:1391 (June 2002), amended LR 37:2167 (July 2011).

§303. School Lunchrooms and Concession Stands
[formerly paragraph 17:022]

A. All school lunch rooms and school concession stands shall comply with the general sanitary requirements for public eating places as specified in Part XXIII of this Code.

B. [Formerly paragraph 17:023] Single-service utensils, made of paper or approved plastic, shall be used in school lunchrooms whenever equipment is deemed inadequate by the state health officer to provide proper sanitization for multiple-use utensils.

C. [Formerly paragraph 17:024] In all schools and in other special types of institutions with classrooms, hand-washing facilities (for student and staff use before eating)

shall be readily accessible in a common area and shall not be further than 50 feet from the lunch room, dining area or cafeteria. Said facility shall be provided with hot and cold running water delivered via a mixing faucet(s) or a mixing valve at a water temperature not to exceed 120°F [utilizing an approved temperature control device(s) as required under LAC 51:XIV.623], soap, and disposable paper towels or mechanical hand-drying devices.

AUTHORITY NOTE: Promulgated in accordance with R.S. 40:4(A)(10) and R.S. 40:5(2)(3)(4)(5)(16)(17)(19)(21).

HISTORICAL NOTE: Promulgated by the Department of Health and Hospitals, Office of Public Health, LR 28:1391 (June 2002), amended LR 37:2167 (July 2011), amended LR 38:2925 (November 2012).

§305. Space and Lighting Requirements for Classrooms
[formerly paragraph 17:025]

A. In all schools, and in other special types of institutions with classrooms, a minimum of 20 square feet of floor space shall be provided in every classroom for each student.

B. [Formerly paragraph 17:026] In all schools, and in other special types of institutions with classrooms, artificial lighting shall be provided in all classrooms and other rooms with the minimum level of illumination as listed in Table 305.B below.

Table 305.B—School/Classroom Lighting						
Room Type Classification	Direct Lighting Footcandle Levels ⁽¹⁾			Indirect Footcandle Levels ⁽²⁾		
	Maximum	Average	Minimum	Maximum	Average	Minimum
Administrative Areas						
Offices/Receptionist	75	50	25	60	40	20
Storage Rooms	38	25	13	38	25	13
Restrooms	38	25	13	38	25	13
Conference/Resource Rooms	75	50	25	60	40	20
Healthcare Area	75	50	25	60	40	20
Teacher Prep/Work Area	75	50	25	60	40	20
Classrooms						
General Classrooms	75	50	25	60	40	20
Visual Arts Rooms	75	50	25	60	40	20
Modular Technology Labs	75	50	25	60	40	20
Computer Aided/Drafting Labs	45	30	15	45	30	15
Industrial Arts Rooms	90	60	30	90	60	30
Computer Labs	60	40	20	60	40	20
Graphics Labs	75	50	25	60	40	20
Life Skills Labs	75	50	25	75	50	25
Science Rooms/Labs	75	50	25	75	50	25
Laundry Rooms	38	25	13	38	25	13
Music Rooms	75	50	25	60	40	20
Large Group Instruction Rooms	75	50	25	60	40	20
Media Center						
Active Areas	75	50	25	60	40	20
Inactive Areas	60	40	20	60	40	20
Student Dining/Auditoriums						
Assembly	30	20	10	N/A		
Stage/Work Lights	30	20	10	N/A		
Makeup/Dressing Rooms	75	50	25	75	50	25
Theatrical Control Room	45	30	15	45	30	15
Kitchen	60	40	20	N/A		
Dining Areas	60	40	20	60	40	20
Athletic Areas						
Gymnasium-Elementary School	75	50	25	N/A		
Gymnasium-Middle School	75	50	25	N/A		
Gymnasium-High School	90	60	30	N/A		

Table 305.B—School/Classroom Lighting						
Room Type Classification	Direct Lighting Footcandle Levels ⁽¹⁾			Indirect Footcandle Levels ⁽²⁾		
	Maximum	Average	Minimum	Maximum	Average	Minimum
Multi-use Physical Education Rooms	75	50	25	N/A		
Locker Rooms	38	25	13	38	25	13
Circulation						
Hallways	30	20	10	30	20	10
Stairwells	30	20	10	30	20	10
Maintenance Areas						
Custodial Closets	45	30	15	45	30	15
Mechanical Rooms	45	30	15	45	30	15

Footnotes to Table 305.B

(1) Direct lighting refers to light that is being directed in a downward direction towards the surface being illuminated.

(2) Indirect lighting refers to light that is directed at least partially in an upward direction or is reflected in some manner towards the surface being illuminated.

1. General Notes on Lighting System Design and Enforcement of Table 305.B

a. For design in new and significantly renovated schools, the designer shall utilize the Illuminating Engineering Society of North America (IESNA) Lighting Handbook; however, the standards contained in Table 305B of this Part shall control if there is a conflict.

b. Enforcement of the lighting standards is based upon the average illumination level in each room or area.

c. For instructional spaces utilizing digital “smart boards” or outfitted for audio-visual presentations, the designer should consider the installation of lighting controls readily accessible to the instructor having capability to reduce the illumination on the screen to seven footcandles or less, while maintaining an average of 20 footcandles within the remaining functional areas of the room or area.

d. For instructional spaces utilizing dry-erase whiteboards, the designer should consider the installation of separately controlled, dedicated luminaries mounted parallel

to the whiteboard, providing 30 footcandles average on the vertical plane of the whiteboard.

AUTHORITY NOTE: Promulgated in accordance with R.S. 40:4(A)(10) and R.S. 40:5(2)(3)(4)(5)(16)(17)(19)(21).

HISTORICAL NOTE: Promulgated by the Department of Health and Hospitals, Office of Public Health, LR 28:1391 (June 2002), amended LR 37:2167 (July 2011).

§307. Outdoor Play Areas

A. For elementary schools and other schools with children under 12 years of age, all pieces of playground equipment with play surfaces four feet or higher from the ground shall have an appropriate energy absorptive surface such as wood chips at a depth of 8-10 inches or rubber mats, manufactured for such use meeting A.S.T.M. Standard F355-10a, under the fall zone of the equipment. A swing with the seat four feet above the ground when at a 90 degree arc shall meet this requirement.

AUTHORITY NOTE: Promulgated in accordance with R.S. 40:4(A)(10) and R.S. 40:5(2)(3)(4)(5)(16)(17)(19)(21).

HISTORICAL NOTE: Promulgated by the Department of Health and Hospitals, Office of Public Health, LR 37:2168 (July 2011).

Chapter 5. Health Requirements for Schools

§501. Employee Health and Student Health [formerly paragraph 17:028]

A. [Formerly paragraph 17:028] The requirements of Part I, §117 and Part II, §§113 and 503 shall be met.

B.1. [Formerly paragraph 17:029] All students in the health care professions shall be free of tuberculosis in a communicable state as evidenced by either:

a. a negative purified protein derivative test, five tuberculin unit strength, given by the Mantoux method;

b. a normal chest X-ray if the skin test is positive; or

c. a statement from a Louisiana licensed physician that the person is noninfectious to others if the chest X-ray is other than normal.

2. If the student has a positive purified protein derivative skin test for tuberculosis, five tuberculin unit strength, given by the Mantoux method, or a chest X-ray other than normal, the student shall complete a course of chemotherapy for tuberculosis as prescribed by a Louisiana licensed physician, or present a signed statement from a Louisiana licensed physician stating that chemotherapy for tuberculosis is not indicated. In any case, the student shall not be denied access to an institutional learning experience or work solely on the basis of being infected with tuberculosis, provided the infection is not communicable.

AUTHORITY NOTE: Promulgated in accordance with R.S. 40:4 (A)(2)(10) and R.S. 40:5 (1)(2)(10)(17).

HISTORICAL NOTE: Promulgated by the Department of Health and Hospitals, Office of Public Health, LR 28:1392 (June 2002), repromulgated LR 29:1099 (July 2003), amended LR 41:2657 (December 2015).

Title 51
PUBLIC HEALTH—SANITARY CODE

Part XVIII. Jails, Prisons and Other Institutions of Detention or Incarceration

Chapter 1. General Requirements

§101. Construction Requirements

A. No new jails, prisons or other institutions of detention or incarceration shall hereafter be constructed nor shall major alterations be made to existing jails, prisons or other institutions of detention or incarceration without the prior written approval of, and unless in accordance with plans and specifications approved in advance by, the state health officer.

B. [Formerly paragraph 18:002] All buildings shall be of sound construction. A finish that is easily cleaned shall be applied to all walls, floors, and ceilings.

C. [Formerly paragraph 18:003] All facilities shall be connected to a potable water supply designed, constructed, operated, and maintained in accordance with the provisions of Part XII of this Code.

D. [Formerly paragraph 18:004] All facilities shall be connected to a sewage treatment system designed, constructed, operated, and maintained in accordance with the provision of Part XIII of this Code.

E. [Formerly paragraph 18:005] All plumbing shall be in accordance with the provisions of Part XIV of this Code.

F. [Formerly paragraph 18:006] Running potable water, for drinking purposes, shall be available to each cell and cell block area.

G. [Formerly paragraph 18:007] New construction and renovation shall provide hand washing lavatories, with hot water (not to exceed 110° Fahrenheit) and cold water, delivered through a mixing faucet, in each cell and cell block area except in padded cells.

H. [Formerly paragraph 18:008] New construction and renovations shall provide toilets conforming to the requirements of Part XIV in each cell and cell block area. When prisoners are not allowed free access to the cell block area, a toilet shall be provided in each cell. Padded cells are exempt from this provision.

I. [Formerly paragraph 18:009] Showers, tubs or other bathing facilities, with hot and cold water delivered through a mixing faucet, shall be available to all inmates and shall meet the requirements of Part XIV.

J. [Formerly paragraph 18:010] When inmates are housed in dormitories, sanitary facilities, meeting the requirements of Part XIV shall be provided in accordance with the following.

Toilets	Urinals*	Lavatories	Bathing Facilities (Showers, Tubs, etc.)	Drinking Fountains
1 for each 20 male inmates	1-30 1 31-50 2 51-100 3 101-150 4 over 150	1 for each 16	**1 for 20	1 for 75
1 for each 14 female inmates	for each additional 50 inmates	Space between beds: min. of 28 inches vertically and horizontally for all new construction, renovation and replacement.		
1. *Only for facilities housing males. Trough urinals may be used as long as they meet the requirements of Part XIV.				
2. **The state health officer will consider written appeals based on unusual program schedules.				

K. [Formerly paragraph 18:011] If visitor waiting rooms are provided, a toilet and lavatory shall be provided in a room separate from cell block facilities.

L. [Formerly paragraph 18:012] For all new construction or renovation, a minimum of 48 square feet of floor space shall be provided for each prisoner where he or she is confined for 72 hours or over in any one area at a time.

M. [Formerly paragraph 18:013] There shall be a minimum spacing of 28 inches, horizontally in all directions and vertically, between all beds which are not separated by walls or approved solid partitions.

N. [Formerly paragraph 18:014] All indoor area inhabited or traversed by people shall have a minimum of 20 foot-candles of illumination measured at a level 3 feet above the floor.

O. [Formerly paragraph 18:015] Forced ventilation approved by the state health officer shall be provided throughout all areas. The combustion chambers of all heaters, heating systems, and other fired equipment shall be vented to the atmosphere. Other parts of the heating, cooling, and ventilating system shall be so designed, built, and maintained as to ensure that the pressure in the space from which combustion air is drawn does not become negative with respect to the atmosphere.

P. [Formerly paragraph 18:016] All openings to the outer air shall be protected against the entrance of flies, mosquitoes, rodents, and other insects and vermin by self-closing doors, closed windows, screening, controlled air currents or other approved means, and shall meet the requirements of Part V of this Code.

AUTHORITY NOTE: The first source of authority for promulgation of the sanitary code is in R.S. 36:258(B), with more particular provisions found in Chapters 1 and 4 of Title 40 of the Louisiana Revised Statutes. This Part is promulgated in accordance with R.S. 40:4(A)(10) and R.S. 40:5(2)(3)(4)(5)(7)(17)(19)(21).

HISTORICAL NOTE: Promulgated by the Department of Health and Hospitals, Office of Public Health, LR 28:1392 (June 2002), amended LR 38:2925 (November 2012).

§103. Operations and Maintenance
[formerly 18:017]

A. All facilities and fixtures shall be maintained in a clean condition at all times.

B. [Formerly paragraph 18:018] Beds, pillows, sheets and pillow cases, if provided, and other bedding, shall be maintained in good repair and in clean condition at all times. Either fixed or removable impervious covers or removable cloth covers, which are maintained in good repair and kept clean, shall be provided for all mattresses and pillows.

C. [Formerly paragraph 18:019] All food must be prepared in a kitchen that possesses a valid "Permit to Operate" issued by the state health officer. Food transported from a kitchen area or dining hall to other areas shall be transported in accordance with the requirements of Part XXIII.

D. [Formerly paragraph 18:020] An isolation cell shall be provided for any prisoner with communicable disease when isolation is deemed necessary by the state health officer.

AUTHORITY NOTE: Promulgated in accordance with the provisions of R.S. 40:4(A)(10) and R.S. 40:5(4).

HISTORICAL NOTE: Promulgated by the Department of Health and Hospitals, Office of Public Health, LR 28:1393 (June 2002).

Chapter 3. Health Requirements for Incarceration

§301. Inmate Health

A. [Formerly paragraph 18:021] Any person entering any Louisiana state prison as an inmate for 48 hours or more

shall be screened for tuberculosis with a purified protein derivative skin test, five tuberculin unit strength, given by the Mantoux method, and a chest X-ray if the skin test is positive. If the individual is known to be infected with the human immunodeficiency virus (HIV) or has acquired immunodeficiency syndrome (AIDS), he or she shall be required to have a chest X-ray in addition to a skin test for tuberculosis, regardless of the skin test results. If an individual has a positive skin test or positive X-ray, he or she shall be evaluated by a physician to determine whether he or she should receive a course of chemotherapy for tuberculosis. If evaluation is desired before 48 hours, a chest X-ray is acceptable for screening.

B. [Formerly paragraph 18:022] Any person entering any Louisiana parish jail as an inmate for 14 days or more shall be screened for tuberculosis, where funding is available, with a purified protein derivative skin test, five tuberculin unit strength, given by the Mantoux method, or by the blood assay for Mycobacterium tuberculosis, and a chest x-ray if the skin test or the blood assay for Mycobacterium tuberculosis is positive. If the individual is known to be infected with the human immunodeficiency virus (HIV) or has acquired immunodeficiency syndrome (AIDS), he or she shall be required to have a chest x-ray in addition to a skin test for tuberculosis or in addition to a blood assay for Mycobacterium tuberculosis, regardless of the results. If an individual has a positive skin test or a positive result of a blood assay for Mycobacterium tuberculosis or a positive x-ray, he or she shall be evaluated by a physician to determine whether he or she should receive a course of chemotherapy for tuberculosis. If evaluation is desired before 14 days, a chest x-ray is acceptable for screening.

AUTHORITY NOTE: Promulgated in accordance with the provisions of R.S. 40:4(A)(2) and R.S. 40:5.

HISTORICAL NOTE: Promulgated by the Department of Health and Hospitals, Office of Public Health, LR 20:301 (March 1994), repromulgated LR 29:1099 (July 2003), amended LR 37:598 (February 2011).

Title 51

PUBLIC HEALTH—SANITARY CODE

Part XIX. Hospitals, Ambulatory Surgical Centers, Renal Dialysis Centers

Chapter 1. General Requirements

§101. Definitions

[formerly paragraph 19:001]

A. Unless otherwise specifically provided herein, the following words and terms used in this Part and all other Parts which are adopted or may be adopted, are defined for the purposes thereof as follows.

Ambulatory Surgical Center—an establishment with an organized medical staff of physicians, permanent facilities that are equipped and operated primarily for the purpose of performing surgical procedures, continuous physician services and registered professional nursing services whenever a patient is in the facility, which does not provide services or other accommodations for patients to stay overnight, and which offers the following services whenever a patient is in the center: drug services as need for medical operations and procedures performed; provisions for physical and emotional well-being of patients; provisions for emergency services; organized administrative structure; and administrative, statistical, and medical records.

Hospital—any institution, place, building, or agency, public or private, whether for profit or not, devoted primarily to the maintenance and operation of facilities to 10 or more individual for the diagnosis, treatment or care of persons admitted for overnight stay or longer who are suffering form illness, injury, infirmity or deformity or other physical condition which obstetrical, medical or surgical services would be available and appropriate.

Renal Dialysis Center—an establishment which is approved to furnish diagnostic, therapeutic, or rehabilitative services required for the care of end stage renal disease dialysis patients.

AUTHORITY NOTE: The first source of authority for promulgation of the sanitary code is in R.S. 36:258(B), with more particular provisions found in Chapters 1 and 4 of Title 40 of the Louisiana Revised Statutes. This Part is promulgated in accordance with the provisions of R.S. 40:4(A)(10) and R.S. 40:5(3).

HISTORICAL NOTE: Promulgated by the Department of Health and Hospitals, Office of Public Health, LR 28:1393 (June 2002).

§103. Construction Requirements

[formerly paragraph 19:002]

A. Plans. No new hospital, ambulatory surgical center, or renal dialysis center shall hereafter be constructed, nor shall major alterations be made to existing hospitals, without the prior written approval of, and unless in accordance with plans and specifications approved in advance by, the state health officer. The review and approval of plans and specifications shall be made in accordance with the

publication entitled: "Minimum Requirements of Construction and Equipment for Hospitals and Medical Facilities" [DHEW Publication No. (HRA) 79-14500], published by the U.S. Department of Health, Education, and Welfare, Public Health Service, Health Resources Administration, Bureau of Health Facilities Financing, Compliance and Conversion.

B. [Formerly paragraph 19:005] Doors, Stairways, and Elevators. The building shall be provided with ramps, doors, corridors, and elevators to accommodate the handicapped. Stairways, ramps and elevators shall be provided with nonskid floors and surfaces, and shall have handrails on both sides located approximately 31 inches (78.7 cm) above the stair-tread on edge of riser and continue the length of stairway or ramp. All doors to the outside shall open outward and be provided with self-closing devices and be equipped with panic type hardware, unless automatic sliding doors are provided.

C. Ventilation, Air Conditioning and Heating

1. [Formerly paragraph 19:006] All patient rooms shall be well ventilated and under positive pressure except for negative pressure rooms designated as such. Temperature, humidity, pressure and air exchange characteristics shall conform to the requirements in "Minimum Requirements on Construction and Equipment for Hospitals and Medical Facilities" [DHEW Publication No. (HRA) 79-14500] as they apply to specific areas of the building. The heating and cooling system shall be such type and maintained and operated in such a manner to provide a comfortable temperature for patients and personnel. The heating and cooling system shall also be constructed to conform to the requirements in "Minimum Requirements on Construction and Equipment for Hospitals and Medical Facilities" (DHEW Publication No. (HRA) 79-14500).

2.a. [formerly paragraph 19:006-1] Persons with tuberculosis in a communicable state or suspected of having tuberculosis in a communicable state shall be cared for in isolation rooms with negative air pressure and either:

i. at least six changes of room air per hour accomplished by exhaust ventilation; or

ii. equivalent circulation and treatment by ultraviolet light treatment, "air scrubber," or equivalent.

b. If the patient is not in a room with proper ventilation and is unable or unwilling to cover their cough, then exposed persons shall wear proper masks, which filter all particles larger than 1 micron, in order to prevent the spread of infectious respiratory droplets.

3. [formerly paragraph 19:006-2] Rooms used for aerosolized pentamidine treatments or for aerosol treatments designed to induce sputum shall have negative air pressure and at least six changes of room air per hour, accomplished by exhaust ventilation.

D. [Formerly paragraph 19:007] Lighting and Wiring. Usable rooms and general areas of the building shall be lighted with a minimum of 20 foot-candles including rooms where food is prepared and handled. Emergency lighting shall be provided for surgery, delivery, nursery, emergency rooms, intensive care units and for patients requiring mechanical respirators, life support systems or monitoring equipment. Power outlets serviced by emergency power shall be distinguished from non-emergency outlets. The emergency generator shall be checked at least once weekly and records to insure proper operation and maintenance shall be kept for at least one year. Flash lights or battery operated lamps for emergency use shall be available at the nurses' station to hospital personnel and kept in operating condition.

E. [Formerly paragraph 19:008] Toilet Facilities. Each patient shall have access to a toilet room without entering the general corridor area. One toilet room shall serve no more than four beds and no more than two patient rooms. The toilet room shall contain a water closet and a lavatory. The lavatory may be omitted from a toilet room which serves single-bed and two-bed rooms if each such patient's room contains a lavatory. Toilet room air shall be filtered or mechanically exhausted to the outside. This room shall be equipped with hot and cold water under pressure with detergent or antiseptic scrub and individual towels. Toilet rooms shall be provided with waste receptacles which shall remain covered.

AUTHORITY NOTE: Promulgated in accordance with R.S. 40:4 (A)(2)(10) and R.S. 40:5 (1)(2)(3)(10)(17).

HISTORICAL NOTE: Promulgated by the Department of Health and Hospitals, Office of Public Health, LR 28:1393 (June 2002), repromulgated LR 29:1099 (July 2003).

Chapter 3. Operations and Maintenance

§301. General [formerly paragraph 19:003]

A. The building shall be in good repair, reflect good housekeeping and shall be free of insects and rodents and when necessary, dust control measures shall be employed. Equipment shall be clean and in good repair for the safety and well being of the patients and employees. Equipment should be properly disinfected or sterilized as required.

B. [Formerly paragraph 19:004] Employee health shall meet the requirements of Part I, §117 and Part II, §§501-503.C.

C. [Formerly paragraph 19:009] Housekeeping. An approved method of cleaning patient rooms, floors, and corridors shall be provided. Use EPA approved hospital grade disinfectant matched to local water conditions; dilute and apply according to manufacturer's directions. Separate cleaning equipment shall be provided for the food

preparation and storage area, operating rooms, and delivery rooms. Removable mop heads shall be provided for proper cleaning and disinfection. Wet vacuum operations are encouraged. A mop sink and a sufficient amount of storage area shall be provided to store all cleaning compounds and equipment.

D. [Formerly paragraph 19:010] Storage. There shall be clean storage space throughout the building for all supplies and equipment, which shall include provision for the safe separation of different items and located away from foot traffic and overhead contamination.

E. [Formerly paragraph 19:011] Water Supply. All water supplies shall conform to Part XII of this Code and to the federal drinking water standards. Approved emergency water supply shall be provided or made available in the event of internal or external disaster.

F. [Formerly paragraph 19:012] Food Service. The dietary unit of the hospital shall comply with all the provisions established in Part XXIII of this Code.

AUTHORITY NOTE: Promulgated in accordance with the provisions of R.S. 40:4(A)(10) and R.S. 40:5(3).

HISTORICAL NOTE: Promulgated by the Department of Health and Hospitals, Office of Public Health, LR 28:1394 (June 2002).

§303. Laundry [formerly paragraph 19:013]

A. Laundry Room. The clean and dirty laundry areas shall be separated to prevent cross-contamination. Hand-washing facilities shall be provided in each area. Personnel in dirty laundry rooms shall not perform duties in clean laundry rooms. The ventilation systems for the clean and dirty laundry rooms shall be separate. The clean laundry room shall have a positive air pressure and the dirty laundry rooms shall have a negative air pressure with respect to surrounding areas.

B. [Formerly paragraph 19:014] Laundry Movement and Storage. The facility shall make provisions and be responsible for the proper handling, cleaning, disinfection, and storage of linen and other washable items. Laundry carts shall be handled in a way as not to transmit communicable diseases from one section of the hospital to another and the carts shall be properly disinfected. Clean laundry shall be carried in clean carts only and be covered so as to prevent contamination en route. Disposable bags shall be used for the handling of contaminated items from isolation areas. Clean linens shall be placed in a clean bag or other suitable container. A commercial contract for such services with an outside vendor does not relieve the facility from ensuring that these conditions are met.

AUTHORITY NOTE: Promulgated in accordance with the provisions of R.S. 40:4(A)(10) and R.S. 40:5(3).

HISTORICAL NOTE: Promulgated by the Department of Health and Hospitals, Office of Public Health, LR 28:1394 (June 2002).

§305. Plumbing, Sewage, Garbage, and Waste
[formerly paragraph 19:015]

A. All plumbing shall be installed and maintained in a manner so as to comply with all local and state plumbing codes and regulations, including Part XIV of this Code. Approved equipment shall be provided for cleaning and sanitizing bedpans, if used for more than one patient.

B. [Formerly paragraph 19:016] Sewage shall be disposed of in accordance with Part XIII of this Code and with the Environmental Protection Agency (EPA) and Louisiana Department of Natural Resources (DNR) hazardous waste regulations.

C. [Formerly paragraph 19:017] Garbage and trash shall be stored and disposed of in accordance with Part XXVII of this Code and with DNR regulations. Compactors, dumpsters and other equipment shall be maintained in a sanitary condition.

D. [Formerly paragraph 19:018] Contaminated dressings, surgical, obstetrical and laboratory waste shall be incinerated or sterilized before burial in a landfill. Disposable needles and other "sharps" shall be placed in specifically labeled containers of sufficient thickness to prevent breakthrough and disposed of in an approved manner, preferable incineration.

AUTHORITY NOTE: Promulgated in accordance with the provisions of R.S. 40:4(A)(10) and R.S. 40:5(3).

HISTORICAL NOTE: Promulgated by the Department of Health and Hospitals, Office of Public Health, LR 28:1395 (June 2002).

§307. Patient Areas
[formerly paragraph 19:019]

A. All new facilities and those undergoing extensive renovation shall have no more than four beds per room in patient areas, excluding nurseries or intensive care units, and shall have at least one isolation room maintained under negative air pressure for every 30 adult beds.

B. [Formerly paragraph 19:020] Bathing Facilities. A tub or shower shall be provided at the ratio of 1 per 10 patients on each floor and conveniently located. Bathroom air shall be mechanically exhausted to the outside or filtered and be clean, disinfected and free of odors. Handgrips and non-slip mats shall be provided for tub and/or showers. Bathrooms fixtures shall meet the standards of Part XIV of this Code. Bath tub and/or shower shall be provided with hot and cold water delivered through a mixing valve.

C. [Formerly paragraph 19:021] All supplies and equipment used in patient care shall be properly cleaned and appropriately stored. They shall be disinfected between uses for different patients. Impervious material which can be readily cleaned and disinfected shall be used to cover beds and pillows. After discharge of a patient, the bed, bedside furniture and equipment shall be properly cleaned and terminally disinfected. Mattresses, blankets and pillows assigned to patients shall be in a sanitary condition. The blankets, towels, sheets and pillow cases used for a patient in

isolation shall be collected at the bedside in a double lined bag and taken immediately for laundering after each use.

D. [Formerly paragraph 19:022] Nursing stations shall be clean, have proper storage of medication, provide hand-washing facilities with hot and cold water, soap, towels and waste receptacles. Narcotics shall be stored under a double lock arrangement.

E. [Formerly paragraph 19:023] The handling and storage of ice for patient use shall conform with Part VI of this Code.

AUTHORITY NOTE: Promulgated in accordance with the provisions of R.S. 40:4(A)(10) and R.S. 40:5(3).

HISTORICAL NOTE: Promulgated by the Department of Health and Hospitals, Office of Public Health, LR 28:1395 (June 2002).

§309. Laboratory
[formerly paragraph 19:024]

A. Microbiological cultures shall be disposed of in an incinerator approved by the Air Permits Division of the DEQ or sterilized prior to disposal. Smoking and eating are not allowed in laboratory areas. Laboratories, especially horizontal work surfaces, shall be cleaned and disinfected at the end of each work day.

B. [formerly paragraph 19:025] Sterilizers of the proper type and necessary capacity for adequate sterilization shall be provided and maintained in a satisfactory condition. The hospital shall adopt a recognized method of verifying sterilizer performance and records shall be kept of the sterilizer operations for at least a year. Quality control of sterilization procedures shall include placement of indicators insuring that heat/time requirements have been met in package interiors and at least weekly live spore testing in steam sterilizers. Live spore testing shall be conducted for each load which is gas sterilized. A mechanism shall be employed for re-sterilizing outdated packs and recalling sterilized supplies in the event of a spore test failure. Clean and sterilized supplies shall be dated and kept separate from soiled and contaminated supplies and equipment.

C. [formerly paragraph 19:026] Blood bank refrigerators shall be kept clean and maintained at a temperature of 1°C to 6°C (33.8°F to 42.8°F), provided with an alarm and used for flood storage only. Time and temperature charts shall be maintained continuously and monitored and recorded daily. These records shall be maintained for at least a year. Alarm devices for refrigerators shall be provided.

AUTHORITY NOTE: Promulgated in accordance with the provisions or R.S. 40:4(A)(10) and R.S. 40:5(2)(3)(5)(15)(17)(20).

HISTORICAL NOTE: Promulgated by the Department of Health and Hospitals, Office of Public Health, LR 28:1395 (June 2002), amended LR 39:1055 (April 2013).

§311. Radiation Controls
[formerly paragraph 19:027]

A. All equipment and handled materials providing a source of radiation and disposal of radioactive waste shall be shielded as required by the Nuclear Division of DNR office of Environmental Affairs. All radiation equipment operators

shall be provided with the proper clothing and equipped with an approved radiation monitoring device. Certificates of registration shall be obtained from DNR's Nuclear Control Board and available for review.

B. [Formerly paragraph 19:028] Dressing rooms and toilet facilities shall be conveniently located for patients.

AUTHORITY NOTE: Promulgated in accordance with the provisions of R.S. 40:4(A)(10) and R.S. 40:5(3).

HISTORICAL NOTE: Promulgated by the Department of Health and Hospitals, Office of Public Health, LR 28:1395 (June 2002).

§313. Operating Rooms, Delivery Rooms, Intensive Care Units, Recovery, Nursery and Emergency Rooms
[formerly paragraph 19:029]

A. Only authorized and properly attired personnel shall be allowed into operating rooms, delivery rooms, recovery rooms, intensive care units and nurseries. Scrub suits for operation room and delivery rooms used should not be worn outside designated areas.

B. [Formerly paragraph 19:030] Operating room and delivery room shall be cleaned and disinfected between uses.

C. [Formerly paragraph 19:031] Adequate hand-washing facilities providing hot and cold running water equipped with mixing faucet, knee, foot, or elbow faucet control shall be provided in or adjacent to these areas. Hand-washing facilities shall not be located in, but rather adjacent to the operating room. Adequate supplies of antiseptic scrub material or detergent shall be maintained for these facilities at all times.

D. [Formerly paragraph 19:032] There shall be adequate provisions for washing instruments and equipment used in these areas. Sterilization procedures shall comply with the stipulation specified in the laboratory §§309-311.A of this Chapter.

E. [Formerly paragraph 19:033] The operating room shall be provided with safety electrical circuits, properly grounded, non-conductive floor surfaces, positive ventilation, and humidity control in accordance with federal construction and life safety standards.

F. [Formerly paragraph 19:034] Handling of equipment and surgical clothing shall be done so as to prevent cross-contamination with other areas.

G. [Formerly paragraph 19:035] Staff Facilities: A separate facility shall be provided for the staff of the operating room, delivery room and nursery. This facility shall include dressing rooms with toilet and lavatory facilities including hot and cold running water, detergent or antiseptic scrub, individual towels and waste receptacles.

AUTHORITY NOTE: Promulgated in accordance with the provisions of R.S. 40:4(A)(10) and R.S. 40:5(3).

HISTORICAL NOTE: Promulgated by the Department of Health and Hospitals, Office of Public Health, LR 28:1396 (June 2002).

§315. Nursery
[formerly paragraph 19:036]

A. A maximum of 24 infants stations shall be allowed in each full-term nursery room. The nursery shall be maintained at a temperature of approximately 75°F (24°C) and 30-60 percent relative humidity. The nursery shall have a reliable thermometer with records of daily temperatures maintained. Separate nursery rooms shall be provided for well and sick babies. There shall be a suitable designated area for staff hygiene and gowning.

B. [Formerly paragraph 19:037] There shall be a suitable, designated area for the preparation of milk mixtures. This area shall be equipped with a sink, hand-washing facilities and storage space. This sink and lavatory shall be equipped with foot, knee or elbow faucet control with hot and cold water dispensed through a mixing valve.

C. [Formerly paragraph 19:038] Infant formula and other fluids requiring heat sterilization shall be prepared by terminal heat method in a separate room. This is a process by which the completely assembled formula units (bottles filled with formula, with nipples applied and covered with nipple protectors) are exposed to a minimum of 230°F (110°C) for 10 minutes in order to achieve pasteurization.

D. [Formerly paragraph 19:039] The individually bottled formula shall be stored in a refrigerator, specifically designated for that purpose, equipped with a thermometer. The temperature shall be maintained at 40° to 45°F (4° to 7°C).

AUTHORITY NOTE: Promulgated in accordance with the provisions of R.S. 40:4(A)(10) and R.S. 40:5(3).

HISTORICAL NOTE: Promulgated by the Department of Health and Hospitals, Office of Public Health, LR 28:1396 (June 2002).

§317. Respiratory/Physical Therapy Rooms
[formerly paragraph 19:040]

A. These areas shall be clean at all times and free of materials or equipment not needed to carry out the function required by the respective units. Accommodation shall be made to handle patients under isolation requiring such therapy. Respiratory and hydrotherapy equipment shall be cleaned and disinfected as needed after each use.

AUTHORITY NOTE: Promulgated in accordance with the provisions of R.S. 40:4(A)(10) and R.S. 40:5(3).

HISTORICAL NOTE: Promulgated by the Department of Health and Hospitals, Office of Public Health, LR 28:1396 (June 2002).

§319. Morgue
[formerly paragraph 19:041]

A. The mortuary table shall be cleaned and disinfected after each use and kept in good repair. A check valve shall be provided in the water supply line upstream from the control valve. A vacuum breaker or siphon breaker of an approved type shall be installed in the water supply line at least 6 inches (15 cm) higher than the aspirator and downstream from the control valve. The aspirator shall be installed at least 6 inches (15 cm) above the highest level at which suction may be taken. An air gap equal to at least one pipe

diameter shall be provided between the outlet of the discharge pipe and the overflow rim of the receiving fixture.

B. [Formerly paragraph 19:042] The cold storage vaults shall be clean and in good repair, maintained at less than 45°F (7°C) and used for no other purpose.

AUTHORITY NOTE: Promulgated in accordance with the provisions of R.S. 40:4(A)(10) and R.S. 40:5(3).

HISTORICAL NOTE: Promulgated by the Department of Health and Hospitals, Office of Public Health, LR 28:1396 (June 2002).

Chapter 5. General Standards

§501. Space and Bed Standards [formerly paragraph 19:043]

A. The following space and bed guidelines shall be provided for specific patient care areas.

1. Adult Patient Room
 - a. 4 beds per room maximum;
 - b. 100 sq. ft. (9.29 sq. m.) for single room;
 - c. 80 sq. ft. (7.43 sq. m.) per bed for multi-bed rooms;
 - d. 3'8" (1.12 m.) minimum clearance at foot of bed in multi-bed rooms.
2. Adult Intensive Care Unit
 - a. 120 sq. ft. (11.15 sq. m.) for single bed rooms or Intensive Care Unit Cubicles;
 - b. 7'10" (2.13 m.) clearance between beds.
3. Obstetrical Care—Levels I, II, and III*
 - a. Labor Room
 - i. **Minimum of 140 sq. ft. per private room
 - ii. **Minimum of 100 sq. ft. for each bed in multiple-bed rooms
 - b. Delivery Room
 - i. **Minimum of 350 sq. ft. of floor space
4. Neonatal Care (Nursery)
 - a. Levels I and II*
 - i. **Maximum of 24 bassinets per nursery room
 - ii. **Minimum of 2 feet between bassinets
 - iii. Minimum of 20 sq. ft. per infant in normal newborn area
 - iv. **Minimum of 40 sq. ft. per infant in admission-observation area
 - b. Level III* (Newborn Intensive Care)
 - i. **Minimum of 6 ft. between bassinets or incubators
 - ii. Minimum of 80 sq. ft. per infant

*Note: Levels are defined in the following document: "Obstetrical and Neonatal Guidelines Regionalization of Perinatal Care in the State of Louisiana," Commission on Perinatal Care, February, 1980, amended February 1982.

**Note: These standards conform to the new guidelines recommended by the American Academy of Pediatrics and the American College of Obstetricians and Gynecologists in "Guidelines for Perinatal Care," 1983.

5. Pediatrics

a. 6 cribs/beds maximum per room for pediatric/adolescent room;

b. 60 sq. ft. (5.57 sq. m.) per cribs/beds.

6. Out Patient

a. 80 sq. ft. (7.43 sq. m.) for general and special exam rooms;

b. 120 sq. ft. (11.15 sq. m.) for out patient treatment rooms.

7. Operating Room

a. 360 sq. ft. (33.45 sq. m.) per room.

8. Cystoscopy-Type Room

a. 250 sq. ft. (23.23 sq. m.) per room.

B. [Formerly paragraph 19:044] Present Enforceable Standards with which Hospitals Must Comply Include the Following Parts from This Code

1. Part II. The Control of Diseases
2. Part V. Disease Vector Control
3. Part VII. Milk, Milk Products, and Manufactured Milk Products
4. Part VIII. Frozen Desserts
5. Part IX. Seafood (Marine and Freshwater Animal Food Products)
6. Part XII. Water Supplies
7. Part XIII. Sewage Disposal
8. Part XIV. Plumbing
9. Part XXIII. Retail Food Establishments
10. Part XXVI. Burial, Transportation, Disinterment or other Disposition of Dead Human Bodies

AUTHORITY NOTE: Promulgated in accordance with the provisions of R.S. 40:4(A)(10) and R.S. 40:5(3).

HISTORICAL NOTE: Promulgated by the Department of Health and Hospitals, Office of Public Health, LR 28:1396 (June 2002).

Title 51
PUBLIC HEALTH—SANITARY CODE
Part XX. Nursing Homes

Chapter 1. General Sanitary Provisions for Nursing Homes

§101. Definitions
[formerly paragraph 20:001]

A. Unless otherwise specifically provided herein, the following words and terms used in this Part of the sanitary code and all other Parts which are adopted or may be adopted are defined for the purposes thereof as follows.

Nursing Home—a private home, institution, building, residence or other place, serving three or more persons who are not related by blood or marriage to the operator, whether operated for profit or not, and including those places operated by a political subdivision of the state of Louisiana which undertakes, through its ownership or management, to provide maintenance, personal care, or nursing for persons who, by reason of illness or physical infirmity or age, are unable to properly care for themselves. The term does not include the following:

a. a hospital, sanitarium or other institution whose principal activity or business is the care and treatment of persons suffering from tuberculosis or from mental disease;

b. a hospital, sanitarium or other medical institution whose principal activity or business is the diagnosis, care and treatment of human illness through the maintenance and operation of organized facilities therefor.

AUTHORITY NOTE: The first source of authority for promulgation of the sanitary code is in R.S. 36:258(B), with more particular provisions throughout Chapters 1 and 4 of Title 40 of the Louisiana Revised Statutes. This Part is promulgated in accordance with the provisions of R.S. 40:4(A)(10) and R.S. 40:5.

HISTORICAL NOTE: Promulgated by the Department of Health and Hospitals, Office of Public Health, LR 28:1397 (June 2002).

§103. Advance Approval of New Construction or Major Alteration of Existing Nursing Homes is Mandatory
[formerly paragraph 20:002]

A. No new nursing home shall hereafter be constructed nor shall major alterations be made to existing nursing homes without the prior approval or, and unless in accordance with plans and specifications approved in advance by, the state health officer.

AUTHORITY NOTE: Promulgated in accordance with the provisions of R.S. 40:4(A)(10) and R.S. 40:5.

HISTORICAL NOTE: Promulgated by the Department of Health and Hospitals, Office of Public Health, LR 28:1397 (June 2002).

§105. Heating, Cooling, and Ventilating Systems
[formerly paragraph 20:003]

A. [Formerly paragraph 20:003] All homes shall be provided with heating equipment adequate to maintain, in every room used by patients, a temperature of not less than 76 degrees Fahrenheit in the coldest weather. Each room having a bathtub, or shower, or toilet shall have a heater, or a duct to it from a heating system. The combustion chambers of all heating systems, and other fired equipment shall be vented to the atmosphere. Other parts of the heating, cooling, and ventilating system shall be so designed, built, and maintained as to ensure that the pressure in the space from which combustion air is drawn does not become negative with respect to the atmosphere.

B.1. [Formerly paragraph 20:003-1] Persons with tuberculosis in a communicable state or suspected of having tuberculosis in a communicable state shall be cared for in isolation rooms with negative air pressure and either:

a. at least six changes of room air per hour accomplished by exhaust ventilation; or

b. equivalent circulation and treatment by ultraviolet light treatment, "air scrubber", or equivalent.

2. If the patient is not in a room with proper ventilation and is unable or unwilling to cover their cough, then exposed persons shall wear proper masks, which filter all particles larger than 1 micron, in order to prevent the spread of infectious respiratory droplets.

AUTHORITY NOTE: Promulgated in accordance with R.S. 40:4(A)(2)(10) and R.S. 40:5(1)(2)(3)(10)(17).

HISTORICAL NOTE: Promulgated by the Department of Health and Hospitals, Office of Public Health, LR 28:1398 (June 2002), repromulgated LR 29:1100 (July 2003).

§107. Building Conditions
[formerly paragraph 20:004]

A. All homes shall be structurally sound, and shall be maintained in good condition.

B. [Formerly paragraph 20:005] Stairs shall be provided where needed which may be easily used by the patients. Stair treads shall have non-slip surfaces.

C. [Formerly paragraph 20:006] Every occupied room shall have a smooth floor, walls, and ceilings in good repair and so finished as to enable satisfactory cleaning.

D. [Formerly paragraph 20:007] All rooms shall be provided with adequate illumination to provide: (a) a minimum of 10 foot-candles over the entire stairway, halls, and occupied rooms at an elevation of 30 inches above the floor; and (b) a minimum of 30 foot-candles over areas used for reading or close work.

AUTHORITY NOTE: Promulgated in accordance with the provisions of R.S. 40:4(A)(10) and R. S. 40:5.

HISTORICAL NOTE: Promulgated by the Department of Health and Hospitals, Office of Public Health, LR 28:1398 (June 2002).

§109. Bedding Requirements
[formerly paragraph 20:009]

A. Each patient shall be provided with an individual bed which shall be equipped with clean bed linens. Moisture-proof covers and rubber sheets shall be provided as necessary to keep mattress and pillows dry. Provisions shall be made when necessary for laundering household linens and personal clothing of patients.

B. [Formerly paragraph 20:008] Each patient's bedroom shall have windows opening to the outside atmosphere.

AUTHORITY NOTE: Promulgated in accordance with the provisions of R.S. 40:4(A)(10) and R. S. 40:5.

HISTORICAL NOTE: Promulgated by the Department of Health and Hospitals, Office of Public Health, LR 28:1398 (June 2002).

§111. Bathroom Requirements
[formerly paragraph 20:010-1]

A. Every nursing home shall have toilets, lavatories and bathtubs or showers on each floor occupied by patients. There shall be one lavatory in each room, or immediately adjacent thereto, one toilet for each eight patients and one tub or shower for each 10 patients. In nursing homes built and operating as such prior to May 21, 1974, there shall be at least one toilet and lavatory for each 10 patients and one bathtub or shower for each 15 patients.

B. [Formerly paragraph 20:010-2] There shall be bedpans and urinals in sufficient number for patients needing them and facilities for sanitization thereof are required. There shall be a clinic service sink with flush rim or a water closet with bedpan lugs, and a bedpan washing attachment with a foot operated valve for washing and a deep sink suitable for immersing the bedpans in a sanitizing solution. The equipment shall be in the soiled utility area or a separate room with a safe storage place for chemicals and a rack for draining and storing the bedpans.

C. [Formerly paragraph 20:010-3] Bathrooms shall be easily accessible, conveniently located, well lighted and ventilated to the outside atmosphere. The fixtures shall be of substantial construction, in good repair, and of such design to enable satisfactory cleaning.

D. [Formerly paragraph 20:010-4] Tub and shower bath bottoms shall be of non-slip material. Grab bars shall be provided to prevent falling and to assist in getting in and out of the tub or shower.

E. [Formerly paragraph 20:010-5] Lights shall be controlled by wall switches, which shall be so placed that they cannot be reached from the bathtub or shower.

F. [Formerly paragraph 20:010-6] Institutional type grab bars shall be provided at all patient water closets.

AUTHORITY NOTE: Promulgated in accordance with the provisions of R.S. 40:4(A)(10) and R. S. 40:5.

HISTORICAL NOTE: Promulgated by the Department of Health and Hospitals, Office of Public Health, LR 28:1398 (June 2002).

§113. Nurses' Station
[formerly paragraph 20:011]

A. A nurses' station shall be provided and shall include a sink, adequate work space, and storage for medicine.

AUTHORITY NOTE: Promulgated in accordance with the provisions of R.S. 40:4(A)(10) and R. S. 40:5.

HISTORICAL NOTE: Promulgated by the Department of Health and Hospitals, Office of Public Health, LR 28:1398 (June 2002).

§115. Sanitary Provisions for Food
[formerly paragraph 20:012]

A. Food preparation, storage and service shall meet the requirements of Part XXIII of this Code.

AUTHORITY NOTE: Promulgated in accordance with the provisions of R.S. 40:4(A)(10) and R. S. 40:5.

HISTORICAL NOTE: Promulgated by the Department of Health and Hospitals, Office of Public Health, LR 28:1398 (June 2002).

§117. Water Supply
[formerly paragraph 20:013]

A. The water supply shall meet the requirements of Part XII of this Code.

AUTHORITY NOTE: Promulgated in accordance with the provisions of R.S. 40:4(A)(10) and R. S. 40:5.

HISTORICAL NOTE: Promulgated by the Department of Health and Hospitals, Office of Public Health, LR 28:1398 (June 2002).

§119. Sewage and Waste Disposal
[formerly paragraph 20:014]

A. Sewage and waste disposal shall meet the requirements of Part XIII of this Code.

AUTHORITY NOTE: Promulgated in accordance with the provisions of R.S. 40:4(A)(10) and R. S. 40:5.

HISTORICAL NOTE: Promulgated by the Department of Health and Hospitals, Office of Public Health, LR 28:1399 (June 2002).

§121. Plumbing
[formerly paragraph 20:015]

A. Plumbing shall meet the requirements of Part XIV of this Code.

AUTHORITY NOTE: Promulgated in accordance with the provisions of R.S. 40:4(A)(10) and R. S. 40:5.

HISTORICAL NOTE: Promulgated by the Department of Health and Hospitals, Office of Public Health, LR 28:1399 (June 2002).

§123. Employee and Patient Health Provisions
[formerly paragraph 20:016]

A. Employee and patient health shall meet the requirements of Part 1, §117 and Part II, §§501-505 of this Code.

AUTHORITY NOTE: Promulgated in accordance with the provisions of R.S. 40:4(A)(10) and R. S. 40:5.

HISTORICAL NOTE: Promulgated by the Department of Health and Hospitals, Office of Public Health, LR 28:1399 (June 2002).

Title 51
PUBLIC HEALTH—SANITARY CODE
Part XXI. Day Care Centers and Residential Facilities

Chapter 1. General Requirements

§101. Definitions
[formerly paragraph 21:001]

A. Unless otherwise specifically provided herein, the following words and terms used in this Part and all other Parts which are adopted or may be adopted, are defined for the purpose thereof as follows.

Adult Day Care Center—any place or facility, operated by any person for the primary purpose of providing care, supervision and guidance of 10 or more people 18 years and older, not related to the caregiver and unaccompanied by parent or guardian, on a regular basis, for a total of at least 20 hours in a continuous seven day week in a place other than the person's home.

Child—a person who has not reached age 18 or otherwise been legally emancipated.

Child Day Care Center—any place or facility operated by any *institution*, political subdivision, society, agency, corporation, person or persons, or any other group for the purpose of providing care, supervision, and guidance of seven or more children, not including those related to the caregiver, unaccompanied by parent or legal custodian, on a regular basis for at least twelve and one-half hours in a continuous seven-day week. If a child day care center provides transportation or arranges for transportation to and from the center, either directly or by contract with third parties, all hours during which a child is being transported shall be included in calculating the hours of operation. A child day care center that remains open for more than twelve and one-half hours in a continuous seven-day week, and in which no individual child remains for more than twenty-four hours in one continuous stay shall be known as a full-time child day care center. A child day care center that remains open after 9 p.m. shall meet the regulations established for nighttime care.

Day Care Center—includes adult day care center, and early learning center.

Early Learning Center—any child day care center, early head start center, head start center, or stand-alone prekindergarten program not attached to a school.

Food Preparation—any activity in which food or beverages (other than pre-packaged individual servings) are cooked, processed, mixed, unpackaged or otherwise handled for service to the staff and clients of a care facility.

Head Start and Early Head Start Programs—the federally-funded early childhood care and education programs that promote and teach school readiness to

children ages *birth* to five years of age from low-income families and provide services in the areas of education, social services for families, nutrition, family engagement, health and mental health, as well as providing the physical plant and instructional staff members for such purposes.

Infant—any child under the age of 12 months.

Preschool—any child less than five years of age.

Residential Facility—any place, facility, or home operated by any person who receives therein four or more people who are not related to such person for supervision, care, lodging and maintenance with or without transfer of custody. This shall include, but not be limited to group homes, community homes, maternity homes, juvenile detention centers, emergency shelters, halfway homes and schools for the mentally retarded.

Suitable Barrier—any gate or other device designed to exclude children which is non-climbable and not easily opened by children, with openings in the barrier no greater than 3 1/2 inches to prevent entrapment. Pantograph-type gates shall not be permitted.

AUTHORITY NOTE: The first source of authority for promulgation of the sanitary code is in R.S. 36:258(B), with more particular provisions found in Parts 1 and 4 of Title 40 of the Louisiana Revised Statutes. This Part is promulgated in accordance with the specific provisions of R.S. 40:4(A)(10), R.S. 40:5, and R.S. 40:31.15.

HISTORICAL NOTE: Promulgated by the Department of Health and Hospitals, Office of Public Health, LR 28:1399 (June 2002), amended by the Department of Health, Office of Public Health, LR 46:591 (April 2020).

§103. Plans and Specifications
[formerly paragraph 21:002]

A. No new facilities for institutions covered by this Part, shall hereafter be constructed nor shall major alterations be made to such existing facilities without the prior written approval of, and unless in accordance with plans and specifications approved in advance by, the state health officer.

AUTHORITY NOTE: Promulgated in accordance with the provisions of R.S. 40:4(A)(10) and R.S. 40:5.

HISTORICAL NOTE: Promulgated by the Department of Health and Hospitals, Office of Public Health, LR 28:1399 (June 2002).

§105. General
[formerly paragraph 21:002-1]

A. Facilities applying for license after the effective date of this Part shall meet all of the requirements contained herein. Facilities licensed or with pending applications prior to the effective date shall be allowed 36 months from the

effective date to comply with the following Sections: 105.C.5.a, 105.C.5.c, as regards temperature control; 105.C.5.d, 105.E.1, 105.F, 501.A, and 501.C as regards opening-sizes, heights and gates; 501.D. Facilities licensed or with pending applications prior to the effective date shall be allowed 12 months from the effective date to comply with the following Sections: 103.H.2 and 301.A.9. Such facilities shall comply with all other requirements of this Part on the effective date.

B. [Formerly paragraph 21:002-2] This Part shall become effective on April 1, 1993.

C. [Formerly paragraph 21:003] All of the above facilities shall comply with appropriate Parts of this Code as stated below.

1. [Formerly paragraph 21:003-1] Employee, patient, and client health shall meet the requirements of Part I, §117 and Part II, §§113, 503, and 505 of this Code.

2. [Formerly paragraph 21:003-2] Child day care centers and residential facilities for children and the mentally retarded shall meet the requirements of Part IV of this Code.

3. [Formerly paragraph 21:003-3] Water supplies shall meet the requirements of Part XII of this Code.

4. [Formerly paragraph 21:003-4] Sewage disposal shall meet the requirements of Part XIII of this Code.

5. [Formerly paragraph 21:003-5] Plumbing shall meet the requirements of Part XIV of this Code with the following additional provisions.

a. In child day care facilities, toilets (water closets) and lavatories shall be provided in accordance with Table 411 of Part XIV. Fixtures shall be of size appropriate for the age of children being cared for (toilets 11 inches maximum height and lavatories 22 inches maximum height), or if standard size fixtures are used, safe, cleanable step aids shall be provided.

b. Handwashing and bathing facilities shall be provided with hot and cold running water. Where such water will be in direct contact with children, the temperature shall not exceed 120°F utilizing an approved temperature control device(s) as required under LAC 51:XIV.623.

c. Residential facilities housing six residents or less may provide plumbing fixtures as a single family residence. All others must provide plumbing as required for dormitories in accordance with Table 411 of Part XIV.

D. [Formerly paragraph 21:004] Toilet training chairs shall be of a type which is easily cleaned and sanitized. Training "potties" shall be cleaned and disinfected, immediately after each use, in a mop/utility sink or other plumbing fixture dedicated solely to that purpose, the waste being disposed of in a flushing toilet. They shall be stored in the toilet room and be accessible to children only under direct supervision. Training chairs shall not be counted as toilets in the toilet-child ratio.

E. [Formerly paragraph 21:005] Heating, cooling and ventilation shall meet the following requirements.

1. [Formerly paragraph 21:005-1] A draft free temperature of 65°F to 75°F shall be maintained during the cooler months (November-March) and a draft free temperature of 68°F to 82°F shall be maintained during the warmer months (April-October).

2. [Formerly paragraph 21:005-2] The combustion chambers of all heaters, heating systems, and other fired equipment shall be vented to the atmosphere. Other parts of the heating, cooling, and ventilating system shall be so designed, built, and maintained as to ensure that the pressure in the space from which combustion air is drawn does not become negative with respect to the atmosphere.

F. [Formerly paragraph 21:006] In day care centers, the following illumination levels shall be maintained (all measurements to be made 3 feet above the floor): Minimum of 50 foot-candles in all work and play areas; minimum of 10 foot-candles in hallways, stairs, toilet rooms; maximum of 5 foot-candles in any area during napping or sleeping.

G. [Formerly paragraph 21:006-1] Shielded light fixtures or shatterproof bulbs shall be utilized in food preparation areas and in areas designated for children less than two years of age.

H. [Formerly paragraph 21:007] Bedding shall meet the following standards.

1. [Formerly paragraph 21:007-1] Each bed in every residential facility shall be separated, vertically and horizontally, by at least 28 inches. In day care centers, cribs, cots, and mats used for napping shall be separated by at least 18 inches with a head to foot arrangement so that no two children's heads are adjacent.

2. [Formerly paragraph 21:007-2] Cribs shall meet current federal safety standards, and industry voluntary standards. Spaces between slats shall be no more than 2 3/8 inches. Mattresses shall be of standard size so that they fit the crib frame without gaps of more than 1/2 inches. Cribs shall not be used with the drop side down. There shall be no corner post extensions (over 1/16 inch) or cutouts in the headboards.

3. [Formerly paragraph 21:007-3] Stacked cribs shall not be used.

4. [Formerly paragraph 21:007-4] Bedding such as cots, beds, cribs, or floor pads (mats) shall be maintained in a safe and sanitary manner. Linens, if provided with bedding, shall be changed when soiled and between each use by different persons. These sheets shall be changed and laundered routinely at least once each week and blankets at least once each month and immediately when soiled.

I. [Formerly paragraph 21:008] The food preparation area in day care centers and residential facilities shall meet the following.

1. [Formerly paragraph 21:008-1] Where seven or more individuals are cared for, food preparation, storage and

handling shall meet all the requirements of Part XXIII of this Code, with the following exception: where the number of individuals cared for is between 7 and 15, the following may be provided: either a three-compartment sink as required in Part XXIII of this Code or an approved domestic or commercial type dishwashing machine and a two-compartment sink with hot and cold running water under pressure to each compartment.

2. [Formerly paragraph 21:008-2] Food preparation, storage and handling where six or less individuals are cared for may provide a "home-type" setting with the following: approved potable water supply, approved sewage disposal, a two-compartment sink with hot and cold running water under pressure to each compartment and an approved domestic type dishwasher, plumbing installed in accordance with Part XIV, adequate dry storage space for food and a refrigerator capable of maintaining a temperature below 45°F.

3. [Formerly paragraph 21:008-3] Children shall be excluded by a suitable barrier from the food preparation area.

4. [Formerly paragraph 21:008-4] In facilities where the provision of food by clients is permitted by state regulations, food brought into the facility shall have a label showing client's name and the identity of the food. Perishable food shall be refrigerated at 45°F or below. Thermometer shall be provided in each refrigerator. All foods shall be protected against contamination.

J. [Formerly paragraph 21:009] The serving and/or use of milk or milk products shall conform with the following.

1. Only Grade A pasteurized milk shall be served and dispensed at day care centers and residential facilities. The milk shall be dispensed from a bulk milk container dispensing device that conforms with 3-A Standards. In lieu thereof, milk may be served by providing a commercially filled container of one pint capacity or less to each child, and/or client.

EXCEPTION: In facilities licensed for 30 or less children or clients, the state health officer may allow milk to be served from commercially filled containers with a capacity of not greater than one gallon.

2. The serving of reconstituted milk is prohibited except in making instant desserts, whipped products, or for cooking and baking purposes, as stated in Part XXIII, §1707.

AUTHORITY NOTE: Promulgated in accordance with the provisions of R.S. 40:4(A)(10) and R.S. 40:5.

HISTORICAL NOTE: Promulgated by the Department of Health and Hospitals, Office of Public Health, LR 28:1399 (June 2002), amended LR 37:2728 (September 2011), amended LR 38:2926 (November 2012), repromulgated LR 38:3233 (December 2012), amended LR 41:2657 (December 2015).

Chapter 3. Child Day Care Centers

§301. General Standards [formerly paragraph 21:010]

A. Written policies and procedures regarding infection control practices and disease prevention shall be developed by each center which include the following.

1. [Formerly paragraph 21:010-1] Staff and children shall wash their hands at least at the following times: upon entering the center, before preparing or serving meals, after toileting or changing diapers, before and after eating meals or snacks, and anytime hands become soiled with body fluids (urine, stool, saliva, blood, nasal discharge).

2. [Formerly paragraph 21:010-2] Procedures shall ensure that staff teach use of running water, soap, and single use of disposable towels. Hands shall be washed and scrubbed for at least 10 seconds with soap and running water. Warm running water in sinks is required.

3. [Formerly paragraph 21:010-3] Weekly monitoring by the center director shall ensure that handwashing and cleaning procedures are followed as specified in the center's plan.

4. [Formerly paragraph 21:010-4] Noses shall be blown or wiped with disposable, one-use tissues that are discarded in a plastic-lined and covered garbage container.

5. [Formerly paragraph 21:010-5] Draining or oozing cuts or sores shall be covered.

6. [Formerly paragraph 21:010-6] Child care personnel shall adopt routine procedures for handling blood and blood-containing fluids and wound exudates of all children in the center.

a. For spills of vomitus, urine, and feces, floors, walls, bathrooms, table tops, toys, kitchen counter tops, and diaper-changing tables shall be cleaned and disinfected.

b. For spills of blood or blood-containing body fluids and injury and tissue discharges, the area shall be cleaned and disinfected. Gloves shall be used in these situations unless the amount of blood or body fluid is so small that it can easily be contained by the material used for cleaning.

c. Persons involved in cleaning contaminated surfaces avoid exposure of open skin sores or mucous membranes to blood or blood-containing body fluids and injury or tissue discharges by using gloves to protect hands when cleaning contaminated surfaces.

d. Mops shall be cleaned, rinsed in sanitizing solution and then wrung as dry as possible and hung to dry.

e. Blood-contaminated material and diapers shall be disposed of in a plastic bag with a secure tie.

7. [Formerly paragraph 21:010-7] The day care center director shall exclude from care any child with the following illnesses or symptoms based on potential contagiousness of the disease. Periods may be extended beyond this depending upon individual conditions.

Illness/Symptom	Exclude Until
Meningococcal disease (<i>Neisseria meningitidis</i>)	Well and proof of non-carriage ¹
Hib disease (<i>Haemophilus influenza</i>)	Well and proof of non-carriage ¹
Diarrhea (two or more loose stool, or over and above what is normal for that child)	Diarrhea resolved or is controlled (contained in diaper or toilet)
Fever of unknown origin (100°F oral or 101 rectal or higher) and some behavioral signs of illness	Fever resolved or cleared by child's physician/health department
Chicken pox	Skin lesions (blisters) all scabbed over
Hepatitis A	One week after illness started and fever resolved
AIDS (or HIV infection)	Until child's health, neurologic development, behavior, and immune status is deemed appropriate (on a case-by-case basis) by qualified persons, including the child's physician ² chosen by the child's parent, guardian and the center director
Undiagnosed generalized rash	Well or cleared by child's physician as non-contagious
Any child with a sudden onset of vomiting, irritability or excessive sleepiness	Evaluated and cleared by child's physician

a. ¹Proof of non-carriage: Either by completion of appropriate drug regimen of Rifampin (two-day course for Meningococcal disease or four-day course for Hib disease) or by a negative throat culture obtained after completion of treatment for meningitis.

b. ²These persons should include the child's physician and other qualified individuals such as the center director, a representative from the Office of Public Health, and a child development specialist, and should be able to evaluate whether the child will receive optimal care in the specific program being considered and whether an HIV-infected child poses a potential threat to others.

c. With most other illnesses, children have either already exposed others before becoming obviously ill (e.g., colds) or are not contagious one day after beginning treatment (e.g., strep throat, conjunctivitis, impetigo, ringworm, parasites, head lice, and scabies). The waiting periods required after the onset of treatment vary with the disease. Check with your local health department for information on specific diseases. Children who are chronic carriers of viral illnesses such as cytomegalovirus (CMV) and Herpes simplex can and should be admitted to day care centers.

d. The parent or designated person shall be notified as soon as possible if a child develops symptoms of illness or suffers an accident while in care.

8. [Formerly paragraph 21:010-8] Guidelines shall be developed regarding biting behavior, treatment of bites, and notification to parents of the children (if injury requires first aid or medical attention).

9. [Formerly paragraph 21:010-9] Each child care employee shall receive a total of three hours of training per year on infectious diseases, health and safety, and/or food

service preparation. Whenever possible, this training should be provided during regular working hours.

B. [Formerly paragraph 21:011] Indoor environmental surfaces associated with children's activities and objects handled by children shall be cleaned when soiled and at least on the following basis.

1. Table tops and objects handled by children such as washable toys shall be cleaned at least once weekly. Items that children may place in their mouths shall be washed and sanitized at least daily. Soft, non-washable toys shall be limited to personal use items brought from home that are not shared between children.

2. All walls and ceilings shall be of a color that readily shows soil. Walls, ceilings, and other surfaces shall be maintained in good repair and in a clean condition; not able to visibly contaminate cold rinse water.

3. Floors, except those carpeted, shall be vacuumed or swept, and mopped with a disinfecting solution at least daily and when soiled. Soiled mop water shall be disposed of immediately after use. Stored mops shall be hung.

4. Carpeted floors and large throw rugs which cannot be washed, shall be vacuumed at least daily and shampooed at least every three months and when soiled.

5. Toilet rooms and fixtures shall be cleaned and disinfected at least daily and shall be in good repair. Toilet rooms shall have walls, floors and ceilings of a smooth, easily cleanable finish, and shall be painted a light color. These rooms must be ventilated by means of a ventilation system in compliance with Part XIV.

6. Potty chairs and diaper changing surfaces shall be cleaned and disinfected after each use.

7. Any object or surface contaminated by bodily fluids (e.g., urine, feces, blood, wound or tissue exudate) shall be cleaned immediately and disinfected with a fresh solution of household bleach diluted 1/4 cup in 1 gallon of water made fresh every 24 hours.

8. Soap and separate paper towels will be provided at handwashing sinks.

C. [Formerly paragraph 21:012] Coat hooks spaced at least 12 inches apart, or individual cubicles or lockers, child's height shall be provided for storage of clothing and personal possessions of the children.

D. [Formerly paragraph 21:013] All areas accessible to children shall be free of toxic or hazardous materials and conditions.

1. [Formerly paragraph 21:013-1] Cleaning materials, detergents, aerosol cans, pesticides, health and beauty aids, poisons, and other toxic materials shall be stored in their original labeled containers and shall be used only in a manner that will not contaminate play surfaces, food, food preparation areas, or constitute a hazard to the children. When not in actual use, such materials shall be kept in a locked place inaccessible to children and stored separately from medications and food. Matches and lighters shall be inaccessible to children.

2. [Formerly paragraph 21:013-2] All medications will be kept in a locked cabinet.

3. [Formerly paragraph 21:013-3] Poisonous or potentially harmful plants on the premises shall be inaccessible to children.

4. [Formerly paragraph 21:013-4] No pets shall be maintained on the premises except aquarium fish if they are kept out of the reach of children, or animals to aid the disabled.

5. [Formerly paragraph 21:013-5] Electrical outlets accessible to the children shall be covered with child resistant covers or be of the child-proof type.

6. [Formerly paragraph 21:013-6] All stair cases must be provided with suitable barriers to prevent access by children. All porches and decks where children are allowed to play must be provided with suitable barriers to prevent falls.

7. [Formerly paragraph 21:013-7] Smoking shall not be permitted in indoor areas of the child care facility.

8. [Formerly paragraph 21:013-8] Premises shall be maintained free of insect, rodent or other pest infestations or haborages. Application of any pesticide shall not be done when children are present. No restricted use pesticides shall be stored or used on the premises unless by properly licensed persons.

9. [Formerly paragraph 21:013-9] Open containers such as mop buckets shall not be left unattended.

E. [Formerly paragraph 21:014] Openings to the outside shall be protected against the entrance of flies or other flying insects by outward opening, self-closing doors, closed windows, screening or other effective and approved means.

F. [Formerly paragraph 21:015] Each foundation, floor, wall, ceiling, roof, window, exterior door, and basement shall be free from openings which may permit the entry of rodents.

G. [Formerly paragraph 21:016] Each center shall be provided with a designated area for the care of a child who needs to be separated from the group due to injury, illness or the need for additional rest. This area shall be located so the child may be supervised. Toilet and lavatory facilities shall be readily accessible. If the child under care is suspected of having a communicable disease, all equipment used by the child shall be cleaned and sanitized after use. This area may be used for other purposes when not needed for the separation and care of a child or if the uses do not conflict.

H. [Formerly paragraph 21:017] All formula bottles for those children still on bottles must be properly designated with the particular child's name attached to the bottle. These formulas are to be brought in bottles with caps and tops and shall immediately be placed under refrigeration by the operator. When bottles are emptied, they must be promptly cleaned and any bottles to be reused must be properly sterilized.

I. [Formerly paragraph 21:018] In child care centers, infants shall be cared for in an area separated by a suitable barrier from older children. Activities which bring infants and older children in contact with each other shall be limited.

AUTHORITY NOTE: Promulgated in accordance with the provisions of R.S. 40:4(A)(10) and R.S. 40:5.

HISTORICAL NOTE: Promulgated by the Department of Health and Hospitals, Office of Public Health, LR 28:1401 (June 2002).

§303. Diaper Changing Areas [formerly paragraph 21:019]

A. A diaper changing table shall be provided in those centers that accept children in that age group. Children shall be diapered or have soiled underwear changed in the diaper changing area. The changing area shall never be located in food preparation areas and shall never be used for temporary placement of food.

B. [Formerly paragraph 21:019-1] Changing tables shall have an impervious surface and be kept in good repair. Tables shall be sturdy, adult-height, and shall be equipped with railings.

C. [Formerly paragraph 21:019-2] Changing tables shall be disinfected after each use by washing to remove visible soil followed by wiping with an approved disinfecting solution (e.g., 1/4 cup of liquid chlorine bleach per 1 gallon of water made fresh every 24 hours). Disposable, non-absorbent paper sheets approved by the health department for this purpose may be used and shall be discarded immediately after each diapering.

D. [Formerly paragraph 21:019-3] Conveniently located, washable, plastic-lined, covered receptacles operated by a foot pedal shall be provided for soiled diapers; separate from a similar covered receptacle for burping cloths and linen and shall be placed out of children's reach.

E. [Formerly paragraph 21:019-4] A handwashing sink shall be in or adjacent to each diapering area.

AUTHORITY NOTE: Promulgated in accordance with the provisions of R.S. 40:4(A)(10) and R.S. 40:5.

HISTORICAL NOTE: Promulgated by the Department of Health and Hospitals, Office of Public Health, LR 28:1403 (June 2002).

Chapter 5. Outdoor Play Areas

§501. General Standards [formerly paragraph 21:020]

A. The outdoor play area shall be enclosed with a fence or natural barriers. The barrier shall be at least 4 feet in height and the bottom edge shall be no more than 3 1/2 inches off the ground. There shall be at least two exits from such areas with at least one remote from buildings. Gates shall be equipped with self-closing and positive self-latching closure mechanisms. The latch or securing device shall be high enough or of a type that cannot be opened by small children.

1. The openings in the fence shall be no greater than 3 1/2 inches to prevent entrapment. The fence shall be constructed to discourage climbing, at least equivalent to a chain link fence.

B. [Formerly paragraph 21:020-1] Outdoor areas shall be kept free of excessive dust, weeds, brush, high grass, debris, and standing water.

C. [Formerly paragraph 21:020-2] Outside play areas shall be free from unprotected swimming and wading pools (both in-ground and above-ground), ditches, quarries, canals, excavations, fish ponds or other bodies of water. All water hazards shall be enclosed with a fence which is at least 5 feet high and comes within 3 1/2 inches of the ground with no openings of greater than 3 1/2 inches.

D. [Formerly paragraph 21:020-3] All pieces of playground equipment with play surfaces 4 feet or higher from the ground shall have an appropriate energy absorptive surface such as wood chips at a depth of 8-10 inches or rubber mats manufactured for such use meeting A.S.T.M. Standard F-355, under the fall zone of the equipment.

E. [Formerly paragraph 21:020-4] Sandboxes shall be constructed to permit drainage, and shall be covered when not in use and be kept free from cat or other animal excrement.

AUTHORITY NOTE: Promulgated in accordance with the provisions of R.S. 40:4(A)(10) and R.S. 40:5.

HISTORICAL NOTE: Promulgated by the Department of Health and Hospitals, Office of Public Health, LR 28:1403 (June 2002).

Chapter 7. Swimming Pools

§701. General Standards [formerly paragraph 21:021]

A. Outdoor swimming pools associated with children's activities shall be rendered safe and free of hazards.

B. [Formerly paragraph 21:021-1] Water in swimming and wading pools used by children shall be maintained between pH 7.2 and pH 8.2. The water shall be disinfected by available free chlorine greater than 0.4 parts per million or an equivalent disinfectant as approved by the state health officer. Swimming pools shall be maintained in a clean condition and the chlorine level and pH level shall be tested in accordance with Part XXIV of this Code. Wading pools shall be tested every two hours during use periods and cleaned daily. The results of these tests will be posted in a log for review by the state health officer.

C. [Formerly paragraph 21:021-2] Water temperature shall be maintained at no less than 82°F and no more than 93°F while in use.

AUTHORITY NOTE: Promulgated in accordance with the provisions of R.S. 40:4(A)(10) and R.S. 40:5.

HISTORICAL NOTE: Promulgated by the Department of Health and Hospitals, Office of Public Health, LR 28:1403 (June 2002).

Title 51
PUBLIC HEALTH—SANITARY CODE
Part XXIII. Retail Food Establishments

Chapter 1. Definitions

§101. Definitions
[formerly paragraph 23:001]

A. Terms not defined or referenced herein shall have the meanings as defined in LAC 51:I. In any instance where a term defined herein is also defined in one or more Parts of LAC 51:Part I, the definition contained in this Part shall govern this Part.

"a"—water activity.

Additive—as defined in Federal Food, Drug and Cosmetic Act 201(s), [21 U.S.C. 321(s)], any substance the intended use of which results or may reasonably be expected to result, directly or indirectly, in its becoming a component or otherwise affecting the characteristics of any food (including any substance intended for use in producing, manufacturing, packing, processing, preparing, treating, packaging, transporting, or holding food; and including any source of radiation intended for any such use), if such substance is not generally recognized, among experts qualified by scientific training and experience to evaluate its safety, as having been adequately shown through scientific procedures (or, in the case of a substance used in food prior to January 1, 1958, through either scientific procedures or experience based on common use in food) to be safe under the conditions of its intended use; except that such term does not include:

- a. a pesticide chemical residue in or on a raw agricultural commodity, processed food; or
- b. a pesticide chemical; or
- c. a color additive; or
- d. any substance used in accordance with a sanction or approval granted prior to the enactment of this Paragraph pursuant to this Act, the Poultry Products Inspection Act (21 U.S.C. 451 et seq.) or the Meat Inspection Act of March 4, 1907 (34 Stat. 1260), as amended and extended (21 U.S.C. 71 et seq.); or
- e. a new animal drug; or
- f. an ingredient described in Paragraph (ff) of this Act in, or intended for use in, a dietary supplement;
- g. and defined in 21 CFR 170.3(e)(1)—Food additives include all substances not exempted by Section 201(s) of this Act, the intended use of which results or may reasonably be expected to result, directly or indirectly, either in their becoming a component of food or otherwise affecting the characteristics of food. A material used in the production of containers and packages is subject to the

definition if it may reasonably be expected to become a component, or to affect the characteristics, directly or indirectly, of food packed in the container. "Affecting the characteristics of food" does not include such physical effects, as protecting contents of packages, preserving shape, and preventing moisture loss. If there is no migration of a packaging component from the package to the food, it does not become a component of the food and thus is not a food additive. A substance that does not become a component of food, but that is used, for example, in preparing an ingredient of the food to give a different flavor, texture, or other characteristic in the food, may be a food additive.

Adulterated Food—as defined in §607 of the State Food, Drug, and Cosmetic Law (R.S. 40:601 et seq.), a food is considered adulterated if it has been found to be such by any department of the United States government, or:

- a. if it contains any poisonous or deleterious substances, added or otherwise, which may render it dangerous to health, or any added poisonous or deleterious substance which is prohibited by R.S. 40:611 or which is in excess of the limits of tolerance prescribed by regulations of the department;
- b. if it consists in whole or in part of any filthy, putrid, or decomposed substance, or if it is otherwise unfit for food;
- c. if it has been prepared, packed, or held under unsanitary conditions whereby it may have become contaminated with filth or whereby it may have been rendered injurious to health;
- d. if it is the product of a diseased animal or of an animal which has died otherwise than by slaughter;
- e. if its container is composed of any poisonous or deleterious substance which may render the contents injurious to health;
- f. if any valuable constituent has been in whole or in part abstracted therefrom;
- g. if any substance has been substituted wholly or in part therefore;
- h. if damage or inferiority has been concealed in any manner;
- i. any substance has been added thereto or mixed or packed therewith so as to increase its bulk or weight, reduce its quality or strength, or create a deceptive appearance;
- j. if it contains a coal-tar color other than one from a batch that has been certified in accordance with regulations of the department;
- k. if it is confectionery or ice cream and contains any alcohol, resinous glaze, or non-nutritive substance

except harmless coloring, harmless flavoring, natural gum, and pectin. However, this Paragraph does not apply to any confectionery or ice cream by reason of its containing less than 1/2 of 1 percent by volume of alcohol, derived solely from the use of flavoring extracts, or to any chewing gum by reason of its containing harmless non-nutritive masticatory substance.

Approved Supplier—a producer, manufacturer, distributor or food establishment that is acceptable to the enforcement agency based on a determination of conformity with applicable laws, or, in the absence of applicable laws, with current public health principles and practices, and generally recognized industry standards that protect public health.

Base of Operations/Commissary—a catering establishment, restaurant, or any other properly equipped place in which food, containers, or supplies are kept, handled, prepared, packaged or stored.

Bed and Breakfast Establishment—a privately owned house where rooms are let and a breakfast is included in the rent. See *Food Establishment*.

Beverage—a liquid for drinking, including water.

Bulk Food—processed or unprocessed food in aggregate containers from which quantities desired by the consumer are withdrawn.

CIP—clean in place by the circulation or flowing by mechanical means through a piping system of a detergent solution, water rinse, and sanitizing solution onto or over equipment surfaces that require cleaning, such as the method used, in part, to clean and sanitize a frozen dessert machine.

Certification Number—a unique combination of letters and numbers assigned by a shellfish control authority to a molluscan shellfish dealer according to the provisions of the National Shellfish Sanitation Program.

Comminuted—reduced in size by methods including chopping, flaking, grinding, or mincing and restructured or reformulated.

Consumer—a person who is a member of the public, takes possession of food, is not functioning in the capacity of an operator of a "food" establishment or "food processing plant" and does not offer the "food" for resale.

Convenience Store—a retail food store which is usually easily accessible and deals mostly with prepackaged food products.

Corrosion-Resistant Material—a material that maintains acceptable surface cleanability characteristics under prolonged influence of the food to be contacted, the normal use of cleaning compounds, and "sanitizing" solutions, and other conditions of the environment.

Critical Control Point—as defined in the 1999 Food Code published by FDA, a point or procedure in a specific food system where loss of control may result in an unacceptable health risk.

Critical Item—a provision of this code that, if in noncompliance, is more likely than other violations to contribute to food contamination, illness, or environmental degradation, such as, but not limited to a potentially hazardous food stored at improper temperature, poor personal hygienic practices, not sanitizing equipment and utensils, no water, contaminated water sources, sewage backup, severe insect and rodent infestation, and chemical contamination.

Deli/Delicatessen—a food establishment which generally serves ready to eat food products such as sandwiches, cold cuts, cheeses, prepared salads and some prepared hot foods.

Drinking Water—see *potable water*.

Dry Storage Area—a room or area designated for the storage of packaged or containerized bulk food that is not potentially hazardous and dry goods such as single-service items.

Easily Cleanable—surfaces that are readily accessible and made of such materials, finish and so fabricated that residue may be effectively removed by normal cleaning methods.

Employee—the permit holder, person in charge, person having supervisory or management duties, person on the payroll, family member, volunteer, person performing work under contractual agreement, or other person working in a food establishment.

Equipment—an article that is used in the operation of a food establishment and retail food store/market such as, but not limited to, a reach-in or walk-in refrigerator or freezer, grinder, ice maker, meat block, mixer, oven, scale, sink, slicer, stove, table, thermometers, vending machine, or warewashing machine.

Fairs and Festivals—a gathering of persons for an event such as a bazaar, carnival, circus, public exhibition or other similar gathering for the purpose of celebration, competition, entertainment, distribution or sale of foods or goods, exhibition, religious activity, or other such purposes, which will operate for only a temporary period in any one location.

Food—a raw, cooked, or processed edible substance, ice, beverage, or ingredient used or intended for use or for sale in whole or in part for human consumption, or chewing gum.

Food Contact Surfaces—a surface of equipment or a utensil with which food normally comes in contact with, or a surface of equipment or a utensil from which food may drain, drip or splash into a food or onto a surface normally in contact with food.

Food Establishment—an operation that stores, prepares, packages, serves, vends or otherwise provides food for human consumption. The term includes restaurants, cafeterias, caterers, delicatessens, bars, lounges, or any other facility that prepares food for individual service or for a group of people, whether consumption is on or off the premises and regardless if there is a charge for the food. The term does not include:

a. private homes where food is prepared or served for individual family consumption and a kitchen in a private home if only food that is not potentially hazardous is prepared for sale or service at a function such as a religious or charitable organization's bake sale if allowed by "law" and if the consumer is informed by a clearly visible placard at the sales or service location that the food is prepared in a kitchen that is not subject to regulation and inspection by the regulatory authority;

b. a kitchen in a private home, such as a bed-and-breakfast operation that prepares and offers food to guests if the home is owner occupied, the number of available guest bedrooms does not exceed six, breakfast is the only meal offered, the number of guests served does not exceed 18, and the consumer is informed by statements contained in published advertisements, mailed brochures, and placards posted at the registration area that the food is prepared in a kitchen that is not regulated and inspected by the Office of Public Health.

Food Vendor/Food Concessionaire—any person who handles food or drink during preparation or serving, or who comes in contact with any eating or drinking utensils, or who is employed at any time in a room in which food or drink is prepared or served in a temporary food service.

Foodborne Disease Outbreak—the occurrence of two or more cases of a similar illness resulting from the ingestion of a common food.

Game Animals—an animal, the products of which are food, that is not classified by law as cattle, sheep, swine, goat, poultry, fish, and game birds or small animals as described in Part X of the Louisiana state sanitary code.

Garbage—the putrescible components of refuse which are subject to spoilage, rot, or decomposition. It includes wastes from the preparation and consumption of food, vegetable matter, and animal offal and carcasses.

HACCP—Hazard Analysis Critical Control Point.

HACCP Plan—a written document that delineates the formal procedures for following the Hazard Analysis Critical Control Point principles developed by The National Advisory Committee of Microbiological Criteria for Foods.

Hermetically Sealed Container—a container that is designed and intended to be secure against the entry of microorganisms and, in the case of low acid canned foods, to maintain the commercial sterility of its contents after processing.

Highly Susceptible Population—a group of persons who are more likely than other populations to experience foodborne disease because they are immunocompromised, or for the purposes of this Part, older adults in a facility that provides health care or assisted living services, such as a hospital or nursing home; or preschool age children in a facility that provides custodial care, such as a day care center.

Hot Holding Temperature—food stored for hot holding and service shall be held at a temperature of 140°F (60°C) or higher with the exception of roast beef. If roast beef is cooked in accordance with §1305.A.6 the minimum hot holding temperature shall be 130°F (54°C).

Individual Food Operator/Responsible Person—the person responsible for operating the individual temporary food service.

Injected—manipulating a meat through tenderizing with deep penetration or injecting the meat such as with juices which may be referred to as "injecting," "pinning," or "stitch pumping."

Itinerant Food Establishment—any fixed or mobile food establishment which operates on a temporary or seasonal basis.

Itinerant Retail Food Store/Market—any fixed or mobile retail food store/market which operates on a temporary or seasonal basis.

Kiosk—a small structure used as a food and/or beverage booth.

Kitchenware—food preparation and storage utensils.

Label—the principal display or displays of written, printed, or graphic matter upon any food or the immediate container thereof, or upon the outside container or wrapper, if any, of the retail package of any food.

Labeling—includes all labels and other written, printed and graphic matter, in any form whatsoever, accompanying any food.

Linens—fabric items such as cloth hampers, cloth napkins, table cloths, wiping cloths, and work garments including cloth gloves.

Market—a retail food store or food market which stores, prepares, packages, serves, vends or otherwise provides food products such as beverages, eggs, meat, milk, produce, seafood or other similar products.

Microorganisms—yeasts, molds, fungi, bacteria, parasites and viruses including, but not limited to, species having public health significance. The term "undesirable microorganisms" includes those microorganisms that are of public health significance, that subject food to decomposition, that indicate that food is contaminated with filth, or that otherwise may cause food to be adulterated within the meaning of the Food, Drug and Cosmetic Laws and Regulations.

Mobile Food Establishment—a vehicle-mounted food establishment designed to be readily movable.

Mobile Retail Food Store/Market—a vehicle-mounted retail food store/market designed to be readily movable.

Multi-Service Articles—reusable articles for the service of foods made of smooth, impervious material and approved by the state health officer.

Noncritical Item—all provisions in this Part that are not classified as critical items.

Offal—waste parts, especially of a butchered animal, including but not limited to bones, cartilage, fatty tissue and gristle.

Open Air Market—a site that deals in produce that is normally peeled or washed prior to consumption.

Organizer/Promoter/Chairman—that person responsible for managing a festival or fair. In the event of his/her unavailability, the assistant shall be deemed the responsible person.

"pH"—the symbol for the negative logarithm of the hydrogen ion concentration, which is a measure of the degree of acidity or alkalinity of a solution. Values between 0 and 7 indicate acidity and values between 7 and 14 alkalinity. The value for pure distilled water is 7, which is considered neutral.

PPM—parts per million, (mg/l) which is the metric equivalent.

Packaged—bottled, canned, cartoned, securely bagged, or securely wrapped.

Permit—the document issued by the "department" that authorizes a person to operate a food establishment or retail food store/market.

Permit Holder—the entity that:

a. is legally responsible for the operation of the establishment such as the owner, the owner's agent, or other person; and

b. possesses a valid permit to operate an establishment.

Person—an association, a corporation, individual, partnership, other legal entity, governmental subdivision or agency.

Person in Charge—the individual present at a food establishment or retail food store/market who is responsible for the operation at the time of inspection.

Personal Care Items—

a. items or substances that may be poisonous, toxic, or a source of contamination and are used to maintain or enhance a person's health, hygiene, or appearance;

b. includes items such as medicines; first aid supplies; and other items such as cosmetics, and toiletries such as toothpaste and mouthwash.

Pest—refers to any objectionable animal or insect including, but not limited to, birds, roaches, rodents, flies, and larvae.

Poisonous or Toxic Materials—substances that are not intended for ingestion including, but not limited to:

a. cleaners and "sanitizers" which include cleaning and "sanitizing" agents and agents such as caustics, acids, drying agents, polishes, and other chemicals;

b. pesticides, except "sanitizers," which include substances such as insecticides, rodenticides, herbicides;

c. substances necessary for the operation and maintenance of the establishment such as nonfood grade lubricants and personal care items that may be deleterious to health.

Potable Water—water having bacteriological, physical, radiological and chemical qualities that make it safe and suitable for use by people for drinking, cooking or washing.

Potentially Hazardous Food—

a. food that is natural or synthetic and is in a form capable of supporting:

i. the rapid and progressive multiplication of infectious or toxigenic microorganisms;

ii. the multiplication and toxin production of *Clostridium botulinum*; or

iii. in shell eggs, the multiplication of *Salmonella enteritidis*.

b. potentially hazardous food includes an animal food (a food of animal origin) that is raw or heat-treated; a food of plant origin that is heat-treated or consists of raw seed sprouts; cut melons; and garlic and oil mixtures;

c. potentially hazardous food does not include:

i. an air-cooled hard-boiled-egg with shell intact, or a shell egg that is not hard-boiled, but has been treated to destroy all viable *Salmonellae*;

ii. a food with a water activity (a_w) value of 0.85 or less;

iii. a food with a hydrogen ion concentration (pH) level of 4.6 or below when measured at 75°F (24°C);

iv. a food, in an unopened hermetically sealed container, that is commercially processed to achieve and maintain commercial sterility under conditions of nonrefrigerated storage and distribution; or

v. a food for which a variance granted by the regulatory authority is based upon laboratory evidence demonstrating that rapid and progressive multiplication of infectious and toxigenic microorganisms or the slower multiplication of *C. botulinum* cannot occur.

Premises—

a. the physical facility, its contents, and the contiguous land or property under the control of the permit holder; or

b. the physical facility, its contents, and the land or property not described under Subparagraph a of this definition if its facilities and contents are under the control of the permit holder and may impact establishment personnel, facilities, or operations, and an establishment is only one component of a larger operation such as a health care facility, hotel, motel, school, recreational camp, or prison.

Pushcart—a mobile food establishment or retail food store/market propelled by a person.

Ready-to-Eat-Food—food that is in a form that is edible without washing, cooking, or additional preparation by the food establishment or the consumer and that is reasonably expected to be consumed in that form.

Recognized Louisiana Festival or Fair—those fairs or festivals that are officially acknowledged, in writing, as recognized by a state, parish, or municipal governmental body or by the Louisiana Association of Fairs and Festivals.

Reconstituted—dehydrated food products recombined with water or other liquids.

Reduced Oxygen Packaging—the reduction of the amount of oxygen in a package by mechanically evacuating the oxygen; displacing the oxygen with another gas or combination of gases; or otherwise controlling the oxygen content in a package to a level below that normally found in the surrounding atmosphere, which is 21 percent oxygen. This may include methods referred to as altered atmosphere, modified atmosphere, controlled atmosphere, low oxygen, and vacuum packaging including sous vide.

Refuse—any garbage, rubbish, sludge from a food establishment, retail food store/market, waste treatment plant, water supply treatment plant, or air pollution control facility. It also includes other discarded material such as solid, liquid, semi-solid, or contained gaseous material resulting from either industrial, commercial, mining, or agricultural operations, or from community activities. It does not include solid or dissolved material in domestic sewage, irrigation return flow, industrial discharges which are point sources, or radioactive wastes.

Regulatory Authority—the local, state or federal enforcement body or authorized representative having jurisdiction over the food establishment or retail food store/market.

Retail Food Manufacturer—an establishment in which food is manufactured or packaged for human consumption and is sold only at the site of manufacture, such as but not limited to bakery products and candy.

Retail Food Store/Market—all types of food markets including convenience, fixed, mobile and temporary food stores. These may also be referred to as groceries. Larger retail food stores may also include bakeries and delicatessens.

Rubbish—all non-putrescible waste matter, except ashes, from any public or private establishments, institution, or residence. It also includes construction and demolition wastes.

Safe Material—an article manufactured from or composed of materials that may not reasonably be expected to result, directly or indirectly, in their becoming a component or otherwise affecting the characteristics of any food.

Sanitization—the application of cumulative heat or chemicals on cleaned food-contact surfaces that, when evaluated for efficacy, is sufficient to yield a reduction of five logs, which is equal to a 99.999 percent reduction of representative disease microorganisms of public health importance.

Seafood—includes but is not limited to fish, shellfish, edible crustaceans, marine and freshwater animal food products.

Sealed—free of cracks or other openings that allow the entry or passage of moisture.

Seasonal—a recurrent period that is characterized by certain seasons of the year, occupations, festivities, or crops; any period of time that is legally available to the hunter, fisherman, or trapper. These seasons are legally set by government regulatory agencies such as the Department of Wildlife and Fisheries, Department of Agriculture or other such agencies.

Single-Service Articles—tableware, carry-out utensils, and other items such as bags, containers, cups, lids, closures, plates, knives, forks, spoons, paddles, napkins, placemats, stirrers, straws, toothpicks, and wrappers that are designed and constructed for one time, one person use and then discarded.

Single-Use Articles—utensils and bulk food containers designed and constructed to be used once and discarded. Single-use articles includes items such as wax paper, butcher paper, plastic wrap, formed aluminum food containers, jars, plastic tubs, or buckets, bread wrappers, pickle barrels, and number 10 cans.

Slacking—the process of moderating the temperature of a food such as allowing a food to gradually increase from a temperature of -23°C (-10°F) to -4°C (25°F) in preparation for deep-fat frying or to facilitate even heat penetration during the cooking of previously block-frozen food such as spinach.

Smoked Food—food which has been colored or flavored by natural or liquid smoke.

Substantial Renovation—

a. alterations or repairs made within a 12-month period, costing in excess of 50 percent of the then physical value of the existing building; or

b. alterations or repairs made within a 12-month period, costing in excess of \$15,000; or

c. alterations or repairs made within a 12-month period, involving a change in "occupancy classification" or use of the property;

d. the physical value of the building in Subparagraph a of this Paragraph may be established by an appraisal not more than three years old, provided that said appraisal was performed by a certified appraiser or by the tax assessor in the parish where the building is located;

e. the cost of alterations or repairs in Subparagraphs a or b of this Paragraph may be established by:

i. an estimate signed by a licensed architect or a licensed general contractor; or

ii. by copies of receipts for the actual costs.

Tableware—eating, drinking, and serving utensils for table use such as flatware including forks, knives and spoons; hollowware including bowls, cups, serving dishes, tumblers; and plates.

Temperature Measuring Device—a thermometer, thermocouple, thermistor, or other device that indicates the temperature of food, air, or water.

Temporary Food Establishment—a fixed or mobile food establishment that operates for a period of time of not more than 21 consecutive days in conjunction with a single event in a single location such as, but not limited to a festival or fair.

Temporary Food Service—a temporary food establishment or temporary retail food store/market.

Temporary Retail Food Store/Market—a fixed or mobile food store/market which operates for a period of time no more than 21 consecutive days in conjunction with a single event in a single location such as, but not limited to a festival or fair.

Utensil—a food-contact implement or container used in the storage, preparation, transportation, dispensing, sale, or service of food, such as kitchenware or tableware that is multi-use, single-service, or single-use; gloves used in contact with food; and food temperature measuring devices.

Warewashing—the cleaning and sanitizing of food-contact surfaces of equipment and utensils.

Water Activity—(a_w) a measure of the free moisture in a food and is the quotient of the water vapor pressure of the substance divided by the vapor pressure of pure water at the same temperature.

Wholesome—food which is in sound condition, clean, free from adulteration or contamination and is otherwise suitable for human consumption.

AUTHORITY NOTE: Promulgated in accordance with R.S. 40:4.

HISTORICAL NOTE: Promulgated by the Department of Health and Hospitals, Office of Public Health, LR 28:311 (February 2002), repromulgated LR 28:1405 (June 2002), amended LR 28:2531 (December 2002).

Chapter 3. General Requirements

§301. Effective Date of Part

A. The provisions of this Part shall have effect from the date of publication hereof as a Rule in the *Louisiana Register*. Upgrading of such buildings and facilities shall be required when:

1. the construction of buildings and facilities was not previously approved by the state health officer pursuant to sanitary code requirements then in effect;
2. substantial renovation of, or additions to, such buildings or facilities is undertaken;
3. the real property ownership, or the occupancy classification of the business located therein changes subsequent to the effective date hereof;

a. Exception

i. When only a real property ownership change occurs, restroom plumbing fixture upgrades to meet the minimum plumbing fixture requirements contained in LAC 51:XIV.411 and LAC 51:XIV.Table 411 are not to be blindly enforced if the state health officer/Office of Public Health has assurances that the prior or existing business held a food permit (e.g., grocery store, restaurant, etc.) under this Part (LAC 51:XXIII) and the prospective new business owner agrees, in writing to the state health officer/Office of Public Health, to operate the business in exactly the same manner as the prior or existing business owner (e.g., parents sell a business to their children who will operate the business in exactly the same manner) and there have been no documented complaints, within the past 5 years, about:

- (a). a lack of toilet room fixtures;
- (b). urination in non-restroom fixtures or floor areas within the building; or,
- (c). urination on the outside of the building or the premises or adjoining lots or areas, etc.

b. The exception (see §301.A.3.a.) to the normal enforcement procedures (see §301.A.3) shall not be applicable when a serious health threat to the public exists.

4. the business ownership (occupant) changes subsequent to the effective date, except that the upgrading of restroom plumbing fixtures shall not be required where only the business ownership (occupant) changes if the construction of restroom plumbing fixtures was approved by the state health officer pursuant to sanitary code requirements then in effect; or

5. a serious health threat to the public health exists, unless otherwise specifically provided hereinafter.

AUTHORITY NOTE: Promulgated in accordance with provisions of R.S. 40:4 and R.S. 40:5.

HISTORICAL NOTE: Promulgated by the Department of Health and Hospitals, Office of Public Health, LR 28:315 (February 2002), amended LR 28:1409 (June 2002), LR 38:2926 (November 2012).

§303. Interpretation [formerly paragraph 23:002]

A. This Part shall be interpreted and applied to promote its underlying purpose of protecting the public health.

AUTHORITY NOTE: Promulgated in accordance with R.S. 40:4.

HISTORICAL NOTE: Promulgated by the Department of Health and Hospitals, Office of Public Health, LR 28:315 (February 2002), amended LR 28:1409 (June 2002).

§305. Food Safety Certification [formerly paragraph 23:002-2]

A. The owner or a designated employee of each food establishment shall hold a "food safety certificate" from the department exclusively on behalf of that food establishment. The certificate shall be required to be renewed every five years.

1. For the purposes of this Section and §1901.D only, the term *food establishment* as defined in §101 of this Part shall additionally not include the following:

- a. private clubs where food is prepared and served exclusively for member consumption;
- b. religious or charitable food sales;
- c. any establishment that heats or prepares boudin or sausage for personal consumption;
- d. a bar or lounge that serves beverages only;
- e. temporary and seasonal establishments;
- f. nursing facilities;
- g. public, private, or parochial schools;
- h. elderly nutrition meal sites which do not prepare meals; and
- i. child care facilities.

2. The owner or a designated food service employee of a child care facility shall be required to complete one hour of food safety training each year as part of the three hours of mandatory yearly training required under the requirements of LAC 51:XXI.301.A.9. When the owner or a designated food service employee of a child care facility holds a valid Food Safety Certificate issued under the provisions of this Section, the holder of said certificate will be credited with three years of the mandatory yearly training required under LAC 51:XXI.301.A.9.

B. Any food establishments with food sales of less than \$125,000 annually shall not be required to comply with this Section until July 1, 2002. However, any establishment may apply for such certificate prior to such date. Those food establishments permitted after July 1, 2002 shall comply with this Section within 60 days of permit issuance.

C. To obtain a department food safety certificate, the following is required.

1. The individual must complete a course provided by an approved training program. The department shall approve all training programs and shall maintain a list of these training programs. These programs shall include, but are not limited to, the standards set forth in the ServSafe Program established by the Educational Foundation of the National Restaurant Association, or other programs recognized by the food service industry and the department.

a. Instructors/trainers shall meet the criteria established by the Educational Foundation of the National Restaurant Association or other instructor/trainer requirements established by the food service industry and the department.

b. The department shall approve training programs administered or approved by another state, political subdivision, or other jurisdiction with standards that meet or exceed those established in this Code.

2. The individual must pass a written exam approved by the department before qualifying for the certificate. This

test will meet the standards as described in Paragraph 1 above.

3. The individual must submit a completed application to the department with:

- a. satisfactory evidence that he/she has completed an approved training program which includes passing a written examination; and
- b. a \$25 fee for each certificate.

EXCEPTION: All state and local government employees are exempt from this fee.

4. Upon receipt and approval of the documentation and fee described in Paragraph 3 above, the department shall then issue a food safety certificate to the applicant.

5. The permit holder shall display a current state food safety certificate in a location in the food establishment conspicuous to the public.

D. Certificates from the department shall be required to be renewed every five years for a \$25 fee. A person shall pass another written exam as described in Paragraph 2, Subsection C above before the certificate is renewed.

E. No parish or municipality in Louisiana shall enforce any ordinance or regulation requiring a food establishment or any of its employees to complete a food safety training program or test.

AUTHORITY NOTE: Promulgated in accordance with R.S. 40:4 and 40:5.5.

HISTORICAL NOTE: Promulgated by the Department of Health and Hospitals, Office of Public Health, LR 28:316 (February 2002), amended LR 28:1409 (June 2002), LR 33:848 (May 2007).

§307. Submission of Plans [formerly paragraph 23:003]

A. Whenever a food establishment or retail food store/market is constructed, substantially renovated, or a change of real property or business ownership occurs, or the occupancy classification changes, plans and specifications shall be submitted to the state health officer for review and approval. The plans and specifications must be approved before construction and renovation begins and shall indicate the proposed type of operation, anticipated volume and types of food products to be stored, prepared, packaged and/or served along with the proposed layout of the facility, mechanical plans, construction materials and the types and location and specifications of all fixed and mobile equipment to be used in the establishment.

AUTHORITY NOTE: Promulgated in accordance with R.S. 40:4.

HISTORICAL NOTE: Promulgated by the Department of Health and Hospitals, Office of Public Health, LR 28:316 (February 2002), amended LR 28:1410 (June 2002).

§309. Preoperational Inspection [formerly paragraph 23:004]

A. The state health officer may conduct one or more preoperational inspections to verify that the food

establishment or retail food store/market is constructed and equipped in accordance with the approved plans and is in compliance with all provisions of this Title.

AUTHORITY NOTE: Promulgated in accordance with R.S. 40:4.

HISTORICAL NOTE: Promulgated by the Department of Health and Hospitals, Office of Public Health, LR 28:316 (February 2002), amended LR 28:1410 (June 2002).

§311. Hazard Analysis Critical Control Point (HACCP)
[formerly paragraph 22:02-4]

A. A food establishment or retail food store/market that packages food using a reduced oxygen packaging method shall have a Hazard Analysis Critical Control Point (HACCP) plan and provide the information required in §4121 of this Part.

B. A HACCP plan shall contain:

1. a categorization of the types of Potentially Hazardous Foods that are specified in the menu such as soups and sauces, salads, and bulk, solid foods such as meat roasts, or of other foods that are specified by the department;

2. a flow diagram by specific food or category type identifying Critical Control Points and providing information on the following:

a. ingredients, materials, and equipment used in the preparation of that food; and

b. formulations or recipes that delineate methods and procedural control measures that address the food safety concerns involved;

3. a supervisory training plan that addresses the food safety issues of concern;

4. a statement of standard operating procedures for the plan under consideration including clearly identifying:

a. each critical control point;

b. the critical limits for each critical control point;

c. the method and frequency for monitoring and controlling each critical control point by the employee designated by the person in charge;

d. the method and frequency for the person in charge to routinely verify that the employee is following standard operating procedures and monitoring critical control points;

e. action to be taken by the person in charge if the critical limits for each critical control point are not met;

f. records to be maintained by the person in charge to demonstrate that the HACCP plan is properly operated and managed; and

5. additional scientific data or other information, as required by the department supporting the determination that food safety is not compromised by the proposal.

AUTHORITY NOTE: Promulgated in accordance with R.S. 40:4.

HISTORICAL NOTE: Promulgated by the Department of Health and Hospitals, Office of Public Health, LR 28:316 (February 2002), amended LR 28:1410 (June 2002).

Chapter 5. Permits

§501. General
[formerly paragraph 23:125]

A. No person shall operate a food establishment or retail food store/market of any type without first having received a valid permit to operate from the state health officer. Permits are not transferable. A valid permit shall be posted in a location of the establishment conspicuous to the public.

AUTHORITY NOTE: Promulgated in accordance with R.S. 40:4.

HISTORICAL NOTE: Promulgated by the Department of Health and Hospitals, Office of Public Health, LR 28:317 (February 2002), amended LR 28:1411 (June 2002).

§503. To Obtain a Permit from the State Health Officer
[formerly paragraph 23:126-1, 23:126-2, 23:126-3]

A. The owner, president of the corporation, or other such officer duly delegated by the corporation or partnership shall make written application for a permit to operate and submit plans as described in §307 to the state health officer.

B. After plans and specifications have been reviewed and approved, the owner, president of the corporation, or other such officer shall request a preoperational inspection be made as described in §309 to determine compliance with all provisions of this Title.

C. A permit to operate shall be issued by the state health officer to the applicant if an inspection reveals that the proposed food establishment or retail food store/market and applicant has complied with all the provisions of this Title.

AUTHORITY NOTE: Promulgated in accordance with R.S. 40:4.

HISTORICAL NOTE: Promulgated by the Department of Health and Hospitals, Office of Public Health, LR 28:317 (February 2002), amended LR 28:1411 (June 2002).

Chapter 7. Employee Health

§701. General
[formerly paragraph 23:031]

A. All employees shall meet the requirements of Part I, §117.A, B of this title, Employee Health and Chapter 2, The Control of Diseases, of the State Sanitary Code. The employee shall report information to the person in charge about their health and activities as they relate to infectious diseases that are transmissible through food. The person in charge shall be responsible for complying with Part I, §117 of this title, and excluding the employee from the food establishment to prevent the likelihood of foodborne disease transmission.

B. All employees shall report to the person in charge any symptom caused by illness, infection, or other source that is:

1. associated with an acute gastrointestinal illness such as diarrhea, fever, vomiting, jaundice or sore throat with fever; or

2. a lesion containing pus such as a boil or infected wound that is open or draining and is:

a. on the hands or wrist, unless an impermeable cover such as a finger cot, or stall protects the lesion and a single-use glove is worn over the impermeable cover;

b. on exposed portions of the arms, unless the lesion is protected by an impermeable cover; or

c. on other parts of the body, unless the lesion is covered by a dry, durable, tight-fitting bandage.

C. The person in charge shall restrict employees from working with exposed food; clean equipment, utensils, and linens; and unwrapped single-service and single-use articles, in a food establishment or retail food store/market if the employee is suffering a symptom specified in Subsection B of this Section.

AUTHORITY NOTE: Promulgated in accordance with R.S. 40:4.

HISTORICAL NOTE: Promulgated by the Department of Health and Hospitals, Office of Public Health, LR 28:317 (February 2002), amended LR 28:1411 (June 2002).

Chapter 9. Personal Cleanliness and Hygienic Practices

§901. Handwashing [formerly paragraph 23:032]

A. Employees shall thoroughly wash their hands and exposed portions of their arms with soap and warm water before starting work, before applying gloves, during work as often as necessary to keep them clean, and after smoking, using tobacco, eating, drinking, coughing, sneezing, handling raw food, using the toilet.

AUTHORITY NOTE: Promulgated in accordance with R.S. 40:4.

HISTORICAL NOTE: Promulgated by the Department of Health and Hospitals, Office of Public Health, LR 28:317 (February 2002), amended LR 28:1411 (June 2002).

§903. Fingernails [formerly paragraph 22:06-2]

A. Employees shall keep their fingernails clean and trimmed not to exceed the end of the fingertip. An employee shall not wear nail polish, long, or artificial fingernails when working with exposed food unless wearing intact gloves in good repair.

AUTHORITY NOTE: Promulgated in accordance with R.S. 40:4.

HISTORICAL NOTE: Promulgated by the Department of Health and Hospitals, Office of Public Health, LR 28:317 (February 2002), repromulgated LR 28:1411 (June 2002), amended LR 28:2531 (December 2002).

§905. Jewelry [formerly paragraph 22:06-3]

A. Employees may not wear jewelry on their arms and hands while preparing food. This does not apply to a plain ring such as a wedding band.

AUTHORITY NOTE: Promulgated in accordance with R.S. 40:4.

HISTORICAL NOTE: Promulgated by the Department of Health and Hospitals, Office of Public Health, LR 28:317 (February 2002), amended LR 28:1411 (June 2002).

§907. Outer Clothing [formerly paragraph 22:06-4]

A. Employees shall wear clean outer clothing.

AUTHORITY NOTE: Promulgated in accordance with R.S. 40:4.

HISTORICAL NOTE: Promulgated by the Department of Health and Hospitals, Office of Public Health, LR 28:318 (February 2002), amended LR 28:1411 (June 2002).

§909. Hand Sanitizers

A. Employees may apply hand sanitizers only to hands that are cleaned as specified in §901 of this Chapter. Hand sanitizers shall comply with all state and federal regulations and be used in accordance with label directions.

AUTHORITY NOTE: Promulgated in accordance with R.S. 40:4.

HISTORICAL NOTE: Promulgated by the Department of Health and Hospitals, Office of Public Health, LR 28:318 (February 2002), amended LR 28:1411 (June 2002).

§911. Tasting, Eating and Drinking [formerly paragraph 23:034-1]

A. Employees shall eat and drink only in designated areas where the contamination of exposed food, equipment, utensils or other items needing protection cannot result, except an employee may drink from a closed beverage container if the container is handled properly to prevent contamination. An employee may not use a utensil more than once to taste food that is to be sold or served.

AUTHORITY NOTE: Promulgated in accordance with R.S. 40:4.

HISTORICAL NOTE: Promulgated by the Department of Health and Hospitals, Office of Public Health, LR 28:318 (February 2002), repromulgated LR 28:1412 (June 2002), amended LR 28:2531 (December 2002).

§913. Using Tobacco [formerly paragraph 23:034-2]

A. Employees shall not use tobacco in any form while preparing or serving food. Employees shall use tobacco only in designated areas such as described in §4105.C of this Part.

AUTHORITY NOTE: Promulgated in accordance with R.S. 40:4.

HISTORICAL NOTE: Promulgated by the Department of Health and Hospitals, Office of Public Health, LR 28:318 (February 2002), amended LR 28:1412 (June 2002).

§915. Hair Restraints
[formerly paragraph 23:033-2]

A. Employees shall wear hair restraints such as hats, hair coverings or nets, beard restraints, and clothing that covers body hair, that are designed and worn to effectively keep their hair from contacting exposed food, equipment, utensils and other items needing protection. This does not apply to employees such as counter staff who only serve beverages and wrapped or packaged food items if they present a minimal risk of contaminating exposed food, clean equipment, utensils, and linens, and unwrapped single service and single use articles.

AUTHORITY NOTE: Promulgated in accordance with R.S. 40:4.

HISTORICAL NOTE: Promulgated by the Department of Health and Hospitals, Office of Public Health, LR 28:318 (February 2002), amended LR 28:1412 (June 2002).

§917. Food Contamination
[formerly paragraph 22:07-4]

A. Employees experiencing persistent sneezing, coughing or a runny nose may not work with exposed food, equipment, utensils or other items needing protection.

AUTHORITY NOTE: Promulgated in accordance with R.S. 40:4.

HISTORICAL NOTE: Promulgated by the Department of Health and Hospitals, Office of Public Health, LR 28:318 (February 2002), amended LR 28:1412 (June 2002).

§919. Handling
[formerly paragraph 22:07-5]

A. Employees shall handle soiled tableware in a manner to prevent the contamination of clean tableware by their hands. Employees may not care for or handle animals allowed under §4101.B of this Part while preparing or serving food, except employees may handle or care for fish in aquariums, or molluscan shellfish, or crustacea in display tanks or storage when they wash their hands as specified under §901 of this Part.

AUTHORITY NOTE: Promulgated in accordance with R.S. 40:4.

HISTORICAL NOTE: Promulgated by the Department of Health and Hospitals, Office of Public Health, LR 28:318 (February 2002), amended LR 28:1412 (June 2002).

Chapter 11. Food Supplies

§1101. General
[formerly paragraph 22:08-1]

A. All food shall be safe, unadulterated and honestly presented.

AUTHORITY NOTE: Promulgated in accordance with R.S. 40:4.

HISTORICAL NOTE: Promulgated by the Department of Health and Hospitals, Office of Public Health, LR 28:318 (February 2002), amended LR 28:1412 (June 2002).

§1103. Source
[formerly paragraph 22:08-2]

A. Food shall be obtained from sources that comply with law. Food prepared in a private home may not be used or

offered for human consumption in any food establishment or retail food store/market. This Section shall not apply to any jellies, preserves, jams, honey and honeycomb products prepared in private homes, when the gross annual sales are less than \$5000.

AUTHORITY NOTE: Promulgated in accordance with R.S. 40:4 and 40:4.9.

HISTORICAL NOTE: Promulgated by the Department of Health and Hospitals, Office of Public Health, LR 28:318 (February 2002), amended LR 28:1412 (June 2002).

§1105. Package
[formerly paragraph 22:08-3]

A. Food packages shall be in a good condition and protect the integrity of the contents so that the food is not exposed to adulteration or potential contaminants.

AUTHORITY NOTE: Promulgated in accordance with R.S. 40:4.

HISTORICAL NOTE: Promulgated by the Department of Health and Hospitals, Office of Public Health, LR 28:318 (February 2002), amended LR 28:1412 (June 2002).

§1107. Labeling
[formerly paragraph 22:08-4]

A. Packaged food shall be labeled as specified by law. All bulk food storage containers shall be properly labeled according to law.

AUTHORITY NOTE: Promulgated in accordance with R.S. 40:4.

HISTORICAL NOTE: Promulgated by the Department of Health and Hospitals, Office of Public Health, LR 28:318 (February 2002), amended LR 28:1412 (June 2002).

§1109. Raw Shellfish Consumer Information Message
[formerly paragraph 22:08-5.1]

A. All establishments that sell or serve raw oysters must display signs, menu notices, table tents, or other clearly visible messages at point of sale with either of the following wording:

1. "THERE MAY BE A RISK ASSOCIATED WITH CONSUMING RAW SHELLFISH AS IS THE CASE WITH OTHER RAW PROTEIN PRODUCTS. IF YOU SUFFER FROM CHRONIC ILLNESS OF THE LIVER, STOMACH OR BLOOD OR HAVE OTHER IMMUNE DISORDERS, YOU SHOULD EAT THESE PRODUCTS FULLY COOKED"; or

2. "CONSUMING RAW OR UNDERCOOKED MEATS, POULTRY, SEAFOOD, SHELLFISH OR EGGS MAY INCREASE YOUR RISK OF FOODBORNE ILLNESS, ESPECIALLY IF YOU HAVE CERTAIN MEDICAL CONDITIONS."

B. In addition, either of the above messages in Subsection A of this Section must appear on the principal display panel or top of containers of pre-packaged raw oysters. This may be done by printing on the container or by pressure sensitive labels.

C. In addition, one of the following messages must appear on the tag of each sack or other container of unshucked raw oysters:

1. "THERE MAY BE A RISK ASSOCIATED WITH CONSUMING RAW SHELLFISH AS IS THE CASE WITH OTHER RAW PROTEIN PRODUCTS. IF YOU SUFFER FROM CHRONIC ILLNESS OF THE LIVER, STOMACH OR BLOOD OR HAVE OTHER IMMUNE DISORDERS, YOU SHOULD EAT THESE PRODUCTS FULLY COOKED";

2. "RETAILERS, INFORM YOUR CUSTOMERS— Consuming raw or undercooked meats, poultry, seafood, shellfish or eggs may increase your risk of foodborne illness, especially if you have certain medical conditions"; or

3. equivalent wording as approved by the state authority (see LAC 51:IX.323.B.6.).

AUTHORITY NOTE: Promulgated in accordance with R.S. 40:4.A.(1) and R.S. 40:5(2)(3)(5)(7)(15).

HISTORICAL NOTE: Promulgated by the Department of Health and Hospitals, Office of Public Health, LR 28:319 (February 2002), amended LR 28:1412 (June 2002), amended by the Department of Health and Hospitals, Office of Public Health, Center for Environmental Health Services, LR 34:445 (March 2008).

§1111. Exemption to Raw Shellfish Consumer Information Message
[formerly paragraph 22:08-5.2]

A. Food establishments that exclusively serve raw molluscan shellfish that have been subjected to a process recognized by the state health officer as being effective in reducing the bacteria *Vibrio vulnificus* to non-detectable levels may apply for an exemption from the mandatory consumer information notification requirement. Food establishments interested in obtaining an exemption shall certify in writing to the state health officer that it shall use exclusively for raw consumption only molluscan shellfish that have been subjected to the approved process. Upon receipt and verification of that communication, the state health officer may confirm the establishment as being exempt from the requirement of displaying the consumer information message. The food establishment's certification must be sent to the state health officer at the following address:

Louisiana Office of Public Health
P.O. Box 629
Baton Rouge, LA 70821-0629

AUTHORITY NOTE: Promulgated in accordance with R.S. 40:4.

HISTORICAL NOTE: Promulgated by the Department of Health and Hospitals, Office of Public Health, LR 28:319 (February 2002), amended LR 28:1413 (June 2002).

§1113. Hermetically Sealed Containers
[formerly paragraph 22:08-6]

A. Food in hermetically sealed containers shall be obtained from a licensed and/or regulated food processing plant.

AUTHORITY NOTE: Promulgated in accordance with R.S. 40:4.

HISTORICAL NOTE: Promulgated by the Department of Health and Hospitals, Office of Public Health, LR 28:319 (February 2002), amended LR 28:1413 (June 2002).

§1115. Milk
[formerly paragraph 22:08-7]

A. Fluid, frozen, dry milk and milk products shall be obtained from sources with Grade A Standards as specified in law and Part VII and Part VIII of the state sanitary code.

B. All pasteurized, ultra-pasteurized and aseptically processed milk and dairy products shall be placed in their final delivery containers in the plant in which they are pasteurized, ultra-pasteurized or aseptically processed. It shall be unlawful for hotels, soda fountains, restaurants, grocery stores, markets and similar establishments to sell or serve any milk or milk products except in the original containers received from the plant in which it was pasteurized, ultra-pasteurized or aseptically processed or from a bulk container dispensing device that conforms with 3-A Standards. Packaging of milk and milk products from such dispensers is prohibited. This requirement shall not apply to cream consumed on the premises or milk and milk products in portions less than 1/2 pint used in mixed drinks, cereals, desserts or other foods. In these instances, pouring from a commercially filled container of not more than one gallon capacity is acceptable. (see LAC 51:VII.953.A)

C. Food establishments having counter freezers which freeze frozen dessert or non-dairy frozen dessert mixes shall comply with the requirements of Part VII of this code, as applicable, particularly LAC 51:VII.2709.A.1-4.

D. The dipping and/or packaging of firmly frozen frozen desserts by consumers who serve themselves is prohibited. Ice cream, ice milk and other frozen desserts shall be offered to consumers who serve themselves only when dispensed from approved dispensing machines designed expressly for that purpose.

AUTHORITY NOTE: Promulgated in accordance with the provisions of R.S. 40:4(A)(1)(a), R.S. 40:5(2)(3)(5)(7)(15)(17) and R.S. 40:922.

HISTORICAL NOTE: Promulgated by the Department of Health and Hospitals, Office of Public Health, LR 28:319 (February 2002), amended LR 28:1413 (June 2002), LR 37:2728 (September 2011).

§1117. Seafood
[formerly paragraph 22:08-8]

A. Fish, shellfish, edible crustaceans, marine and fresh water animal food products shall be obtained from sources according to law and Part IX of the state sanitary code. Shellstock tags shall be retained by the food establishment or retail food store/market for 90 days after service or sale to the consumer.

AUTHORITY NOTE: Promulgated in accordance with R.S. 40:4.

HISTORICAL NOTE: Promulgated by the Department of Health and Hospitals, Office of Public Health, LR 28:319 (February 2002), amended LR 28:1413 (June 2002).

§1119. Eggs
[formerly paragraph 22:08-9]

A. Shell eggs shall be received clean and sound according to law.

B. Liquid, frozen and dry egg products shall be obtained pasteurized.

C. Shell eggs which have not been specifically processed to destroy all live *Salmonellae* before distribution to the consumer shall be labeled with the following safe handling statement on the label of the shell eggs: "SAFE HANDLING INSTRUCTIONS: To prevent illness from bacteria: keep eggs refrigerated, cook eggs until yolks are firm and cook foods containing eggs thoroughly."

AUTHORITY NOTE: Promulgated in accordance with R.S. 40:4.

HISTORICAL NOTE: Promulgated by the Department of Health and Hospitals, Office of Public Health, LR 28:319 (February 2002), repromulgated LR 28:1413 (June 2002), amended LR 28:2531 (December 2002).

§1121. Poultry and Meats
[formerly paragraph 22:08-10]

A. Poultry and meat products shall be obtained from sources according to law.

AUTHORITY NOTE: Promulgated in accordance with R.S. 40:4.

HISTORICAL NOTE: Promulgated by the Department of Health and Hospitals, Office of Public Health, LR 28:319 (February 2002), amended LR 28:1413 (June 2002).

§1123. Game Animals
[formerly paragraph 22:08-11]

A. Game animals may be received for sale if they are under a routine inspection program conducted by a regulatory authority or raised, slaughtered, and processed under a voluntary inspection program by a regulatory authority.

B. If retail food markets are requested by an individual to process wild deer meat, they must process this meat in accordance with the guidelines established by the department.

AUTHORITY NOTE: Promulgated in accordance with R.S. 40:4.

HISTORICAL NOTE: Promulgated by the Department of Health and Hospitals, Office of Public Health, LR 28:319 (February 2002), amended LR 28:1413 (June 2002).

Chapter 13. Temperature

§1301. Temperature Control
[formerly paragraph 22:09-1]

A. Except as specified in §1303 of this Chapter, all refrigerated potentially hazardous foods shall be received at a temperature of 41°F (5°C) or below.

AUTHORITY NOTE: Promulgated in accordance with R.S. 40:4.

HISTORICAL NOTE: Promulgated by the Department of Health and Hospitals, Office of Public Health, LR 28:320 (February 2002), amended LR 28:1413 (June 2002).

§1303. Exceptions
[formerly paragraph 22:09-2]

A. Shell eggs, milk and molluscan shellstock may be received at a temperature not to exceed 45°F (7.2°C) as specified by law.

AUTHORITY NOTE: Promulgated in accordance with R.S. 40:4.

HISTORICAL NOTE: Promulgated by the Department of Health and Hospitals, Office of Public Health, LR 28:320 (February 2002), amended LR 28:1413 (June 2002).

§1305. Cooking/Reheating
[formerly paragraph 22:09-3]

A. Foods shall be cooked to heat all parts of the food to a temperature and for a time that are at least:

1. 165°F (74°C) or above for 15 seconds for wild game, poultry, stuffed fish, stuffed meat, stuffed pasta, stuffed poultry, stuffed ratites or stuffing containing fish, meat or poultry;
2. 155°F (68°C) or above for 15 seconds for comminuted fish, comminuted meats, injected meats, ratites or raw pooled eggs;
3. 165°F (74°C) or above when foods are cooked or reheated in microwave ovens and the food shall be rotated and stirred throughout to compensate for uneven distribution of heat;
4. 145°F (63°C) or above for 15 seconds for pork and all other foods;
5. 165°F (74°C) or above for 15 seconds in all parts of the food when reheating all potentially hazardous food that is cooked, cooled, and reheated for hot holding or serving;
6. 130°F (54°C) minimum internal temperature for beef roasts or to a temperature and time that will cook all parts of the roast as required by the following:

a. in an oven that is preheated to the temperature specified for the roast's weight in the following chart and that is held at that temperature:

Oven Type	Oven Temperature Based on Roast Weight	
	Less than 4.5 kg (10 lbs)	4.5 kg (10 lbs) or more
Still Dry	350°F (177°C) or more	250°F (121°C) or more
Convection	325°F (163°C) or more	250°F (121°C) or more
High Humidity ¹	250°F (121°C) or more	250°F (121°C) or more

¹ Relative humidity greater than 90 percent for at least 1 hour as measured in the cooking chamber or exit of the oven; or in a moisture-impermeable bag that provides 100 percent humidity.

and;

b. as specified in the following chart, to heat all parts of the food to a temperature and for the holding time that corresponds to that temperature;

Temperature °F (°C)	Time ¹ in Minutes	Temperature °F (°C)	Time ¹ in Seconds
130 (54.4)	112	147 (63.9)	134
131 (55.0)	89	149 (65.0)	85
133 (56.1)	56	151 (66.1)	54

Temperature °F (°C)	Time ¹ in Minutes	Temperature °F (°C)	Time ¹ in Seconds
135 (57.2)	36	153 (67.2)	34
136 (57.8)	28	155 (68.3)	22
138 (58.9)	18	157 (69.4)	14
140 (60.0)	12	158 (70.0)	0
142 (61.1)	8		
144 (62.2)	5		
145 (62.8)	4		

¹ Holding time may include post-oven heat rise.

7. 140°F (60°C) or above for 15 seconds for raw vegetables and fruit.

B. Exceptions:

1. raw or undercooked whole muscle, intact beef steak to be served or offered for sale in a ready to eat form shall be cooked to 145°F (63°C) or above surface temperature on both the top and bottom and until a cooked color change is achieved on all external surfaces; and

2. all food shall be served in accordance with this Section unless otherwise ordered by the consumer for immediate service, such as but not limited to raw, marinated fish, raw molluscan shellfish, steak tartare, or partially or lightly cooked food, if the food establishment serves a population that is not a highly susceptible population.

AUTHORITY NOTE: Promulgated in accordance with R.S. 40:4.

HISTORICAL NOTE: Promulgated by the Department of Health and Hospitals, Office of Public Health, LR 28:320 (February 2002), repromulgated LR 28:1414 (June 2002), amended LR 28:2531 (December 2002).

§1307. Hot Holding Temperatures
[formerly paragraph 22:09-4]

A. Food stored for hot holding and service shall be held at a temperature of 135°F (57°C) or higher with the exception of roast beef. If roast beef is cooked in accordance with §1305.A.6 of this Chapter the minimum hot holding temperature shall be 130°F (54°C).

AUTHORITY NOTE: Promulgated in accordance with R.S. 40:4.

HISTORICAL NOTE: Promulgated by the Department of Health and Hospitals, Office of Public Health, LR 28:320 (February 2002), amended LR 28:1414 (June 2002), LR 849 (May 2007).

§1309. Cold Holding Temperatures
[formerly paragraph 22:09-5]

A. Food stored for cold holding and service shall be held at a temperature of 41°F (5°C) or below.

AUTHORITY NOTE: Promulgated in accordance with R.S. 40:4.

HISTORICAL NOTE: Promulgated by the Department of Health and Hospitals, Office of Public Health, LR 28:320 (February 2002), amended LR 28:1414 (June 2002).

§1311. Cooling
[formerly paragraph 22:09-6]

A. Cooling of food shall be accomplished by using one or more of the following methods:

1. placing the food in shallow pans;
2. separating the food into smaller or thinner portions;
3. using rapid cooling equipment;
4. stirring the food in a container placed in an ice water bath;
5. using containers that facilitate heat transfer;
6. adding ice as an ingredient;
7. other approved effective methods.

B. Cooked potentially hazardous food shall be cooled:

1. to 70°F (21°C) from 135°F (57°C) within two hours of cooking or hot holding; and
2. to 41°F (5°C) from 70°F (21°C) within four hours or less.

C. Potentially hazardous food, if prepared from ingredients at ambient temperature, shall be cooled to 41°F (5°C) within four hours following preparation.

AUTHORITY NOTE: Promulgated in accordance with R.S. 40:4.

HISTORICAL NOTE: Promulgated by the Department of Health and Hospitals, Office of Public Health, LR 28:320 (February 2002), amended LR 28:1414 (June 2002), LR 33:849 (May 2007).

§1313. Frozen Food
[formerly paragraph 22:09-7]

A. Stored frozen food should be stored at a temperature of 0°F (-17.8°C) or below and shall be maintained frozen.

AUTHORITY NOTE: Promulgated in accordance with R.S. 40:4.

HISTORICAL NOTE: Promulgated by the Department of Health and Hospitals, Office of Public Health, LR 28:321 (February 2002), amended LR 28:1415 (June 2002).

§1315. Thawing
[formerly paragraph 22:09-8]

A. Potentially hazardous food shall be thawed by one of the following methods:

1. under refrigeration that maintains the food temperature at 41°F (5°C) or below;
2. completely submerged under potable running water at a temperature of 70°F (21°C) or below with sufficient velocity to agitate and float off loose particles in an overflow, and for a period of time that does not allow thawed portions of a raw animal food requiring cooking to be above 41°F (5°C) for more than four hours including:
 - a. the time the food is exposed to the running water and the time needed;
 - b. for preparation for cooking; or
 - c. the time it takes under refrigeration to lower the food temperature to 41°F (5°C);
3. as part of the conventional cooking process;

4. thawed in a microwave oven and immediately transferred to conventional cooking equipment and cooked as specified in §1305, with no interruption of the process.

AUTHORITY NOTE: Promulgated in accordance with R.S. 40:4.

HISTORICAL NOTE: Promulgated by the Department of Health and Hospitals, Office of Public Health, LR 28:321 (February 2002), repromulgated LR 28:1415 (June 2002), amended LR 28:2532 (December 2002).

§1317. Time as a Public Health Control
[formerly paragraph 22:09-9]

A. Time only, rather than time in conjunction with temperature, may be used as a public health control for a working supply of potentially hazardous food before cooking, or for ready-to-eat potentially hazardous food before cooking, or for ready-to-eat potentially hazardous food that is displayed or held for service for immediate consumption if:

1. the food is marked or otherwise identified with the time within which it shall be cooked, served or discarded;
2. the food is served or discarded within four hours from the point in time when the food is removed from temperature control;
3. food in unmarked containers or packages, or for which the time expires, is discarded; and
4. written procedures are maintained in the food establishment or retail food store/market and are available to the department upon request.

AUTHORITY NOTE: Promulgated in accordance with R.S. 40:4.

HISTORICAL NOTE: Promulgated by the Department of Health and Hospitals, Office of Public Health, LR 28:321 (February 2002), amended LR 28:1415 (June 2002).

§1319. Parasite Destruction by Freezing

A. Except as specified in Subsection B of this Section, before service or sale in ready-to-eat form, raw, raw-marinated, partially cooked, or marinated-partially cooked fish other than molluscan shellfish shall be frozen throughout to a temperature of:

1. -4°F (-20°C) or below for 168 hours (seven days) in a freezer; or
2. -31°F (-35°C) or below for 15 hours in a blast freezer.

B. If the fish are tuna of the species *Thunnus alalunga*, *Thunnus albacares* (Yellowfin tuna), *Thunnus atlanticus*, *Thunnus maccoyii* (Bluefin tuna, Southern), *Thunnus obesus* (Bigeye tuna), or *Thunnus thynnus* (Bluefin tuna, Northern), the fish may be served or sold in a raw, raw-marinated, or partially cooked ready-to-eat form without freezing as specified under Subsection A of this Section.

C. Except as specified in Subsection B of this Section, if raw, raw-marinated, partially cooked, or marinated-partially cooked fish are served or sold in ready-to-eat form, the person in charge shall record the freezing temperature and

time to which the fish are subjected and shall retain the records at the food establishment or retail food store/market for 90 calendar days beyond the time of service or sale of the fish.

D. If the fish are frozen by a supplier, a written agreement or statement from the supplier stipulating that the fish supplied are frozen to a temperature and for a time specified under §1319 may substitute for the records specified under Subsection C of this Section.

AUTHORITY NOTE: Promulgated in accordance with R.S. 40:4.

HISTORICAL NOTE: Promulgated by the Department of Health and Hospitals, Office of Public Health, LR 28:321 (February 2002), amended LR 28:1415 (June 2002).

§1321. Temperature Measuring Devices
(Thermometers)
[formerly paragraph 22:09-10]

A. Temperature measuring devices shall be provided and used to measure:

1. food temperatures of potentially hazardous food on a device scaled in Fahrenheit (F) accurate to a plus or minus 2°F or Celsius (C) accurate to a plus or minus 1°C and should be able to measure the internal temperature of food products that are less than 1/2 inch thick;
2. the ambient air temperature of all equipment or a simulated product temperature in all equipment used to hold potentially hazardous food on a device scaled in Fahrenheit accurate to a plus or minus 3°F or Celsius accurate to a plus or minus 1.5°C.

AUTHORITY NOTE: Promulgated in accordance with R.S. 40:4.

HISTORICAL NOTE: Promulgated by the Department of Health and Hospitals, Office of Public Health, LR 28:321 (February 2002), repromulgated LR 28:1415 (June 2002), amended LR 28:2532 (December 2002).

Chapter 15. Food Storage

§1501. Protected
[formerly paragraph 22:10-1]

A. Food shall be protected from contamination by storing the food:

1. in a clean, covered container except during periods of preparation or service;
2. in a clean, dry location;
3. where it is not exposed to splash, dust, or other contamination;
4. at least 6 inches (15 cm) above the floor except:
 - i. metal pressurized beverage containers and cased food packages in cans, glass or other waterproof containers need not be elevated when the food container is not exposed to floor moisture;
 - ii. containerized food may be stored on dollies, racks or pallets, provided such equipment is readily movable;

5. so that it is arranged so that cross contamination of raw animal foods of one type with another, or ready to eat foods is prevented.

AUTHORITY NOTE: Promulgated in accordance with R.S. 40:4.

HISTORICAL NOTE: Promulgated by the Department of Health and Hospitals, Office of Public Health, LR 28:322 (February 2002), repromulgated LR 28:1415 (June 2002), amended LR 28:2532 (December 2002).

§1503. Storage
[formerly paragraph 22:10-2]

- A. Food may not be stored:
1. in locker rooms;
 2. in toilet rooms;
 3. in dressing rooms;
 4. in garbage rooms;
 5. in mechanical rooms;
 6. under sewer pipes that are not adequately shielded to intercept potential drips;
 7. under water pipes that are not adequately shielded to intercept potential drips;
 8. under open stairwells;
 9. in vehicles used to transfer or hold any type of waste; or
 10. under other sources of contamination.

AUTHORITY NOTE: Promulgated in accordance with R.S. 40:4.

HISTORICAL NOTE: Promulgated by the Department of Health and Hospitals, Office of Public Health, LR 28:322 (February 2002), repromulgated LR 28:1416 (June 2002), amended LR 28:2532 (December 2002).

§1505. Packaged Food
[formerly paragraph 22:10-3]

A. Packaged food may not be stored in direct contact with ice or water if the food is subject to the entry of water through the packaging, wrapping, or container because of its positioning in the ice or water. Unpackaged food may only be stored in direct contact with drained ice, except:

1. whole, raw fruits or vegetables; cut, raw vegetables such as celery or carrot sticks or cut potatoes; and tofu may be immersed in ice or water;
2. raw chicken and raw fish that are received immersed in ice in shipping containers may remain in that condition while in storage awaiting preparation, display, service or sale.

AUTHORITY NOTE: Promulgated in accordance with R.S. 40:4.

HISTORICAL NOTE: Promulgated by the Department of Health and Hospitals, Office of Public Health, LR 28:322 (February 2002), amended LR 28:1416 (June 2002).

§1507. Date Marking

A. Ready-to-eat, potentially hazardous foods prepared on premise and held under refrigeration for more than 24 hours shall be clearly marked at the time of preparation to indicate the date by which the food shall be consumed, which is, including the day of preparation, seven calendar days.

AUTHORITY NOTE: Promulgated in accordance with R.S. 40:4.

HISTORICAL NOTE: Promulgated by the Department of Health and Hospitals, Office of Public Health, LR 28:322 (February 2002), amended LR 28:1416 (June 2002).

Chapter 17. Food Preparation

§1701. General
[formerly paragraph 22:11-1]

A. During preparation, unpackaged food shall be protected from environmental sources of contamination. Raw fruits and vegetables shall be thoroughly washed in water to remove soil and other contaminants before being cut, combined with other ingredients, cooked, served or offered for human consumption in ready to eat form.

AUTHORITY NOTE: Promulgated in accordance with R.S. 40:4.

HISTORICAL NOTE: Promulgated by the Department of Health and Hospitals, Office of Public Health, LR 28:322 (February 2002), amended LR 28:1416 (June 2002).

§1703. Hand Contact
[formerly paragraph 23:012]

A. Food shall be prepared with the least possible manual contact, with suitable utensils, and on surfaces that have been cleaned, rinsed, and sanitized prior to use to prevent cross-contamination.

AUTHORITY NOTE: Promulgated in accordance with R.S. 40:4.

HISTORICAL NOTE: Promulgated by the Department of Health and Hospitals, Office of Public Health, LR 28:322 (February 2002), amended LR 28:1416 (June 2002).

§1705. Cross Contamination
[formerly paragraph 22:11-3]

- A. Cross contamination shall be prevented by separating:
1. raw animal foods from ready to eat foods, including but not limited to, placing, storing, or displaying ready to eat food above raw animal food;
 2. raw unprepared vegetables from ready to eat potentially hazardous foods; or
 3. certain raw animal foods from each other because of different cooking temperatures except when combining as ingredients.

B. Cross contamination shall be prevented by properly washing, rinsing and sanitizing cutting boards, food preparation surfaces and other food contact surfaces following contact with raw animal foods or raw vegetables and before contact with ready to eat food.

AUTHORITY NOTE: Promulgated in accordance with R.S. 40:4.

HISTORICAL NOTE: Promulgated by the Department of Health and Hospitals, Office of Public Health, LR 28:322 (February 2002), amended LR 28:1416 (June 2002).

§1707. Reconstituted Dry Milk and Dry Milk Products
[formerly paragraph 23:015]

A. Reconstituted dry milk and dry milk products meeting the requirement of Part VII of the state sanitary code may only be used in instant desserts and whipped products, or for cooking and baking purposes.

AUTHORITY NOTE: Promulgated in accordance with R.S. 40:4.

HISTORICAL NOTE: Promulgated by the Department of Health and Hospitals, Office of Public Health, LR 28:322 (February 2002), amended LR 28:1416 (June 2002).

§1709. Molluscan Shellfish
[formerly paragraph 22:11-2]

A. Raw shellfish shall be handled in accordance with Part IX of the state sanitary code, except a HACCP plan is not required and raw shellfish may not be prepackaged by food establishments and retail food stores/markets.

AUTHORITY NOTE: Promulgated in accordance with R.S. 40:4.

HISTORICAL NOTE: Promulgated by the Department of Health and Hospitals, Office of Public Health, LR 28:323 (February 2002), amended LR 28:1416 (June 2002).

Chapter 19. Food Display and Service

§1901. General
[formerly paragraph 22:12-1]

A. Food on display shall be protected from contamination by the use of packaging, counter service line or food/sneeze guards, display cases, or other effective means except for nuts in the shell and whole, raw fruits and vegetables that are intended for hulling, peeling or washing by the consumer before consumption.

B. Proper utensils shall be used for preparation, service and dispensing of food. These utensils shall be stored in accordance with §2519 of this Part.

C. Self service consumers shall not be allowed to use soiled tableware, including single service articles, to obtain additional food from the display and serving equipment. Tableware, including single service articles, shall be made available at the serving display. A sign shall be posted at the serving display prohibiting the reuse of soiled tableware.

D. Food establishments which have a self-service buffet shall provide a sign posted at the location of the self-service buffet which encourages individuals to wash their hands prior to serving themselves. This requirement shall not be applicable to those types of food establishments which are not included in the definition of *food establishment* as per §§101.A and 305.A.1 of this Part.

AUTHORITY NOTE: Promulgated in accordance with R.S. 40:4.

HISTORICAL NOTE: Promulgated by the Department of Health and Hospitals, Office of Public Health, LR 28:323 (February 2002), amended LR 28:1417 (June 2002), LR 33:849 (May 2007).

§1903. Bulk Foods
[formerly paragraph 22:12-2]

A. Bulk foods shall be handled and dispensed in a manner described in §1901 of this Part.

AUTHORITY NOTE: Promulgated in accordance with R.S. 40:4.

HISTORICAL NOTE: Promulgated by the Department of Health and Hospitals, Office of Public Health, LR 28:323 (February 2002), amended LR 28:1417 (June 2002).

§1905. Condiments
[formerly paragraph 22:12-3]

A. Condiments shall be protected from contamination by being kept in dispensers that are designed to provide protection, protected food displays provided with the proper utensils, original containers designed for dispensing, or individual packages or portions.

AUTHORITY NOTE: Promulgated in accordance with R.S. 40:4.

HISTORICAL NOTE: Promulgated by the Department of Health and Hospitals, Office of Public Health, LR 28:323 (February 2002), amended LR 28:1417 (June 2002).

§1907. Ice
[formerly paragraph 22:12-4]

A. Ice for consumer use shall be dispensed only by employees with scoops, tongs, or other ice-self-dispensing utensils or through automatic service ice-dispensing equipment. Ice-dispensing utensils shall be stored in accordance with §2519 of this Part.

B. Ice used as a medium for cooling food such as melons or fish, packaged foods such as canned beverages, or cooling coils and tubes of equipment, shall not be used as food.

AUTHORITY NOTE: Promulgated in accordance with R.S. 40:4.

HISTORICAL NOTE: Promulgated by the Department of Health and Hospitals, Office of Public Health, LR 28:323 (February 2002), amended LR 28:1417 (June 2002).

§1909. Reservice
[formerly paragraph 22:12-5]

A. Once served to a consumer, portions of left-over food shall not be reserved, except:

1. food that is not potentially hazardous, such as crackers and condiments, in an unopened original package and maintained in sound condition may be reserved or resold;

2. food that is dispensed so that it is protected from contamination and the container is closed between uses, such as a narrow-neck bottle containing catsup, steak sauce, or wine.

AUTHORITY NOTE: Promulgated in accordance with R.S. 40:4.

HISTORICAL NOTE: Promulgated by the Department of Health and Hospitals, Office of Public Health, LR 28:323 (February 2002), amended LR 28:1417 (June 2002).

§1911. Special Requirements for Highly Susceptible Populations

A. In a food establishment that serves a highly susceptible population:

1. prepackaged juice or a prepackaged beverage containing juice must be pasteurized;

2. pasteurized shell eggs or pasteurized liquid, frozen, or dry eggs shall be substituted for raw shell eggs in the preparation of:

a. foods such as Caesar salad, hollandaise or Bearnaise sauce, mayonnaise, egg nog, ice cream, and egg-fortified beverages; and

b. recipes in which more than one egg is broken and the eggs are combined except:

i. when combined immediately before cooking for one consumer's serving at a single meal, cooked to 145°F for 15 seconds and served immediately, such as an omelet, souffle, or scrambled eggs;

ii. when combined as an ingredient immediately before baking and the eggs are thoroughly cooked to a ready-to-eat form, such as a cake, muffin, or bread;

3. the following foods may not be served or offered for sale in a ready to eat form:

a. raw animal foods such as raw fish, raw-marinated fish, raw molluscan shellfish, and steak tartare;

b. a partially cooked animal food such as lightly cooked fish, rare meat, soft cooked eggs that are made from raw shell eggs, and meringue; and

c. raw seed sprouts.

AUTHORITY NOTE: Promulgated in accordance with R.S. 40:4.

HISTORICAL NOTE: Promulgated by the Department of Health and Hospitals, Office of Public Health, LR 28:323 (February 2002), amended LR 28:1417 (June 2002), LR 33:849 (May 2007).

Chapter 21. Equipment and Utensils

§2101. General

[formerly paragraph 22:13]

A. All equipment and utensils shall be of construction approved by the state health officer and shall be maintained in good repair.

B. Mollusk and crustacean shells may not be used more than once as serving containers. This prohibition does not apply to the removal of the animal from the shell for preparation then returning the same animal to the same shell for service.

AUTHORITY NOTE: Promulgated in accordance with R.S. 40:4.

HISTORICAL NOTE: Promulgated by the Department of Health and Hospitals, Office of Public Health, LR 28:324

(February 2002), repromulgated LR 28:1417 (June 2002), amended LR 28:2532 (December 2002), amended by the Department of Health, Office of Public Health, LR 43:1392 (July 2017).

§2103. Multi-Use

[formerly paragraph 22:13-1]

A. Materials that are used in the construction of utensils and food contact surfaces of equipment shall not allow the migration of deleterious substances or impart colors, odors, or tastes to food and under normal use conditions shall be:

1. safe;

2. durable, corrosion-resistant, and non absorbent;

3. sufficient in weight and thickness to withstand repeated warewashing;

4. finished to have a smooth, easily cleanable surface; and

5. resistant to pitting, chipping, grazing, scratching, scoring, distortion, and decomposition.

AUTHORITY NOTE: Promulgated in accordance with R.S. 40:4.

HISTORICAL NOTE: Promulgated by the Department of Health and Hospitals, Office of Public Health, LR 28:324 (February 2002), amended LR 28:1417 (June 2002).

§2105. Copper

[formerly paragraph 22:13-2]

A. Copper and copper alloys such as brass shall not be used in contact with a food that has a pH below 6.0, such as vinegar, fruit juice, or wine.

AUTHORITY NOTE: Promulgated in accordance with R.S. 40:4.

HISTORICAL NOTE: Promulgated by the Department of Health and Hospitals, Office of Public Health, LR 28:324 (February 2002), amended LR 28:1418 (June 2002).

§2107. Galvanized Metal

[formerly paragraph 22:13-3]

A. Galvanized metal shall not be used for utensils or food-contact surfaces or equipment that are used for acidic food.

AUTHORITY NOTE: Promulgated in accordance with R.S. 40:4.

HISTORICAL NOTE: Promulgated by the Department of Health and Hospitals, Office of Public Health, LR 28:324 (February 2002), amended LR 28:1418 (June 2002).

§2109. Lead

[formerly paragraph 22:13-4]:

A. Lead in Ceramic, China, and Crystal Utensils—Use Limitation

1. Ceramic, china, crystal utensils, and decorative utensils such as hand painted ceramic or china that are used in contact with food shall be lead-free or contain levels of lead not exceeding the limits of the following utensil categories.

Utensil Category	Description	Maximum Lead mg/L
Hot Beverage Mugs	Coffee Mugs	0.5
Large Hollowware	Bowls 1.1L (1.16 qt)	1

Small Hollowware	Bowls < 1.1L (1.16 qt)	2.0
Flat Utensils	Plates, Saucers	3.0

B. Lead in Pewter Alloys—Use Limitation

1. Pewter alloys containing lead in excess of 0.05 percent shall not be used as a "food-contact surface."

C. Lead in Solder and Flux—Use Limitation

1. Solder and flux containing lead in excess of 0.2 percent shall not be used as a food-contact surface.

AUTHORITY NOTE: Promulgated in accordance with R.S. 40:4.

HISTORICAL NOTE: Promulgated by the Department of Health and Hospitals, Office of Public Health, LR 28:324 (February 2002), amended LR 28:1418 (June 2002).

§2111. Wood [formerly paragraph 22:13-5]

A. Wood and wood wicker shall not be used as a food-contact surface except as follows.

1. Hard maple or an equivalently hard, close-grained wood may be used for:

a. cutting boards, cutting blocks, baker's tables; and utensils, such as rolling pins, doughnut dowels, salad bowls, and chopsticks; and

b. wooden paddles used in confectionery operations for pressure scraping kettles when manually preparing confections at a temperature of 230°F (110°C) or above.

2. Whole, uncut, raw fruits and vegetables, and nuts in the shell may be kept in the wood shipping containers in which they were received, until the fruits, vegetables, or nuts are used.

3. If the nature of the food requires removal of rinds, peels, husks, or shells before consumption, the whole, uncut, raw food may be kept in untreated wood containers or approved treated wood containers complying with the Code of Federal Regulations (CFR).

4. "Cedar-Plank" or "Shingles" may be used as a single-service article if:

a. the food establishment has certified that the "cedar-plank" has not been chemically treated and is in its natural state;

b. the side of the "plank" which will come in contact with the fish must be planed and sanded to a smooth finish.

AUTHORITY NOTE: Promulgated in accordance with R.S. 40:4.

HISTORICAL NOTE: Promulgated by the Department of Health and Hospitals, Office of Public Health, LR 28:324 (February 2002), amended LR 28:1418 (June 2002).

§2113. Non-Food Contact Surfaces [formerly paragraph 22:14]

A. Surfaces of equipment that are exposed to splash, spillage, or other food soiling or that require frequent

cleaning shall be constructed of a corrosion-resistant, non-absorbent, and smooth material.

AUTHORITY NOTE: Promulgated in accordance with R.S. 40:4.

HISTORICAL NOTE: Promulgated by the Department of Health and Hospitals, Office of Public Health, LR 28:324 (February 2002), amended LR 28:1418 (June 2002).

§2115. Single-Service and Single-Use Articles [formerly paragraph 22:15]

A. Single-service and single-use articles shall not be reused.

AUTHORITY NOTE: Promulgated in accordance with R.S. 40:4.

HISTORICAL NOTE: Promulgated by the Department of Health and Hospitals, Office of Public Health, LR 28:325 (February 2002), amended LR 28:1418 (June 2002).

§2117. Gloves, Use Limitations [formerly paragraph 22:16]

A. If used, single use gloves shall be used for only one task such as working with ready-to-eat food or with raw animal food, used for no other purpose, and discarded when damaged or soiled, or when interruptions occur in the operation.

B. Except as specified in Subsection C of this Section, slash-resistant gloves that are used to protect the hands during operations requiring cutting shall be used in direct contact only with food that is subsequently cooked as specified under §1305 of this Part such as frozen food or a primal cut of meat.

C. Slash-resistant gloves may be used with ready-to-eat food that will not be subsequently cooked if the slash-resistant gloves have a smooth, durable, and nonabsorbent outer surface; or if the slash-resistant gloves are covered with a smooth, durable, nonabsorbent glove or a single-use glove.

D. Cloth gloves may not be used in direct contact with food unless the food is subsequently cooked as required under §1305 of this Part such as frozen food or a primal cut of meat.

AUTHORITY NOTE: Promulgated in accordance with R.S. 40:4.

HISTORICAL NOTE: Promulgated by the Department of Health and Hospitals, Office of Public Health, LR 28:325 (February 2002), amended LR 28:1418 (June 2002).

§2119. Food Temperature Measuring Devices [formerly paragraph 22:17]

A. Food temperature measuring devices may not have sensors or stems constructed of glass, except that thermometers with glass sensors or stems that are encased in a shatterproof coating such as candy thermometers may be used.

AUTHORITY NOTE: Promulgated in accordance with R.S. 40:4.

HISTORICAL NOTE: Promulgated by the Department of Health and Hospitals, Office of Public Health, LR 28:325 (February 2002), amended LR 28:1419 (June 2002).

Chapter 23. Requirements for Equipment

§2301. General

[formerly paragraph 22:18-1]

A. Equipment used for cooling, heating and holding cold and hot foods, shall be sufficient in number and capacity to provide food temperatures as specified in this Part.

AUTHORITY NOTE: Promulgated in accordance with R.S. 40:4.

HISTORICAL NOTE: Promulgated by the Department of Health and Hospitals, Office of Public Health, LR 28:325 (February 2002), amended LR 28:1419 (June 2002).

§2303. Manual Warewashing, Sink Compartment Requirements

[formerly paragraph 22:18-2]

A. A sink with at least three compartments shall be provided for manual washing, rinsing and sanitizing equipment and utensils, except:

1. where an approved alternative process is used as specified in Subsection C of this Section; or

2. where there are no utensils or equipment to wash, rinse and sanitize as in a facility with only prepackaged foods.

B. Sink compartments shall be large enough to accommodate immersion of the largest equipment and utensils.

C. When equipment or utensils are too large for the warewashing sink or warewashing machine, the following alternative process may include:

1. high-pressure detergent sprayers;
2. low or line-pressure spray detergent foamers;
3. other task specific cleansing equipment, such as CIP;
4. brushes or other implements.

D. Drainboards, utensil racks, or tables large enough to accommodate all soiled and cleaned items that may accumulate during hours of operation shall be provided for necessary utensil holding before cleaning and after sanitizing. Drainboards for sinks and machines shall be self-draining.

E. A warewashing sink may not be used for handwashing or dumping mop water. Sinks may be used to wash wiping cloths, wash produce and other foods or thaw foods if the sinks are properly washed and sanitized before this use.

AUTHORITY NOTE: Promulgated in accordance with R.S. 40:4.

HISTORICAL NOTE: Promulgated by the Department of Health and Hospitals, Office of Public Health, LR 28:325 (February 2002), amended LR 28:1419 (June 2002).

§2305. Warewashing Machines [formerly paragraph 22:18-3]

A. When provided, a warewashing machine shall have an easily accessible and readable data plate affixed to the machine by the manufacturer that indicates the machine's design and operating specifications including the:

1. temperatures required for washing, rinsing and sanitizing;
2. pressure required for the fresh water sanitizing rinse unless the machine is designed to use only a pumped sanitizing rinse; and
3. conveyor speed for conveyor machines or cycle time for stationary rack machines.

B. Warewashing machine wash and rinse tanks shall be equipped with baffles, curtains, or other means to minimize internal cross contamination of the solutions in wash and rinse tanks.

C. Warewashing machines shall be equipped with a temperature measuring device that indicates the temperature of the water:

1. in each wash and rinse tank; and
2. as the water enters the hot water sanitizing final rinse manifold or in the chemical sanitizing solution tank.

D. Warewashing machines that provide a fresh hot water sanitizing rinse shall be equipped with a pressure gauge or similar device such as a transducer that measures and displays the water pressure in the supply line immediately before entering the warewashing machine.

E. Warewashing machines shall be operated in accordance with the machine's data plate and other manufacturer's specifications.

AUTHORITY NOTE: Promulgated in accordance with R.S. 40:4.

HISTORICAL NOTE: Promulgated by the Department of Health and Hospitals, Office of Public Health, LR 28:325 (February 2002), amended LR 28:1419 (June 2002).

Chapter 25. Cleaning of Equipment and Utensils

§2501. General

[formerly paragraph 22:19-1]

A. Equipment food-contact surfaces and utensils shall be clean to sight and touch.

B. The food-contact surfaces of cooking equipment and pans shall be kept free of encrusted grease deposits and other accumulations.

C. Nonfood-contact surfaces of equipment shall be kept free of an accumulation of dust, dirt, food residue, and other debris.

AUTHORITY NOTE: Promulgated in accordance with R.S. 40:4.

HISTORICAL NOTE: Promulgated by the Department of Health and Hospitals, Office of Public Health, LR 28:326 (February 2002), amended LR 28:1419 (June 2002).

§2503. Frequency of Cleaning
[formerly paragraph 22:19-2]

A. Equipment food contact surfaces and utensils shall be cleaned:

1. before each use with a different type of raw animal food such as beef, seafood, lamb, pork, or poultry, except when the food contact surface or utensil is in contact with a succession of different raw animal foods each requiring a higher cooking temperature, as specified in §1305, than the previous food, such as raw fish followed by raw poultry on the same cutting board;

2. each time there is a change from working with raw foods to working with ready to eat foods;

3. between uses with raw fruits or vegetables and with potentially hazardous food;

4. before using or storing a temperature measuring device;

5. at any time during the operation when contamination may have occurred.

B. Equipment food-contact surfaces and utensils used with potentially hazardous food shall be cleaned throughout the day at least every four hours.

C. Nonfood-contact surfaces of equipment shall be cleaned at a frequency necessary to preclude accumulation of soil residues.

D. Warewashing equipment, including machines and the compartments of sinks, basins or other receptacles used for washing and rinsing equipment, utensils, or raw foods, or laundering wiping cloths; and drainboards or other equipment used to substitute for drainboards, shall be cleaned:

1. before use;

2. throughout the day at a frequency necessary to prevent recontamination of equipment and utensils and to ensure that the equipment performs its intended function; and

3. if used, at least every 24 hours.

AUTHORITY NOTE: Promulgated in accordance with R.S. 40:4.

HISTORICAL NOTE: Promulgated by the Department of Health and Hospitals, Office of Public Health, LR 28:326 (February 2002), repromulgated LR 28:1420 (June 2002), amended LR 28:2532 (December 2002).

§2505. Cleaning Agents
[formerly paragraph 22:19-3]

A. The wash compartment of a sink, mechanical warewasher, or other alternative process as specified in §2303.C of this Part, when used for warewashing, shall contain a wash solution of soap, detergent, acid cleaner, alkaline cleanser, degreaser, abrasive cleaner, or other cleaning agent according to the cleaning agent manufacturer's label instruction.

AUTHORITY NOTE: Promulgated in accordance with R.S. 40:4.

HISTORICAL NOTE: Promulgated by the Department of Health and Hospitals, Office of Public Health, LR 28:326 (February 2002), amended LR 28:1420 (June 2002).

§2507. Temperature of Wash Solution
[formerly paragraph 22:19-4]

A. The temperature of the wash solution in manual warewashing equipment shall be maintained at not less than 110°F (43°C) unless a different temperature is specified on the cleaning agent manufacturer's label instruction.

B. The temperature of the wash solution in spray type warewashers that use hot water to sanitize may not be less than:

1. for a single tank, stationary rack, single temperature machine, 165°F (74°C);

2. for a single tank, conveyor, dual temperature machine, 160°F (71°C);

3. for a single tank, stationary rack, dual temperature machine, 150°F (66°C);

4. for a multitank, conveyor, multitemperature machine, 150°F (66°C).

C. The temperature of the wash solution in spray type warewashers that use chemicals to sanitize may not be less than 120°F (49°C).

AUTHORITY NOTE: Promulgated in accordance with R.S. 40:4.

HISTORICAL NOTE: Promulgated by the Department of Health and Hospitals, Office of Public Health, LR 28:326 (February 2002), amended LR 28:1420 (June 2002).

§2509. Methods of Cleaning
[formerly paragraph 22:19-5]

A. Precleaning

1. Food debris on equipment and utensils shall be scrapped over a waste disposal unit, scupper, or garbage receptacle or shall be removed in a warewashing machine with a prewash cycle.

2. If necessary for effective cleaning, utensils and equipment shall be pre-flushed, pre-soaked, or scrubbed with abrasives.

B. Loading. Soiled items to be cleaned in a warewashing machine shall be loaded into racks, trays, or baskets or onto conveyors in a position that:

1. exposes the items to the unobstructed spray from all cycles and;

2. allows the items to drain.

C. Wet Cleaning

1. Equipment food-contact surfaces and utensils shall be effectively washed to remove or completely loosen soils by using the manual or mechanical means necessary such as the application of detergents containing wetting agents and emulsifiers; acid, alkaline, or abrasive cleaners; hot water; brushes; scouring pads; high-pressure sprays; or ultrasonic devices.

2. The washing procedures selected shall be based on the type and purpose of equipment or utensil, and on the type of soil to be removed.

3. Equipment shall be disassembled as necessary to allow access of the detergent solution to all parts.

AUTHORITY NOTE: Promulgated in accordance with R.S. 40:4.

HISTORICAL NOTE: Promulgated by the Department of Health and Hospitals, Office of Public Health, LR 28:326 (February 2002), amended LR 28:1420 (June 2002).

§2511. Rinsing Procedures
[formerly paragraph 22:19-6]

A. Washed utensils and equipment shall be rinsed so that abrasives are removed and cleaning chemicals are removed or diluted through the use of water or other solutions. A distinct, separate water rinse after washing and before sanitizing shall be used with:

1. a three compartment sink;
2. an alternative manual warewashing equipment equivalent to a three compartment sink as specified in §2303.C of this Part;
3. a three-step washing, rinsing and sanitizing procedure in a warewashing system for CIP equipment.

AUTHORITY NOTE: Promulgated in accordance with R.S. 40:4.

HISTORICAL NOTE: Promulgated by the Department of Health and Hospitals, Office of Public Health, LR 28:327 (February 2002), amended LR 28:1420 (June 2002).

§2513. Sanitization
[formerly paragraph 22:19-7]

A. After the food-contact surfaces of all equipment and utensils are washed and rinsed, they shall be sanitized before use. Clean food-contact surfaces of all equipment and utensils shall be sanitized in:

1. hot water:
 - a. if immersion in hot water is used in manual operation, the temperature of the water shall be maintained at 171°F (77°C) or above;
 - b. in a mechanical operation, the temperature of the hot water rinse as it enters the manifold may not be more than 194°F (90°C) or less than:
 - i. for a single tank, stationary rack, single temperature machine, 165°F (74°C); or
 - ii. for all other machines, 180°F (82°C). This should achieve a utensil surface temperature of 160°F (71°C) as measured by an irreversible registering temperature indicator;
 - c. in a mechanical operation using a hot water rinse, the flow pressure may not be less than 15 pounds per square inch or more than 25 pounds per square inch as measured in the water line immediately upstream from the fresh hot water sanitizing rinse control valve;
2. chemicals:

a. only a chemical sanitizer listed in 21 CFR 178.1010, Sanitizing Solutions, shall be used in a sanitizing solution for manual or mechanical operation at the specified exposure times. These sanitizing solutions shall be used in accordance with the EPA approved manufacturers label use instructions, and shall be used as follows:

i. a chlorine solution shall have a minimum temperature based on the concentration and pH of the solution as listed in the following chart:

Minimum Concentration	Minimum Temperature	Minimum Temperature
MG/L or ppm	>pH 8 - pH 10	pH 8 or less
25 ppm	120°F (49°C)	120°F (49°C)
50 ppm	100°F (38°C)	75°F (24°C)
100 ppm	55°F (13°C)	55°F (13°C)

ii. an iodine solution shall have a:

- (a). minimum temperature of 75°F (24°C);
- (b). pH of 5.0 or less, unless the manufacturer's use directions included in the labeling specify a higher pH limit of effectiveness; and
- (c). concentration between 12.5 mg/L and 25 mg/L(ppm);

iii. a quarternary ammonium compound solution shall:

- (a). have a minimum temperature of 75°F (24°C);
- (b). have a concentration of 200 mg/L (ppm) or as indicated by the manufacturer's use directions included in labeling; and
- (c). be used only in water with 500 mg/L (ppm) hardness or less;

iv. other solutions of the chemicals specified in Clauses i, ii, and iii of this Subparagraph may be used if demonstrated to the department to achieve sanitization and approved by the department; or

v. other chemical sanitizers may be used if they are applied in accordance with the manufacturer's use directions included in the labeling;

b. chemical, manual or mechanical operations, including the applications of sanitizing chemicals by immersion, manual swabbing, brushing, or pressure spraying methods, using a solution as specified in §2513.A.2.a of this Section shall be used to provide the following:

- i. an exposure time of at least 10 seconds for a chlorine solution;
- ii. an exposure time of at least 30 seconds for other chemical sanitizer solutions; or
- iii. an exposure time used in relationship with a combination of temperature, concentration, and pH that, when evaluated for efficacy, yields sanitization as defined in this Part;

c. a test kit or other device that accurately measures the concentration in mg/L or parts per million (ppm) of sanitizing solution shall be provided.

AUTHORITY NOTE: Promulgated in accordance with R.S. 40:4.

HISTORICAL NOTE: Promulgated by the Department of Health and Hospitals, Office of Public Health, LR 28:327 (February 2002), amended LR 28:1421 (June 2002).

§2515. Air Drying
[formerly paragraph 22:19-8]

A. Except as specified in Subsection C of this Section, after cleaning and sanitizing, equipment and utensils may not be cloth-dried.

B. Equipment and utensils shall be air-dried or used after adequate draining as specified in Paragraph (a) of 21 CFR 178.1010 Sanitizing Solutions, before contact with food.

C. Utensils that have been air-dried may be polished with cloths that are maintained clean and dry.

AUTHORITY NOTE: Promulgated in accordance with R.S. 40:4.

HISTORICAL NOTE: Promulgated by the Department of Health and Hospitals, Office of Public Health, LR 28:327 (February 2002), amended LR 28:1421 (June 2002).

§2517. Storage of Clean Equipment and Utensils
[formerly paragraph 22:19-9]

A. Except as specified in Subsection D of this Section, cleaned equipment, utensils and single-service and single use articles shall be stored:

1. in a clean dry location;
2. where they are not exposed to splash, dust, or contamination; and
3. at least 6 inches (15 cm) above the floor.

B. Clean equipment and utensils shall be stored as specified under Subsection A of this Section and shall be stored:

1. in a self-draining position that permits air drying; and
2. covered or inverted.

C. Single-service and single-use articles shall be stored as specified under Subsection A of this Section and shall be kept in the original protective package or stored by using other means that afford protection from contamination until used.

D. Items that are kept in closed packages may be stored less than 6 inches (15 cm) above the floor on dollies, pallets, racks, or skids provided that the storage equipment is designed so that it may be moved by hand or by conveniently available equipment such as hand trucks and forklifts.

AUTHORITY NOTE: Promulgated in accordance with R.S. 40:4.

HISTORICAL NOTE: Promulgated by the Department of Health and Hospitals, Office of Public Health, LR 28:328 (February 2002), amended LR 28:1421 (June 2002).

§2519. In-Use and Between-Use Utensil Storage
[formerly paragraph 22:19-10]

A. During pauses in food preparation or dispensing, food preparation dispensing utensils shall be stored:

1. in the food:
 - a. with their handles above the top of the food and the container;
 - b. with their handles above the top of the food within containers or equipment that can be closed, if such food is not potentially hazardous, such as bins of sugar, flour, or cinnamon;

2. on a clean portion of the food preparation table or cooking equipment only if the in-use utensil and the food-contact surface of the food preparation table or cooking equipment are cleaned and sanitized at a frequency specified under §2503 of this Part;

3. in running water of sufficient velocity to flush particulate matter to the drain, if used with moist food such as ice cream or mashed potatoes; or

4. in a clean, protected location if the utensils, such as ice scoops, are used only with a food that is not potentially hazardous;

5. in a container of water if the water is maintained at a temperature of at least 140°F (60°C) and the container is cleaned at least once every 24 hours or at a frequency necessary to preclude accumulation of soil residues.

AUTHORITY NOTE: Promulgated in accordance with R.S. 40:4.

HISTORICAL NOTE: Promulgated by the Department of Health and Hospitals, Office of Public Health, LR 28:328 (February 2002), amended LR 28:1422 (June 2002).

Chapter 27. Water Supply

§2701. General
[formerly paragraph 22:20-1]

A. Sufficient quantities of potable water for the needs of the food establishment or retail food store/market shall be provided in accordance with Part XII of the state sanitary code.

AUTHORITY NOTE: Promulgated in accordance with R.S. 40:4.

HISTORICAL NOTE: Promulgated by the Department of Health and Hospitals, Office of Public Health, LR 28:328 (February 2002), amended LR 28:1422 (June 2002).

§2703. Pressure
[formerly paragraph 22:20-2]

A. Water under pressure shall be provided to all fixtures, equipment, and nonfood equipment that are required to use water.

AUTHORITY NOTE: Promulgated in accordance with R.S. 40:4.

HISTORICAL NOTE: Promulgated by the Department of Health and Hospitals, Office of Public Health, LR 28:328 (February 2002), amended LR 28:1422 (June 2002).

§2705. Hot Water
[formerly paragraph 22:20-3]

A. Hot water shall be provided to all fixtures, equipment and nonfood equipment as required and the generation and distribution system shall be sufficient to meet the peak hot water demands throughout the food establishment or retail food store/market.

AUTHORITY NOTE: Promulgated in accordance with R.S. 40:4.

HISTORICAL NOTE: Promulgated by the Department of Health and Hospitals, Office of Public Health, LR 28:328 (February 2002), amended LR 28:1422 (June 2002).

§2707. Steam
[formerly paragraph 22:20-4]

A. Steam used in contact with food or food contact surfaces shall be free of deleterious materials or additives.

AUTHORITY NOTE: Promulgated in accordance with R.S. 40:4.

HISTORICAL NOTE: Promulgated by the Department of Health and Hospitals, Office of Public Health, LR 28:328 (February 2002), amended LR 28:1422 (June 2002).

§2709. Bottled Water
[formerly paragraph 22:20-5]

A. Bottled and packaged potable water shall be obtained from a source that complies with Part VI of the State Sanitary Code and the Food, Drug and Cosmetic Law and Regulations. Bottled and packaged potable water, if used, shall be handled and stored in a way that protects it from contamination and shall be dispensed from the original container.

AUTHORITY NOTE: Promulgated in accordance with R.S. 40:4.

HISTORICAL NOTE: Promulgated by the Department of Health and Hospitals, Office of Public Health, LR 28:328 (February 2002), amended LR 28:1422 (June 2002).

Chapter 29. Sewage

§2901. General
[formerly paragraph 22:21-1]

A. All sewage from retail food establishments or retail food stores/markets shall be disposed of through an approved sewerage system/facility in accordance with Part XIII of the state sanitary code.

AUTHORITY NOTE: Promulgated in accordance with R.S. 40:4.

HISTORICAL NOTE: Promulgated by the Department of Health and Hospitals, Office of Public Health, LR 28:329 (February 2002), amended LR 28:1422 (June 2002).

Chapter 31. Plumbing

§3101. General
[formerly paragraph 22:22-1]

A. Plumbing shall be sized, installed, and maintained in accordance with Part XIV of the state sanitary code.

AUTHORITY NOTE: Promulgated in accordance with R.S. 40:4.

HISTORICAL NOTE: Promulgated by the Department of Health and Hospitals, Office of Public Health, LR 28:329 (February 2002), amended LR 28:1422 (June 2002).

§3103. Cross-Connection
[formerly paragraph 22:22-2]

A. There shall be no cross-connection between the potable water supply and any other source of water of lesser quality including any source of pollution from which the potable water supply might become contaminated.

AUTHORITY NOTE: Promulgated in accordance with R.S. 40:4.

HISTORICAL NOTE: Promulgated by the Department of Health and Hospitals, Office of Public Health, LR 28:329 (February 2002), amended LR 28:1423 (June 2002).

§3105. Backflow
[formerly paragraph 22:22-3]

A. Backflow shall be prevented by:

- installing an air gap in the water distribution system between the water supply inlet and the flood level rim of the plumbing fixture, equipment, or nonfood equipment which is at least twice the diameter of the water supply inlet (or generally, three times the diameter if affected by a nearby wall); or

- installing an approved backflow or backsiphonage prevention device installed and maintained on a water line in accordance with Part XIV of the state sanitary code;

- not having a direct connection between the drainage system and any drain line originating from food handling equipment (e.g., any sink where food is cleaned, peeled, cut up, rinsed, battered, defrosted, or otherwise prepared or handled; potato peelers; ice cream dipper wells; refrigerators; freezers; walk-in coolers and freezers; ice boxes; ice making machines, fountain type drink dispensers; rinse sinks, cooling or refrigeration coils; laundry washers; extractors; steam tables; egg boilers; coffee urns; or similar equipment).

EXCEPTION: A commercial dishwashing (warewashing) machine may have a direct connection between its waste outlet and a floor drain when the machine is located within 5 feet (1.5m) of a trapped floor drain and the machine outlet is connected to the inlet side of a properly vented floor drain trap.

AUTHORITY NOTE: Promulgated in accordance with R.S. 40:4.

HISTORICAL NOTE: Promulgated by the Department of Health and Hospitals, Office of Public Health, LR 28:329 (February 2002), repromulgated LR 28:1423 (June 2002), amended LR 28:2532 (December 2002).

§3107. Non-Potable Water System
[formerly paragraph 22:22-4]

A. A non-potable water system is permitted only for purposes such as air conditioning and fire protection, provided the system is installed in accordance with Part XII and Part XIV of the state sanitary code and:

1. the non potable water does not contact directly or indirectly, food, potable water equipment that contacts food, or utensils; and

2. the piping of any nonpotable water system shall be easily identified so that it is readily distinguishable from piping that carries potable water.

AUTHORITY NOTE: Promulgated in accordance with R.S. 40:4.

HISTORICAL NOTE: Promulgated by the Department of Health and Hospitals, Office of Public Health, LR 28:329 (February 2002), amended LR 28:1423 (June 2002).

§3109. Lavatory Facilities
[formerly paragraph 22:22-5]

A. All lavatory fixtures shall be installed in accordance with Part XIV of the state sanitary code and:

1. at least one handwashing lavatory shall;

a. be located to permit convenient use by all employees in food preparation areas and utensil washing areas including the produce, meat and seafood markets;

b. also be located in or immediately adjacent to toilet rooms;

2. lavatories shall be accessible to employees at all times;

3. lavatories shall be equipped to provide a flow of water at a temperature of at least 85°F (30°C) through a mixing valve or combination faucet;

4. if a self-closing, slow-closing, or metering faucet is used, it shall provide a flow of water for at least 15 seconds without the need to reactivate the faucet;

5. steam mixing valves are prohibited;

6. a supply of hand-cleansing soap or detergents shall be available at each lavatory. A supply of individual disposable towels, a continuous towel system that supplies the user with a clean towel or a heat-air drying device shall be available at each lavatory. The use of common towels is prohibited;

7. lavatories, soap dispensers, hand-drying devices and all related fixtures shall be kept clean and in good repair;

8. a handwashing lavatory may not be used for purposes other than handwashing.

AUTHORITY NOTE: Promulgated in accordance with R.S. 40:4.

HISTORICAL NOTE: Promulgated by the Department of Health and Hospitals, Office of Public Health, LR 28:329 (February 2002), amended LR 28:1423 (June 2002).

§3111. Toilet Facilities
[formerly paragraph 22:22-6]

A. All toilet fixtures and facilities shall be installed in accordance with Part XIV of the state sanitary code and:

1. toilet fixtures and facilities shall be the number required, shall be conveniently located, and accessible to employees at all times;

2. a toilet room located on the premises shall be completely enclosed and provided with a solid tight-fitting

and self-closing door except that this requirement does not apply to a toilet room that is located outside a food establishment or retail food store/market and does not open directly into the food establishment or retail food store/market, such as but not limited to shopping malls, airports, or other places of public assembly;

3. toilet rooms shall be mechanically vented to the outside atmosphere;

4. toilet fixtures and facilities shall be kept clean and in good repair. A supply of toilet tissue shall be provided at each toilet at all times. Easily cleanable receptacles shall be provided for waste materials with at least one covered waste receptacle in toilet rooms used by women.

B. Floor drains will be provided in restrooms in accordance with Part XIV of the state sanitary code.

AUTHORITY NOTE: Promulgated in accordance with R.S. 40:4.

HISTORICAL NOTE: Promulgated by the Department of Health and Hospitals, Office of Public Health, LR 28:329 (February 2002), repromulgated LR 28:1423 (June 2002), amended LR 28:2533 (December 2002).

§3113. Grease Traps
[formerly paragraph 22:22-7]

A. An approved type grease trap shall be installed in accordance with Part XIV of the state sanitary code and:

1. it shall be installed in the waste line leading from the sinks, drains and other fixtures or equipment where grease may be introduced in the drainage or sewage system in quantities that may affect line stoppage or hinder sewage treatment;

2. a grease trap, if used, shall be located to be easily accessible for cleaning and shall be serviced as often as necessary.

AUTHORITY NOTE: Promulgated in accordance with R.S. 40:4.

HISTORICAL NOTE: Promulgated by the Department of Health and Hospitals, Office of Public Health, LR 28:330 (February 2002), amended LR 28:1424 (June 2002).

§3115. Garbage Grinders
[formerly paragraph 22:22-8]

A. If used, garbage grinders shall be installed and maintained in accordance with Part XIV of the state sanitary code.

AUTHORITY NOTE: Promulgated in accordance with R.S. 40:4.

HISTORICAL NOTE: Promulgated by the Department of Health and Hospitals, Office of Public Health, LR 28:330 (February 2002), amended LR 28:1424 (June 2002).

§3117. Utility or Service Sink
[formerly paragraph 22:22-9]

A. At least one service sink provided with hot and cold water, or one curbed cleaning facility equipped with a floor drain and hot and cold water, shall be provided and conveniently located for the cleaning of mops or similar wet floor cleaning tools and for the disposal of mop water and

similar waste. The sink shall be located in an area to avoid food contamination.

B. The use of lavatories, utensil washing, equipment washing, or food preparation sinks as a utility or service sink is prohibited.

C. In some special applications, because of space restrictions or unique situations, when the risk of contamination is low in the opinion of the state health officer, a large utility/service sink may be used as a handwashing sink.

AUTHORITY NOTE: Promulgated in accordance with R.S. 40:4.

HISTORICAL NOTE: Promulgated by the Department of Health and Hospitals, Office of Public Health, LR 28:330 (February 2002), repromulgated LR 28:1424 (June 2002), amended LR 28:2533 (December 2002).

§3119. Minimum Plumbing Fixtures

Editor’s Note: These pre-existing regulations are being re-codified as LAC 51:XXIII.3119. These regulations can also be viewed in LAC 51:XIV.411.

A. Table 411 of Part XIV (LAC 51:XIV.Table 411) lists the minimum number of plumbing fixtures required for retail food service establishments under the following building or occupancy classifications:

1. retail stores;
2. restaurants/food service establishments; and,
3. clubs, lounges, and restaurants/food service establishments with club, or lounge.

B. The following serves to clarify the basic requirements and exceptions to Table 411 itself as may be applicable to retail food service establishments:

1. With the exception of retail stores associated with retail fuel stations and/or restaurant/food service establishments associated with retail fuel stations and retail stores that require 2 or more different food permits (see Paragraph 3 below), a single facility consisting of one water closet and one lavatory may be used by both males and females in the following occupancies subject to the building area limitations:

Occupancy	Total Building Area (sq ft)
Retail Store (within covered mall)	3500

Occupancy	Usable Floor Space (sq ft)
Restaurant/Food Service Establishment (excluding retail fuel stations)	500
Retail Store (excluding retail fuel stations)	1500*

* A single facility [normally allowed under this Paragraph for a retail store occupancy (excluding retail fuel stations)] does not apply when the conditions of Subparagraph 3.a. below exist.

2. If alcoholic beverages are to be served, facilities shall be as required for clubs or lounges; however, this requirement shall not be construed to require a restaurant/food service establishment which serves alcoholic beverages and consists of 500 square feet or less of usable floor space to add any more toilet rooms than the minimum required pursuant to Paragraph 1 above (as long as such small restaurant/food service establishment does not have a wet bar and thus would not fall under the “Club, Lounge, and Restaurants/Food Service Establishments with Club, or Lounge” occupancy classification).

3.a. A retail store which requires two or more different food permits (e.g., Grocery Permit, Restaurant Permit, etc.) under this Part and has a combined usable floor space of more than 500 square feet shall be required to provide no less than a minimum of two facilities consisting of one water closet and one lavatory each.

b. A retail store which requires two or more different food permits under this Part and has a combined usable floor space of 500 square feet or less shall be allowed to operate with a single facility consisting of one water closet and one lavatory used by both males and females. The allowance to operate with a single facility assumes that a wet bar is not located on the premises.

4. The drinking fountain requirement under the building or occupancy classifications listed in Subsection A above may be waived for certain food service establishments if drinking water is dispensed in an approved, sanitary manner in accord with the requirements of this Part. Minimally, the food service establishment facility shall hold a health permit from DHH-OPH which requires a 3 compartment sink and a hand wash lavatory in the food preparation area. Any food service establishment facility issued a health permit under the requirements of the this Part but not meeting the minimum sink/hand wash lavatory requirement [such as grocery store serving pre-packaged food items only (equivalent to a retail store)] shall install a publicly accessible drinking fountain(s) in accordance with the requirements of Table 411 of Part XIV.

AUTHORITY NOTE: Promulgated in accordance with provisions of R.S. 40:4 and R.S. 40:5.

HISTORICAL NOTE: Promulgated by the Department of Health and Hospitals, Office of Public Health, LR 38:2926 (November 2012).

Chapter 33. Garbage, Rubbish and Refuse

§3301. General [formerly paragraph 22:23-1]

A. All garbage, rubbish and refuse shall be handled in accordance with Part XXVII of the state sanitary code.

AUTHORITY NOTE: Promulgated in accordance with R.S. 40:4.

HISTORICAL NOTE: Promulgated by the Department of Health and Hospitals, Office of Public Health, LR 28:330 (February 2002), amended LR 28:1424 (June 2002).

§3303. Receptacles for Garbage, Rubbish and Refuse
[formerly paragraph 22:223-2]

A. Equipment and receptacles for refuse, recyclables, returnables, and for use with materials containing food residue shall be durable, cleanable, insect and rodent resistant, leakproof, and nonabsorbent.

B. Plastic bags and wet strength paper bags may be used to line receptacles for storage of garbage, etc., inside the retail food establishment or retail food store/market, or within closed outside receptacles.

C. Outside receptacles for garbage, etc., shall have tight-fitting lids, doors, or covers and shall be kept closed.

D. There shall be a sufficient number of receptacles to hold all the garbage and refuse that accumulates. They shall be emptied when full. All garbage, rubbish and refuse shall be disposed of in an approved manner pursuant to applicable state laws and regulations.

E. Soiled receptacles shall be cleaned at a frequency to prevent a nuisance or the attraction of insects and rodents.

F. Liquid waste from compacting shall be disposed of as sewage.

AUTHORITY NOTE: Promulgated in accordance with R.S. 40:4.

HISTORICAL NOTE: Promulgated by the Department of Health and Hospitals, Office of Public Health, LR 28:330 (February 2002), amended LR 28:1424 (June 2002).

§3305. Incineration
[formerly paragraph 22:23-3]

A. Where garbage, rubbish or refuse is burned on the premises, it shall be done by incineration in accordance with the rules and regulations of the Louisiana Department of Environmental Quality.

AUTHORITY NOTE: Promulgated in accordance with R.S. 40:4.

HISTORICAL NOTE: Promulgated by the Department of Health and Hospitals, Office of Public Health, LR 28:330 (February 2002), amended LR 28:1424 (June 2002).

§3307. Cleaning and Storage
[formerly paragraph 22:23-4]

A. Indoor garbage or refuse storage rooms, if used, shall be constructed of easily cleanable, nonabsorbent washable materials, shall be kept clean, shall be insect and rodent proof and shall be large enough to store the garbage and refuse that accumulates.

B. Outdoor garbage or refuse storage area surfaces shall be constructed of non-absorbent material such as concrete or asphalt and shall be smooth, durable, and sloped for drainage.

C. Suitable cleaning equipment and supplies such as high pressure pumps, steam, and detergent shall be provided as necessary and hot and cold water shall be provided in accordance with Part XIV of the state sanitary code for effective cleaning of equipment and receptacles.

D. Liquid waste from the cleaning operation and from the leakage of garbage containers holding putrescible wastes shall be disposed of as sewage. Methods used for this disposal shall prevent rainwater and runoff from adjacent areas from entering the sanitary sewerage system (i.e., dumpster pads may be elevated or curbed, enclosed or covered). When determined by the state health officer that liquid wastes or putrescible wastes contain grease (or, for new establishments, will likely contain grease in the future), an approved grease trap, grease interceptor, or large capacity grease interceptor shall be installed in the waste line in accordance with LAC 51:XIV.1005.D.

E. If approved by the state health officer, off-premises-based cleaning services may be used if on-premises cleaning implements and supplies are not provided.

F. Outdoor premises used for storage of garbage, rubbish, refuse, recyclables and returnables shall be maintained clean and free of litter.

AUTHORITY NOTE: Promulgated in accordance with provisions of R.S. 40:4 and R.S. 40:5.

HISTORICAL NOTE: Promulgated by the Department of Health and Hospitals, Office of Public Health, LR 28:330 (February 2002), repromulgated LR 28:1424 (June 2002), amended LR 28:2533 (December 2002), LR 38:2927 (November 2012).

Chapter 35. Insects and Rodent Control

§3501. General
[formerly paragraph 22:24-1]

A. Insects and rodents shall be controlled in accordance with Part V of the state sanitary code.

AUTHORITY NOTE: Promulgated in accordance with R.S. 40:4.

HISTORICAL NOTE: Promulgated by the Department of Health and Hospitals, Office of Public Health, LR 28:331 (February 2002), amended LR 28:1425 (June 2002).

§3503. Insect Control Devices
[formerly paragraph 22:24-2]

A. Insect control devices that are used to electrocute or stun flying insects shall be designed to retain the insect within the device.

B. Insect control devices shall be installed so that:

1. the devices are not located over a food preparation area; and

2. dead insects and insect fragments are prevented from being impelled onto or falling on exposed food; clean equipment, utensils, and linens; and unwrapped single-service and single-use articles.

AUTHORITY NOTE: Promulgated in accordance with R.S. 40:4.

HISTORICAL NOTE: Promulgated by the Department of Health and Hospitals, Office of Public Health, LR 28:331 (February 2002), amended LR 28:1425 (June 2002).

§3505. Openings**[formerly paragraph 22:24-3]**

A. Openings to a portion of the building that is part of the food establishment, or retail food store/market, or to the outdoors shall be protected against the entry of insects and rodents by:

1. filling or closing holes and other gaps along floors, walls and ceilings;
2. closed, tight-fitting windows;
3. solid, self-closing, tight-fitting doors; or
4. if windows or doors are kept open for ventilation or other purposes, the openings shall be protected against the entry of insects by:
 - a. 16 mesh to the inch (25.4 mm) screens;
 - b. properly designed and installed air curtains; or
 - c. other effective means approved by the department.

B. Establishment location, weather or other limiting conditions may be considered as part of an overall flying insect and other pest control program.

AUTHORITY NOTE: Promulgated in accordance with R.S. 40:4.

HISTORICAL NOTE: Promulgated by the Department of Health and Hospitals, Office of Public Health, LR 28:331 (February 2002), amended LR 28:1425 (June 2002), LR 33:849 (May 2007).

§3507. Premises**[formerly paragraph 22:24-2]**

A. The premises shall be free of:

1. items that are unnecessary to the operation or maintenance of the food establishment, or retail food store/market, such as equipment that is nonfunctional or no longer used; and
2. litter.

B. The premises shall be kept free of pests by:

1. routinely inspecting the premises for evidence of pests; and
2. using methods of control approved by law.

C. Outdoor walking and driving areas shall be surfaced with concrete, asphalt, gravel or other materials that have been effectively treated to minimize dust, facilitate maintenance, drain properly and prevent muddy conditions.

AUTHORITY NOTE: Promulgated in accordance with R.S. 40:4.

HISTORICAL NOTE: Promulgated by the Department of Health and Hospitals, Office of Public Health, LR 28:331 (February 2002), amended LR 28:1425 (June 2002).

Chapter 37. Physical Facilities**§3701. Floors****[formerly paragraph 22:25]**

A. Floors shall be constructed of smooth, durable, nonabsorbent and easily cleanable material.

B. Closely woven and easily cleanable carpet may be used in certain areas of the food establishment or retail food store/market except where food is prepared and processed.

C. Properly installed floor drains shall be provided in toilet rooms, seafood and meat markets and in all areas where water flush cleaning methods are used. The floor shall be sloped to the floor drain.

D. Floors shall be maintained clean and in good repair.

AUTHORITY NOTE: Promulgated in accordance with R.S. 40:4.

HISTORICAL NOTE: Promulgated by the Department of Health and Hospitals, Office of Public Health, LR 28:331 (February 2002), amended LR 28:1425 (June 2002).

§3703. Walls and Ceilings**[formerly paragraph 22:26]**

A. Walls and ceilings in the food preparation areas and equipment-utensil washing areas shall be constructed of light colored, smooth, durable and easily cleanable materials.

B. Utility service lines, pipes, exposed studs, joists, rafters and decorative items shall not be unnecessarily exposed in food preparation and processing areas. When exposed in other areas of the food establishment or retail food store/market, they shall be installed so they do not obstruct or prevent cleaning of the walls and ceilings.

C. Walls, ceilings, and any attachments shall be maintained clean and in good repair.

AUTHORITY NOTE: Promulgated in accordance with R.S. 40:4.

HISTORICAL NOTE: Promulgated by the Department of Health and Hospitals, Office of Public Health, LR 28:331 (February 2002), amended LR 28:1425 (June 2002).

§3705. Lighting Intensity**[formerly paragraph 22:27-1]**

A. The lighting intensity:

1. in walk-in refrigeration units and dry food storage areas, and in other areas or rooms during periods of cleaning, shall be at least 110 lux (10 foot-candles) at a distance of 30 inches (75 cm) above the floor;

2. in areas where there is consumer self service, areas used for handwashing, warewashing, equipment and utensil storage, and in toilet rooms, shall be at least 220 lux (20 foot-candles) at a distance of 30 inches (75 cm) above the floor;

3. at a surface where a food employee is working with unpackaged potentially hazardous food or with food, utensils, and equipment such as knives, slicers, grinders, or saws where employees' safety is a factor, shall be at least 540 lux (50 foot-candles) at a distance of 30 inches (75 cm) above the floor.

AUTHORITY NOTE: Promulgated in accordance with R.S. 40:4.

HISTORICAL NOTE: Promulgated by the Department of Health and Hospitals, Office of Public Health, LR 28:332 (February 2002), amended LR 28:1426 (June 2002).

§3707. Light Shielding
[formerly paragraph 22:27-2]

A. Light bulbs shall be shielded, coated, or otherwise shatter-resistant in areas where there is exposed food, clean equipment, utensils and linens or unwrapped single-service and single-use articles.

B. Infrared or other heat lamps shall be protected against breakage by a shield surrounding and extending beyond the bulb so that only the face of the bulb is exposed.

AUTHORITY NOTE: Promulgated in accordance with R.S. 40:4.

HISTORICAL NOTE: Promulgated by the Department of Health and Hospitals, Office of Public Health, LR 28:332 (February 2002), amended LR 28:1426 (June 2002).

§3709. Mechanical Ventilation
[formerly paragraph 22:28-1]

A. If necessary to keep rooms free of excessive heat, steam, condensation, vapors, obnoxious odors, smoke and fumes, mechanical ventilation of sufficient capacity shall be provided exhausting to the outside atmosphere.

AUTHORITY NOTE: Promulgated in accordance with R.S. 40:4.

HISTORICAL NOTE: Promulgated by the Department of Health and Hospitals, Office of Public Health, LR 28:332 (February 2002), amended LR 28:1426 (June 2002).

§3711. Hood Ventilation
[formerly paragraph 22:28-2]

A. Ventilation hood systems and devices shall be sufficient in number and capacity to prevent grease or condensation from collecting on walls and ceilings and should be equipped with filters to prevent grease from escaping into the outside atmosphere.

AUTHORITY NOTE: Promulgated in accordance with R.S. 40:4.

HISTORICAL NOTE: Promulgated by the Department of Health and Hospitals, Office of Public Health, LR 28:332 (February 2002), amended LR 28:1426 (June 2002).

§3713. Heating, Air Conditioning, Ventilating System Vents
[formerly paragraph 22:28-3]

A. These systems shall be designed and installed so that make-up air intake and exhaust vents do not cause contamination of food, food preparation surfaces, equipment and utensils.

AUTHORITY NOTE: Promulgated in accordance with R.S. 40:4.

HISTORICAL NOTE: Promulgated by the Department of Health and Hospitals, Office of Public Health, LR 28:332 (February 2002), amended LR 28:1426 (June 2002).

Chapter 39. Poisonous or Toxic Materials

§3901. Labeling
[formerly paragraph 22:29-1]

A. Containers of poisonous or toxic materials and personal care items shall bear a legible manufacturer's label.

B. Working containers used for storing poisonous or toxic materials such as cleaners and sanitizers taken from bulk supplies shall be clearly and individually identified with the common name of the material.

AUTHORITY NOTE: Promulgated in accordance with R.S. 40:4.

HISTORICAL NOTE: Promulgated by the Department of Health and Hospitals, Office of Public Health, LR 28:332 (February 2002), repromulgated LR 28:1426 (June 2002), amended LR 28:2533 (December 2002).

§3903. Storage and Display
[formerly paragraph 22:29-2]

A. Poisonous or toxic materials shall be stored for use in food establishments or displayed for retail sale or use in retail food stores/markets so they may not contaminate food, equipment, utensils, linens, single-service and single-use articles by:

1. separating the poisonous or toxic materials by spacing or partitioning; and

2. locating the poisonous or toxic materials in an area that is not above food, equipment, utensils, linens, single-service and single-use articles; and

3. storing those properly labeled medicines and first aid supplies necessary for the health of employees or for retail sale in a location or area that prevents contamination of food, equipment, utensils, linens, single-service and single-use articles; and

4. storing medicines belonging to employees that require refrigeration (and are stored in a food refrigerator) in a package or container kept inside a covered, leakproof container that is identified as a container for the storage of medicines, or as specified for day care centers and residential facilities in Part XXI of this Title; and

5. storing employees' personal care items in lockers or other suitable facilities that are located in an area that prevents contamination of food, equipment, utensils, linens, single-service and single-use articles.

AUTHORITY NOTE: Promulgated in accordance with R.S. 40:4.

HISTORICAL NOTE: Promulgated by the Department of Health and Hospitals, Office of Public Health, LR 28:332 (February 2002), amended LR 28:1426 (June 2002).

§3905. Use
[formerly paragraph 22:29-3]

A. Only those poisonous or toxic materials that are required for the operation and maintenance of the food establishment or retail food store/market such as for the cleaning and sanitizing of equipment and utensils and the

control of insects and rodents, shall be allowed in food preparation and processing areas. This does not apply to approved, packaged poisonous or toxic materials that are for retail sale stored in accordance with §3903 of this Part.

B. Poisonous or toxic materials shall be stored in accordance with §3903 of this Part, and used according to:

1. law;
2. manufacturer's use directions included in labeling, and, for a pesticide, manufacturer's label instructions including a statement that the use is allowed in a food preparation or processing area; and
3. any additional conditions that may be established by the regulatory authority.

C. Chemical sanitizers and other chemical antimicrobials applied to food contact surfaces shall meet the requirements specified in §2513.A.2 and §2515.B of this Part.

D. Chemicals used to wash or peel raw, whole fruits and vegetables shall be used in accordance with the manufacturer's label instructions and as specified in 21 CFR 173.315.

E. Restricted use pesticides shall be applied and used according to law and in accord with the manufacturer's label instructions.

F. Rodent bait shall be contained in a covered, tamper-resistant bait station.

AUTHORITY NOTE: Promulgated in accordance with R.S. 40:4.

HISTORICAL NOTE: Promulgated by the Department of Health and Hospitals, Office of Public Health, LR 28:332 (February 2002), amended LR 28:1426 (June 2002).

Chapter 41. Miscellaneous

§4101. Prohibitive Acts [formerly paragraph 22:30]

A. Except as specified in Subsection B of this Section, live animals may not be allowed on the premises of food establishments or retail food stores/markets.

B. Live animals may be allowed in the following situations if the contamination of food; clean equipment, utensils, and linens; and unwrapped single-service and single-use articles cannot result, such as:

1. edible fish or decorative fish in aquariums, shellfish and crustacea in display tank systems;
2. patrol dogs accompanying police or security officers in offices and dining, sales, and storage areas, and sentry dogs running loose in outside fenced areas;
3. service animals that are controlled by a disabled employee or person, if a health or safety hazard will not result from the presence or activities of the service animal, in areas that are not used for food preparation and that are usually open for customers, such as dining and sales areas;

4. pets in the common dining areas of group residences at times other than during meals if:

- a. effective partitioning and self-closing doors separate the common dining areas from storage or food preparation areas;
- b. condiments, equipment, and utensils are stored in enclosed cabinets or removed from the common dining areas when pets are present; and
- c. dining areas including tables, countertops, and similar surfaces are effectively cleaned before the next meal service.

C. Body Art. No employee or any other person shall engage in the practice of "Body art" within the premises of any food establishment or retail food store/market as defined in this Part.

D. Persons unnecessary to the food establishment or retail food store/market operation are not allowed in the food preparation, food storage, or warewashing areas, except that brief visits and tours may be authorized by the person in charge if steps are taken to ensure that exposed food; clean equipment, utensils, and linens; and unwrapped single-service and single-use articles are protected from contamination.

AUTHORITY NOTE: Promulgated in accordance with R.S. 40:4.

HISTORICAL NOTE: Promulgated by the Department of Health and Hospitals, Office of Public Health, LR 28:333 (February 2002), amended LR 28:1427 (June 2002).

§4103. Distressed Merchandise [formerly paragraph 22:32]

A. Products that are held by the food establishment or retail food store/market for credit, redemption, or return to the distributor, such as damaged, spoiled, or recalled products, shall be segregated and held in designated areas that are separated from food, equipment, utensils, linens, and single-service and single-use articles.

AUTHORITY NOTE: Promulgated in accordance with R.S. 40:4.

HISTORICAL NOTE: Promulgated by the Department of Health and Hospitals, Office of Public Health, LR 28:333 (February 2002), amended LR 28:1427 (June 2002).

§4105. Dressing Areas, Lockers and Employee Break Areas [formerly paragraph 22:33]

A. Dressing rooms or dressing areas shall be designated if employees routinely change their clothes in the establishment.

B. Lockers or other suitable facilities shall be provided and used for the orderly storage of employees' clothing and other possessions.

C. Areas designated for employees to eat, drink, and use tobacco shall be located so that food, equipment, linens, and single-service and single-use articles are protected from contamination. Areas where employees use tobacco should be well ventilated.

AUTHORITY NOTE: Promulgated in accordance with R.S. 40:4.

HISTORICAL NOTE: Promulgated by the Department of Health and Hospitals, Office of Public Health, LR 28:333 (February 2002), amended LR 28:1427 (June 2002).

§4107. Linen/Laundry, General
[formerly paragraph 22:35-1]

A. Clean linens shall be free from food residues and other soiled matter.

AUTHORITY NOTE: Promulgated in accordance with R.S. 40:4.

HISTORICAL NOTE: Promulgated by the Department of Health and Hospitals, Office of Public Health, LR 28:333 (February 2002), amended LR 28:1427 (June 2002).

§4109. Linen/Laundry, Frequency of Cleaning
[formerly paragraph 22:35-2]

A. Linens that do not come in direct contact with food shall be laundered between operations if they become wet, sticky, or visibly soiled.

B. Cloth gloves shall be laundered before being used with a different type of raw animal food such as beef, lamb, pork, and fish.

C. Wet wiping cloths shall be laundered before being used with a fresh solution of cleanser or sanitizer.

D. Dry wiping cloths shall be laundered as necessary to prevent contamination of food and clean serving utensils.

AUTHORITY NOTE: Promulgated in accordance with R.S. 40:4.

HISTORICAL NOTE: Promulgated by the Department of Health and Hospitals, Office of Public Health, LR 28:333 (February 2002), amended LR 28:1427 (June 2002).

§4111. Wiping Cloths
[formerly paragraph 22:35-3]

A. Cloths that are used for wiping food spills shall be used for no other purpose.

B. Moist cloths used for wiping food spills on food contact surfaces of equipment shall be stored in an approved chemical sanitizing solution between uses.

AUTHORITY NOTE: Promulgated in accordance with R.S. 40:4.

HISTORICAL NOTE: Promulgated by the Department of Health and Hospitals, Office of Public Health, LR 28:334 (February 2002), amended LR 28:1428 (June 2002).

§4113. Storage of Soiled Linens
[formerly paragraph 22:35-4]

A. Soiled linens shall be kept in clean, nonabsorbent receptacles or clean, washable laundry bags and stored and transported to prevent contamination of food, clean equipment, clean utensils and single-service and single-use articles.

AUTHORITY NOTE: Promulgated in accordance with R.S. 40:4.

HISTORICAL NOTE: Promulgated by the Department of Health and Hospitals, Office of Public Health, LR 28:334 (February 2002), amended LR 28:1428 (June 2002).

§4115. Use of Laundry Facilities
[formerly paragraph 22:35-5]

A. Laundry facilities on the premises of a food establishment or retail food store/market shall be used only for the washing and drying of items used in the operation of the establishment and located away from food preparation areas.

B. Linens which are not laundered on the premises may be sent to an off premise commercial laundry.

AUTHORITY NOTE: Promulgated in accordance with R.S. 40:4.

HISTORICAL NOTE: Promulgated by the Department of Health and Hospitals, Office of Public Health, LR 28:334 (February 2002), amended LR 28:1428 (June 2002).

§4117. Living Areas
[formerly paragraph 22:36]

A. Living or sleeping quarters such as a private home, a room used as living or sleeping quarters, or an area directly opening into a room used as living or sleeping quarters, shall not be used for conducting food establishment or retail food store/market operations.

AUTHORITY NOTE: Promulgated in accordance with R.S. 40:4.

HISTORICAL NOTE: Promulgated by the Department of Health and Hospitals, Office of Public Health, LR 28:334 (February 2002), amended LR 28:1428 (June 2002).

§4119. Maintenance Equipment
[formerly paragraph 22:37]

A. Maintenance tools such as brooms, mops, vacuum cleaners, and similar equipment shall be:

1. stored so they do not contaminate food, equipment, utensils, linens, and single-service and single-use articles; and
2. stored in an orderly manner that facilitates cleaning.

B. Mops should be hung and/or stored in a manner to facilitate air drying.

AUTHORITY NOTE: Promulgated in accordance with R.S. 40:4.

HISTORICAL NOTE: Promulgated by the Department of Health and Hospitals, Office of Public Health, LR 28:334 (February 2002), amended LR 28:1428 (June 2002).

§4121. Reduced Oxygen Packaging
[formerly paragraph 22:39]

A. A food establishment or retail food store/market that packages food using a reduced oxygen packaging method shall have a Hazard Analysis Critical Control Point (HACCP) plan as specified in §311 of this Part, which provides the following information:

1. identifies the food to be packaged;
2. limits the food packaged to a food that does not support the growth of *Clostridium botulinum* because it complies with one of the following:
 - a. has a water activity of (a_w) of 0.91 or less;
 - b. has a pH of 4.6 or less;

c. is a meat product cured at a food processing plant regulated by the USDA or the Louisiana Department of Agriculture using substances specified in 9 CFR 318.7, Approval of Substances for Use in the Preparation of Products, and 9 CFR 381.147, Restrictions on the Use of Substances in Poultry Products, and is received in an intact package; or

d. is a food with a high level of competing organisms such as raw meat or raw poultry;

e. the product is immediately frozen upon packaging and labeled with instructions to keep frozen or maintain at 41°F (5°C) or below and discard the food within 14 days of defrosting;

3. specifies methods for maintaining food at 41°F (5°C) or below;

4. describes how the packages shall be prominently and conspicuously labeled on the principal display panel in bold type on a contrasting background, with instructions to:

a. maintain refrigerated food at 41°F (5°C) or below; and

b. discard the refrigerated food if within 14 calendar days from packaging it is not served for on-premises consumption, or consumed if served or sold for off-premise consumption;

5. limits:

a. the refrigerated shelf life to no more than 14 calendar days from packaging to consumption or the original manufacturer's "sell by" or "use by" date, whichever occurs first; or

b. limits the shelf life of frozen product to no more than 14 calendar days from defrosting;

6. includes operational procedures that:

a. prohibit contacting food with bare hands;

b. identify a designated area and the method by which:

i. physical barriers or methods of separation of raw foods and ready-to eat foods minimize cross-contamination; and

ii. access to the processing equipment is restricted to responsible trained personnel familiar with the potential hazards of the operation; and

c. delineate cleaning and sanitization procedures for food-contact surfaces; and

7. describes the training program that ensures that the individual responsible for reduced oxygen packaging (vacuum packaging) operation understands the:

a. concepts required for a safe operation;

b. equipment and facilities; and

c. procedures specified in Paragraph A.6 of this Subsection and the HACCP plan.

B. Except for fish that is frozen before, during, and after packaging, a food establishment may not package fish using a reduced oxygen packaging method.

AUTHORITY NOTE: Promulgated in accordance with R.S. 40:4.

HISTORICAL NOTE: Promulgated by the Department of Health and Hospitals, Office of Public Health, LR 28:334 (February 2002), repromulgated LR 28:1428 (June 2002), amended LR 28:2533 (December 2002).

§4123. Smoked Meat Preparation, Not Fully Cooked [formerly paragraph 22:40-1]

A. Not fully cooked smoked meats, also referred to as "partially cooked meats," shall be heated to a temperature and time sufficient to allow all parts of the meat to reach between 100°F and 140°F. This product shall be labeled on each retail package "FURTHER COOKING REQUIRED" with lettering of not less than 1/2 inch.

AUTHORITY NOTE: Promulgated in accordance with R.S. 40:4.

HISTORICAL NOTE: Promulgated by the Department of Health and Hospitals, Office of Public Health, LR 28:335 (February 2002), amended LR 28:1429 (June 2002).

§4125. Smoked Meat Preparation, Fully Cooked [formerly paragraph 22:40-2]

A. Fully cooked smoked meats shall be heated at a temperature and time sufficient to allow all parts of the meat to reach 155°F except poultry products which shall reach 165°F with no interruption of the cooking process and fish which shall reach 145°F.

AUTHORITY NOTE: Promulgated in accordance with R.S. 40:4.

HISTORICAL NOTE: Promulgated by the Department of Health and Hospitals, Office of Public Health, LR 28:335 (February 2002), amended LR 28:1429 (June 2002).

§4127. Open Air Markets

A. Markets commonly called "open air markets," "curb markets" or "open front markets" shall store all food products above the floor or ground level.

AUTHORITY NOTE: Promulgated in accordance with R.S. 40:4.

HISTORICAL NOTE: Promulgated by the Department of Health and Hospitals, Office of Public Health, LR 28:335 (February 2002), amended LR 28:1429 (June 2002).

§4129. Itinerant Food Establishments, Itinerant Retail Food Stores/Markets Permit [formerly paragraph 22:34-1]

A. No itinerant food establishment or itinerant retail food store/market shall operate without first applying for and receiving a permit from the state health officer.

B. Seasonal permits issued to itinerant food establishments or itinerant retail food stores/markets should coincide with the legally set seasons for the products those markets plan to handle or sell and expire the last day of the season.

AUTHORITY NOTE: Promulgated in accordance with R.S. 40:4.

HISTORICAL NOTE: Promulgated by the Department of Health and Hospitals, Office of Public Health, LR 28:335 (February 2002), amended LR 28:1429 (June 2002).

§4131. Itinerant Food Establishments, Itinerant Food Stores/Markets Plans
[formerly paragraph 22:34-2]

A. Plans and specifications for all proposed itinerant food establishments or itinerant retail food stores/markets shall be submitted to the state health officer for review and approval before applying for and receiving a permit.

AUTHORITY NOTE: Promulgated in accordance with R.S. 40:4.

HISTORICAL NOTE: Promulgated by the Department of Health and Hospitals, Office of Public Health, LR 28:335 (February 2002), amended LR 28:1429 (June 2002).

Chapter 43. Inspections and Enforcement

§4301. Inspections, Frequency
[formerly paragraph 22:42-1]

A. Inspections of food establishments or retail food stores/markets shall be performed by the department as often as necessary for the enforcement of this Part.

AUTHORITY NOTE: Promulgated in accordance with R.S. 40:4.

HISTORICAL NOTE: Promulgated by the Department of Health and Hospitals, Office of Public Health, LR 28:335 (February 2002), amended LR 28:1429 (June 2002).

§4303. Inspections, Access
[formerly paragraph 22:42-2]

A. Representatives of the state health officer, after proper identification, shall be permitted to enter any food establishment or retail food store/market at any time for the purpose of making inspections to determine compliance with this Part.

AUTHORITY NOTE: Promulgated in accordance with R.S. 40:4.

HISTORICAL NOTE: Promulgated by the Department of Health and Hospitals, Office of Public Health, LR 28:335 (February 2002), amended LR 28:1429 (June 2002).

§4305. Inspections, Records
[formerly paragraph 22:42-3]

A. The state health officer shall be permitted to examine the records of food establishments or retail food stores/markets to obtain information pertaining to food and supplies purchased, received, or used, or to persons employed. Such records shall be maintained for a period of not less than six months.

AUTHORITY NOTE: Promulgated in accordance with R.S. 40:4.

HISTORICAL NOTE: Promulgated by the Department of Health and Hospitals, Office of Public Health, LR 28:335 (February 2002), amended LR 28:1429 (June 2002).

§4307. Inspections, Reports
[formerly paragraph 22:42-4]

A. Whenever an inspection of a food establishment or retail food store/market is made, the findings shall be recorded on an inspection report form. A copy of the completed inspection report shall be furnished to the person in charge of the food establishment or retail food store/market at the conclusion of the inspection.

AUTHORITY NOTE: Promulgated in accordance with R.S. 40:4.

HISTORICAL NOTE: Promulgated by the Department of Health and Hospitals, Office of Public Health, LR 28:335 (February 2002), amended LR 28:1429 (June 2002).

§4309. Enforcement, General
[formerly paragraph 22:43-2]

A. Enforcement procedures shall be conducted in accordance with Part I of this Title.

AUTHORITY NOTE: Promulgated in accordance with R.S. 40:4.

HISTORICAL NOTE: Promulgated by the Department of Health and Hospitals, Office of Public Health, LR 28:336 (February 2002), amended LR 28:1429 (June 2002).

§4311. Enforcement, Critical Violations
[formerly paragraph 22:43-2]

A. Critical items, such as, but not limited to a potentially hazardous food stored at improper temperature, poor personal hygienic practices, not sanitizing equipment and utensils, no water, contaminated water source, chemical contamination, sewage backup or improper sewage disposal, noted at the time of inspection shall be corrected immediately or by a time set by the state health officer.

AUTHORITY NOTE: Promulgated in accordance with R.S. 40:4.

HISTORICAL NOTE: Promulgated by the Department of Health and Hospitals, Office of Public Health, LR 28:336 (February 2002), amended LR 28:1430 (June 2002).

§4313. Enforcement, Noncritical Violations
[formerly paragraph 22: 43-3]

A. Noncritical items noted at the time of inspection shall be corrected as soon as possible or by a time limit set by the state health officer.

AUTHORITY NOTE: Promulgated in accordance with R.S. 40:4.

HISTORICAL NOTE: Promulgated by the Department of Health and Hospitals, Office of Public Health, LR 28:336 (February 2002), amended LR 28:1430 (June 2002).

§4315. Enforcement, Adulterated Food
[formerly paragraph 22:43-4]

A. Any food product that is adulterated, misbranded or unregistered is subject to seizure and condemnation by the state health officer according to law.

AUTHORITY NOTE: Promulgated in accordance with R.S. 40:4.

HISTORICAL NOTE: Promulgated by the Department of Health and Hospitals, Office of Public Health, LR 28:336 (February 2002), amended LR 28:1430 (June 2002).

**Chapter 45. Mobile Food
Establishments, Mobile Retail Food
Stores/Markets and Pushcarts
[formerly paragraph 22:34-3]**

§4501. Interior of Vehicles

A. The interior of vehicles where food products are prepared and stored shall be constructed of a smooth, easily cleanable surface and maintained in good repair.

B. The interior of vehicles where food products are prepared and stored shall be kept clean.

AUTHORITY NOTE: Promulgated in accordance with R.S. 40:4.

HISTORICAL NOTE: Promulgated by the Department of Health and Hospitals, Office of Public Health, LR 28:336 (February 2002), amended LR 28:1430 (June 2002).

**§4503. Packaged Food Products
[formerly paragraph 22:34-4]**

A. Trucks or vendors selling packaged food products such as ice cream, frozen novelties, meats, etc. shall operate from a base of operation where leftover products may be properly stored and inspected and the vehicle serviced. Packaged potentially hazardous foods shall be stored in accordance with §§1309 and 1313 of this Part.

AUTHORITY NOTE: Promulgated in accordance with R.S. 40:4.

HISTORICAL NOTE: Promulgated by the Department of Health and Hospitals, Office of Public Health, LR 28:336 (February 2002), amended LR 28:1430 (June 2002).

**§4505. Produce
[formerly paragraph 22:34-5]**

A. Produce vendors shall comply with §§1101, 1103, 1107, Chapter 15, and §4101 of this Part. The produce should be protected by some type of enclosure or cover on the vehicles. Any produce left at the end of the day should be properly stored and protected from insects and rodents overnight.

AUTHORITY NOTE: Promulgated in accordance with R.S. 40:4.

HISTORICAL NOTE: Promulgated by the Department of Health and Hospitals, Office of Public Health, LR 28:336 (February 2002), amended LR 28:1430 (June 2002).

**§4507. General
[formerly paragraph 23:117-1]**

A. Mobile food establishments, mobile retail food stores/markets or pushcarts shall comply with the requirements of this Part, except as otherwise provided in this Section and in §4129 of this Part. The department may impose additional requirements to protect against health hazards related to the conduct of the food establishment or retail food store/market as a mobile operation, may prohibit the sale of some or all potentially hazardous food and when no health hazard will result, may modify requirements of this Part relating to physical facilities.

AUTHORITY NOTE: Promulgated in accordance with R.S. 40:4.

HISTORICAL NOTE: Promulgated by the Department of Health and Hospitals, Office of Public Health, LR 28:336 (February 2002), amended LR 28:1430 (June 2002).

**§4509. Plans Submission
[formerly paragraph 22:34-2]**

A. Properly prepared plans and specifications for mobile food establishments, mobile retail food stores/markets and pushcarts shall be submitted to the state health officer for review and approval before construction is begun.

AUTHORITY NOTE: Promulgated in accordance with R.S. 40:4.

HISTORICAL NOTE: Promulgated by the Department of Health and Hospitals, Office of Public Health, LR 28:336 (February 2002), amended LR 28:1430 (June 2002).

**§4511. Permit
[formerly paragraph 23:125]**

A. No person shall operate a mobile food establishment, mobile retail food store/market or pushcart who does not have a valid permit issued to him by the state health officer. Only a person who complies with the requirements of this Part shall be entitled to receive or retain such a permit. Permits are not transferable. A valid permit shall be posted in every mobile food establishment, mobile retail food store/market or pushcart.

AUTHORITY NOTE: Promulgated in accordance with R.S. 40:4.

HISTORICAL NOTE: Promulgated by the Department of Health and Hospitals, Office of Public Health, LR 28:336 (February 2002), amended LR 28:1430 (June 2002).

**§4513. Issuance of Permits
[formerly paragraph 23:126-1]**

A. Any person desiring to operate a mobile food establishment, mobile retail food store/market or pushcart shall make written application for a permit on forms provided by the Office of Public Health. Such application shall include the name and address of each applicant, the day(s), time(s), and location(s) of operation, and type of the proposed mobile food establishment, mobile retail food store/market, or pushcart, and the signature of each applicant. When using a commissary or other fixed food establishment owned by a permit holder other than the mobile food establishment permit holder, the mobile food establishment shall provide a signed and dated agreement with the commissary or other fixed food establishment.

B. Upon re-application for a current permit to operate, the mobile food establishment owner shall provide a current agreement with the commissary or other fixed food establishment and any changes in day(s), time(s), and location(s) of operation.

AUTHORITY NOTE: Promulgated in accordance with R.S. 40:4.

HISTORICAL NOTE: Promulgated by the Department of Health and Hospitals, Office of Public Health, LR 28:337 (February 2002), amended LR 28:1430 (June 2002), LR 40:1008 (May 2014).

§4515. Restricted Operations
[formerly paragraph 22:34-6]

A. Boiled peanuts shall be handled in accordance with guidelines set by the state health officer.

B. Hot tamales shall be handled in accordance with guidelines set by the state health officer.

C. Seafood

1. Boiled seafood shall be cooked and handled in accordance with guidelines set by the state health officer.

2. Oysters sold by the sack must be in an enclosed, mechanically refrigerated vehicle and comply with §§1101, 1103, 1107, 1109 and 1117 of this Part.

3. Live crabs or crawfish sold by the bushel or sack must be stored either on ice in an enclosed, insulated vehicle or in an enclosed mechanically refrigerated vehicle and comply with §§1101, 1103 and 1117 of this Part.

4. Raw shrimp vendors:

a. shall store their shrimp in containers such as ice chests which are smooth, impervious and easily cleanable. The use of styrofoam is prohibited;

b. shall maintain shrimp at a temperature of 41°F (5°C) in accordance with §1309 of this Part;

c. shall provide a minimum one gallon container of sanitizer solution at the proper strength in accordance with §2513.A.2 of this Part to rinse hands, scoops, scales, ice chests, etc., as needed; and

d. shall provide paper hand towels and a waste receptacle.

5. Waste water from any seafood vendor shall be disposed of properly in accordance with §2901 of this Part. Waste water shall be collected in an approved, covered, labeled container for proper disposal. The discharging of waste water onto the ground or into a storm drainage system is prohibited.

AUTHORITY NOTE: Promulgated in accordance with R.S. 40:4.

HISTORICAL NOTE: Promulgated by the Department of Health and Hospitals, Office of Public Health, LR 28:337 (February 2002), amended LR 28:1431 (June 2002).

§4517. Single-Service Articles
[formerly paragraph 23:119]

A. Mobile food establishments, mobile retail food stores/markets or pushcarts shall provide only single-service articles for use by the consumer.

AUTHORITY NOTE: Promulgated in accordance with R.S. 40:4.

HISTORICAL NOTE: Promulgated by the Department of Health and Hospitals, Office of Public Health, LR 28:337 (February 2002), amended LR 28:1431 (June 2002).

§4519. Water System
[formerly paragraph 23:120]

A. A mobile food establishment or a mobile retail food store/market requiring a water system shall have a potable water system under pressure. The system shall be of sufficient capacity to furnish enough hot and cold water for food preparation, utensil cleaning and sanitizing, and handwashing, in accordance with the requirements of this regulation. The water inlet shall be located so that it will not be contaminated by waste discharge, road dust, oil, or grease, and it shall be kept capped unless being filled. The water inlet shall be provided with a transition connection of a size or type that will prevent its use for any other service. All water distribution pipes or tubing shall be constructed and installed in accordance with the requirements of Part XIV of the state sanitary code. An approved gauge shall be provided to determine contents level.

B. Potable water shall come from an approved source in accord with the requirements of Part XII of the state sanitary code.

AUTHORITY NOTE: Promulgated in accordance with R.S. 40:4.

HISTORICAL NOTE: Promulgated by the Department of Health and Hospitals, Office of Public Health, LR 28:337 (February 2002), amended LR 28:1431 (June 2002).

§4521. Waste Retention
[formerly paragraph 23:121]

A. If liquid waste results from operation of a mobile food establishment or mobile retail food store/market, the waste shall be stored in a permanently installed retention tank that is of at least 15 percent larger capacity than the water supply tank. Liquid waste shall not be discharged from the retention tank when the mobile food establishment or mobile retail food store/market is in motion. All connections on the vehicle for servicing mobile food establishment or mobile retail food store/market waste disposal facilities shall be of a different size or type than those used for supplying potable water to the mobile food establishment or mobile retail food store/market. The waste connection shall be located lower than the water inlet connection to preclude contamination of the potable water system. An approved gauge shall be provided to determine content levels.

B. Wastewater from mobile food establishments or mobile retail food stores/markets shall be disposed of in accord with §2901 of this Part.

AUTHORITY NOTE: Promulgated in accordance with R.S. 40:4.

HISTORICAL NOTE: Promulgated by the Department of Health and Hospitals, Office of Public Health, LR 28:337 (February 2002), amended LR 28:1431 (June 2002).

§4523. Base of Operations/Commissary
[formerly paragraphs 23:122, 23:123, and 23:124]

A. Mobile food establishments, mobile retail food stores/markets and pushcarts shall operate from a commissary or other fixed food establishment and shall

report at least daily to such location for all supplies and for all cleaning and servicing operations.

B. The commissary or other fixed food establishments used as a base of operation for mobile food establishments, mobile retail food stores/markets, or pushcarts shall be constructed, permitted, and operated in compliance with the requirements of this Part.

C. Servicing Area

1. A servicing area shall be provided. Within this servicing area, there shall be a location provided for the flushing and drainage of liquid wastes separate from the location provided for water servicing and for the loading and unloading of food and related supplies.

2. The surface of the servicing area shall be constructed of a smooth nonabsorbent material, such as concrete or machine-laid asphalt and shall be maintained in good repair, kept clean, and be graded to drain.

3. Potable water servicing equipment shall be installed according to law and shall be stored and handled in a way that protects the water and equipment from contamination.

4. The liquid waste retention tank, where used, shall be thoroughly flushed and drained during the servicing operation. All liquid waste shall be discharged to a sanitary sewage disposal system in accordance with §2901 of this Part.

AUTHORITY NOTE: Promulgated in accordance with R.S. 40:4.

HISTORICAL NOTE: Promulgated by the Department of Health and Hospitals, Office of Public Health, LR 28:337 (February 2002), amended LR 28:1431 (June 2002), LR 40:1008 (May 2014).

§4525. Mobile Frozen Dessert Units

A. Mobile frozen dessert units shall comply with LAC 51:VII.2711.

AUTHORITY NOTE: Promulgated in accordance with the provisions of R.S. 40:4(A)(1)(a), R.S. 40:5(2)(3)(5)(7)(15)(17) and R.S. 40:922.

HISTORICAL NOTE: Promulgated by the Department of Health and Hospitals, Office of Public Health, LR 37:2728 (September 2011).

§4527. Depots for Mobile Frozen Dessert Units

A. Depots for mobile frozen dessert units shall comply with LAC 51:VII.2713.

AUTHORITY NOTE: Promulgated in accordance with the provisions of R.S. 40:4(A)(1)(a), R.S. 40:5(2)(3)(5)(7)(15)(17) and R.S. 40:922.

HISTORICAL NOTE: Promulgated by the Department of Health and Hospitals, Office of Public Health, LR 37:2729 (September 2011).

Chapter 47. Temporary Food Service

§4701. General

[formerly paragraph 23A:002]

A. The state health officer or his/her duly authorized representative may impose requirements in addition to those

set forth below to protect against health hazards related to the operation of the temporary food service, may prohibit the sale of some or all potentially hazardous foods, and when no health hazard will result, may waive or modify requirements of the state sanitary code, in accordance with the Administrative Procedure Act. Nothing in this Part shall be construed to abridge the constitutional rights of the people to peaceably assemble.

AUTHORITY NOTE: Promulgated in accordance with R.S. 40:4.

HISTORICAL NOTE: Promulgated by the Department of Health and Hospitals, Office of Public Health, LR 28:338 (February 2002), amended LR 28:1432 (June 2002).

§4703. Permits

[formerly paragraph 23A:003]

A. A temporary food service permit is not required for those fairs or festivals expressly exempted from regulation by R.S. 40:4.1 thru R.S. 40:4.6 inclusive.

B. When an organizer, promoter, or chairman of an exempted fair or festival makes written request for Office of Public Health inspections and permits and pays applicable fees, he or she shall comply with §4705 of this Part.

C. All fairs or festivals not exempted by Subsection A of this Section, shall not be allowed to operate until applying for, paying applicable fees, and receiving a valid permit to operate from the state health officer or his/her duly authorized representative.

AUTHORITY NOTE: Promulgated in accordance with R.S. 40:4.

HISTORICAL NOTE: Promulgated by the Department of Health and Hospitals, Office of Public Health, LR 28:338 (February 2002), amended LR 28:1432 (June 2002).

§4705. Written Application

[formerly 23A:003-1]

A. Written application for permit (LHS-31A), signed agreement, and supplemental application (obtainable from the parish health unit) should be received by the state health officer or his/her duly authorized representative at least 30 days in advance of the proposed gathering.

B. A permit to operate shall be required of the festival, fair or other special event organizer or promoter and must be obtained from the local parish health unit. The application for permit shall include the:

1. name and location of the special event;
2. permanent mailing address and phone number;
3. name of the property owner;
4. opening date and closing date;
5. daily hours of operation;
6. size of site (square feet);
7. anticipated maximum attendance at any one time;
8. name of the event organizer or promoter;

9. home address and phone number of the organizer or promoter;

10. business address and phone number of the organizer or promoter;

11. list of each individual food operator/responsible person, including their home address, home phone number, business phone, and food items to be sold;

12. outline map showing the location of all proposed and existing:

a. toilets;

b. lavatory facilities;

c. water supply sources (including storage tanks) and distribution system;

d. food service areas (including diagram and description of the types of booths, tents, etc., to be used for the preparation of or dispensing of any food or beverage products);

e. garbage and refuse storage and disposal areas;

f. special event command post; and

g. location of sewage disposal.

C. The following optional information is recommended to be included with the application for permit (on the outline map):

1. areas of assemblage;

2. camping areas (if any);

3. entrance and exits to public roadways;

4. emergency ingress and egress roads;

5. emergency medical and local enforcement command posts;

6. parking facilities;

7. written plan for dust control; and

8. written plan for emergency situations (e.g., inclement weather, etc.).

D. A permit to operate shall be required of each individual food operator/responsible person operating a temporary food service unit/booth and must be obtained from the local parish health unit. Permits are not transferrable and shall be issued for each food and/or beverage unit/booth. Permits shall be posted in the temporary food service unit/booth.

AUTHORITY NOTE: Promulgated in accordance with R.S. 40:4.

HISTORICAL NOTE: Promulgated by the Department of Health and Hospitals, Office of Public Health, LR 28:338 (February 2002), amended LR 28:1432 (June 2002).

§4707. Ice/Wet Storage
[formerly paragraph 23A:004]

A. Ice shall be made and stored as required by §1907 of this Part and Part VI of the state sanitary code. Ice scoops

must be used. The use of dry ice and/or frozen gel packs are recommended for cold storage. Storage of packaged food in contact with water or undrained ice is prohibited. Sandwiches shall not be stored in direct contact with ice.

AUTHORITY NOTE: Promulgated in accordance with R.S. 40:4.

HISTORICAL NOTE: Promulgated by the Department of Health and Hospitals, Office of Public Health, LR 28:339 (February 2002), amended LR 28:1432 (June 2002).

§4709. Equipment
[formerly paragraph 23A:004-1]

A. Equipment and food contact surfaces shall comply with Chapter 21 and Chapter 25 of this Part.

AUTHORITY NOTE: Promulgated in accordance with R.S. 40:4.

HISTORICAL NOTE: Promulgated by the Department of Health and Hospitals, Office of Public Health, LR 28:339 (February 2002), amended LR 28:1433 (June 2002).

§4711. Food Source and Protection
[formerly paragraph 23A:005-1]

A. Food shall be obtained, prepared, stored, handled and transported in accordance with Chapters 11, 13, 15, 17, and 19 of this Part. The sale of potentially hazardous home prepared food is prohibited.

B. The re-use of containers made of paper, wood, wax, or plastic coated cardboard is prohibited. Containers made of glass, metal, or hard plastic may be re-used only after they are properly washed, rinsed and sanitized.

AUTHORITY NOTE: Promulgated in accordance with R.S. 40:4.

HISTORICAL NOTE: Promulgated by the Department of Health and Hospitals, Office of Public Health, LR 28:339 (February 2002), amended LR 28:1433 (June 2002).

§4713. Personal Hygiene
[formerly paragraph 23A:007]

A. Each person working in a food booth shall comply with Chapter 7 and Chapter 9 of this Part.

AUTHORITY NOTE: Promulgated in accordance with R.S. 40:4.

HISTORICAL NOTE: Promulgated by the Department of Health and Hospitals, Office of Public Health, LR 28:339 (February 2002), amended LR 28:1433 (June 2002).

§4715. Food Stand/Booth Construction
[formerly paragraph 23A:008]

A. [Formerly paragraph 23A:008-1] Indoor booths must be constructed with tables, counters, and/or walls on all sides to control patron access. Food service must be from the rear area of the booth or otherwise dispensed to prevent contamination by customers.

B. [Formerly paragraph 23A:008-2] Outdoor booths must be constructed to include a roof made of wood, canvas, or other material that protects the interior of the booth from the weather and be enclosed by counters/walls to control patron access.

1. It is recommended that the booth be enclosed on three sides with the fourth, front side encompassing the service area, so constructed as to minimize the entrance of dust, flies and vermin. The use of screen, mosquito netting, or polyurethane for this purpose is acceptable; counter-service openings shall be minimal.

2. Additional protective covering must be provided to completely enclose outer openings in the event of rain, dust storms or other inclement weather.

AUTHORITY NOTE: Promulgated in accordance with R.S. 40:4.

HISTORICAL NOTE: Promulgated by the Department of Health and Hospitals, Office of Public Health, LR 28:339 (February 2002), amended LR 28:1433 (June 2002).

§4717. Floors

[formerly paragraph 23X:008-3]

A. Floors shall be kept clean, in good repair and level, so as not to allow the pooling of water. It is recommended that floors be constructed of concrete, asphalt, or similar material. Dirt or gravel, when graded to drain, may be used, however, clean removable pallets, duckboard, plywood, or similar material is recommended.

AUTHORITY NOTE: Promulgated in accordance with R.S. 40:4.

HISTORICAL NOTE: Promulgated by the Department of Health and Hospitals, Office of Public Health, LR 28:339 (February 2002), amended LR 28:1433 (June 2002).

§4719. Barbecue Places

[formerly paragraph 23A:008-4]

A. Places where barbecue is cooked must be provided with a cover impenetrable by rain or barbecue pits must be provided with covers. All food storage and handling must comply with §4711 of this Part.

AUTHORITY NOTE: Promulgated in accordance with R.S. 40:4.

HISTORICAL NOTE: Promulgated by the Department of Health and Hospitals, Office of Public Health, LR 28:339 (February 2002), amended LR 28:1433 (June 2002).

§4721. Seafood Boils

[formerly paragraph 23A:008-5]

A. Seafood boiling areas must be provided with a cover impenetrable to rain or a covered boiling apparatus. All food storage and handling must comply with §4711 of this Part.

AUTHORITY NOTE: Promulgated in accordance with R.S. 40:4.

HISTORICAL NOTE: Promulgated by the Department of Health and Hospitals, Office of Public Health, LR 28:339 (February 2002), amended LR 28:1433 (June 2002).

§4723. Exception

[formerly paragraph 23A:008-6]

A. Pre-packaged, pre-wrapped and properly labeled (according to the provisions of the Louisiana Food, Drug and Cosmetic Law) foods may be offered for sale in open type food stands, providing such food is properly stored and handled as described in this Part.

AUTHORITY NOTE: Promulgated in accordance with R.S. 40:4.

HISTORICAL NOTE: Promulgated by the Department of Health and Hospitals, Office of Public Health, LR 28:339 (February 2002), amended LR 28:1433 (June 2002).

§4725. Sanitizing of Utensils and Equipment **[formerly paragraph 23A:009]**

A. All utensils and equipment must be washed, rinsed and sanitized at least daily, or as required in Chapter 25 of this Part.

AUTHORITY NOTE: Promulgated in accordance with R.S. 40:4.

HISTORICAL NOTE: Promulgated by the Department of Health and Hospitals, Office of Public Health, LR 28:340 (February 2002), amended LR 28:1433 (June 2002).

§4727. Water

[formerly paragraph 23A:010]

A. Enough potable water from an approved source shall be provided for drinking, food preparation, for cleaning and sanitizing utensils and equipment, and for handwashing in accordance with Chapter 27 and Chapter 31 of this Part and Part XII of the state sanitary code.

AUTHORITY NOTE: Promulgated in accordance with R.S. 40:4.

HISTORICAL NOTE: Promulgated by the Department of Health and Hospitals, Office of Public Health, LR 28:340 (February 2002), amended LR 28:1433 (June 2002).

§4729. Sewage (Toilets and Waste)

[formerly paragraph 23A:011]

A. Approved facilities shall be provided and maintained for the disposal of all sewage and liquid waste in accordance with §2901 of this Part and Part XIII of the state sanitary code.

B. Toilets shall be provided at the rate of 1 per 200 persons or fractional part thereof.

AUTHORITY NOTE: Promulgated in accordance with R.S. 40:4.

HISTORICAL NOTE: Promulgated by the Department of Health and Hospitals, Office of Public Health, LR 28:340 (February 2002), amended LR 28:1434 (June 2002).

§4731. Hand Washing

[formerly paragraph 23A:012]

A. When water under pressure is available, a hand washing facility shall be provided in accordance with §3109 of this Part.

B. When water under pressure is not available at the serving or food dispensing booth, two buckets of water shall be provided for each food concessionaire. One bucket containing potable water must be provided to remove extraneous materials or excess food particles; a second bucket containing a sanitizing solution (100 ppm chlorine, or 25 ppm iodine, or 200 ppm quaternary ammonia) must be provided as a hand dip well.

AUTHORITY NOTE: Promulgated in accordance with R.S. 40:4.

HISTORICAL NOTE: Promulgated by the Department of Health and Hospitals, Office of Public Health, LR 28:340 (February 2002), amended LR 28:1434 (June 2002).

§4733. Refuse (Garbage and Trash)
[formerly paragraph 23A:013]

A. All garbage and refuse shall be handled in accordance with Chapter 33 of this Part and Part XXVII of the state sanitary code.

B. A 50 gallon refuse container shall be provided at the rate of one for each 100 persons at peak anticipated attendance. In addition, each food vendor must have a covered refuse container for booth use.

C. Grease containers must be provided and all used grease must be deposited in these containers. Grease must not be poured down any drain.

D. The grounds and immediate surrounding properties shall be cleaned of refuse as soon as possible following the assembly, within and not exceeding 24 hours of closure.

AUTHORITY NOTE: Promulgated in accordance with R.S. 40:4.

HISTORICAL NOTE: Promulgated by the Department of Health and Hospitals, Office of Public Health, LR 28:340 (February 2002), amended LR 28:1434 (June 2002).

§4735. Miscellaneous
[formerly paragraph 23A:014-1 and 23A:014-2]

A. The grounds of each fair, festival and/or temporary food service site shall be well drained and so arranged to provide sufficient space for people assembled, vehicles, sanitary facilities, and equipment.

B. All tents, cars, trailers, food stands and other appurtenances connected with the fair or festival shall at all times be kept in a clean and sanitary condition; and the grounds on which the fair or festival is located shall be kept in a clean and sanitary condition and, when vacated, left in a clean and sanitary condition.

C. The grounds shall be maintained free from accumulations of refuse, health and safety hazards, and from dust wherever possible.

AUTHORITY NOTE: Promulgated in accordance with R.S. 40:4.

HISTORICAL NOTE: Promulgated by the Department of Health and Hospitals, Office of Public Health, LR 28:340 (February 2002), amended LR 28:1434 (June 2002).

§4737. Vector Control
[formerly paragraph 23A:014-2]

A. Insects, rodents, and other vermin shall be controlled by proper sanitary practices, extermination, or other safe and effective control methods in accord with applicable Sections of Chapter 35 and Chapter 39 of this Part.

AUTHORITY NOTE: Promulgated in accordance with R.S. 40:4.

HISTORICAL NOTE: Promulgated by the Department of Health and Hospitals, Office of Public Health, LR 28:340 (February 2002), amended LR 28:1434 (June 2002).

§4739. Inspections/Violations/Closure
[formerly paragraph 23A:015]

A. All food operations are subject to at least daily inspections by representatives of the department.

B. Critical violations shall be corrected in accordance with §4311 of this Part.

C. Noncritical violations shall be corrected in accordance with §4313 of this Part.

D. Failure to make the necessary corrections or repeated violations will result in monetary penalties, sanctions, suspension of permit, seizure of food and/or further legal action.

AUTHORITY NOTE: Promulgated in accordance with R.S. 40:4.

HISTORICAL NOTE: Promulgated by the Department of Health and Hospitals, Office of Public Health, LR 28:340 (February 2002), amended LR 28:1434 (June 2002).

Title 51
PUBLIC HEALTH—SANITARY CODE
Part XXIV. Swimming Pools and Natural or
Semi-Artificial Swimming or Bathing Places

Chapter 1. General Requirements

§101. Authority
[formerly paragraph 24:029]

A. The state health officer shall decide the maximum number of persons who may utilize an artificial or semi-artificial swimming pool or bathing place; the quantity of fresh water which must be discharged into said pool or place; the treatment, if any, that the water in said pool or place shall receive; and the number, design, and operating conditions of dressing rooms, showers, toilets, and/or any other appurtenances that shall be provided to maintain sanitary conditions at said pool or bathing place. This information shall be stated in the letter of approval of plans after review.

B. [Formerly paragraph 24:030] The state health officer has the authority to decide the design and operating conditions of health related ancillary facilities, at natural swimming places or bathing places, such as "bath houses," dressing rooms, showers, and toilets.

C. [Formerly paragraph 24:031] No natural or semi-artificial swimming pool or bathing place shall be operated when the water in said pool or place is determined by the state health officer to be so polluted as to constitute a menace to health if used for swimming or bathing. The owner or operator of any semi-artificial swimming pool or bathing place and the owner or operator of the ancillary facilities at any natural swimming place or bathing place shall conspicuously post the area as "unsuitable for swimming or bathing," whenever the state health officer has determined that the area is so polluted as to constitute a menace to health.

AUTHORITY NOTE: The first source of authority for promulgation of the sanitary code is in R.S. 36:258(B), with more particular provisions found in Chapters 1 and 4 of Title 40 of the Louisiana Revised Statutes. This Part is promulgated in accordance with the provisions of R.S. 40:4(A)(11) and R.S. 40:5(2)(3)(16)(17)(20).

HISTORICAL NOTE: Promulgated by the Department of Health and Hospitals, Office of Public Health, LR 28:1435 (June 2002).

§103. Definitions
[formerly Subpart A paragraph 24:001]

A. Unless otherwise specifically provided herein the following words or terms used in this Part of the sanitary code and all other Parts which are adopted or may be adopted, are defined for the purposes thereof as follows.

LSPC—Louisiana State Plumbing Code, i.e., Part XIV (Plumbing) of this Code (LAC 51:XIV).

Natural Swimming Place or Bathing Place—any area in any natural watercourse or body of water in which people are immersed, or partially immersed, for swimming, recreational bathing, sporting events, therapeutic treatment, ceremonies, or any other related activities.

Semi-Artificial Swimming Pool or Bathing Place or Bathing Beach—any area in any natural watercourse or body of water, the configuration of which has been altered by human construction, and in which people are immersed, or partially immersed, for swimming, recreational bathing, sporting events, ceremonies, therapeutic treatment, or any other related activities.

State Health Officer—the legally appointed and/or acting state health officer of the health authority having jurisdiction over the entire state of Louisiana, and includes his/her duly authorized representative, except where the context of these regulations or pertinent statutory language indicates the reference is to the state health officer acting personally. Should legislative action either change the term *state health officer* or transfer his/her authority, the successor shall assume the functions delegated to the state health officer in this sanitary code.

a. [Formerly paragraph 24:002] The state health officer has jurisdiction (for anything related to health) over the design, construction, and operation of all swimming pools (pools), water parks, and water slides, public or private, including, but not limited to, those owned by clubs, private schools, apartment houses, and condominiums.

b. [Formerly paragraph 24:003] No new swimming pool, water park or water slide shall hereafter be constructed nor shall major alterations be made to existing swimming pools, water parks, or water slides without the prior written approval of, and unless in accordance with plans and specifications approved in advance by, the state health officer. The approval may include certain provisions, which, if violated, may result in revocation of the approval.

Swimming Pool (Pools)—any indoor or outdoor pool or vessel, which is entirely of human construction, and in which people are immersed, or partially immersed, in water, for swimming, therapeutic treatment, recreational bathing, sporting events, ceremonies, or any other related activities. This includes, but is not limited to, hot tubs, medical treatment pools, spas, whirlpools, and water parks.

a. *Permanently Installed Swimming Pool*—a pool that is constructed in the ground or in a building in such a manner that it cannot be readily disassembled for storage.

b. *Residential Pool*—a residential pool shall be defined as any constructed pool, permanent or non-portable, that is intended for noncommercial use as a swimming pool by not more than five owner families and their guests and that is over 24 inches in depth, has a surface area exceeding 250 square feet and/or a volume over 3,750 gallons. (Residential pools are excluded from the provisions of these regulations.)

c. *Public Pool*—any pool, other than a residential pool, which is intended to be used for swimming or bathing and is operated by owner, lessee, operator, licensee or concessionaire, regardless of whether a fee is charged for use. References within the regulations to various types of public pools are defined by the following categories.

i. *Class A: Competition Pool*—any pool intended for use for accredited competitive aquatic events such as Federation Internationale de Natation Amateur (FINA), U.S. Swimming, U.S. Diving, National Collegiate Athletic Association (NCAA), National Federation of State High School Associations (NFSHSA), etc. The pool may be used for recreation.

ii. *Class B: Public Pool*—any pool intended for public recreational use.

iii. *Class C: Semi-Public Pool*—any pool operated solely for and in conjunction with lodgings such as hotels, motels, apartments, condominiums, etc.

iv. *Class D: Other Pool*—any pool operated for medical treatment, therapy, exercise, lap swimming, recreational play, and other special purposes, including, but not limited to, wave or surf action pools, activity pools, splash pools, kiddie pools and play areas.

d. *Ceremonial Pools*—pools used for ceremonies and/or religious purposes - only. Size not to exceed 10 feet long x 5 feet wide x 5 feet deep and/or 2000 gallons. (Ceremonial pools are excluded from these regulations.)

e. *Wading Pool*—a pool that has a shallow depth, 24 inches or shallower, used for wading. (There are no requirements for residential wading pools.)

Turnover—the ratio of the volume of clean water entering a pool in 24 hours to the total pool volume. The term *clean water* means water from an approved source meeting the requirements of Part XII of this Code, or water taken from the pool and returned after filtration and disinfection in accordance with the requirements of this Part.

Waterline—the waterline shall be defined in one of the following ways.

a. *Skimmer System*—the waterline shall be at the midpoint of the operating range of the skimmer when there are no users in the pool or spa.

b. *Overflow System*—the waterline shall be deemed to be that established by the height of the overflow rim.

Water Park—any indoor or outdoor area in any natural water course, body of water or manmade construction which shall include but not be limited to swimming pools, wave

pools, water slides, flumes, plunge pools, flotation rides that include immersion or partial immersion with direct or indirect contact with the water (primary and secondary contact).

Water Slide—any slide or flume or group of slides or flumes upon which people and water descend simultaneously, and upon which the same water contacts the bodies of people. This includes the landing and/or recirculating pool at the bottom of the slide, the ascent path or stair, the departure platform or area at the top, and any ancillary health related facilities such as bath houses, dressing rooms, showers, and toilets.

AUTHORITY NOTE: Promulgated in accordance with the provisions of R.S. 40:4(A)(11) and R.S. 40:5(3)(16)(17)(20).

HISTORICAL NOTE: Promulgated by the Department of Health and Hospitals, Office of Public Health, LR 28:1435 (June 2002), repromulgated LR 29:1100 (July 2003), amended LR 38:2927 (November 2012).

Chapter 3. Design Requirements for Swimming Pools [formerly Subpart B]

§301. Materials of Constructions [formerly paragraph 24:004]

A. Swimming pools and all appurtenances thereto shall be constructed of materials which are non-toxic to man and the environment; which are impervious and enduring; which can withstand the design stresses; and which will provide a watertight structure with a smooth and easily cleaned surface without cracks or joints, excluding structural joints, or to which a smooth, easily cleaned surface finish is applied or attached.

B. The floor of all pools shall be white, light colored, or light colored patterns in order to facilitate the identification of any objects within the pool. The color, patterns, or finishes of the pool interior shall not be such as to obscure the existence or presence of objects or surfaces within the pool.

AUTHORITY NOTE: Promulgated in accordance with the provisions of R.S. 40:4(A)(11) and R.S. 40:5(3)(16)(17)(20).

HISTORICAL NOTE: Promulgated by the Department of Health and Hospitals, Office of Public Health, LR 28:1436 (June 2002).

§303. Dimensional Design [formerly paragraph 24:005]

A. There shall be construction tolerances allowed on all dimensional designs. Overall length, width, and depth in the deep end may vary plus or minus 3 inches. All other overall dimensions may vary plus or minus two inches, unless otherwise specified (such as in a Class A pool). The designed waterline shall have a maximum construction tolerance at the time of completion of the work of plus or minus 1/4 inch for pools with adjustable weir surface skimming systems, and of plus or minus 1/8 inch for pools with non-adjustable surface skimming systems.

B. The size of Class A or Class D pools shall be governed by the requirements of the activities for which the installation is intended.

AUTHORITY NOTE: Promulgated in accordance with the provisions of R.S. 40:4(A)(11) and R.S. 40:5(3)(16)(17)(20).

HISTORICAL NOTE: Promulgated by the Department of Health and Hospitals, Office of Public Health, LR 28:1436 (June 2002).

§305. Walls
[formerly paragraph 24:005-1]

A. Walls in Class B and Class C pools shall not be greater than 11° from plumb for a minimum depth of 2 feet 9 inches from the waterline in deep areas, or for a minimum depth of 2 feet 3 inches in the shallow areas. Below these depths, the wall may be radiused to join the floor. Class A pools, where racing lanes terminate, shall have plumb walls. (A maximum 1° from plumb construction tolerance shall be allowed.)

AUTHORITY NOTE: Promulgated in accordance with the provisions of R.S. 40:4(A)(11) and R.S. 40:5(3)(16)(17)(20).

HISTORICAL NOTE: Promulgated by the Department of Health and Hospitals, Office of Public Health, LR 28:1436 (June 2002).

§307. Floor Slopes
[formerly paragraph 24:005-2]

A. Floor slopes shall, as a minimum, be in compliance with the following.

1. All slopes shall be uniform.
2. The slope of the floor from the shallow end wall towards the deep end shall not exceed 1 foot in 12 feet to the point of the first slope change for Class A and Class B pools, or 1 foot in 10 feet for Class C pools.
3. The slope of the floor from the point of the first slope change to the deep end shall not exceed 1 foot in 3 feet. Such slopes are not intended to provide any less water depth than those specified in the pool if intended for diving.

AUTHORITY NOTE: Promulgated in accordance with the provisions of R.S. 40:4(A)(11) and R.S. 40:5(3)(16)(17)(20).

HISTORICAL NOTE: Promulgated by the Department of Health and Hospitals, Office of Public Health, LR 28:1437 (June 2002).

§309. Traditional Radius Requirements
[formerly paragraph 24:005-3]

A. Traditional Radius from wall to floor where floor slopes join the wall shall comply with the following.

1. The radius shall have its center no less than 2 feet 9 inches below the waterline in deep areas or no less than 2 feet 6 inches below the waterline in the shallow area.
2. The radius shall be tangent at the point where the radius either meets the wall or the floor.
3. The radius shall be at least equal to, or greater than, the depth of the pool minus the vertical wall depth measured from the waterline (or tolerance allowed in §305) minus 3 inches to allow draining to the main drain.

AUTHORITY NOTE: Promulgated in accordance with the provisions of R.S. 40:4(A)(11) and R.S. 40:5(3)(16)(17)(20).

HISTORICAL NOTE: Promulgated by the Department of Health and Hospitals, Office of Public Health, LR 28:1437 (June 2002).

§311. Water Depth
[formerly paragraph 24:005-4]

A. At the shallow end of the swimming area the water depth shall be 3 feet minimum, with a 3 feet 6 inches minimum for racing pools. Exceptions may be made in a recessed area of the main swimming pool, outside of the competitive and/or swimming course, when the pool is an irregular shape, with the prior written permission of the state health officer.

B. The beginners' area of a pool shall be visually set apart from, but may be adjoined to, the shallow area and shall not adjoin the deep area.

C. The transition point of the pool from the beginners' area to the shallow area and from the shallow area to the deep area shall be visually set apart with a rope and float line, depth markers, and a 4 inches minimum width row of floor tile, painted line, or by similar means of a color contrasting with the bottom. In diving pools with a constant slope, the shallow area shall be visually set apart from the deep area with a rope and float line, depth markers, and a 4 inches minimum width row of floor tile, painted line, or by similar means of a color contrasting with the bottom.

D. Class A pools intended for competitive diving and swimming shall be designed and constructed so as to provide the water depths specified by Federation Internationale de Natation Amateur (FINA), U.S. Swimming, and U.S. Diving.

E. Diving intended for Class B and Class C pools shall conform to minimum water depths, areas, slopes and other dimensions in §317.

AUTHORITY NOTE: Promulgated in accordance with the provisions of R.S. 40:4(A)(11) and R.S. 40:5(3)(16)(17)(20).

HISTORICAL NOTE: Promulgated by the Department of Health and Hospitals, Office of Public Health, LR 28:1437 (June 2002).

§313. Diving Boards
[formerly paragraph 24:005-5]:

A. For indoor pools at least 16 feet of headroom above the highest diving board must be provided.

B. The water depth adjacent to diving boards should conform to the following safety standards.

Elevation of Diving Board above Water (feet)	Minimum Depth of Water under End of Board (feet)	Minimum Depth of Water 6 ft. behind, 20 ft. forward, and 8 ft. to either Side of the End of the Diving Board
1' to 4'	10**	10**
4' to 10'	12'	10'
above 10' (platforms)	15'	12'

*The bottom may not be horizontal but must be sloped to permit drainage.

C. Standard diving boards are mounted 1 meter and 3 meters (approximately 10 feet) above the water and are 16 feet long by 20 inches wide. They shall extend at least 6 feet and no more than 7 feet beyond the edge of the pool.

1. Spring boards, diving platforms and floats shall be covered with non-slip material.

D. Floats or fixed platforms in the water shall be constructed with an air space of at least 1 foot between the water and the platform. All braces, struts, etc., shall be designed to prevent entanglement or trapping of bathers beneath the platform.

E. Public pools with diving facilities in excess of 3 meters in height, or pools designed for platform diving, shall comply with the dimensional design requirements of FINA, U.S. Diving, National Federation of State High School Associations (NFSHSA), etc.

AUTHORITY NOTE: Promulgated in accordance with the provisions of R.S. 40:4(A)(11) and R.S. 40:5(3)(16)(17)(20).

HISTORICAL NOTE: Promulgated by the Department of Health and Hospitals, Office of Public Health, LR 28:1437 (June 2002).

§315. Turnover
[formerly paragraph 24:005-6]

A. The turnover of clean water entering the pool daily shall not be less than three. Kiddie pools shall turnover once every two hours.

AUTHORITY NOTE: Promulgated in accordance with the provisions of R.S. 40:4(A)(11) and R.S. 40:5(3)(16)(17)(20).

HISTORICAL NOTE: Promulgated by the Department of Health and Hospitals, Office of Public Health, LR 28:1437 (June 2002).

§317. Drawings and Diagrams
[formerly paragraph 24:006]

A. Minimum Dimensions for Diving Portion of Class B and Class C Pools (This drawing does not show the shallow portion of the pool.)

1. Ref.: §317.A.1

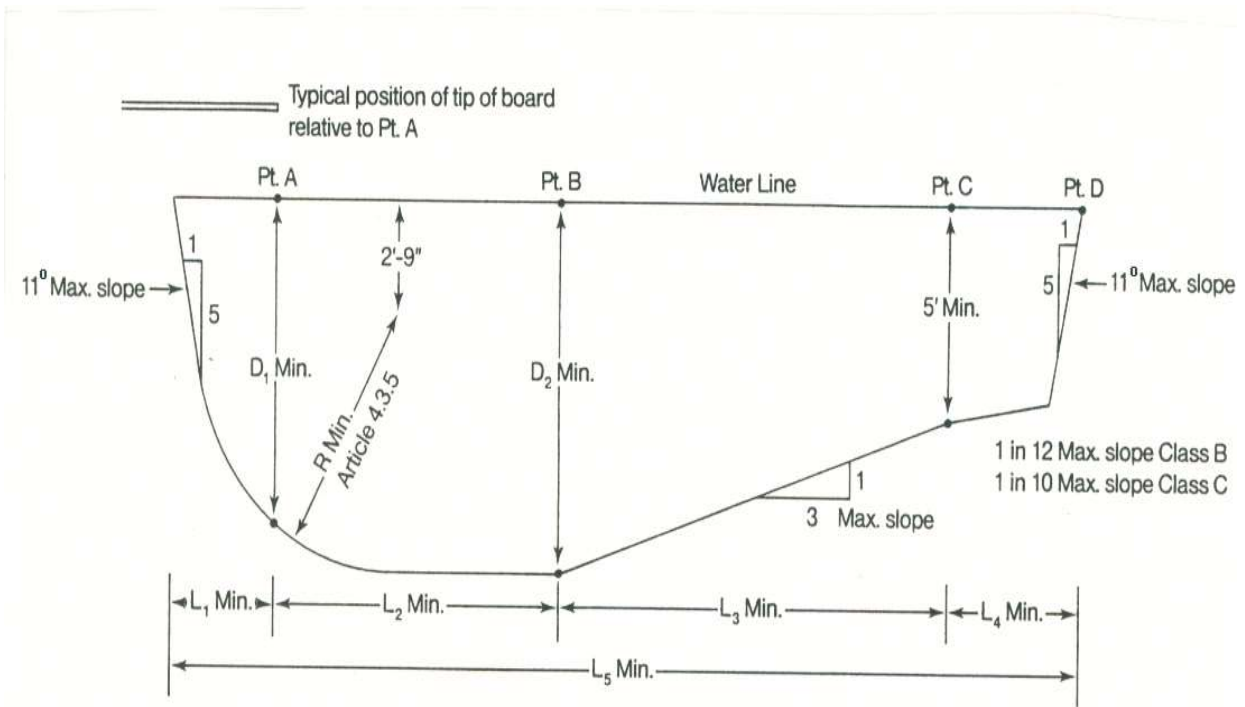

NOTE: L₄ is a minimum dimension to allow sufficient length opposite the board. This may of course be lengthened to form the shallow portion of the pool.

2. Drawing Ref.: §317.A.2

POOL TYPE	RELATED DIVING EQUIPMENT		MINIMUM DIMENSIONS								MINIMUM WIDTH OF POOL AT:	
	MAX. DIVING BOARD LENGTH	MAX. BOARD HEIGHT OVER WATER	D ₁	D ₂	R	L ₁	L ₂	L ₃	L ₄	L ₅	PT.A	PT.B
VI	10'	26" (2/3 meter)	7'-0"	8'-6"	5'-6"	2'-6"	8'-0"	10'-6"	7'-0"	28'-0"	16'-0"	18'-0"
VII	12'	30" (3/4 meter)	7'-6"	9'-0"	6'-0"	3'-0"	9'-0"	12'-0"	4'-0"	28'-0"	18'-0"	20'-0"
VIII	16'	1 Meter	8'-6"	10'-0"	7'-0"	4'-0"	10'-0"	15'-0"	2'-0"	31'-0"	20'-0"	22'-0"
IX	16'	3 Meter	11'-0"	12'-0"	8'-6"	6'-0"	10'-6"	21'-0"	0	37'-6"	22'-0"	24'-0"

L₂, L₃ and L₄ combined represent the minimum distance from the tip of board to pool wall opposite diving equipment.

For board heights exceeding 3 meters

*NOTE: Placement of boards shall observe the following minimum dimensions. With multiple board installations minimum pool widths must be increased accordingly.

- Deck Level Board to Pool Side 8'
- 1 Meter Board to Pool Side 10'
- 3 Meter Board to Pool Side 11'
- 1 Meter or Deck Level Board to 3 Meter Board 10'
- 1 Meter or Deck Level Board to another 1 Meter or Deck Level Board 8'
- 3 Meter to another 3 Meter Board 10'

B. Maximum Allowable Wall Slope

1. Ref. :§317.B.1

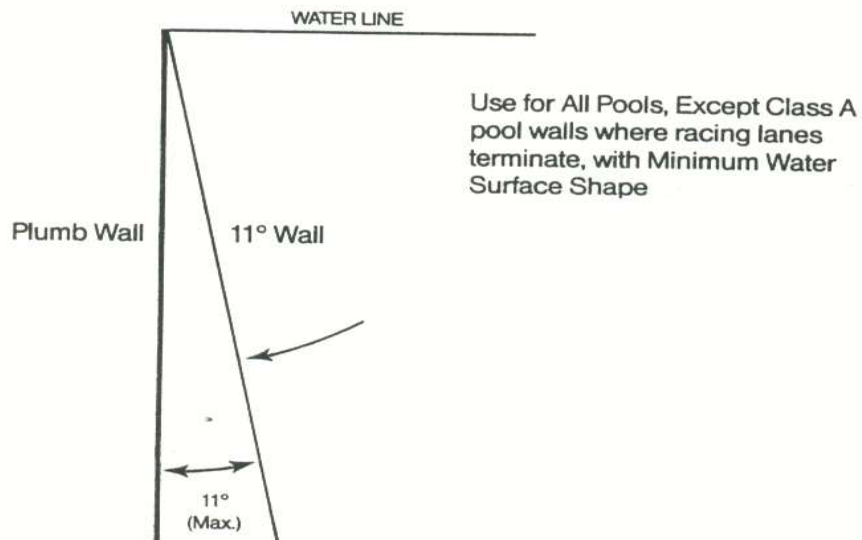

C. Offset Ledges

1. Offset ledges, when provided, shall fall within 11° from plumb starting at the junction of the pool wall and waterline, and shall have a slip-resisting surface. Maximum

width shall be 8 inches. The typical allowable dimensions are based on the depths shown below.

a. Ref.: §317.C.1

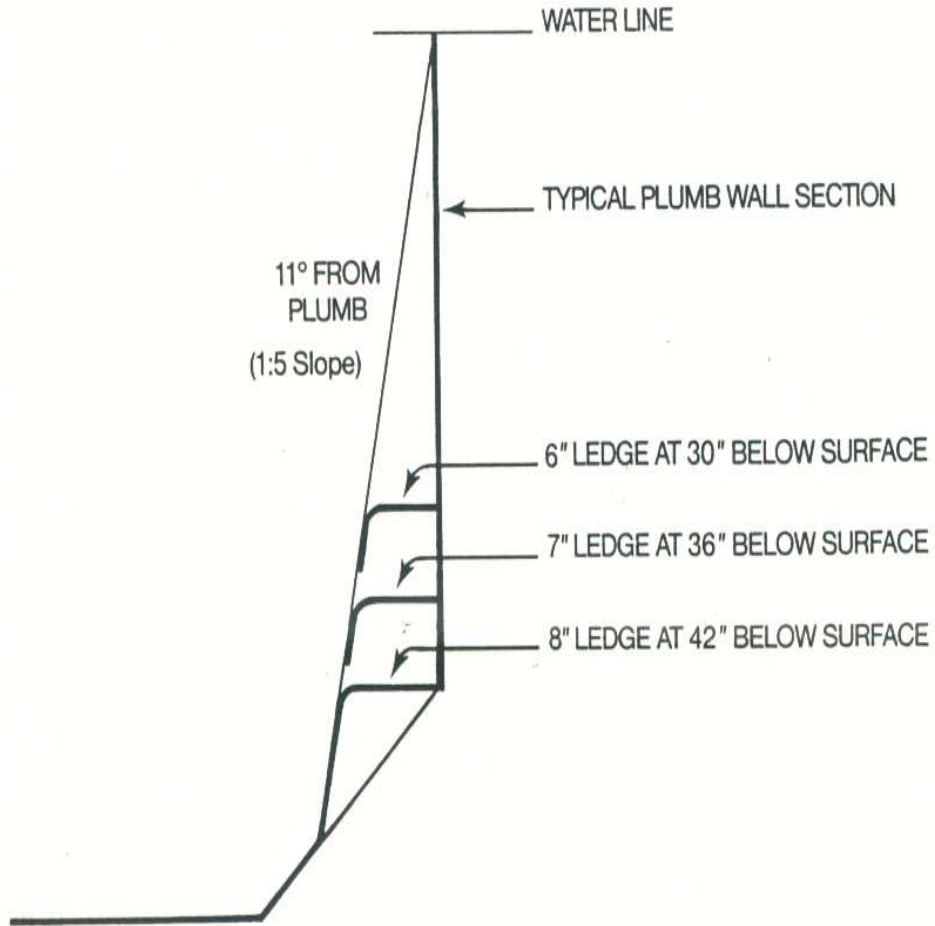

D. Underwater Seat Benches

1. Underwater seat benches are not allowed in pools but are allowed in spas and whirlpools.

AUTHORITY NOTE: Promulgated in accordance with the provisions of R.S. 40:4(A)(11) and R.S. 40:5(3)(16)(17)(20).

HISTORICAL NOTE: Promulgated by the Department of Health and Hospitals, Office of Public Health, LR 20:668 (June 1994), repromulgated LR 29:1101 (July 2003).

§319. Maximum User Load [formerly paragraph 24:007]

A. Maximum user load at Class B or Class C pools shall be in accordance with the following table.

	Shallow Instruction or Wading Areas	Deep Area (not including the diving area)	Diving Area (per each diving board)
Pools with Minimum Deck Areas	15 square feet per user	20 square feet per user	300 square feet
Pools with Deck Area at Least Equal to Water Surface Area	12 square feet per user	15 square feet per user	300 square feet
Pools with Deck Area at Least Twice the Water Surface Area	8 square feet per user	10 square feet per user	300 square feet

AUTHORITY NOTE: Promulgated in accordance with the provisions of R.S. 40:4(A)(11) and R.S. 40:5(3)(16)(17)(20).

HISTORICAL NOTE: Promulgated by the Department of Health and Hospitals, Office of Public Health, LR 20:668 (June 1994), repromulgated LR 29:1105 (July 2003).

§321. Wading Pools
[formerly paragraph 24:008]

A. Wading pools shall be separate and physically set apart from beginning or shallow water areas of swimming pools by at least 6 feet of deck at Class B pools or 4 feet of deck at Class C pools. Where a wading pool is adjacent to any deep water area, a minimum 4 feet high barrier shall be installed separating the two pools.

B. The maximum water depth of wading pools, shall not exceed 24 inches. The water depth at the perimeter shall not exceed 18 inches. Water depths may be reduced from the above maximums and brought to zero at the most shallow point.

C. Walls in wading pools shall be vertical or within 11° of vertical except for the lower 6 inches which shall be radiused to the floor. Walls shall not extend more than 6 inches above the waterline at any point.

D. Floors of wading pools shall be uniform, sloped to drain with a maximum slope of 1 foot in 12 feet.

AUTHORITY NOTE: Promulgated in accordance with the provisions of R.S. 40:4(A)(11) and R.S. 40:5(3)(16)(17)(20).

HISTORICAL NOTE: Promulgated by the Department of Health and Hospitals, Office of Public Health, LR 28:1438 (June 2002).

§323. Decks and Deck Equipment
[formerly paragraph 24:009]

A. Deck (s) shall be designed and installed in accordance with the engineering practices required in the area of installation. This includes the design and quality of subbase when required, concrete mix design, reinforcing, joints, etc. If a concrete deck is selected, in the absence of specific local engineering practices, the work shall be performed in accordance with the recommended practices of American Concrete Institute (ACI) Standard 302.1R-80, "Guide for Concrete Floor and Slab Construction."

B. Decks, ramps, coping and similar step surfaces shall be slip-resisting and easily cleanable.

C. Special features in or on deck(s) such as markers, brand insignias or similar shall conform to this article.

D. Risers for steps for the deck shall be uniform and have a minimum height of 3 3/4 inches and a maximum height of 7 1/2 inches. The minimum tread depth shall be 10 inches.

E. Excavation areas shall be adequately compacted when they support the deck(s).

F. The minimum continuous, unobstructed deck width, including the coping, shall conform to the following:

1. Class A pool—as recommended by the appropriate activity (FINA, U.S. Swimming, U.S. Diving);
2. Class B pool—6 feet minimum;

3. Class C pool—4 feet minimum;
4. Class D pool—3 feet minimum where possible;

5. a minimum of 4 feet deck width shall be provided on the sides and rear of any diving equipment. A deck clearance of 24 inches shall be provided around any other deck equipment that is 36 inches or less in height above the deck. A deck clearance of 36 inches shall be provided around all other deck equipment;

6. when pools, spas, wading pools, etc., are used and/or constructed adjoining, the requirements for decking shall be additive, i.e., a cumulative sum of the minimums.

G. The minimum slope of the deck(s) shall be 1/8 inch per 1 foot for textured, hand-finished concrete decks; 1/4 inch per 1 foot for exposed aggregate concrete decks; and 1/2 inch per 1 foot for indoor/outdoor carpeting decks, unless an alternate drainage method is provided.

H. The maximum slope of all decks, other than wood decks, shall be 1 inch per foot except for ramps. The maximum slope for wood decks shall be 1/8 inch per foot. Gaps shall be based on good engineering practices with respect to the type of wood used.

I. The maximum voids between adjoining concrete slabs, and/or between concrete slabs and expansion joint material, shall be 3/16 inch of horizontal clearance with a maximum difference in vertical elevation of 1/4 inch.

J. Construction joints where pool coping meets concrete deck(s) shall be watertight and shall not allow water to pass to the ground beneath.

K. The areas where the deck(s) join pool coping shall be designed and installed so as to protect the coping and its mortar bed from damage as a result of reasonable movement of adjoining deck(s).

L. Joints in deck(s) shall be provided to minimize the potential for cracks due to a change in elevations, separation of surfaces or movement of the slab.

M. The areas where deck(s) join concrete work shall be protected by expansion joints to protect the pool adequately from the pressures of relative movements.

N. Deck(s) shall be edged, have a radius, or be otherwise relieved to eliminate sharp corners.

O. Deck(s) shall be sloped to effectively drain either to perimeter areas or to deck drains. Drainage shall remove pool splash water, deck cleaning water, and rain water without leaving standing water.

P. Site drainage shall be provided so as to direct all perimeter deck drainage away from the pool. When required, yard drains shall be installed to prevent the accumulation or puddling of site water in the general area of the deck(s) and related improvements.

Q. Circulation system piping, other than that integrally included in the manufacture of the pool, shall be subject to an induced static hydraulic pressure test (sealed system) at 25 pounds per square inch (psi) for 30 minutes. This test

shall be performed before the deck is poured, and the pressure shall be maintained through the deck pour.

R. Valves installed in or under any deck(s) shall provide a minimum 10 inches diameter access cover and valve pit to facilitate servicing.

S. A hose bib and a vacuum breaker shall be provided for washing down the entire deck area.

AUTHORITY NOTE: Promulgated in accordance with the provisions of R.S. 40:4(A)(11) and R.S. 40:5(3)(16)(17)(20).

HISTORICAL NOTE: Promulgated by the Department of Health and Hospitals, Office of Public Health, LR 28:1438 (June 2002).

§325. Entry/Exit
[formerly paragraph 24:010]

A. All pools shall have at least two means of entry/exit located so as to serve both ends of the pool. These shall consist of ladders, stairs, or recessed treads and may be used in combination. All treads shall have slip-resisting surfaces.

B. Where water depths are 24 inches or less at the pool wall, such areas shall be considered as providing their own natural mode for entry/exit.

C. For pools or water areas over 30 feet in width, both sides of the deep portions of the pool shall have entries/exits provided.

D. A means of entry/exit for the shallow end shall be located between the shallow end wall and the cross section at Point D, while a means of entry/exit for the deep end shall be between the deep end wall and the cross section at Point B (refer to §317).

E. A means of entry/exit shall be provided at a minimum of every 75 linear feet of pool wall or fraction thereof.

F. Stairs, ladders, and recessed treads shall be located so as not to interfere with racing lanes if applicable.

AUTHORITY NOTE: Promulgated in accordance with the provisions of R.S. 40:4(A)(11) and R.S. 40:5(3)(16)(17)(20).

HISTORICAL NOTE: Promulgated by the Department of Health and Hospitals, Office of Public Health, LR 28:1438 (June 2002).

§327. Pool Stairs
[formerly paragraph 24:011]

A. The design and construction of protruding and recessed pool stairs shall conform to following.

1. Step treads shall have a minimum unobstructed horizontal depth of 10 inches and a minimum unobstructed surface area of 240 square inches.

2. Risers at the centerline of the treads shall have a maximum uniform height of 12 inches, with the bottom riser height allowed to vary plus or minus 2 inches from the uniform riser height.

3. Each set of stairs shall be provided with at least one handrail to serve all treads and risers. Handrails shall conform to the following.

a. Handrails, if removable, shall be installed in such a way that they cannot be removed without the use of tools.

b. The leading edge of handrails facilitating stairs and pool entry/exit shall be no more than 18 inches plus or minus 3 inches, horizontally from the vertical plane of the bottom riser (where applicable).

c. The outside diameter of handrails shall be between 1 inch and 1 9/10 inches.

AUTHORITY NOTE: Promulgated in accordance with the provisions of R.S. 40:4(A)(11) and R.S. 40:5(3)(16)(17)(20).

HISTORICAL NOTE: Promulgated by the Department of Health and Hospitals, Office of Public Health, LR 28:1439 (June 2002).

§329. Pool Ladders
[formerly paragraph 24:012]

A. The design and construction of pool ladder(s) shall conform to the following.

1. Pool ladders shall be made entirely of corrosion-resisting materials.

2. Ladders shall provide two handholds or two handrails.

3. Below the water level, there shall be a clearance of not more than 6 inches nor less than 3 inches between any ladder tread edge and the pool wall.

4. The clear distance between ladder handrails shall be a minimum of 17 inches and a maximum of 24 inches.

5. There shall be a uniform height between ladder treads, with a 7-inch minimum distance and a 12-inch maximum distance.

6. Ladder treads shall have a minimum horizontal depth of 1 1/2 inches.

AUTHORITY NOTE: Promulgated in accordance with the provisions of R.S. 40:4(A)(11) and R.S. 40:5(3)(16)(17)(20).

HISTORICAL NOTE: Promulgated by the Department of Health and Hospitals, Office of Public Health, LR 28:1439 (June 2002).

§331. Pool Appurtenances
[formerly paragraph 24:013]

A. [Formerly paragraph 24:013-1] Recessed Treads. The design and construction of recessed treads in the pool wall shall conform to the following.

1. Recessed treads at the centerline shall have a uniform vertical spacing of 12 inches maximum and 7 inches minimum.

2. The vertical distance between the pool coping edge, deck, or step surface and the uppermost recessed tread shall be a maximum of 12 inches.

3. Recessed treads shall have a minimum depth of 5 inches and a minimum width of 12 inches.

4. Recessed treads shall drain into the pool to prevent the accumulation of dirt.

5. Each set of recessed treads shall be provided with a set of handrails/grabrails/handholds to serve all treads and risers.

B. Support for Diving Equipment [formerly paragraph 24:013-2]

1. Supports, platforms, stairs, and ladders for diving equipment shall be designed to carry the anticipated loads. Stairs and ladders shall be of corrosion-resisting material, easily cleanable and with slip-resisting tread. All diving stands higher than 21 inches measured from the deck to the top butt end of the board shall be provided with stairs and/or a ladder. Step treads shall be self-draining.

2. Platforms and diving equipment of 1 meter or less shall be protected with guard rails which shall be at least 30 inches above the diving board and extend to the edge of the pool wall. All platforms or diving equipment higher than 1 meter shall have guard rails which are at least 36 inches above the diving board and extend to the edge of the pool wall.

AUTHORITY NOTE: Promulgated in accordance with the provisions of R.S. 40:4(A)(11) and R.S. 40:5(3)(16)(17)(20).

HISTORICAL NOTE: Promulgated by the Department of Health and Hospitals, Office of Public Health, LR 28:1439 (June 2002).

Chapter 5. Circulation Systems [formerly Subpart C]

§501. Design Requirements [formerly paragraph 24:013-3]

A. A circulation system consisting of pumps, piping, return inlets and suction outlets, filters, and other necessary equipment shall be provided for complete circulation of water through all parts of the pool.

B. The equipment shall be of adequate size to turn over the entire pool water capacity at least once every eight hours. This system shall be designed to give the proper turnover rate based on the manufacturer's recommended maximum pressure flow of the filter in clean media condition of the filter. Water clarity shall be maintained. When standing at the pool's edge at the deep end, the deepest portion of the pool floor shall be visible.

C. Circulation system components which require replacement or servicing shall be accessible for inspection, repair, or replacement, and shall be installed in accordance with the manufacturer's instructions.

D. Where equipment sizing falls within the scope of National Sanitation Foundation (NSF) testing, materials and equipment used in the circulation system shall comply with the appropriate requirements of NSF Standard 50.

AUTHORITY NOTE: Promulgated in accordance with the provisions of R.S. 40:4(A)(11) and R.S. 40:5(3)(16)(17)(20).

HISTORICAL NOTE: Promulgated by the Department of Health and Hospitals, Office of Public Health, LR 28:1439 (June 2002).

§503. Water Velocity [formerly paragraph 24:013-4]

A. The water velocity in the pool piping shall not exceed 10 feet per second for discharge piping, (except for copper pipe where the velocity should not exceed 8 feet per second),

and 6 feet per second for suction piping, unless summary calculations are provided to show that the greater flow is possible with the pump and piping provided. Pool piping shall be sized to permit the rated flows for filtering and cleaning without exceeding the maximum head of the pump.

1. A wading pool shall have a separate circulation system of adequate size to turn over the entire pool water capacity at least once every two hours.

B. Piping and Fittings. The circulation system piping and fittings shall be non-toxic, shall be considered to be process piping, and shall be of material able to withstand operating pressures and operating conditions.

1. Pool piping subject to damage by freezing shall have a uniform slope in one direction equipped with valves for adequate drainage. Pool piping shall be supported at sufficient intervals to prevent entrapment of air, water or dirt. Provisions shall be made for expansion or contraction of pipes.

C. System Condition. A pressure or vacuum gauge or other means of indicating system condition shall be provided in the circulation system in an easily readable location.

1. Class A, Class B, and Class C public pools shall be provided with an indicator measuring the rate of flow through the filter system with an appropriate range readable in gallons per minute and accurate within 10 percent actual flow.

AUTHORITY NOTE: Promulgated in accordance with the provisions of R.S. 40:4(A)(11) and R.S. 40:5(3)(16)(17)(20).

HISTORICAL NOTE: Promulgated by the Department of Health and Hospitals, Office of Public Health, LR 28:1440 (June 2002).

§505. Filters [formerly paragraph 24:013-5]

A. Design. Filters shall be designed so that after cleaning per manufacturer's instructions the system can provide the required water clarity.

1. Filters shall be designed so that filtration surfaces can be inspected and serviced.

AUTHORITY NOTE: Promulgated in accordance with the provisions of R.S. 40:4(A)(11) and R.S. 40:5(3)(16)(17)(20).

HISTORICAL NOTE: Promulgated by the Department of Health and Hospitals, Office of Public Health, LR 28:1440 (June 2002).

§507. Pumps and Motors [formerly paragraph 24:013-6]

A. A pump motor shall be provided for circulation of the pool water. Performance of all pumps shall meet or exceed the conditions of flow required for filtering and cleaning (if applicable) the filters against the total dynamic head developed by the complete system.

B. All motors shall have, as minimum, an open, drip-proof enclosure (as defined by the latest National Electrical Manufacturers Association [NEMA] Standard ANSI/NEMA-MGI) and be constructed electrically and mechanically to

perform satisfactorily and safely under the conditions of load and environment normally encountered in swimming pool installations.

AUTHORITY NOTE: Promulgated in accordance with the provisions of R.S. 40:4(A)(11) and R.S. 40:5(3)(16)(17)(20).

HISTORICAL NOTE: Promulgated by the Department of Health and Hospitals, Office of Public Health, LR 28:1440 (June 2002).

§509. Return Inlets and Suction Outlets
[formerly paragraph 24:013-7]

A. Return inlet(s) and suction outlet(s) shall be provided and arranged to produce a uniform circulation of water and maintain a uniform disinfectant residual throughout the pool. Where skimmers are used, the return inlet(s) shall be located so as to help bring floating particles within range of the skimmer.

B. A public pool shall have a minimum of two return inlets regardless of pool size. The number of return inlets shall be based on two inlets per 600 square feet of pool surface area, or fraction thereof.

C. The pool shall not be operated if the outlet grate is missing, broken, or secured in such a way that it can be removed without the use of tools.

1. All pools shall be provided with main drain suction outlet(s) in the lowest point of the pool floor. The spacing of the main drain(s) for suction outlet(s) shall not be greater than 20 feet on centers nor more than 15 feet from each side wall.

2. In large pools with outlets more than 5 feet from the end wall, inlets shall be placed on equidistant centers around the entire perimeter of the pool. The maximum distance between inlets shall be 20 feet. Pools more than 30 feet wide shall have bottom inlets, or other demonstrably effective means to provide uniform distribution of disinfectant throughout the pool.

AUTHORITY NOTE: Promulgated in accordance with the provisions of R.S. 40:4(A)(11) and R.S. 40:5(3)(16)(17)(20).

HISTORICAL NOTE: Promulgated by the Department of Health and Hospitals, Office of Public Health, LR 28:1440 (June 2002).

§511. Inlets and Outlets
[formerly paragraph 24:013-8]

A. Design. Return water inlets shall be adjustable so that water can be distributed evenly.

B. Number and Location

1. All inlets shall discharge at a depth of at least 10 to 15 inches below pool overflow level to prevent loss of disinfectant.

2. In large pools, with outlets more than 5 feet from the end wall, inlets shall be placed on 20 foot centers entirely around the perimeter of the pool or in the bottom. Pools more than 30 feet wide shall have bottom inlets.

3. In smaller pools when the distance across the shallow end is as great as 15 feet, multiple inlets at the shallow end shall be provided. These inlets must serve not

more than 15 linear feet each. In spoon-shaped rectangular pools where outlets are located more than 5 feet from the end walls, inlets must be placed at both ends of the pool.

C. Main Drain

1. The main drain outlet grating shall have an area of openings four times the area of the discharge pipe to prevent objectionable suction effects.

2. The main drain outlet system, located in the deepest section of the pool, shall be provided with more than one outlet point if the pool width exceeds 20 feet. These outlets shall be no farther apart than 20 feet on center and no closer than 10 feet from the side walls.

3. The grating of the main drain outlet shall be easily visible. Drains not constructed of shiny metal shall be marked with a dark colored circle.

D. Back Siphonage. Water discharged from the pool to waste must pass through an air gap to preclude back-siphonage.

AUTHORITY NOTE: Promulgated in accordance with the provisions of R.S. 40:4(A)(11) and R.S. 40:5(3)(16)(17)(20).

HISTORICAL NOTE: Promulgated by the Department of Health and Hospitals, Office of Public Health, LR 28:1440 (June 2002).

§513. Suction Outlet
[formerly paragraph 24:013-9]

A. If the suction outlet system, such as a filtration system, booster system, automatic cleaning system, solar system, etc., has a single suction outlet, or multiple suction outlets which can be isolated by valves, each suction outlet shall protect against user entrapment by either:

1. an antivortex cover;
2. a 12 inch by 12 inch grate or larger;
3. Section 511.C. Main Drain;
4. other means approved by the state health officer.

AUTHORITY NOTE: Promulgated in accordance with the provisions of R.S. 40:4(A)(11) and R.S. 40:5(3)(16)(17)(20).

HISTORICAL NOTE: Promulgated by the Department of Health and Hospitals, Office of Public Health, LR 28:1441 (June 2002).

§515. Surface Skimmer Systems
[formerly paragraph 24:013-10]

A. A surface skimming system shall be provided on all public swimming pools, and shall be designed and constructed to skim the pool surface when the water level is maintained within the operational parameters of the system's rim or weir device.

B. Where automatic surface skimmers are used as the sole overflow system, at least one surface skimmer shall be provided for each 500 square feet or fraction thereof of the water surface area.

C. Where a perimeter-type surface skimming system is used as the sole surface skimming system, this system shall extend around a minimum 50 percent of the perimeter of the pool.

1. Where perimeter surface skimming systems are used, they shall be connected to the circulation system with a system surge capacity of not less than 1 gallon for each square foot of pool surface.

D. **Overflow Gutter and Skimmers.** An overflow gutter, if utilized, shall extend completely around the pool. The overflow gutter shall be designed so as to be easily cleanable and so that material entering it will not be washed out by a sudden surge of entering water, and so that the danger of bathers catching arms or feet in it may be reduced to a minimum. A sufficient number of drainage outlets shall be provided to carry away water entering the overflow gutter during surface flushing.

AUTHORITY NOTE: Promulgated in accordance with the provisions of R.S. 40:4(A)(11) and R.S. 40:5(3)(16)(17)(20).

HISTORICAL NOTE: Promulgated by the Department of Health and Hospitals, Office of Public Health, LR 28:1441 (June 2002).

§517. Heaters

[formerly paragraph 24:013-12]

A. **Installation.** The heater(s) shall be installed in accordance with all federal, state, and local codes as well as the manufacturer's recommendations.

B. Heaters shall be tested and shall comply with the requirements of ANSI-Z21.56a-1990 for gas applications, or UL 1261 for electrical applications. Heat pumps shall comply with the UL 559 specifications and be accepted by a recognized testing facility.

C. Owner/operator shall routinely check the in-pool water to ensure that the temperature does not exceed 93°F. If adjustments are necessary, those adjustments shall be performed in accordance with manufacturer's instructions.

AUTHORITY NOTE: Promulgated in accordance with the provisions of R.S. 40:4(A)(11) and R.S. 40:5(3)(16)(17)(20).

HISTORICAL NOTE: Promulgated by the Department of Health and Hospitals, Office of Public Health, LR 28:1441 (June 2002).

Chapter 7. General Standards

§701. Depth Markers

[formerly paragraph 24:013-13]

A. Depth markers shall conform to the following.

1. Depth of water in feet shall be plainly and conspicuously marked at or above the waterline on the vertical pool wall and on the top of the coping or edge of the deck or walk next to the pool.

2. Depth markers on the vertical pool wall shall be positioned to be read from the water side.

3. Depth markers on the deck shall be within 18 inches of the water edge and positioned to be read while standing on the deck facing the water.

4. Depth markers shall be slip-resisting.

5. Depth markers shall be installed at the maximum and minimum water depth and at all points of slope change.

6. Depth markers shall be installed at intermediate increments of water depth not to exceed 2 feet, nor spaced at distances greater than 25 foot intervals.

7. Depth markers shall be arranged uniformly on both sides and both ends of the pool.

8. Depth markers on irregularly shaped pools shall designate depths at all major deviations in shape as well as conform to the foregoing articles.

9. Depth markers shall have a 4-inch minimum height. Numbers shall be of contrasting color to the background on which they are applied, and the color shall be of a permanent nature.

10. A rope and float line shall be provided between 1 foot and 2 feet on the shallow side of the break in grade between the shallow and deep portions of the swimming pool, with its position marked with visible floats at not greater than seven feet intervals.

AUTHORITY NOTE: Promulgated in accordance with the provisions of R.S. 40:4(A)(11) and R.S. 40:5(3)(16)(17)(20).

HISTORICAL NOTE: Promulgated by the Department of Health and Hospitals, Office of Public Health, LR 28:1441 (June 2002).

§703. Lifesaving Equipment

[formerly paragraph 24:013-14]

A. Class A, Class B, and Class C swimming pools shall have lifesaving equipment conspicuously and conveniently on hand at all times including the following:

1. a light, strong pole not less than 12 feet long, including a body hook;

2. a minimum 1/4 inch diameter throwing rope as long as 1 1/2 times the maximum width of the pool or 50 feet, whichever is less, to which has been firmly attached a ring buoy with an outside diameter of approximately 15 inches or a similar flotation device;

3. a telephone with posted names and phone numbers of nearest available police, fire, ambulance service and/or rescue unit, and/or 911, if available;

4. it is recommended that Class B and Class C pools with over 1,800 square feet of water surface area shall have at least one elevated lifeguard chair for each 3,000 square feet of pool surface or fraction thereof. Where a pool is provided with more than one lifeguard chair, and pool width is 45 feet or more, they shall be located on each side of the pool.

AUTHORITY NOTE: Promulgated in accordance with the provisions of R.S. 40:4(A)(11) and R.S. 40:5(3)(16)(17)(20).

HISTORICAL NOTE: Promulgated by the Department of Health and Hospitals, Office of Public Health, LR 28:1442 (June 2002).

§705. Barriers

[formerly paragraph 24:013-15]

A. Barriers shall conform with the requirements of the following.

1. Class A or Class B public swimming pools shall be protected by a fence, wall, building, enclosure, or solid wall of durable material of which the pool itself may be constructed, or any combination thereof. Natural or artificial barriers shall be provided so as to afford no external handholds or footholds, be at least 4 feet in height, and be equipped with a self-closing and positive self-latching closure mechanism at a height of at least 45 inches above the ground and provided with hardware for locking.

AUTHORITY NOTE: Promulgated in accordance with the provisions of R.S. 40:4(A)(11) and R.S. 40:5(3)(16)(17)(20).

HISTORICAL NOTE: Promulgated by the Department of Health and Hospitals, Office of Public Health, LR 28:1442 (June 2002).

§707. Interconnections
[formerly paragraph 24:014]

A. There shall be no physical connection between a potable public or private water supply system and a pool structure at a point below the maximum flow line of the pool, or to the recirculation system of the swimming pool, unless such physical connection is so installed and operated that no pool water can be discharged or siphoned into a potable water supply system.

AUTHORITY NOTE: Promulgated in accordance with the provisions of R.S. 40:4(A)(11) and R.S. 40:5(3)(16)(17)(20).

HISTORICAL NOTE: Promulgated by the Department of Health and Hospitals, Office of Public Health, LR 28:1442 (June 2002).

§709. Water Supply
[formerly paragraph 24:015]

A. The water supply serving the pool shall be from an approved water supply.

B. No direct mechanical connection shall be made between the potable water supply and the swimming pool, chlorinating equipment, or the system of piping for the pool, unless it is protected against backflow and back-siphonage in a manner approved by the state and local authority, or through an air gap meeting the latest American National Standards Institute Standard A112.1.2, or other equivalent means approved by the state health officer.

C. An over-the-rim spout, if used, shall be located under a diving board, adjacent to a ladder, or otherwise properly shielded so as not to create a hazard. Its open end shall have no sharp edges and shall not protrude more than 2 inches beyond the edge of the pool.

AUTHORITY NOTE: Promulgated in accordance with the provisions of R.S. 40:4(A)(11) and R.S. 40:5(3)(16)(17)(20).

HISTORICAL NOTE: Promulgated by the Department of Health and Hospitals, Office of Public Health, LR 28:1442 (June 2002).

§711. Waste Water Disposal
[formerly paragraph 24:016]

A. Backwash water may be discharged into a sanitary sewer through an approved air gap, or into an approved subsurface disposal system or by other means approved by the state health officer.

B. Sewage disposal shall be of a manner conforming to the provisions of Part XIII of this Code.

AUTHORITY NOTE: Promulgated in accordance with the provisions of R.S. 40:4(A)(11) and R.S.40:5(3) (16)(17)(20).

HISTORICAL NOTE: Promulgated by the Department of Health and Hospitals, Office of Public Health, LR 28:1442 (June 2002).

§713. Electrical Requirements
[formerly paragraph 24:013-11]

A. The requirements of the latest National Electrical Code of the National Fire Protection Agency shall be complied with.

AUTHORITY NOTE: Promulgated in accordance with the provisions of R.S. 40:4(A)(11) and R.S. 40:5(3)(16)(17)(20).

HISTORICAL NOTE: Promulgated by the Department of Health and Hospitals, Office of Public Health, LR 28:1442 (June 2002).

§715. Lighting
[formerly paragraph 24:022]

A. Whenever swimming pools, bathing places, or water slides are to be operated at night, illumination shall be provided as follows.

1. Where night activities are permitted and underwater lighting is used, not less than 0.5* watts shall be provided per square foot of pool area. Area lighting shall be provided for the deck areas and directed toward the deck areas away from the pool surface insofar as practical. 0.6 watts per square foot of deck area shall be used.

2. Where night swimming is permitted and underwater lighting is used, area pool lighting combined shall be provided at not less than 2 watts per square foot of deck area.

*Values of Efficiency for incandescent lamps assumed to be 20 lamp lumens per watt.

3. In either case, lighting shall be provided in such concentration so as to permit a black circle 6 inches in diameter on a white field, when placed on the bottom of the pool at the deepest point, to be clearly visible from the deck around the pool at all distances up to 10 yards measured from a line drawn across the pool through said disk.

4. Semi-Artificial and Natural Swimming Pools and Bathing Places

a. Minimum foot-candles (F-C) (measured vertically on the surface):

i. all water areas utilized if a large body of water is involved: (this amount of light must be present out to 150 feet from the shore): 3 F-C;

ii. adjacent land areas utilized during swimming or bathing activities: 1 F-C.

5. Stairs from lower to upper areas of water slides shall be provided with at least 10 foot-candles of illumination (measured on the surface).

6. All areas used or traversed by people, inside of all ancillary buildings, shall be provided with at least 10 foot-candles of illumination (measured 3 feet above the floor).

7. Various of the lighting requirements, which do not alter maximum safety considerations of the need for lighting, may be approved by the state health officer, on a case by case basis.

AUTHORITY NOTE: Promulgated in accordance with the provisions of R.S. 40:4(A)(11) and R.S. 40:5(3)(16)(17)(20).

HISTORICAL NOTE: Promulgated by the Department of Health and Hospitals, Office of Public Health, LR 28:1443 (June 2002).

§717. Ventilation
[formerly paragraph 24:023]

A. All indoor pools, including dressing rooms and all other rooms that are used or traversed by people (except restrooms, bathrooms, water closet combination rooms, and toilet rooms) in any pool buildings or ancillary buildings, shall be ventilated by methods including, but not limited to, one or more of the following: windows, air conditioning, or forced air ventilation.

B. Every restroom, bathroom, water closet combination room, and toilet room, shall be provided with ventilation in accordance with §405.A of the Louisiana State Plumbing Code (LSPC).

C. Chlorine Room. A separate chlorine room at or above grade is required if gas chlorination is used. There shall be direct access to the room from outside the building, and it shall have one or more observation windows for viewing the interior from the outside and from the filter room without entering. The room shall be large enough to house the chlorinator and chlorine storage tanks as required. Provision must be made in this room for chaining storage tanks to a wall or post, for installation of scales to weigh chlorine tanks, and for a spark-proof ventilation fan capable of producing a complete exchange of air in two minutes. The fan shall exhaust from floor level. Provision must be made to store an approved gas mask, for emergency access, directly outside one entrance to the chlorine room. The floor should be of non-slip material, and a separate drain, that is not connected to others in the building, shall be provided. A hose connection is also required.

AUTHORITY NOTE: Promulgated in accordance with the provisions of R.S. 40:4(A)(11) and R.S. 40:5(3)(16)(17)(20).

HISTORICAL NOTE: Promulgated by the Department of Health and Hospitals, Office of Public Health, LR 28:1443 (June 2002), amended LR 38:2927 (November 2012).

§719. Visitors Gallery
[formerly paragraph 24:024]

A. There shall be a separation of the space used by spectators from that used by bathers. Galleries for spectators shall not overhang any portion of the pool surface. Floor and foot rail of the gallery shall be of tight construction to prevent dirt which is tracked in from getting into the pool. The drainage from the spectators area shall in no case be allowed to drain upon the area used exclusively by bathers. A curb or other arrangement shall be used to prevent litter

and dirt from being kicked or scuffed by spectators into the pool or pool area.

AUTHORITY NOTE: Promulgated in accordance with the provisions of R.S. 40:4(A)(11) and R.S. 40:5(3)(16)(17)(20).

HISTORICAL NOTE: Promulgated by the Department of Health and Hospitals, Office of Public Health, LR 28:1443 (June 2002).

§721. Dressing Rooms
[formerly paragraph 24:025]

A. Dressing rooms shall be provided. Floor shall be well drained, impervious to moisture and constructed of non-slip material. Walls and partitions shall be constructed of smooth, impervious material, without open cracks or joints.

AUTHORITY NOTE: Promulgated in accordance with the provisions of R.S. 40:4(A)(11) and R.S. 40:5(3)(16)(17)(20).

HISTORICAL NOTE: Promulgated by the Department of Health and Hospitals, Office of Public Health, LR 28:1443 (June 2002).

§723. Plumbing Fixtures
[formerly paragraph 24:026]

A. One water closet and one urinal shall be provided for each 60 males or fraction thereof. One water closet shall be provided for each 30 females or fraction thereof. Female urinals, if provided, may be used in the same proportion as for men above. One lavatory with hot and cold water, under pressure delivered through a mixing faucet and soap shall be provided for each 60 patrons or fraction thereof. Circular foot-operated lavatories, serving several persons at one time, may be used in some situations, such as in schools. One shower shall be provided for each 40 persons or fraction thereof. One drinking fountain shall be provided for each 100 persons or fraction thereof. Number of persons shall be calculated on the basis of pool load as described in §319 (Maximum User Load). (An equal distribution of males and females will be assumed unless otherwise indicated.)

AUTHORITY NOTE: Promulgated in accordance with the provisions of R.S. 40:4(A)(11) and R.S. 40:5(3)(16)(17)(20).

HISTORICAL NOTE: Promulgated by the Department of Health and Hospitals, Office of Public Health, LR 28:1443 (June 2002).

§725. Experimental and Innovative Processes and Equipment
[formerly paragraph 24:027]

A. Experimental units must be submitted to the state health officer for review. Additional information may be required. Approval of experimental units by the state health officer will be based on the merit and need of proposed experimental unit(s). Bonding may be required.

B. Experimental units and treatment chemicals such as, but not limited to, Ion generators, bactericides, and alternative disinfectants will be evaluated on a case by case basis, and require prior approval of the state health officer.

AUTHORITY NOTE: Promulgated in accordance with the provisions of R.S. 40:4(A)(11) and R.S. 40:5(3)(16)(17)(20).

HISTORICAL NOTE: Promulgated by the Department of Health and Hospitals, Office of Public Health, LR 28:1443 (June 2002).

§727. Abandoned Pools
[formerly paragraph 24:028]

A.1. A pool that is not in use and/or not intended for use that presents a situation endangering the public health as deemed by the state health officer, shall be either:

- a. emptied;
- b. filled with inert material;
- c. covered and anchored; or
- d. addressed by other methods submitted to and approved by the state health officer.

2. The owner and/or lessee shall jointly be held liable.

AUTHORITY NOTE: Promulgated in accordance with the provisions of R.S. 40:4(A)(11) and R.S. 40:5(3)(16)(17)(20).

HISTORICAL NOTE: Promulgated by the Department of Health and Hospitals, Office of Public Health, LR 28:1444 (June 2002).

§729. Food Service for Class A and B Public Pools
[formerly paragraph 24:032]

A. Eating, drinking, and smoking shall not be permitted within the pool deck enclosure.

B. Exception to §729.A may be made to allow food and beverage(s) in the visitor and spectator area or in a similarly separated snack bar area for users which has been approved by the state health officer.

C. Food and beverage(s) shall only be served in non-breakable containers.

D. Trash containers shall be provided where food and/or beverage(s) are available.

E. All food service establishments must be in compliance with Part XXIII of the state sanitary code.

AUTHORITY NOTE: Promulgated in accordance with the provisions of R.S. 40:4(A)(11) and R.S. 40:5(3)(16)(17)(20).

HISTORICAL NOTE: Promulgated by the Department of Health and Hospitals, Office of Public Health, LR 28:1444 (June 2002).

§731. Operation and Maintenance
[formerly paragraph 24:033]

A. Lifeguards and safety assistants shall be attired so that they are readily identifiable as members of the lifeguard staff. Individuals shall be considered qualified in life-saving and first aid if they hold the appropriate Red Cross certificate or equivalent.

B. Instructions. Rules and regulations for users shall be posted in a conspicuous place to inform pool patrons.

AUTHORITY NOTE: Promulgated in accordance with the provisions of R.S. 40:4(A)(11) and R.S. 40:5(3)(16)(17)(20).

HISTORICAL NOTE: Promulgated by the Department of Health and Hospitals, Office of Public Health, LR 28:1444 (June 2002).

§733. Emergency Equipment
[formerly paragraph 24:034]

A. Pole-hooks, ropes, buoys and other necessary lifesaving equipment shall be provided and be readily accessible at all pools and bathing places. A first-aid kit completely equipped shall be provided for emergency use at all pools and bathing places.

AUTHORITY NOTE: Promulgated in accordance with the provisions of R.S. 40:4(A)(11) and R.S. 40:5(3)(16)(17)(20).

HISTORICAL NOTE: Promulgated by the Department of Health and Hospitals, Office of Public Health, LR 28:1444 (June 2002).

Chapter 9. Disinfection and Bacteriological Quality

§901. Disinfectant Equipment and Chemical Feeders
[formerly paragraph 24:017]

A. Disinfectant equipment and chemical feeders, hereinafter referred to jointly as "equipment," shall comply with the requirements of NSF Standard 50. The disinfection equipment shall be capable of precisely introducing a sufficient quantity of an approved disinfecting agent to maintain the appropriate recommended guidelines required concentrations as per §§903 and 905.

1. Every pool shall be required to have at least one unit of disinfectant agent equipment in compliance with §901.A.2. Additional units may be required to maintain chemical and physical parameters of the pool water.

2. The pool water shall be continuously disinfected by a disinfecting agent that imparts an easily measured residual. The disinfecting agent used shall be subject to field testing procedures that are simple and accurate.

B. Chemical Feeders. The installation and use of chemical feeders shall conform to the following.

1. When using chemical feeders, it is extremely important that they be installed downstream from the filter and heater. Erosion-type feeders shall be allowed to feed their solution to the suction side of the pump.

2. If the chemical feeder is equipped with its own pump, it shall be installed so it introduces the gas or solution downstream from the heater and, if possible, at a position lower than the heater outlet fitting.

3. Swimming pools and wading pools which are equipped with gaseous or liquid chlorination feeders must be equipped with a mechanical chemical feeder to continuously control pH. Hand batch feeding of any pH chemical into the pool is expressly prohibited.

C. Test Kit. All pools shall be supplied with chemical test kits for the determination of pH, chlorine or bromide residuals, cyanuric acid (if used), total alkalinity, and calcium hardness. The test kit shall be capable of at least measuring pH and disinfectant residual ranges, as required. The method used in determining the free available chlorine residual shall be such that chloramines or other chlorine compounds that may be present in the pool do not affect the determination.

AUTHORITY NOTE: Promulgated in accordance with the provisions of R.S. 40:4(A)(11) and R.S. 40:5(3)(16)(17)(20).

HISTORICAL NOTE: Promulgated by the Department of Health and Hospitals, Office of Public Health, LR 28:1444 (June 2002).

§903. Disinfection
[formerly paragraph 24:018]

A. Disinfection shall be employed in all swimming pools. The disinfection of the water shall be continuous and when chlorine alone is used, the water shall contain at least 0.4 parts per million residual chlorine; or 0.7 parts per million residual chlorine when chlorine with ammonia is used, as determined by the *N,N* diethyl-*p*-phenylenediamine (DPD) test.

B. On innovative processes, the state health officer may allow new and innovative means of disinfection so long as the disinfection residuals can be measured easily, accurately, and reliably (see §725).

AUTHORITY NOTE: Promulgated in accordance with the provisions of R.S. 40:4(A)(11) and R.S. 40:5(3)(16)(17)(20).

HISTORICAL NOTE: Promulgated by the Department of Health and Hospitals, Office of Public Health, LR 28:1444 (June 2002).

§905. Chemical and Physical Quality of Swimming Pool Water
[formerly paragraph 24:019]

A. Chlorination. Whenever chlorine, calcium hypochlorite, or other chlorine compounds, without the use of ammonia, are used for swimming pool disinfection, the amount of available or free chlorine in the water at all times when the pool is in use shall not be less than 0.4 ppm., nor more than 0.6 ppm. Whenever chlorine or chlorine compounds are used with ammonia, the amount of available or free chlorine shall not be less than 0.7 ppm., nor more than 1.0 ppm.

B. pH Control

1. Swimming Pools and Wading Pools. The pH shall be maintained in an alkaline condition as indicated by a pH of not less than 7.2 nor greater than 7.8 at any time the facility is in use.

2. Bathing Beaches. When the pH is less than 6.5 or greater than 8.5, the beach should not be used for bathing.

C. Clearness. At times when the pool is in use the water shall be sufficiently clear to permit a black disk six inches in diameter on a white field, when placed on the bottom of the pool at the deepest point, to be clearly visible from the deck around the pool at all distances up to 10 yards measured from a line drawn across the pool through said disk.

D. Temperatures. The water in any swimming pool shall not be artificially heated to a temperature above 93°F (34°C). The temperature of the air at any artificially heated indoor swimming pool should not become more than 8°F (4°-5°C) warmer nor more than 2°F (1°C) colder than the water in the pool at any time when the pool is in use.

AUTHORITY NOTE: Promulgated in accordance with the provisions of R.S. 40:4(A)(11) and R.S. 40:5(3)(16)(17)(20).

HISTORICAL NOTE: Promulgated by the Department of Health and Hospitals, Office of Public Health, LR 28:1445 (June 2002).

§907. Cleanliness
[formerly paragraph 24:020]

A. The bottom and sides of pools shall be kept free from sediment and visible dirt. Visible scum or floating matter on the surface of the pool shall be removed at least once each day.

AUTHORITY NOTE: Promulgated in accordance with the provisions of R.S. 40:4(A)(11) and R.S. 40:5(3)(16)(17)(20).

HISTORICAL NOTE: Promulgated by the Department of Health and Hospitals, Office of Public Health, LR 28:1445 (June 2002).

§909. Bacterial Quality
[formerly paragraph 24:021]

A. Swimming Pools. Not more than 15 percent of the samples collected on each two consecutive occasions shall contain more than 200 bacteria per ml. nor shall such samples show positive test (confirmed) for the coli-aerogenes group, in any of 5, 10 ml. portions of water at times when the pool is in use. All primary fermentation tubes showing gas should be confirmed. The state health officer may approve other EPA approved methods for bacteriological and the coli-aerogenes group testing.

B. Bathing Beaches/Places. The coliform group is not to exceed 1,000 per 100 ml. as a monthly geometric average value, nor exceed this number in 20 percent of the samples examined during any month nor exceed 2,400 per 100 ml. on any day. The fecal coliform (either MPN or MF) count shall not exceed 200 per 100 ml. as a 30-day geometric mean based on not less than five samples during any 30-day period nor exceed 400 per 100 ml. in more than 10 percent of all samples during any 30-day period.

AUTHORITY NOTE: Promulgated in accordance with the provisions of R.S. 40:4(A)(11) and R.S. 40:5(3)(16)(17)(20).

HISTORICAL NOTE: Promulgated by the Department of Health and Hospitals, Office of Public Health, LR 28:1445 (June 2002).

Title 51
PUBLIC HEALTH—SANITARY CODE
Part XXV. Mass Gatherings

Chapter 1. General Requirements

§101. Definitions
[formerly paragraph 25:001]

A. Unless otherwise specifically provided herein, the following words and terms used in this Part of the sanitary code and all other Parts which are adopted or may be adopted, are defined for the purposes thereof as follows.

Mass Gathering Area—any place maintained, operated, or used for a mass gathering, or assemblage, except an established permanent stadium, athletic field, arena, auditorium, coliseum, fairground or other similar permanent place of assembly.

Mass Gatherings—a group of 500 or more persons assembled together at any one time, for four or more hours, for a meeting, festival, fair, social gathering, or other similar purposes at a site other than a permanent place of assembly.

Nuisance—annoyance; anything which would cause harm, inconvenience or damage; anything that interferes with the enjoyment of life or property, and includes inadequate and insanitary sewerage or plumbing facilities or any insanitary condition.

Operator—the person responsible for managing the mass gathering area. In the event that no "manager" exists, the owner, or in the event of his unavailability, the lessee of the ground encompassing the mass gathering area, shall be deemed to be the *operator* under these regulation.

Refuse—as defined in Part XXVII §101 of this Code, includes all combustible or noncombustible, putrescible or non-putrescible solid or liquid wastes.

Sanitary Facilities—toilets, lavatories, showers, urinals, drinking fountains, and the service building or room provided for installation and use of these units.

AUTHORITY NOTE: The first note of authority for promulgation of the sanitary code is in R.S. 36:258(B), with more particular provisions found in Chapters 1 and 4 of Title 40 of the Louisiana Revised Statutes. This Part is promulgated in accordance with R.S. 40:5(16).

HISTORICAL NOTE: Promulgated by the Department of Health and Hospitals, Office of Public Health, LR 28:1445 (June 2002).

§103. Permits
[formerly paragraph 25:002]

A. *Application for Permit*—written application for permit must be received by the local health unit at least 30 days in advance of the proposed mass gathering.

B. [Formerly paragraph 25:003] The following shall be included with the application for permit, when applicable: an outline map of the area to be used showing the location of all

proposed toilets to be used, lavatory and bathing facilities, water supply sources, areas of assemblage, camping areas, food service areas, emergency egress roads, refuse disposal, and collection facilities. Also included must be detailed drawing of toilet facilities, sewage disposal system, lavatory and bathing facilities, and water supply system. An anticipated attendance figure shall also be included.

C. [Formerly paragraph 25:004] The operator shall meet all provisions of the state sanitary code and obtain the necessary permit at least 72 hours prior to the starting date of the mass gathering.

D. [Formerly paragraph 25:005] The operator shall be responsible for meeting the provisions of these standards and regulations to serve the maximum number of people to be assembled, for operational maintenance, and for the clean, safe, and sanitary condition of the grounds, sanitary facilities, and other service equipment.

AUTHORITY NOTE: Promulgated in accordance with the provisions of R.S. 40:5(16).

HISTORICAL NOTE: Promulgated by the Department of Health and Hospitals, Office of Public Health, LR 28:1446 (June 2002).

§105. Access
[formerly paragraph 25:006]

A. Each mass gathering area shall be provided with convenient and safe access for the ingress and egress of pedestrian and vehicular traffic.

AUTHORITY NOTE: Promulgated in accordance with the provisions of R.S. 40:5(16).

HISTORICAL NOTE: Promulgated by the Department of Health and Hospitals, Office of Public Health, LR 28:1446 (June 2002).

§107. Grounds
[formerly paragraph 25:007]

A. Each mass gathering area shall be well drained and so arranged as to provide sufficient space for people assembled, vehicles, sanitary facilities, and appurtenant equipment.

B. [Formerly paragraph 25:008] Trees, underbrush, large rocks, and other natural features shall be left intact and undisturbed whenever possible. Natural vegetative cover shall be retained, protected, and maintained so as to facilitate drainage, prevent erosion, and preserve the scenic attributes of the area.

C. [Formerly paragraph 25:009] The grounds shall be maintained free from dust whenever possible, accumulations of refuse and other health and safety hazards constituting a nuisance as defined.

AUTHORITY NOTE: Promulgated in accordance with the provisions of R.S. 40:5(16).

HISTORICAL NOTE: Promulgated by the Department of Health and Hospitals, Office of Public Health, LR 28:1446 (June 2002).

§109. Size
[formerly paragraph 25:010]

A. The size of the mass gathering should be limited to the number of persons for which the facilities are designed to accommodate the provisions should be made to prevent people in excess of the maximum permissible number from gaining access to the mass gathering area.

B. [Formerly paragraph 25:013] At least 20 square feet per person will be provided at the site for daytime assemblage and at least 40 square feet per person shall be provided for overnight assemblage.

AUTHORITY NOTE: Promulgated in accordance with the provisions of R.S. 40:5(16).

HISTORICAL NOTE: Promulgated by the Department of Health and Hospitals, Office of Public Health, LR 28:1446 (June 2002).

§111. Lighting
[formerly paragraph 25:011]

A. Illumination shall be provided, at night, to protect the safety of the persons at the assembly. The mass gathering area shall be adequately lighted but shall not unreasonable reflect beyond the assembly area boundaries, unless adjacent properties are uninhabited. Light level intensities shall be at least 5 foot-candles.

AUTHORITY NOTE: Promulgated in accordance with the provisions of R.S. 40:5(16).

HISTORICAL NOTE: Promulgated by the Department of Health and Hospitals, Office of Public Health, LR 28:1446 (June 2002).

§113. Parking Space
[formerly paragraph 25:012-1]

A. On site parking space shall be provided where persons arrive at the group gathering area by vehicular means.

B. [Formerly paragraph 25:012-2] Service road and parking spaces shall be so located as to permit convenient and safe movement of vehicular and pedestrian traffic and free passage of emergency vehicles.

C. [Formerly paragraph 25:012-3] Width of service roads shall be not less than the following: one traffic lane—11 feet; two traffic lanes—22 feet; parallel parking lane—7 feet.

D. [Formerly paragraph 25:012-4] Parking space shall be provided at the rate of at least one parking space for every four persons. The density shall not exceed 100 passenger cars or 30 busses per usable acre.

AUTHORITY NOTE: Promulgated in accordance with the provisions of R.S. 40:5(16).

HISTORICAL NOTE: Promulgated by the Department of Health and Hospitals, Office of Public Health, LR 28:1446 (June 2002).

§115. Water
[formerly paragraph 25:014]

A. An adequate, safe supply of potable water, under pressure (not less than 20 psi), easily accessible and meeting requirements of Part XII of the Louisiana state sanitary code shall be provided.

B. [Formerly paragraph 25:014-1] If water is to be provided only for drinking and washing, it should be supplied at a rate of at least 5 gallons per person per day.

C. [Formerly paragraph 25:014-2] If water is used for drinking, washing, flushing toilets, and showers when required, then water shall be provided at a rate of at least 15 gallons per person per day.

AUTHORITY NOTE: Promulgated in accordance with the provisions of R.S. 40:5(16).

HISTORICAL NOTE: Promulgated by the Department of Health and Hospitals, Office of Public Health, LR 28:1447 (June 2002).

§117. Sanitary Facilities
[formerly paragraph 25:015]

A. Sanitary facilities shall be provided and installed in the minimum numbers as required by the following schedule.

B. [Formerly paragraph 25:015-1] Toilets. At the rate of 1 for each 200 persons or fractional part thereof.

C. [Formerly paragraph 25:015-2] Urinals. Urinals (men's) and sanistands (women's) may be substituted for up to one-third of the required number of toilets. Twenty-four inches of trough urinals in a men's room shall be considered the equivalent of one urinal or toilet (or as outlined in Part XIV, Section 14:082-1-14:083 of this Code).

D. [Formerly paragraph 25:016] Required sanitary facilities shall be conveniently accessible and well identified.

E. [Formerly paragraph 25:017] Each toilet shall have a continuous supply of toilet paper.

AUTHORITY NOTE: Promulgated in accordance with the provisions of R.S. 40:5(16).

HISTORICAL NOTE: Promulgated by the Department of Health and Hospitals, Office of Public Health, LR 28:1447 (June 2002).

Chapter 3. Construction and Design Requirements

§301. Buildings
[formerly paragraph 25:018]

A. Service buildings or rooms housing required plumbing fixtures, shall be constructed of easily cleanable, non-absorbent materials. The buildings, service rooms, and required plumbing fixtures located therein shall be maintained in good repair and in a clean and sanitary condition.

AUTHORITY NOTE: Promulgated in accordance with the provisions of R.S. 40:5(16).

HISTORICAL NOTE: Promulgated by the Department of Health and Hospitals, Office of Public Health, LR 28:1447 (June 2002).

§303. Water Facilities
[formerly paragraph 25:019]

A. Water points or drinking fountains shall be of approved type, conveniently accessible, and well identified.

B. [Formerly paragraph 25:020] Showers shall be provided at the rate of not less than 1 per 250 persons at gatherings when those in attendance are expected to remain for 48 hours or longer.

AUTHORITY NOTE: Promulgated in accordance with the provisions of R.S. 40:5(16).

HISTORICAL NOTE: Promulgated by the Department of Health and Hospitals, Office of Public Health, LR 28:1447 (June 2002).

§305. Disposal Systems
[formerly paragraph 25:021]

A. Approved facilities shall be provided and properly maintained for the disposal or treatment and disposal of all sewage and liquid waste.

B. [Formerly paragraph 25:022] Where a public sewer system is available, all plumbing fixtures and all building sewers shall be connected thereto. If a public sewer system is not available, a private sewage disposal facility meeting the requirements of Part XIII of this Code shall be installed and connected to all plumbing fixtures and building sewers.

AUTHORITY NOTE: Promulgated in accordance with the provisions of R.S. 40:5(16).

HISTORICAL NOTE: Promulgated by the Department of Health and Hospitals, Office of Public Health, LR 28:1447 (June 2002).

Chapter 5. Operations and Maintenance

§501. Refuse
[formerly paragraph 25:023]

A. The storage, collection, transportation, and disposal of refuse shall be so conducted as to prevent odor, insect, rodent and other nuisance conditions.

B. [Formerly paragraph 25:024] One 50-gallon refuse container or its equivalent shall be provided for each 100 persons anticipated. Refuse containers shall be readily accessible.

C. [Formerly paragraph 25:025] All refuse shall be collected from the assembly area at least once each day of the assembly, and disposed of at a disposal site approved by the state health officer.

D. [Formerly paragraph 25:026] The grounds and immediate surrounding properties shall be cleaned of refuse within 24 hours following the mass gathering.

AUTHORITY NOTE: Promulgated in accordance with the provisions of R.S. 40:5(16).

HISTORICAL NOTE: Promulgated by the Department of Health and Hospitals, Office of Public Health, LR 28:1447 (June 2002).

§503. Vector Control
[formerly paragraph 25:027-1]

A. Insects, rodents, and other vermin shall be controlled by proper sanitary practices and/or approved chemical or biological extermination.

B. [Formerly paragraph 25:027-2] To avoid health hazard, animal ecto-parasites and other disease transmitting and nuisance insects shall be controlled.

AUTHORITY NOTE: Promulgated in accordance with the provisions of R.S. 40:5(16).

HISTORICAL NOTE: Promulgated by the Department of Health and Hospitals, Office of Public Health, LR 28:1447 (June 2002).

§505. Medical and Emergencies
[formerly paragraph 25:028]

A. Emergency medical services shall be provided under the supervision of a licensed physician.

B. [Formerly paragraph 25:029] An enclosed covered structure shall be provided for emergency medical treatment and care.

C. [Formerly paragraph 25:030] Adequate medical supplies and medicines shall be provided and made available for emergency treatment of sick and injured persons.

D. [Formerly paragraph 25:031] Adequate vehicles suitable for emergency use shall be available.

E. [Formerly paragraph 25:032] Telephone or radio communications shall be provided and kept available for emergency purposes.

AUTHORITY NOTE: Promulgated in accordance with the provisions of R.S. 40:5(16).

HISTORICAL NOTE: Promulgated by the Department of Health and Hospitals, Office of Public Health, LR 28:1448 (June 2002).

§507. Food Service
[formerly paragraph 25:033]

A. *Food Service*—all food service operations shall comply with applicable portions of the Louisiana State Sanitary Code (Part XXIII) and the Louisiana Food, Drug and Cosmetic Law (R.S. 40:601 et seq.).

AUTHORITY NOTE: Promulgated in accordance with the provisions of R.S. 40:5(16).

HISTORICAL NOTE: Promulgated by the Department of Health and Hospitals, Office of Public Health, LR 28:1448 (June 2002).

Title 51
PUBLIC HEALTH—SANITARY CODE
Part XXVI. Burial, Transportation, Disinterment or
Other Disposition of Dead Human Bodies

Chapter 1. General Requirements

§101. Permits
[formerly paragraph 26:001-1]

A. The state health officer shall provide a permit for the burial, cremation, entombing, removal, transportation by common carrier or other disposition of dead human bodies as defined by R.S. 40:32; to be known as the burial-transit permit, and no other permit shall be necessary for any other the above dispositions.

B. [Formerly paragraph 26:001-2] The burial-transit permit shall consist of three sections: The first section shall be executed by the State Registrar of Vital Records or his designated agent to whom the certificate of death is presented and shall contain the following information: full name, race, age and sex of the deceased, the place of death, date of death and a space for a statement by the registrar that a certificate of death has been filed and that permission is granted to a stated party to dispose of the corpse. The second section of the permit shall be filled out and signed by the funeral director or other person designated as custodian of the body, and shall contain a statement as to the method of embalming or preparation for final disposition and date thereof. The third section shall be filled out and signed by the sexton or person in charge of burial or other final disposal, and shall contain a statement as to the method of final disposal, date, and name and location of cemetery or crematory, and lot number if burial is in a cemetery.

C. [Formerly paragraph 26:001-3] When dead bodies are shipped by common carrier, the burial-transit permit shall be securely attached to the shipping case in an envelope and shall accompany the remains to their destination.

D. [Formerly paragraph 26:001-4] Within 10 days after burial, cremation or other disposal, the sexton of the cemetery, or other such person in charge of the disposal, shall execute the third section of the burial-transit permit, transcribe the date thereon to the record of the cemetery, and shall forward the permit to the registrar of the parish where the burial or other such disposal occurred.

E. [Formerly paragraph 26:001-5] The burial-transit permits of the other states (including foreign countries) shall be accepted as authorization for burial in the same manner as if the permit had been issued by the State Registrar of Vital Records.

F. [Formerly paragraph 26:002] The local registrar shall file and preserve the executed burial-transit permits which are returned to him by the sexton or other such persons.

AUTHORITY NOTE: The first source of authority for promulgation of the sanitary code is in R.S. 36:258(B), with more particular provisions found in Chapters 1 and 4 of Title 40 of the Louisiana Revised Statutes. This Part is promulgated in accordance with R.S. 40:4(A)(3) and R.S. 40:5(14).

HISTORICAL NOTE: Promulgated by the Department of Health and Hospitals, Office of Public Health, LR 28:1448 (June 2002).

§103. Embalming
[formerly paragraph 26:003-1]

A. [Formerly paragraph 26:003-1] Embalming dead human bodies shall be performed in accordance with R.S. 37:831-861 relating to embalming.

B. [Formerly paragraph 26:003-2] If the body is to be held longer than 30 hours without refrigeration as specified, it shall be embalmed in a manner approved by the Louisiana Board of Embalmers and Funeral Directors. If a dead human body is to be held longer than 30 hours in the custody of a Louisiana licensed hospital, Louisiana medical school, the Louisiana Anatomical Board or a coroner, it shall be refrigerated at all times at a temperature not to exceed 45 degrees Fahrenheit prior to its release to a funeral director for final disposition. If a body is not refrigerated or embalmed, it shall be buried, cremated, or otherwise disposed of within 30 hours after death or as soon as possible after its release to the licensed funeral director. No one shall carry, transport or remove from within the confines of this state any dead human body more than 24 hours after death unless said body has been embalmed or cremated. Nothing in this Section, however, shall be construed to prohibit transfer of an unembalmed dead human body which has been disposed of for the purpose of the advancement of medical science, or for use as "transplant" organs. Additionally, nothing in this Section shall be construed to require embalming if special practices and beliefs of religious groups prohibit it.

AUTHORITY NOTE: Promulgated in accordance with the provisions of R.S. 40:4(A)(3) and R.S. 40:5 (2)(3)(14)(17).

HISTORICAL NOTE: Promulgated by the Department of Health and Hospitals, Office of Public Health, LR 20:1388 (December 1994), repromulgated LR 28:1448 (June 2002), LR 29:1105 (July 2003).

§105. Construction and Alterations of Funeral Establishments
[formerly paragraph 26:004]

A. No new funeral establishments shall hereafter be constructed nor major alterations be made to existing funeral establishments without the prior written approval of, and unless in accordance with the plumbing plans and

specifications approved in advance by the state health officer.

AUTHORITY NOTE: Promulgated in accordance with the provisions of R.S. 40:4(A)(3) and R.S. 40:5(14).

HISTORICAL NOTE: Promulgated by the Department of Health and Hospitals, Office of Public Health, LR 28:1449 (June 2002).

§107. Transportation
[formerly paragraph 26:005-1]

A. The transportation of dead human bodies by a common carrier shall conform to the following requirements.

1. [Formerly paragraph 26:005-2] A burial-transit permit shall accompany the body in accordance with §101.C.

2. [Formerly paragraph 26:005-3] The body shall be placed in a coffin or casket. It shall be enclosed in a strong outer box unless it is transported in a closed vehicle designed exclusively for the transportation of dead human bodies.

B. [Formerly paragraph 26:007] The state health officer reserves the right to prescribe additional requirements regarding transportation and handling of dead human bodies in accordance with the general powers and jurisdiction, where cases warrant such, pursuant to R.S. 40:5.

AUTHORITY NOTE: Promulgated in accordance with the provisions of R.S. 40:4(A)(3) and R.S. 40:5(14).

HISTORICAL NOTE: Promulgated by the Department of Health and Hospitals, Office of Public Health, LR 28:1449 (June 2002).

§109. Burial
[formerly paragraph 26:006]

A. Human bodies shall be buried only in a duly authorized cemetery or burying place as defined or set forth in R.S. Title 8.

AUTHORITY NOTE: Promulgated in accordance with the provisions of R.S. 40:4(A)(3) and R.S. 40:5(14).

HISTORICAL NOTE: Promulgated by the Department of Health and Hospitals, Office of Public Health, LR 28:1449 (June 2002).

Title 51
PUBLIC HEALTH—SANITARY CODE
Part XXVII. Management of Refuse, Infectious Waste,
Medical Waste, and Potentially Infectious Biomedical Waste

Chapter 1. Refuse Management
[formerly Chapter XXVII Part 1]

§101. Definitions
[formerly paragraph 27:001]

A. Unless otherwise specifically provided herein, the following words and terms used in Part XXVII of the sanitary code and all other Parts which are adopted or may be adopted, are defined for the purposes thereof as follows.

Ashes—include the solid residue resulting from the combustion of all fuels, including those used for heating, cooking, and the production of energy in any public or private establishment, institution, or residence.

Garbage—the putrescible components of refuse which are subject to spoilage, rot, or decomposition. It includes wastes from the preparation and consumption of food, vegetable matter, and animal offal and carcasses.

Offal—waste parts especially of a butchered animal including, but not limited to, bones, cartilage, fatty tissue and gristle.

Refuse—any garbage, rubbish, sludge from a waste treatment plant, water supply treatment plant, or air pollution control facility. It also includes other discarded material such as solid, liquid, semi-solid, or contained gaseous material resulting from either industrial, commercial, mining, or agricultural operations, or from community activities. It does not include solid or dissolved material in domestic sewage, irrigation return flows, industrial discharges which are point sources, or radioactive wastes.

Rubbish—includes all non-putrescible waste matter, except ashes, from any public or private establishments, institution, or residence. It also includes construction and demolition wastes.

Stable Refuse—includes animal feces and urine, any material contaminated by animal body discharges, and waste feed stuff.

Trash—*rubbish*.

AUTHORITY NOTE: The first source of authority for promulgation of the sanitary code is in R.S. 36:258(B), with more particular provisions found in Chapters 1 and 4 of Title 40 of the Louisiana Revised Statutes. This Part is promulgated in accordance with R.S. 40:4(A)(2)(b) and R.S. 40:5.

HISTORICAL NOTE: Promulgated by the Department of Health and Hospitals, Office of Public Health, LR 28:1449 (June 2002).

§103. Accumulation and Collection of Refuse
[formerly paragraph 27:002]

A. No owner or lessee of any public or private property or premises nor agent of such owner or lessee shall permit garbage to accumulate upon the property or premises except in tightly covered containers constructed of such material and in such a manner as to be strong, watertight, not easily corroded, and rodent and insect-proof. When garbage and other types of refuse are collected separately, separate containers may be required by the state health officer.

B. [Formerly paragraph 27:003] Refuse shall not be allowed to remain in any house or other building, cellar, or outhouse, or on any premises long enough to cause a nuisance or health hazard.

C. [Formerly paragraph 27:004] The bodies of vehicles used for the collection and transportation of garbage shall be watertight and easily cleaned. Such bodies shall be covered except when being loaded and unloaded.

D. [Formerly paragraph 27:005] No person shall throw, deposit, or allow to fall upon any public or private property any refuse of any kind.

AUTHORITY NOTE: Promulgated in accordance with the provisions of R.S. 40:4(A)(2)(b) and R.S. 40:5.

HISTORICAL NOTE: Promulgated by the Department of Health and Hospitals, Office of Public Health, LR 28:1450 (June 2002).

§105. Swine Feeding
[formerly paragraph 27:006]

A. No garbage, either cooked or raw, shall be disposed of by feeding said garbage to swine.

AUTHORITY NOTE: Promulgated in accordance with the provisions of R.S. 40:4(A)(2)(b) and R.S. 40:5.

HISTORICAL NOTE: Promulgated by the Department of Health and Hospitals, Office of Public Health, LR 28:1450 (June 2002).

§107. Disposal of Carcasses
[formerly paragraph 27:007]

A. Animal offal and the carcasses of animals shall be buried or cremated or shall be cooked (rendered) at minimum temperature of 250 degrees Fahrenheit, which temperature shall be maintained for at least 30 minutes. The apparatus and method or methods used in rendering shall be approved by the Livestock Sanitary Board and the state health officer, and rendering shall not be carried out in any establishment except as required in the *Louisiana Administrative Code*, Title 7, Louisiana Department of Agriculture and Animals, Part XXI (Diseases of Animals) and under the provisions of a permit issued by such representative, as required in Part XI of this Code.

AUTHORITY NOTE: Promulgated in accordance with the provisions of R.S. 40:4(A)(2)(b) and R.S. 40:5.

HISTORICAL NOTE: Promulgated by the Department of Health and Hospitals, Office of Public Health, LR 28:1450 (June 2002).

§109. Stable Refuse
[formerly paragraph 27:008]

A. Every owner, lessee, manager (or other agent of an owner or lessee) of any stable, barn, stall, or any other establishment in the built-up part of any community, in which horses, cattle, dogs, fowl, or any other animals are quartered or in which stable refuse may accumulate shall cause such stable refuse to be removed therefrom, and shall at all times keep, or cause to be kept, such stable, barn, stall, or quarters, and the yards, drains, and appurtenances in a clean and sanitary condition so that no offensive odors shall be allowed to escape therefrom. Manure shall be kept in covered containers, or shall be treated to prevent the breeding of flies.

B. [Formerly paragraph 27:009] It shall be the duty of every owner, lessee, manager (or other agent of an owner or lessee) of any stable, barn, stall, or other establishment used for quartering animals or fowl to cause all stable refuse to be removed daily from such stable, or stable premises, unless the refuse is pressed bales, barrels or boxes. The removal and disposal of stable refuse without a written permit from the state health officer is prohibited.

C. [Formerly paragraph 27:010] Vehicles used for the removal of stable refuse shall be loaded within the premise, and not upon the street or sidewalk.

D. [Formerly paragraph 27:011] No stable refuse vault or receptacle shall be built, or used, on any premises except pursuant to the terms of a permit granted therefore by the state health officer.

AUTHORITY NOTE: Promulgated in accordance with the provisions of R.S. 40:4(A)(2)(b) and R.S. 40:5.

HISTORICAL NOTE: Promulgated by the Department of Health and Hospitals, Office of Public Health, LR 28:1450 (June 2002).

Chapter 3. Management of Infectious Waste, Medical Waste and Potentially Infectious Biomedical Waste
[formerly Chapter XXVII Part 2]

§301. Definitions
[formerly paragraph 27:020]

A. Unless otherwise specifically provided herein, the following words and terms used in this Part of the sanitary code are defined for the purposes thereof as follows.

Generator—any person or facility that produces potentially infectious biomedical waste.

Health Care and Medical Facilities—shall include, but not be limited to hospitals, clinics, dialysis facilities, birthing centers, emergency medical services, mental health facilities, physicians' offices, outpatient surgery centers, nursing and

extended care facilities, podiatry offices, dental offices and clinics, veterinary medical facilities, medical laboratories, home health care services, diagnostic services, mortuaries, and blood and plasma collection centers and mobile units.

Infectious Waste—that portion of potentially infectious biomedical waste which contains pathogens with sufficient virulence and quantity that exposure to the waste by a susceptible host could result in an infectious disease.

Labeling—to pre-print, mold an impression, write on or affix a sign to a package that is water resistant, legible and readily visible.

Large Health Care and Medical Facility Generator—a health facility generating 25 or more kilograms (55 pounds) of potentially infectious biomedical waste, not including sharps, or 5 or more kilograms (11 pounds) of sharps per month.

Medical Waste—that portion of potentially infectious biomedical waste that is generated from the operation of medical programs, offices and facilities.

Packaging—containing of potentially infectious biomedical waste in disposable or reusable containers in such a manner as to prevent exposure to the waste material.

Potentially Infectious Biomedical Waste—includes medical waste, infectious waste as defined herein, and as may be defined in other Louisiana law or code, and waste considered likely to be infectious by virtue of what it is or how it may have been generated in the context of health care or health care like activities. It includes, but is not limited to the following:

- a. cultures and stocks of infectious agents and associated biologicals, including cultures from medical and pathological laboratories, from research and industrial laboratories;
- b. human pathological wastes including tissue, organs, body parts and fluids that are removed during surgery or autopsy;
- c. human blood, human blood products, blood collection bags, tubes and vials;
- d. sharps used or generated in health care or laboratory settings;
- e. bandages, diapers, "blue pads," and other disposable materials if they have covered infected wounds or have been contaminated by patients isolated to protect others from the spread of infectious diseases;
- f. any other refuse which has been mingled with potentially infectious biomedical waste.

NOTE: For purposes of these regulations, eating utensils are excluded from the definition of potentially infectious biomedical waste.

NOTE: Also excluded are animal carcasses and bedding as regulated under §§107.A-109.D of this Part, and very small quantities of uninfected human and animal surgical waste as specified in §303.E.

NOTE: Once treated in accordance with the provisions of §1101 of these regulations, the waste shall be deemed not to be potentially infectious, and may be handled and treated in accordance with those regulations governing the management of other municipal and industrial waste.

Sharps—are needles, syringes, scalpels, scalpel blades, pipettes and other medical instruments capable of puncturing or lacerating skin. This definition also includes glass fragments and other health care and laboratory waste capable of puncturing or lacerating skin.

Small Health Care and Medical Facility Generator—a health facility generating less than 25 kilograms (55 pounds) of Potentially Infectious Biomedical waste, not including sharps, or less than 5 kilograms (11 pounds) of sharps per month.

Small Quantity of Potentially Infectious Biomedical Waste—a single package containing less than 5 kilograms (11 pounds) of potentially infectious biomedical waste not including sharps, or less than 1 kilogram (2.2 pounds) of sharps.

Storage—the containment of potentially infectious biomedical waste until treated or transported from the premises of a generator or treatment facility while the material is still potentially infectious.

Transport—the movement of potentially infectious biomedical waste from the premises of a generator or others involved over more than 0.1 mile of public streets or roadways to places for storage, treatment or disposal.

Transporter—any person or firm who transports large quantities of potentially infectious biomedical waste or who transports any quantity of such waste generated by another. This definition shall not apply to municipal waste haulers who transport such waste disposed of in household waste under the provisions of §503.A.

Treatment (in the case of potentially infectious biomedical wastes other than human bodies; gross anatomical parts such as limbs, torsos and heads; fetal remains; and sharps)—any method, technique, or process designed to change the character or composition of any potentially infectious biomedical waste so as to render the waste non-infectious. Treatment of human bodies, anatomical parts and fetal remains shall be by cremation, burial, or other means specifically authorized by law or regulation. Sharps shall be treated by incineration, encapsulation, or other means by which they are rendered unrecognizable as potentially infectious biomedical waste or otherwise unusable.

AUTHORITY NOTE: Promulgated in accordance with the provisions of R.S. 40:4(A)(2)(b) and R.S. 40:5.

HISTORICAL NOTE: Promulgated by the Department of Health and Hospitals, Office of Public Health, LR 28:1450 (June 2002), amended LR 35:1238 (July 2009).

§303. Requirements for Large Health Care and Medical Facility Generators of Potentially Infectious Biomedical Waste [formerly paragraph 27:021]

A. [Formerly paragraph 27:021-1] If potentially infectious biomedical waste is not segregated from other wastes at the point of origin, all wastes commingled with the potentially infectious biomedical waste must be managed as potentially infectious biomedical waste.

B. [Formerly paragraph 27:021-2] Potentially infectious biomedical waste must be packaged as defined in §301.A. Liquid wastes require sturdy, leak resistant containment. For sharps, this is to be a break resistant, rigid, puncture resistant container, the openings of which must be tightly closed prior to storage or transport. Plastic bags and other containers used for potentially infectious biomedical waste must be clearly labeled, impervious to moisture and have a strength sufficient to preclude ripping, tearing, or bursting under normal conditions of usage. Such containers must be securely closed so as to prevent leakage or other loss of contents during storage and transport. Potentially infectious biomedical wastes to be stored outside prior to treatment require a second level of containment. The outer containers must be constructed of such material and in such a manner as to be strong, watertight, not easily corroded, and rodent and insect-proof.

C. [Formerly paragraph 27:021-3] Liquid or liquefied potentially infectious biomedical waste may be directly disposed into a sewage system meeting the requirements of Part XIII.

D. [Formerly paragraph 27:021-4] Animal cadavers, and tissue and waste from large animals (e.g., livestock and horses) that are potentially infectious to human hosts may be disposed of in accordance with Livestock Sanitary Board Regulations, or treated and disposed as potentially infectious biomedical waste. Cadavers, tissues and waste from companion animals (e.g., cats and dogs) that are potentially infectious to human hosts may be buried, rendered, incinerated or otherwise appropriately treated in accordance with these regulations by, or on the order of, a licensed veterinarian involved with the case.

E. [Formerly paragraph 27:021-5] Very small quantities of human or animal tissue, reasonably estimated as less than 250 grams (about half a pound) and associated surgical dressings and non-sharp surgical wastes from clean surgical procedures from persons or animals not known or suspected to be infected with a disease communicable to humans, need not be disinfected prior to disposal, but must be disposed of in tightly closed plastic bags or other impervious containers.

F. [Formerly paragraph 27:021-6] Sharps shall be packaged as defined in §301.B. Every sharps container shall be labeled as defined in §301.A and as specified in §303.G. The contents of the container will be treated as specified in §1101 prior to disposal.

G. [Formerly paragraph 27:021-7] All bags and other containers of potentially infectious biomedical waste shall be labeled as defined in §301.A and as follows.

1. Each package shall be prominently identified as "Potentially Infectious Biomedical Waste," "Medical Waste," or "Infectious Waste," with or without the universal biohazard symbol.

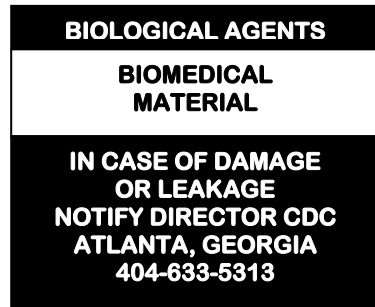

2. Untreated, potentially infectious biomedical waste that leaves the premises of the generator must bear the name and address of the generator or transporter. If not labeled as to generator, the transporter must maintain a tracking system that can identify the generator of every package of potentially infectious biomedical waste.

3. Treated, but still recognizable potentially infectious biomedical waste shall carry a supplemental label or marking to specify the treatment method used and the name or initials of the person responsible for assurance of treatment.

H. [Formerly paragraph 27:021-8] Storage of potentially infectious biomedical waste shall be in a secure manner and location which affords protection from theft, vandalism, inadvertent human and animal exposure, rain and wind. It shall be managed so as not to provide a breeding place or food for insects or rodents, and not generate noxious odors.

AUTHORITY NOTE: Promulgated in accordance with the provisions of R.S. 40:4(A)(2)(b) and R.S. 40:5.

HISTORICAL NOTE: Promulgated by the Department of Health and Hospitals, Office of Public Health, LR 28:1451 (June 2002).

§305. Transportation of Potentially Infectious Biomedical Waste
[formerly paragraph 27:021-9]

A. Transportation of potentially infectious biomedical waste shall be as follows.

1. A generator who transports large quantities of untreated or treated but still recognizable potentially infectious biomedical waste off site must register as a transporter and meet all the requirements specified in §701 of these regulations.

2. Generators shall transfer custody of potentially infectious biomedical waste only to transporters who are registered with the state health officer for this purpose as set forth in §701.

AUTHORITY NOTE: Promulgated in accordance with the provisions of R.S. 40:4(A)(2)(b) and R.S. 40:5.

HISTORICAL NOTE: Promulgated by the Department of Health and Hospitals, Office of Public Health, LR 28:1452 (June 2002).

§307. Disposal of Potentially Infectious Biomedical Wastes
[formerly paragraph 27:021-10]

A. Disposal of potentially infectious biomedical wastes shall be in accordance with the provisions of §1301.

AUTHORITY NOTE: Promulgated in accordance with the provisions of R.S. 40:4(A)(2)(b) and R.S. 40:5.

HISTORICAL NOTE: Promulgated by the Department of Health and Hospitals, Office of Public Health, LR 28:1452 (June 2002).

§309. Contingency Plans
[formerly paragraph 27:021-11]

A. Generators who normally depend upon on site incineration or other on site treatment and destruction of potentially infectious biomedical waste shall prepare and annually update written contingency plans for management of such waste when the incinerator or other means of on site destruction becomes inoperative for any reason. Such contingency plans shall be developed for periods of one day, seven to 29 days, and more than 30 days.

AUTHORITY NOTE: Promulgated in accordance with the provisions of R.S. 40:4(A)(2)(b) and R.S. 40:5.

HISTORICAL NOTE: Promulgated by the Department of Health and Hospitals, Office of Public Health, LR 28:1452 (June 2002).

Chapter 5. Requirements for Small Health Care and Medical Facilities, Household and Other Small Quantity Generators of Potentially Infectious Medical Waste
[formerly paragraph 27:022]

§501. General Provisions
[formerly paragraph 27:022-1]

A. A physician, dentist, veterinarian or nurse or, in the case of households, patient or family member, is authorized to transport small quantities of properly packaged sharps and other potentially infectious biomedical waste, generated as a result of professional or self administered health care services, from the place of original generation of the waste to an approved large quantity generator, permitted storage facility, or permitted treatment facility without having to meet the requirements of §§701 or 1101 of these regulations.

B. [Formerly paragraph 27:022-2] Small quantity generators shall package, label and store potentially infectious biomedical wastes as defined and specified in §303 of these regulations.

C. [Formerly paragraph 27:022-3] Small quantity generators may handle liquid, animal and very small quantity wastes as specified in §303.C, D, and E.

AUTHORITY NOTE: Promulgated in accordance with the provisions of R.S. 40:4(A)(2)(b) and R.S. 40:5.

HISTORICAL NOTE: Promulgated by the Department of Health and Hospitals, Office of Public Health, LR 28:1452 (June 2002), amended LR 35:1238 (July 2009).

§503. Home-Generated Sharps

A. [Formerly §501.D] Small quantities of potentially infectious biomedical waste generated as a result of self administered or non professional health care or veterinary care services in a household or other non health care facility may be disposed of in ordinary municipal waste without treatment, provided that such waste is packaged to assure no loss of contents, should the integrity of the original package be violated. This shall generally be interpreted to mean placing the original plastic bag or rigid disposal into a second bag or rigid disposal container. Sharps must be encased as specified in §1101 or placed in a sharps disposal container of standard manufacture or other similar container of a type approved by the state health officer. This sharps container should then be placed within another bag or rigid container containing a greater volume of non infectious waste.

B. On an annual basis, all persons who collect and transport public municipal household waste shall provide a copy of the Department of Health and Hospitals—Office of Public Health's (DHH-OPH) educational brochure to its clients to include the current DHH-OPH procedures for the proper handling, packaging, treatment and disposal of home generated sharps and medical wastes. Persons who collect municipal household waste shall direct clients to their own name and contact numbers on the brochure for client questions.

C. No later than January 31 of each year, persons who collect and transport municipal household wastes shall provide written certification to DHH-OPH that it has complied with Subsection B of this Section for the previous calendar year. A copy of the brochure and any additional information provided to each household in this effort shall accompany the certification.

AUTHORITY NOTE: Promulgated in accordance with R.S. 40:4(A)(2)(b) and R.S. 40:5.

HISTORICAL NOTE: Promulgated by the Department of Health and Hospitals, Office of Public Health, LR 35:1238 (July 2009).

Chapter 7. Transportation

§701. Requirements for Transporters of Potentially Infectious Biomedical Waste [formerly paragraph 27:023]

A. [Formerly paragraph 27:023-1] This Section shall apply to all transportation of potentially infectious biomedical waste within, into, out of or through the state of Louisiana.

B. [Formerly paragraph 27:023-2] A generator that transports large quantities of untreated, or treated but still recognizable potentially infectious biomedical waste must secure a permit as required in this Section.

C. [Formerly paragraph 27:023-3] Arrangements between a generator and transporter for the transport of potentially infectious biomedical waste must be in the form of written contract which specifies that both parties fully understand and are fully committed to compliance with the provision of these regulations.

D. [Formerly paragraph 27:023-4] Potentially infectious biomedical waste to be transported from the point of generation to an off-site treatment or disposal facility must meet the packaging and labeling requirements specified in §303.

E. [Formerly paragraph 27:023-5] The transporter shall deliver potentially infectious biomedical waste only to facilities that are permitted to transfer, store, treat or otherwise receive such wastes in accordance with these regulations. In the event that potentially infectious biomedical waste is transported out of state, the transporter shall deliver such waste to a facility demonstrating full compliance with all pertinent federal, state and local laws, rules and regulations.

F. [Formerly paragraph 27:023-6] Vehicles used by transporters shall meet the following minimum requirements.

1. The vehicle must have a fully enclosed cargo carrying body or compartment which is an integral part of the vehicle or firmly attached thereto and which affords protection from theft, vandalism, inadvertent human and animal exposure, rain, rodents and insects. The cargo body or compartment shall be separated by a solid barrier from the driver and passengers.

2. Provision shall be made for the containment within the body or compartment of any liquid which might leak from the packaged waste.

3. The cargo body or compartment shall be maintained in good sanitary condition and must be secured if left unattended.

4. The cargo body or vehicle containing the cargo compartment shall be identified on both sides with the name of the transporter and on both sides and the rear with the words "Medical Waste," "Infectious Waste," "Regulated Medical Waste," or "Potentially Infectious Biomedical Waste" in letters at least three inches high on contrasting background. In addition, a current permit decal issued by the Department of Health and Hospitals shall be affixed to the lower front section of the left side of the cargo body or to the driver's side door of the vehicle.

G. [Formerly paragraph 27:023-7] Any person transporting potentially infectious biomedical waste for a generator other than himself shall secure a permit from the state health officer or his duly authorized representative by submitting each of the following.

1. [Formerly paragraph 27:023-7(1)] A completed and signed permit application form provided by the Louisiana Department of Health and Hospitals. The forms shall contain the following:

a. a statement certifying that the permittee understands and will comply with the applicable requirements of this Part;

b. a list of all vehicles and containers to be used by the permittee for transporting potentially infectious medical waste; and

c. a copy of a certificate of insurance;

d. a commitment that insurance coverage will be fully maintained for the duration of the permit.

2. [Formerly paragraph 27:023-7(2)] An operation plan for the handling and transport of potentially infectious biomedical waste. the operation plan shall include the following, each of which shall be subject to approval by the state health officer or his designee:

a. the method(s) to be used for handling potentially infectious biomedical waste separately from other waste which prevents unauthorized persons from having access to or contact with the waste;

b. the method(s) to be used for labeling each package of potentially infectious biomedical Waste, and, if needed, the method(s) for tracking such waste, if the name, address and phone number of the generator is not to appear on the outer package, as specified in §303.G.2 of these regulations;

c. the method(s) to be used for loading and unloading of such wastes which limits the number of persons handling the wastes and minimizes the possibility of exposure of employees and the public to potentially infectious biomedical waste;

d. the method(s) to be used for decontaminating emptied reusable potentially infectious biomedical waste containers, transport vehicles and facility equipment which are known or believed to have been contaminated with potentially infectious biomedical waste;

e. the provision and required use of clean protective gloves and uniforms for persons manually loading or unloading containers of potentially infectious biomedical waste on or from transport vehicles. Soiled protective gear shall be laundered or otherwise properly treated;

f. the management of any person having had bodily contact with potentially infectious biomedical waste;

g. except as specified in §501, and single small quantity packages of potentially infectious biomedical waste, compactor vehicles shall not be used for the transport of potentially infectious biomedical waste.

AUTHORITY NOTE: Promulgated in accordance with the provisions of R.S. 40:4(A)(2)(b) and R.S. 40:5.

HISTORICAL NOTE: Promulgated by the Department of Health and Hospitals, Office of Public Health, LR 28:1453 (June 2002).

Chapter 9. Storage

§901. Storage of Potentially Infectious Biomedical Waste [formerly paragraph 27:024]

A. [Formerly paragraph 24:024-1] Storage of potentially infectious biomedical waste shall be in a secure manner and location which affords protection from theft, vandalism, inadvertent human and animal exposure, rain and wind. It shall be managed so as not to provide a breeding place or food for insects or rodents, and not generate noxious odors.

B. [Formerly paragraph 24:024-2] Compactors shall not be used for the storage of potentially infectious biomedical waste.

AUTHORITY NOTE: Promulgated in accordance with the provisions of R.S. 40:4(A)(2)(b) and R.S. 40:5.

HISTORICAL NOTE: Promulgated by the Department of Health and Hospitals, Office of Public Health, LR 28:1454 (June 2002).

Chapter 11. Treatment

§1101. Treatment of Potentially Infectious Biomedical Waste [formerly paragraph 27:025]

A. Treatment shall be by one of the following.

1. [Formerly paragraph 27:025-1] *Incineration*-to consume waste by burning under conditions in conformance with the standards prescribed by the Louisiana Department of Environmental Quality and other laws, rule and regulations as may apply.

2. [Formerly paragraph 27:025-2] *Steam Sterilization*-autoclaving at a temperature of at least 120°C., (248°F.), and a pressure of at least 15 pounds per square inch for at least 30 minutes. Longer times are required depending on the amount of waste, the presence of water and the type of container used. Alternate patterns of temperature, pressure and time may be used if compatible with the sterilization equipment being used and demonstrably sufficient to kill disease causing microorganisms.

3. [Formerly paragraph 27:025-3] Disposal as a liquid, with or without other treatment, into a sewage treatment system meeting the requirements of Part XIII of this Code.

4. [Formerly paragraph 27:025-4] *Thermal Inactivation*-dry heat of at least 160°C., (320°F.), at atmospheric pressure for at least two hours. This relates to time of exposure after attaining the specific temperature and does not include lag time.

5. [Formerly paragraph 27:025-5] *Chemical Disinfection*-the use of a chemical agent only in accordance with the written approval of the state health officer, except for hypochlorite bleach, diluted with water to no less than 5,000 ppm of chlorine (generally 1 part liquid household bleach, 9 parts water). If chemically disinfected wastes are to be disposed into a sewage treatment system, the written

permission of the operating authority of the sewage treatment system must be secured.

6. [Formerly paragraph 27:025-6] *Irradiation Sterilization*-the use of gamma rays, X-rays, or other forms of radiation to treat potentially infectious biomedical waste may be used only with the written approval of the state health officer.

7. [Formerly paragraph 27:025-7] Treatment and disposition of human bodies, gross anatomical parts and fetal remains shall be by burial, cremation, or other means specifically authorized in law or regulation. Extracted human teeth may be disposed of by these means, or as sharps.

8. [Formerly paragraph 27:025-8] Treatment and disposition of sharps shall be by incineration, encasement in plaster within a tightly closed container, encasement in other substances within a tightly closed container, as approved by the state health officer or by other treatment that renders them unrecognizable as medical sharps, and, for all practical purposes, precludes the release of recognizable needles and syringes if compacted. Small health care and medical facility generators, as defined in §301 of these regulations may dispose of sharps by encasement, as described above, without prior sterilization, inactivation or disinfection. Large health care and medical facility generators, as defined in §301 of these regulations may apply to the state health officer for authority to dispose of sharps by encasement without prior sterilization, inactivation or disinfection.

AUTHORITY NOTE: Promulgated in accordance with the provisions of R.S. 40:4(A)(2)(b) and R.S. 40:5.

HISTORICAL NOTE: Promulgated by the Department of Health and Hospitals, Office of Public Health, LR 28:1454 (June 2002).

Chapter 13. Disposal

§1301. Disposal of Potentially Infectious Biomedical Waste [formerly paragraph 27:026]

A. [Formerly paragraph 27:026-1] Once treated, as specified in §1101, potentially infectious biomedical waste may be disposed as non-infectious waste in a permitted sanitary landfill in accordance with the Solid Waste Regulations of the Department of Environmental Quality.

B. [Formerly paragraph 27:026-2] Treated, but still recognizable potentially infectious biomedical waste shall carry a supplemental label or marking to specify the treatment method used, date and name or initials of the person responsible for assurance of treatment.

AUTHORITY NOTE: Promulgated in accordance with the provisions of R.S. 40:4(A)(2)(b) and R.S. 40:5.

HISTORICAL NOTE: Promulgated by the Department of Health and Hospitals, Office of Public Health, LR 28:1454 (June 2002).

Chapter 15. Treatment Facilities

§1501. General Provisions [formerly paragraph 27:027]

A. [Formerly paragraph 27:027-1] A generator may store its own potentially infectious biomedical wastes without a separate permit as otherwise required in this Section, but must fully comply with all other provisions of this Section.

B. [Formerly paragraph 27:027-2] Any generator operating its own incinerator or any other person operating a storage or treatment facility shall secure a permit from the state health officer by submitting each of the following.

1. A completed and signed permit application form provided by the state health officer. The forms shall contain the following:

a. a statement certifying that the permittee understands and will comply with the applicable requirements of this Chapter; and

b. proof of all appropriate permits as required by the Louisiana Department of Environmental Quality and other state and federal agencies;

c. written arrangements between the storage and treatment facility and transporters which specify that both parties fully understand and are fully committed to compliance with the provisions of these regulations.

2. An operation plan for the management of potentially infectious biomedical waste. The operation plan shall include the following:

a. methods of receiving wastes, unloading, storing and processing them, which ensure that all requirements specified in §§303.A, 303.H, 901, 1101, and 1301 are fully addressed;

b. a proposed method of decontaminating emptied reusable potentially infectious biomedical waste containers, transport vehicles and facility equipment which are known or believed to have been contaminated with potentially infectious biomedical waste;

c. the provision and required use of protective gloves and uniforms to protect employees against exposure to potentially infectious biomedical waste. Soiled protective gear shall be laundered or otherwise appropriately treated;

d. the management of any person having had bodily contact with potentially infectious biomedical waste.

C. Section 1501 shall not apply to municipal and other sewage treatment facilities permitted in accordance with Part XIII.

AUTHORITY NOTE: Promulgated in accordance with the provisions of R.S. 40:4(A)(2)(b) and R.S. 40:5.

HISTORICAL NOTE: Promulgated by the Department of Health and Hospitals, Office of Public Health, LR 28:1454 (June 2002).

Chapter 17. Enforcement
[formerly paragraph 27:028]

§1701. General Provisions

A. The Office of Public Health shall enforce the provisions of this Part in accordance with the provisions of the state sanitary code.

B. [Formerly paragraph 27:029] Effective Dates

1. [Formerly paragraph 27:029-1] These regulations shall take effect July 1, 1990.

C. Notes

1. ¹Sections revised July 20, 1991;

2. [Sections 27:025-9, 27:026-3, 27:029-2 were deleted July 20, 1991].

AUTHORITY NOTE: Promulgated in accordance with the provisions of R.S. 40:4(A)(2)(b) and R.S. 40:5.

HISTORICAL NOTE: Promulgated by the Department of Health and Hospitals, Office of Public Health, LR 28:1455 (June 2002).

Title 51
PUBLIC HEALTH—SANITARY CODE
Part XXVIII. Commercial Body Art

Chapter 1. Commercial Body Art
Regulation

§101. Definitions
[formerly paragraph 28:001]

A. Unless otherwise specifically provided herein, the following words and terms used in this Part and all other Parts which are adopted or may be adopted, are defined for the purposes thereof as follows.

Antiseptic—an agent that destroys disease causing microorganisms on human skin or mucosa.

Aftercare—written instructions given to the consumer, specific to the body art procedure(s) rendered, on caring for the body art and surrounding area. These instructions will include information when to seek medical treatment, if necessary.

Body Art—the practice of physical body adornment by registered establishments and operators utilizing, but not limited to, the following techniques: tattooing, cosmetic tattooing, body piercing, branding and scarification. This definition does not include practices that are considered medical procedures by a state medical board, such as implants under the skin, and shall not be performed in a commercial body art facility. This definition does not include the piercing of the lobe of the ear using pre-sterilized single use stud and clasp ear piercing system.

Body Piercing—puncturing or penetration of the skin of a person using pre-sterilized single use needles and the insertion of pre-sterilized jewelry or other adornment thereto in the opening, except puncturing the lobe of the ear using a pre-sterilized single use stud and clasp ear piercing system shall not be included in this definition.

Branding—inducing a pattern of scar tissue development by means of a heated instrument.

Client—a consumer requesting the application of a tattoo, body piercing services or permanent cosmetic application services

Commercial Body Art Facility as defined herein and in R.S. 40:2831(1)—any location, place, area, or business, whether permanent or temporary, which provides consumers access to personal services workers who for remuneration perform any of the following procedures:

a. tattooing or the insertion of pigment under the surface of the skin of a human being, by pricking with a needle or otherwise, to produce an indelible mark or figure visible under the skin;

b. body piercing or the creation of an opening in the body of a human being for the purpose of inserting jewelry or other decoration; but does not for the purposes of this Part, include piercing an ear with a disposable, single use stud or solid needle that is applied using a mechanical device to force the needle or stud through the ear;

c. the application of permanent cosmetics or pigments under the skin of a human being for the purpose of permanently changing the color or other appearance of the skin, including but not limited to permanent eyeliner, eye shadow, or lip color.

Consumer—any individual who is provided access to a commercial body art facility which is required to be registered pursuant to the provisions of this Part.

Contaminated Waste—any liquid or semi-liquid blood or other potentially infectious materials; contaminated items that would release blood or other potentially infectious materials in a liquid or semi-liquid state if compressed; items that are caked with dried blood or other potentially infectious materials and are capable of releasing these materials during handling; sharps and any wastes containing blood and other potentially infectious materials, as defined in 29 Code of Federal Regulations Part 1910.1030 (latest edition), known as "Occupational Exposure to Bloodborne Pathogens."

Disinfection—the destruction of disease-causing microorganisms on inanimate objects or surfaces, thereby rendering these objects safe for use or handling.

Department—the Department of Health and Hospitals.

Ear Piercing—the puncturing of the lobe of the ear using a pre-sterilized single use stud and clasp ear piercing system following manufacturers instructions.

Equipment—all machinery, including fixtures, containers, vessels, tools, devices, implements, furniture, display and storage areas, sinks and all other apparatus and appurtenances used in connection with the operation of a commercial body art facility.

Hand Sink—a lavatory equipped with hot and cold running water under pressure, used solely for washing hands, arms or other portions of the body.

Invasive—entry into the body either by incision or insertion of an instrument into or through the skin or mucosa, or by any other means intended to puncture, break or compromise the skin or mucosa.

Jewelry—any personal ornament inserted into a newly pierced area, which must be made of surgical implant grade stainless steel, solid 14k or 18k white or yellow gold,

niobium, titanium or platinum, a dense, low-porosity plastic and which is free of nicks, scratches or irregular surfaces and which has been properly sterilized prior to use.

Manager—any individual designated by the owner to manage the daily business of a commercial body art facility.

Operator—any individual designated by the registrant to apply or to assist in the performance of body art procedures upon the consumer for remuneration. The term includes technicians who work under the operator and perform body art activities.

Owner—any person who operates a commercial body art facility.

Person—any natural person, partnership, corporation, association, governmental subdivision, receiver, tutor, curator, executor, administrator, fiduciary, or representative of another person, or public or private organization of any character.

Protective Gloves—gloves made of vinyl or latex.

Registrant—any person who is registered with the department as required by R.S. 40:2832.

Sanitize—to adequately treat equipment by a process that is effective in destroying vegetative cells of microorganisms of public health significance, and in substantially reducing numbers of other undesirable microorganisms without adversely affecting the equipment or its safety for the consumer.

Sharps—any object (sterile or contaminated) that may purposefully or accidentally cut or penetrate the skin or mucosa including, but not limited to, pre-sterilized, single use needles, scalpel blades and razor blades.

Sharps Container—a puncture-resistant, leak-proof container that can be closed for handling, storage, transportation and disposal and is labeled with the international "biohazard" symbol.

Single Use—products or items that are intended for one-time, one-person use and are disposed of after use on each client including, but not limited to, cotton swabs or balls, tissues or paper products, paper or plastic cups, gauze and sanitary coverings, razors, piercing needles, scalpel blades, stencils, ink cups and protective gloves.

Sterilization—a very powerful process resulting in the destruction of all forms of microbial life, including highly resistant bacterial spores.

Tattooing—any method of placing ink or other pigment into or under the skin or mucosa by the aid of needles or any other instruments used to puncture the skin, resulting in permanent coloration of the skin or mucosa. This includes all forms of cosmetic tattooing.

Temporary Commercial Body Art Facility—any place or premise operating at a fixed location where an operator performs body art procedures for no more than 14 days consecutively in conjunction with a single event or celebration.

Temporary Demonstration Registration—the registration issued by the department to a *temporary commercial body art facility*, as defined herein, as required by Chapter 3 of this Part and R.S. 40:2832 for a period of time not to exceed 14 consecutive calendar days.

Temporary Operator Registration—the registration issued by the department to an *operator*, as defined herein, to perform body art procedures at a temporary commercial body art facility approved and registered by the department.

Universal Precautions—a set of guidelines and controls, published by the Center for Disease Control (CDC) as "guidelines for prevention of transmission of human immunodeficiency virus and hepatitis B virus to health-care and public-safety workers" in Morbidity and Mortality Weekly Report (MMWR), June 23, 1989, Vol. 38, No. S-6, and as "recommendations for preventing transmission of human immunodeficiency virus and hepatitis B virus to patients during exposure-prone invasive procedures," in MMWR, July 12, 1991, Vol. 40, No. RR-8. This method of infection control requires the employer and the employee to assume that all human blood and specified human body fluids are infectious for HIV, HBV and other blood pathogens. Precautions include hand washing, gloving, personal protective equipment, injury prevention, and proper handling and disposal of needles, other sharp instruments, and blood and body fluid contaminated products.

AUTHORITY NOTE: The first source of authority for promulgation of the sanitary code is in R.S. 36:258(B), with more particular provisions found in Chapters 1 and 4 of Title 40 of the Louisiana Revised Statutes. This Part is promulgated in accordance with the specific provisions of R.S. 40:4, R.S. 40:5 and R.S. 40:2833.

HISTORICAL NOTE: Promulgated by the Department of Health and Hospitals, Office of Public Health, LR 28:1455 (June 2002).

§103. Facility Standards [formerly paragraph 28:002]

A. All commercial body art facilities shall meet the following criteria.

1. [Formerly paragraph 28:002-1] All areas shall be kept clean and in good repair.
2. [Formerly paragraph 28:002-2] All procedure surfaces, including counters, tables, equipment, chairs, or recliners, that are in treatment and sterilization areas shall be made of smooth, nonabsorbent, and nonporous materials.
3. [Formerly paragraph 28:002-3] All wall, floor, and ceiling surfaces within each procedure area shall be smooth, free of open holes or cracks, light colored, washable and in good repair. Walls, floors and ceilings shall be maintained in a clean condition.
4. [Formerly paragraph 28:002-4] Surfaces or blood spills shall be cleaned using an EPA registered, hospital-grade disinfectant
5. [Formerly paragraph 28:002-5] Each facility shall provide a hand washing sink to be used solely for hand washing in body art procedure area for the exclusive use of

the operator. A separate restricted area away from public access shall be provided in each facility for the purpose of handling contaminated equipment, instruments and sterilization operations. Also, a separate instrument sink shall be provided for the sole purpose of cleaning instruments and equipment prior to sterilization in addition to the sink that is located in the restrooms. These sinks shall be provided with hot (120 degrees Fahrenheit minimum) and cold running water under pressure dispensed from a mixing valve. There shall also be available at all sinks and lavatories, powdered or liquid soap in a soap dispenser, disposable single use towels or automatic hand drying device, and a refuse container.

6. [Formerly paragraph 28:002-6] Toilet facilities shall be kept clean and in good repair and in working order at all times. If only one restroom is provided, it must contain a water closet and a hand washing sink equipped with a powdered or liquid soap dispenser and disposable single use towels or automatic hand drying device, as must all restrooms.

7. [Formerly paragraph 28:002-7] The facility shall be provided with adequate and sufficient artificial or natural lighting equivalent to at least 20 foot-candles 3 feet off the floor, except that at least 100 foot-candles shall be provided at the level where the body art procedure is being performed, and where instruments and sharps are assembled.

8. [Formerly paragraph 28:002-8] The facility shall be well ventilated with natural or mechanical methods that remove or exhaust fumes, vapors, or dust in order to prevent hazardous conditions from occurring or to allow the free flow of air in a room in proportion to the size of the room and the capacity of the room.

9. [Formerly paragraph 28:002-9] If a room used for any business purposes other than body art procedures is the same room or is adjacent to a room used for body art procedures, then the department may require that one or more of the following requirements be satisfied if there are conditions that the department considers a possible threat to the health of the employees, the customers, or the public.

a. A solid partition shall separate the premises used for other business purposes from the commercial body art area. The partition may contain a door, provided it remains closed except for entering and leaving.

b. A separate outside entrance shall be provided for the facility.

10. [Formerly paragraph 28:002-10] Pets or other animals shall not be permitted in the commercial body art facility. This prohibition shall not apply to trained guide animals for the disabled, sightless, or hearing impaired; or fish in aquariums.

AUTHORITY NOTE: Promulgated in accordance with the provisions of R.S. 40:4, R.S. 40:5, and 40:2833.

HISTORICAL NOTE: Promulgated by the Department of Health and Hospitals, Office of Public Health, LR 28:1457 (June 2002).

§105. Required Equipment [formerly paragraph 28:003]

A. Articles and Materials. Commercial body art facility registrants and operators shall provide and maintain the following tattooing and/or piercing equipment and supplies at the place of business:

1. [Formerly paragraph 28:003-1] tattoo machine or hand pieces, of non porous material which can be sanitized;

2. [Formerly paragraph 28:003-2] stainless steel or carbon needles and needle bars;

3. [Formerly paragraph 28:003-3] stainless steel, brass or lexan tubes that can be sanitized;

4. [Formerly paragraph 28:003-4] stencils, plastic acetate or single use disposable carbon paper;

5. [Formerly paragraph 28:003-5] sterilization bags with color strip indicator;

6. [Formerly paragraph 28:003-6] disposable protective gloves;

7. [Formerly paragraph 28:003-7] single use or disposable razors, tongue depressors, lubricants or medicines;

8. [Formerly paragraph 28:003-8] single use towels, tissues or paper products;

9. [Formerly paragraph 28:003-9] sharps container and BIOHAZARD waste bags;

10. [Formerly paragraph 28:003-10] commercially purchased inks, dyes and pigments;

11. [Formerly paragraph 28:003-11] a trash receptacle(s);

12. [Formerly paragraph 28:003-12] commercially available spore tests performed monthly;

13. [Formerly paragraph 28:003-13] single-use hollow piercing stainless steel needles;

14. [Formerly paragraph 28:003-14] approved equipment for cleaning and sterilizing instruments;

15. [Formerly paragraph 28:003-15] all tables or chairs made of nonporous material that can be cleaned and sanitized;

16. [Formerly paragraph 28:003-16] all piercing instruments shall be made of stainless steel;

17. [Formerly paragraph 28:003-17] bleach or hard-surface disinfectants, or both;

18. [Formerly paragraph 28:003-18] antibacterial hand soap; and

19. [Formerly paragraph 28:003-19] minimum of 10 pre-sterilized needle/tube packs or 10 single use needle/tube packs per artist in respect to tattooist.

AUTHORITY NOTE: Promulgated in accordance with the provisions of R.S. 40:4, R.S. 40:5, and 40:2833.

HISTORICAL NOTE: Promulgated by the Department of Health and Hospitals, Office of Public Health, LR 28:1457 (June 2002).

§107. Practice Standards; Restrictions
[formerly paragraph 28:004]

A. [Formerly paragraph 28:004-1] Prior to any body art procedure, a consent form shall be completed and signed by each client. Aftercare instructions shall be given to the client both verbally and in writing after every service. The written care instructions shall advise the client to consult the body art operator or a qualified health care professional at the first sign of abnormal inflammation/swelling or possible infection.

B. [Formerly paragraph 28:004-2] Registrants may obtain advice from physicians regarding medical information needed to safeguard consumers and body art operators.

C. [Formerly paragraph 28:004-3(a)] Registrants shall keep an individual written record of each client. That record shall include the name and address of the client; the date of each service; description of service; the color, manufacturer and lot number of each pigment used for each tattoo or permanent cosmetic procedure performed.

1. [Formerly paragraph 28:004-3(b)] The following information should be requested by the registrant or operator and recorded on the client's written record required in §107.C. In order to promote proper healing of the body art procedure performed, we ask that you disclose if you have, or have had, any of the following conditions which may affect the healing process:

- a. diabetes;
- b. history of hemophilia (bleeding);
- c. history of skin diseases, skin lesions or skin sensitivities to soap, disinfectants, etc.;
- d. history of allergies or adverse reactions to pigments, dyes or other skin sensitivities;
- e. history of epilepsy, seizures, fainting or narcolepsy;
- f. pregnancy or breast-feeding/nursing;
- g. immune disorders;
- h. scarring (keloid).

D. [Formerly paragraph 28:004-3(c)] Each commercial body art facility shall display a sign clearly visible to each client which bears the following wording.

1. "There may be risks associated with the procedures of commercial body art, which includes permanent tattoos, body piercing and permanent cosmetic application, that may adversely affect the healing process if you have, or have had, any of the following conditions:

- a. diabetes;
- b. history of hemophilia (bleeding);

c. history of skin diseases, skin lesions or skin sensitivities to soap, disinfectants, etc.;

d. history of allergies or adverse reactions to pigments, dyes or other skin sensitivities;

e. history of epilepsy, seizures, fainting or narcolepsy;

f. pregnancy or breast-feeding/nursing;

g. immune disorders;

h. scarring (keloid)."

2. The sign required in this sub-section shall be printed in upper and lower case letters which are at least 1/2 inch and 1/4 inch in height respectively.

E. [Formerly paragraph 28:004-4] For permanent cosmetic procedures, operators shall take photographs for corrective procedures before and after the procedure and retain such photographs.

F. [Formerly paragraph 28:004-5] Records shall be kept for a minimum of three years.

G. [Formerly paragraph 28:004-6] Inks, dyes, or pigments shall be purchased from a commercial supplier or manufacturer. Products banned or restricted by the Food and Drug Administration shall not be used.

H. [Formerly paragraph 28:004-7] Registrants or operators shall not perform tattooing and body piercing for any of these individuals:

1. on a person who is inebriated or appears to be incapacitated by the use of alcohol or drugs;

2. on persons who show signs of intravenous drug use;

3. on persons with sunburn or other skin diseases or disorders such as open lesions, rashes, wounds, puncture marks in areas of treatment;

4. on persons with psoriasis or eczema present in the treatment area;

5. on persons under 18 years of age without the presence, consent and proper identification of a parent, legal custodian parent or legal guardian as prescribed in R.S. 14:93.2(A) and (B). Nothing in this Section is intended to require an operator to perform any body art procedure on a person under 18 years of age with parental or guardian consent.

I. [Formerly paragraph 28:004-8] Use of a piercing gun to pierce shall be prohibited on all parts of the body, including the outer cartilage perimeter of the ear with the exception of the ear lobe.

J. [Formerly paragraph 28:004-9] Use of personal client jewelry or any apparatus or device presented by the client for use during the initial body piercing shall be sterilized prior to use. Each facility shall provide pre-sterilized jewelry, apparatus, or devices, which shall be of metallic content recognized as compatible with body piercing.

K. [Formerly paragraph 28:004-10] No person afflicted with an infectious or communicable disease that may be transmitted during the performance of body art procedures shall be permitted to work or train in a commercial body art facility.

L. [Formerly paragraph 28:004-11] No commercial body art facility shall require an operator to knowingly work upon a person suffering from any infectious or communicable disease that may be transmitted during the performance of permanent color, tattoo application, or body piercing.

M. [Formerly paragraph 28:004-12] Nothing shall prohibit a commercial body art facility operator from refusing to provide services to anyone under the age of 18.

AUTHORITY NOTE: Promulgated in accordance with the provisions of R.S. 40:4, R.S. 40:5, and 40:2833.

HISTORICAL NOTE: Promulgated by the Department of Health and Hospitals, Office of Public Health, LR 28:1458 (June 2002).

§109. Operator Training
[formerly paragraph 28:005]

A. [Formerly paragraph 28:005-1] Each commercial body art facility registrant shall establish and maintain procedures to ensure that all operators that perform commercial body art procedures receive adequate training and hold a current certificate in CPR, first aid, blood borne pathogens and disease transmission prevention.

B. [Formerly paragraph 28:005-2] Commercial Body Art Trainer means any person who provides training in the commercial body art field to students for a fee. The training facility shall be a fully accredited educational institution and the curriculum shall include training specified in §109.A.

C. [Formerly paragraph 28:005-3] Commercial body art facility registrants and owners must only hire operators who have registered with the department and have received training as required in §109.A and B.

AUTHORITY NOTE: Promulgated in accordance with the provisions of R.S. 40:4, R.S. 40:5, and 40:2833.

HISTORICAL NOTE: Promulgated by the Department of Health and Hospitals, Office of Public Health, LR 28:1459 (June 2002).

§111. Hand Washing and Protective Gloves
[formerly paragraph 28:006]

A. [Formerly paragraph 28:006-1] Prior to and immediately following administering services to a client, all registrants and operators shall thoroughly wash their hands and nails in hot, running water with soap and rinse them in clear, warm water.

B. [Formerly paragraph 28:006-2] All registrants and operators shall wear protective gloves during services. Protective gloves shall be properly disposed of immediately following service.

C. [Formerly paragraph 28:006-3] Protective gloves will be changed during a procedure if the need of additional supplies are needed.

AUTHORITY NOTE: Promulgated in accordance with the provisions of R.S. 40:4, R.S. 40:5, and 40:2833.

HISTORICAL NOTE: Promulgated by the Department of Health and Hospitals, Office of Public Health, LR 28:1459 (June 2002).

§113. Preparation and Aftercare of Treatment Area on Clients
[formerly paragraph 28:007]

A. [Formerly paragraph 28:007-1] Body art operators shall cleanse the client's skin, excluding the areas surrounding the eyes, by washing with an EPA-approved antiseptic solution applied with a clean, single-use paper product, before placing the design on the client's skin or beginning tattooing or permanent cosmetic work.

B. [Formerly paragraph 28:007-2] If the area is to be shaved, the operator shall use a single-use disposable safety razor and then rewash the client's skin.

C. [Formerly paragraph 28:007-3] Substances applied to the client's skin to transfer the design from stencil or paper shall be single use.

D. [Formerly paragraph 28:007-4] Aftercare shall be administered to each client following service, as stated in §§107.A and 131.L of this Part.

AUTHORITY NOTE: Promulgated in accordance with the provisions of R.S. 40:4, R.S. 40:5, and 40:2833.

HISTORICAL NOTE: Promulgated by the Department of Health and Hospitals, Office of Public Health, LR 28:1459 (June 2002).

§115. Cleaning Methods Prior to Sterilization
[formerly paragraph 28:008]

A. [Formerly paragraph 28:008-1] Each operator shall clean all non-electrical instruments prior to sterilizing by brushing or swabbing to remove foreign material or debris, rinsing, and then performing either of the following steps:

1. immersing them in detergent and water in an ultrasonic unit that operates at 40 to 60 hertz, followed by a thorough rinsing and wiping; or

2. submerging and soaking them in a protein-dissolving detergent or enzyme cleaner, followed by a thorough rinsing and wiping.

B. [Formerly paragraph 28:008-2] For all electrical instruments, each operator shall perform the following:

1. first remove all foreign matter; and

2. disinfect with an EPA-registered disinfectant with demonstrated bactericidal, fungicidal, and virucidal activity used according to manufacturer's instructions.

AUTHORITY NOTE: Promulgated in accordance with the provisions of R.S. 40:4, R.S. 40:5, and 40:2833.

HISTORICAL NOTE: Promulgated by the Department of Health and Hospitals, Office of Public Health, LR 28:1459 (June 2002).

§117. Instrument Sterilization Standards
[formerly paragraph 28:009]

A. [Formerly paragraph 28:009-1] Commercial body art facility operators shall place cleaned instruments used in the practice of tattooing, permanent cosmetics or piercing in sterile bags, with color strip indicators, and shall sterilize the instruments by exposure to one cycle of an approved sterilizer, in accordance with the approved sterilization modes in §119 of this Part.

B. [Formerly paragraph 28:009-2] The provisions of this Part shall not apply to electrical instruments.

AUTHORITY NOTE: Promulgated in accordance with the provisions of R.S. 40:4, R.S. 40:5, and 40:2833.

HISTORICAL NOTE: Promulgated by the Department of Health and Hospitals, Office of Public Health, LR 28:1459 (June 2002).

§119. Approved Sterilization Modes
[formerly paragraph 28:010]

A. [Formerly paragraph 28:010-1] Instruments used in the practice of commercial body art services shall be sterilized, using one of the following methods:

1. in a steam or chemical autoclave sterilizer, registered and listed with the Federal Food and Drug Administration (FDA), and used, cleaned, and maintained according to manufacturer's directions; or

2. with single-use, prepackaged, sterilized equipment obtained from reputable suppliers or manufacturers.

B. [Formerly paragraph 28:010-2] Facility registrants and operators shall sterilize all piercing instruments that have or may come in direct contact with a client's skin or be exposed to blood or body fluids. Piercing needles shall not be reused. All piercing needles shall be single use.

C. [Formerly paragraph 28:010-3] All sterilizing devices shall be tested on a monthly basis for functionality and thorough sterilization by use of the following means:

1. chemical indicators that change color, to assure sufficient temperature and proper functioning of equipment during the sterilization cycle; and

2. a biological monitoring system using commercially prepared spores, to assure that all microorganisms have been destroyed and sterilization has been achieved. This testing shall be performed on a monthly basis for tattoo and body piercing facilities.

D. [Formerly paragraph 28:010-4] Sterilization device test results shall be made available at the facility at all times for inspection by the state health officer for a minimum of three years.

AUTHORITY NOTE: Promulgated in accordance with the provisions of R.S. 40:4, R.S. 40:5, and 40:2833.

HISTORICAL NOTE: Promulgated by the Department of Health and Hospitals, Office of Public Health, LR 28:1460 (June 2002).

§121. Waste Receptacles
[formerly paragraph 28:011]

A. [Formerly paragraph 28:011-1] Following body art procedures for each client, the registrant or operator shall deposit all waste material related to treatment in a container of the type specified in §121.C of this Part.

B. [Formerly paragraph 28:011-2] Waste disposed in a reception area and restrooms shall be limited only to materials that are not used in providing body art services to clients or are practice related.

C. [Formerly paragraph 28:011-3] Waste disposal containers shall be constructed of non-absorbent and readily cleanable materials, shall have smooth surfaces and shall be kept clean and in good repair.

AUTHORITY NOTE: Promulgated in accordance with the provisions of R.S. 40:4, R.S. 40:5, and 40:2833.

HISTORICAL NOTE: Promulgated by the Department of Health and Hospitals, Office of Public Health, LR 28:1460 (June 2002).

§123. Linens
[formerly paragraph 28:012]

A. [Formerly paragraph 28:012-1] Each registrant or operator shall use clean reusable linens or disposable linens for each client.

B. [Formerly paragraph 28:012-2] A common towel shall be prohibited.

C. [Formerly paragraph 28:012-3] Air blowers may be substituted for hand towels.

D. [Formerly paragraph 28:012-4] Each registrant or operator shall store clean linens, tissues, or single-use paper products in a clean, enclosed storage area until needed for immediate use.

E. [Formerly paragraph 28:012-5] Each registrant or operator shall dispose of or store used linens in a closed or covered container until laundered.

F. [Formerly paragraph 28:012-6] Each registrant or operator shall launder used linens either by a regular, commercial laundering or by a noncommercial laundering process that includes immersion in water at 160 degrees Fahrenheit for not less than 15 minutes during the washing and rinsing operations.

AUTHORITY NOTE: Promulgated in accordance with the provisions of R.S. 40:4, R.S. 40:5, and 40:2833.

HISTORICAL NOTE: Promulgated by the Department of Health and Hospitals, Office of Public Health, LR 28:1460 (June 2002).

§125. Clean Instruments and Products Storage
[formerly paragraph 28:013]

A. [Formerly paragraph 28:013-1] Before use, disposable products that come in contact with the areas to be treated shall be stored in clean containers that can be closed between treatments.

B. [Formerly paragraph 28:013-2] Clean, sterilized reusable instruments that come in contact with the areas to be treated shall be packed in self-sealing sterilization packages and stored in clean, dry covered containers.

C. [Formerly paragraph 28:013-3] Clean, sterilized reusable transfer instruments, including forceps, trays, and tweezers, shall be packed in self-sealing sterilization packages and stored in clean, dry covered containers.

AUTHORITY NOTE: Promulgated in accordance with the provisions of R.S. 40:4, R.S. 40:5, and 40:2833.

HISTORICAL NOTE: Promulgated by the Department of Health and Hospitals, Office of Public Health, LR 28:1460 (June 2002).

§127. Chemical Storage
[formerly paragraph 28:014]

A. [Formerly paragraph 28:014-1] Each registrant or operator shall store chemicals in labeled, closed containers in an enclosed storage area. All bottles containing poisonous or caustic substances shall be additionally and distinctly marked as such and shall be stored in an area not open to the public.

AUTHORITY NOTE: Promulgated in accordance with the provisions of R.S. 40:4, R.S. 40:5, and 40:2833.

HISTORICAL NOTE: Promulgated by the Department of Health and Hospitals, Office of Public Health, LR 28:1460 (June 2002).

§129. Handling Disposable Materials
[formerly paragraph 28:015]

A. [Formerly paragraph 28:015-1] All potentially infectious waste materials shall be handled, stored and disposed of in a manner specified in Part XXVII of the state sanitary code.

B. [Formerly paragraph 28:015-2] Each registrant or operator shall dispose of disposable materials coming into contact with blood, body fluids, or both, in a sealable plastic bag that is separate from sealable trash or garbage liners or in a manner that protects not only the registrant or operators and the client, but also others who may come into contact with the material, including sanitation workers. Waste materials shall be kept secured from public access. Waste dumpsters shall be kept locked.

C. [Formerly paragraph 28:015-3] Disposable, sharp objects that come in contact with blood or body fluids shall be disposed of in a sealable, rigid, puncture-proof container that is strong enough to protect the registrant or operators, clients, and others from accidental cuts or puncture wounds that could happen during the disposal process.

D. [Formerly paragraph 28:015-4] Registrants or operators shall have both sealable plastic bags or sealable rigid containers available at the facility.

E. [Formerly paragraph 28:015-5] Each registrant or operator shall follow universal precautions in all cases.

AUTHORITY NOTE: Promulgated in accordance with the provisions of R.S. 40:4, R.S. 40:5, and 40:2833.

HISTORICAL NOTE: Promulgated by the Department of Health and Hospitals, Office of Public Health, LR 28:1460 (June 2002).

§131. Tattoo and Permanent Cosmetic Procedures; Preparation and Aftercare
[formerly paragraph 28:016]

A. [Formerly paragraph 28:016-1] During preparation, performance of service, and aftercare phases all substances shall be dispensed from containers in a manner to prevent contamination of the unused portion. Use of a covered spray bottle to apply liquid to skin is acceptable and will enhance the prevention of cross-contamination. Single use tubes or containers and applicators shall be discarded following tattoo service.

B. [Formerly paragraph 28:016-2] The client's skin shall be cleansed, excluding the areas surrounding the eyes, by washing with a Food and Drug Administration (FDA) compliant antiseptic solution applied with a clean single-use paper product before placing the design on the client's skin or beginning tattooing work.

C. [Formerly paragraph 28:016-3] If the area is to be shaved, the operator shall use a single use disposable safety razor and then rewash client's skin.

D. [Formerly paragraph 28:016-4] Substances applied to client's skin to transfer design from stencil or paper shall be single use. Paper stencils and skin scribes shall be single-use and disposed of immediately following service.

E. [Formerly paragraph 28:016-5] Body pencils used during a tattoo and permanent cosmetic service shall have the tip removed, the body and tip of the pen disinfected, and the tip sharpened to remove exposed edge after use on a client and prior to use on another client.

F. [Formerly paragraph 28:016-6] The plastic or acetate stencil used to transfer the design to the client's skin shall be thoroughly cleansed and rinsed in an Environmental Protection Agency (EPA) approved high-level disinfectant according to the manufacturers instructions and then dried with a clean single-use paper product.

G. [Formerly paragraph 28:016-7] Individual portions of inks, dyes, or pigments dispensed from containers or bottles into single-use containers shall be used for each client. Any remaining unused ink, dye or pigments shall be discarded immediately following service and shall not be re-used on another client.

H. [Formerly paragraph 28:016-8] Excess ink, dye, or pigment applied to the client's skin shall be removed with clean single-use paper product.

I. [Formerly paragraph 28:016-9] Use of styptic pencils or alum solids to check any blood flow is prohibited.

J. [Formerly paragraph 28:016-10] Upon completion of tattooing, the operator shall cleanse the skin, excluding the area surrounding the eyes, with a clean, single-use paper product saturated with an EPA-approved antiseptic solution.

K. [Formerly paragraph 28:016-11] A sanitary covering shall be placed over designs and adhered to the skin with suitable medical skin tape.

L. [Formerly paragraph 28:016-12] Each operator shall provide aftercare, which shall consist of both verbal and written instructions concerning proper care of the tattooed skin. Instructions shall specify the following information:

1. care following the procedure;
2. advise clients to contact the body art operator or a qualified health care professional at the first sign of abnormal inflammation, swelling or possible infection; and
3. restrictions.

AUTHORITY NOTE: Promulgated in accordance with the provisions of R.S. 40:4, R.S. 40:5, and 40:2833.

HISTORICAL NOTE: Promulgated by the Department of Health and Hospitals, Office of Public Health, LR 28:1461 (June 2002).

§133. Body Piercing Procedures **[formerly paragraph 28:017]**

A. Body piercing operators shall be responsible for adhering to the following standards while serving clients in the commercial body art facility.

1. [Formerly paragraph 28:017-1] Each operator shall observe and follow thorough hand washing procedures with soap and water or an equivalent hand washing product before and after serving each client and as needed to prevent cross contamination or transmission of body fluids, infections or exposure to service-related wastes or chemicals.

2. [Formerly paragraph 28:017-2] Each operator shall cleanse the client's skin, excluding the areas surrounding the eyes, by washing it with an FDA registered antiseptic solution applied with a clean, single-use paper product before and after piercing the client's skin.

3. [Formerly paragraph 28:017-3] All substances shall be dispensed from containers in a manner to prevent contamination of the unused portion. Single use swabs, applicators, lubricants, cups, skin scribes or marking instruments shall be discarded following the piercing service.

4. [Formerly paragraph 28:017-4] Any type of marking pen used by the operator shall be applied on cleansed skin only or shall be a surgical marking pen sanitized by design, including alcohol-based ink pens. The operator shall remove the tip of each body pencil used during a piercing, shall disinfect the body and the tip of the pencil, and shall sharpen the tip to remove the exposed edge prior to disinfection.

5. [Formerly paragraph 28:017-5] Use of styptic pencils or alum solids to control blood flow shall be prohibited.

6. [Formerly paragraph 28:017-6] Aftercare shall be administered to each client following service. Aftercare shall consist of both verbal and written instructions concerning proper care of the pierced area. Instructions shall specify the following information:

- a. care following service;
- b. advise clients to contact the body art operator or a qualified health care professional at the first sign of abnormal inflammation, swelling or possible infection; and
- c. restrictions.

7. [Formerly paragraph 28:017-7] Operators who have open sores or bleeding lesions on their hands shall not have client contact until the lesions have healed to the scab phase. Each operator shall cover them with protective gloves or impervious bandages prior to contact with clients.

8. [Formerly paragraph 28:017-8] Operators shall wear eye goggles, shields, or masks if spattering is likely to occur while providing services.

AUTHORITY NOTE: Promulgated in accordance with the provisions of R.S. 40:4, R.S. 40:5, and 40:2833.

HISTORICAL NOTE: Promulgated by the Department of Health and Hospitals, Office of Public Health, LR 28:1461 (June 2002).

Chapter 3. Registration **[formerly paragraph 28:018]**

§301. Procedures **[formerly paragraph 28:018-1]**

A. Each person owning or operating a commercial body art facility or facilities within the state of Louisiana on January 1, 2000 shall register each facility with the department no later than March 1, 2000.

B. [Formerly paragraph 28:018-2] Each person acquiring or establishing a commercial body art facility within the state of Louisiana after January 1, 2000, shall register the facility with the department prior to beginning operation of such a facility.

C. [Formerly paragraph 28:018-3] No person shall operate a commercial body art facility without first having registered that facility as provided by §301.A and B of this Section. The application for registration of commercial body art facilities shall be submitted on forms provided by the department and shall contain all the information required by such forms and any accompanying instructions.

D. [Formerly paragraph 28:018-4] Each person managing a commercial body art facility and each person acting as an operator as defined in §101 of this Part on January 1, 2000, shall register with the department no later than March 1, 2000.

E. [Formerly paragraph 28:018-5] Each person who begins to act as a manager or operator in a commercial body art facility after January 1, 2000, shall register the facility as required in this Part prior to beginning operation of such a facility.

F. [Formerly paragraph 28:018-6] No person shall act as a manager or operator in a commercial body art facility without having first registered as provided in §301.D and E of this Section. The applications for registration shall be submitted on forms provided by the department and shall contain all of the information required by such forms and any accompanying instructions.

G. [Formerly paragraph 28:018-7] Any person or facility approved by the department for training commercial body art operators pursuant to R.S. 37:2743(A)(4) shall register with the department upon approval. The applications for registration shall be submitted on forms provided by the department and shall contain all of the information required by such forms and any accompanying instructions.

H. [Formerly paragraph 28:018-8] As part of the application for registration process, owners of commercial body art facilities shall submit a scale drawing and floor plan of the proposed establishment to the department for a review. This shall apply to new construction and to renovation of any existing property.

AUTHORITY NOTE: Promulgated in accordance with the provisions of R.S. 40:4, R.S. 40:5, and 40:2833.

HISTORICAL NOTE: Promulgated by the Department of Health and Hospitals, Office of Public Health, LR 28:1462 (June 2002).

§303. Registration Application Form [formerly paragraph 28:019]

A. [Formerly paragraph 28:019-1] The department shall require at least the following information for registration:

1. name, physical address, mailing address and telephone number and normal business hours of each commercial body art facility;

2. name, residence address, mailing address and telephone number of the owner of each commercial body art facility;

3. for each manager or operator: name, residence address, mailing address, telephone number, place(s) of employment as a manger or operator, training and/or experience, proof of attendance of an approved operator training course as specified in §109 of this Part;

4. name, mailing address, telephone number and owner, manager or contact person for each operator training facility.

AUTHORITY NOTE: Promulgated in accordance with the provisions of R.S. 40:4, R.S. 40:5, and 40:2833.

HISTORICAL NOTE: Promulgated by the Department of Health and Hospitals, Office of Public Health, LR 28:1462 (June 2002).

§305. Registration Fees [formerly paragraph 28:020]

A. [Formerly paragraph 28:020-1] The following fees shall accompany each application for initial registration.

Registrant	Fee
Owner of Facility	\$1,000
Manager of Facility	\$ 200
Operator	\$ 100
Training Facility or Person	\$3,000

1. Make check or money orders payable to the Department of Health and Hospitals.

AUTHORITY NOTE: Promulgated in accordance with the provisions of R.S. 40:4, R.S. 40:5, and 40:2833.

HISTORICAL NOTE: Promulgated by the Department of Health and Hospitals, Office of Public Health, LR 28:1462 (June 2002).

§307. Issuance of Certificate of Registration [formerly paragraph 28:021]

A. [Formerly paragraph 28:021-1] A certificate of registration shall be issued upon receipt of an application and the required registration fee provided that no certificate of registration will be issued until an inspection has been made of the commercial body art facility and it has been found to be operating in compliance with the provisions of R.S. 40:2831-40:2834 and the provisions of this Part of the sanitary code.

B. [Formerly paragraph 28:021-2] Certificates of registration shall be displayed in an open public area of the commercial body art facility.

C. [Formerly paragraph 28:021-3] Certificates of registration shall expire annually on December 31.

D. [Formerly paragraph 28:021-4] Certificates of registration shall be issued only to the applicants and shall not be transferable.

AUTHORITY NOTE: Promulgated in accordance with the provisions of R.S. 40:4, R.S. 40:5, and 40:2833.

HISTORICAL NOTE: Promulgated by the Department of Health and Hospitals, Office of Public Health, LR 28:1462 (June 2002).

§309. Renewal of Certificate of Registration [formerly paragraph 28:022]

A. [Formerly paragraph 28:022-1] Each registrant shall file applications for renewal of certificate of registration annually on forms provided by the department. The renewal application shall be forwarded to the mailing address of the registrant as listed on the last application for registration submitted to the department.

B. [Formerly paragraph 28:022-2] The following fees shall accompany each application for registration renewal.

Registrant	Renewal Fee
Owner of Facility	\$ 500
Manager of Facility	\$ 150
Operator	\$ 60
Training Facility or Person	\$1,000

1. Make check or money orders payable to the Department of Health and Hospitals.

C. [Formerly paragraph 28:022-3] Provided that a registrant files a required application with the department in proper form not less than 30 days prior to the expiration date stated on the certificate of registration, the certificate shall not expire pending final action on the application by the department.

AUTHORITY NOTE: Promulgated in accordance with the provisions of R.S. 40:4, R.S. 40:5, and 40:2833.

HISTORICAL NOTE: Promulgated by the Department of Health and Hospitals, Office of Public Health, LR 28:1463 (June 2002).

§311. Temporary Commercial Body Art Facility/Operator Registration
[formerly paragraph 28:023]

A. [Formerly paragraph 28:023-1] Temporary commercial body art facilities and, when required, operator registrations may be issued for body art services provided outside of the physical site of a registered permanent facility for the purposes of product demonstration, industry trade shows or for educational reasons.

B. [Formerly paragraph 28:023-2] Temporary commercial body art facility and/or operator registrations will not be issued unless:

1. the applicant furnishes proof of compliance with Chapter 3 of this Part relating to operator's registration;
2. the applicant is currently affiliated with a permanent fixed location or permanent facility which, is registered by the department;
3. applicants who reside outside of Louisiana must demonstrate to the department that they hold a valid registration or license to operate a commercial body art facility at a permanent fixed location issued by the state or local regulatory authority within their respective state;
4. the temporary site complies with §315 of this Part.

C. [Formerly paragraph 28:023-3] In lieu of attendance at a bloodborne pathogens training program approved by the department within the past year as specified in §109 of this Part, the applicant may furnish proof of attendance at equivalent training which is acceptable to the department.

D. [Formerly paragraph 28:023-4] Temporary registrations expire after 14 consecutive calendar days or at the conclusion of the special event, whichever is less.

E. [Formerly paragraph 28:023-5] Temporary commercial body art facility and/or operator registrations will not be issued unless the applicant has paid a reasonable fee as set by the department.

F. [Formerly paragraph 28:023-6] The temporary commercial body art facility and/or operator registration(s) shall not be transferable from one place or person to another.

G. [Formerly paragraph 28:023-7] The temporary commercial body art facility and/or operator registrations shall be posted in a prominent and conspicuous area where they may be readily seen by clients.

AUTHORITY NOTE: Promulgated in accordance with the provisions of R.S. 40:4, R.S. 40:5, and 40:2833.

HISTORICAL NOTE: Promulgated by the Department of Health and Hospitals, Office of Public Health, LR 28:1463 (June 2002).

§313. Temporary Commercial Body Art Facility/Operator Registration Requirements
[formerly paragraph 28:024]

A. [Formerly paragraph 28:024-1] A temporary registration may be issued by the department for educational, trade show or product demonstration purposes only. The registration may not exceed 14 calendar days.

B. [Formerly paragraph 28:024-2] A person who wishes to obtain a temporary demonstration registration must submit the request in writing for review by the department, at least 30 days prior to the event. The request should specify:

1. the purpose for which the registration is requested;
2. the period of time during which the registration is needed (not to exceed 14 consecutive calendar days per event), without re-application;
3. the fulfillment of operator requirements as specified in §109 of this Part;
4. the location where the temporary demonstration registration will be used.

C. [Formerly paragraph 28:024-3] The applicant's demonstration project must be contained in a completely enclosed, non-mobile facility (e.g., inside a permanent building).

D. [Formerly paragraph 28:024-4] Compliance with all of the requirements of this code, including but not limited to:

1. conveniently located hand washing facilities with liquid soap, paper towels and hot and cold water under adequate pressure shall be provided. Drainage in accordance with Part XIV and local plumbing codes is to be provided. Antiseptic single use hand wipes, approved by the department, to augment the hand washing requirements of this Section must be made readily available to each operator;
2. a minimum of 80 square feet of floor space;
3. at least 100 foot-candles of light at the level where the body art procedure is being performed:
 - a. facilities to properly sterilize instruments—evidence of spore test performed on sterilization equipment 30 days or less prior to the date of the event, must be provided; or only single use, prepackaged, sterilized equipment obtained from reputable suppliers or manufacturers will be allowed;
4. ability to properly clean and sanitize the area used for body art procedures.

E. [Formerly paragraph 28:024-5] The facility where the temporary demonstration registration is needed must be inspected by the department and a certificate of registration issued prior to any body art procedures being performed.

F. [Formerly paragraph 28:024-6] Temporary demonstration registrations issued under the provisions of §313.E of this Part may be suspended by the department for failure of the holder to comply with the requirements of this Part.

G. [Formerly paragraph 28:024-7] All temporary demonstration registrations and the disclosure notice must be readily seen by clients.

AUTHORITY NOTE: Promulgated in accordance with the provisions of R.S. 40:4, R.S. 40:5, and 40:2833.

HISTORICAL NOTE: Promulgated by the Department of Health and Hospitals, Office of Public Health, LR 28:1463 (June 2002).

§315. Report of Changes
[formerly paragraph 28:025]

A. [Formerly paragraph 28:025-1] The registrant shall notify the department in writing before making any change which would render the information contained in the application for registration inaccurate. Notification of changes shall include information required Chapter 3 of this Part.

AUTHORITY NOTE: Promulgated in accordance with the provisions of R.S. 40:4, R.S. 40:5, and 40:2833.

HISTORICAL NOTE: Promulgated by the Department of Health and Hospitals, Office of Public Health, LR 28:1464 (June 2002).

§317. Transfer of Registrations
[formerly paragraph 28:026]

A. [Formerly paragraph 28:026-1] Certificates of registration issued to commercial body art facilities, facility managers, body art operators and operator trainers shall not be transferrable.

AUTHORITY NOTE: Promulgated in accordance with the provisions of R.S. 40:4, R.S. 40:5, and 40:2833.

HISTORICAL NOTE: Promulgated by the Department of Health and Hospitals, Office of Public Health, LR 28:1464 (June 2002).

Chapter 5. Enforcement

[formerly paragraph 28:027]

§501. General Provisions
[formerly paragraph 28:027-1]

A. The Office of Public Health shall enforce the provisions of this Part in accordance with Part I of this Code.

AUTHORITY NOTE: Promulgated in accordance with the provisions of R.S. 40:4, R.S. 40:5, and 40:2833.

HISTORICAL NOTE: Promulgated by the Department of Health and Hospitals, Office of Public Health, LR 28:1464 (June 2002).

§503. Suspension or Revocation of Approval
[formerly paragraph 28:029]

A. [Formerly paragraph 28:029-1] The department may suspend or revoke the approval and registration of a commercial body art facility at any time the department determines that the business is being operated in violation of the provisions of R.S. 40:2831-2834, or the provisions of R.S. 14:93.2, which prohibits the tattooing and body piercing of minors without parental or custodial consent.

B. [Formerly paragraph 28:029-2] In addition to suspension or revocation of approval and registration by the department, if a commercial body art facility violates the provisions of R.S. 14:93.2, it shall be subject to the penalties provided therein.

C. [Formerly paragraph 28:029-3] The department may suspend or revoke the registration of a manager or operator at a commercial body art facility or the registration of a registered training facility at any time the department determines that the registrant is operating in violation of the

provisions of R.S. 40:2831-2834 or the provisions of R.S. 14:93.

D. [Formerly paragraph 28:029-4] In addition to suspension or revocation of registration by the department, a registrant who violates the provisions of R.S. 14:93.2 shall be subject to the penalties provided therein.

E. [Formerly paragraph 28:029-5] The department may suspend or revoke the approval and registration of a commercial body art facility for any of the following reasons:

1. failure to pay a registration fee or an annual registration renewal fee;
2. the applicant obtained or attempted to obtain an approval or registration by fraud or deception;
3. a violation of any of the provisions of this Part of the state sanitary code.

AUTHORITY NOTE: Promulgated in accordance with the provisions of R.S. 40:4, R.S. 40:5, and 40:2833.

HISTORICAL NOTE: Promulgated by the Department of Health and Hospitals, Office of Public Health, LR 28:1464 (June 2002).

§505. Injunctive Relief
[formerly paragraph 28:030]

A. [Formerly paragraph 28:030-1] If the department or state health officer finds that a person has violated, is violating, or threatening to violate the provisions of R.S. 40:2831-2834 or the provisions of this Part of the sanitary code and that violation or threat of violation creates an immediate threat to the health and safety of the public, the department or state health officer may petition the district court for a temporary restraining order to restrain the violation or threat of violation. If a person has violated, is violating, or threatening to violate provisions of R.S. 40:2831-2834 or the provisions of this Part of the sanitary code, the department or state health officer may, after sending notice of said alleged violation to the alleged violator via certified mail and the lapse of 10 days following receipt of the notice by the alleged violator may petition the district court for an injunction to prohibit the person from continuing the violation or threat of violation.

B. [Formerly paragraph 28:030-2] On application for injunctive relief and a finding that a person is violating or threatening to violate provisions of R.S. 40:2831-2834 or the provisions of this Part of the sanitary code, the district court may grant any injunctive relief warranted by the facts. Venue for a suit brought under provisions of this Section shall be in the parish in which the violation is alleged to have occurred.

AUTHORITY NOTE: Promulgated in accordance with the provisions of R.S. 40:4, R.S. 40:5, and 40:2833.

HISTORICAL NOTE: Promulgated by the Department of Health and Hospitals, Office of Public Health, LR 28:1464 (June 2002).

§507. Severability
[formerly paragraph 28:031]

A. See state sanitary code, Part I, §103.

AUTHORITY NOTE: Promulgated in accordance with the provisions of R.S. 40:4, R.S. 40:5, and 40:2833.

HISTORICAL NOTE: Promulgated by the Department of Health and Hospitals, Office of Public Health, LR 28:1465 (June 2002).

Chapter 7. Facility Inspections [formerly paragraph 28:028]

§701. General Provisions [formerly paragraph 28:028-1]

A. The department shall conduct at least one inspection of a commercial body art facility prior to approving the business to offer body art application services under provisions of this Part and R.S. 40:2831-2834. The department may conduct additional inspections as necessary

for the approval process, and may inspect a registered commercial body art facility at any time the department considers necessary.

B. [Formerly paragraph 28:028-2] In an inspection, the department shall be given access to the business' premises and to all records relevant to the inspection.

AUTHORITY NOTE: Promulgated in accordance with the provisions of R.S. 40:4, R.S. 40:5, and 40:2833.

HISTORICAL NOTE: Promulgated by the Department of Health and Hospitals, Office of Public Health, LR 28:1465 (June 2002).

Title 51
PUBLIC HEALTH—SANITARY CODE
Part XXIX. Medical Marijuana

Chapter 1. General Requirements

§101. Definitions

A. Except as may be otherwise defined in any provision of this Part, and unless the context or use thereof clearly indicates otherwise, the following words and terms used in this Part of the *Sanitary Code* are defined for the purposes thereof, and for purposes of any other Parts which are adopted or may hereafter be adopted, as follows:

Immature Plant—nonflowering medical marijuana (as defined below) plant that is no taller than eight inches produced from a cutting, clipping or seedling.

Licensee—as defined in La. R.S. 40:1046(H)(2)(a), the Louisiana State University Agricultural Center or the Southern University Agricultural Center.

Louisiana Medical Marijuana Tracking System (LMMTS)—the required seed-to-sale tracking system that tracks medical marijuana from either the seed or immature plant stage until the plant material is sold as a finished product to a licensed medical marijuana pharmacy or destroyed.

Medical Marijuana—any parts of the plant genus *Cannabis* and all derivatives of all strains of this genus, whether growing or not; the seeds thereof; the resin extracted therefrom; any compound, mixture, or preparation of such plant, its seeds, or resin, including tetrahydrocannabinol (THC), cannabidiol (CBD), and all other naturally-occurring phytocannabinoids, whether produced directly or indirectly by extraction. This term does not include the mature stalks of such plant; fiber produced from such stalks; oil or cake made from the seeds of such plant; any other compound, salt, derivative, mixture, or preparation of such mature stalks (except for the resin extracted therefrom); fiber, oil, or cake; or sterilized seed incapable of germination.

Medical Marijuana Waste—medical marijuana that is unusable or that cannot be processed into a useable form.

Permittee—contractor employed by the licensee to grow, cultivate, process, transport, and distribute medical marijuana.

Therapeutic Marijuana—see *Medical Marijuana*.

AUTHORITY NOTE: Promulgated in accordance with R.S. 40:1046 et seq.

HISTORICAL NOTE: Promulgated by the Department of Health, Office of Public Health, LR 48:2976 (December 2022).

Chapter 3. Authority; Preemption

§301. Authority

A. The rules specified in this Part are promulgated under the authority of R.S. Title 40, Chapter 4, Part X-E (R.S. 40:1046 et seq.).

B. In accordance with the provisions of 21 U.S.C. 812, medical marijuana remains classified as a Schedule I Controlled Dangerous Substance by the government of the United States. No Louisiana law or regulation may preempt or supersede federal law, and the products regulated in the rules described in this Part remain subject to such laws as are applicable to Schedule I substances.

AUTHORITY NOTE: Promulgated in accordance with R.S. 40:1046 et seq.

HISTORICAL NOTE: Promulgated by the Department of Health, Office of Public Health, LR 48:2977 (December 2022).

Chapter 5. Licensure and Permitting

§501. Licensure of Authorized Entities

A. The department shall issue a nontransferable license to the Louisiana State University Agricultural Center and to the Southern University Agricultural Center to produce medical marijuana. Such license shall be renewable annually on July 1. Requirements for renewal include the maintenance of a contractual relationship with a single permittee.

B. No other entity is authorized to receive a license for the production of medical marijuana.

C. Licensees shall comply with all applicable requirements of R.S. Title 40, Chapter 4, Part X-E (R.S. 40:1046 et seq.), including payment of all fees, allowance of all inspections, and provision of all information required thereunder.

AUTHORITY NOTE: Promulgated in accordance with R.S. 40:1046 et seq.

HISTORICAL NOTE: Promulgated by the Department of Health, Office of Public Health, LR 48:2977 (December 2022).

§503. Permitting

A. Licensees shall contract with only one permittee, and this permittee shall apply to the department for an annual permit to engage in growing, cultivating, processing, transporting, and distributing medical marijuana.

B. Permits are nontransferable and subject to an application review process and a license fee of \$100,000.00. Permits expire on and shall be renewed annually on July 1.

C. Permittees shall comply with all applicable requirements of R.S. Title 40, Chapter 4, Part X-E (R.S.

40:1046 et seq.), including payment of all fees, allowance of all inspections, and provision of all information required thereunder.

AUTHORITY NOTE: Promulgated in accordance with R.S. 40:1046 et seq.

HISTORICAL NOTE: Promulgated by the Department of Health, Office of Public Health, LR 48:2977 (December 2022).

§505. Application Process

A. Applications for permitting shall be made using documents supplied by the department for this purpose.

B. Applicants shall supply the following information as a condition of receiving a new permit:

1. detailed plans of the facility, including a site plan and plumbing, electrical, mechanical, HVAC, and drainage schedules as well as schedules of finishes for floors, walls, and ceilings in all areas;

2. plans including layouts and lists of equipment used for surveillance of the facility, including cameras, motion-sensing devices, locking mechanisms, points of secured entry and egress, and monitoring stations;

3. proposed hours of operation and approximate estimated staffing levels;

4. product safety plans, including the protocol for processing each kind of medical marijuana manufactured at the site, including procedures for identifying, monitoring, and controlling any relevant biological, physical, or chemical hazards reasonably likely to occur during the growth, cultivation and harvesting, and production and packaging phases of the operation;

5. lists of required per-batch production records used for the manufacture of medical marijuana, including relevant laboratory testing of raw materials, components, excipients, and other constituents;

6. a recall plan;

7. a document provided by the licensee affirming that all criminal background checks on contractor personnel required by R.S. 40:1047 have been completed to the licensee's satisfaction; and

8. any other information or plans required to be provided under R.S. Title 40, Chapter 4, Part X-E (R.S. 40:1046 et seq.).

C. As a condition of renewal of a permit, the permittee shall supply the following additional information in writing to the department by January 10 of the renewal year:

1. the gross quantity of medical marijuana grown during the preceding calendar year;

2. a detailed report of associated production costs, including seed, fertilizer, labor, advisory services, construction and maintenance, and irrigation;

3. a detailed list of items for which subcontractors were employed and the associated costs for each service rendered by subcontractors;

4. the total quantity of medical marijuana generated as a finished product within that year and the quantity distributed to each licensed marijuana pharmacy;

5. costs paid to the licensee related to medical marijuana production; and

6. any other information or plans required to be provided under R.S. Title 40, Chapter 4, Part X-E (R.S. 40:1046 et seq.).

AUTHORITY NOTE: Promulgated in accordance with R.S. 40:1046 et seq.

HISTORICAL NOTE: Promulgated by the Department of Health, Office of Public Health, LR 48:2977 (December 2022).

Chapter 7. Inspections and Operational Requirements

§701. Inspections

A. Permittee facilities require a preoperational or initial inspection and this shall follow review and acceptance of the plans required in §505. Inspections are designed to ensure the following:

1. the facility is of solid construction and designed in such a way to secure the knowledge of the nature of its operations from a casual observer by means of odor control and secure enclosed spaces;

2. the facility, staff, and documents meet the necessary minimum standards to ensure the production of safe medical marijuana;

3. operational documents as described in §505.B are maintained on-premises;

4. the firm has current access to the Louisiana Medical Marijuana Tracking System (LMMTS);

5. the facility has adequate site and product security measures in place, including visitor logs and employee activity records;

6. the facility has an inventory tracking system as described in §703-§705 of this Chapter in place;

7. the facility has complete personnel records in place;

8. compliance with the requirements of §715 of this Part; and

9. the facility complies with all applicable requirements of R.S. Title 40, Chapter 4, Part X-E (R.S. 40:1046 et seq.).

B. As a condition of its permit, the permittee shall allow the State Health Officer or his/her designee(s) to review all records relevant to the operations and management of the permitted facility.

C. Routine inspections of permitted facilities to assess continued compliance shall occur no less frequently than twice per fiscal year. Complaint-based inspections may be conducted at any time during business hours and without prior notice.

AUTHORITY NOTE: Promulgated in accordance with R.S. 40:1046 et seq.

HISTORICAL NOTE: Promulgated by the Department of Health, Office of Public Health, LR 48:2978 (December 2022).

§703. Product and Site Security

A. Permittee facilities shall maintain an onsite security system that includes, at a minimum, the following components:

1. secured locks on doors throughout the facility;
2. audible alarms and a system of video and audio surveillance cameras with recording capabilities that meets the following additional requirements:
 - a. video surveillance shall cover all points of entry and exit and restricted-access areas;
 - b. video surveillance shall have accurate date and time stamps;
 - c. video surveillance recordings shall be maintained for at least 30 days.
3. a “panic” device with the ability to contact law enforcement;
4. a “duress” device capable of contacting law enforcement by means of a “silent alarm” and;
5. restricted access to sensitive areas (where medical marijuana products are cultivated, extracted, processed or stored).

B. Surveillance systems shall be monitored onsite between the hours of 8:00 and 17:00, but off-site monitoring may be provided during other hours.

C. Restricted-access areas shall be noted in the firm’s security plan and posted with suitable signage. These areas shall remain locked during all hours and access shall be controlled by means of employee badge scanners or similar devices.

D. Visitors shall be required to sign a log indicating their firm, purpose of visit, and date and time in and out of the facility. Visitors shall be allowed on the premises for official purposes only and shall be issued visitor badges for the duration of their visits. Visitors shall not remain in restricted-access areas unaccompanied by an authorized staff member unless no medical marijuana is present in the area at the time of the visit.

AUTHORITY NOTE: Promulgated in accordance with R.S. 40:1046 et seq.

HISTORICAL NOTE: Promulgated by the Department of Health, Office of Public Health, LR 48:2978 (December 2022).

§705. Louisiana Medical Marijuana Tracking System

A. Permittee facilities shall possess and maintain required hardware and software to connect to the Louisiana Medical Marijuana Tracking System.

B. Each plant and medical marijuana product originating at the facility shall be assigned a unique tag and identification number for tracking purposes.

C. Within 24 hours of the occurrence of one of the following events, it shall be documented in the LMMTS:

1. purchase or other acquisition of marijuana plants or seeds, including immature plants and seedlings;
2. sale, transfer or transport of medical marijuana to another contractor, approved laboratory, or medical marijuana pharmacy;
3. disposal of medical marijuana waste.

D. All records relating to transactions referenced in Subsection C., above, must be maintained for at least the current calendar year as well as the three preceding calendar years (if applicable).

AUTHORITY NOTE: Promulgated in accordance with R.S. 40:1046 et seq.

HISTORICAL NOTE: Promulgated by the Department of Health, Office of Public Health, LR 48:2978 (December 2022).

§707. Inventory Control

A. Permittee facilities shall maintain an inventory of medical marijuana, including medical marijuana waste, on their premises and update these records no less frequently than once per week.

B. Medical marijuana waste shall be tracked in the LMMTS and stored in a restricted-access area until it is incinerated or removed to a composting facility or landfill.

AUTHORITY NOTE: Promulgated in accordance with R.S. 40:1046 et seq.

HISTORICAL NOTE: Adopted by the Louisiana Department of Health, Office of Public Health, LR 48:2979 (December 2022).

§709. Toxic Chemical Use and Storage

A. Permittee facilities shall handle and store any chemicals for direct or indirect contact with medical marijuana in accordance with its written operations plan and the manufacturer’s directions.

B. Restricted-use pesticides shall only be handled by individuals with the required certifications.

C. Permittees shall maintain records of material safety data sheets (MSDS) for all chemicals currently in use at the facility.

D. When applying pesticides to a crop, the facility shall maintain the following records:

1. date and time of application;
2. name of the individual applying the pesticide;
3. batch numbers of all chemicals used; and
4. the amount and name of the chemicals used, including the EPA registration number, if applicable.

AUTHORITY NOTE: Promulgated in accordance with R.S. 40:1046 et seq.

HISTORICAL NOTE: Promulgated by the Department of Health, Office of Public Health, LR 48:2979 (December 2022).

§711. Transportation of Medical Marijuana

A. Permittee facilities shall generate an inventory manifest prior to transporting any medical marijuana to a licensed marijuana pharmacy, laboratory, contractor or disposal site. The manifest shall include the following items:

1. name of the originating firm;
2. name of the receiving facility;
3. quantity expressed in terms of weight measure or unit of each type of medical marijuana comprising the shipment;
4. the date and approximate departure and arrival times of the shipment;
5. the identity of the agents involved in the transportation; and
6. the make, model, and license plate number of the transport vehicle.

B. Prior to initiating transport, the originating facility shall supply a copy of the inventory manifest referenced in Subsection A to the receiving facility.

C. Upon receipt, the receiving facility shall update the relevant records in the LMMTS, except that the shipment shall be refused if unaccompanied by a valid, unaltered LMMTS inventory-manifest document.

D. Shipments that are refused under the provisions of Subsection C shall be returned to the originating facility at its expense and the appropriate documentation shall be generated and provided to the transporter and the receiving facility prior to returning the materials to the receiver. Updates to the material records in the LMMTS shall be made as needed.

AUTHORITY NOTE: Promulgated in accordance with R.S. 40:1046.

HISTORICAL NOTE: Promulgated by the Department of Health, Office of Public Health, LR 48:2979 (December 2022).

§713. Sampling Requirements

A. Permittees shall sample every batch of product to ensure compliance with the standards of quality outlined below. Permittees shall not release any batch of product for sale until the representative sample has been verified as compliant. Batches may be tested prior to portioning or packaging.

B. Sample verification shall be by means of the issuance of a certificate of analysis from the approved laboratory conducting the sample analysis issued to the Louisiana Department of Health and the originating facility no later than 24 hours after testing is complete.

C. Any batch with a sample failing one or more of the tests (by exceeding allowable limits for contaminants or residues) shall be remediated or destroyed, at the option of the permittee. A batch shall only be remediated once, and if subsequent sampling fails to correct the exceedance, the affected batch shall be destroyed.

D. Sample medical marijuana waste held at an approved laboratory shall be destroyed within 60 days of completion of testing.

E. Minimally-processed plant material shall be subject to all testing requirements below except testing for solvent residues.

F. Medical marijuana samples shall be required to meet the following standards of quality:

1. microbiological contaminants:
 - a. mold/yeast <10,000 CFU/g;
 - b. pathogenic *Escherichia coli* and *Salmonella* spp. < 1CFU/g;
 - c. aflatoxins < 20 ppb;
 - d. ochratoxins < 20 ppb.
2. solvent residues:
 - a. butanes < 800 ppm;
 - b. heptanes < 500 ppm;
 - c. benzene <1 ppm;
 - d. toluene <1 ppm;
 - e. hexanes < 10 ppm;
 - f. xylenes < 1ppm;
 - g. ethanol < 5,000 ppm.
3. heavy-metal contaminants:
 - a. arsenic < 10 ppm;
 - b. cadmium < 4.1 ppm;
 - c. lead < 10 ppm;
 - d. mercury < 2 ppm.
4. pesticide residues: see Table 1 for maximum contaminant levels for finished products; any pesticide not listed shall not have detectable residues in finished products.
5. homogeneity: each aliquot shall have a variance of no more than plus or minus 15 percent of the total average result for THC content.
6. potency: the product shall have a variance of no more than plus or minus 15 percent of the THC content specified on the product label.

G. Table 1. Category I and II Pesticide Residue Maximum Contaminant Levels (MCL) in parts per million (ppm) by dosage form

Name	Ingested	Inhaled
Category I (includes aldicarb, carbofuran, chlorpyrifos, coumaphos, daminozide, dichlorvos, dimethoate, ethoprop(hos), etofenprox, fenoxycarb, imazalil, methocarb, methyl parathion, mevinphos, paclobutrazol,	0	0

Name	Ingested	Inhaled
propoxur, spiroxamine, and thiacloprid)		
Category II		
Abamectin	0.3	0.1
Acephate	5	0.1
Acetamiprid	5	0.1
Acequinocyl	4	0.1
Azoxystrobin	40	0.1
Bifentate	5	0.1
Bifenthrin	0.5	3
Boscalid	10	0.1
Captan	5	0.7
Carbaryl	0.5	0.5
Chlorantraniliprole	40	10
Clofentezine	0.5	0.1
Cyfluthrin	1	2
Cypermethrin	1	1
Diazinon	0.2	0.1
Dimethomorph	20	2
Etoxazole	1.5	0.1
Fenhexamid	10	0.1
Fenpyroximate	2	0.1
Fonicamid	2	0.1
Fludioxionil	30	0.1
Hexythiazox	2	0.1
Imidacloprid	3	5
Kresoxim-methyl	1	0.1
Malathion	5	0.5
Metalaxyl	15	2
Methomyl	0.1	1
Myclobutanil	9	0.1
Naled	0.5	0.1
Oxamyl	0.2	0.5
Pentachloronitrobenzene	0.2	0.1
Permethrin	20	0.5
Phosmet	0.2	0.1
Piperonylbutoxide	8	3
Prallethrin	0.4	0.1
Propiconazole	20	0.1
Pyrethrins	1	0.5
Pyradiben	3	0.1
Spinetoram	3	0.1
Spinosad	3	0.1
Spiromesifen	12	0.1
Spirotetramat	13	0.1
Tebuconazole	2	0.1
Thiamethoxam	4.5	5
Trifloxystrobin	30	0.1

AUTHORITY NOTE: Promulgated in accordance with R.S. 40:1046 et seq.

HISTORICAL NOTE: Promulgated by the Department of Health, Office of Public Health, LR 48:2979 (December 2022).

§715. Basic Facility Requirements

A. Permittee facilities shall provide finishes to floors, walls, and ceilings that are durable, light in color, and easily cleanable.

B. Facilities shall be sufficient in size to allow space for the following:

1. orderly placement of equipment and materials to minimize the possibility of contamination;

2. receipt, storage, and withholding from use components pending sampling (if required), identification and release by quality assurance personnel;

3. holding of rejected components or finished products pending disposal or rework;

4. storage of containers, packaging and labeling;

5. manufacturing and processing operations;

6. packaging and labeling operations; and

7. storage of finished products.

C. Facilities shall provide lighting, ventilation, and screening as needed to do the following:

1. prevent contamination of products with extraneous adulterants;

2. minimize dissemination of microorganisms from one area to another.

D. Facilities shall provide locker rooms for storage of employee personal equipment and belongings.

E. Facilities shall provide a plumbing system designed and installed in accordance with the Louisiana State Uniform Construction Code. Additionally, the system shall include the following:

1. no cross-connections between any potable and non-potable water supply;

2. where all equipment is not clean-in-place, at least one three-compartment sink with compartments adequate in size to submerge the largest utensil used in manufacturing operations;

3. an adequate number of hand lavatories supplied with hot-and-cold running water through a mixer-type faucet and hand soap and paper towels located convenient to manufacturing operation areas;

4. at least one utility sink for the disposal of mop wastes;

5. adequate means of sanitary disposal of wastewater.

F. Facilities shall provide adequate means of conveyance, storage, and disposal of refuse and non-medical marijuana waste products so as to minimize the development of odors, prevent waste products from becoming an attractant to and harborage for vermin, and prevent contamination of components, finished products, facility surfaces, grounds or water supplies.

G. Facilities shall provide toilet rooms in accordance with the Louisiana State Uniform Construction Code. Additionally toilet rooms shall be maintained in proper working order and in a sanitary condition. Toilet rooms shall have self-closing doors and shall not open directly into manufacturing areas. Toilet rooms shall include signs directing employees to wash hands with soap and water after using the toilet.

H. Facilities shall be located on premises that are maintained free of the following:

1. disused equipment, waste, debris or other materials that may serve as harborages for or attractants to vermin;
2. overgrowth of vegetation;
3. poorly-drained areas; and
4. excessively-dusty areas.

I. Equipment used in manufacturing operations shall not be additive, reactive, or absorptive to any product or its components and shall be installed in such a manner as to facilitate cleaning and not to contribute to potential cross-contamination of finished products.

AUTHORITY NOTE: Promulgated in accordance with R.S. 40:1046 et seq.

HISTORICAL NOTE: Promulgated by the Department of Health, Office of Public Health, LR 48:2980 (December 2022).

Chapter 9. Approved Laboratories for Testing Medical Marijuana

§901. General Requirements

A. Permittee facilities shall only utilize approved laboratories, as defined in this Section, for testing of medical marijuana.

B. Prior to testing medical marijuana to verify compliance, a laboratory shall apply for and receive a medical marijuana laboratory license from the Louisiana Department of Health.

C. A laboratory holding or seeking a medical marijuana laboratory license shall comply with all applicable requirements of R.S. Title 40, Chapter 4, Part X-E (R.S. 40:1046 et seq.).

AUTHORITY NOTE: Promulgated in accordance with R.S. 40:1046 et seq.

HISTORICAL NOTE: Promulgated by the Department of Health, Office of Public Health, LR 48:2981 (December 2022).

§903. Application Process

A. Applications for initial licensure and renewal of licensure shall be made using documents supplied by the department for this purpose.

B. Applicants shall be required to supply the following documentation as part of the application process:

1. proof of accreditation through the National Institute on Drug Abuse (NIDA), the National Environmental Laboratory Accreditation Conference (NELAC), or the International Organization for

Standardization (ISO); or proof of operation of a licensed or permitted medical marijuana testing laboratory in another state for the previous 12 months, and accreditation or pending accreditation through ISO;

2. an affidavit that representatives of the State Health Officer shall be granted access to all areas of the facility utilized for medical marijuana testing upon request; and

3. documentation indicating that the firm is currently able to access and utilize the Louisiana Medical Marijuana Tracking System (LMMTS).

C. Approved medical marijuana testing laboratory licenses shall be renewable annually every December 31. Applications for renewal shall be submitted to the Louisiana Department of Health no later than October 31; applicants shall provide copies of current accreditation-verification and permit documents in order for a new license to be issued to the facility.

D. Failure to renew in a timely fashion shall trigger a requirement to destroy all medical marijuana located at the facility after midnight on December 31. Any product remaining on the premises at that time shall be subject to seizure under the provisions of La. R.S. 40:632 et seq.

AUTHORITY NOTE: Promulgated in accordance with R.S. 40:1046 et seq.

HISTORICAL NOTE: Promulgated by the Department of Health, Office of Public Health, LR 48:2981 (December 2022).

§905. Exemptions

A. The Agricultural Chemistry Laboratory of the Louisiana Department of Agriculture and Forestry is exempt from the requirements of §901 and §903.

AUTHORITY NOTE: Promulgated in accordance with R.S. 40:1046 et seq.

HISTORICAL NOTE: Promulgated by the Department of Health, Office of Public Health, LR 48:2981 (December 2022).

§907. Records

A. Laboratories shall maintain all records related to testing of medical marijuana for no less than three years. Such records shall be made available for review to representatives of the State Health Officer upon request.

AUTHORITY NOTE: Promulgated in accordance with R.S. 40:1046 et seq.

HISTORICAL NOTE: Promulgated by the Department of Health, Office of Public Health, LR 48:2981 (December 2022).