

HIGHLIGHTS OF PRESCRIBING INFORMATION

These highlights do not include all the information needed to use NYVEPRIA safely and effectively. See full prescribing information for NYVEPRIA.

NYVEPRIA™ (pegfilgrastim-apgf) injection, for subcutaneous use
Initial U.S. Approval: 2020

NYVEPRIA (pegfilgrastim-apgf) is biosimilar* to NEULASTA (pegfilgrastim)

INDICATIONS AND USAGE

NYVEPRIA is a leukocyte growth factor indicated to decrease the incidence of infection, as manifested by febrile neutropenia, in patients with non-myeloid malignancies receiving myelosuppressive anti-cancer drugs associated with a clinically significant incidence of febrile neutropenia. (1)

Limitations of Use

NYVEPRIA is not indicated for the mobilization of peripheral blood progenitor cells for hematopoietic stem cell transplantation. (1)

DOSAGE AND ADMINISTRATION

Patients with cancer receiving myelosuppressive chemotherapy

- 6 mg administered subcutaneously once per chemotherapy cycle. (2.1)
- Do not administer between 14 days before and 24 hours after administration of cytotoxic chemotherapy. (2.1)
- Use weight based dosing for pediatric patients weighing less than 45 kg; refer to Table 1. (2.2)

DOSAGE FORMS AND STRENGTHS

Injection: 6 mg/0.6 mL solution in a single-dose prefilled syringe for manual use only. (3)

CONTRAINDICATIONS

Patients with a history of serious allergic reactions to human granulocyte colony-stimulating factors such as pegfilgrastim products or filgrastim products. (4)

WARNINGS AND PRECAUTIONS

- Fatal splenic rupture: Evaluate patients who report left upper abdominal or shoulder pain for an enlarged spleen or splenic rupture. (5.1)
- Acute respiratory distress syndrome (ARDS): Evaluate patients who develop fever, lung infiltrates, or respiratory distress. Discontinue NYVEPRIA in patients with ARDS. (5.2)
- Serious allergic reactions, including anaphylaxis: Permanently discontinue NYVEPRIA in patients with serious allergic reactions. (5.3)
- Fatal sickle cell crises: Have occurred. (5.4)
- Glomerulonephritis: Evaluate and consider dose-reduction or interruption of NYVEPRIA if causality is likely. (5.5)

ADVERSE REACTIONS

Most common adverse reactions ($\geq 5\%$ difference in incidence compared to placebo) are bone pain and pain in extremity. (6.1)

To report SUSPECTED ADVERSE REACTIONS, contact Pfizer Inc. at 1-800-438-1985 or FDA at 1-800-FDA-1088 or www.fda.gov/medwatch.

See 17 for PATIENT COUNSELING INFORMATION and FDA-approved patient labeling.

*Biosimilar means that the biological product is approved based on data demonstrating that it is highly similar to an FDA-approved biological product, known as a reference product, and that there are no clinically meaningful differences between the biosimilar product and the reference product. Biosimilarity of NYVEPRIA has been demonstrated for the condition(s) of use (e.g., indication(s), dosing regimen(s)), strength(s), dosage form(s), and route(s) of administration described in its Full Prescribing Information.

Revised: 06/2020

FULL PRESCRIBING INFORMATION: CONTENTS**

- 1 INDICATIONS AND USAGE
- 2 DOSAGE AND ADMINISTRATION
 - 2.1 Patients with Cancer Receiving Myelosuppressive Chemotherapy
 - 2.2 Administration
- 3 DOSAGE FORMS AND STRENGTHS
- 4 CONTRAINDICATIONS
- 5 WARNINGS AND PRECAUTIONS
 - 5.1 Splenic Rupture
 - 5.2 Acute Respiratory Distress Syndrome
 - 5.3 Serious Allergic Reactions
 - 5.4 Use in Patients with Sickle Cell Disorders
 - 5.5 Glomerulonephritis
 - 5.6 Leukocytosis
 - 5.7 Capillary Leak Syndrome
 - 5.8 Potential for Tumor Growth Stimulatory Effects on Malignant Cells
 - 5.9 Aortitis
 - 5.10 Nuclear Imaging
- 6 ADVERSE REACTIONS
 - 6.1 Clinical Trials Experience
 - 6.2 Immunogenicity
 - 6.3 Postmarketing Experience

- 8 USE IN SPECIFIC POPULATIONS
 - 8.1 Pregnancy
 - 8.2 Lactation
 - 8.4 Pediatric Use
 - 8.5 Geriatric Use
- 10 OVERDOSAGE
- 11 DESCRIPTION
- 12 CLINICAL PHARMACOLOGY
 - 12.1 Mechanism of Action
 - 12.2 Pharmacodynamics
 - 12.3 Pharmacokinetics
- 13 NONCLINICAL TOXICOLOGY
 - 13.1 Carcinogenesis, Mutagenesis, Impairment of Fertility
- 14 CLINICAL STUDIES
- 16 HOW SUPPLIED/STORAGE AND HANDLING
- 17 PATIENT COUNSELING INFORMATION

** Sections or subsections omitted from the full prescribing information are not listed.

FULL PRESCRIBING INFORMATION

1 INDICATIONS AND USAGE

NYVEPRIA is indicated to decrease the incidence of infection, as manifested by febrile neutropenia, in patients with non-myeloid malignancies receiving myelosuppressive anti-cancer drugs associated with a clinically significant incidence of febrile neutropenia [see *Clinical Studies (14)*].

Limitations of Use

NYVEPRIA is not indicated for the mobilization of peripheral blood progenitor cells for hematopoietic stem cell transplantation.

2 DOSAGE AND ADMINISTRATION

2.1 Patients with Cancer Receiving Myelosuppressive Chemotherapy

The recommended dosage of NYVEPRIA is a single subcutaneous injection of 6 mg administered once per chemotherapy cycle. For dosing in pediatric patients weighing less than 45 kg, refer to Table 1. Do not administer NYVEPRIA between 14 days before and 24 hours after administration of cytotoxic chemotherapy.

2.2 Administration

NYVEPRIA is administered subcutaneously via a single-dose prefilled syringe for manual use.

Prior to use, remove the carton from the refrigerator and allow the NYVEPRIA prefilled syringe to reach room temperature for a minimum of 30 minutes. Discard any prefilled syringe left at room temperature for greater than 15 days.

Parenteral drug products should be inspected visually for particulate matter and discoloration prior to administration, whenever solution and container permit. NYVEPRIA is supplied as a clear and colorless solution. Do not administer NYVEPRIA if discoloration or particulates are observed.

The NYVEPRIA syringe plunger stopper and needle cover are not made with natural rubber latex.

Pediatric Patients Weighing Less than 45 kg

The NYVEPRIA prefilled syringe is not designed to allow for direct administration of doses less than 0.6 mL (6 mg). The syringe does not bear graduation marks, which are necessary to accurately measure doses of NYVEPRIA less than 0.6 mL (6 mg) for direct administration to patients. Thus, the direct administration to patients requiring dosing of less than 0.6 mL (6 mg) is not recommended due to the potential for dosing errors. Refer to Table 1.

Table 1. Dosing of NYVEPRIA for Pediatric Patients Weighing Less than 45 kg

Body Weight	NYVEPRIA Dose	Volume to Administer
Less than 10 kg [*]	See below [*]	See below [*]
10 - 20 kg	1.5 mg	0.15 mL
21 - 30 kg	2.5 mg	0.25 mL
31 - 44 kg	4 mg	0.4 mL

^{*} For pediatric patients weighing less than 10 kg, administer 0.1 mg/kg (0.01 mL/kg) of NYVEPRIA.

3 DOSAGE FORMS AND STRENGTHS

NYVEPRIA is a clear, colorless, preservative-free solution available as:

- Injection: 6 mg/0.6 mL in a single-dose prefilled syringe for manual use only.

4 CONTRAINDICATIONS

NYVEPRIA is contraindicated in patients with a history of serious allergic reactions to pegfilgrastim products or filgrastim products. Reactions have included anaphylaxis [*see Warnings and Precautions (5.3)*].

5 WARNINGS AND PRECAUTIONS

5.1 Splenic Rupture

Splenic rupture, including fatal cases, can occur following the administration of pegfilgrastim products. Evaluate for an enlarged spleen or splenic rupture in patients who report left upper abdominal or shoulder pain after receiving NYVEPRIA.

5.2 Acute Respiratory Distress Syndrome

Acute respiratory distress syndrome (ARDS) can occur in patients receiving pegfilgrastim products. Evaluate patients who develop fever and lung infiltrates or respiratory distress after receiving NYVEPRIA, for ARDS. Discontinue NYVEPRIA in patients with ARDS.

5.3 Serious Allergic Reactions

Serious allergic reactions, including anaphylaxis, can occur in patients receiving pegfilgrastim products. The majority of reported events occurred upon initial exposure. Allergic reactions, including anaphylaxis, can recur within days after the discontinuation of initial anti-allergic treatment. Permanently discontinue NYVEPRIA in patients with serious allergic reactions. Do not administer NYVEPRIA to patients with a history of serious allergic reactions to pegfilgrastim products or filgrastim products.

5.4 Use in Patients with Sickle Cell Disorders

Severe and sometimes fatal sickle cell crises can occur in patients with sickle cell disorders receiving pegfilgrastim products. Discontinue NYVEPRIA if sickle cell crisis occurs.

5.5 Glomerulonephritis

Glomerulonephritis has occurred in patients receiving pegfilgrastim products. The diagnoses were based upon azotemia, hematuria (microscopic and macroscopic), proteinuria, and renal biopsy. Generally, events of glomerulonephritis resolved after dose-reduction or discontinuation of pegfilgrastim products. If glomerulonephritis is suspected, evaluate for cause. If causality is likely, consider dose-reduction or interruption of NYVEPRIA.

5.6 Leukocytosis

White blood cell (WBC) counts of $100 \times 10^9/L$ or greater have been observed in patients receiving pegfilgrastim products. Monitoring of complete blood count (CBC) during NYVEPRIA therapy is recommended.

5.7 Capillary Leak Syndrome

Capillary leak syndrome has been reported after G-CSF administration, including pegfilgrastim products, and is characterized by hypotension, hypoalbuminemia, edema and hemoconcentration. Episodes vary in frequency, severity and may be life-threatening if treatment is delayed. Patients who develop symptoms of capillary leak syndrome should be closely monitored and receive standard symptomatic treatment, which may include a need for intensive care.

5.8 Potential for Tumor Growth Stimulatory Effects on Malignant Cells

The granulocyte-colony stimulating factor (G-CSF) receptor through which pegfilgrastim products and filgrastim products act has been found on tumor cell lines. The possibility that pegfilgrastim products act as a

growth factor for any tumor type, including myeloid malignancies and myelodysplasia, diseases for which pegfilgrastim products are not approved, cannot be excluded.

5.9 Aortitis

Aortitis has been reported in patients receiving pegfilgrastim products. It may occur as early as the first week after start of therapy. Manifestations may include generalized signs and symptoms such as fever, abdominal pain, malaise, back pain, and increased inflammatory markers (e.g., c-reactive protein and white blood cell count). Consider aortitis in patients who develop these signs and symptoms without known etiology. Discontinue NYVEPRIA if aortitis is suspected.

5.10 Nuclear Imaging

Increased hematopoietic activity of the bone marrow in response to growth factor therapy has been associated with transient positive bone imaging changes. This should be considered when interpreting bone imaging results.

6 ADVERSE REACTIONS

The following clinically significant adverse reactions are discussed in greater detail in other sections of the labeling:

- Splenic Rupture [see Warnings and Precautions (5.1)]
- Acute Respiratory Distress Syndrome [see Warnings and Precautions (5.2)]
- Serious Allergic Reactions [see Warnings and Precautions (5.3)]
- Use in Patients with Sickle Cell Disorders [see Warnings and Precautions (5.4)]
- Glomerulonephritis [see Warnings and Precautions (5.5)]
- Leukocytosis [see Warnings and Precautions (5.6)]
- Capillary Leak Syndrome [see Warnings and Precautions (5.7)]
- Potential for Tumor Growth Stimulatory Effects on Malignant Cells [see Warnings and Precautions (5.8)]
- Aortitis [see Warnings and Precautions (5.9)]

6.1 Clinical Trials Experience

Because clinical trials are conducted under widely varying conditions, adverse reaction rates observed in the clinical trials of a drug cannot be directly compared to rates in the clinical trials of another drug and may not reflect the rates observed in practice.

Pegfilgrastim clinical trials safety data are based upon 932 patients receiving pegfilgrastim in seven randomized clinical trials. The population was 21 to 88 years of age and 92% female. The ethnicity was 75% Caucasian, 18% Hispanic, 5% Black, and 1% Asian. Patients with breast (n = 823), lung and thoracic tumors (n = 53) and lymphoma (n = 56) received pegfilgrastim after nonmyeloablative cytotoxic chemotherapy. Most patients received a single 100 mcg/kg (n = 259) or a single 6 mg (n = 546) dose per chemotherapy cycle over 4 cycles.

The following adverse reaction data in Table 2 are from a randomized, double-blind, placebo-controlled study in patients with metastatic or non-metastatic breast cancer receiving docetaxel 100 mg/m² every 21 days (Study 3). A total of 928 patients were randomized to receive either 6 mg pegfilgrastim (n = 467) or placebo (n = 461). The patients were 21 to 88 years of age and 99% female. The ethnicity was 66% Caucasian, 31% Hispanic, 2% Black, and <1% Asian, Native American, or Other.

The most common adverse reactions occurring in ≥5% of patients and with a between-group difference of ≥5% higher in the pegfilgrastim arm in placebo-controlled clinical trials are bone pain and pain in extremity.

Table 2. Adverse Reactions with $\geq 5\%$ Higher Incidence in Pegfilgrastim Patients Compared to Placebo in Study 3

Body System Adverse Reaction	Placebo (N = 461)	Pegfilgrastim 6 mg SC on Day 2 (N = 467)
Musculoskeletal and connective tissue disorders		
Bone pain	26%	31%
Pain in extremity	4%	9%

Leukocytosis

In clinical studies, leukocytosis (WBC counts $>100 \times 10^9/L$) was observed in less than 1% of 932 patients with non-myeloid malignancies receiving pegfilgrastim. No complications attributable to leukocytosis were reported in clinical studies.

6.2 Immunogenicity

As with all therapeutic proteins, there is potential for immunogenicity. The detection of antibody formation is highly dependent on the sensitivity and specificity of the assay. Additionally, the observed incidence of antibody (including neutralizing antibody) positivity in an assay may be influenced by several factors, including assay methodology, sample handling, timing of sample collection, concomitant medications, and underlying disease. For these reasons, comparison of the incidence of antibodies in the studies described below with the incidence of antibodies in other studies or to other pegfilgrastim products may be misleading.

Binding antibodies to pegfilgrastim were detected using a BIAcore assay. The approximate limit of detection for this assay is 500 ng/mL. Pre-existing binding antibodies were detected in approximately 6% (51/849) of patients with metastatic breast cancer. Four of 521 pegfilgrastim-treated subjects who were negative at baseline developed binding antibodies to pegfilgrastim following treatment. None of these 4 patients had evidence of neutralizing antibodies detected using a cell-based bioassay.

6.3 Postmarketing Experience

The following adverse reactions have been identified during post-approval use of pegfilgrastim products. Because these reactions are reported voluntarily from a population of uncertain size, it is not always possible to reliably estimate their frequency or establish a causal relationship to drug exposure.

- Splenic rupture and splenomegaly (enlarged spleen) [*see Warnings and Precautions (5.1)*]
- Acute respiratory distress syndrome (ARDS) [*see Warnings and Precautions (5.2)*]
- Allergic reactions/hypersensitivity, including anaphylaxis, skin rash, urticaria, generalized erythema, and flushing [*see Warnings and Precautions (5.3)*]
- Sick cell crisis [*see Warnings and Precautions (5.4)*]
- Glomerulonephritis [*see Warnings and Precautions (5.5)*]
- Leukocytosis [*see Warnings and Precautions (5.6)*]
- Capillary Leak Syndrome [*see Warnings and Precautions (5.7)*]
- Injection site reactions
- Sweet's syndrome (acute febrile neutrophilic dermatosis), cutaneous vasculitis
- Aortitis [*see Warnings and Precautions (5.9)*]
- Alveolar hemorrhage

8 USE IN SPECIFIC POPULATIONS

8.1 Pregnancy

Risk Summary

Although available data with NYVEPRIA or pegfilgrastim product use in pregnant women are insufficient to establish whether there is a drug associated risk of major birth defects, miscarriage, or adverse maternal or fetal

outcomes, there are available data from published studies in pregnant women exposed to filgrastim products. These studies have not established an association of filgrastim product use during pregnancy with major birth defects, miscarriage, or adverse maternal or fetal outcomes.

In animal studies, no evidence of reproductive/developmental toxicity occurred in the offspring of pregnant rats that received cumulative doses of pegfilgrastim approximately 10 times the recommended human dose (based on body surface area). In pregnant rabbits, increased embryoletality and spontaneous abortions occurred at 4 times the maximum recommended human dose simultaneously with signs of maternal toxicity (*see Data*).

The estimated background risk of major birth defects and miscarriage for the indicated population is unknown. All pregnancies have a background risk of birth defect, loss, or other adverse outcomes. In the U.S. general population, the estimated background risk of major birth defects and miscarriage in clinically recognized pregnancies is 2 to 4% and 15 to 20%, respectively.

Data

Animal Data

Pregnant rabbits were dosed with pegfilgrastim subcutaneously every other day during the period of organogenesis. At cumulative doses ranging from the approximate human dose to approximately 4 times the recommended human dose (based on body surface area), the treated rabbits exhibited decreased maternal food consumption, maternal weight loss, as well as reduced fetal body weights and delayed ossification of the fetal skull; however, no structural anomalies were observed in the offspring from either study. Increased incidences of post-implantation losses and spontaneous abortions (more than half the pregnancies) were observed at cumulative doses approximately 4 times the recommended human dose, which were not seen when pregnant rabbits were exposed to the recommended human dose.

Three studies were conducted in pregnant rats dosed with pegfilgrastim at cumulative doses up to approximately 10 times the recommended human dose at the following stages of gestation: during the period of organogenesis, from mating through the first half of pregnancy, and from the first trimester through delivery and lactation. No evidence of fetal loss or structural malformations was observed in any study. Cumulative doses equivalent to approximately 3 and 10 times the recommended human dose resulted in transient evidence of wavy ribs in fetuses of treated mothers (detected at the end of gestation but no longer present in pups evaluated at the end of lactation).

8.2 Lactation

Risk Summary

There are no data on the presence of pegfilgrastim products in human milk, the effects on the breastfed child, or the effects on milk production. Other filgrastim products are secreted poorly into breast milk, and filgrastim products are not absorbed orally by neonates. The developmental and health benefits of breastfeeding should be considered along with the mother's clinical need for NYVEPRIA and any potential adverse effects on the breastfed child from NYVEPRIA or from the underlying maternal condition.

8.4 Pediatric Use

The safety and effectiveness of pegfilgrastim have been established in pediatric patients. No overall differences in safety were identified between adult and pediatric patients based on postmarketing surveillance and review of the scientific literature.

Use of pegfilgrastim in pediatric patients for chemotherapy-induced neutropenia is based on adequate and well-controlled studies in adults with additional pharmacokinetic and safety data in pediatric patients with sarcoma [*see Clinical Pharmacology (12.3) and Clinical Studies (14)*].

8.5 Geriatric Use

Of the 932 patients with cancer who received pegfilgrastim in clinical studies, 139 (15%) were aged 65 and over, and 18 (2%) were aged 75 and over. No overall differences in safety or effectiveness were observed between patients aged 65 and older and younger patients.

10 OVERDOSAGE

Overdosage of pegfilgrastim products may result in leukocytosis and bone pain. Events of edema, dyspnea, and pleural effusion have been reported in a single patient who administered pegfilgrastim on 8 consecutive days in error. In the event of overdose, the patient should be monitored for adverse reactions [see *Adverse Reactions (6)*].

11 DESCRIPTION

Pegfilgrastim-apgf is a covalent conjugate of recombinant methionyl human G-CSF and monomethoxypolyethylene glycol. Recombinant methionyl human G-CSF is a water-soluble 175 amino acid protein with a molecular weight of approximately 19 kilodaltons (kD). Recombinant methionyl human G-CSF is obtained from the bacterial fermentation of a strain of *E. coli* transformed with a genetically engineered plasmid containing the human G-CSF gene. To produce pegfilgrastim-apgf, a 20 kD monomethoxypolyethylene glycol molecule is covalently bound to the N-terminal methionyl residue of recombinant methionyl human G-CSF. The average molecular weight of pegfilgrastim-apgf is approximately 39 kD.

NYVEPRIA for manual subcutaneous injection is supplied in 0.6 mL prefilled syringes. The prefilled syringe does not bear graduation marks and is designed to deliver the entire contents of the syringe (6 mg/0.6 mL).

The delivered 0.6 mL dose from the prefilled syringe for manual subcutaneous injection contains 6 mg pegfilgrastim-apgf (based on protein weight) in a sterile, clear, colorless, preservative-free solution (pH 4.0) containing acetate (0.35 mg), polysorbate 20 (0.02 mg), sodium (0.01 mg), and sorbitol (30 mg) in Water for Injection, USP.

12 CLINICAL PHARMACOLOGY

12.1 Mechanism of Action

Pegfilgrastim products are colony-stimulating factors that act on hematopoietic cells by binding to specific cell surface receptors, thereby stimulating proliferation, differentiation, commitment, and end cell functional activation.

12.2 Pharmacodynamics

Animal data and clinical data in humans suggest a correlation between pegfilgrastim products' exposure and the duration of severe neutropenia as a predictor of efficacy. Selection of the dosing regimen of NYVEPRIA is based on reducing the duration of severe neutropenia.

12.3 Pharmacokinetics

The pharmacokinetics of pegfilgrastim was studied in 379 patients with cancer. The pharmacokinetics of pegfilgrastim was nonlinear, and clearance decreased with increases in dose. Neutrophil receptor binding is an important component of the clearance of pegfilgrastim, and serum clearance is directly related to the number of neutrophils. In addition to numbers of neutrophils, body weight appeared to be a factor. Patients with higher body weights experienced higher systemic exposure to pegfilgrastim after receiving a dose normalized for body weight. A large variability in the pharmacokinetics of pegfilgrastim was observed. The half-life of pegfilgrastim ranged from 15 to 80 hours after subcutaneous injection.

Specific Populations

No gender-related differences were observed in the pharmacokinetics of pegfilgrastim, and no differences were observed in the pharmacokinetics of geriatric patients (≥ 65 years of age) compared with younger patients (< 65 years of age) [*see Use in Specific Populations (8.5)*].

Renal Impairment

In a study of 30 subjects with varying degrees of renal dysfunction, including end stage renal disease, renal dysfunction had no effect on the pharmacokinetics of pegfilgrastim.

Pediatric Patients with Cancer Receiving Myelosuppressive Chemotherapy

The pharmacokinetics and safety of pegfilgrastim were studied in 37 pediatric patients with sarcoma in Study 4 [*see Clinical Studies (14)*]. The mean (\pm standard deviation [SD]) systemic exposure ($AUC_{0-\infty}$) of pegfilgrastim after subcutaneous administration at 100 mcg/kg was 47.9 (± 22.5) mcg·hr/mL in the youngest age group (0 to 5 years, $n = 11$), 22.0 (± 13.1) mcg·hr/mL in the 6 to 11 years age group ($n = 10$), and 29.3 (± 23.2) mcg·hr/mL in the 12 to 21 years age group ($n = 13$). The terminal elimination half-lives of the corresponding age groups were 30.1 (± 38.2) hours, 20.2 (± 11.3) hours, and 21.2 (± 16.0) hours, respectively.

13 NONCLINICAL TOXICOLOGY

13.1 Carcinogenesis, Mutagenesis, Impairment of Fertility

No carcinogenicity or mutagenesis studies have been performed with pegfilgrastim products.

Pegfilgrastim did not affect reproductive performance or fertility in male or female rats at cumulative weekly doses approximately 6 to 9 times higher than the recommended human dose (based on body surface area).

14 CLINICAL STUDIES

Pegfilgrastim was evaluated in three randomized, double-blind, controlled studies. Studies 1 and 2 were active-controlled studies that employed doxorubicin 60 mg/m² and docetaxel 75 mg/m² administered every 21 days for up to 4 cycles for the treatment of metastatic breast cancer. Study 1 investigated the utility of a fixed dose of pegfilgrastim. Study 2 employed a weight-adjusted dose. In the absence of growth factor support, similar chemotherapy regimens have been reported to result in a 100% incidence of severe neutropenia ($ANC < 0.5 \times 10^9/L$) with a mean duration of 5 to 7 days and a 30% to 40% incidence of febrile neutropenia. Based on the correlation between the duration of severe neutropenia and the incidence of febrile neutropenia found in studies with filgrastim, duration of severe neutropenia was chosen as the primary endpoint in both studies, and the efficacy of pegfilgrastim was demonstrated by establishing comparability to filgrastim-treated patients in the mean days of severe neutropenia.

In Study 1, 157 patients were randomized to receive a single subcutaneous injection of pegfilgrastim (6 mg) on day 2 of each chemotherapy cycle or daily subcutaneous filgrastim (5 mcg/kg/day) beginning on day 2 of each chemotherapy cycle. In Study 2, 310 patients were randomized to receive a single subcutaneous injection of pegfilgrastim (100 mcg/kg) on day 2 or daily subcutaneous filgrastim (5 mcg/kg/day) beginning on day 2 of each chemotherapy cycle.

Both studies met the major efficacy outcome measure of demonstrating that the mean days of severe neutropenia of pegfilgrastim-treated patients did not exceed that of filgrastim-treated patients by more than 1 day in cycle 1 of chemotherapy. The mean days of cycle 1 severe neutropenia in Study 1 were 1.8 days in the pegfilgrastim arm compared to 1.6 days in the filgrastim arm [difference in means 0.2 (95% CI -0.2, 0.6)] and in Study 2 were 1.7 days in the pegfilgrastim arm compared to 1.6 days in the filgrastim arm [difference in means 0.1 (95% CI -0.2, 0.4)].

A secondary endpoint in both studies was days of severe neutropenia in cycles 2 through 4 with results similar to those for cycle 1.

Study 3 was a randomized, double-blind, placebo-controlled study that employed docetaxel 100 mg/m² administered every 21 days for up to 4 cycles for the treatment of metastatic or non-metastatic breast cancer. In this study, 928 patients were randomized to receive a single subcutaneous injection of pegfilgrastim (6 mg) or placebo on day 2 of each chemotherapy cycle. Study 3 met the major trial outcome measure of demonstrating that the incidence of febrile neutropenia (defined as temperature $\geq 38.2^{\circ}\text{C}$ and ANC $\leq 0.5 \times 10^9/\text{L}$) was lower for pegfilgrastim-treated patients as compared to placebo-treated patients (1% versus 17%, respectively, $p < 0.001$). The incidence of hospitalizations (1% versus 14%) and IV anti-infective use (2% versus 10%) for the treatment of febrile neutropenia was also lower in the pegfilgrastim-treated patients compared to the placebo-treated patients.

Study 4 was a multicenter, randomized, open-label study to evaluate the efficacy, safety, and pharmacokinetics [see *Clinical Pharmacology (12.3)*] of pegfilgrastim in pediatric and young adult patients with sarcoma. Patients with sarcoma receiving chemotherapy age 0 to 21 years were eligible. Patients were randomized to receive subcutaneous pegfilgrastim as a single dose of 100 mcg/kg ($n = 37$) or subcutaneous filgrastim at a dose 5 mcg/kg/day ($n = 6$) following myelosuppressive chemotherapy. Recovery of neutrophil counts was similar in the pegfilgrastim and filgrastim groups. The most common adverse reaction reported was bone pain.

16 HOW SUPPLIED/STORAGE AND HANDLING

NYVEPRIA (pegfilgrastim-apgf) injection is a clear, colorless solution supplied in a prefilled single-dose syringe for manual use containing 6 mg pegfilgrastim-apgf, supplied with a 27-gauge 1/2-inch needle and a BD UltraSafe Plus™ Passive Needle Guard.

The NYVEPRIA syringe plunger stopper and needle cover are not made with natural rubber latex.

NYVEPRIA is provided in a dispensing pack containing one sterile 6 mg/0.6 mL prefilled syringe (NDC 0069-0324-01).

NYVEPRIA prefilled syringe does not bear graduation marks and is intended only to deliver the entire contents of the syringe (6 mg/0.6 mL) for direct administration. Use of the prefilled syringe is not recommended for direct administration for pediatric patients weighing less than 45 kg who require doses that are less than the full contents of the syringe.

Store refrigerated between 36°F to 46°F (2°C to 8°C) in the carton to protect from light. Do not shake. Discard syringes stored at room temperature for more than 15 days. Avoid freezing; if frozen, thaw in the refrigerator before administration. Discard syringe if frozen more than once.

17 PATIENT COUNSELING INFORMATION

Advise the patient to read the FDA-approved patient labeling (Patient Information and Instructions for Use).

Advise patients of the following risks and potential risks with NYVEPRIA:

- Splenic rupture and splenomegaly
- Acute Respiratory Distress Syndrome
- Serious allergic reactions
- Sickle cell crisis
- Glomerulonephritis

- Capillary Leak Syndrome
- Aortitis

Instruct patients who self-administer NYVEPRIA using the single-dose prefilled syringe of the:

- Importance of following the Instructions for Use.
- Dangers of reusing syringes.
- Importance of following local requirements for proper disposal of used syringes.

This product's label may have been updated. For full prescribing information, please visit www.pfizer.com.

Manufactured by
Hospira, Inc., a Pfizer Company,
Lake Forest, IL 60045 USA
US License No. 1974



Distributed by Pfizer Labs, division of Pfizer Inc., New York, NY 10017 USA

BD UltraSafe Plus is a trademark of Becton Dickinson and Company.

LAB-1186-1.0

Patient Information
NYVEPRIA™ (Nigh-VEP ree-ah)
(pegfilgrastim-apgf)
injection
Single-Dose Prefilled Syringe

What is NYVEPRIA?

NYVEPRIA is a man-made form of granulocyte colony-stimulating factor (G-CSF). G-CSF is a substance produced by the body. It stimulates the growth of neutrophils, a type of white blood cell important in the body's fight against infection.

Do not take NYVEPRIA if you have had a serious allergic reaction to pegfilgrastim products or filgrastim products.

Before you receive NYVEPRIA, tell your healthcare provider about all of your medical conditions, including if you:

- have a sickle cell disorder.
- have kidney problems.
- are pregnant or plan to become pregnant. It is not known if NYVEPRIA will harm your unborn baby.
- are breastfeeding or plan to breastfeed. It is not known if NYVEPRIA passes into your breast milk.

Tell your healthcare provider about all of the medicines you take, including prescription and over-the-counter medicines, vitamins, and herbal supplements.

How will I receive NYVEPRIA?

- **NYVEPRIA is given as an injection under your skin (subcutaneous injection) by a healthcare provider. If your healthcare provider decides that the subcutaneous injections can be given at home by you or your caregiver, follow the detailed “Instructions for Use” that comes with your NYVEPRIA for information on how to prepare and inject a dose of NYVEPRIA.**
- You and your caregiver will be shown how to prepare and inject NYVEPRIA before you use it.
- You should not inject a dose of NYVEPRIA to children weighing less than 45 kg from a NYVEPRIA prefilled syringe. A dose less than 0.6 mL (6 mg) cannot be accurately measured using the NYVEPRIA prefilled syringe.
- If you are receiving NYVEPRIA because you are also receiving chemotherapy, the last dose of NYVEPRIA should be injected at least 14 days before and 24 hours after your dose of chemotherapy.
- If you miss a dose of NYVEPRIA, talk to your healthcare provider about when you should give your next dose.

What are possible side effects of NYVEPRIA?

NYVEPRIA may cause serious side effects, including:

- **Spleen rupture.** Your spleen may become enlarged and can rupture. A ruptured spleen can cause death. Call your healthcare provider right away if you have pain in the left upper stomach area or your left shoulder.
- **A serious lung problem called Acute Respiratory Distress Syndrome (ARDS).** Call your healthcare provider or get emergency help right away if you have shortness of breath with or without a fever, trouble breathing, or a fast rate of breathing.
- **Serious allergic reactions.** NYVEPRIA can cause serious allergic reactions. These reactions can cause a rash over your whole body, shortness of breath, wheezing, dizziness, swelling around your mouth or eyes, fast heart rate, and sweating. If you have any of these symptoms, stop using NYVEPRIA and call your healthcare provider or get emergency medical help right away.
- **Sickle cell crises.** You may have a serious sickle cell crisis, which could lead to death, if you have a sickle cell disorder and receive NYVEPRIA. Call your healthcare provider right away if you have symptoms of sickle cell crisis such as pain or difficulty breathing.
- **Kidney injury (glomerulonephritis).** NYVEPRIA can cause kidney injury. Call your healthcare provider right away if you develop any of the following symptoms:
 - swelling of your face or ankles
 - blood in your urine or dark colored urine
 - you urinate less than usual
- **Increased white blood cell count (leukocytosis).** Your healthcare provider will check your blood during treatment with NYVEPRIA.
- **Capillary Leak Syndrome.** NYVEPRIA can cause fluid to leak from blood vessels into your body's tissues. This condition is called “Capillary Leak Syndrome” (CLS). CLS can quickly cause you to have symptoms that may become life-threatening. Get emergency medical help right away if you develop any of the following symptoms:

- swelling or puffiness and are urinating less than usual
 - trouble breathing
 - swelling of your stomach area (abdomen) and feeling of fullness
 - dizziness or feeling faint
 - a general feeling of tiredness
 - **Inflammation of the aorta (aortitis).** Inflammation of the aorta (the large blood vessel which transports blood from the heart to the body) has been reported in patients who received pegfilgrastim products. Symptoms may include fever, abdominal pain, feeling tired, and back pain. Call your healthcare provider if you experience these symptoms.
- The most common side effects of NYVEPRIA are pain in the bones, arms, and legs. These are not all the possible side effects of NYVEPRIA. Call your healthcare provider for medical advice about side effects. You may report side effects to FDA at 1-800-FDA-1088.

- How should I store NYVEPRIA?**
- Store NYVEPRIA in the refrigerator between 36°F to 46°F (2°C to 8°C).
 - **Do not** freeze. If NYVEPRIA is accidentally frozen, allow the prefilled syringe to thaw in the refrigerator before injecting.
 - **Do not** use a NYVEPRIA prefilled syringe that has been frozen more than 1 time. Use a new NYVEPRIA prefilled syringe.
 - Keep the prefilled syringe in the original carton to protect from light or physical damage.
 - Do not shake the prefilled syringe.
 - Take NYVEPRIA out of the refrigerator 30 minutes before use and allow it to reach room temperature before preparing an injection.
 - Throw away (dispose of) any NYVEPRIA that has been left at room temperature, 68°F to 77°F (20°C to 25°C), for more than 15 days.
- Keep the NYVEPRIA prefilled syringe out of the reach of children.**

General information about the safe and effective use of NYVEPRIA.
 Medicines are sometimes prescribed for purposes other than those listed in a Patient Information leaflet. Do not use NYVEPRIA for a condition for which it was not prescribed. Do not give NYVEPRIA to other people, even if they have the same symptoms that you have. It may harm them. You can ask your pharmacist or healthcare provider for information about NYVEPRIA that is written for health professionals.

What are the ingredients in NYVEPRIA?
 Active ingredient: pegfilgrastim-apgf.
 Inactive ingredients: acetate, polysorbate 20, sodium, and sorbitol in water for injection.

Manufactured by Hospira, Inc., a Pfizer Company, Lake Forest, IL 60045 USA
 US License No. 1974
 Distributed by Pfizer Labs, division of Pfizer Inc., New York, NY 10017 USA

LAB-1187-1.0
 For more information go to www.pfizer.com or call 1-800-438-1985.



This Patient Information has been approved by the U.S. Food and Drug Administration. Issued: June 2020

Instructions for Use
NYVEPRIA (Nigh-VEP ree-ah)
(pegfilgrastim-apgf)
Injection, for subcutaneous use
Single-Dose Prefilled Syringe

Guide to parts

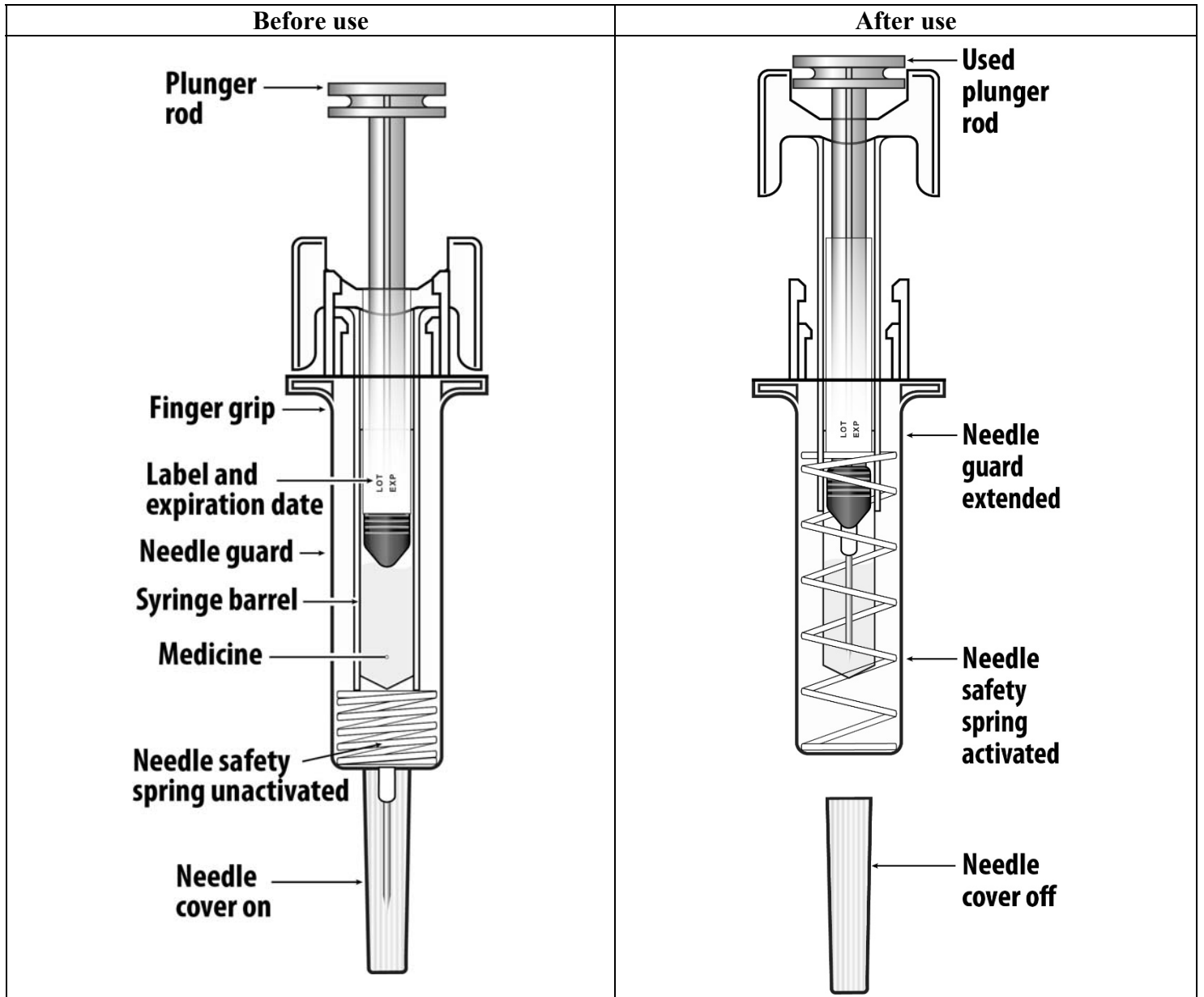

Important: The needle is covered by the needle cover before use.

Important

Read the Patient Information for important information that you need to know about NYVEPRIA before using these Instructions for Use.

Before you use a NYVEPRIA prefilled syringe, read this important information.

Storing the prefilled syringe

- Store NYVEPRIA in the refrigerator between 36°F to 46°F (2°C to 8°C).
- **Do not** freeze. If NYVEPRIA is accidentally frozen, allow the prefilled syringe to thaw in the refrigerator before injecting.
- **Do not** use a NYVEPRIA prefilled syringe that has been frozen more than 1 time. Use a new NYVEPRIA prefilled syringe.
- Keep the prefilled syringe in the original carton to protect from light or physical damage.
- Take the prefilled syringe out of the refrigerator 30 minutes before use and allow it to reach room temperature before preparing an injection.
- Throw away (dispose of) any NYVEPRIA that has been left at room temperature, 68°F to 77°F (20°C to 25°C), for more than 15 days.
- Keep the NYVEPRIA prefilled syringe out of the reach of children.

Using the prefilled syringe

- **It is important that you do not try to give the injection unless you or your caregiver has received training from your healthcare provider.**
- Make sure the name NYVEPRIA appears on the carton and prefilled syringe label.
- Check the carton and prefilled syringe label to make sure the dose strength is 6 mg/0.6 mL.
- You should not inject a dose of NYVEPRIA to children weighing less than 45 kg from a NYVEPRIA prefilled syringe. A dose less than 0.6 mL (6 mg) cannot be accurately measured using the NYVEPRIA prefilled syringe.
- **Do not** use a prefilled syringe after the expiration date on the label.
- **Do not** shake the prefilled syringe.
- **Do not** remove the needle cover from the prefilled syringe until you are ready to inject.
- **Do not** use the prefilled syringe if the carton is open or damaged.
- **Do not** use a prefilled syringe if it has been dropped on a hard surface. The prefilled syringe may be broken even if you cannot see the break. Use a new prefilled syringe.
- The prefilled syringe has a needle guard that automatically activates to cover the needle after the injection is given. **Do not** use a prefilled syringe if the needle guard has been activated. Use another prefilled syringe that has not been activated and is ready to use.

Call your healthcare provider if you have any questions.

Step 1: Prepare

A. Remove the prefilled syringe carton from the refrigerator.

Remove the inner carton containing the prefilled syringe from the outer carton by peeling away the cover. On a clean, well-lit surface, place the inner carton containing the prefilled syringe at room temperature for **30 minutes** before you give an injection.

- **Do not** use the prefilled syringe if the inner carton containing the prefilled syringe is damaged.
- **Do not** try to warm the prefilled syringe by using a heat source such as hot water or microwave.
- **Do not** leave the prefilled syringe in direct sunlight.
- **Do not** shake the prefilled syringe.

Open the inner carton containing the prefilled syringe by peeling away the cover. Grab the needle guard to remove the prefilled syringe from the inner carton containing the prefilled syringe.

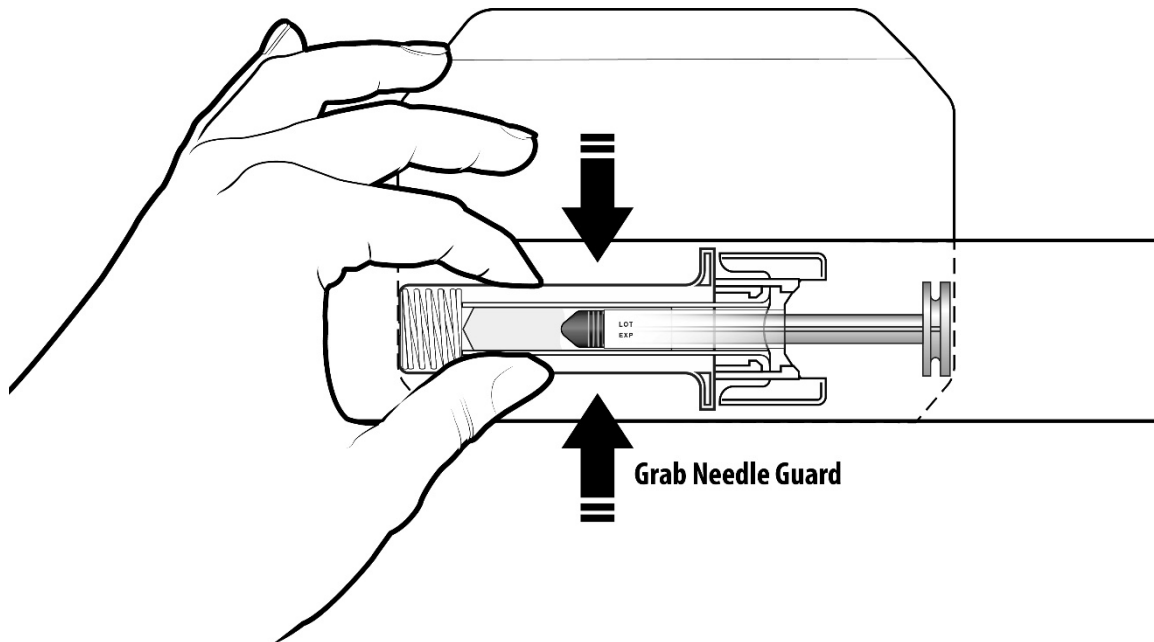

For safety reasons:

- **Do not** grab the plunger rod.
- **Do not** grab the needle cover.

B. Inspect the medicine and prefilled syringe.

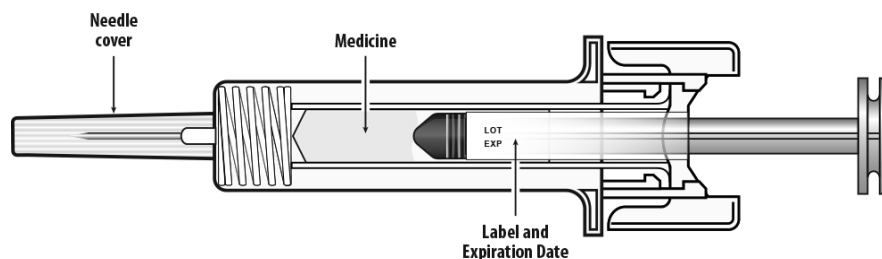

Make sure the medicine in the prefilled syringe is clear and colorless.

- **Do not** use the prefilled syringe if:
 - The medicine is cloudy or discolored, or contains flakes or particles.
 - Any part appears cracked or broken.
 - The prefilled syringe has been dropped.
 - The needle cover is missing or not securely attached.
 - The expiration date printed on the label has passed.

In all cases, use a new prefilled syringe and call your healthcare provider.

C. Gather all materials needed for the injection.

Wash your hands thoroughly with soap and water.

On a clean, well-lit work surface, place the:

- Prefilled syringe
- Alcohol wipe
- Cotton ball or gauze pad
- Adhesive bandage
- Sharps disposal container

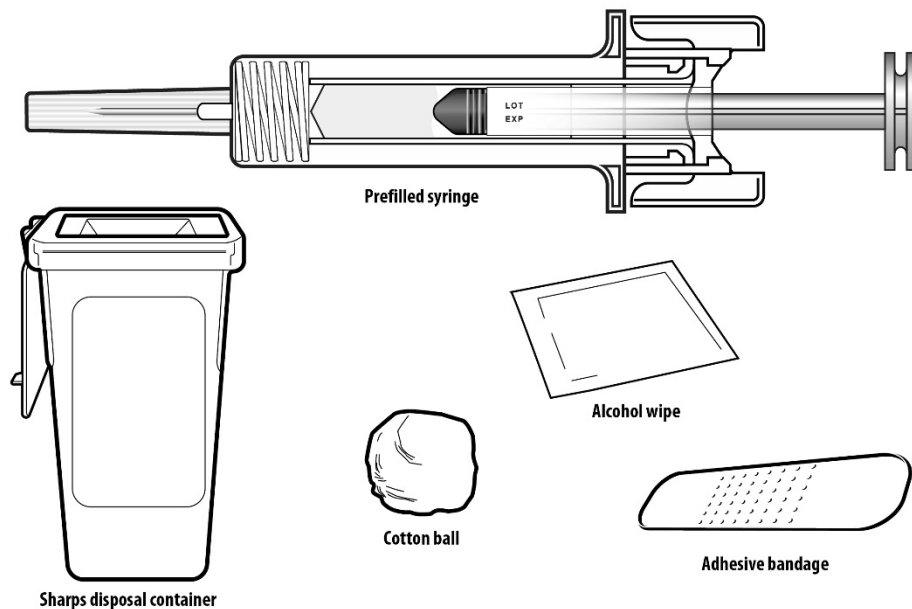

Step 2: Get ready

D. Prepare and clean the injection site(s).

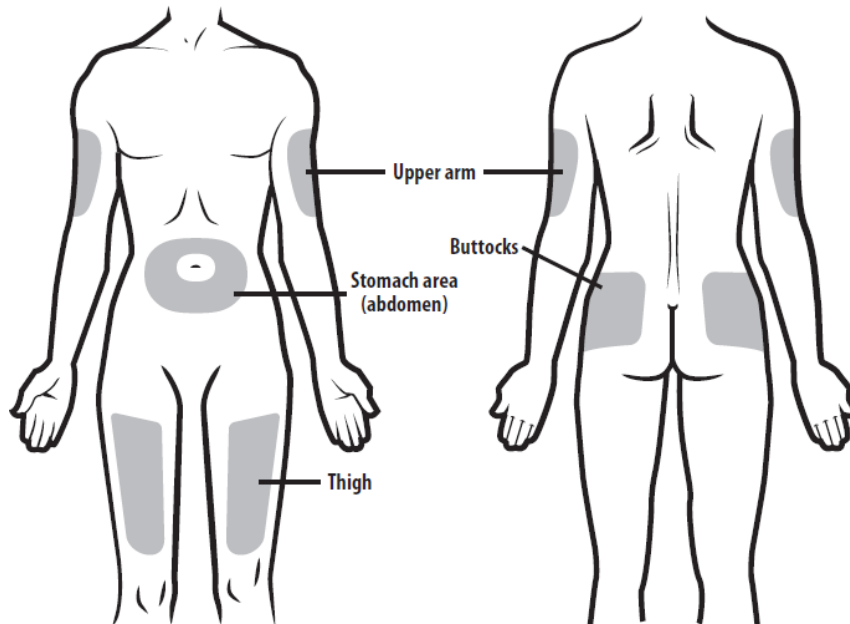

You can use:

- Thigh
- Stomach area (abdomen), except for a 2-inch area right around the navel (belly button)
- Upper outer area of the buttocks (only if someone else is giving you the injection)
- Outer area of upper arm (only if someone else is giving you the injection)

Clean the injection site with an alcohol wipe. Let the skin dry.

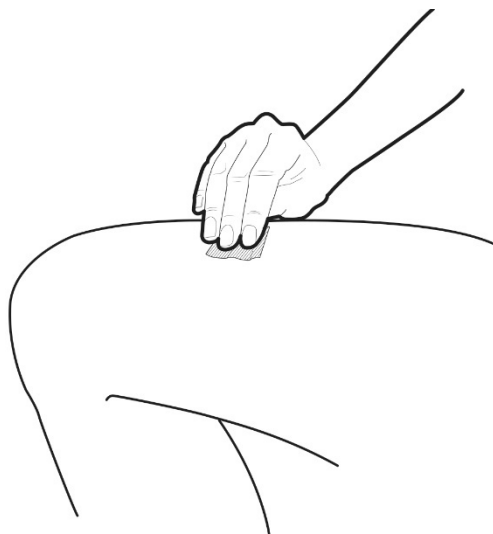

- **Do not** touch this area again before injecting.
- If you want to use the same injection site, make sure it is not the same spot on the injection site you used for a previous injection.
- **Do not** inject into areas where the skin is tender, bruised, red or hard. Avoid injecting into areas with scars or stretch marks.

E. Hold the prefilled syringe by the needle guard. Carefully pull the needle cover straight off and away from the body. **Do not** recap.

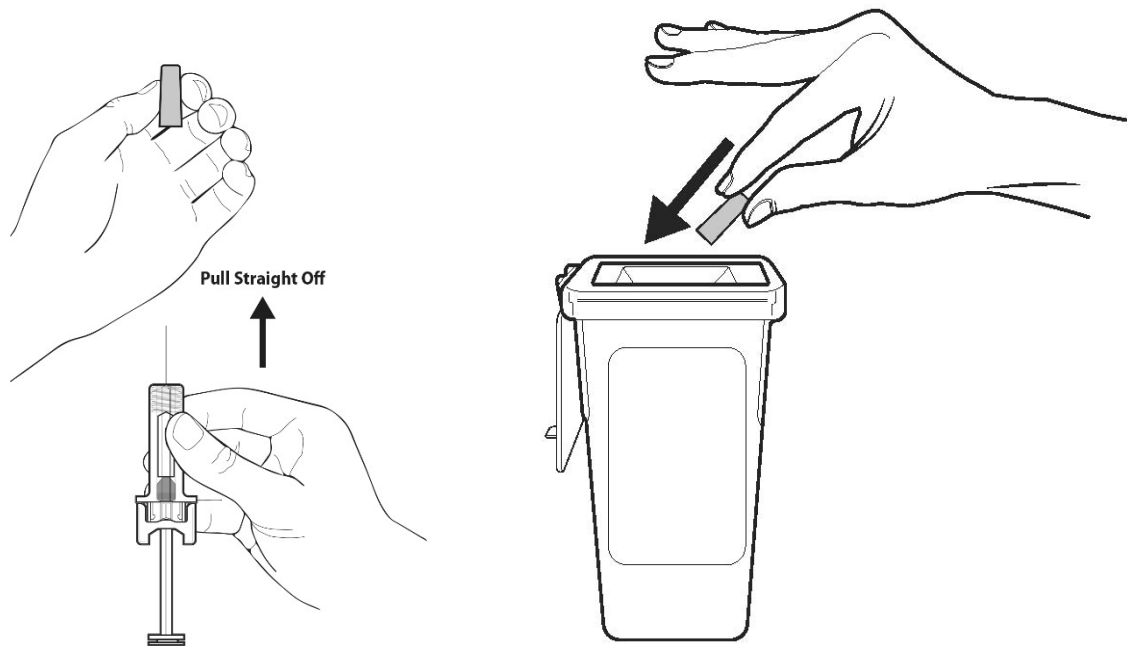

- **Do not** remove the needle cover from the prefilled syringe until you are ready to inject.
- **Do not** twist or bend the needle cover.
- **Do not** hold the prefilled syringe by the plunger rod.
- **Do not** put the needle cover back onto the prefilled syringe.

Important: Throw the needle cover into the sharps disposal container.

Step 3: Subcutaneous (under the skin) injection

F. Pinch the injection site to create a firm surface.



Important: Keep skin pinched while injecting.

G. Hold the pinch. Insert the needle into the skin at 45 to 90 degrees.

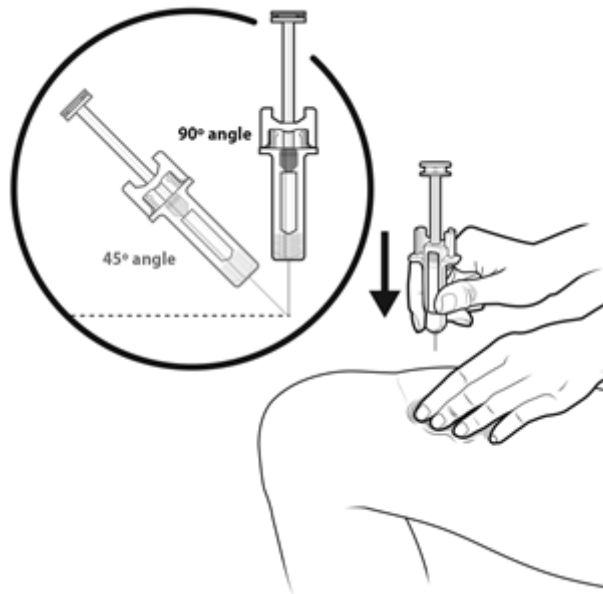

H. Using slow and constant pressure, push the plunger rod down until it reaches the bottom.



Step 4: Finish

I. When the syringe is empty, keep the plunger rod fully pressed down while you carefully pull the needle straight out from the injection site and off your skin.

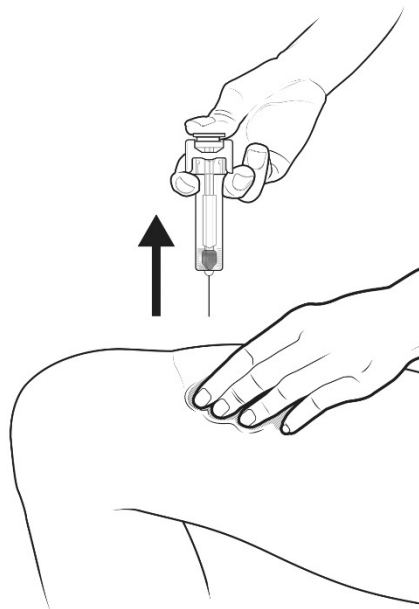

J. Slowly release the plunger rod and allow the syringe needle guard to automatically cover the exposed needle. **Do not recap the needle.**

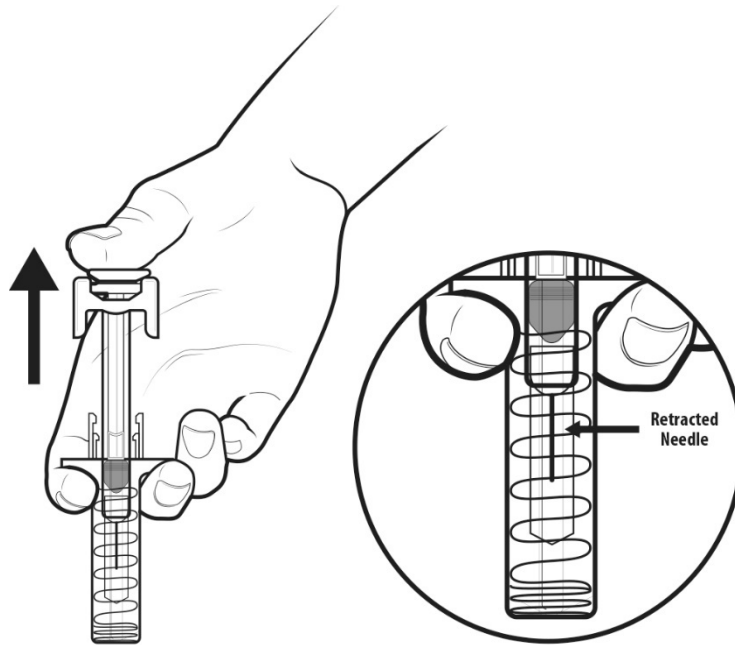

Important: When you remove the syringe, if it looks like the medicine is still in the syringe barrel, this means you have not received a full dose. Call your healthcare provider right away.

K. Examine the injection site.

If there is blood, press a cotton ball or gauze pad on the injection site. **Do not** rub the injection site. Apply an adhesive bandage if needed.

L. Discard (throw away) the used prefilled syringe.

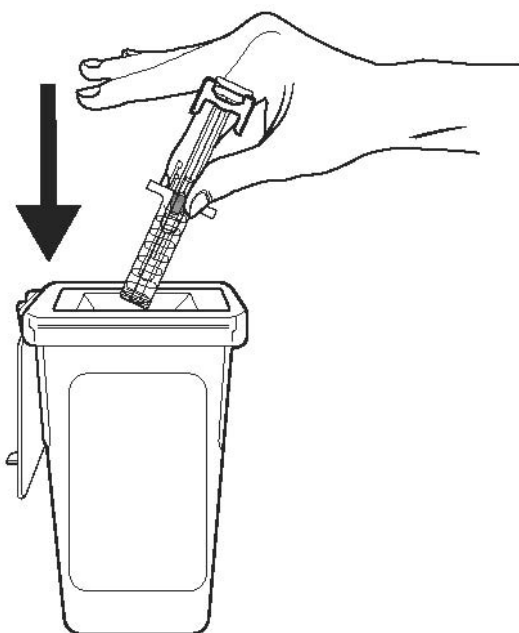

- Put the used prefilled syringe in a FDA-cleared sharps disposal container right away after use. **Do not** throw away (dispose of) the syringe in your household trash.
- If you do not have a FDA-cleared sharps disposal container, you may use a household container that is:
 - made of a heavy-duty plastic,
 - can be closed with a tight-fitting, puncture-resistant lid, without sharps being able to come out,
 - upright and stable during use,
 - leak-resistant, and
 - properly labeled to warn of hazardous waste inside the container.
- When your sharps disposal container is almost full, you will need to follow your community guidelines for the right way to dispose of your sharps disposal container. There may be state or local laws about how you should throw away used needles and syringes. For more information about safe sharps disposal, and for specific information about sharps disposal in the state that you live in, go to the FDA's website at: <http://www.fda.gov/safesharpsdisposal>.
- **Do not** reuse the prefilled syringe.
- **Do not** recycle the prefilled syringe or sharps disposal container or throw them in the household trash.

Important: Always keep the sharps disposal container out of the reach of children.

This Instructions for Use has been approved by the U.S. Food and Drug Administration.

Manufactured by
Hospira, Inc., a Pfizer Company,
Lake Forest, IL 60045 USA
US License No. 1974

Distributed by Pfizer Labs, division of Pfizer Inc., New York, NY 10017 USA



For more information go to www.pfizer.com or call 1-800-438-1985.

LAB-1188-1.0

Issued: June 2020