

LungFit[®] PH System Operator's Manual





Operator Assistance Information

Manufacturer: Beyond Air Inc.
900 Stewart Avenue
Suite 301,
Garden City, NY
USA 11530
Ph: 1-(855)-LUN-GFLX (1-855-586-4359)

Website: www.beyondair.net

For clinical and technical support, contact your local Beyond Air Inc. representative.

CAUTION: US Federal and Canadian law restrict this device to sale by or on the order of a licensed medical practitioner. Outside the USA and Canada, check local laws for any restrictions that may apply.

Contents

Operator Assistance Information	2
1. USER RESPONSIBILITY	6
2. DEFINITIONS	6
3. WARNINGS AND CAUTIONS	7
4. ABBREVIATIONS	11
5. INTENDED USE	12
6. CONTRAINDICATION	12
7. HOW SUPPLIED	12
8. SYMBOLS USED IN THIS MANUAL OR ON THE DEVICE	12
9. PRODUCT DESCRIPTION	16
9.1 NO Generator and NO ₂ Filters	19
9.2 Nitric Oxide Delivery Module (NDM)	21
9.3 Gas Sampling and Monitoring System	23
9.4 The Nitric Oxide Backup and Bagging System	27
9.5. Automatic Purge Cycles	30
9.6. Battery	30
10. LUNGFIT PH SYSTEM SETUP	31
10.1 Nitric Oxide Delivery Module (NDM) Assembly	31
10.2 Gas Sample Line setup	37
10.3 LungFit PH Startup	37
10.4 Verification Check	39
10.5 Monthly Procedures	40
11. USING THE DEVICE	41
11.1 Setting up the ventilator circuit	41
11.2 Begin NO Therapy	44
11.3 Changing an NO ₂ Filter	45
11.4 Adjusting Alarms	53
11.5 Adjusting NO Concentration	54
11.6 Pausing Therapy	55
11.7 Adjusting time and date	56
11.8 Backup Delivery Menu Page	57
11.9 Alarm History	58
11.10 Brightness Adjustment	59
11.11 Information Screen	60
11.12 Maintenance	60
11.13. Changing components during use	61
12. USING THE BAGGING SYSTEM NO/O ₂ OUTLET	62
13. USING THE BACKUP NO SYSTEM	65
14. COMPLETING THERAPY	67
15. REMOVING THE LUNGFIT PH SYSTEM FROM THE CART	68

16. GAS MONITOR CALIBRATION PROCEDURE	69
16.1 Zero NO, NO ₂ , and O ₂ Sensors	69
16.2 Calibrate NO Sensor.....	70
16.3 Calibrate NO ₂ Sensor	71
16.4 Calibrate O ₂ Sensor	72
16.5 Sensor Replacement.....	72
17. ALARMS	73
18. TROUBLESHOOTING GUIDE.....	75
18.1. Common Problems Encountered.....	91
19. COMPATIBLE VENTILATORS.....	92
19.1. Ventilator List	92
19.2. Ventilator Specification Window.....	92
19.3. Device Effects on Ventilator.....	93
20. CLEANING AND REPROCESSING	94
20.1. Cleaning during use	94
20.2. Reprocessing between uses.....	94
20.3. Approved cleaning and bactericidal agents.....	94
21. SPECIFICATIONS.....	96
21.1. Nitric Oxide Delivery Specifications	96
21.2. Analyzer and Sensor Specifications	96
21.3. Flow Sensor	97
21.4. Oxygen Monitor	97
21.5. Physical	97
21.6. Battery	97
21.7. Environmental.....	97
21.8. Electrical	98
21.9. User Applied Parts	98
22. ELECTROMAGNETIC COMPATIBILITY INFORMATION	99
23. OCCUPATIONAL EXPOSURE	102
24. INDICATIONS FOR USE.....	102
25. CONTRAINDICATIONS.....	102
26. DOSAGE AND ADMINISTRATION	103
26.1. Dosage.....	103
26.2. Administration	103
27. WARNINGS AND PRECAUTIONS ASSOCIATED WITH NITRIC OXIDE (NO).....	103
27.1. Rebound Pulmonary Hypertension Syndrome following Abrupt Discontinuation.....	103
27.2. Hypoxemia from Methemoglobinemia.....	104
27.3. Airway Injury from Nitrogen Dioxide	104
27.4. Worsening Heart Failure.....	104
28. ADVERSE EVENTS	104
28.1. Clinical Trials Experience.....	104



28.2. Post-Marketing Experience.....	105
29. DRUG INTERACTIONS	105
30. USE IN SPECIFIC POPULATIONS.....	105
30.1. Pregnancy.....	105
30.2. Nursing Mothers	106
30.3. Pediatric Use	106
30.4. Geriatric Use	106
31. OVERDOSAGE.....	106
32. DESCRIPTION.....	106
33. CLINICAL PHARMACOLOGY	106
33.1. Mechanism of Action.....	106
33.2. Pharmacodynamics	107
33.3. Pharmacokinetics	107
34. NONCLINICAL TOXICOLOGY	108
34.1. Carcinogenesis, Mutagenesis, Impairment of Fertility	108
35. CLINICAL STUDIES.....	108
35.1. Treatment of Hypoxic Respiratory Failure (HRF).....	108
35.2. Ineffective in Adult Respiratory Distress Syndrome (ARDS)	110
35.3. Ineffective in Prevention of Bronchopulmonary Dysplasia (BPD)	111



1. USER RESPONSIBILITY

The LungFit PH System performs in line with the description detailed in this user manual and accompanying labels and/or guides when assembled, operated, maintained, repaired, and stored in accordance with the instructions provided.

The device must be checked prior to use in accordance with the procedures outlined in this manual. A damaged device should not be used; contact Beyond Air immediately for a replacement device (1-855-LUN-GFLX (1-855-586-4359)).

The user of this device is solely responsible for any malfunction resulting from improper use, faulty maintenance, improper repair, damage, or alteration by any source not authorized by Beyond Air Inc.

For technical support, contact Beyond Air at 1-855-LUN-GFLX (1-855-586-4359).

2. DEFINITIONS

- **Warning(s)** – alert the operator to possible injury, death, or other serious adverse reactions associated with the use or misuse of the device.
- **Caution(s)** – information regarding any special care to be exercised by the user for safe and effective use of the device.
- **Contraindication(s)** – alert the operator to possible situations or conditions that the device should not be used because the risk of use outweighs any possible benefit.

3. WARNINGS AND CAUTIONS



WARNING: A non-expired NO₂ Filter must be properly installed at all times for the LungFit PH System to function.

- Insert new filter as quickly as possible (within 15 seconds) to minimize interruption of NO treatment
- If the filter is not installed, there will be no nitric oxide delivered through the **NO Injector Line Outlet**
- The device will not start if the installed NO₂ Filter is past its designated usage time.
- The device will alarm (**Change NO₂ Filter**) if the installed NO₂ Filter is past its designated usage time.
- Always have at least one spare NO₂ Filter available



WARNING: Complete a Verification Check outlined in this manual at least once per month.



WARNING: The LungFit PH System sample line withdraws approximately 230 mL/minute of gas flow from the ventilator breathing circuit. Flow sensitivity adjustment on the ventilator may be necessary to prevent auto-cycling of the ventilator (repetitive triggering of a mechanical breath).



WARNING: Place the gas sample line on the breathing circuit inspiratory limb and close to the patient connection (approximately 6 inches from patient wye, and at least 18 inches downstream from the NDM) to accurately measure the inhaled NO, NO₂ and O₂.



WARNING: Persons using the LungFit PH System should be trained and experienced in its use before performing procedures described in this manual to assure effective administration of nitric oxide and to avoid injury to the patient or to others resulting from inhalation of excess nitric oxide, nitrogen dioxide, or other reaction products.



WARNING: The LungFit PH System operating manual should be kept with the device at all times to answer questions or concerns that may arise.



WARNING: Only use the sample line with hydrophobic filter provided by Beyond Air.



WARNING: Ensure the NO, NO₂, and O₂ alarms are set to acceptable limits when delivering NO to a patient.



WARNING: Follow all local, state, and federal regulations with respect to environmental protection when disposing of batteries and electrochemical sensors.



WARNING: Always have an independent back up NO delivery system available close at hand as a contingency in the event the LungFit PH System becomes inoperative during a NO therapy session.



WARNING: Adjustments to FiO₂ may be required when administering nitric oxide gas as the FiO₂ delivered to the patient may change due to the dilution effect of the NO gas.



WARNING: Do not place containers of liquid of any type on top of or near this device. Liquid spilt in or on the device can cause equipment malfunction and damage.



WARNING: Avoid abrupt discontinuation of NO. To wean NO down, titrate in several steps, pausing several hours at each step to monitor for hypoxemia.



WARNING: Abrupt discontinuation of NO may lead to worsening oxygenation and increasing pulmonary artery pressure, i.e., Rebound Pulmonary Hypertension Syndrome. Signs and symptoms of Rebound Pulmonary Hypertension Syndrome include hypoxemia, systemic hypotension, bradycardia, and decreased cardiac output. If Rebound Pulmonary Hypertension occurs, reinstate NO therapy immediately.



WARNING: To avoid the risk of electric shock, this equipment must only be connected to a supply main with protective earth.



WARNING: Do not make unauthorized changes to the device as it can result in harm to the patient.



WARNING: The Backup NO System introduces a fixed flow (1 L/min) and NO concentration (220 ppm) through the injector line into the NDM. The final delivered concentration will depend on the ventilator circuit flow.

- When using the integrated backup with breathing circuit gas flows of 5 L/min, the delivered NO dose will be approximately 40 ppm. Breathing circuit gas flows less than 5 L/min will deliver an NO dose greater than 40 ppm.
- **The Backup NO System is intended for short term use when the main NO delivery system fails. Use only until a replacement NO system can be placed in use.**
- An NO₂ Filter must be installed when using the Backup NO System
- The Backup NO System delivers a variable concentration of NO to the patient that depends on the ventilator flow used.



WARNING: Do not use the device if visibly damaged; contact Beyond Air for replacement device.



WARNING: If NO₂ ≥ 3 ppm, the delivery system should be assessed in accordance with the Troubleshooting Guide (Section 18).



WARNING: Use the device in a well-ventilated area.



WARNING: LungFit PH is MR Unsafe.



WARNING: Always keep at least one spare NDM kit on hand.



WARNING: Warning: The LungFit PH adds flow to the ventilator flow when NO is set greater than zero ppm (see Section 18.3 for details). Only use ventilators validated with the LungFit PH, and only those modes listed as confirmed compatible. Additionally, confirm stable patient ventilation and oxygenation with an arterial blood gas after initiation or removal of NO therapy with the LungFit PH.



CAUTION: Condensing humidity will impair the function of the sensors. In the unlikely event that the sensor(s) gets wet, turn the unit on and sample room air to allow the analysis module to dry out. Once dry, the sensors will function normally.



CAUTION:

- DO NOT sterilize.
- DO NOT clean any parts with acetone or other strong solvents.
- DO NOT immerse or allow water or any other liquid to enter the device or housings.



CAUTION: Calibrate the sensors at least once a month, or more frequently if needed, to ensure the device monitors the gases in the breathing circuit correctly.



CAUTION: Single use items to be used on one patient only



CAUTION: To maintain the LungFit PH batteries in a charged state, keep the system plugged in between uses.



CAUTION: NO can be administered during the sensor calibration process. However, inspired gasses are not monitored, and gas monitoring alarms are disabled.



CAUTION: Aerosolized medications delivered before the sample tee may clog and obstruct the sample line filter and trigger a low sample flow.

4. ABBREVIATIONS

bpm	Breaths per minute
cmH₂O	Centimeters of water
FiO₂	Fraction of inspired gaseous oxygen
HFOV	High Frequency Oscillatory Ventilators
L/min	Liters per minute
mL	Milliliters
mL/min	Milliliters per minute
mmHg	Millimeters of mercury
NDM	Nitric oxide Delivery Module
NO	Nitric Oxide
NO₂	Nitrogen Dioxide
O₂	Oxygen
PaO₂	Arterial Oxygen Partial Pressure
ppm	parts per million

5. INTENDED USE

The LungFit[®] PH is intended to deliver nitric oxide (NO), a vasodilator, generated by the device into the inspiratory limb of the patient breathing circuit of a ventilator in a way that provides a constant concentration of nitric oxide, as set by the user, to the patient throughout the inspired breath.

The LungFit[®] PH provides continuous integrated monitoring of inspired oxygen (O₂), nitrogen dioxide (NO₂) and nitric oxide (NO), and a comprehensive alarm system.

The LungFit[®] PH includes an integrated backup NO delivery system that is a completely independent backup NO generating system; it has its own NO generator and gas flow delivery system. The backup flow is delivered at 1 L/min at 220ppm NO to either a ventilator circuit or to a bagging system, depending upon the user selected setting.

The NO from the LungFit PH System is indicated to improve oxygenation and reduce the need for extracorporeal membrane oxygenation in term and near-term (>34 weeks gestation) neonates with hypoxic respiratory failure associated with clinical or echocardiographic evidence of pulmonary hypertension in conjunction with ventilatory support and other appropriate agents.

6. CONTRAINDICATION









The NO from the LungFit PH is contraindicated in neonates dependent on right-to-left shunting of blood.







7. HOW SUPPLIED





Nitric oxide (NO) is generated by the LungFit PH from room air just prior to delivery into an attached breathing circuit.

8. SYMBOLS USED IN THIS MANUAL OR ON THE DEVICE

Symbol	Symbol Title	Reference Number	Description	Standard Title and Designation Number
	Warning		Alert the operator to possible injury, death, or other serious adverse reactions associated with the use or misuse of the device.	

Symbol	Symbol Title	Reference Number	Description	Standard Title and Designation Number
	Caution	ISO 7000-0434B	Information regarding any special care to be exercised by the user for safe and effective use of the device.	
	Type B Applied Part	5840	On medical equipment. To identify a type B applied part complying with IEC 60601-1. Note – B = Body	IEC/TR 60878 Graphical symbols for electrical equipment in medical practice.
	Bell Cancel (Alarm Silence)	5576	To identify the control whereby a bell may be switched off or to indicate the operating status of the bell.	IEC/TR 60878 Graphical symbols for electrical equipment in medical practice.
	Alarm Silence Activation Button	N/A	Button used to silence high priority alarms for 2 minutes.	N/A
	Equipotentiality	5021	To identify the terminals which, when connected together, bring the various parts of an equipment or of a system to the same potential, not necessarily being the earth (ground) potential, e.g., for local bonding.	IEC/TR 60878 Graphical symbols for electrical equipment in medical practice.
	Refer to Instruction Manual/Booklet	ISO 7010-M002	To signify that the instruction manual/booklet must be read.	IEC/TR 60878 Graphical symbols for electrical equipment in medical practice.
	Catalogue Number	5.1.6	Indicates the manufacturer's catalogue number so that the medical device can be identified.	ISO & ANSI/AAMI/ISO 15223-1 Medical devices – Symbols to be used with medical device labels – General requirements.
	Serial Number	5.1.7	Indicates the manufacturer's serial number so that a specific medical device can be identified.	ISO & ANSI/AAMI/ISO 15223-1 Medical devices – Symbols to be used with medical device labels – General requirements.

Symbol	Symbol Title	Reference Number	Description	Standard Title and Designation Number
	Batch Code	5.1.5	Indicates the manufacturer's batch code so that the batch or lot can be identified.	ISO & ANSI/AAMI/ISO 15223-1 Medical devices – Symbols to be used with medical device labels – General requirements.
	“OFF” (Power)	5008	To indicate disconnection from the mains, at least for mains switches or their positions, and all those cases where safety is involved.	IEC/TR 60878 Graphical symbols for electrical equipment in medical practice.
	“ON” (Power)	5007	To indicate connection to the mains, at least for mains switches or their positions, and all those cases where safety is involved.	IEC/TR 60878 Graphical symbols for electrical equipment in medical practice.
	Alternating Current	N/A	To indicate connection to alternating current.	IEC/TR 60878 Graphical symbols for electrical equipment in medical practice.
	Do Not Reuse	5.4.2	To indicate the item is for single use only and must not be used more than once, for example packages of medical disposables	ISO 15223-1: 2016 Reference No. 5.4.2 (ISO 7000 – 1051)
	Non-sterile Component	5.2.7	To indicate item has not been sterilized	ISO 15223-1:2016 Reference No. 5.2.7 (ISO 7000-2609)
	Consult Instructions for Use	5.4.3	Indicates the need for the user to consult the instructions for use	ISO 15223-1:2016 Reference No. 5.4.3 (ISO 7000-1641)

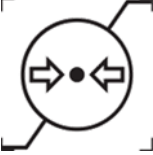
Symbol	Symbol Title	Reference Number	Description	Standard Title and Designation Number
	Date of manufacture	5.1.3	Indicates the date when the medical device was manufactured	ISO 15223- 1:2016 Reference no. 5.1.3. (ISO 7000-2497)
	Manufacturer	5.1.1	Indicates the medical device manufacturer	ISO 15223-1:2016 Reference No. 5.1.1 (ISO 7000-3082)
	Use-by Date	5.1.4	Indicates the date after which the medical device is not to be used	ISO 15223-1: 2016 Reference No. 5.1.4 (ISO 7000 – 2607)
	Temperature Limit	5.3.7	Indicates the temperature limits to which the medical device can be safely exposed	ISO 15223-1:2016 Reference No. 5.3.7 (ISO 7000-0632)
	Humidity Limitation	5.3.8	Indicates the range of humidity to which the medical device can be safely exposed	ISO 15223-1:2016 Reference No. 5.3.8 (ISO 7000-2620)
	Atmospheric Pressure Limitation	5.3.9	Indicates the range of atmospheric pressure to which the medical device can be safely exposed.	ISO 15223-1:2016 Reference No. 5.3.9 (ISO 7000-2621)
Rx Only	Prescription Use Only	N/A	Caution: Federal law restricts this device to sale by or on the order of a licensed medical practitioner.	21 CFR 801.109 Subpart D

Symbol	Symbol Title	Reference Number	Description	Standard Title and Designation Number
	MR Unsafe	N/A	Indicates an item which poses unacceptable risks to the patient, medical staff, or other persons within the MR environment.	ASTM F2503-20

9. PRODUCT DESCRIPTION

The LungFit PH System generates nitric oxide (NO) from room air and delivers it to a mechanical ventilator breathing circuit in a controlled concentration from 0.1 to 80 ppm NO. The attached nitric oxide delivery module (NDM) measures the gas flow in the ventilator breathing circuit and delivers a controlled flow of nitric oxide enriched gas into the breathing circuit. The device also incorporates a gas monitoring system (with user-set alarms) for measuring the gas concentrations of nitric oxide, nitrogen dioxide (NO₂) and oxygen (O₂) in the ventilator breathing circuit just prior to inhalation by the patient, via a sampling line.

The system is comprised of three sub-systems: The NO Generator with the NO₂ Filter, the Nitric Oxide Backup and Bagging System, and the Gas Sampling and Monitoring System. Figure 1 shows the LungFit PH system. Figure 2 shows the LungFit PH Delivery and Backup System Connectors. Figure 3 shows the back panel of the LungFit PH.

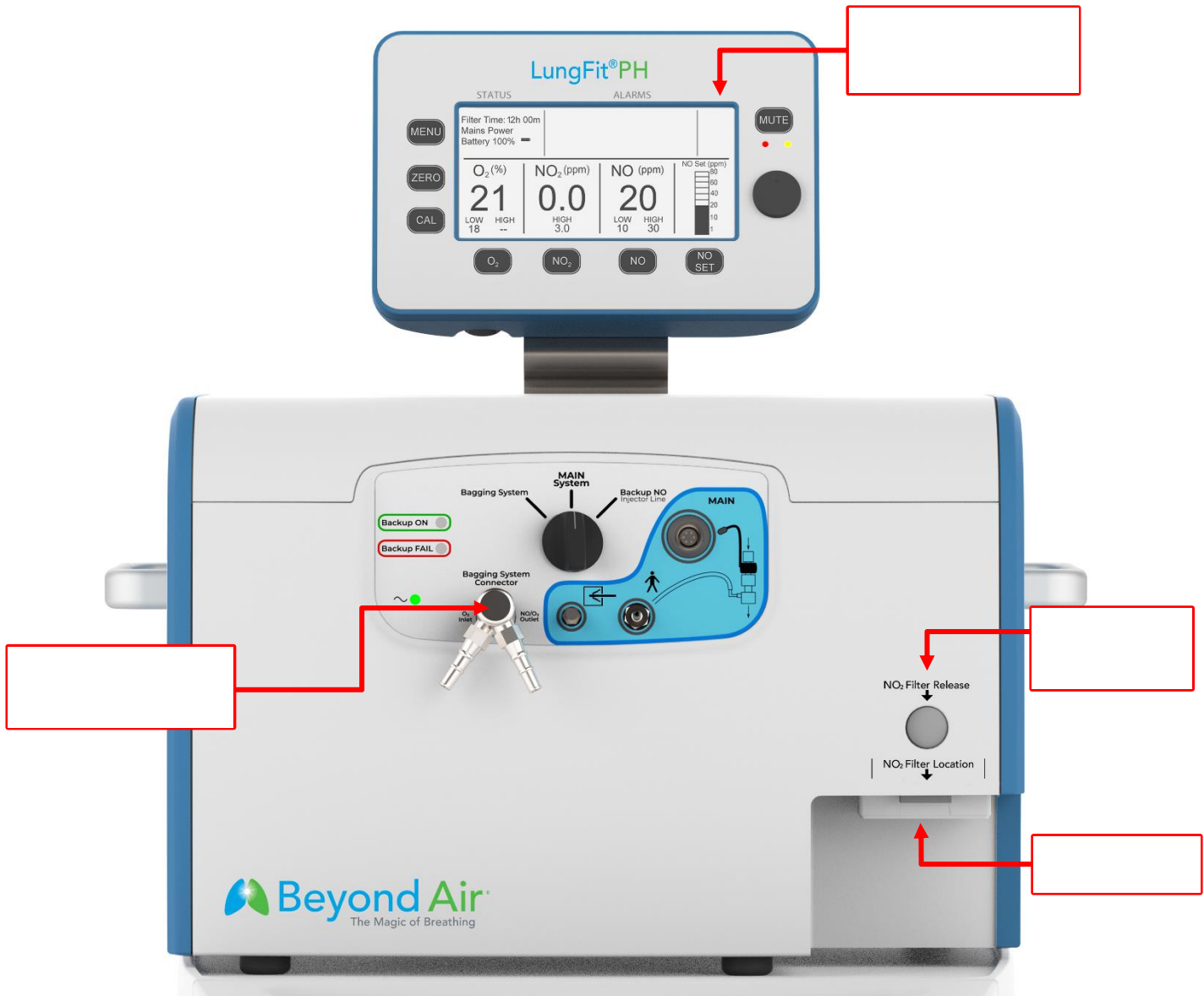

Figure 1: The LungFit PH System

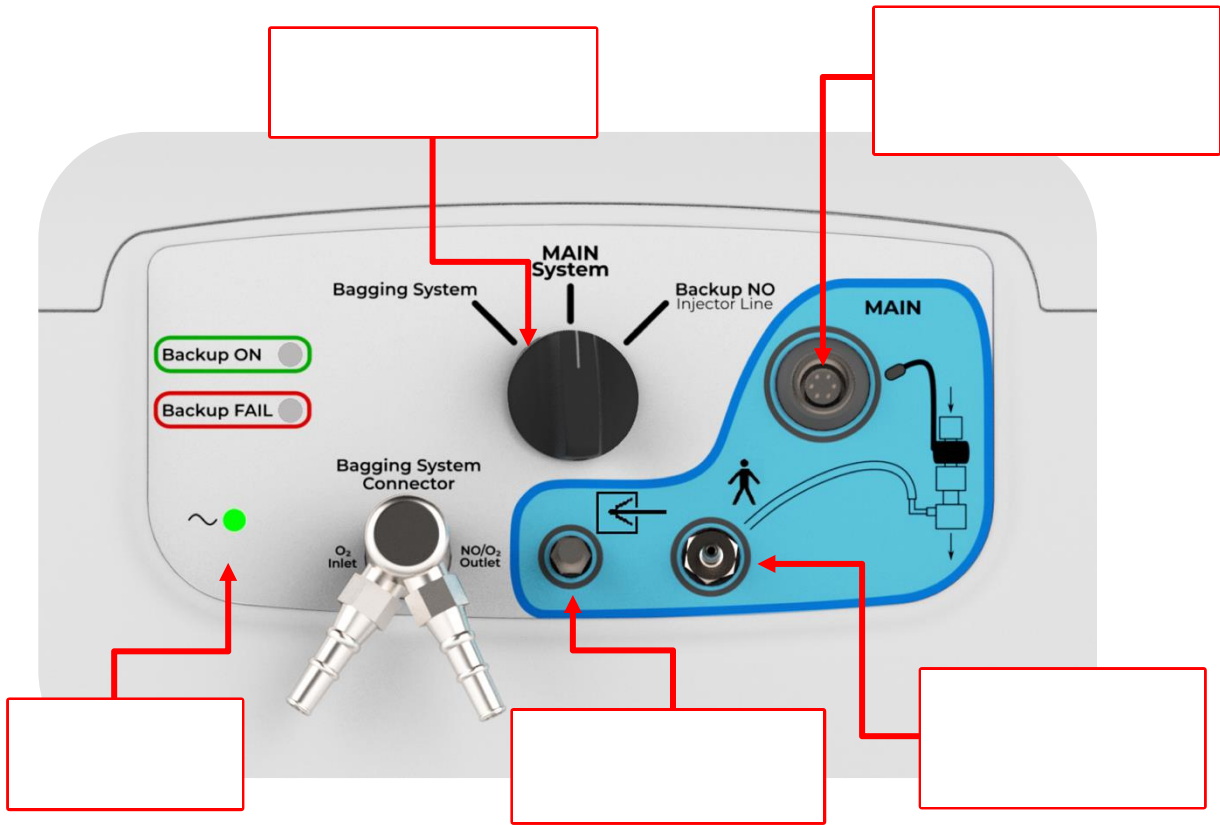

Figure 2: LungFit PH Delivery and Backup System Connectors

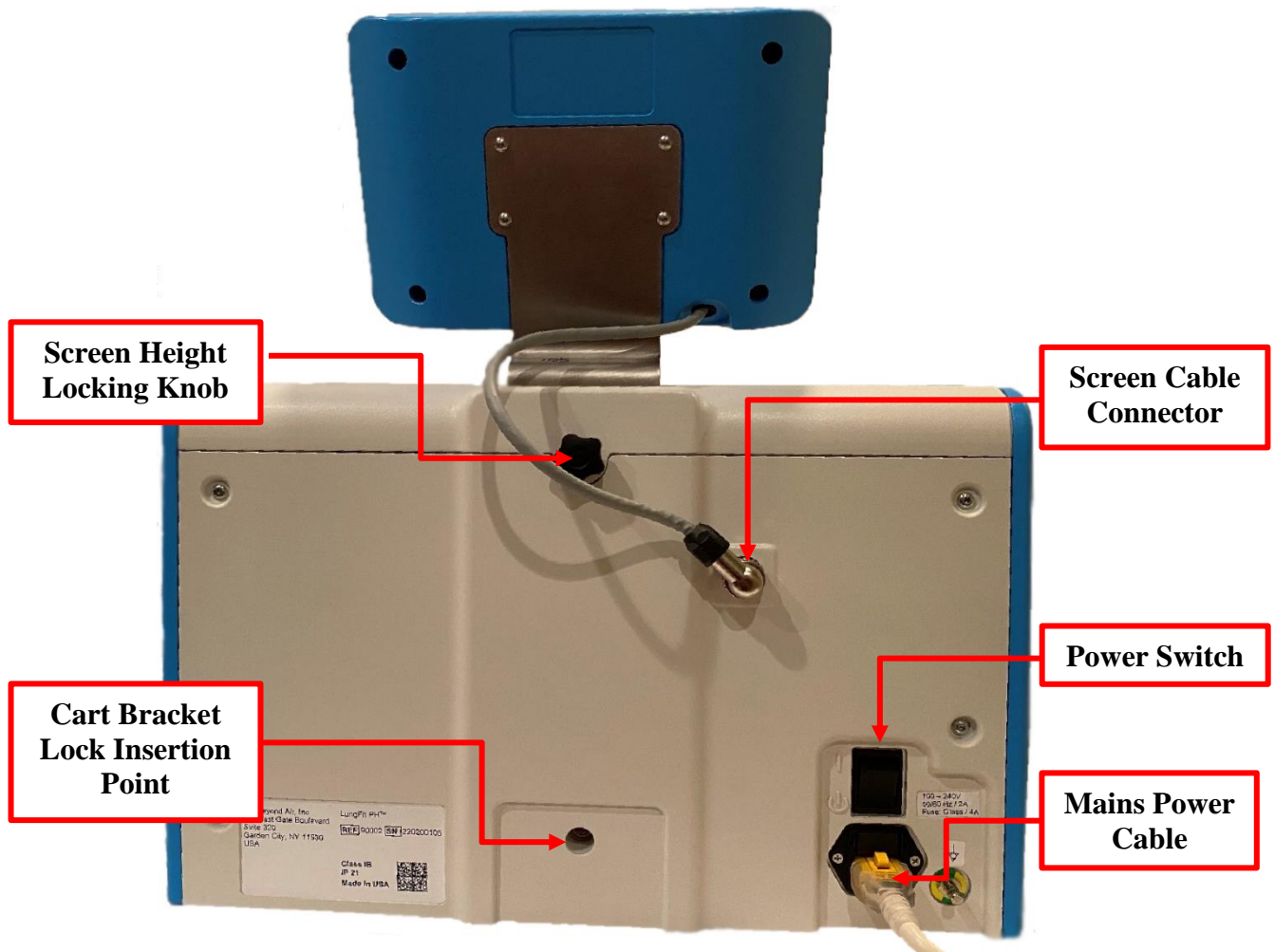

Figure 3: Back Panel of LungFit PH

9.1 NO Generator and NO₂ Filters

- **NO Generator**

The NO generator subsystem produces nitric oxide (NO) from the oxygen and nitrogen in ambient room air. Ambient air (containing approximately 21% oxygen and 79% nitrogen) for the NO generation is drawn into the device by a gas pump. This air is passed through a particulate filter (removing dust particles) and then to a flow meter that measures the air gas flow. The pump and the flow meter are connected to a micro-controller that ensures the required gas flow of air passes through the NO reaction chamber.

- **NO₂ Filter**

At the outlet of the NO generator is an NO₂ filter. Its function is to remove NO₂ from the NO-containing gas flow before it is delivered to the ventilatory circuit. Electronic circuitry in each filter is used to log filter usage to ensure it has not been depleted due to previous use. There is one 1-micron filter on the inlet of the filter and one on the outlet of the NO₂ filter.

A single filter will provide 12 hours of NO₂ filtering, regardless of NO concentration and ventilator settings.



Figure 4: LungFit PH NO₂ Filter



CAUTION: Replace and Dispose of filter after 12 hours of use.

9.2 Nitric Oxide Delivery Module (NDM)

The Nitric Oxide Delivery Module (NDM) (*see Figures 5 and 6*) measures gas flow in the ventilator breathing circuit (flow sensor) and delivers nitric oxide gas mixture into the inspiratory limb of the ventilator breathing circuit (injector line and adapter). The NDM is placed close to the ventilator gas outlet (at least 6 inches/15 cm from the ventilator inspiratory outlet and before the humidifier) to allow for proper mixing of nitric oxide enriched gas from the NDM with the ventilator delivered gas flow.

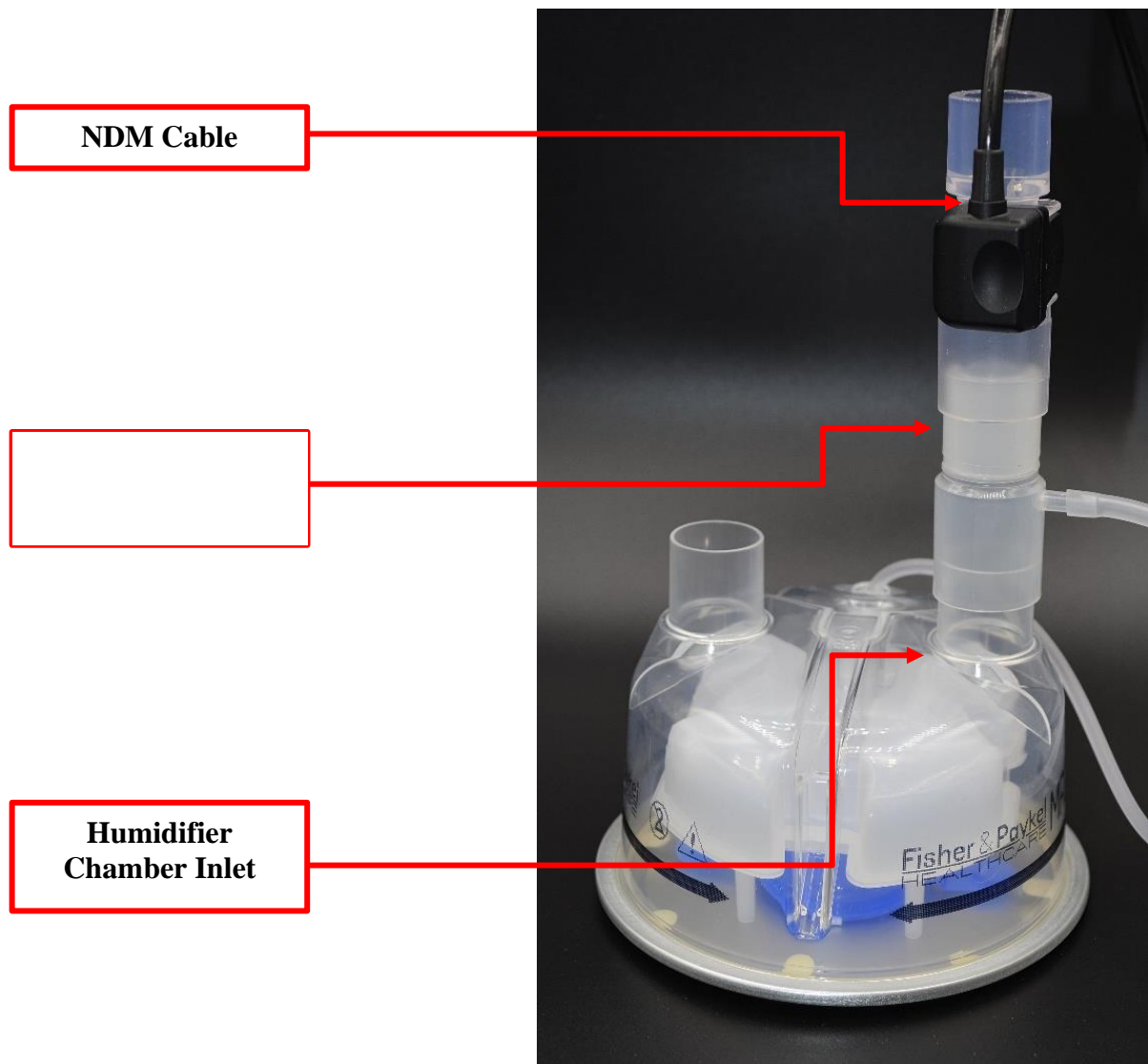

Figure 5: Nitric Oxide Delivery Module, with Cable and Injector Line, Attached to Humidifier Chamber Inlet

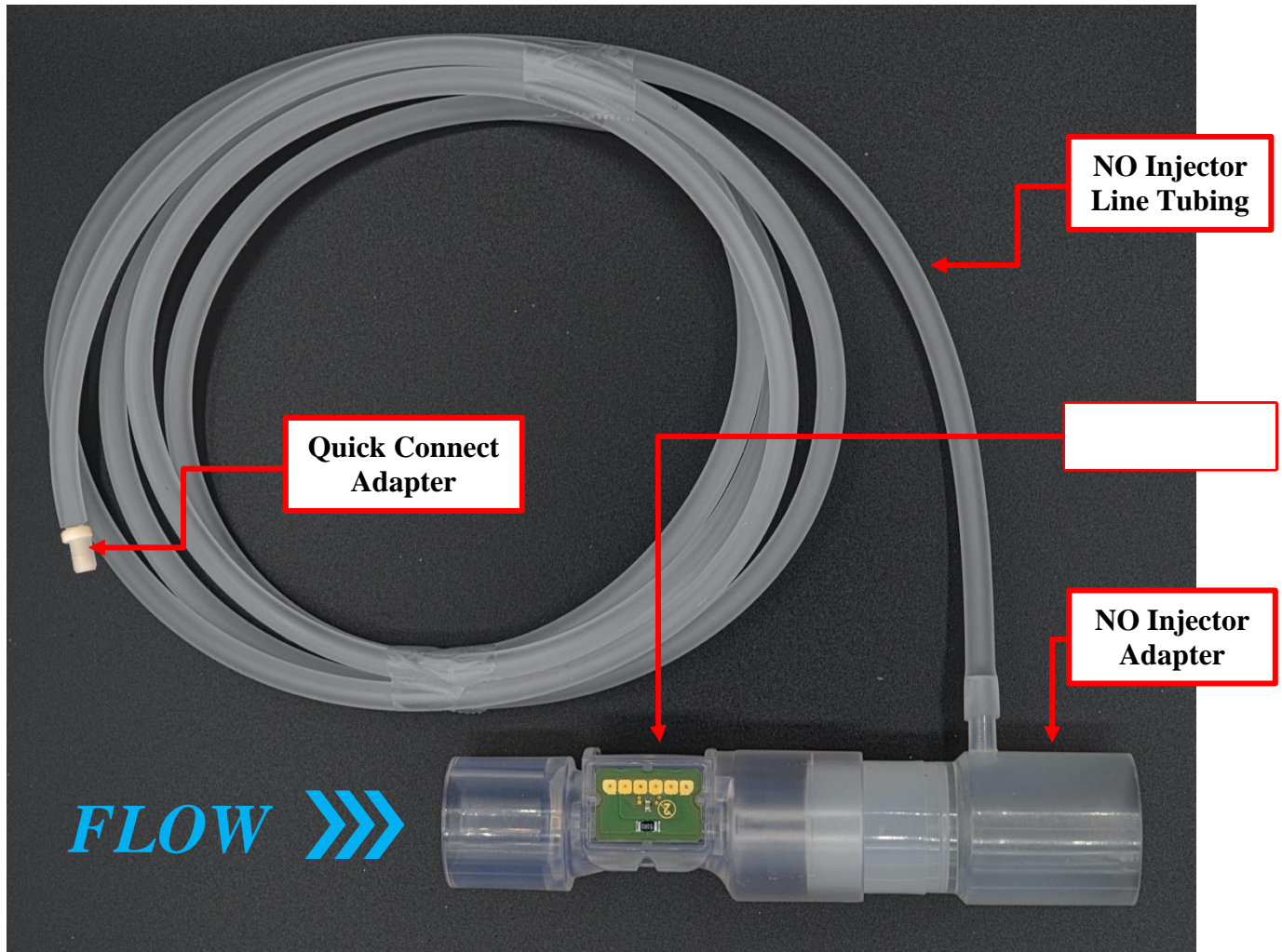

Figure 6: NDM Assembly, comprised of NO Injector Adapter and Tubing, Flow Sensor. Flow enters the flow sensor and exits through the injector adapter.

The disposable, single use NDM flow sensor provides a bidirectional, high speed/high accuracy, real time measurement of gas flow in the ventilator breathing circuit, allowing for proper calculation of the required nitric oxide flow output needed to maintain the set NO concentration.



CAUTION: NDM kit components, except for the NDM Cable, to be used on one patient only.

9.3 Gas Sampling and Monitoring System

- Gas Sampling

The system includes a gas monitoring module, with alarms, for measuring and monitoring the NO, NO₂ and the O₂ concentrations in the ventilator circuit. This is done by sampling the gas flow in the inspiratory limb of the ventilator breathing circuit near the patient connection. The sampling line is attached on one end to the inspiratory limb of the ventilator breathing circuit near the patient connection and to the LungFit PH System gas sampling port at the other. A gas pump draws approximately 230 mL/min of gas from the ventilator breathing circuit.

A hydrophobic filter and Nafion tubing are used to prevent condensation and liquid from entering the internal sampling pump and sensors. The single use Gas Sample Line is shown in Figure 7.

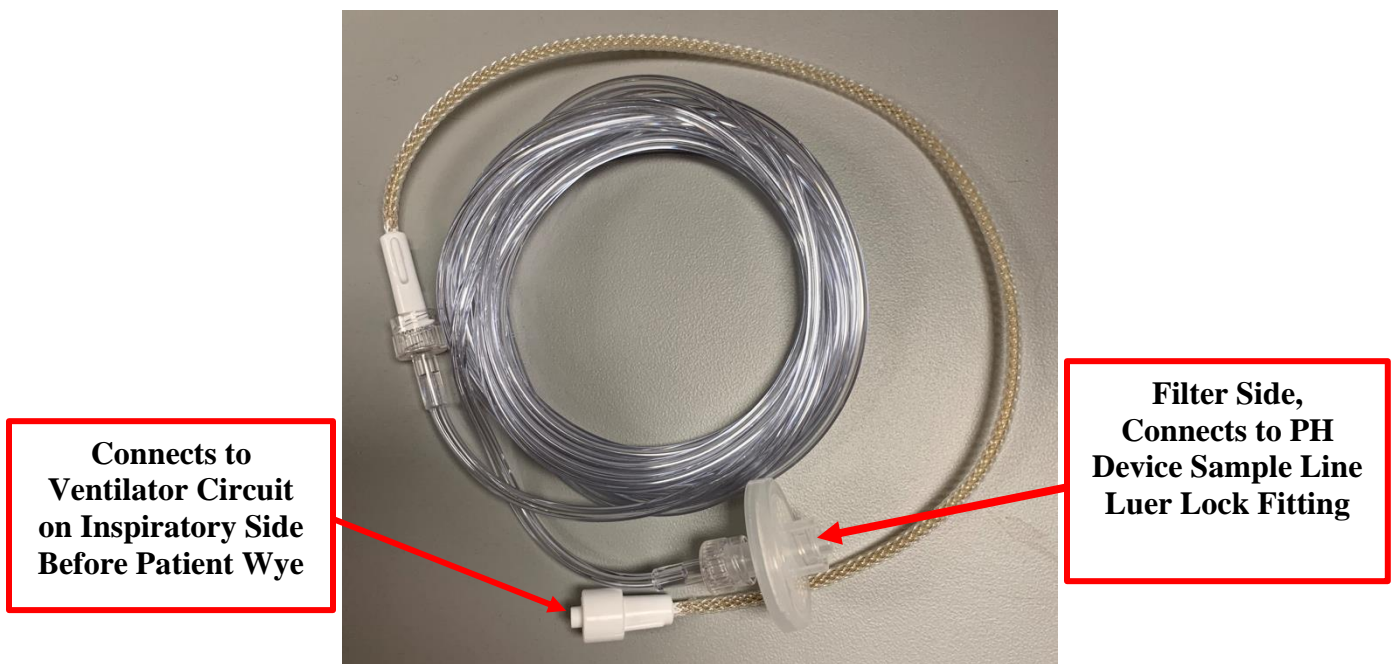

Figure 7: Gas Sample Line



CAUTION: Single use sample line to be used on one patient only; discard if contaminated.



CAUTION: Aerosolized medications delivered before the sample may clog and obstruct the sample line filter and trigger a low sample flow alarm.

- Monitor Screen and User Interface

The monitor screen and user interface are shown in *Figure 8*.

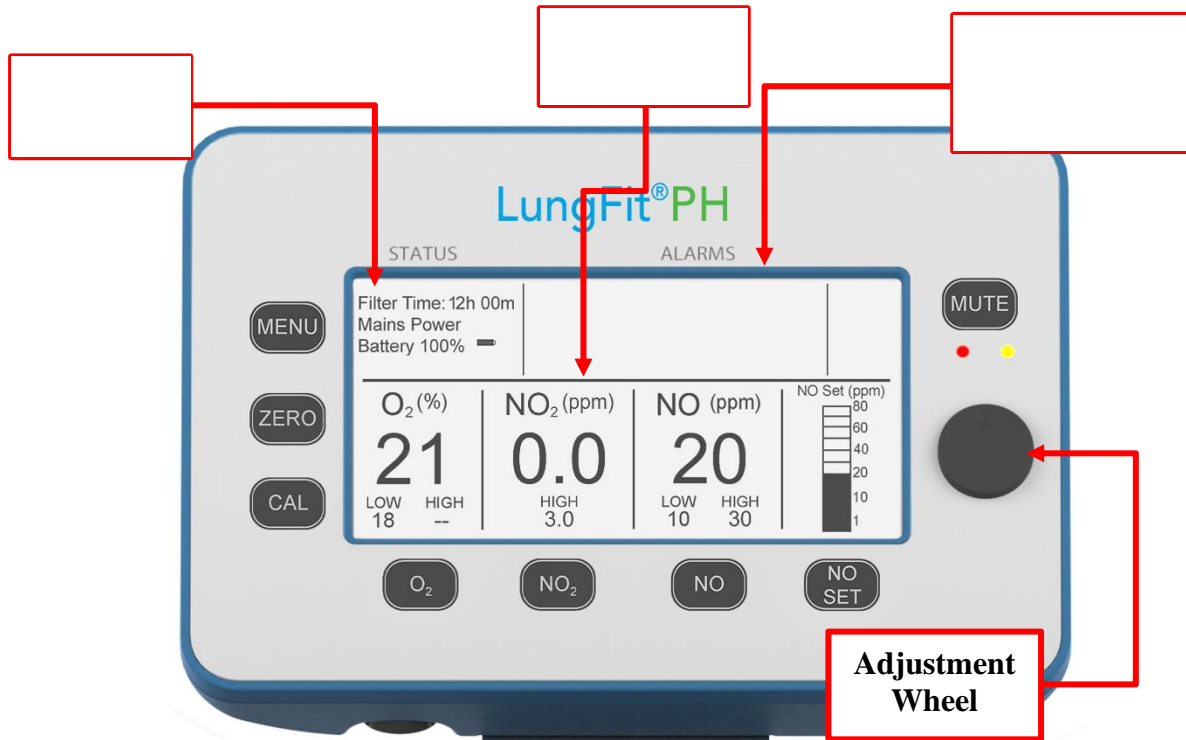

Figure 8. LungFit PH System Monitor/User Interface

- **STATUS Section**

Filter time: Displays time remaining (hours and minutes) for the installed NO₂ filter

Power: Displays current power source (Mains or Battery)

Battery: Displays current battery charge level in percent

- **Monitor Section**

O₂ (%): Displays monitored O₂ concentration in percent

LOW: Displays Low O₂ Alarm setting

HIGH: Displays High O₂ Alarm setting

NO₂ (ppm): Displays monitored NO₂ concentration in ppm

HIGH: Displays High NO₂ Alarm

NO (ppm): Displays monitored NO concentration in ppm

LOW: Displays Low NO Alarm setting

HIGH: Displays High NO Alarm setting

NO Set (ppm): Displays current NO concentration setting as the filled in portion of 0-80 ppm vertical bar graph

Used in conjunction with the Adjustment Wheel to change NO concentration delivered into the breathing circuit

○ **Alarm Indicator Section**

Displays any active alarms or previous alarms that were not reset.

○ **Adjustment Wheel**

Used to adjust settings for alarms and set NO concentration. Rotate wheel clockwise or counterclockwise to adjust active setting or alarm then press wheel until it clicks to confirm the setting.

○ **Buttons**



Alarm Silence button

Press button during an active alarm state to silence alarm for 2 minutes. Any new alarm that is triggered during this state will cancel the silenced state.

- a. High Priority Alarms: Audible alarms will be silenced for 2 minutes
- b. Low Priority Alarms: Audible alarms will remain silenced; visual indicators will remain as long as alarm is active



Oxygen Alarm button

Press button once to adjust LOW oxygen alarm setting. Press button twice to adjust HIGH oxygen alarm setting.

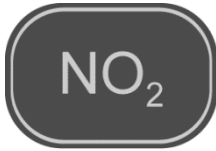

NO₂ Alarm button

Press button to adjust HIGH nitrogen dioxide alarm setting.



NO Alarm button

Press button once to adjust LOW nitric oxide alarm setting. Press button twice to adjust HIGH nitric oxide alarm setting.



NO Set button

Press button to initiate nitric oxide concentration adjustment.



Sensor Zero button

Press button to initiate a sensor zeroing operation. Note this can be performed while system is delivering nitric oxide to a patient.



Sensor Calibration button

Press button to initiate a sensor calibration.



Menu Screen button

Press button to bring up menu section of STATUS Screen. On this screen, further information can be obtained about Alarm History, Backup Delivery System (filter duration), Brightness, Information, Version, and Setting the Clock.

9.4 The Nitric Oxide Backup and Bagging System

The integrated Backup NO delivery system is a completely independent backup NO generating system that is separate from the main delivery system; it has its own NO generator and gas flow delivery system. Backup NO flow can be delivered to one of two different locations by using the System Selector switch located on the front panel of the LungFit PH system (*see Figure 2*).

System Selector Switch Position	NO Flow Path
<i>MAIN System (Center)</i>	Injector Line
<i>Backup NO Injector Line (Right)</i>	Injector Line
<i>Bagging System (Left)</i>	Bagging System Connector (flow continues through Injector Line if NO concentration set above zero and flow sensor detects flow)

Table 1: System Selector Switch Description

There are three positions available for the Selector Switch:

1. MAIN System

When the Selector Switch is turned to “Main System” position, the main NO delivery system is delivering NO through the injector tube to the NDM adaptor in the ventilator circuit at the level of NO set on the user interface display as previously described.

2. Backup NO Injector Line

When the Selector Switch is turned to “Backup NO” position (which is most likely to occur if there has been a failure of the main NO delivery system), the internal backup NO module is turned on and delivers 1 L/min of 220 ppm of NO to the ventilator circuit through the same NO₂ filter and injector tube as the main system. This provides a quick resumption of NO delivery with a minimum time of interruption to the patient. The “Main” NO delivery system is turned off when the Selector Switch is in this “Backup NO” position.

3. Bagging System

(See section 12 for details on how to set up the bagging system for LungFit PH)

When the Selector Switch is turned to “Bagging System” position, the backup NO module turns on and delivers 1 L/min of 220 ppm of NO through a separate internal NO₂ filter to the Bagging System connector on the front panel of the LungFit PH system. The Bagging System connector has two tubing fittings: one for connecting to an air/oxygen source through oxygen tubing or equivalent to provide an external flow of air/oxygen and the other to connect to a manual resuscitator for manually ventilating a patient. The 1 L/min NO flow from the backup NO module is added to this air/oxygen flow which dilutes the NO concentration down to therapeutic levels. Final NO concentration will depend on the amount of external flow added; for example, a flow of 10 L/min will provide 20 ppm of NO to the patient (1:11 dilution). See Table 2 below for bagging system dilutions.

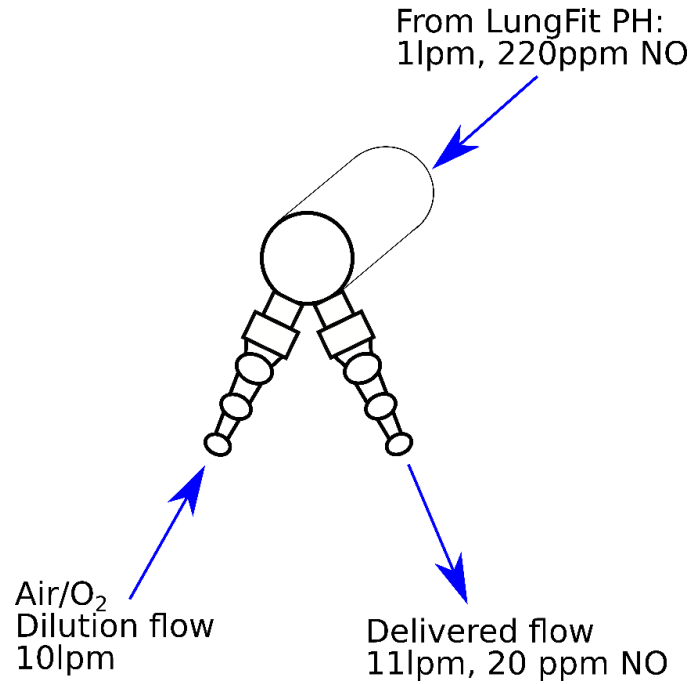

Figure 9: Dilution Flow and Final Bagging System Flow, Using 10 L/min dilution flow as an example.

Air/Oxygen Flow (L/min)	Delivered NO (ppm)
4	44
5	37
6	31
7	28
8	24
9	22
10	20
11	18
12	17
13	16
14	15
15	14
16	13
18	12
20	11

Table 2: Bagging System Dilution Table. External air/oxygen mixture is added to the 1 L/min/220 ppm NO flow from the LungFit PH to give a final NO concentration as indicated. Total flow delivered will be the air/oxygen flow plus the 1 L/min from the LungFit PH.

To check time remaining on Bagging System Internal NO₂ filter:

- Press **MENU** button
- Turn Control Wheel clockwise one click so that selection box is around **Backup Delivery**
- **Bagging Filter Duration** time will be displayed in **ALARMS** section of screen (see *Figure 10*)
- Press **MENU** button to return to Main Screen



Figure 10: Bagging Filter duration displayed in ALARMS Section of Screen

9.5. Automatic Purge Cycles

Room air is the carrier gas for the delivered nitric oxide. This allows the system to purge the delivery lines when NO generation has been paused. Whenever a purge routine is active, **Purging** will appear as a message in the **STATUS** section of the screen.

Automatic Purge Routines are:

- NO Set dose changed from >0 ppm to 0 ppm
 - 10% of ventilator flow through the NO generation chamber and injector line (if attached) for 5 seconds
- NO delivery selector switched from **Bagging System** to **MAIN System**
 - 6 second purge of backup NO generation chamber through the Bagging System Outlet port
- NO delivery selector switched from Backup NO to MAIN System
 - 6 second purge of backup NO generation chamber through the Bagging System Outlet port followed by a 2 second purge of 1 L/min through the ventilator outlet port
- System power switched to OFF position
 - 5 second purge through the NO generator chamber.
 - Note that if an NO₂ filter is not installed, flow will exit through the right side NO₂ filter port (nearest outer edge of device). If an NO₂ filter is installed, flow will exit through the injector line port on the front of the device
 - 2 second purge through the Backup NO generator chamber

9.6. Battery

The LungFit PH is equipped with 2 rechargeable Lithium Ion batteries. Together, the LungFit PH batteries provide up to 4 hours of run time when fully charged, under the following conditions:

- 2 hours of MAIN System when set to deliver 20 ppm NO at a flow of 10 L/min and
- 2 hours of NO Backup (Backup NO or Bagging System active) with MAIN System NO dose set to zero.

The LungFit PH batteries are housed internally and can only be replaced by trained technicians.

10. LUNGFIT PH SYSTEM SETUP

10.1 Nitric Oxide Delivery Module (NDM) Assembly

Attach the NDM cable to the flow sensor of the NDM:

- Align cable head with flow sensor so that locking tabs are lined up together and pins are lined up with the pads (see *Figure 11*).
- Slide locking tab of cable head beneath locking tab of flow sensor.
- Support the bottom of the flow sensor (side opposite to flow sensor pads) and press down on the top of the cable head until locking clip clicks into place (see *Figures 11 and 12*).
- Attach cylindrical end of NDM cable to NDM connector port of LungFit PH unit (see *Figure 13*).
- Connect injector adapter tubing to Ventilator NO Outlet of LungFit PH by pushing the quick connect fitting until it clicks into place. (see *Figures 14-16*).

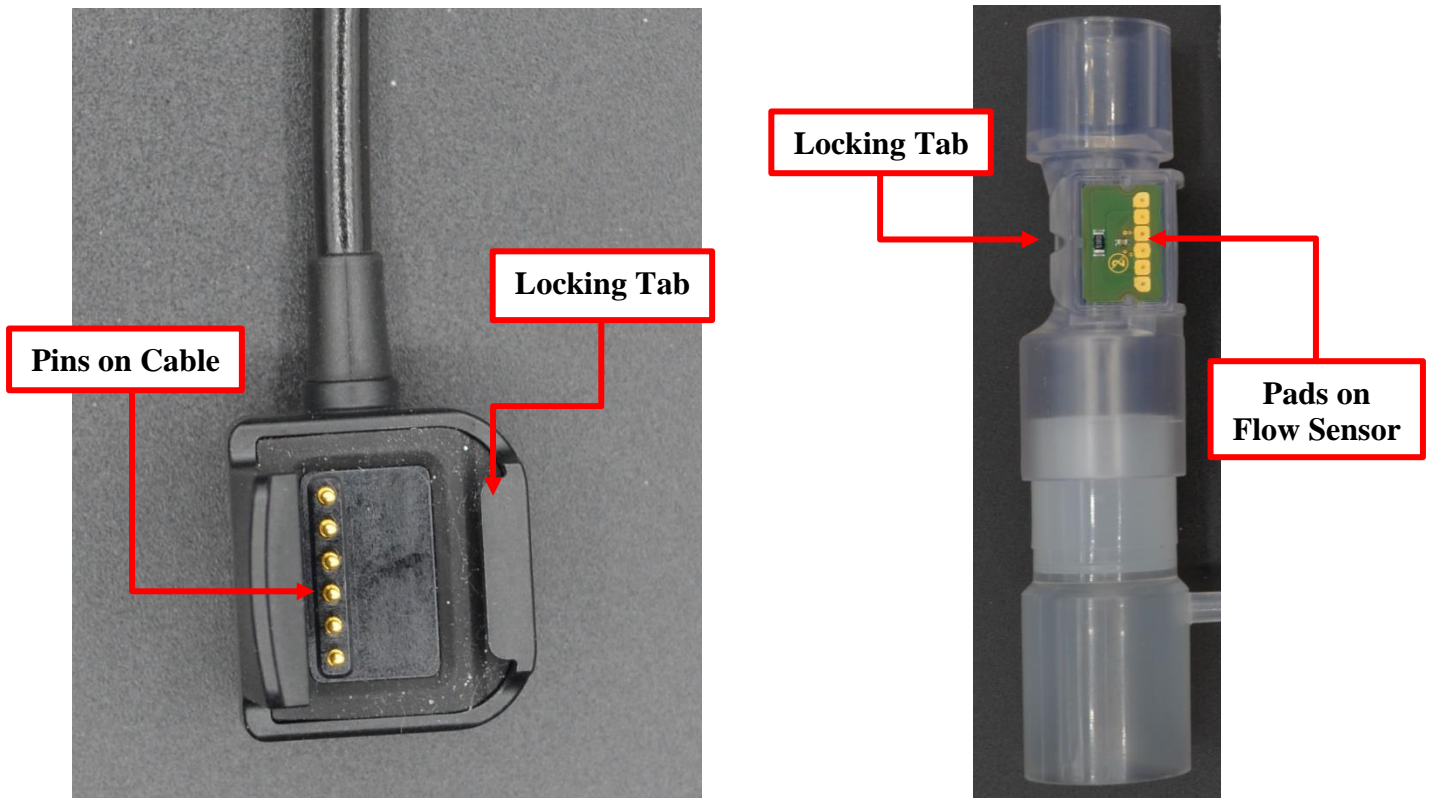

Figure 11: NDM Flow Sensor and Cable Connector

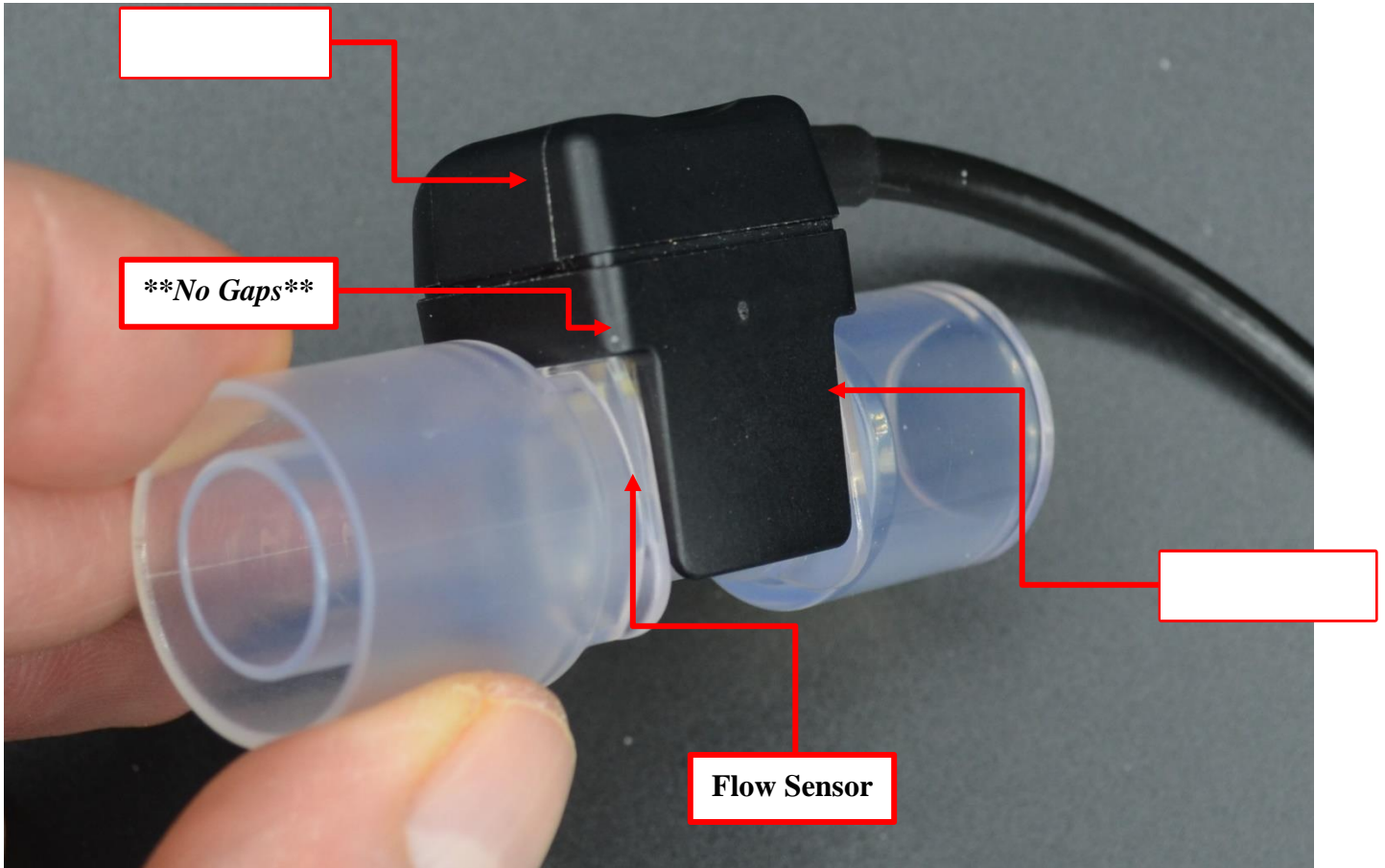

Figure 12: Cable Head attached to the single use flow sensor. Note that the head sits flat on the sensor with no gaps and the locking clip is locked in place.

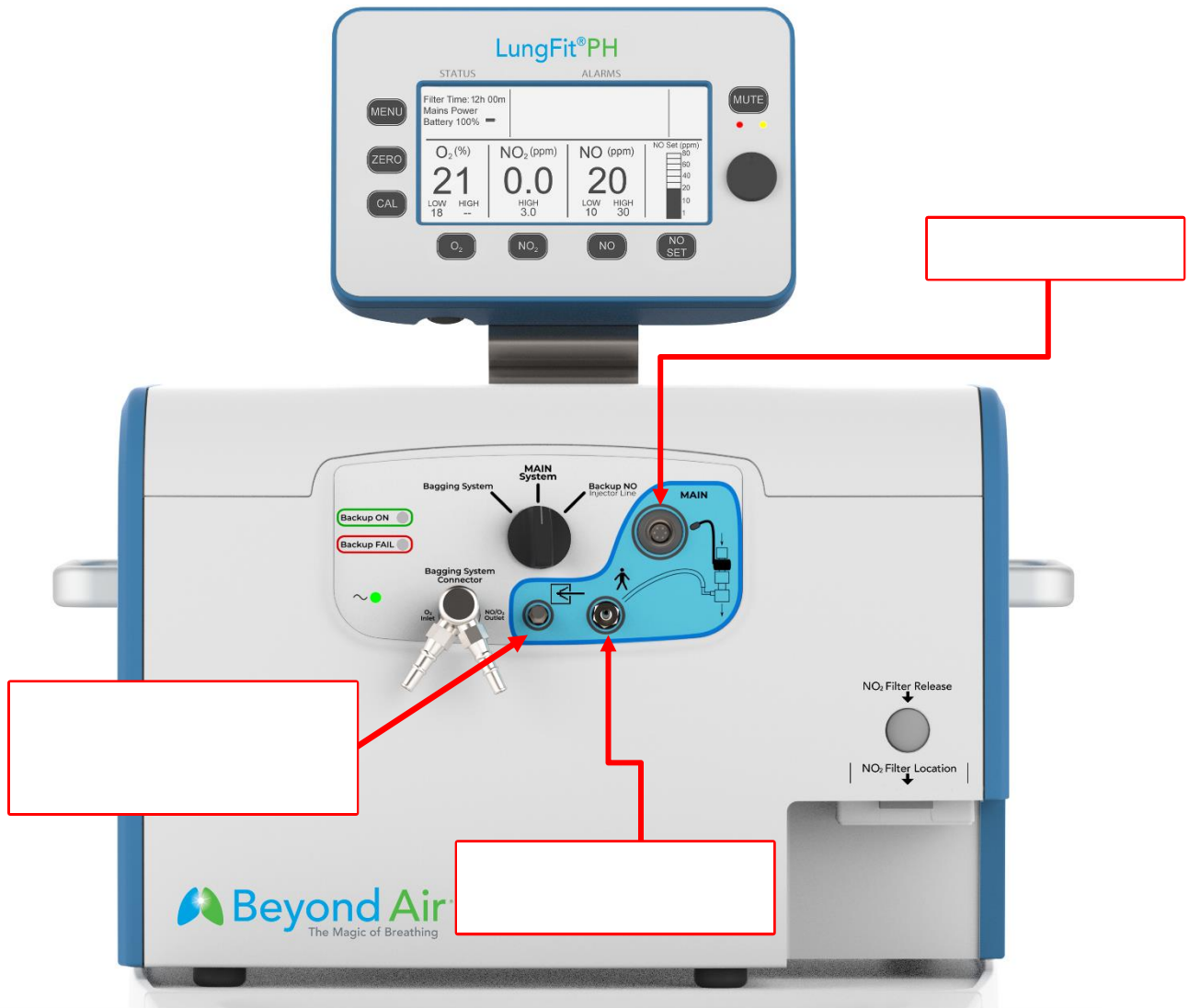

Figure 13: NDM & Gas sample line Connections to the LungFit PH Main Unit



Figure 14: NDM Cable Orientation (dual ridges facing up)



Figure 15: LungFit PH Injector Line Quick Connect Fitting



Figure 16: Injector Line Quick Connect Adapter

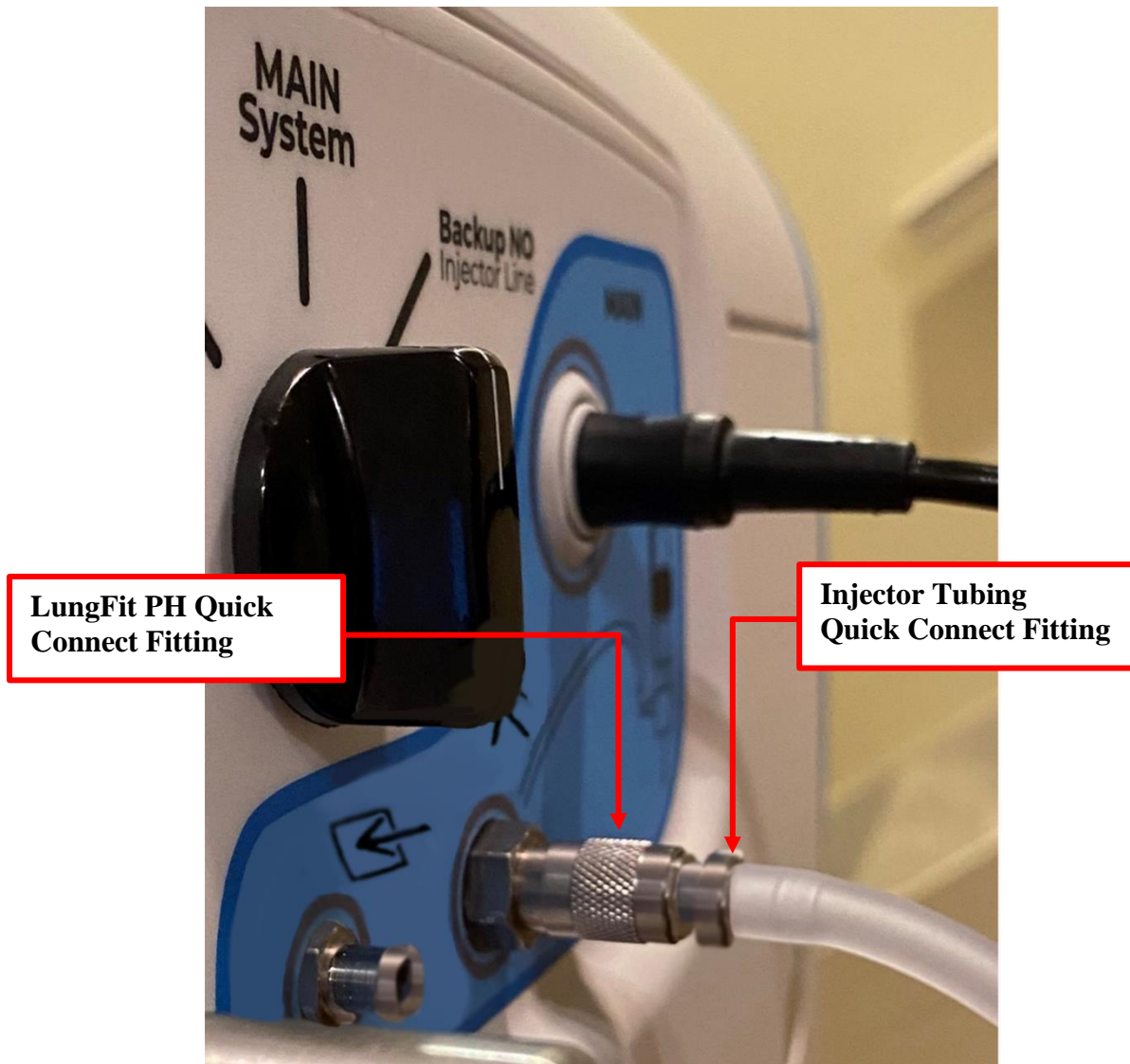

Figure 17: Injector Line Properly Connected to LungFit PH. To insert, press the injector tubing quick connect fitting straight into the LungFit PH quick connect fitting until it clicks into place. To remove, push the outer sleeve of the LungFit PH quick connect fitting back until the tubing quick connect fitting pops out (spring release).

10.2 Gas Sample Line setup

Connect the gas sample line with filter (*Figure 7*) to the LungFit PH system:

- Connect the sample line end with the filter to the Luer lock connection on the front of the LungFit device (*see Figures 13 and 15*).
- The Nafion end of the sample line will attach to the Luer connection on either the Verification kit (*see section 10.4, Figure 18*) or the ventilator circuit (*see Figure 19*)

10.3 LungFit PH Startup

- Place the LungFit PH System in its ready state by turning power switch located on rear panel of the device to 'ON' position (*see Figure 3*).
- The system will quickly go through a series of internal checks and tests and check for an installed filter (typically 8-12 seconds). After this, it will immediately display sensor readings and be ready to use.
- Observe for any alarm messages (in alarm indicator section) once startup sequence is complete.
- Note: If a filter is not inserted when system powers on, the following messages are shown:
 - **STATUS** Section: Filter Not Found
 - **ALARMS** Section: Filter Not Detected
 - Illuminated low Alarm indicator (Amber LED below **MUTE** button) with two (2) audible beeps every 30 seconds.
- Pressing **MUTE** button will silence audible notification as long as alarm condition is active (for low alarm conditions), until a new alarm is induced.
- Install an NO₂ filter if one is not already in place
 - Observe that Filter Time reading is greater than 30 minutes. A new filter will result in a displayed Filter Time of 12 hours.
 - Note: Filter Time (time remaining on a 12-hour filter) is stored on the filter. The correct Filter Time will be identified if used on a different LungFit PH unit.
- Allow gas sensors to stabilize for at least 3 minutes
- Zero gas sensors as per *Section 16.1*.
- Complete a Verification Check (see next section)

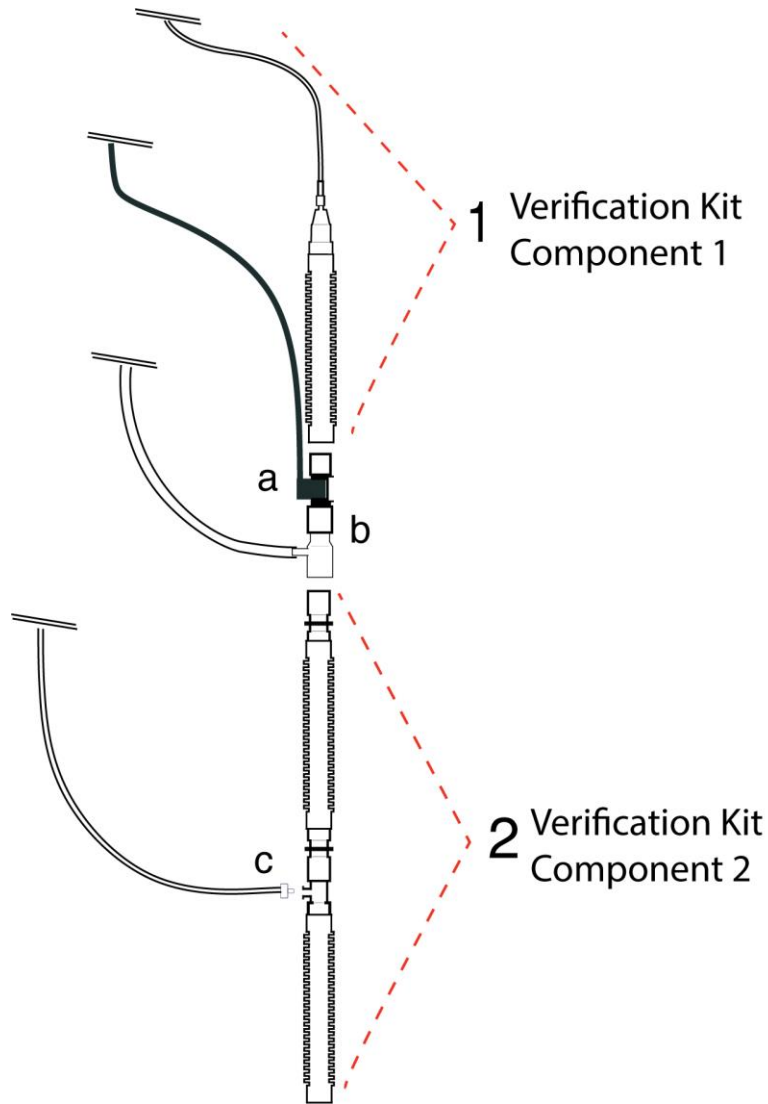

	Description	Source
1	Verification Kit Pre-assembled Component 1 (Oxygen tubing, Oxygen Stem, Corrugated Tubing)	Verification Kit
2	Verification Kit Pre-assembled Component 2 (Connector, Corrugated Tubing (x2), Connector with Sample Port)	Verification Kit
a	NDM Flow Sensor Cable	LungFit PH
b	NDM Pre-assembled Components (Flow Sensor, Connector with Injector Port, Injector Line)	NDM Kit
c	Sample Line	Sample Line Kit

Figure 18: Verification Circuit, Assembled

10.4 Verification Check



WARNING: Complete a Verification Check outlined in this manual at least once per month.

- When to perform a Verification Check:
 - Monthly, in conjunction with sensor calibration
 - Between patient uses
- Running the Verification Check:
 1. Assemble Verification Circuit as shown in Figure 18
 - 1.1 Connect Oxygen Tubing from Verification Kit Pre-Assembled Component 1 to a **100% oxygen source**, typically with a 0-15 L/min flowmeter
 - 1.2 Connect Corrugated Tubing from Verification Kit Pre-Assembled Component 1 to NDM Kit Flow Sensor (b)
 - 1.3 Connect NDM kit Connector with Injector Port (b) to the Straight Connector from the Verification Kit Pre-Assembled Component 2
 - 1.4 Connect the NDM Flow Sensor Cable (a) to the NDM Kit Flow Sensor (b)
 - 1.5 Connect the Sample Line to the port on the Connector with Sample Port from the Verification Kit Pre-Assembled Component 2
 2. Connect NDM Flow Sensor Cable and NO Injector Line from NDM Kit to LungFit PH System (*see Figure 13*)
 3. Connect Sample Line (filter end) to Sample Inlet on LungFit PH System (*see Figure 13*)
 4. Install an NO₂ Filter.
 - 4.1 In **STATUS** Section of the main screen, observe remaining filter time, changing filter as necessary.
 5. Turn oxygen flow to **10 L/min**
 6. **Test Backup System:**
 - 6.1 Turn Backup NO Switch to the position on the right (Backup NO Injector Line).
 - 6.2 Allow equalization period of at least 30 seconds

6.3 Observe stable monitored values:

NO	NO ₂	O ₂
20 ± 6 ppm	< 2 ppm	93 ± 3%

6.4 If the monitored values are not within the stated values above, complete the following steps:

- Verify correct verification set up (see figure 18) and flow (10 L/min)
- Perform sensor zero and calibration if possible then repeat verification check
- Replace LungFit PH System if verification check fails

7. **Test Main System:**

7.1 Turn Selector Switch to “Main System”

7.2 Set the LungFit PH System ‘*NO Set (ppm)*’ value to 40 ppm.

7.3 Allow equalization period of at least 30 seconds

7.4 Observe stable monitored values:

NO	NO ₂	O ₂
40 ± 8 ppm	< 2 ppm	93 ± 3%

7.5 If the monitored values are not within the stated values above, complete the following steps:

- Verify correct verification set up (see figure 18)
 - Perform sensor zero and calibration if possible then repeat verification check
 - Change NDM then repeat verification check
 - Change NDM cable then Repeat verification check
 - Replace LungFit PH System if verification check fails
8. Set the LungFit PH System ‘*NO Set (ppm)*’ value to 0 ppm
 9. Turn System Selector Switch to center MAIN System position.
 10. Verification check is now complete.

10.5 Monthly Procedures

The following procedures should be performed monthly:

- Complete zero and calibration of sensors
- Complete Verification Check
- Check bagging filter duration

11. USING THE DEVICE

Figures 19 and 20 show how the system integrates with a ventilator circuit for use on a patient.

11.1 Setting up the ventilator circuit

- Place flow sensor/injector adapter (Nitric Oxide Delivery Module, NDM) on the inlet port of the humidifier. Be sure that it is placed on the dry side of the humidifier chamber and that the flow sensor is above (before) the injector adapter. (*See Figure 19 for using with a conventional ventilator circuit and Figure 20 for use with a Vyair 3100A HFO ventilator*)
- Attach tube from the inspiratory outlet of ventilator to 22mm OD end of flow sensor.
- Connect sample line to sample tee adapter.
- Place sample tee adapter in the inspiratory limb of the ventilator circuit, at least 18 inches downstream of the NDM to ensure adequate mixing of nitric oxide with ventilator flow. Place adapter close to the patient wye (approximately 6 inches from the patient wye) to accurately measure inhaled NO, NO₂ and O₂.



WARNING: Always have an independent back up NO delivery system available close at hand as a contingency in the event the LungFit PH System becomes inoperative during a NO therapy session.



WARNING: The LungFit PH System sample line withdraws approximately 230 mL/minute of gas flow from the ventilator breathing circuit. Flow sensitivity adjustment on the ventilator may be necessary to prevent auto-cycling of the ventilator (repetitive triggering of mechanical breath).



WARNING: Place the gas sample line on the breathing circuit inspiratory limb and close to the patient connection (approximately 6 inches from patient wye, and at least 18 inches downstream from the NDM) to accurately measure inhaled NO, NO₂ and O₂.

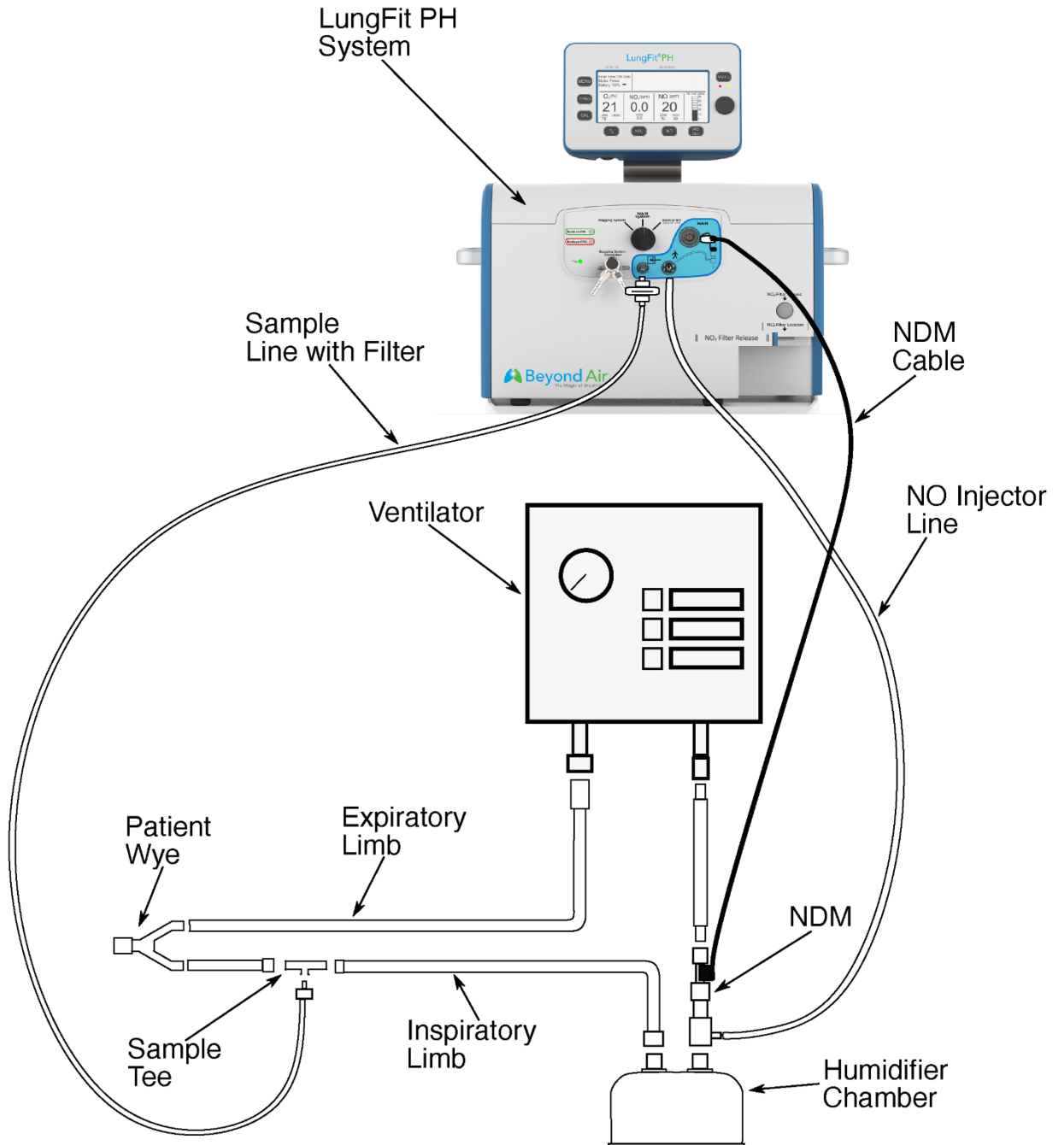

Figure 19: Connecting the LungFit PH System to a Mechanical Ventilator Circuit

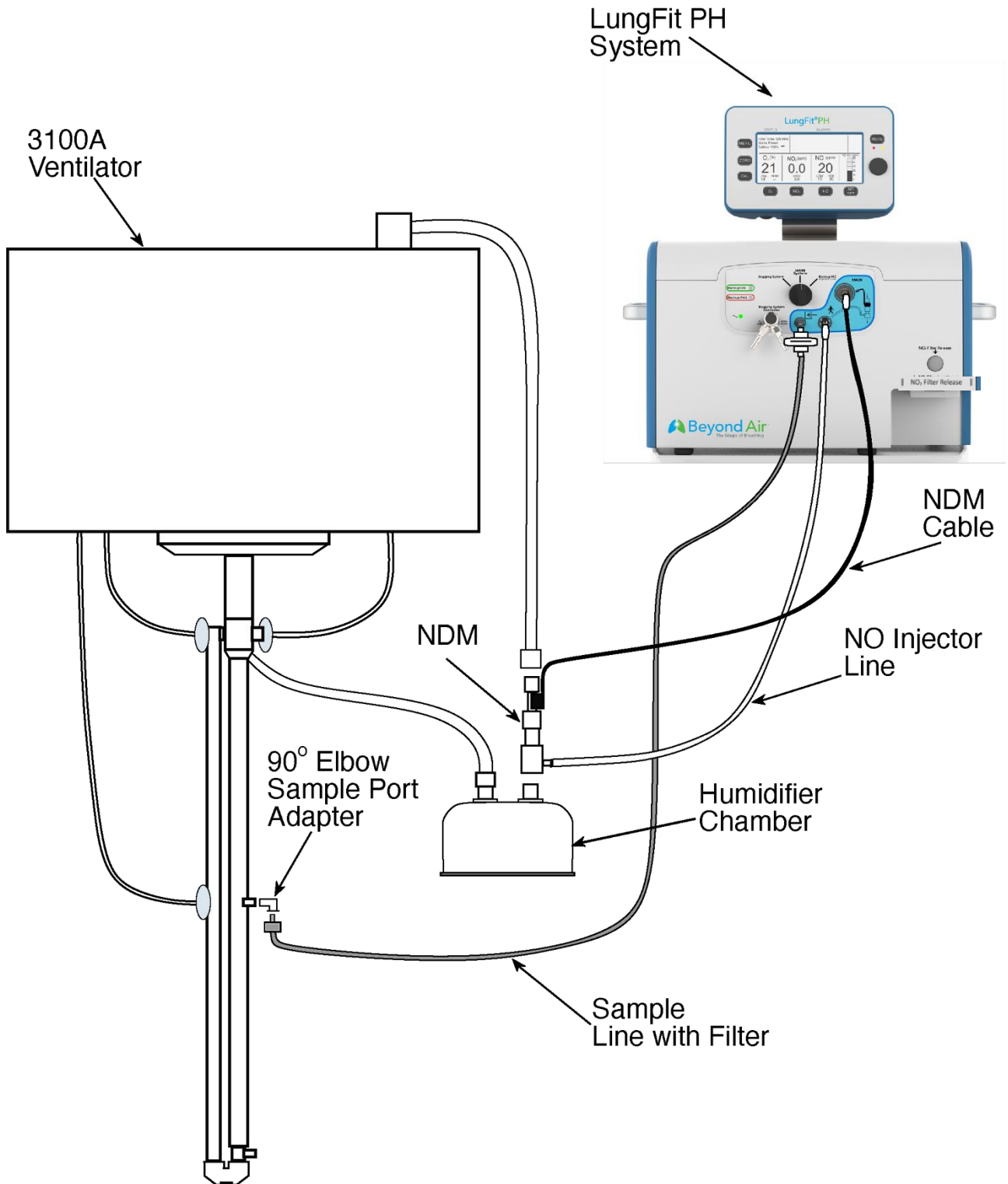

Figure 20: Connecting the LungFit PH System with the Vyair 3100A HFO Ventilator

11.2 Begin NO Therapy

- Observe that there are no Active Alarms, as indicated in **ALARMS** Section of the User Interface (see *Figure 21*).
- Press “NO Set” button on the front panel
 - In “NO Set” portion of screen, a box will appear that contains current NO set point (see *Figure 21*)
- Set desired NO concentration on LungFit PH System:
 - Turn Adjustment wheel to adjust NO set point.
 - Accept new NO setting by pressing wheel until it clicks. The setpoint box and number will disappear, leaving only the bar graph in place with the updated NO set point.
- Observe that the measured NO concentration is consistent with the set NO concentration and that NO₂ and O₂ concentrations are in the desired range.
- Set NO, NO₂, and O₂ alarms appropriately.



Figure 21: NO Set Adjustment. Note box around NO set point (17 on screen)



CAUTION: Condensing humidity will impair the function of the sensors. In the unlikely event that the sensor(s) gets wet, turn the unit on and sample room air to allow the analysis module to dry out. Once dry, the sensors will function normally.



WARNING: Adjustments to ventilator FiO₂ may be required when administering nitric oxide gas as the FiO₂ delivered to the patient may change due to the dilution effect of the NO gas.

11.3 Changing an NO₂ Filter



WARNING: A non-expired NO₂ Filter must be properly installed at all times for the LungFit PH System to function.

- Insert new filter as quickly as possible (within 15 seconds) to minimize interruption of NO treatment
- If the filter is not installed, there will be no nitric oxide delivered through the **NO Injector Line Outlet**
- The device will not start if the installed NO₂ Filter is past its designated usage time.
- The device will alarm (**Change NO₂ Filter**) if the installed NO₂ Filter is past its designated usage time.
- Always have at least one spare NO₂ Filter available

- The process for changing the NO₂ filter is the same during a case or as part of the device set up.
- From the NO₂ filter package label, confirm filter is not past its expiry date (*see Figure 22*). Note that the expiry date is also stored electronically on each filter and an '**NO₂ Filter Expired**' alarm will be triggered if there is an attempt to use an NO₂ Filter past its expiry date.

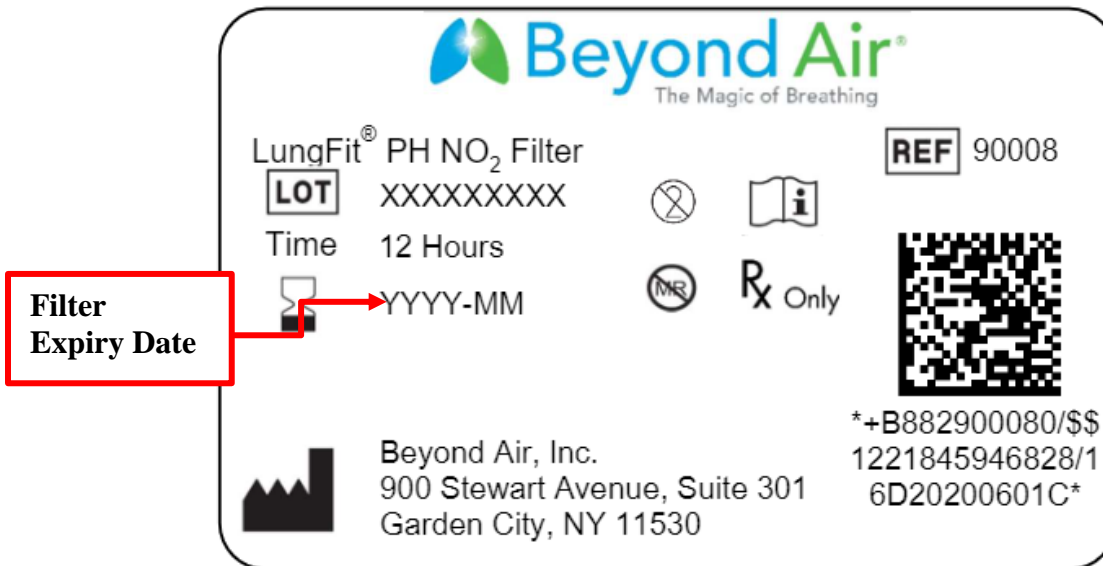

Figure 22: LungFit PH 12 Hour Filter Package Label with expiry date (arrow)

- Remove NO₂ filter from package
- Remove existing filter (*see Figure 23*):
 - Press and hold NO₂ Filter Release button
 - Hold NO₂ filter on outer side edges and pull it straight down
 - Note: This can be either a one-handed or two-handed procedure

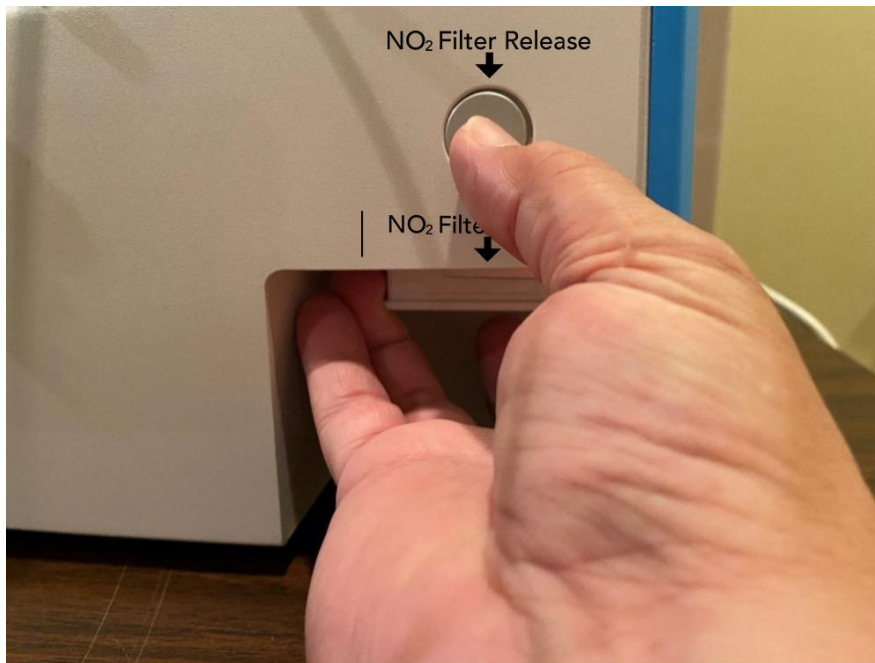

Figure 23: One-handed removal of NO₂ filter

- Insert new filter by lining up the middle of the front face of the filter with the filter release button and sliding vertically (*see Figure 24*). An audible ‘click’ will be heard when it is fully seated.
 - Note: There is a tab on the filter insertion guide of the LungFit PH that acts as a guide for the filter installation (*see Figure 25*). The slot on the back face of the NO₂ filter must be aligned to this tab so that when the filter is slid in vertically it will be correctly aligned with the LungFit PH filter fittings (*see Figure 26*).
 - Note: The NO₂ filter clicks into place when the tab on the front face of the NO₂ filter is locked in place by the locking clip on the LungFit PH (*see Figure 27*).



Figure 24: New NO₂ Filter lined up and ready to be slid in vertically

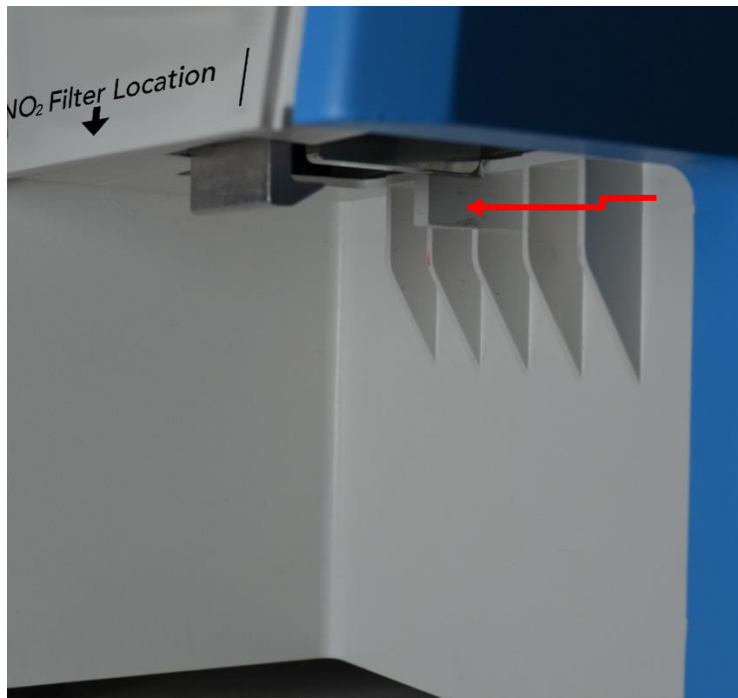

Figure 25: LungFit PH NO₂ Filter Insertion Guide, with Tab (arrow).



Figure 26: NO₂ Filter correctly aligned on the LungFit PH Filter Insertion Guide. At this point, sliding the filter vertically will align the filter openings with the LungFit PH fittings and result in a successful filter installation, which is evident when the filter is clicked into place.



Figure 27: NO₂ Filter Successfully Installed and Locked in Place.

WARNING: A non-expired NO₂ Filter must be properly installed at all times for the LungFit PH System to function.

- Insert new filter as quickly as possible (within 15 seconds) to minimize interruption of NO treatment
- If the filter is not installed, there will be no nitric oxide delivered through the **NO Injector Line Outlet**
- The device will not start if the installed NO₂ Filter is past its designated usage time.
- The device will alarm (**Change NO₂ Filter**) if the installed NO₂ Filter is past its designated usage time.
- Always have at least one spare NO₂ Filter available



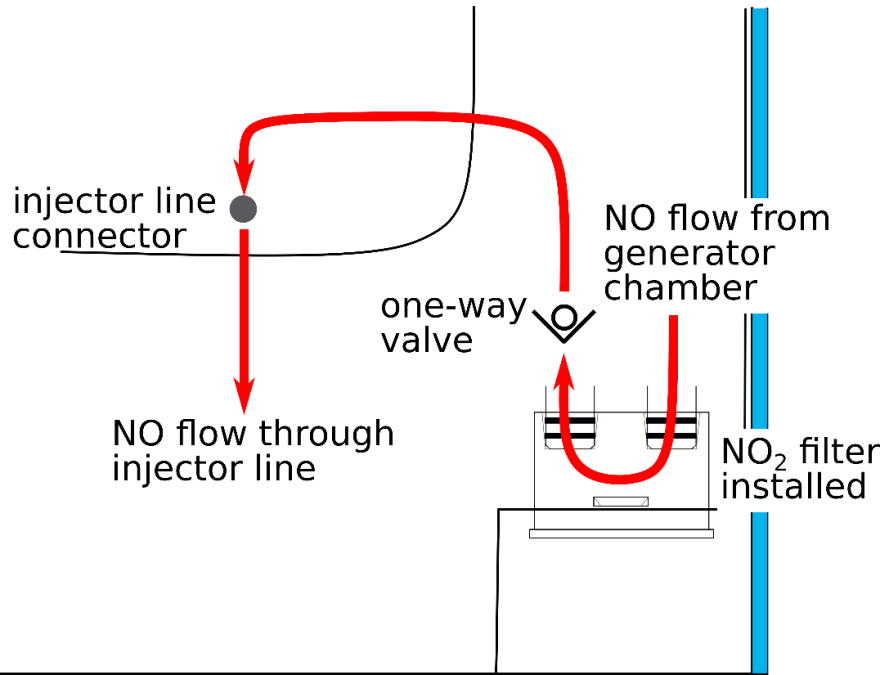

Figure 28: NO Flows Through the NO Injector Line when a NO₂ Filter is Installed in the LungFit PH

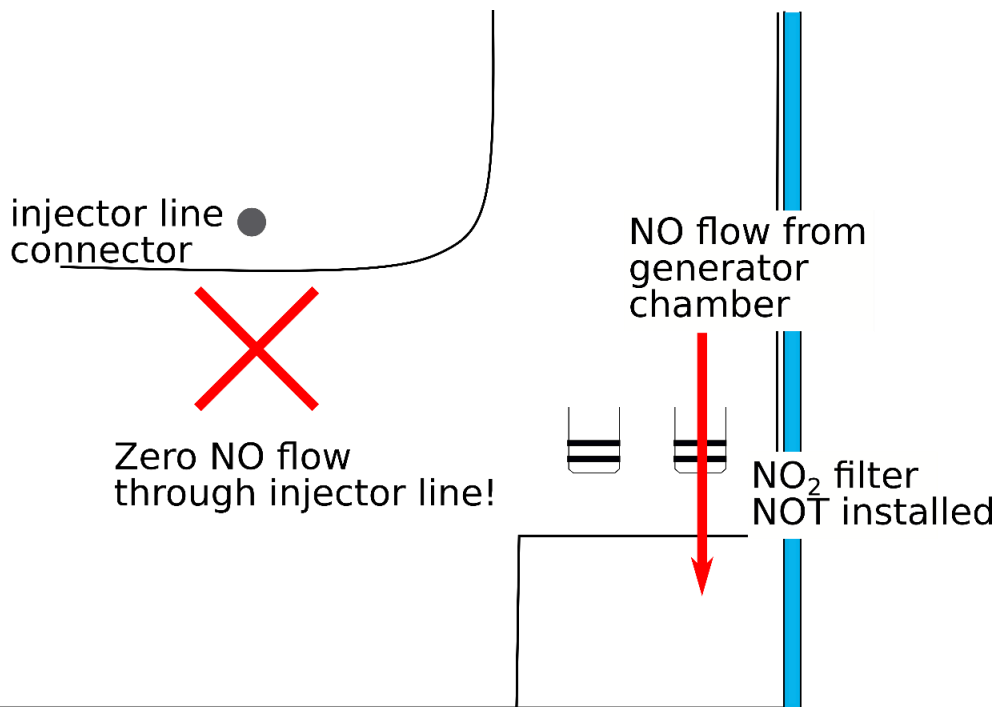

Figure 29: Zero NO Flow Through the NO Injector Line when a NO₂ Filter Is NOT Installed in the LungFit PH

- Confirm that new filter is recognized by LungFit PH system by observing updated value for Filter Time in **STATUS** Section (*see Figure 30*).

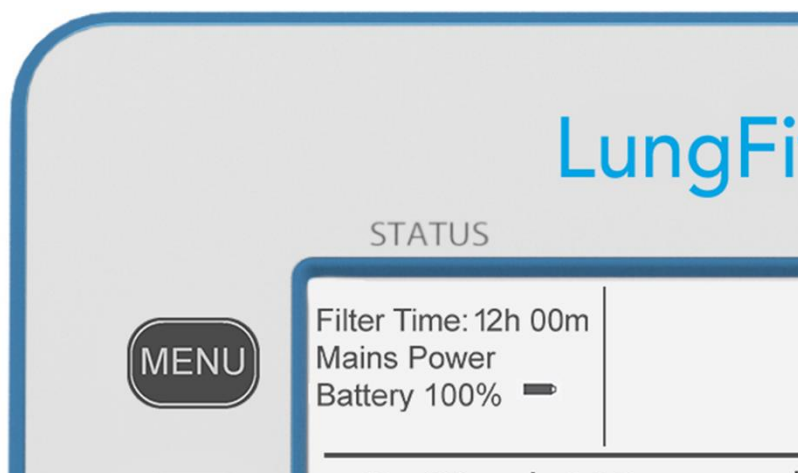

Figure 30: Filter Time remaining (12h 00 m) on STATUS section of User Interface

11.4 Adjusting Alarms



WARNING: Ensure NO, NO₂, and O₂ alarms are set to acceptable limits when delivering NO to a patient.

- Press alarm adjustment button for the desired parameter (*see Figure 31*). Press button the appropriate number of times to access desired alarm parameter:
 - **O₂** Low: Press once
 High: Press twice
 - **NO₂** High: Press once
 - **NO** Low: Press once
 High: Press twice
- Observe that the alarm that is selected has a box around the displayed value
- Turn Adjustment Wheel (*see Figure 31*) to desired alarm level, as indicated by small number below alarm label.
- Press wheel until it clicks to confirm new value.
- Default alarm values:
 - O₂:
 - Low: 18%
 - High: -- (OFF)
 - NO
 - Low: 10 ppm
 - High: 100 ppm
 - NO₂:
 - High: 3 ppm

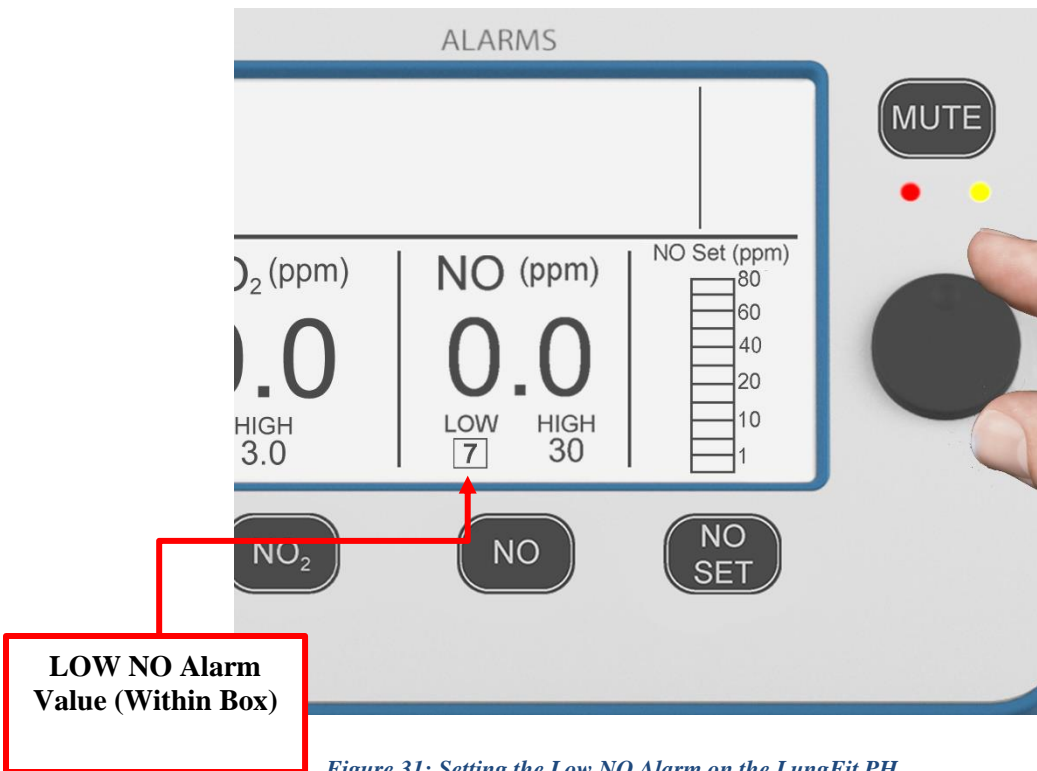

Figure 31: Setting the Low NO Alarm on the LungFit PH

11.5 Adjusting NO Concentration

- Press NO SET button on User Interface panel. The current NO set value will appear in a box to the left of the bar graph (see *Figure 32*).
- Turn Adjustment Wheel until set point reaches desired NO concentration level.
- Press Adjustment Wheel until it clicks to confirm new value. The set value box will disappear, and the new NO setting will be shown in the bar graph.



Figure 32: Setting the NO Concentration on the LungFit PH

11.6 Pausing Therapy

- Set NO concentration on LungFit PH System to zero (0)
 - Note the system will automatically purge the tubing between the NO generation chamber and the NDM adapter (including the NO injector line) with room air immediately after the concentration is set to zero. As a result, a NO₂ purge step is not required when returning to NO therapy after a prolonged pause. See Section 9.5 for details on Automatic Purge Cycles.
- Observe that NO and NO₂ concentrations return to zero.
 - Note that Filter Time will not decrease when NO is set to zero (0) ppm.
- To restart nitric oxide delivery, simply set a NO value above zero. Purging of the injector line is not necessary.
 - The device will automatically purge the injector line with room air when NO is initially set to zero, removing the need to purge the injector line of NO₂ upon restart.

11.7 Adjusting time and date

- Press **MENU** button to display Menu screen in **STATUS** area of the display.
- Use control wheel to select **Clock Set**, indicated by a box surrounding the text (*Figure 33*)
- Press control wheel to confirm selection of parameter.
- Use control wheel to change selected parameter to the desired value.
- Press control wheel again to confirm the value.
- When all parameters are adjusted, press **MENU** button to return to the main page in the **STATUS** section.

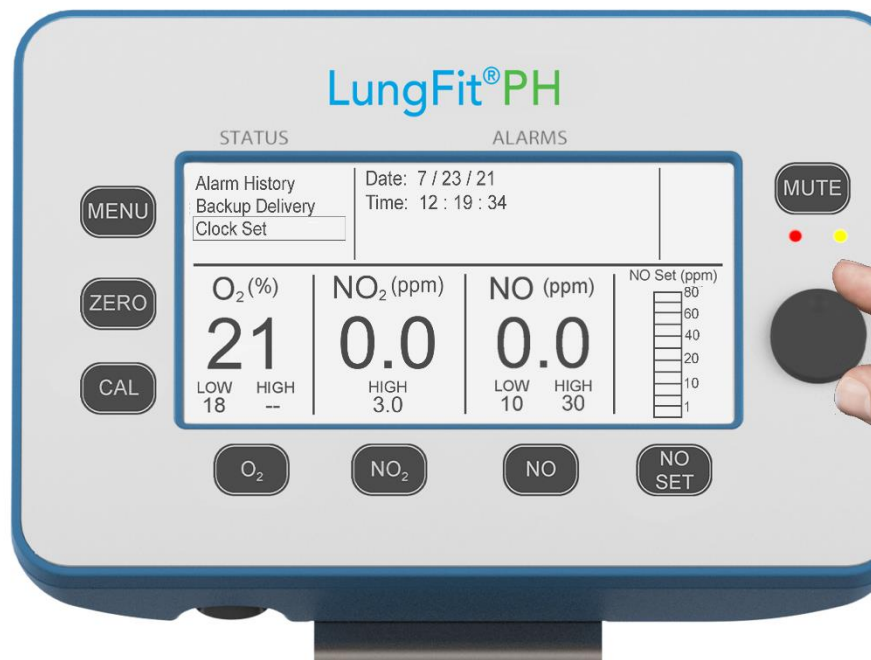

Figure 33: Clock Set Screen

11.8 Backup Delivery Menu Page

- Press **MENU** button to display **MENU** screen in **STATUS** area of the display.
- Use control wheel to select **Backup Delivery**, indicated by a box surrounding the text.
- Press control wheel.
- Information on Bagging Filter Duration will appear in the **ALARMS** section of the screen (*see Figure 34*).
- *Note that a new Bagging Filter has a 48-hour capacity, and the duration decreases only when the front panel switch is in the **Bagging System** position*
- Press **MENU** button to return to the main screen in the **STATUS** section.



Figure 34: Backup Delivery Screen

11.9 Alarm History

- Press **MENU** button to display Menu screen in the **STATUS** area of the display.
- Use control wheel to select **Alarm History**, indicated by a box surrounding the text (*see Figure 35*)
- Press control wheel.
- The 4 most recent alarms will be displayed in the **ALARMS** section of the display, along with time of occurrence.
- Use control wheel (clockwise direction) to scroll down to view earlier alarms
- Press **MENU** button to return to the main screen in the **STATUS** section. If **MENU** button is not pressed, the **STATUS** section will return to the Main Screen after 15 seconds of inactivity.



Figure 35: Alarm History Screen

11.10 Brightness Adjustment

- Press **MENU** button to display Menu screen in the **STATUS** area of the display.
- Use control wheel to select **Brightness**, indicated by a box surrounding the text (see *Figure 36*).
- Turn control wheel to choose appropriate screen brightness.
- Press control wheel to accept adjusted value.
- Press **MENU** button to return to main screen in the **STATUS** section. If the **MENU** button is not pressed, the **STATUS** section will return to the Main Screen after 15 seconds of inactivity.



Figure 36: Brightness Adjustment Screen

11.11 Information Screen

- Press **MENU** button to display Menu screen in the **STATUS** area of the display.
- Use control wheel to select **Information**, indicated by a box surrounding the text (*see Figure 37*).
- Information contained on this screen contains calibration status of internal components.
- Press **MENU** button to return to the main screen in the **STATUS** section. If the **MENU** button is not pressed, the **STATUS** section will return to the Main Screen after 15 seconds of inactivity.

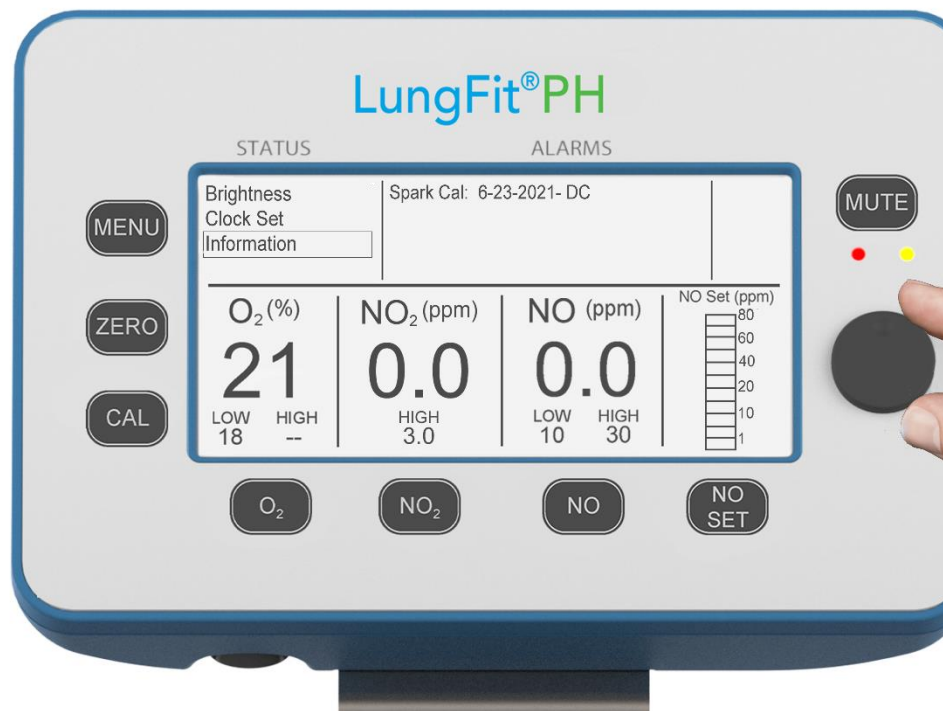

Figure 37: MENU Information Screen

11.12 Maintenance

- The LungFit PH requires a preventative maintenance (PM) check every 1000 hours of operational use, defined as the accumulated time when the device is actively generating nitric oxide.
 - Accumulated time does not include time when the system is powered ON and NO set is at 0ppm.
 - When the system timer reaches 800 hours since the previous PM check, a low priority alarm (**Maint. Due <200 hrs**) will be generated. This alarm will be present until the device is serviced.
- Do not service or maintain any parts of the LungFit PH while in use.

11.13. Changing components during use

- The following components may be changed while the LungFit is in use (if necessary):
 - Sample Line and Filter
 - Nitric Oxide Delivery Module (NDM)
 - Note that no nitric oxide will be delivered to the ventilator circuit when the NDM is not attached to the LungFit PH and installed in the ventilator circuit
 - NO₂ Filter
 - Note that no nitric oxide will be delivered to the ventilator circuit when the NO₂ filter is not installed in the LungFit PH (*see Figure 29*).
 - The Bagging System may be used to supply NO to the patient when an NO₂ filter is not installed. See *Section 12*.



WARNING: A non-expired NO₂ Filter must be properly installed at all times for the LungFit PH System to function.

- Insert new filter as quickly as possible (within 15 seconds) to minimize interruption of NO treatment
- If the filter is not installed, there will be no nitric oxide delivered through the **NO Injector Line Outlet**
- The device will not start if the installed NO₂ Filter is past its designated usage time.
 - The device will alarm (Change NO₂ Filter) if the installed NO₂ Filter is past its designated usage time.
- Always have at least one spare NO₂ Filter available

- List of **external** accessories (which can be changed during use) and internal components (which will be changed in servicing):

External Accessories <i>Changed at point of care</i>
NO ₂ Filter
NDM and Bagging Kits
Sample Line
NDM Flow Sensor Cable

Internal Components <i>Changed by technical service</i>
Bagging Filter
O ₂ , NO, and NO ₂ Sensors
Batteries

12. USING THE BAGGING SYSTEM NO/O₂ OUTLET

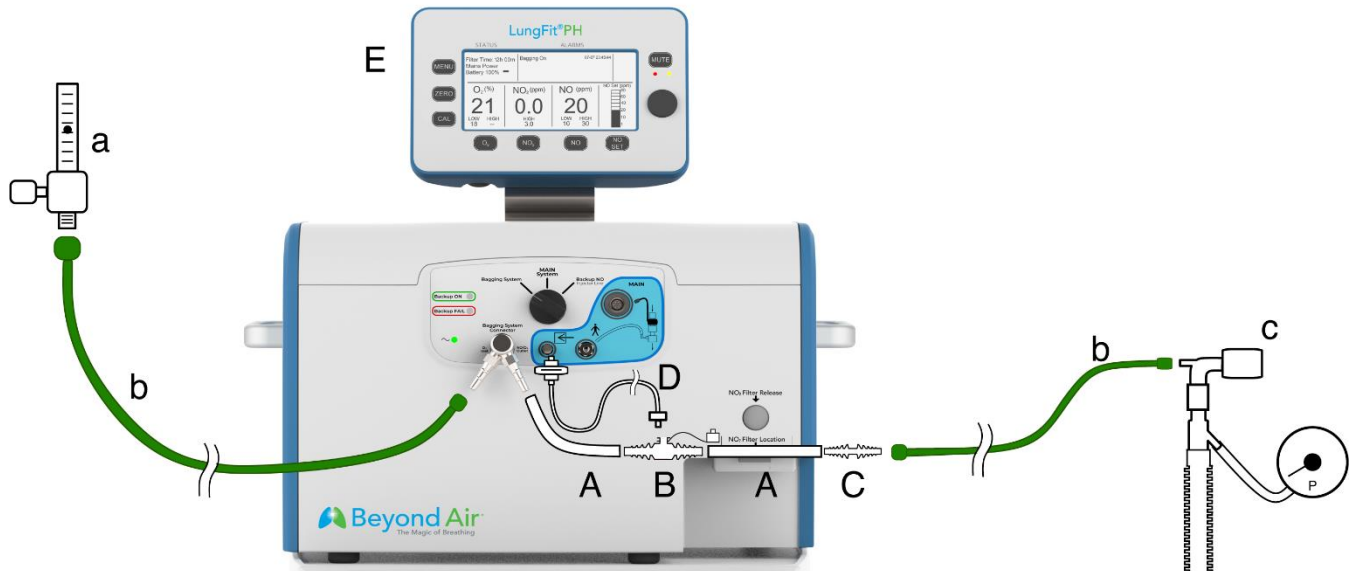

A	1/4" ID PVC tubing (6" length)	
B	1/4" x 1/4" straight connector with luer lock and cap	P/N 90005
C	O ₂ tubing connector	
D	Sample Line with Filter	P/N 90022
E	LungFit PH system	P/N 90001
a	Air/O ₂ source	Hospital-Supplied Equipment
b	Oxygen tubing	
c	Manual resuscitator	

Figure 38: Bagging System Circuit Connections

- Note that the LungFit PH Bagging System uses a separate, internal, NO₂ filter rated at 48 hours when new. To check the time remaining on this internal NO₂ filter, follow the steps outlined in Section 11.8.
 - The Bagging System will provide NO flow even when the main (external) NO₂ filter is not installed.

- Attach oxygen source gas to the O₂ Inlet connector (*Figure 38, item a. and b.*).
- Attach Bagging System Circuit to the NO/O₂ Outlet of the Bagging System Connector (*see Figure 38*).
- Attach resuscitator oxygen tubing to the open barbed fitting of the Bagging System Circuit.
- Ensure that appropriate dilution flow is added to the O₂ Inlet of the LungFit PH (*Table 3 below*)
 - Note that the LungFit PH provides 220 ppm NO (balance air) at a total flow of 1 L/min
 - Use the LungFit PH Bagging System with diluting flows above 2 L/min to maintain delivered NO concentrations below 80 ppm.

Diluting Flow Added (L/min)	Total Delivered Flow (L/min)	Final NO Concentration (ppm)
2	3	73
3	4	55
4	5	44
5	6	37
6	7	31
7	8	28
8	9	24
9	10	22
10	11	20
11	12	18
12	13	17
13	14	16
14	15	15
15	16	14

Table 3: NO Bag Outlet Dilution Flow Effect on Final NO Concentration

- To monitor the gas going to the patient, attach the sample line to the sample T luer port in the bagger circuit (see Figure 38).
 - Turn Backup/Bagger Switch to **Bagging System Connector** position to initiate NO flow
 - This will trigger a Low Priority alarm with **NO Bagging System On** message in the Alarm Display Section

- There will be a single audible beep every 15 seconds while the main switch is set to the Bagging System (left) position. The audible alarm can be silenced with the **MUTE** button.
- The amber LED will remain lit while the switch is in the **Bagging System** position
- Note: NO flow will continue to be delivered to the ventilator circuit at the set NO concentration as long as there is flow through the ventilator circuit
- If gas is being monitored, observe monitored values for appropriate NO, NO₂, and O₂ levels being delivered to the patient.
- Once Bagging System usage is complete, return to Selector Switch to **Main System** (center) position
- Reconnect ventilator circuit to the patient endotracheal tube (ETT)
- If applicable, move the sample line from the Bagging System circuit to the ventilator circuit sample tee
- Confirm return of acceptable measured NO, NO₂, O₂ values in the ventilator circuit (if applicable)

13. USING THE BACKUP NO SYSTEM

WARNING: The Backup NO System introduces a fixed flow (1 L/min) and NO concentration (220 ppm) through the injector line into the NDM. The final delivered concentration will depend on the ventilator circuit flow.



- When using the integrated backup with breathing circuit gas flows of 5 L/min, the delivered NO dose will be approximately 40 ppm. Breathing circuit gas flows less than 5 L/min will deliver an NO dose greater than 40 ppm.
- **The Backup NO System is intended for short term use when the main NO delivery system fails. Use only until a replacement NO system can be placed in use.**
- An NO₂ Filter must be installed when using the Backup NO System
- The Backup NO System delivers a variable concentration of NO to the patient that depends on the ventilator flow used.

- Turn Selector Switch to **Backup NO Injector Line** position (Figure 2) to initiate NO flow into the (NO) injector line and maintain the ventilator circuit setup with the sample line for monitoring.
 - **Backup ON** blue LED on front panel will be lit
 - ‘Backup NO’ message will appear in **STATUS** section of the screen (see Figure 39).

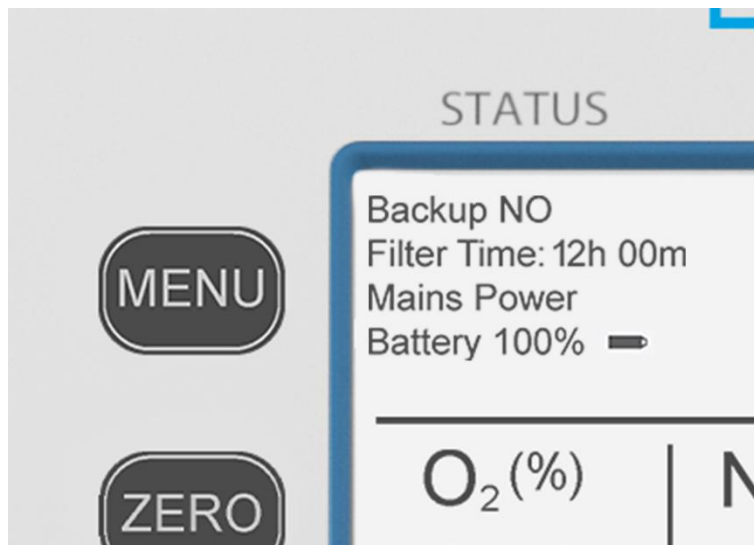

Figure 39: Backup NO notification in the STATUS Section of the screen

- Note that:
 - NO flow to the NDM will be 1 L/min at a NO concentration of 220 ppm
 - The LungFit PH system will not deliver the set NO dose while the switch is in the **Backup NO Injector Line** position
 - To deliver NO flow, a NO₂ filter must be in place.
 - if not present, **Filter Not Detected** high priority alarm will trigger when Selector Switch is placed in **Backup NO Injector Line** position
 - When monitored NO value exceeds 100 ppm, device will automatically switch to Backup NO generator, delivering NO at 220 ppm at a flow of 1 L/min through the injector line
 - “Backup ON” blue LED on front panel will be lit
 - NO will continue to be delivered through the injector line by the Backup NO generator until device is powered down whether Selector Switch is set to Main System or Backup NO
 - SET NO button will be disabled
 - Main Delivery Generator will be disabled
 - Bagging System with manual resuscitator will work normally

14. COMPLETING THERAPY



WARNING: Avoid abrupt discontinuation of NO. To wean NO down, titrate in several steps, pausing several hours at each step to monitor for hypoxemia.



WARNING: Abrupt discontinuation of NO may lead to worsening oxygenation and increasing pulmonary artery pressure, i.e., Rebound Pulmonary Hypertension Syndrome. Signs and symptoms of Rebound Pulmonary Hypertension Syndrome include hypoxemia, systemic hypotension, bradycardia, and decreased cardiac output. If Rebound Pulmonary Hypertension occurs, reinstate NO therapy immediately.

- When NO therapy is no longer required:
 - Adjust NO setting to zero
 - Remove NDM assembly and gas sample line connector from ventilator circuit. Do not discard the NDM cable.
 - Turn off LungFit PH System.
 - Prepare LungFit PH System and black NDM cable for Cleaning and Reprocessing (Section 19).
 - Discard the single-use gas sample line and remaining NDM assembly components.



CAUTION: To maintain LungFit PH batteries in a charged state, keep system plugged in between uses.



CAUTION:

- DO NOT sterilize.
- DO NOT clean any parts with acetone or other strong solvents.
- DO NOT immerse or allow water or any other liquid to enter the device or housings.

15. REMOVING THE LUNGFIT PH SYSTEM FROM THE CART

- Loosen the locking bolt securing the bracket to the LungFit PH (*see Figure 40*). The LungFit PH System can now be removed from the cart, if needed.



Figure 40: LungFit PH Cart Bracket with Locking Bolt

16. GAS MONITOR CALIBRATION PROCEDURE



CAUTION: Calibrate the sensors at least once a month, or more frequently if needed, to ensure the device monitors the gases in the breathing circuit correctly.

16.1 Zero NO, NO₂, and O₂ Sensors

- Zero the LungFit PH sensors prior to use (at start up) and daily while in use.
- *Note: The sample line does NOT have to be placed in room air prior to zeroing the sensors. The LungFit PH uses an internal valve to sample room air during a zero procedure.*
- On the front panel of the LungFit PH System (**Figure 8**), press **Zero** button to the left of the screen for at least one second.
 - When the zeroing function begins, the new zero values and the values shown in the Monitor section are replaced with dashes (‘- -’).
 - As each parameter completes its zeroing, it will return to a numerical (measured) value. Note that each parameter may complete its zeroing at a slightly different time.
 - To cancel in-progress zeroing, press either the **ZERO** button or click the adjustment wheel. The message **Cancelled Zero** will appear in the **STATUS** section of the screen. Note that the previous zero values will be maintained.
 - Once all parameters have returned to measured values and ‘**Zeroing**’ no longer appears in the **STATUS** section of the screen, zeroing is complete.
- If the **Calibration Error** low priority alarm message is observed:
 - Repeat zero procedure.
 - If it fails a second time, replace system.
- If further calibration is needed, proceed to the next section, using the setup shown in Figure 41. If not, the system will automatically resume active gas monitoring.

16.2 Calibrate NO Sensor

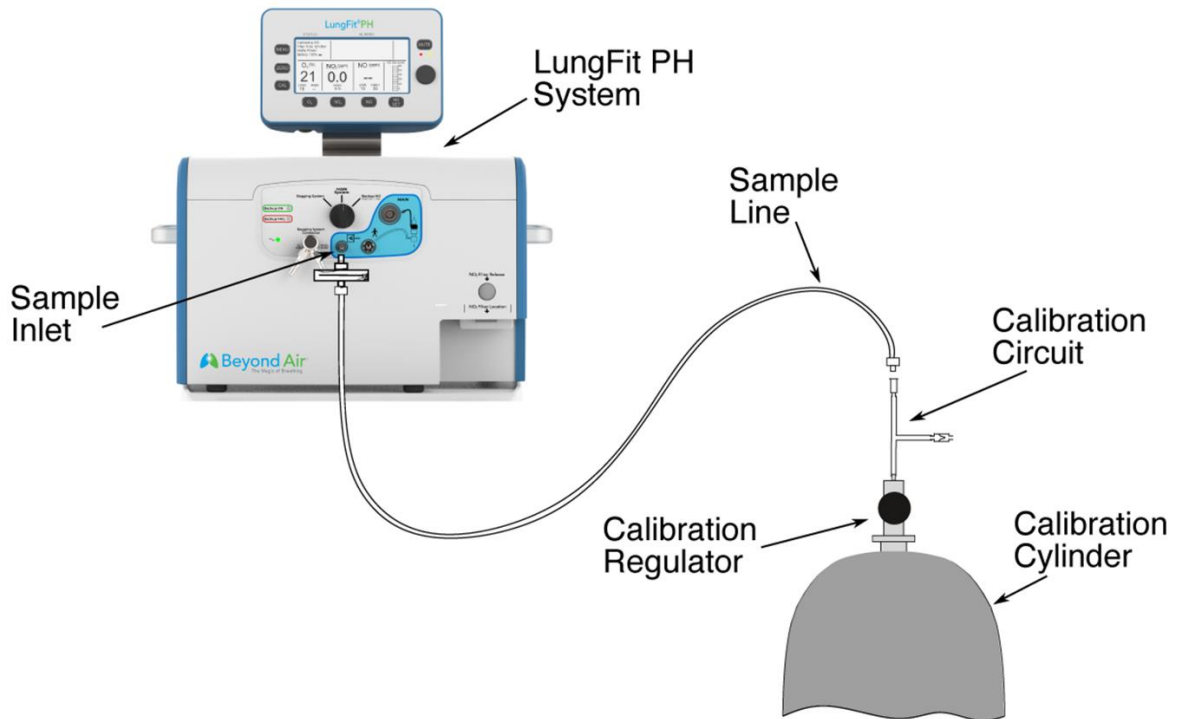

Figure 41: Calibration Setup

- Turn valve on the calibration regulator to its fully open position (fully turn counter- clockwise to open)
- Connect calibration regulator and sample tee to the NO calibration cylinder (45 ppm NO balance N₂). Confirm there is greater than 100 psi in the cylinder.
- Connect the LungFit PH System Sample Line to female luer fitting of the calibration circuit (*see Figure 41*)
- Connect the other end of the Sample Line to the Sample Inlet of the LungFit PH System.
- Allow NO reading to stabilize for 2 - 4 minutes, or until reading has not changed for at least 30 seconds.
- Press **CAL** button on the front panel of the LungFit PH System. The **Press Gas to Cal** message will appear in the **STATUS** section of the screen.
- Press the **NO** button; verify that the **Calibrating NO** message is shown in the Alarm Status section.

- The NO reading shown in the **Monitor** section will change to “----” to indicate that calibration has been initiated.
 - To cancel in-progress calibration, press either the **CAL** button or click the adjustment wheel. The message **Cancelled Cal NO** will appear in the **STATUS** section of the screen. Note that previous calibration values will be maintained.
- Once the calibration is complete, “----” will be replaced by a number.
- The NO reading should be 45 ± 2 ppm and remain stable for at least 30 seconds.
 - If the above value is not observed, or if a **Calibration Error** alarm is triggered:
 - Check calibration gas being used is the correct concentration (45ppm) and not past its expiration date, and connections are tight
 - Repeat NO calibration
 - If it fails a second time, replace system.

16.3 Calibrate NO₂ Sensor

- Turn valve on calibration regulator to its fully open position (fully turn counter- clockwise to open)
- Connect calibration regulator and sample tee to NO₂ calibration cylinder (10 ppm NO₂ balance air). Confirm there is greater than 100 psi in cylinder.
- Connect female luer fitting of calibration circuit to LungFit PH System Sample Line (*see Figure 41*).
- Connect the other end of the Sample Line to the Sample Inlet of the LungFit PH System.
- Allow NO₂ reading to stabilize for 2 - 4 minutes, or until reading has not changed for at least 30 seconds.
- Press **CAL** button on the front panel of the LungFit PH System (*see Figure 8*). The **Press Gas to Cal** message will appear in the **STATUS** section of the screen.
- Press **NO₂** button; verify that the **Calibrating NO₂** message is shown in the Alarm Status section.
- The NO₂ reading in the **Monitor** section will change to “----” to indicate that calibration has been initiated.
 - To cancel in-progress calibration, press either the **CAL** button or click the adjustment wheel. The message **Cancelled Cal NO₂** will appear in the **STATUS** section of the screen. Note that previous calibration values will be maintained.

- Once calibration is complete, “---” will be replaced by a number.
- NO₂ reading should be 10 ±2 ppm and remain stable for at least 30 seconds.
 - If the above value is not observed, or if a **Calibration Error** alarm is triggered:
 - Check calibration gas is the correct concentration (10 ppm) and not past its expiration date, and connections are tight
 - Repeat NO₂ calibration
 - If it fails a second time, replace system.

16.4 Calibrate O₂ Sensor

- Connect a 100% O₂ gas source to the Verification Circuit with a flow of at least 8 L/min (*see Figure 18*).
- Allow O₂ reading to stabilize for 2 - 4 minutes, or until the reading has not changed for at least 30 seconds.
- Press the **CAL** button on the front panel of the LungFit PH System (*see Figure 8*). The **Press Gas to Cal** message will appear in the **STATUS** section of the screen.
- Press **O₂** button; verify that the **Calibrating O₂** message is shown in the Alarm Status section.
- The O₂ reading will change to “---” to indicate that calibration has been initiated.
 - To cancel in-progress calibration, press either the **CAL** button or click the adjustment wheel. The message **Cancelled Cal O₂** will appear in the **STATUS** section of the screen. Note that previous calibration values will be maintained.
- Once the calibration is complete, the ‘---’ will be replaced by a value that is 100 ±3%.
- The O₂ reading should be 100 ±3 % and remain stable for at least 30 seconds.
 - If the above value is not observed, or if a **Calibration Error** alarm is triggered:
 - Check calibration gas is correct, and connections are tight
 - Repeat the O₂ calibration
 - If it fails a second time, replace the system.

16.5 Sensor Replacement

Contact a Beyond Air customer support representative to arrange for LungFit PH sensor replacements.

17. ALARMS

The following are descriptions of alarms in the LungFit PH System. Alarms are displayed in the Alarm Indicator section of the front display.

17.1	Alarm mute icon	High Priority: Active alarm is muted for 120 sec, counts down in seconds Low Priority: Active alarm is muted	Note: A new alarm will override the mute
17.2	Backup On	Indicator (Blue)	Active whenever a Backup system is ON (Selector Switch is in either Bagging System or Backup NO Injector Line position)
17.3	Bagging On	Low Priority Visual (yellow) and audible	Selector Switch set to Bagging System (Left side position)
17.4	Calibration Error	Low Priority Visual (yellow) and audible	During calibration, flow in the sample line is low (<180 mL/min) or an incorrect supply gas is detected.
17.5	Change Bagging Filter	Low Priority Visual (yellow) and audible	Bagging filter time exceeded, requiring filter replacement (48-hour capacity when new)
17.6	Change NO₂ Filter	Low Priority Visual (yellow) and audible	Time remaining on NO ₂ Filter is less than 30 minutes
17.7	Change NO₂ Filter	Low Priority Visual (yellow) and audible	Time remaining on NO ₂ Filter is less than 10 minutes
17.8	Change NO₂ Filter	High Priority Visual [flash red] and audible	Time remaining on NO ₂ Filter is less than 2 minutes
17.9	Filter Not Detected	Low Priority Visual (yellow) and audible	NO ₂ filter not detected when NO dose is set to zero and Backup NO not engaged
17.10	Filter Not Detected	High Priority Visual [flash red] and audible	NO ₂ filter not detected when NO dose set to > zero or Backup NO engaged
17.11	High NO	High Priority Visual [flash red] and audible	Activated when the NO monitored value is greater than the user adjusted High NO alarm setting (5 -100ppm)
17.12	High NO₂	High Priority Visual [flash red] and audible	Activated when the NO ₂ monitored value is greater than the user adjusted High NO ₂ alarm setting (1 – 5ppm).
17.13	High O₂	High Priority Visual [flash red] and audible	Activated when the O ₂ monitored value is greater than the user adjusted High O ₂ alarm setting (21 – 100%).
17.14	Invalid Filter	Low priority Visual (yellow) and audible	Invalid NO ₂ filter detected. Active only when NO dose is set to 0 ppm
17.16	Invalid Filter	High Priority Visual [flash red] and audible	Invalid NO ₂ filter detected. Active when NO is set to >0ppm or Backup NO System activated.
17.17	Low Battery	Low Priority Visual (yellow) and audible	Battery voltage < 30% (approximately 30 minutes remaining)
17.18	Low Battery	High Priority Visual [flash red] and audible	Battery voltage < 10% (approximately 10 minutes remaining)

17.19	Low NO	High Priority Visual [flash red] and audible	Activated when the NO monitored value is less than the user adjusted Low NO alarm setting (range 0 to 70 ppm).
17.20	Low O ₂	High Priority visual [flash red] and audible	Activated when the O ₂ monitored value is less than the user adjusted Low O ₂ alarm setting (18 – 90%).
17.21	Main Delivery Failure	High Priority Visual [flash red] and audible	Active when there has been a failure in the NO delivery due to an internal component failure.
17.22	Mains Power	Indicator Visual (green)	Mains power connected
17.23	Maint. Due <200hrs	Low Priority Visual (yellow) and audible	The 1000-hour preventative maintenance check is due within 200 hours.
17.24	Monitoring Failure	High Priority Visual [flash red] and audible	Internal failure(s) of the monitoring function; monitoring system is no longer functioning correctly or sample flow >350 mL/min for 10 seconds
17.25	NDM Backwards	High Priority Visual [flash red] and audible	When the NO delivery is set to above 0 ppm and the flow through the NDM is in the reverse direction (see Figure 6 for proper direction) *** Note: the LungFit PH will NOT deliver Nitric Oxide when the NDM is in backwards
17.26	NDM Failure	High Priority Visual [flash red] and audible	When the NO delivery is set to ON and the NDM is not detected; or a fault is detected with the NDM
17.27	NO Backup Failure	High Priority Visual [flash red] and audible	Selector Switch turned to Backup NO Injector Line position and flow through the NO Backup System < 700 mL/min for 10 seconds (1 L/min is specified flow rate)
17.28	NO Bagging Failure	High Priority Visual [flash red] and audible	Selector Switch turned to Bagging System and NO flow < 700 mL/min for 10 seconds (1 L/min is specified flow rate)
17.29	NO ₂ Filter Expired	Low Priority Visual (yellow) and audible	The NO ₂ filter expiry date has passed, measured as 1 st day after the expiry date on the filter package label
17.30	NO Sensor Fail	High Priority Visual [flash red] and audible	Internal NO sensor problem
17.31	NO ₂ Sensor Fail	High Priority Visual [flash red] and audible	Internal NO ₂ sensor problem
17.32	O ₂ Sensor Fail	High Priority Visual [flash red] and audible	Internal O ₂ sensor problem
17.33	Sample Line Blocked	High Priority Visual [flash red] and audible	Gas sample flow rate is less than 180 mL/min for 5 seconds

18. TROUBLESHOOTING GUIDE

When you see this alarm...	Do this...
<p style="text-align: center;">Filter Not Detected</p> <p>(High Priority: NO set > 0ppm) (Low Priority: NO set = 0ppm)</p>	<ul style="list-style-type: none"> ○ If an NO₂ filter is NOT installed: <ul style="list-style-type: none"> ▪ NO cannot be delivered through the Injector Line! ▪ Install an NO₂ filter, or, ▪ Use Bagging System with Manual Resuscitator ○ If an NO₂ filter IS installed: <ul style="list-style-type: none"> ▪ Note: <ul style="list-style-type: none"> • NO will continue to be generated if NO set >0ppm prior to alarm • NO cannot be set if NO set at 0ppm prior to alarm ▪ Install a new NO₂ filter, or, ▪ Use Bagging System with Manual Resuscitator ○ Replace LungFit PH if alarm does not clear • See Figure 42 for algorithm
<p style="text-align: center;">High NO</p> <p>(High Priority)</p>	<ul style="list-style-type: none"> • Note: If monitored NO level is above 100ppm, system will automatically switch to Backup System until machine is powered down • Ensure alarm is set to a clinically appropriate level <ul style="list-style-type: none"> ▪ If NO value is within 20% of set NO value, adjust to 20% of set NO value ▪ If NO value is NOT within 20% of set NO value: <ul style="list-style-type: none"> ○ Complete zero calibration and check sensor accuracy by measuring NO calibration gas ○ Ensure ventilator flow range is within operating specifications of the LungFit PH ○ Complete NO sensor calibration, if possible ▪ Replace LungFit PH if alarm does not clear • See Figure 43 for algorithm
<p style="text-align: center;">High NO₂</p> <p>(High Priority)</p>	<ul style="list-style-type: none"> • Ensure alarm is set to a clinically appropriate level <ul style="list-style-type: none"> ▪ If NO₂ level is above a clinically appropriate level: <ul style="list-style-type: none"> ○ Decrease FiO₂ (if appropriate) ○ Decrease NO (if appropriate) ○ Increase ventilator bias flow (if possible) ○ Change NO₂ filter • Replace LungFit PH if alarm does not clear • See Figure 44 for algorithm
<p style="text-align: center;">Low O₂</p> <p>(High Priority)</p>	<ul style="list-style-type: none"> • Ensure alarm is set to clinically appropriate level • Adjust FiO₂ using the ventilator settings

When you see this alarm...	Do this...
<p style="text-align: center;">Low Battery</p> <p>(High Priority: <10% battery life) (Low Priority: <30% battery life)</p>	<ul style="list-style-type: none"> ○ Check power cord connection to LungFit PH and power source ○ Unplug and re-plug power cord to LungFit PH ○ Unplug and re-plug cord to power source ● If above steps do not return Mains Power message in screen <p>STATUS Section: Replace LungFit PH</p> <p>See Figure 45 for algorithm</p>
<p style="text-align: center;">Main Delivery Failure</p> <p style="text-align: center;">(High Priority)</p>	<p>Main Generator not delivering NO while alarm is active!</p> <ul style="list-style-type: none"> ● Initiate Backup System <ul style="list-style-type: none"> ○ Switch to Backup NO (delivered through Injector Line), or, ○ Switch to Bagging System (delivered with Manual Resuscitator) ● Note: If monitored NO level > 100ppm, system will <u>automatically</u> switch to Backup System until machine is powered down <ul style="list-style-type: none"> ○ NO is generated by Backup System whether switch is in Main or Backup NO position ○ NO will be delivered at 1 L/min and 220 ppm through the injector line ○ Bagging system will continue to perform normally at 1 L/min and 220 ppm ● Replace LungFit PH ● See Figure 46 for algorithm
<p style="text-align: center;">Monitoring Failure</p> <p style="text-align: center;">(High Priority)</p>	<p>Monitored gas values may not be accurate when this alarm is active!</p> <ul style="list-style-type: none"> ○ Disconnect filter from LungFit PH, then plug end of filter (to prevent vent leak) ● If alarm does not clear within 30 seconds with open inlet, replace LungFit PH ● See Figure 47 for algorithm
<p style="text-align: center;">NDM Backwards</p> <p style="text-align: center;">(High Priority)</p>	<p>NO will not be delivered if Selector Switch in <i>MAIN System</i> position!</p> <p>Note: Active only when NO set > 0 ppm</p> <ul style="list-style-type: none"> ● Steps: <ol style="list-style-type: none"> 1. Check that NDM is in correct orientation relative to flow <ul style="list-style-type: none"> ▪ arrow points in direction of flow ▪ correct orientation if required 2. If NDM was already in correct position: <ul style="list-style-type: none"> ▪ Initiate Backup System <ul style="list-style-type: none"> ● Switch to Backup NO Injector Line, or, ● Switch to Bagging System with Manual Resuscitator ▪ Replace NDM ▪ Check/Troubleshoot circuit flow ● Replace LungFit PH if alarm does not clear ● See Figure 48 for algorithm

When you see this alarm...	Do this...
<p style="text-align: center;">NDM Failure (High Priority)</p>	<p>NO will not be delivered if Selector Switch in <i>MAIN System</i> position! Note: Active only when NO set > 0 ppm</p> <ul style="list-style-type: none"> • Initiate Backup System <ul style="list-style-type: none"> ○ Switch to Backup NO Injector Line, or, ○ Switch to Bagging System with Manual Resuscitator • Steps (in order, until alarm resolution): <ol style="list-style-type: none"> 1. Replace NDM cable 2. Replace NDM • Replace LungFit PH if alarm does not clear • See Figure 49 for algorithm
<p style="text-align: center;">NO Backup Failure (High Priority)</p>	<p>NO is not being delivered through the Injector Line! Note: Active only when Selector Switch in <i>Backup NO Injector Line</i> position</p> <ul style="list-style-type: none"> • Check/correct Injector Line for kink or blockage • If no obstruction found, switch to alternative method of NO delivery: <ul style="list-style-type: none"> ○ Use Bagging System with Manual Resuscitator, or, ○ Use MAIN System (if possible) • Replace LungFit PH <p>See Figure 50 for algorithm</p>
<p style="text-align: center;">NO Bagging Failure (High Priority)</p>	<p>NO is not being delivered through the Bagger Connector! Note: Active only when Selector Switch in <i>Bagging System</i> position</p> <ul style="list-style-type: none"> • Check/correct resuscitator supply tubing for kink or blockage <ul style="list-style-type: none"> ○ Continue using device if blockage found and alarm cleared • If no obstruction found, switch to alternative method of NO delivery: <ul style="list-style-type: none"> ○ Use MAIN System (if possible) • Replace LungFit PH <p>See Figure 51 for algorithm</p>
<p style="text-align: center;">NO/NO₂/O₂ Sensor Failure (High Priority)</p>	<ul style="list-style-type: none"> • If alarm activated during normal use, replace LungFit PH • If alarm activated during sensor calibration: <ul style="list-style-type: none"> ○ Confirm appropriate calibration gas ○ Check calibration circuit for leaks ○ Recalibrate sensor <ul style="list-style-type: none"> ▪ If alarm does not clear, replace LungFit PH <p>See Figure 52 for algorithm</p>

When you see this alarm...	Do this...
<p style="text-align: center;">Sample Line Blocked (High Priority)</p>	<p>Monitored gas values may not be accurate when this alarm is active!</p> <ul style="list-style-type: none"> • Disconnect Sample Line Filter from LungFit PH, plug end of Sample Line Filter (to prevent vent leak) <ul style="list-style-type: none"> ○ If alarm does NOT clear, replace LungFit PH ○ If alarm clears, replace Sample Line and Sample Line Filter ○ If alarm re-activates with new sample line and filter, replace LungFit PH ○ If alarm does NOT reactivate, continue with current LungFit PH • see Figure 53 for algorithm
<p style="text-align: center;">Change Bagging Filter (Low Priority)</p>	<ul style="list-style-type: none"> • Replace the LungFit PH and return the current device to be serviced to replace the internal Bagging Filter

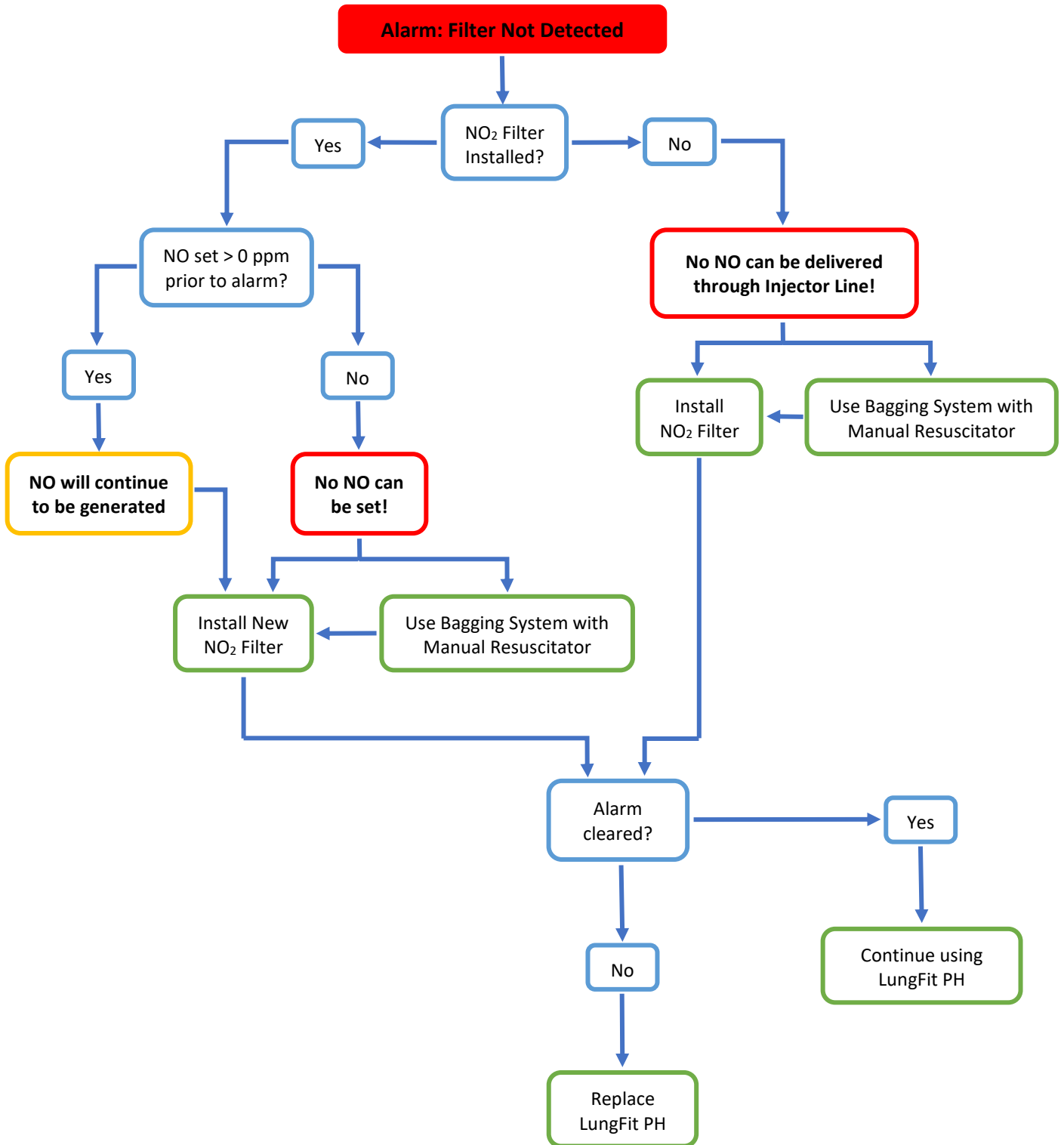

Figure 42: Filter Not Detected Algorithm

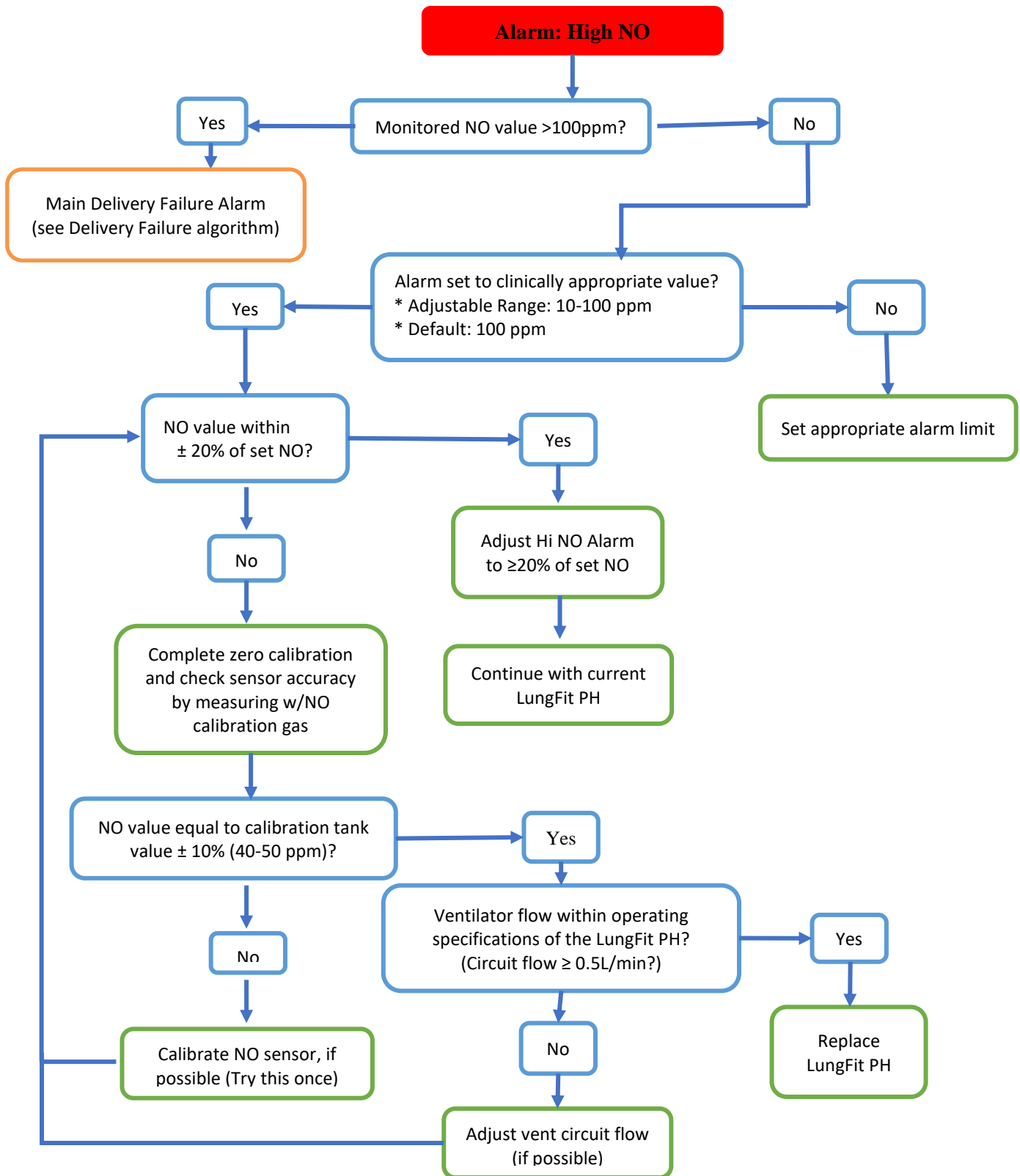

Figure 43: High NO Alarm Algorithm

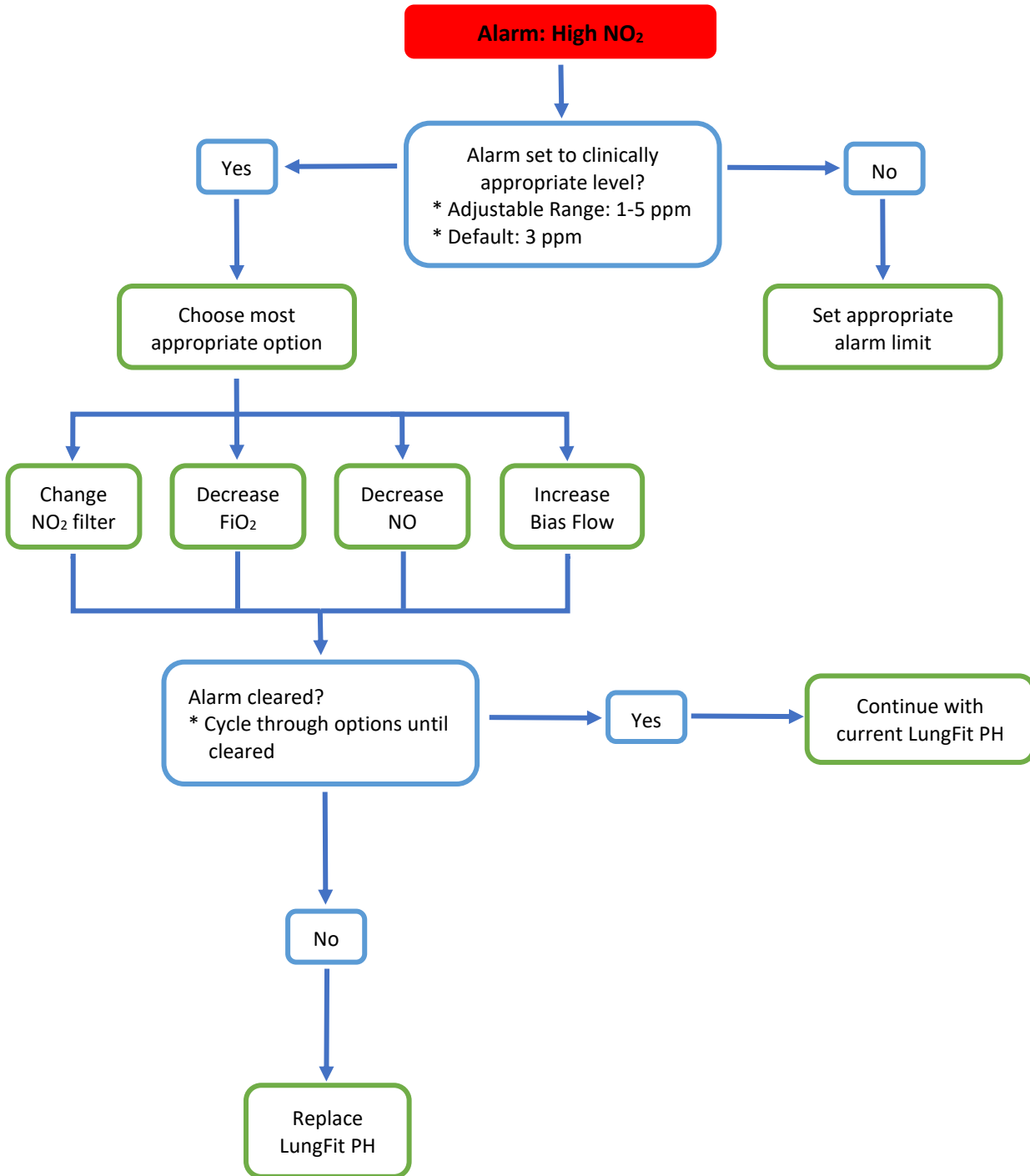

Figure 44. High NO₂ Alarm Algorithm

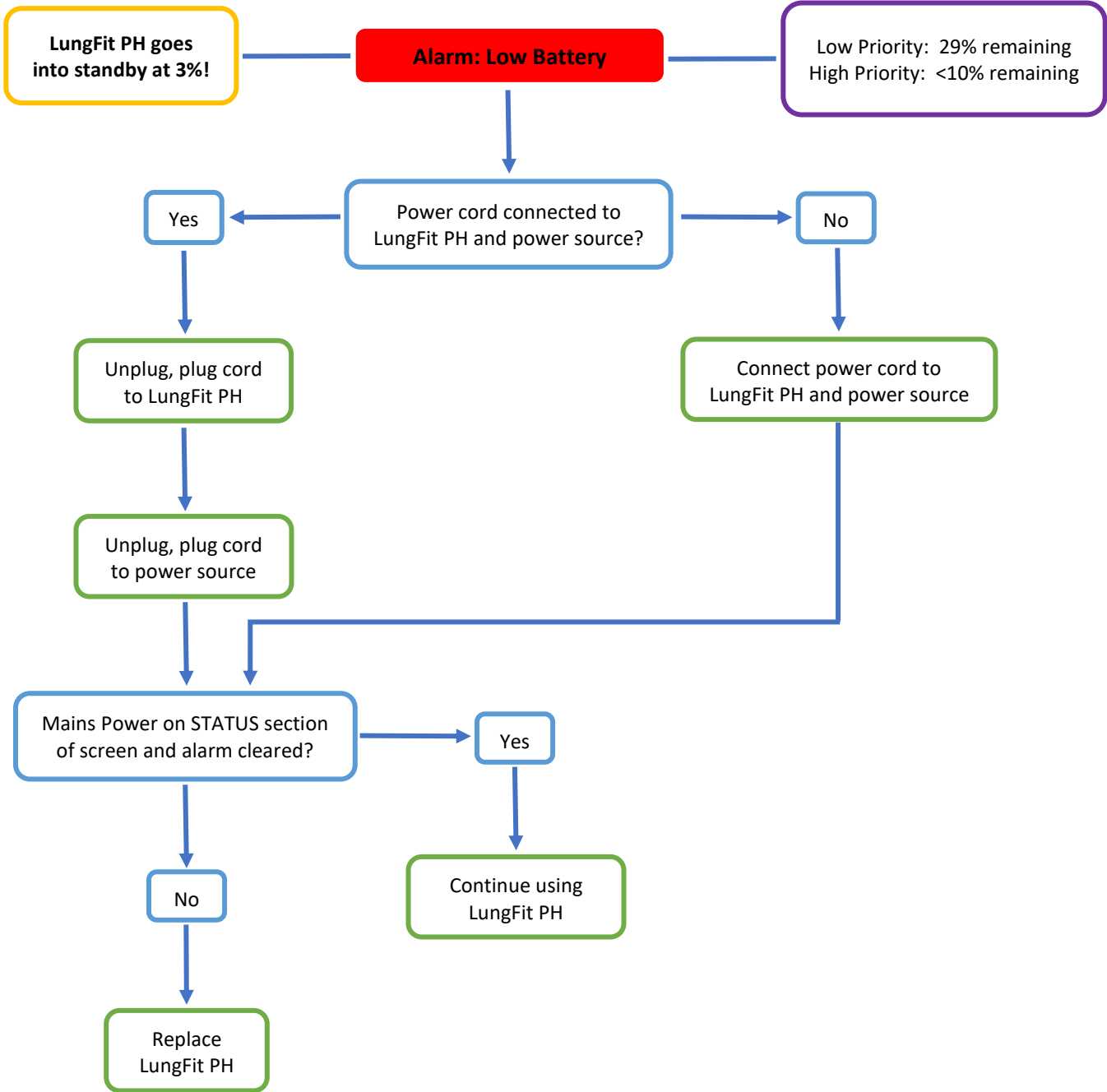

Figure 45: Low Battery Alarm Algorithm

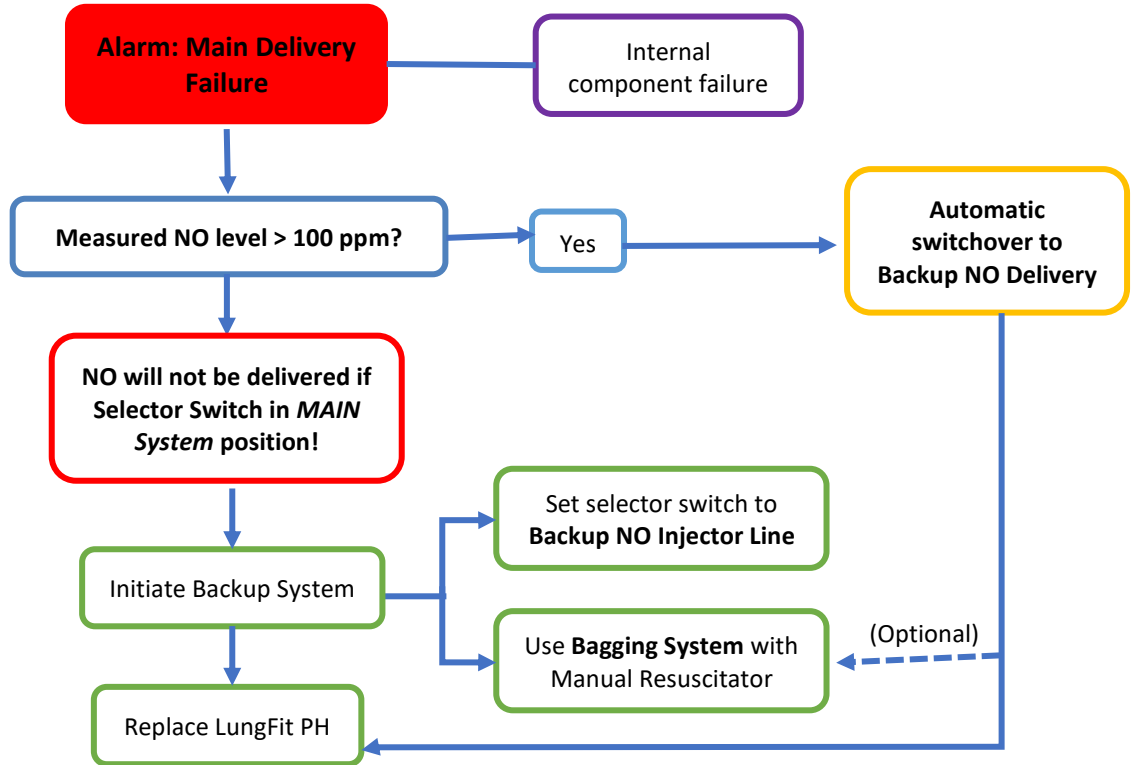

Figure 46: Delivery Failure Algorithm

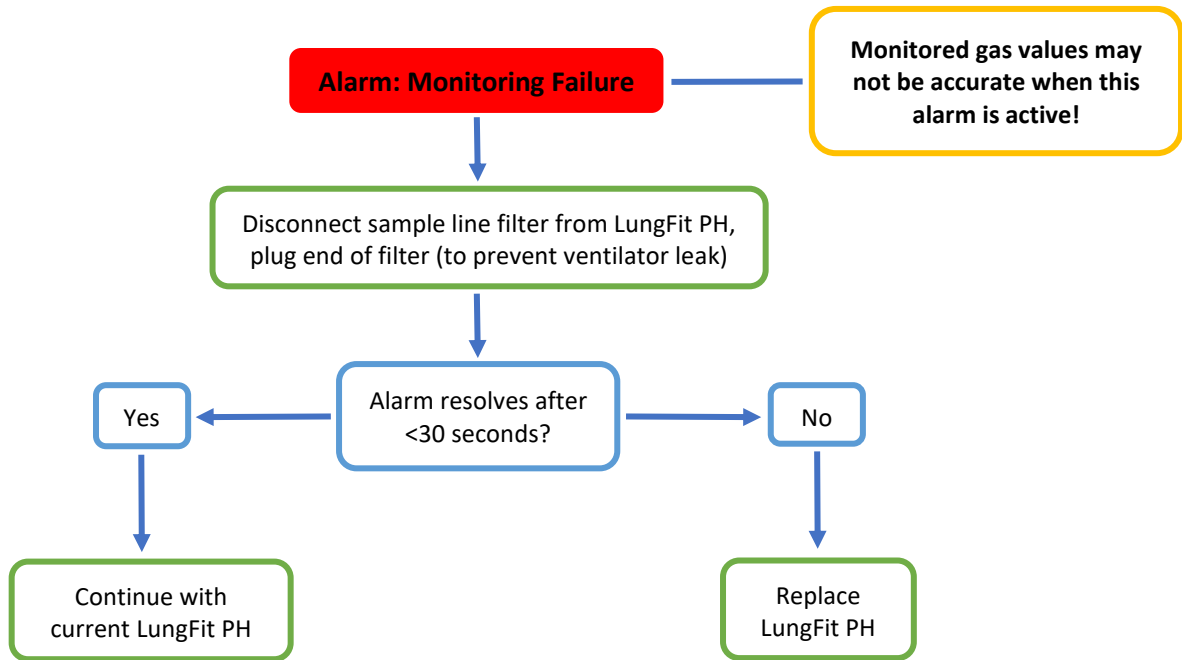

Figure 47: Monitoring Failure Alarm Algorithm

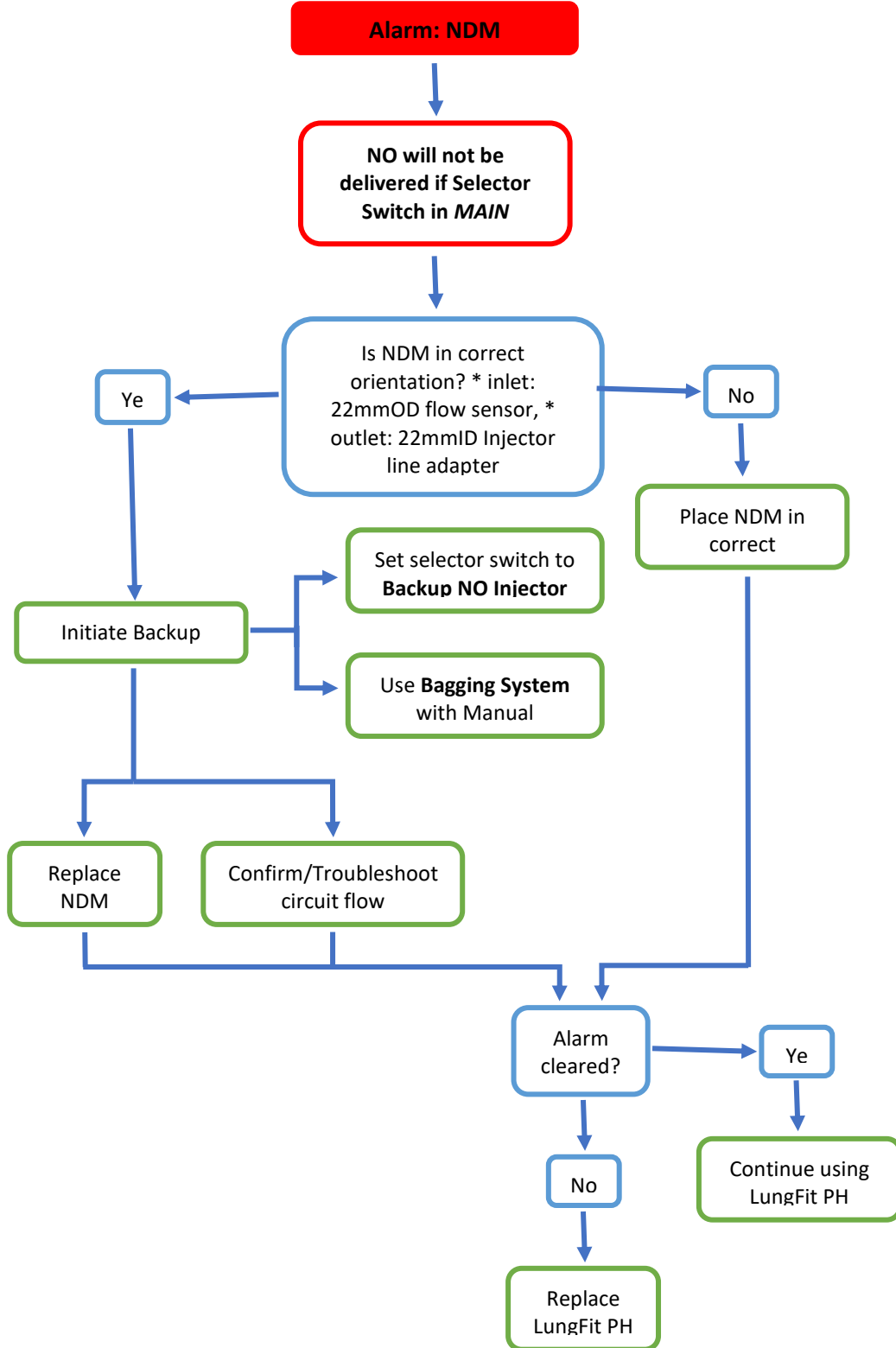

Figure 48: NDM Backwards Alarm Algorithm

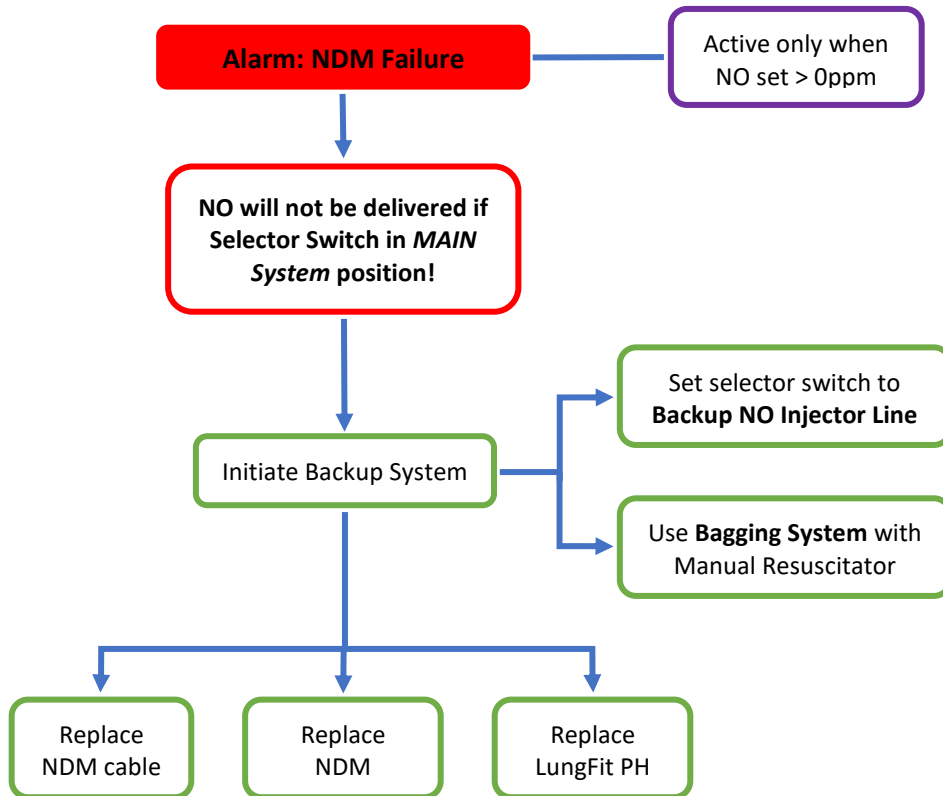

Figure 49: NDM Failure Alarm Algorithm

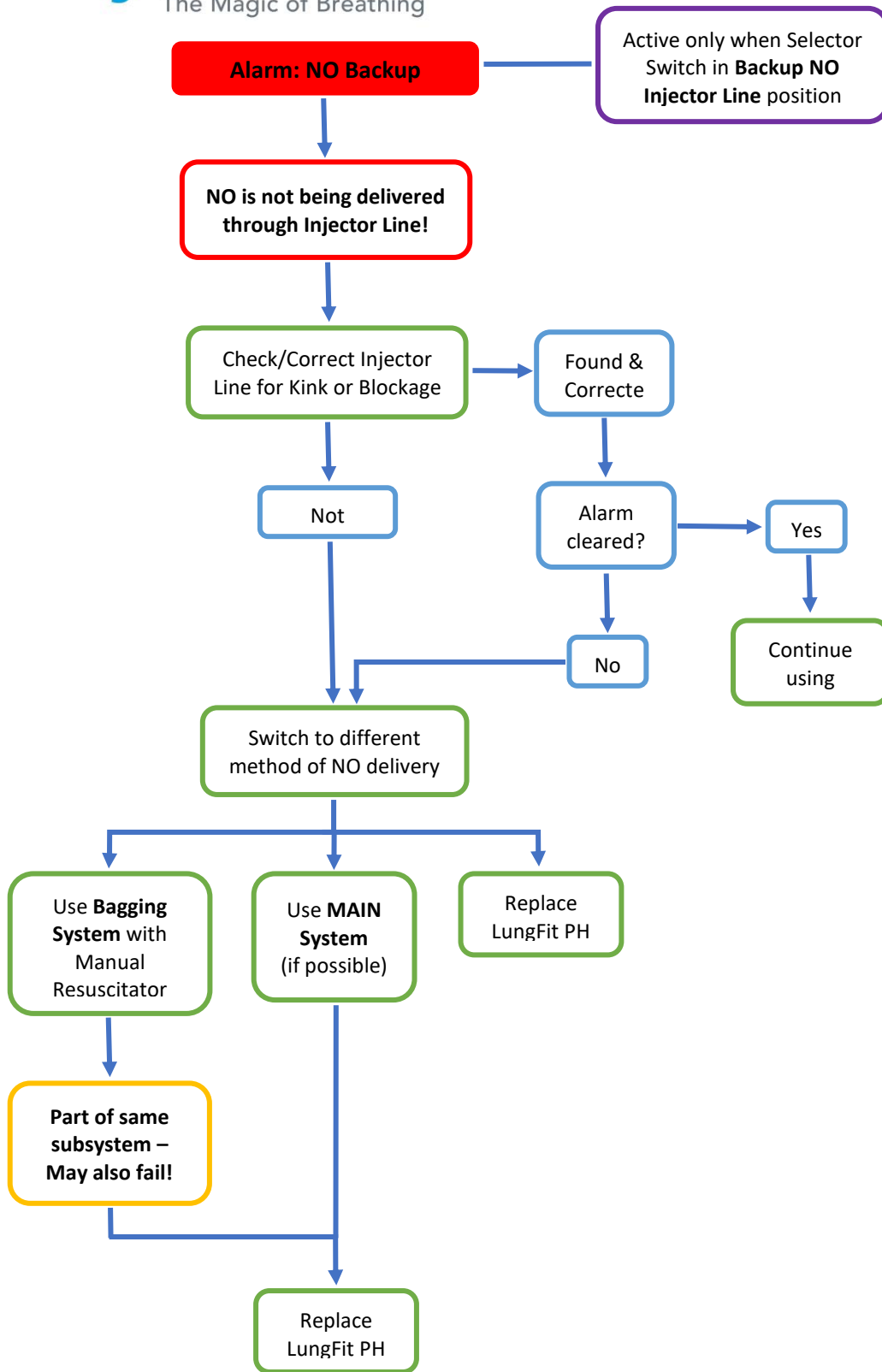

Figure 50: NO Backup Failure Alarm Algorithm

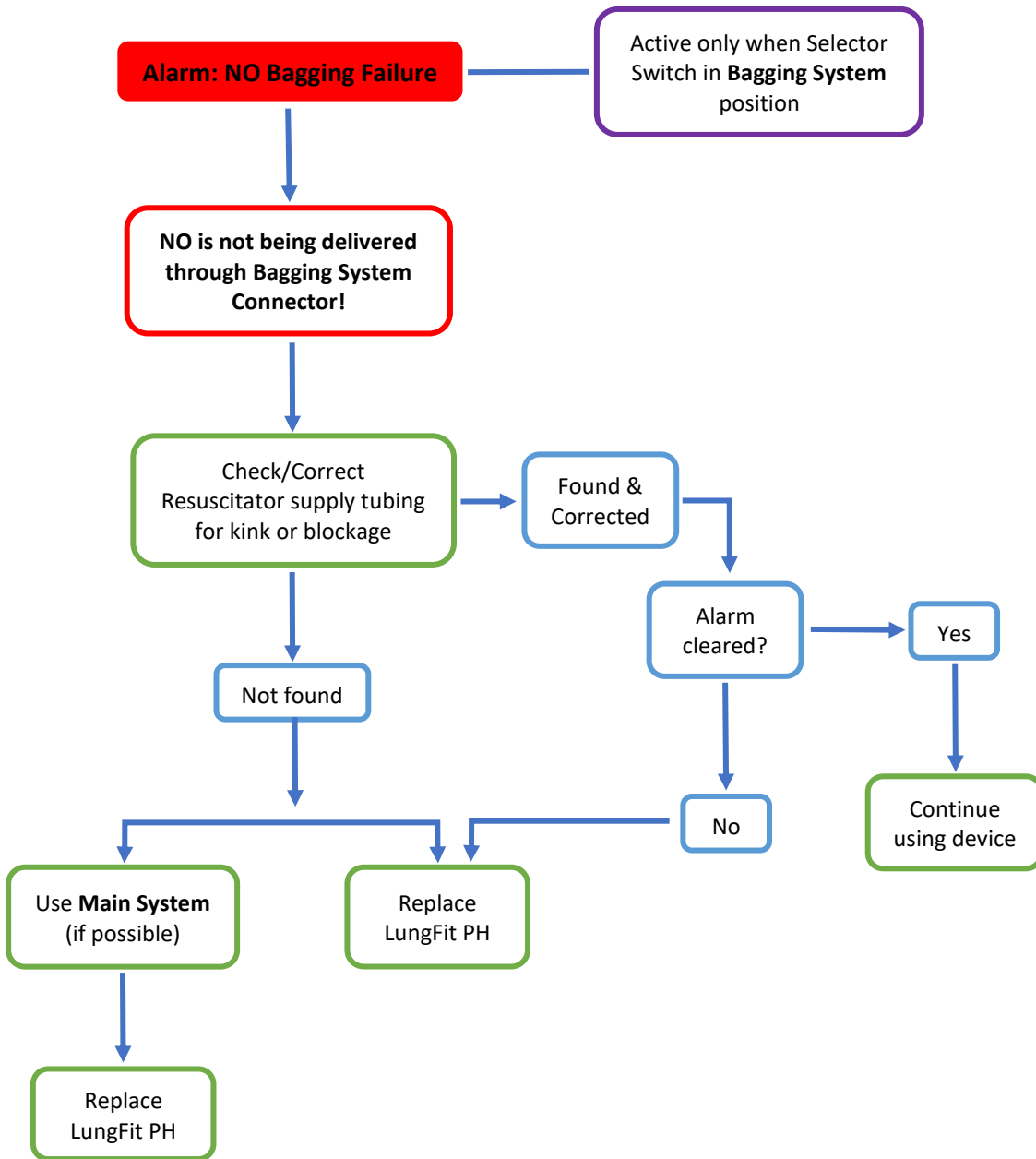

Figure 51: NO Bagging Failure Alarm Algorithm

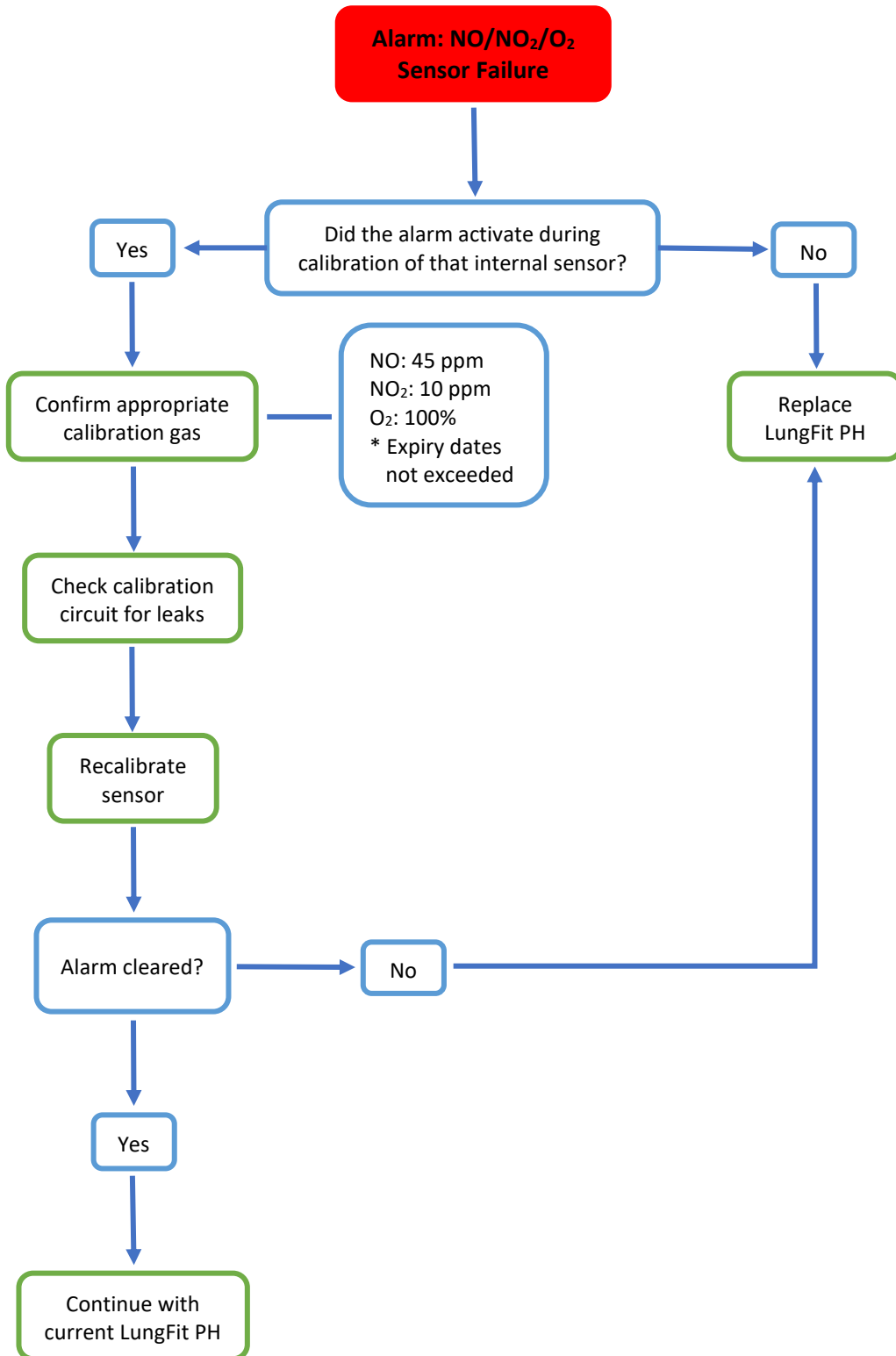

Figure 52: NO/NO₂/O₂ Sensor Failure Algorithm

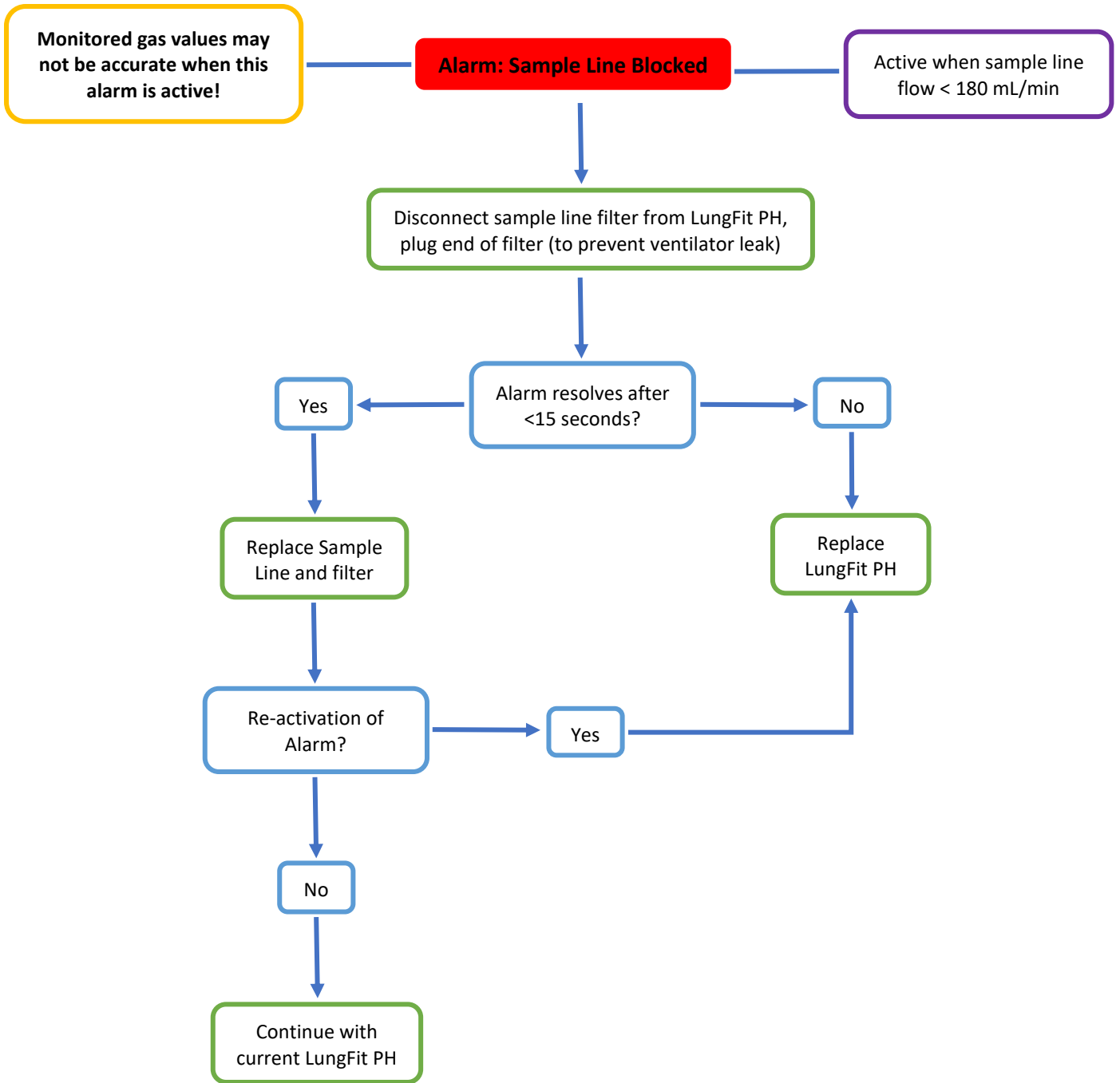

Figure 53: Sample Line Blocked Alarm Algorithm

18.1. Common Problems Encountered

SYMPTOM	CAUSE	ACTION
Screen remains blank when unit is powered up. Pump will not run when unit is powered on.	<ol style="list-style-type: none"> 1. Internal battery has become discharged. 2. Internal battery requires replacement. 	<ol style="list-style-type: none"> 1. Plug “Universal Power Supply” into the Device and allow to charge for at least 30 min. 2. Replace the battery.
NO sensor will not return to zero	<ol style="list-style-type: none"> 1. Sensor has been exposed to high levels of NO 	<ol style="list-style-type: none"> 1. A temporary shift in the zero level is expected if level of NO has been 40 ppm or higher for at least 30 minutes. 2. If not in high dose NO as described above, check for proper zero level of sensors by placing the sample line in room air for 5 minutes. If still above zero, zero the sensors according to <i>Section 16.1</i>
Low NO readings	<ol style="list-style-type: none"> 1. Ventilator flow < 0.5 L/min 2. Leak in NO delivery lines 3. Incorrect NO calibration 4. NDM flow sensor malfunction 5. Incorrect NO generation 	<ol style="list-style-type: none"> 1. Check flow on ventilator 2. Check NO line and filter connections. Check sample line connection. 3. Check calibration with calibration gas 4. Replace NDM 5. Replace the Device

19. COMPATIBLE VENTILATORS

19.1. Ventilator List

The LungFit PH system has been validated for use with the following ventilators:

Ventilator	Validated Modes
Dräger BabyLog® VN500 (Neonatal patient range)	PC-A/C PC-CMV PC-SIMV Volume Guarantee PC-APRV PC-PSV PC-MMV * Flow Triggering
Vyaire Medical Bellavista™ 1000 (Neonatal patient range)	PCV P-AC PC-SIMV PSV Target Vent * Flow Triggering
Vyaire Medical 3100A	HFOV Note: has not been validated with a one-way valve
Hamilton Medical HAMILTON-C1 (Neonatal patient range)	PCV+ PSIMV+ SPONT SIMV+ (S)CMV+ * Flow Triggering

19.2. Ventilator Specification Window

Ventilator settings that are within the LungFit PH operating specifications:

Ventilator parameter	Setting range
Inspiratory Flow Rate	0.5 - 50 l/min, 0.5 – 120 l/min (\leq 40ppm NO)
Bias Flow	0.5 to 40 l/min
PEEP	Up to 40 cmH ₂ O
Peak Inspiratory Pressure	\leq 60 cmH ₂ O
Respiratory Rate	Traditional Ventilators: 6 - 60 bpm, HFOV: 2 - 15 Hz

19.3. Device Effects on Ventilator

There are two main effects of connecting and using the LungFit PH in a ventilator breathing circuit:

- The LungFit PH subtracts gas from the breathing circuit via the sample line, which withdraws approximately 230 mL/min of gas flow from the ventilator breathing circuit.
- The LungFit PH adds additional gas (NO + ambient air) into the breathing circuit:
 - For peak flow rates up to 50 L/min, the LungFit PH adds 10% more gas to that delivered by the ventilator, regardless of NO setting.

$$O_{2\text{delivered}}(\%) = \frac{O_{2\text{set}} + 2.1}{1.1}$$

e.g., for set O₂ 60%: $O_{2\text{delivered}} = \frac{60+2.1}{1.1} = 56.4\%$

Vent. Set (%)	100	90	80	70	60	50	40	30	21
Patient (%)	93	84	75	66	56	47	38	29	21

- For peak flow rates above 50 L/min, the added gas is proportional to the NO:

$$\text{Dilution ratio} = D_r = \frac{\text{NO dose}[\text{ppm}]}{(880 - \text{NO dose}[\text{ppm}])}$$

$$O_{2\text{delivered}}(\%) = \frac{O_{2\text{set}} + (21 * D_r)}{1 + D_r}$$

e.g., for O_{2, set} 60% and NO_{set} 20ppm: $O_{2\text{delivered}} = 60 * \left(\frac{60 + (21 * 0.023)}{1.023} \right) = 59.1\%$

O ₂ setting (%)	80 ppm NO set	40 ppm NO set	20 ppm NO set	10 ppm NO set	5 ppm NO set
Ratio (D_r)	0.100	0.048	0.023	0.011	0.006
100	93	96	98	99	100
90	84	87	88	89	90
80	75	77	79	79	80
70	66	68	69	69	70
60	56	58	59	60	60
50	47	49	49	50	50
40	38	39	40	40	40
30	29	30	30	30	30
21	21	21	21	21	21

The effects of adding and subtracting gas from the ventilator breathing circuit include:

- Oxygen Dilution: The LungFit PH adds gas to the breathing circuit as described above. Thus, the O₂ concentration is reduced from its original value. Delivered O₂ is monitored and displayed by

the LungFit PH, but **must be adjusted on the ventilator**.

- Tidal Volume and Minute Volume: The measured tidal volume and minute volume delivered to the patient may show changes due to the addition and subtraction of gases by the delivery system.
- Trigger Sensitivity: The addition and subtraction of gases by the LungFit PH may affect the trigger sensitivity of the ventilator when using synchronized modes of ventilation. This may cause the ventilator to auto-cycle (auto-trigger) in ventilators which have flow trigger modes, especially where the trigger flow is set to less than 1 L/min. Check the trigger sensitivity of the ventilator after connecting the LungFit PH delivery system.

20. CLEANING AND REPROCESSING

20.1. Cleaning during use

Clean any visible soil from the external surface of the LungFit PH delivery system and NDM cable by wiping it with a cloth dampened with an approved cleaning agent.

- **Do not** use alcohol on the liquid crystal display.
- **Do not** immerse or allow water or any other liquid to enter the device or housings.

20.2. Reprocessing between uses

Wipe down the external surfaces of the LungFit PH device and NDM cable with a cloth moistened with an approved cleaning agent to remove surface soils.

- **Do not** use alcohol on the liquid crystal display.
- **Do not** immerse or allow water or any other liquid to enter the device or housings.

Following cleaning, disinfect external surfaces of the LungFit PH device and NDM cable with a cloth or wipe dampened with an approved bactericidal agent.

- **Do not** use alcohol on the liquid crystal display.
- **Do not** immerse or allow water or any other liquid to enter the device or housings.

20.3. Approved cleaning and bactericidal agents

- Approved cleaning agent:
 - Mild detergent (Alconox or equivalent)
 - For cleaning the exterior of the device and NDM cable when diluted per manufacturer instructions

- Approved bactericidal agent:
 - Cavicide and CaviWipes by Metrex
 - For disinfection of the exterior of the device and NDM cable when diluted per manufacturer instructions (as applicable).
 - Active ingredients:
 - Diisobutylphenoxyethoxyethyl dimethyl benzyl ammonium chloride 0.28%
 - Isopropyl alcohol 17.2%
 - Inert ingredients 82.52%

All routine maintenance, repairs, and replacement of standard parts will be conducted by Beyond Air Inc. or its representatives.

Internal Components <i>Changed by technical service</i>
Bagging Filter
O ₂ , NO, and NO ₂ Sensors
Batteries



CAUTION:

- DO NOT sterilize.
- DO NOT clean any parts with acetone or other strong solvents.
- DO NOT immerse or allow water or any other liquid to enter the device or housings.

21. SPECIFICATIONS

21.1. Nitric Oxide Delivery Specifications

- **NO Delivery Range**
 - 0 – 80 ppm for ventilator flows < 50 L/min
 - Progressively lower than 80 ppm for ventilator flows 50 – 100 L/min
 - Maximum of 40 ppm at 100 L/min
- **Maximum Breathing Circuit Pressure**
 - 60 cmH₂O
- **Set NO Resolution**
 - 0.1 from 0 – 2 ppm
 - 1 from 2 – 80 ppm
- **NO Delivery Accuracy**
 - ± 20% or 2 ppm, whichever is greater

21.2. Analyzer and Sensor Specifications

- **Measurement Range**
 - **NO**

▪ Range:	0 to 100 ppm
▪ Resolution:	
• 0 to 2 ppm	0.1 ppm
• 2-100 ppm	1 ppm
▪ Accuracy:	
• 0 to 20 ppm:	± (20% + 0.5 ppm)
• 20 to 100 ppm:	± (10% + 0.5 ppm)
▪ Rise Time	<30 seconds (10 – 90 %)
 - **NO₂**

▪ Range:	0 to 10 ppm
▪ Resolution:	0.1 ppm
▪ Accuracy:	± (20% or 0.5 ppm, whichever is greater)
▪ Rise Time	<30 seconds (10 – 90 %)
 - **O₂**

▪ Range:	18 – 100% v/v
▪ Resolution:	1 %
▪ Accuracy:	± 3 % O ₂ v/v
▪ Total response time	<30 seconds

- Rise Time <20 seconds (10 – 90 %)
- Maximum breathing circuit pressure: 70 cmH₂O
- Calibration: Daily zero (*see Section 16.1*), calibrate as needed (*see Sections 16.2-16.4*)
- Rise Time: <30 seconds (10 – 90 %)
- Sample Flow: 230 mL/min ± 10%

21.3. Flow Sensor

Flow range: 0.5 to 120 L/min

21.4. Oxygen Monitor

- There is no automatic barometric pressure compensation on the oxygen monitor reading.
- The time from turn on to meeting the Oxygen accuracy is 30 seconds.

21.5. Physical

- Maximum Weight: 20 kg
- Maximum Width and Depth: W 500 x D 380 mm
- Maximum Height: 480 mm

21.6. Battery

- Type: Lithium Ion (2)
 - Voltage 14.40 V
 - Capacity 6.90 Ah
- Backup time: 4 hours (2 hours each)

21.7. Environmental

- Temperature:
 - Operating: 10 to 35°C
 - Storage: -20 to + 60°C
- Humidity: 15 – 95 % RH, non-condensing
- Ambient Pressure:
 - Operating 600 to 800 mmHg
 - Storage 375 to 800 mmHg
- Water Ingress Protection: IPX1

21.8. Electrical

- Input Voltage: 100-240 VAC @ 50/60 Hz
- Input Power: 80 Watts
- Classification: Medical Grade, Class I, Type B

21.9. User Applied Parts

- There are no user applied electrical parts. The NDM Flow Sensor and Sample Line for the LungFit PH are treated as applied parts as per BS EN 60601-1: 2012-08 Section 4.6



WARNING: Follow all local, state, and federal regulations with respect to environmental protection when disposing of batteries and electrochemical sensors.

22. ELECTROMAGNETIC COMPATIBILITY INFORMATION

Guidance and Manufacturer's Declaration – Electromagnetic Immunity			
The system is intended for use in the electromagnetic environment specified below. The user of the system should assure that it is used in such an environment.			
Immunity Test	IEC 60601-1-2 test level	Compliance Level	Electromagnetic Environment Guidance
Electrostatic discharge (ESD) IEC 61000-4-2	± 4, 8 kV contact ± 2, 4, 8, 15 kV Air	± 4, 8 kV Contact ± 2, 4, 8, 15 kV Air	The relative humidity should be at least 15%.
Electrical fast transient/burst IEC 61000-4-4	± 2 kV for power supply lines ± 1 kV for input/output lines	± 2 kV for power supply lines ±1 kV for input/output Lines	Mains power quality should be that of a typical commercial or hospital environment.
Surge IEC 61000-4-5	± 1 kV Line(s) to Line(s) ± 2 kV Line(s) to earth	± 1 kV Line(s) to Line(s) ± 2 kV Line(s) to earth	Mains power quality should be that of a typical commercial and/or hospital environment.
Voltage dips, short interruptions and voltage variations on power supply input lines IEC 61000-4-11	0 % UT (100 % dip in UT) for 0,5 cycle occurring at 0°, 45°, 90°, 135°, 180°, 225°, 270°, 315° 0 % UT (100 % dip in UT) for 1 cycle occurring at 0° 70 % UT (30 % dip in UT) for 25/30 cycles Voltage interruption at test Voltage level: 0 % UT 100 % dip in UT for 250/300 cycles	0 % UT (100 % dip in UT) for 0,5 cycle occurring at 0°, 45°, 90°, 135°, 180°, 225°, 270°, 315° 0 % UT (100 % dip in UT) for 1 cycle occurring at 0° 70 % UT (30 % dip in UT) for 25/30 cycles Voltage interruption at test Voltage level: 0 % UT 100 % dip in UT for 250/300 cycles	Mains power quality should be that of a typical commercial and/or hospital environment. If the user of the system requires continued operation during power mains interruptions, it is recommended that the system be powered from an uninterruptible power supply or a battery.
Power frequency (50/60 Hz) magnetic field IEC 61000-4-8	30 A/m Home Healthcare	30 A/m	Home Healthcare Levels

Guidance and Manufacturer’s Declaration – Electromagnetic Immunity

The system is intended for use in the electromagnetic environment specified below. The user of the system should assure that it is used in such an environment.

Immunity Test	IEC 60601 test level	Compliance Level	Electromagnetic Environment Guidance
Conducted RF IEC 61000-4-6	3 Vrms 150 kHz to 80 MHz outside ISM bands 6 Vrms 150 kHz to 80 MHz in ISM bands	3 Vrms (V1) 6 Vrms (V2)	Portable and mobile RF communications equipment, including cables, should be used no closer to any part of system than the recommended separation distance calculated from the equation applicable to the frequency of the transmitter. Recommended separation distance: $d=3.5*\sqrt{P /V1}$ $d=12*\sqrt{P /V2}$
Radiated RF IEC 61000-4-3	10 V/m 80 MHz to 2.7 GHz	10 V/m 26 MHz to 2.7 GHz (E1)	$d=12*\sqrt{P /E1}$ 80 MHz to 800 MHz $d=23*\sqrt{P /E1}$ 800 MHz to 2.7 GHz Where P is the maximum output power rating of the transmitter in watts (W) according to the transmitter manufacturer and d is the recommended separation distance in meters (m). ^b Field strengths from fixed RF transmitters, as determined by an electromagnetic site survey, ^c should be less than the compliance level in each frequency range. ^d Interference may occur in the vicinity of equipment marked with the following symbol: 

Proximity fields from RF wireless communications equipment	380 - 390 MHz 27 V/m; PM 50%; 18 Hz	380 - 390 MHz 27 V/m; PM 50%; 18 Hz	Portable RF communications equipment (including peripherals such as antenna cables and external antennas) should be used no closer than 30 cm (12 inches) to any part of the device, including cables specified by the manufacturer. Otherwise, degradation of the performance of this equipment could result.
	430 - 470 MHz 28 V/m; (FM ±5 kHz, 1 kHz sine) PM; 18 Hz	430 - 470 MHz 28 V/m; (FM ±5 kHz, 1 kHz sine) PM; 18 Hz	
	704 - 787 MHz 9 V/m; PM 50%; 217 Hz	704 - 787 MHz 9 V/m; PM 50%; 217 Hz	
	800 - 960 MHz 28 V/m; PM 50%; 18 Hz	800 - 960 MHz 28 V/m; PM 50%; 18 Hz	
	1700 - 1990 MHz 28 V/m; PM 50%; 217 Hz	1700 - 1990 MHz 28 V/m; PM 50%; 217 Hz	
	2400 - 2570 MHz 28 V/m; PM 50%; 217 Hz	2400 - 2570 MHz 28 V/m; PM 50%; 217 Hz	
	5100 - 5800 MHz 9 V/m; PM 50%; 217 Hz	5100 - 5800 MHz 9 V/m; PM 50%; 217 Hz	
<p>NOTES:</p> <ul style="list-style-type: none"> • At 80 MHz and 800 MHz, the higher frequency range applies. • These guidelines may not apply in all situations. Electromagnetic propagation is affected by absorption and reflection from structures, objects and people. 			
<p>a The ISM (industrial, scientific and medical) bands between 150 kHz and 80 MHz are 6.765 MHz to 6.795 MHz; 13.553 MHz to 13.567 MHz; 26.957 MHz to 27.283 MHz; and 40.66 MHz to 40.70 MHz.</p> <p>b The compliance levels in the ISM frequency bands between 150 kHz and 80 MHz and in the frequency range 80 MHz to 2.7 GHz are intended to decrease the likelihood that a portable communications device could cause interference if it is inadvertently brought into patient areas. For this reason, an additional factor of 10/3 is used in calculating the recommended separation distance for transmitters in these frequency ranges.</p> <p>c Field strengths from fixed transmitters, such as base stations for radio (cellular/cordless) telephones and land mobile radios, amateur radio, AM and FM radio broadcast and TV broadcast cannot be predicted theoretically with accuracy. To assess the electromagnetic environment due to fixed RF transmitters, an electromagnetic site survey should be considered. If the measured field strength in the location in which the LungFit system is used exceeds the applicable RF compliance level above, the LungFit system should be observed to verify normal operation. If abnormal performance is observed, additional measures may be necessary, such as reorienting or relocating the LungFit system.</p> <p>d Over the frequency range 150 kHz to 80 MHz, field strengths should be less than 3 V/m.</p>			



23.OCCUPATIONAL EXPOSURE

The exposure limit set by the Occupational Safety and Health Administration (OSHA) for nitric oxide is 25 ppm, and for NO₂ the limit is 5 ppm.

The environmental buildup of NO in a well-ventilated ICU room can be evaluated using the following calculation:

Room size 10ft square room =1000 ft³ or room volume = 28,300 L

Room ventilation (6 exchanges/hour) = 2,830 L/min

The NO flow into the room for 20 ppm at 20 L/min = 400 ppm. L/min

Average NO room concentration $400 \div 2,830 = 0.015$ ppm of NO

This theoretic calculation can be supplemented by measurements as performed by Hess et al (Hess et al, Use of Inhaled Nitric Oxide in patients with Acute Respiratory Distress Syndrome. Respiratory Care, 1996, vol. 41, No. 5, pg. 424-446.) The NO and NO₂ concentrations were measured using a chemiluminescence analyzer when 100 ppm of NO at 8 L/min was delivered into a room with no scavenging being used. The maximum NO and NO₂ concentrations measured over a one hour period were 0.12 ppm of NO and 0.03 ppm of NO₂ both well below OSHA limits.

24.INDICATIONS FOR USE

The NO from the LungFit PH System is indicated to improve oxygenation and reduce the need for extracorporeal membrane oxygenation in term and near-term (>34 weeks gestation) neonates with hypoxic respiratory failure associated with clinical or echocardiographic evidence of pulmonary hypertension in conjunction with ventilatory support and other appropriate agents.

25.CONTRAINDICATIONS

The NO from the LungFit PH is contraindicated in neonates dependent on right-to-left shunting of blood.

26. DOSAGE AND ADMINISTRATION

26.1. Dosage

Term and near-term neonates with hypoxic respiratory failure

The recommended dose of inhaled nitric oxide gas is 20 ppm. Maintain treatment up to 14 days or until the underlying oxygen desaturation has resolved and the neonate is ready to be weaned from inhaled nitric oxide therapy.

Doses greater than 20 ppm are not recommended.

26.2. Administration

Measure methemoglobin within 4-8 hours after initiation of treatment with the LungFit PH and periodically throughout treatment.

Monitor for PaO₂ and inspired NO₂ during NO administration.

Avoid abrupt discontinuation of NO. To wean NO down-titrate in several steps, pausing several hours at each step to monitor for hypoxemia.

27. WARNINGS AND PRECAUTIONS ASSOCIATED WITH NITRIC OXIDE (NO)

27.1. Rebound Pulmonary Hypertension Syndrome following Abrupt Discontinuation

Abrupt discontinuation of NO may lead to worsening oxygenation and increasing pulmonary artery pressure, i.e., Rebound Pulmonary Hypertension Syndrome. Signs and symptoms of Rebound Pulmonary Hypertension Syndrome include hypoxemia, systemic hypotension, bradycardia, and decreased cardiac output. If Rebound Pulmonary Hypertension occurs, reinstate NO therapy immediately.



WARNING: Avoid abrupt discontinuation of NO. To wean NO down, titrate in several steps, pausing several hours at each step to monitor for hypoxemia.



WARNING: Abrupt discontinuation of NO may lead to worsening oxygenation and increasing pulmonary artery pressure, i.e., Rebound Pulmonary Hypertension Syndrome. Signs and symptoms of Rebound Pulmonary Hypertension Syndrome include hypoxemia, systemic hypotension, bradycardia, and decreased cardiac output. If Rebound Pulmonary Hypertension occurs, reinstate NO therapy immediately.



27.2. Hypoxemia from Methemoglobinemia

Nitric oxide combines with hemoglobin to form methemoglobin, which does not transport oxygen. Methemoglobin levels increase with the dose of NO; it can take 8 hours or more before steady-state methemoglobin levels are attained. Monitor methemoglobin and adjust the dose of NO to optimize oxygenation.

If methemoglobin levels do not resolve with decrease in dose or discontinuation of NO, additional therapy may be warranted to treat methemoglobinemia

27.3. Airway Injury from Nitrogen Dioxide

Nitrogen dioxide (NO₂) forms in gas mixtures containing NO and O₂. Nitrogen dioxide may cause airway inflammation and damage to lung tissues.

If there is an unexpected change in NO₂ concentration, or if the NO₂ concentration reaches 3 ppm when measured in the breathing circuit, assess the delivery system in accordance with the troubleshooting section, and recalibrate the NO₂ sensor. Adjust the dose of NO and/or FiO₂ as appropriate.

27.4. Worsening Heart Failure

Patients with left ventricular dysfunction treated with NO may experience pulmonary edema, increased pulmonary capillary wedge pressure, worsening of left ventricular dysfunction, systemic hypotension, bradycardia and cardiac arrest. Discontinue NO while providing symptomatic care.

28. ADVERSE EVENTS

The following adverse reactions are discussed elsewhere in the label;

Hypoxemia [see Warnings and Precautions (27.2)]

Worsening Heart Failure [see Warnings and Precautions (27.4)]

28.1. Clinical Trials Experience

Because clinical trials are conducted under widely varying conditions, adverse reaction rates observed in the clinical trials of a drug cannot be directly compared to rates in the clinical trials of another drug and may not reflect the rates observed in practice. The adverse reaction information from the clinical studies does, however, provide a basis for identifying the adverse events that appear to be related to drug use and for approximating rates.

Controlled studies have included 325 patients on nitric oxide doses of 5 to 80 ppm and 251 patients on



placebo.^{1,2,3,3}. Mortality was similar in the two groups.

In both the NINOS and CINRGI studies, the duration of hospitalization was similar in nitric oxide and placebo-treated groups.

From all controlled studies, at least 6 months of follow-up is available for 278 patients who received nitric oxide and 212 patients who received placebo. Among these patients, there was no evidence of an adverse effect of treatment on the need for rehospitalization, special medical services, pulmonary disease, or neurological sequelae.

In the NINOS study,⁴ treatment groups were similar with respect to the incidence and severity of intracranial hemorrhage, Grade IV hemorrhage, periventricular leukomalacia, cerebral infarction, seizures requiring anticonvulsant therapy, pulmonary hemorrhage, or gastrointestinal hemorrhage.

28.2. Post-Marketing Experience

Post marketing reports of accidental exposure to nitric oxide for inhalation in hospital staff has been associated with chest discomfort, dizziness, dry throat, dyspnea, and headache.

29.DRUG INTERACTIONS

Nitric oxide donor agents such as prilocaine, sodium nitroprusside and nitroglycerine may increase the risk of developing methemoglobinemia.

30. USE IN SPECIFIC POPULATIONS

30.1. Pregnancy

Pregnancy Category C Animal reproduction studies have not been conducted with LungFit PH. It is not known if nitric oxide gas from the LungFit PH can cause fetal harm when administered to a pregnant woman or can affect reproductive capacity. NO is not indicated for use in adults.

¹ Analyzed subjects exclude pilot subjects and subjects with lung hypoplasia.

² Davidson, D., Barefield, E. S., Kattwinkel, J., Dudell, G., Damask, M., Straube, R., Rhines, J., Chang, C.-T., I-NO/PPHN Study Group. (1998). Inhaled Nitric Oxide for the Early Treatment of Persistent Pulmonary Hypertension of the Term Newborn: A Randomized, Double-Masked, Placebo-Controlled, Dose-Response, Multicenter Study. *Pediatrics*, 101(3), 325-334.

³ Clark, R. H., Kueser, T. J., Walker, M. W., Southgate, W. M., Huckaby, J. L., Perez, J.A., ..., & Kinsella, J. P. (2000). Low-dose nitric oxide therapy for persistent pulmonary hypertension of the newborn. *New England Journal of Medicine*, 342(7), 469-474.

⁴ Neonatal Inhaled Nitric Oxide Study Group. (1997). Inhaled nitric oxide in full-term and nearly full-term infants with hypoxic respiratory failure. *New England Journal of Medicine*, 336(9), 597-604.

30.2. Nursing Mothers

Nitric oxide is not indicated for use in the adult population, including nursing mothers. It is not known whether nitric oxide is excreted in human milk.

30.3. Pediatric Use

The safety and efficacy of nitric oxide for inhalation has been demonstrated in term and near-term neonates with hypoxic respiratory failure associated with evidence of pulmonary hypertension. Additional studies conducted in premature neonates for the prevention of bronchopulmonary dysplasia have not demonstrated substantial evidence of efficacy. No information about its effectiveness in other age populations is available.

30.4. Geriatric Use

Nitric oxide is not indicated for use in the adult population.

31. OVERDOSAGE

Overdosage with NO is manifest by elevations in methemoglobin and pulmonary toxicities associated with inspired NO₂. Elevated NO₂ may cause acute lung injury. Elevations in methemoglobin reduce the oxygen delivery capacity of the circulation. In clinical studies, NO₂ levels >3 ppm or methemoglobin levels >7% were treated by reducing the dose of, or discontinuing, NO.

Methemoglobinemia that does not resolve after reduction or discontinuation of therapy can be treated with intravenous vitamin C, intravenous methylene blue, or blood transfusion, based upon the clinical situation.

32. DESCRIPTION

Nitric oxide gas generated by the LungFit PH is a drug administered by inhalation. Nitric oxide is a pulmonary vasodilator. Nitric oxide from the LungFit PH is a gaseous blend of nitric oxide and room air (main constituents: nitrogen (78.08%), oxygen (20.95%), argon (0.93%) and carbon dioxide (0.03%).

The generation of NO gas results in the conversion of small amounts of nitrogen and oxygen. The amount of this conversion is dependent on the concentration of nitric oxide, and will be a maximum of 0.08% of nitrogen and oxygen when set to 80 ppm at ventilator flow rates above 50 L/min. This will result in the decrease of nitrogen to approximately 78.00% and oxygen to 20.87% in the carrier gas.

33. CLINICAL PHARMACOLOGY

33.1. Mechanism of Action

Nitric oxide relaxes vascular smooth muscle by binding to the heme moiety of cytosolic guanylate cyclase, activating guanylate cyclase and increasing intracellular levels of cyclic guanosine 3',5'-monophosphate, which then leads to vasodilation. When inhaled, nitric oxide selectively dilates the pulmonary vasculature, and because of efficient scavenging by hemoglobin, has minimal effect on the systemic vasculature. Nitric oxide appears to increase the partial pressure of arterial oxygen (PaO₂) by dilating pulmonary vessels in better ventilated areas of the lung, redistributing pulmonary blood flow away from lung regions with low ventilation/perfusion (V/Q) ratios toward regions with normal ratios.

33.2. Pharmacodynamics

Effects on Pulmonary Vascular Tone in PPHN

Persistent pulmonary hypertension of the newborn (PPHN) occurs as a primary developmental defect or as a condition secondary to other diseases such as meconium aspiration syndrome (MAS), pneumonia, sepsis, hyaline membrane disease, congenital diaphragmatic hernia (CDH), and pulmonary hypoplasia. In these states, pulmonary vascular resistance (PVR) is high, which results in hypoxemia secondary to right-to-left shunting of blood through the patent ductus arteriosus and foramen ovale. In neonates with PPHN, NO improves oxygenation (as indicated by significant increases in PaO₂).

33.3. Pharmacokinetics

The pharmacokinetics of nitric oxide has been studied in adults.

Absorption and Distribution

Nitric oxide is absorbed systemically after inhalation. Most of it traverses the pulmonary capillary bed where it combines with hemoglobin that is 60% to 100% oxygen-saturated. At this level of oxygen saturation, nitric oxide combines predominantly with oxyhemoglobin to produce methemoglobin and nitrate. At low oxygen saturation, nitric oxide can combine with deoxyhemoglobin to transiently form nitrosylhemoglobin, which is converted to nitrogen oxides and methemoglobin upon exposure to oxygen. Within the pulmonary system, nitric oxide can combine with oxygen and water to produce nitrogen dioxide and nitrite, respectively, which interact with oxyhemoglobin to produce methemoglobin and nitrate. Thus, the end products of nitric oxide that enter the systemic circulation are predominantly methemoglobin and nitrate.

Metabolism

Methemoglobin disposition has been investigated as a function of time and nitric oxide exposure concentration in neonates with respiratory failure. The methemoglobin (MetHb) concentration time profiles during the first 12 hours of exposure to 0, 5, 20, and 80 ppm NO are shown in Figure 54.

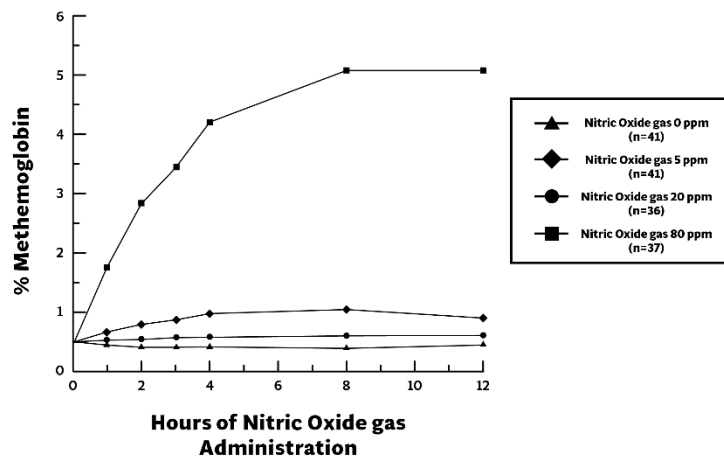

Figure 54²: Methemoglobin Concentration-Time Profiles Neonates Inhaling 0, 5, 20, or 80 ppm Nitric Oxide gas.

Methemoglobin concentrations increased during the first 8 hours of nitric oxide exposure. The mean methemoglobin level remained below 1% in the placebo group and in the 5 ppm and 20 ppm NO groups, but reached approximately 5% in the 80 ppm NO group. Methemoglobin levels >7% were attained only in patients receiving 80 ppm, where they comprised 35% of the group. The average time to reach peak methemoglobin was 10 ± 9 (SD) hours (median, 8 hours) in these 13 patients, but one patient did not exceed 7% until 40 hours.

Elimination

Nitrate has been identified as the predominant nitric oxide metabolite excreted in the urine, accounting for >70% of the nitric oxide dose inhaled. Nitrate is cleared from the plasma by the kidney at rates approaching the rate of glomerular filtration.

34. NONCLINICAL TOXICOLOGY

34.1. Carcinogenesis, Mutagenesis, Impairment of Fertility

No evidence of a carcinogenic effect was apparent, at inhalation exposures up to the recommended dose (20 ppm), in rats for 20 hr/day for up to two years. Higher exposures have not been investigated. Nitric oxide has demonstrated genotoxicity in Salmonella (Ames Test), human lymphocytes, and after in vivo exposure in rats. There are no animal or human studies to evaluate nitric oxide for effects on fertility.

35. CLINICAL STUDIES

35.1. Treatment of Hypoxic Respiratory Failure (HRF)

The efficacy of NO has been investigated in term and near-term newborns with hypoxic respiratory failure resulting from a variety of etiologies. Inhalation of NO reduces the oxygenation index (OI= mean airway pressure in cm H₂O × fraction of inspired oxygen concentration [FiO₂] × 100 divided by systemic arterial concentration in mm Hg [PaO₂]) and increases PaO₂.

NINOS Study

The Neonatal Inhaled Nitric Oxide Study (NINOS) was a double-blind, randomized, placebo-controlled, multicenter trial in 235 neonates with hypoxic respiratory failure.⁵

The objective of the study was to determine whether inhaled nitric oxide would reduce the occurrence of death and/or initiation of extracorporeal membrane oxygenation (ECMO) in a prospectively defined cohort of term or near-term neonates with hypoxic respiratory failure unresponsive to conventional therapy. Hypoxic respiratory failure was caused by meconium aspiration syndrome (MAS; 49%), pneumonia/sepsis (21%), idiopathic primary pulmonary hypertension of the newborn (PPHN; 17%), or respiratory distress syndrome (RDS; 11%). Infants ≤14 days of age (mean, 1.7 days) with a mean PaO₂ of 46 mm Hg and a mean oxygenation index (OI) of 43 cm H₂O / mm Hg were initially randomized to receive 100% O₂ with (n=114) or without (n=121) 20 ppm nitric oxide for up to 14 days. Response to study drug was defined as a change from baseline in PaO₂ 30 minutes after starting treatment (full response = >20 mm Hg, partial = 10–20 mm Hg, no response = <10 mm Hg). Neonates with a less than full response were evaluated for a response to 80 ppm nitric oxide or control gas. The primary results from the NINOS study are presented in Table 4.

Table 4: Summary of Clinical Results from NINOS Study

	Control (n=121)	NO (n=114)	P value
Death or ECMO*†	77 (64%)	52 (46%)	0.006
Death	20 (17%)	16 (14%)	0.06
ECMO	66 (55%)	44 (39%)	0.014

*Extracorporeal membrane oxygenation

†Death or need for ECMO was the study's primary endpoint

Although the incidence of death by 120 days of age was similar in both groups (NO, 14%; control, 17%), significantly fewer infants in the nitric oxide group required ECMO compared with controls (39% vs. 55%, p = 0.014). The combined incidence of death and/or initiation of ECMO showed a significant advantage for the nitric oxide treated group (46% vs. 64%, p = 0.006). The nitric oxide group also had significantly greater increases in PaO₂ and greater decreases in the OI and the alveolar-arterial oxygen gradient than the control group (p<0.001 for all parameters). Significantly more patients had at least a partial response to the initial administration of study drug in the nitric oxide group (66%) than the control group (26%, p<0.001). Of the 125 infants who did not respond to 20 ppm nitric oxide or control, similar percentages of NO-treated (18%) and control (20%) patients had at least a partial response to 80 ppm nitric oxide for inhalation or control drug, suggesting a lack of additional benefit for the higher dose of nitric oxide. No infant had study drug discontinued for toxicity. Inhaled nitric oxide had no detectable effect on mortality. The adverse events collected in the NINOS trial occurred at similar incidence rates in both treatment groups [see Adverse Reactions (6.1)]. Follow-up exams were performed at 18–24 months for the infants enrolled in this trial. In the infants with available follow-up, the two treatment groups were similar with respect to their mental,

⁵ Neonatal Inhaled Nitric Oxide Study Group. (1997). Inhaled nitric oxide in full-term and nearly full-term infants with hypoxic respiratory failure. *New England Journal of Medicine*, 336(9), 597-604.

motor, audiologic, or neurologic evaluations.

CINRGI Study

This study was a double-blind, randomized, placebo-controlled, multicenter trial of 248 term and near-term neonates with pulmonary hypertension and hypoxic respiratory failure.⁶

The primary objective of the study was to determine whether NO would reduce the receipt of ECMO in these patients. Hypoxic respiratory failure was caused by MAS (34% in each group), idiopathic PPHN (iNO 25%; control 20%), pneumonia (21% in each group), or RDS (9% in each group). Patients with a mean PaO₂ of 54 mm Hg and a mean OI of 44 cm H₂O / mm Hg were randomly assigned to receive either 20 ppm NO (n=126) or nitrogen gas (placebo; n=122) in addition to their ventilatory support. Patients who exhibited a PaO₂ >60 mm Hg and a pH < 7.55 were weaned to 5 ppm NO or placebo. The primary results from the CINRGI study are presented in Table 5.

Table 5: Summary of Clinical Results from CINRGI Study

	Placebo	NO	P value
ECMO*†	78/122 (64%)	48/126 (38%)	0.001
Death before discharge	13/122 (11%)	10/126 (8%)	0.82

*Extracorporeal membrane oxygenation

†ECMO was the study's primary endpoint

Significantly fewer neonates in the NO group required ECMO compared to the control group (38% vs. 64%, p<0.001). While the number of deaths before discharge were similar in both groups (NO, 8%; placebo, 11%), the combined incidence of death and/or receipt of ECMO was decreased in the NO group (iNO 50/126 (40%)% vs. control 80/122 (66%%, p<0.001).

Of the 126 patients treated with NO, 2 (2%) were withdrawn from study drug due to methemoglobin levels >4%. The frequency and number of adverse events reported were similar in the two study groups [see Adverse Reactions].

In clinical trials, reduction in the need for ECMO has not been demonstrated with the use of inhaled nitric oxide in neonates with congenital diaphragmatic hernia (CDH).

35.2. Ineffective in Adult Respiratory Distress Syndrome (ARDS)

In a randomized, double-blind, parallel, multicenter study, 385 patients with adult respiratory distress syndrome (ARDS) associated with pneumonia (46%), surgery (33%), multiple trauma (26%), aspiration (23%), pulmonary contusion (18%), and other causes, with PaO₂/FiO₂ <250 mm Hg despite optimal oxygenation and ventilation, received placebo (n=193) or NO (n=192), 5 ppm, for 4 hours to 28 days or until weaned because of improvements in oxygenation. Despite acute

⁶ Clark, R. H., Kueser, T. J., Walker, M. W., Southgate, W. M., Huckaby, J. L., Perez, J.A., ..., & Kinsella, J. P. (2000). Low-dose nitric oxide therapy for persistent pulmonary hypertension of the newborn. *New England Journal of Medicine*, 342(7), 469-474.



improvements in oxygenation, there was no effect of NO on the primary endpoint of days alive and off ventilator support. These results were consistent with outcome data from a smaller dose ranging study of nitric oxide (1.25 to 80 ppm). NO is not indicated for use in ARDS.

35.3. Ineffective in Prevention of Bronchopulmonary Dysplasia (BPD)

The safety and efficacy of NO for the prevention of chronic lung disease [bronchopulmonary dysplasia, (BPD)] in neonates ≤ 34 weeks gestational age requiring respiratory support has been studied in four large, multi-center, double-blind, placebo-controlled clinical trials in a total of 2,600 preterm infants. Of these, 1,290 received placebo, and 1,310 received inhaled nitric oxide at doses ranging from 5-20 ppm, for treatment periods of 7-24 days duration. The primary endpoint for these studies was alive and without BPD at 36 weeks postmenstrual age (PMA). The need for supplemental oxygen at 36 weeks PMA served as a surrogate endpoint for the presence of BPD. Overall, efficacy for the prevention of bronchopulmonary dysplasia in preterm infants was not established. There were no meaningful differences between treatment groups with regard to overall deaths, methemoglobin levels, or adverse events commonly observed in premature infants, including intraventricular hemorrhage, patent ductus arteriosus, pulmonary hemorrhage, and retinopathy of prematurity.

NO for prevention of BPD in preterm neonates ≤ 34 weeks gestational age is not recommended.