



















# Amplatzer™ Amulet™ Left Atrial Appendage Occluder









## Instructions for Use

## Symbols and Definitions

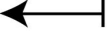
The following symbols may appear on the device packaging:

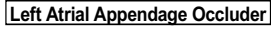
Symbols	Definitions
	Caution, consult accompanying documents
	Manufacturer
	Catalog number
	Serial number
	Batch code
	Use-by date
	Date of manufacture
	Do not re-use
	Do not use if package is damaged
	Sterilized using ethylene oxide
	Unique Device Identification
	Packaging unit
	MR Conditional
	Consult instructions for use
 medical.abbott/manuals	Follow instructions for use on this website
	Keep dry; keep away from rain
	Do not use if package is damaged
	Inner diameter

Symbols	Definitions
	Outer diameter
	Length
	Usable length
	Recommended delivery sheath dimensions
	Left Atrial Appendage Occluder
	Do not resterilize
	Federal law restricts this device to sale by or on the order of a physician.

Amplatzer™ Amulet™ Left Atrial Appendage Occluder .....	1
Device Description .....	1
Indication for Use .....	2
Warnings .....	2
Precautions .....	3
Patient Selection for Treatment .....	3
Patient Counseling Information .....	3
MRI Safety Information .....	4
Potential Adverse Events .....	4
Clinical Summary .....	4
Follow-up Medication .....	6
Directions for Use .....	9
Post-Procedure Instructions .....	13
Disposal .....	13
Warranty .....	14
State of California (USA) Only: .....	14
Appendix A: Supplemental Information .....	15

# Amplatzer™ Amulet™ Left Atrial Appendage Occluder

## Device Description

The Amplatzer™ Amulet™ Left Atrial Appendage Occluder is a transcatheter, self-expanding device intended for use in preventing thrombus embolization from the left atrial appendage. The device is constructed from a nitinol mesh and consists of a lobe and a disc connected by a central waist. Polyester patches are sewn into both the lobe and disc to facilitate occlusion. The lobe has stabilizing wires to improve device placement and retention. The device has threaded screw attachments at each end for connection to the delivery and loading cables. The device has radiopaque markers at each end and at the stabilizing wires that permit visibility during fluoroscopy.

Refer to the figures and tables in Appendix A: Supplemental Information for more information about the device. Device and delivery sheath dimensions are provided in Table 1, and sizing information is provided in Table 2. The following device components are identified in Figure 1 and Figure 2.

- | Figure 1             | Figure 2                                       |
|----------------------|--|
| A Proximal end screw | I Loader with device                           |
| B Waist of device    | J Loader hub                                   |
| C Lobe               | K 14 Fr flush adaptor (for sizes 28 mm–34 mm)  |
| D Distal end screw   | L Hemostasis valve                             |
| E Marker bands       | M Delivery cable                               |
| F Stabilizing wires  | N Delivery cable vise                          |
| G Platinum thread    | O 14 Fr sheath adaptor (for sizes 16 mm–25 mm) |
| H Disc               | P Loading cable vise                           |
|                      | Q Loading cable                                |

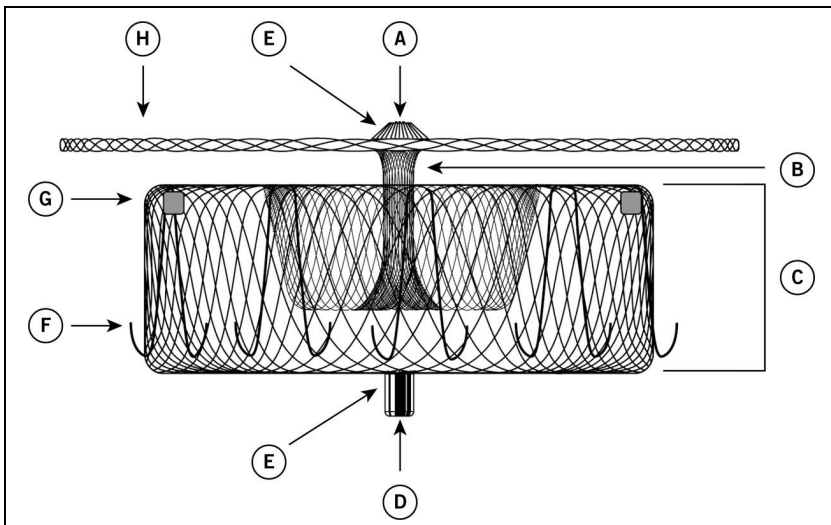
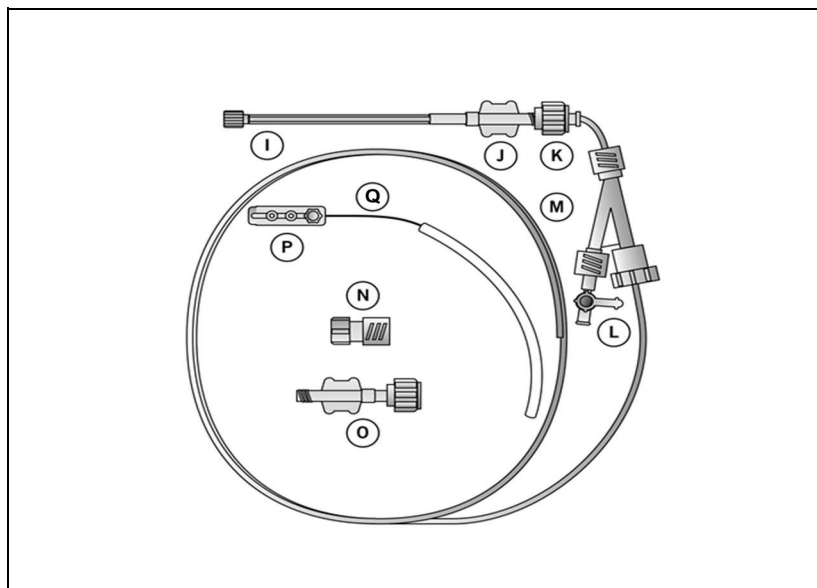

Figure 1. Amplatzer™ Amulet™ Components



**Figure 2. Amplatzer™ Amulet™ Device Components**

### Indication for Use

The Amplatzer™ Amulet™ Left Atrial Appendage Occluder is a percutaneous transcatheter device intended to reduce the risk of thrombus embolization from the left atrial appendage (LAA) in patients who have nonvalvular atrial fibrillation and who are at increased risk for stroke and systemic embolism based on CHADS<sub>2</sub> or CHA<sub>2</sub>DS<sub>2</sub>-VASc scores, are suitable for short-term anticoagulation therapy, and have appropriate rationale to seek a non-pharmacologic alternative to oral anticoagulation, taking into consideration the safety and effectiveness of the device.

### Contraindications

The Amplatzer™ Amulet™ Left Atrial Appendage (LAA) Occluder is contraindicated for patients:

- with the presence of intracardiac thrombus,
- with active endocarditis or other infections producing bacteremia.
- where placement of the device would interfere with any intracardiac or intravascular structures.

### Warnings

- If the device is retracted while it is in the sheath, the device and the sheath must both be removed and replaced. Failure to replace both the device and the sheath may result in sheath and/or device malfunction.
- If the device is retracted farther than the radiopaque markers (fully recaptured), the device and the sheath must both be removed and replaced. Failure to replace both the device and the sheath may result in sheath and/or device malfunction.
- Physicians must be prepared to deal with urgent situations, such as pericardial effusion or device embolization, which can require removal of the device.
- This device should be used only by physicians who are trained in standard transcatheter techniques. The physician should determine which patients are candidates for procedures that use this device.
- Late pericardial effusion events were observed in the clinical study. The use of post-procedure anticoagulation therapy may be associated with an increased potential for a late pericardial effusion. Physicians should monitor for signs and symptoms of pericardial effusion and obtain appropriate imaging when indicated. Physicians should also consider routine echocardiography to screen for pericardial effusion.
- Remove embolized devices. Do not remove an embolized device unless the device is fully captured inside a sheath.
- The Amplatzer™ Amulet™ device contains a nickel-titanium alloy, which is generally considered safe. However, in vitro testing has demonstrated that nickel is released from this device for a minimum of 120 days. Patients who are allergic to nickel may have an allergic reaction to this device, especially those with a history of metal allergies. Certain allergic reactions can be serious; patients should be instructed to seek medical assistance immediately if they suspect they are experiencing an allergic reaction. Symptoms may include difficulty in breathing or swelling of the face or throat. While data are currently limited, it is possible that some patients may develop an allergy to nickel if this device is implanted.
- Do not use this device if the sterile package is open or damaged.

- The device was sterilized with ethylene oxide and is for single use only. Do not reuse or resterilize this device. Attempts to resterilize this device can cause a malfunction, insufficient sterilization, or harm to the patient.
- Use on or before the expiration date that is printed on the product packaging label.

### **Precautions**

- The physician should exercise clinical judgment in situations that involve the use of antithrombotic drugs before, during, and/or after the use of this device.
- The physician should exercise caution if implanting a device in a patient who has an implantable cardioverter defibrillator (ICD) or pacemaker leads.
- The physician should have the guidewire in the left upper pulmonary vein when making exchanges in the left atrium.
- Ensure that the vasculature is adequate for the sheath size being selected.
- The physician should exercise caution if performing ablation at or near the implant site after the device is implanted.
- Use standard interventional cardiovascular catheterization techniques when using Amplatzer™ products.
- Use in specific populations
  - Pregnancy – Minimize the radiation exposure to the fetus and the mother.
  - Nursing mothers – There has been no quantitative assessment for the presence of leachables in breast milk.

### **Patient Selection for Treatment**

In considering the use of the Amplatzer™ Amulet™ Left Atrial Appendage Occluder, the rationale for seeking an alternative to long-term anticoagulation therapy and the safety and effectiveness of the device should be taken into consideration.

Non-valvular atrial fibrillation is associated with an increased risk of cardioembolic stroke. The Amplatzer™ Amulet™ occluder is designed to reduce the risk of thromboembolism originating from the LAA. Although thromboembolism from the LAA is a common source of stroke in this setting, it is not the sole source. Therefore, the Amulet occluder would not be expected to reduce the risk of ischemic stroke unrelated to thromboembolism from the LAA, and other potential risk factors for stroke should be considered (e.g., cerebrovascular disease, hypercoagulable states).

Oral anticoagulants effectively reduce the risk of cardioembolic stroke and are the most commonly used treatments in at-risk patients with non-valvular atrial fibrillation. Following a careful assessment of the safety and effectiveness of the available approved oral anticoagulants, the Amulet occluder is an option that may be considered in selected patients to reduce the risk of thromboembolism from the LAA.

Selection among available treatment options must first take into account whether anticoagulation is indicated to reduce the risk of stroke based on CHADS<sub>2</sub> or CHA<sub>2</sub>DS<sub>2</sub>-VASc scores. Next, in a patient who is deemed by their physicians to be suitable for short term anticoagulation therapy, the physician and the patient should consider the rationale for implantation of the Amplatzer™ Amulet™ occluder. Specific factors may include one or more of the following:

- A history of major bleeding while taking anticoagulation therapy
- The patient's prior experience with oral anticoagulation (if applicable)
- A medical condition, occupation, or lifestyle placing the patient at high risk of major bleeding secondary to trauma
- The presence of indication(s) for long-term anticoagulation therapy, other than non-valvular atrial fibrillation (e.g., mechanical heart valve, hypercoagulable states, recurrent deep venous thrombosis)

Patient factors that need to be considered for the Amplatzer™ Amulet™ occluder and implantation procedure include the following:

- Overall medical status, including conditions which might preclude the safety of a percutaneous, transcatheter procedure or the need for post-implant oral anticoagulation, which may be associated with an increased risk of pericardial effusion
- Suitability for percutaneous, transseptal procedures, including considerations of:
  - Cardiac anatomy relating to the LAA size
  - Vascular access anatomy (e.g., femoral vein size, thrombus, or tortuosity)
  - Ability of the patient to tolerate general or local anesthesia
  - Ability of the patient to undergo required imaging
- Ability to comply with the recommended post-Amplatzer™ Amulet™ occluder implant medication regimen and routine standard of care echocardiographic follow-up (see Post-Procedure Instructions), especially for patients at high risk for bleeding.

### **Patient Counseling Information**

Physicians should review the following information when counseling patients about the Amplatzer™ Amulet™ occluder and implant procedure:

- The safety and effectiveness of transcatheter LAA closure with the Amplatzer™ Amulet™ occluder
- There are non-LAA sources of cardiac emboli and other etiologies of stroke that may result in ischemic stroke independent of LAA closure that should be considered

- The procedural risks associated with the Amplatzer™ Amulet™ occluder implantation. See Table 6 for details about procedure-related complications observed in the Amulet IDE trial
- The need for adherence to a defined medication regimen of antiplatelet therapy following Amplatzer™ Amulet™ occluder implantation
- Clinical conditions may arise that require resumption of anticoagulation therapy following Amplatzer™ Amulet™ occluder implantation
- The risk of the device implantation procedure plus post-procedure related bleeding weighed against the risk of bleeding on long-term anticoagulation therapy

## MRI Safety Information

Non-clinical testing has demonstrated that the Amplatzer™ Amulet™ Left Atrial Appendage Occluder device is MR Conditional. A patient with the Amplatzer™ Amulet™ device can be safely scanned in an MR system under the following conditions:

- Static magnetic fields of 1.5 Tesla (1.5T) and 3.0 Tesla (3.0T)
- Maximum spatial gradient field of 19 T/m (1900 G/cm)
- Maximum MR system reported, whole-body averaged specific absorption rate (SAR) of 2.0 W/kg (normal operating mode)

Under the scan conditions defined above, the device is expected to produce a maximum temperature rise of less than or equal to 4°C after 15 minutes of continuous scanning.

In non-clinical testing, the image artifact caused by the device extends radially up to 20 mm from the device when imaged with a gradient echo pulse sequence in a 3.0T MR system.

## Potential Adverse Events

Potential adverse events associated with the device or implant procedure include, but are not limited to, the following:

- Air embolism
- Airway trauma
- Allergic reaction
- Anemia
- Anesthesia reaction (nausea, vasovagal reaction, confusion/altered mental status or other)
- Arrhythmia
- Atrial septal defect
- Bleeding
- Cardiac arrest
- Cardiac tamponade
- Chest pain/discomfort
- Congestive heart failure
- Death
- Device embolization
- Device erosion
- Device malfunction
- Device malposition
- Device migration
- Device-related thrombus
- Fever
- Hematuria
- Hypertension/hypotension
- Infection
- Multi-organ failure
- Myocardial infarction
- Perforation
- Pericardial effusion
- Pleural effusion
- Renal failure/dysfunction
- Respiratory failure
- Seizure
- Significant residual flow
- Stroke
- Thrombocytopenia
- Thromboembolism: peripheral and pulmonary
- Thrombus formation
- Transient ischemic attack
- Valvular regurgitation/insufficiency
- Vascular access site injury (hematoma, pseudoaneurysm, arteriovenous fistula, groin pain, or other)
- Vessel trauma/injury

## Clinical Summary

### Design

The Amplatzer™ Amulet™ Left Atrial Appendage Occluder IDE Trial (Amulet IDE Trial) was designed to evaluate the safety and effectiveness of the Amplatzer™ Amulet™ Left Atrial Appendage (LAA) Occluder to prevent embolization of thrombus from the LAA in patients with non-valvular atrial fibrillation. The Amulet IDE Trial was a global, prospective, multi-center, randomized (1:1), controlled, non-inferiority trial comparing the safety and effectiveness of the Amplatzer™ Amulet™ device to the FDA-approved and



commercially available WATCHMAN™ LAA closure device (Boston Scientific Corporation, Minneapolis, MN, USA). The trial had an independent clinical events committee (CEC), independent echocardiography core laboratory, and an independent data and safety monitoring board (DSMB).

Key inclusion criteria included:

- patients who were 18 years of age or older
- documented non-valvular atrial fibrillation
- deemed suitable for short-term Warfarin therapy, but deemed unable to take long-term anticoagulation therapy
- CHADS<sub>2</sub> score  $\geq 2$  or a CHA<sub>2</sub>DS<sub>2</sub>-VASc score of  $\geq 3$

All subjects underwent follow-up at discharge, 45 days, six months, 12 months, 18 months, and annually through five years. Implanted subjects underwent trans-esophageal echocardiography (TEE) evaluation at 45-day and 12-month visits.

The primary mechanism of action endpoint was device closure (residual jet around the device  $\leq 5$  mm) as assessed by an independent core laboratory on TEE at the 45-day visit. The primary safety endpoint was a composite of procedure-related complications, all-cause death, or major bleeding (Type 3 or greater per Bleeding Academic Research Consortium (BARC) definition) at 12 months. The primary effectiveness endpoint was a composite of ischemic stroke or systemic embolism at 18 months.

The protocol required that Amplatzer™ Amulet™ subjects be discharged on either dual antiplatelet therapy (aspirin plus clopidogrel) or aspirin plus oral anticoagulation. WATCHMAN™ subjects were required to be discharged on aspirin plus warfarin. When LAA closure was confirmed (residual jet  $\leq 5$ mm) at the 45-day visit, cessation of oral anticoagulation was required for all subjects. Subjects were then instructed to take aspirin plus clopidogrel until the 6-month visit. Cessation of clopidogrel was required at the 6-month visit, and aspirin was to be continued indefinitely. In both groups, if residual jet was  $>5$  mm at either visit, oral anticoagulation plus aspirin was required. If closure was not confirmed at the 12-month visit, oral anticoagulation therapy was left to the physician's discretion.

### Analysis Populations

A total of 1878 subjects were randomized to receive either an Amplatzer™ Amulet™ device (N=934) or a WATCHMAN™ device (N=944) and represent the Intention-to-Treat (ITT) population (Table 1). A total of 915 of 934 subjects randomized to the Amplatzer™ Amulet™ device group and 916 of 944 subjects randomized to the WATCHMAN™ device group underwent an implant attempt with the device as randomized. Of these 1831 (915+916) subjects, 903 Amplatzer™ Amulet™ device subjects and 896 WATCHMAN™ device subjects met protocol eligibility criteria; this group represents the Per Protocol (PP) population. The primary analyses of the primary safety and primary effectiveness endpoints are based on the PP and ITT populations, respectively. The number of subjects successfully implanted with the device as randomized (including reattempt procedures) was 903 for Amplatzer™ Amulet™ device group and 885 for WATCHMAN™ device group.

**Table 1. Analysis Populations**

	Amplatzer™ Amulet™ Device	WATCHMAN™ Device
Randomized (ITT)	934	944
Implant Attempt as Randomized	915	916
Per Protocol (PP)	903	896
Successful Implant as Randomized	903	885

### Baseline Characteristics and Medical History

Table 2 presents the subject baseline characteristics and medical history. The average age in both groups was 75 years and approximately 60% of the subjects were male. There were no statistically significant differences in demographics and baseline characteristics between groups ( $p>0.05$ ). Subjects had a mean CHA<sub>2</sub>DS<sub>2</sub>-VASc score of 4.5 and 4.7 in the Amulet™ device and WATCHMAN™ device groups, respectively. Mean HAS-BLED score was 3.2 for the Amulet™ device and 3.3 for the WATCHMAN™ device.

**Table 2. Baseline Characteristics and Medical History – ITT Population**

Characteristics	Amplatzer™ Amulet™ Device (N=934)	WATCHMAN™ Device (N=944)	P-value
<b>Age (years)</b>	75.0 ± 7.6 (934) (38.0, 92.0)	75.1 ± 7.6 (944) (46.0, 96.0)	0.6802 <sup>a</sup>
<b>Gender:</b>			0.2583 <sup>b</sup>
Male	58.8% (549/934)	61.3% (579/944)	
Female	41.2% (385/934)	38.7% (365/944)	
<b>Ethnicity</b>			
Hispanic or Latino	2.8% (26/934)	3.7% (35/944)	0.2588 <sup>b</sup>
<b>Race</b>			0.6306 <sup>c</sup>
White	89.7% (838/934)	90.1% (851/944)	
Black or African American	2.2% (21/934)	2.1% (20/944)	
Asian	0.4% (4/934)	0.7% (7/944)	
American Indian or Alaska Native	0.4% (4/934)	0.2% (2/944)	
Native Hawaiian or other Pacific Islander	0.0% (0/934)	0.3% (3/944)	
Other	1.1% (10/934)	1.0% (9/944)	
Declined or unable to disclose due to local regulation	6.1% (57/934)	5.5% (52/944)	
<b>AF Classification</b>			0.4292 <sup>b</sup>
Paroxysmal	56.5% (528/934)	53.9% (509/944)	
Persistent	26.8% (250/934)	29.3% (277/944)	
Permanent	16.7% (156/934)	16.6% (157/944)	
<b>CHADS<sub>2</sub> Score</b>	2.7 ± 1.1 (932) (1, 6)	2.8 ± 1.2 (943) (1, 6)	0.0867 <sup>b</sup>
<b>CHA<sub>2</sub>DS<sub>2</sub>-VASc Score</b>	4.5 ± 1.3 (934) (2,9)	4.7 ± 1.4 (944) (2,9)	0.2312 <sup>b</sup>
<b>HAS-BLED Score</b>	3.2 ± 1.0 (933) (1, 7)	3.3 ± 1.0 (943) (1, 6)	0.1272 <sup>b</sup>
<b>History of TIA</b>	10.7% (100/934)	12.0% (113/944)	0.3879 <sup>b</sup>
<b>History of Stroke</b>	18.0% (168/934)	19.9% (188/944)	0.2865 <sup>b</sup>
<b>History of Major or Minor Bleeding</b>	72.2% (674/934)	71.5% (675/944)	0.7511 <sup>b</sup>

Continuous variables are reported as mean ± SD, (min, max) and categorical variables are reported as n/N (%).

a. From t-test

b. From Chi-square test

c. From Fisher's exact test when Cochran's rule is not met.

NOTE: All p-values displayed are two-tailed and not from pre-specified hypothesis testing and are displayed for information only.

## Follow-up Medication

The distribution of antithrombotic medical regimen on the day of discharge and on the day prior to each scheduled follow-up visit in the two groups is presented in Figure 3.

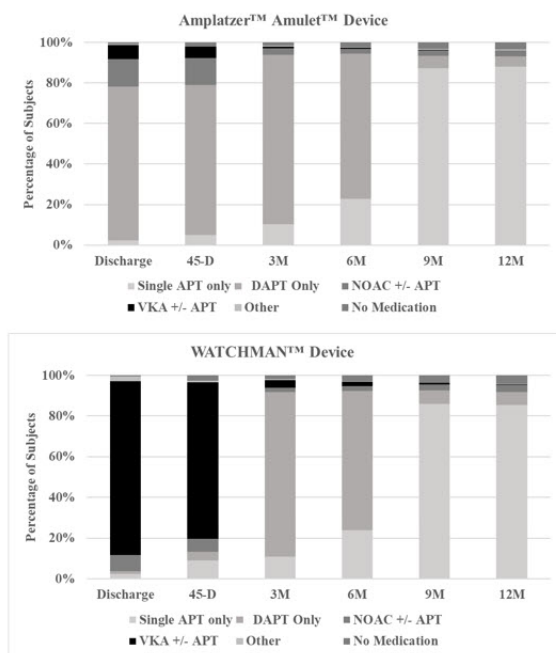

Figure 3. Antithrombotic Medication Usage (Successful Implant as Randomized)

## Mechanism of Action Primary Endpoint at 45 Days

The Amplatzer™ Amulet™ device was non-inferior to the WATCHMAN™ device for the mechanism of action endpoint (98.9% vs 96.8%;  $p < 0.0001$  for non-inferiority). No residual jet around the device was observed in 63% of Amplatzer™ Amulet™ device subjects and 46% of WATCHMAN™ device subjects. Flow  $> 0$  mm and  $\leq 5$  mm was observed in 36% of Amplatzer™ Amulet™ device subjects and 51% of WATCHMAN™ device subjects. A small percentage of subjects (1% Amplatzer™ Amulet™ device subjects and 3% WATCHMAN™ device subjects) had residual jet  $> 5$  mm.

Table 3. Mechanism of Action Primary Endpoint

	Amplatzer™ Amulet™ Device (N=903)	WATCHMAN™ Device (N=885)	97.5% Lower Confidence Bound (LCB)	P-value (Non-inferiority margin: -3%)	Result
Primary Mechanism of Action Endpoint	98.9% (792/801)	96.8% (767/792)	0.41%	$< 0.0001$	Pass

Residual jet around the device  $\leq 5$  mm at the 45-day visit documented by transesophageal echocardiogram defined by Doppler flow. The lower confidence bound was calculated by the Farrington Manning method.

## Primary Safety Endpoint at 12 Months

The Amplatzer™ Amulet™ device was also shown to be non-inferior to the WATCHMAN™ device for the primary safety endpoint at 12 months (14.5% vs. 14.7%,  $p = 0.0002$  for non-inferiority; Table 4). Individual components of the primary safety endpoint are shown in Table 5.

Procedure-related complications, defined as adverse events adjudicated by the CEC as procedure-related and requiring either invasive surgical or percutaneous intervention, occurred in 63 subjects (41 Amplatzer™ Amulet™ device subjects and 22 WATCHMAN™ device subjects). The primary drivers for the higher rate of procedure-related complications in the Amplatzer™ Amulet™ device group were device embolization and pericardial effusion. Bleeding events that were adjudicated by the CEC as BARC Type 3 or greater occurred in 183 subjects (95 Amplatzer™ Amulet™ device subjects and 88 WATCHMAN™ device subjects). As shown in Table 5, the majority of major bleeding events in both groups (7.9% for the Amplatzer™ Amulet™ device group and 8.0% for the WATCHMAN™ device group) were not procedure-related. A total of 80 subjects (35 Amplatzer™ Amulet™ device subjects, 45 WATCHMAN™ device subjects) in the PP population died within 12 months of the procedure.

The rate of procedure-related complications and major bleeding was numerically higher in the Amplatzer™ Amulet™ device group, while the rate of all-cause death was numerically higher in the WATCHMAN™ device group.

Table 6 summarizes the first event that each subject experienced that met the primary safety endpoint as a procedure related complication. Pericardial effusion events within two days of the procedure occurred in about the same number of subjects in the two groups, however, pericardial effusion events that occurred > 2 days post procedure (i.e., late pericardial effusion) occurred more commonly in Amplatzer™ Amulet™ device subjects than WATCHMAN™ device subjects.

**Table 4. Primary Safety Endpoint (PP Population)**

	Amplatzer™ Amulet™ Device (N=903)	WATCHMAN™ Device (N=896)	97.5% Upper Confidence Limit	P-value (Non-inferiority margin: 5.8%)	Result
Primary Safety Endpoint	14.5% (n=131)	14.7% (n=130)	3.13%	0.0002	Pass

Kaplan-Meier method was used to estimate the event rate (number of subjects with events).

**Table 5. Individual Components of the Primary Safety Endpoint (PP Population)**

	Amplatzer™ Amulet™ Device (N=903)	WATCHMAN™ Device (N=896)
Procedure-related Complication	4.5% (n=41)	2.5% (n=22)
[95% Confidence Interval]	[3.37%, 6.12%]	[1.62%, 3.71%]
Major Bleeding (BARC Type 3 or greater)	10.6% (n=95)	10.0% (n=88)
[95% Confidence Interval]	[8.78%, 12.83%]	[8.17%, 12.15%]
Procedure-related Major Bleeding	3.1% (n=28)	2.1% (n=19)
[95% Confidence Interval]	[2.16%, 4.47%]	[1.36%, 3.31%]
Non-procedure-related Major Bleeding	7.9% (n=70)	8.0% (n=70)
[95% Confidence Interval]	[6.27%, 9.84%]	[6.37%, 9.98%]
All-Cause Death	3.9% (n=35)	5.1% (n=45)
[95% Confidence Interval]	[2.82%, 5.40%]	[3.86%, 6.81%]

Kaplan-Meier method is used to estimate the event rate (number of subjects with events). Categories are not mutually exclusive.

**Table 6. Procedure-Related Complications at 12 Months (PP Population; First Event)**

Event Description	Amplatzer™ Amulet™ (N=903)	WATCHMAN™ (N=896)
Pericardial Effusion/Tamponade 0-2 days post-procedure	12	10
Pericardial Effusion/Tamponade >2 days post-procedure	10	1
Device Embolization	6	2
Vascular Access-Related Complications	3	3
Air Embolus	0	2
Cardiac Perforation	1	1
Esophageal Laceration and Rupture	1	1
Hematoma	1	1
Pleural Effusion	2	0
Third Degree Heart Block/Asystole	1	1
Acute Peritonitis	1	0
Gastrointestinal Bleeding	1	0
Hematuria	1	0
Inferior Myocardial Infarction	1	0
Ischemic Stroke	0	1
Peripheral Arterial Occlusion	1	0
<b>Total Number of Subjects<sup>a</sup></b>	<b>41</b>	<b>22</b>

a. One Amplatzer™ Amulet™ subject experienced both pericardial effusion and pleural effusion on POD 20. One Watchman™ subject experienced both air embolism and ischemic stroke on POD 0. Therefore, these totals are not equal to the sum of the numbers in the rows above.

### Primary Effectiveness Endpoint at 18 Months

The Amplatzer™ Amulet™ device was shown to be non-inferior to the WATCHMAN™ device for the primary effectiveness endpoint at 18 months (2.8% vs. 2.8%, p<0.0001 for non-inferiority; Table 7). Individual components of the primary effectiveness endpoint are shown in Table 8. Ischemic stroke occurred in 44 subjects (22 Amplatzer™ Amulet™ device subjects and 23 WATCHMAN™ device

subjects). Systemic embolism events occurred in 5 subjects (3 Amplatzer™ Amulet™ device subjects and 2 WATCHMAN™ device subjects). One WATCHMAN™ device subject experienced both an ischemic stroke and a systemic embolism.

**Table 7. Primary Effectiveness Endpoint (ITT Population)**

	Amplatzer™ Amulet™ Device (N=934)	WATCHMAN™ Device (N=944)	97.5% Upper Confidence Limit	P-value (Non-inferiority margin: 5.8%)	Result
Primary Effectiveness Endpoint	2.8% (n=25)	2.8% (n=24)	1.55%	<.0001	Pass

Kaplan-Meier method was used to estimate the event rate (number of subjects with events).

**Table 8. Individual Components of the Primary Effectiveness Endpoint (ITT Population)**

	Amplatzer™ Amulet™ Device (N=934)	WATCHMAN™ Device (N=944)
Ischemic Stroke	2.5% (n=22)	2.7% (n=23)
[95% Confidence Interval]	[1.63%, 3.73%]	[1.78%, 4.01%]
Systemic Embolism	0.3% (n=3)	0.2% (n=2)
[95% Confidence Interval]	[0.11%, 1.04%]	[0.06%, 0.92%]

Kaplan-Meier method is used to estimate the event rate (number of subjects with events). Categories are not mutually exclusive.

### Device-Related Thrombus

As shown in Table 9, the incidence of device-related thrombus at 18 months was 3.3% for the Amplatzer™ Amulet™ device (30 subjects) and 4.5% for the WATCHMAN™ device (40 subjects). The majority of device-related thrombus events were identified during regular scheduled follow-up. No Amplatzer™ Amulet™ device subjects with device-related thrombus experienced an ischemic stroke or systemic embolism. Two (2) WATCHMAN™ device subjects with a device-related thrombus experienced an ischemic stroke and/or systemic embolism.

**Table 9. Device-Related Thrombus at 18 Months (Successful Implant as Randomized)**

	Amplatzer™ Amulet™ Device (N=903)	WATCHMAN™ Device (N=885)
Device-related Thrombus	3.3% (30/903)	4.5% (40/885)
[95% Confidence Interval] <sup>a</sup>	[2.25%, 4.71%]	[3.25%, 6.10%]

a. determined by Clopper Pearson Exact method

### Summary and Conclusion

In conclusion, non-inferiority of the Amplatzer™ Amulet™ device was demonstrated for all three primary endpoints. The high rate of implant success, a 12-month all-cause mortality rate of 3.9%, along with a low rate of ischemic stroke or systemic embolism at 18 months (2.8%) demonstrate that the Amplatzer™ Amulet™ device is a safe and effective option for non-valvular atrial fibrillation patients at elevated risk of stroke with appropriate rationale to seek a non-pharmacologic alternative to oral anticoagulation.

### Directions for Use

#### Materials recommended for use with the Amplatzer™ Amulet™ Left Atrial Appendage Occluder

- Amplatzer™ Guidewire (9-GW-002)
- 35-cc syringe
- Delivery sheath with inner diameter appropriate for device size (see Table 1 in Appendix A: Supplemental Information).

NOTE: The Amplatzer™ Amulet™ Left Atrial Appendage Occluder is recommended for use with an Amplatzer™ brand sheath.

NOTE: Do not oversize or undersize the delivery sheath. Follow the recommended sizes listed in Table 1 of the Appendix.

#### Procedure

NOTE: Procedures guided by intracardiac echocardiography (ICE) should be preceded by a transesophageal echocardiography (TEE, preferably 3D) or cardiac CT to measure the left atrial appendage.

1. Evaluate the patient using TEE or ICE to rule out the presence of intracardiac thrombus (including left atrial appendage thrombus) and presence of pericardial effusion.
2. Prepare the patient for a standard transcatheter procedure, potentially including administration of oral antiplatelet medication. Effective anticoagulation therapy should be maintained during and after the procedure as determined by the physician. After a transseptal puncture is performed, maintain a recommended activated clotting time (ACT) of 250–350 seconds until the procedure is complete.
3. Perform a transseptal puncture.

- Gain access to the left atrium and place the Amplatzer™ Guidewire into the left upper pulmonary vein.

**CAUTION: Use caution when advancing the guidewire.**

- Use angiography, TEE (preferably 3D), or pre-procedural cardiac CT to measure the left atrial appendage, including the depth of the left atrial appendage (shown as Y in Table 2, in Appendix A) and the maximum width of the orifice (shown as Z in Table 2 in Appendix A). Image the left atrial appendage until it is clearly visible.
  - Identify and measure the left atrial appendage at the landing zone (defined as a minimum of 10–12 mm from the orifice) for the device lobe (shown as X in Table 2 in Appendix A: Supplemental Information) to determine the appropriate device size to occlude the left atrial appendage.
  - Consider using two imaging modalities to inform sizing. Use the maximum landing zone measurement if using 2D TEE or angiography and mean landing zone measurement if using 3D TEE or pre-procedural CT. When choosing between two sizes, consider depth and orifice measurements, confirming the orifice measurement (shown as Z in Table 2 of Appendix A: Supplemental Information) is less than the disc size of the selected device and there is sufficient depth. See Table 2 in Appendix A to determine the appropriate device size to occlude the left atrial appendage.

**WARNING: Do not implant the device if the measurements of the left atrial appendage do not fall within the sizing chart in Table 2 of Appendix A.**

NOTE: Ensure the measurement system is appropriately calibrated.

- Prepare the delivery sheath for use according to the manufacturer's instructions for use.
- Prepare the Amplatzer™ Amulet™ Left Atrial Appendage Occluder and delivery assembly for use:
  - Inspect the sterile pouch and verify that it is unopened and undamaged. Do not use the device or delivery assembly if the sterile barrier has been compromised.
  - Gently open the sterile packaging and inspect the components for damage. Do not use damaged or kinked components.
  - Remove the delivery cable and device from packaging.
- If desired, slide the delivery cable vise over the delivery cable. Tighten the delivery cable vise onto the delivery cable.
- Connect the hemostasis valve to the loader hub and turn the rotating luer to tighten.
- Advance the device until the distal end screw is flush with the distal end of the loader.
- Ensure the device is attached to the delivery cable by rotating the delivery cable vise clockwise until resistance is felt.
- Fill a 35-cc syringe with sterile saline. Connect the syringe to the hemostasis valve. Submerge device in sterile saline. Flush sterile saline through the loader and simultaneously tighten the hemostasis valve onto the delivery cable. Fill the syringe and flush sterile saline through the loader 2 more times.

NOTE: During additional flushing, ensure air does not enter the system.

NOTE: The loader tubing may be massaged to help remove air.

NOTE: During steps 12 – 16, make sure the tip of the loader is submerged in sterile saline at all times so air does not enter the loader.

- Fully retract the syringe plunger while holding the syringe body. Allow time for sterile saline to completely fill the syringe (optional).
- Advance the syringe plunger to force sterile saline through the loader.

NOTE: During this process, a small amount of air may accumulate in the syringe. Ensure the syringe is held upright and no air is introduced back into the loader.
- Flush the device again using steps 13 and 14.

NOTE: If air is visible in the loader, additional flush steps may be performed as described in steps 12–15 or the device may be removed from the loader and disconnected from the delivery cable. Reload the device by performing steps 33 – 42.

**WARNING: Do not retract the device.**

- Retract the plunger to fill the syringe with sterile saline to accommodate fluid-to-fluid connection with the delivery sheath.
- Advance the dilator and delivery sheath over the guidewire into the left upper pulmonary vein or left atrium. Remove the dilator and guidewire and advance a pigtail catheter or advance the device and partially deploy the lobe (as shown in Figure 4). Advance the sheath and pigtail catheter or partially deployed lobe into the left atrial appendage.

**WARNING: Use caution when advancing the dilator and sheath to prevent trauma.**

- If a 14 Fr delivery sheath was selected for use with a 16 mm – 25 mm device, tightly connect the 14 Fr sheath adaptor to the delivery sheath hub.

**WARNING: Proximal adaptor end is only compatible with supplied loader fitting. Do not flush or aspirate with any other accessories.**

- Allow blood backflow to purge all air from the delivery sheath assembly by holding the hub below the plane of the patient's body.

20. Immediately connect the loader to the delivery sheath in a fluid-to-fluid fashion and tighten the rotating luer.
21. Slightly loosen the hemostasis valve. Introduce the device into the delivery sheath and advance the device to the tip of the delivery sheath. Look for air bubbles when advancing. If air is present, allow backflow to purge air from the delivery sheath assembly.

**WARNING: Aspirating is not recommended because air can be introduced into the system.**

**WARNING: Do not rotate the delivery cable when advancing the device through the delivery sheath.**

22. Use fluoroscopy and/or echocardiography to guide the device into the left atrial appendage.

**WARNING: If the device needs to be retracted after this point, the device and sheath must both be removed and replaced.**

NOTE: Delivery cable connection can be checked by rotating the delivery cable/delivery cable vise clockwise until resistance is felt.

23. Hold the delivery cable in place while retracting the delivery sheath to partially expose the lobe (see Figure 4). If necessary, adjust the position of the sheath and lobe for alignment.

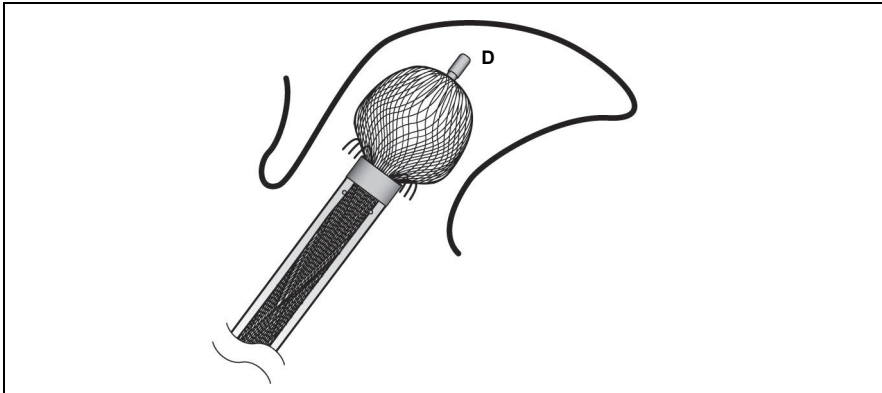
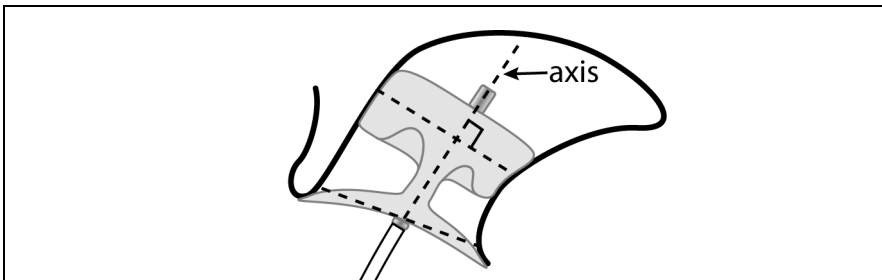

**Figure 4. Deploying the lobe**

24. Continue to deploy the lobe by pushing the cable forward and/or pulling the sheath back until the lobe is fully deployed within the left atrial appendage at the intended landing zone.

**CAUTION: Do not advance the delivery cable or the sheath after the lobe is fully deployed.**

25. The device lobe should be perpendicular with the axis of the left atrial appendage at the intended landing zone (see Figure 5).



**Figure 5. Proper device placement in the left atrial appendage**

26. Maintain a slight tension on the delivery cable while retracting the delivery sheath to expose the disc. The device disc should cover the orifice. Do not leave a gap between the orifice and the disc (see Figure 6).

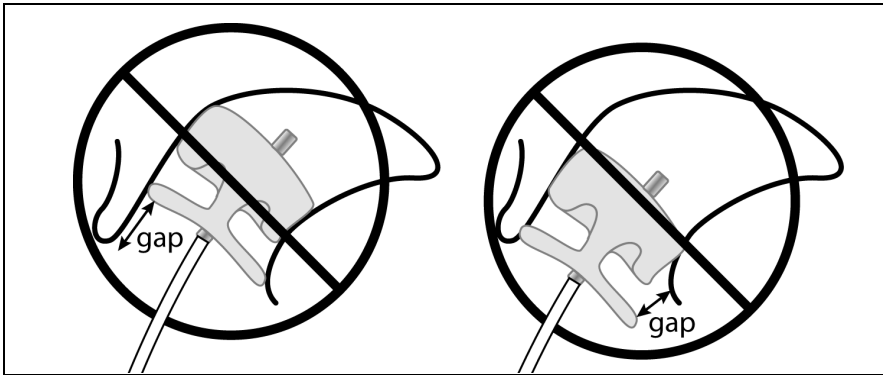

Figure 6. Improper device placement

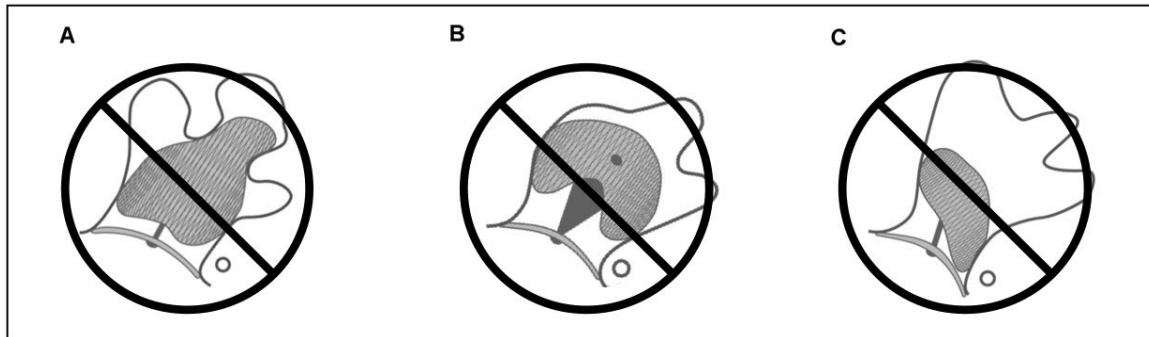

Figure 7. Improper device sizing and placement

27. Confirm proper device placement using echocardiography and fluoroscopy following CLOSE methodology. Indications of proper device placement include:

- **C** At least 2/3 of the device lobe should be distal to the left Circumflex artery on echocardiography (see Figure 8).
- **L** The device Lobe should be slightly compressed and have good apposition to the left atrial appendage wall.
- **O** The **O**rientation of the device lobe must be in line with the axis of the intended landing zone in the left atrial appendage. See Figures 5, 6, and 8.
- **S** The disc must be **S**eparated from the lobe (see Figure 5).
- **E** The disc will have a concave (**E**lliptical) shape.

NOTE: Figure 7 shows device over-sizing (A and B) and device not in line with the axis (C). Under these circumstances, consideration should be given to device repositioning or replacement with a different size device.

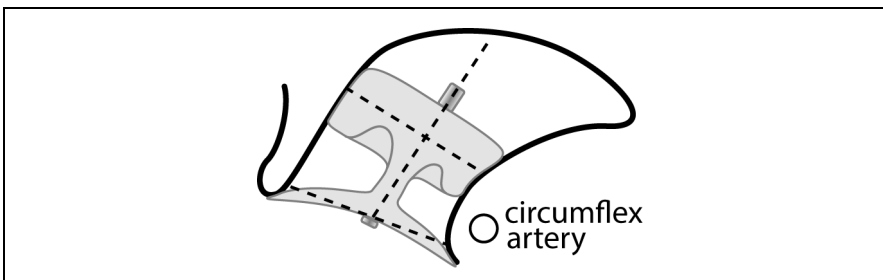

Figure 8. Proper device placement relative to circumflex artery



28. If device repositioning is required:

- Partially recapture the device by maintaining tension on the delivery cable and readvancing the delivery sheath to retrieve the disc and part of the lobe until the platinum thread marker is aligned with the distal edge of the delivery sheath's marker band (see Figure 4). Do not retract the device any farther to prevent damaging the delivery sheath.

**WARNING: If the device is retracted farther than the radiopaque markers, do not readvance the device or perform injections. The device and the delivery sheath must both be removed and replaced.**

- Reposition and redeploy the device (see steps 22 – 27).

NOTE: The device can be partially recaptured and redeployed a maximum of three times. If the device position is still unsatisfactory, then remove and replace both the device and the sheath.

29. Perform echocardiography and fluoroscopy to confirm that the device is in place.

30. When proper device placement is confirmed the device may be released:

- Detach the device by turning the delivery cable/delivery cable vise counter-clockwise.

**CAUTION: Do not exceed eight rotations. If difficulty occurs while attempting to release the device, stop and release the built-up tension. Advance the cable until it is perpendicular with the device and attempt to release.**

31. Remove the delivery cable and the delivery sheath from the patient.

32. Perform echocardiography and fluoroscopy to confirm that the device remains in place.

### Device Reloading Procedure

33. Insert loading cable through the distal loader tip.

34. Attach distal end screw to loading cable.

35. Rotate the loading cable vise clockwise until resistance is felt, ensuring that the loading cable is secured to the device.

36. Immerse the device and hub end of loader in sterile saline to remove air from both components. Device may be massaged to help remove air.

37. Pull the loading cable vise until the lobe is fully retracted within the loader, but stop before the disc is loaded.

38. Connect the delivery cable to the exposed proximal end screw of the device. Grasp the loader and device and rotate the delivery cable clockwise to thread the device onto the delivery cable. Stop rotating the delivery cable when resistance is felt.

39. Immerse the device in sterile saline.

40. Pull the loading cable vise until the device is loaded into the proximal end of the loader.

NOTE: Do not pull the device to the distal end of the loader.

41. Remove the loading cable by rotating the loading cable vise counterclockwise.

42. Return to Step 9.

### Post-Procedure Instructions

- Monitor the patient overnight. Perform a transthoracic echocardiogram (TTE) to make sure the device is in the correct position and no pericardial effusion is present before the patient is discharged.
- Aspirin and clopidogrel (or an alternate antiplatelet agent) is recommended for patients for six months post-implant. The decision to continue antiplatelet therapy (such as aspirin alone) after six months is at the discretion of the physician.
- Oral anticoagulation is not recommended unless residual flow around the device is  $>5\text{mm}^1$ .
- Patients should take appropriate endocarditis prophylaxis for six months following device implantation. The decision to continue endocarditis prophylaxis beyond six months is at the discretion of the physician.
- Instruct the patient when to seek medical attention.
- Provide routine standard of care follow-up<sup>2</sup>, including echocardiography, for evaluation of residual shunt and adverse events (such as thrombus formation and pericardial effusion).

### Disposal

- The carton and instructions for use are recyclable. Dispose of all packaging materials as appropriate.
- Device accessories can be returned to Abbott Medical for disposal. Contact an Abbott Medical representative or [returns@amplatzer.com](mailto:returns@amplatzer.com) for instructions.
- Use solid biohazard waste procedures to discard devices.

---

1. See Clinical Summary and Warnings (above) for medication recommendation for the trial and association between oral anticoagulation and late pericardial effusion.  
2. In the clinical study, rare late pericardial effusion events associated with discharge oral anticoagulation were reported within six months following the procedure.

## Warranty

Abbott Medical warrants to buyer that, for a period equal to the validated shelf life of the product, this product shall meet the product specifications established by the manufacturer when used in accordance with the manufacturer's instructions for use and shall be free from defects in materials and workmanship. Abbott Medical's obligation under this warranty is limited to replacing or repairing at its option, at its factory, this product if returned within the warranty period to Abbott Medical and after confirmed to be defective by the manufacturer.

EXCEPT AS EXPRESSLY PROVIDED IN THIS WARRANTY, ABBOTT MEDICAL DISCLAIMS ANY REPRESENTATION OR WARRANTY OF ANY KIND, EXPRESS OR IMPLIED, INCLUDING ANY WARRANTY AS TO MERCHANTABILITY OR FITNESS FOR A PARTICULAR PURPOSE.

See the Terms and Conditions of Sale for further information.

### State of California (USA) Only:



**WARNING:** This product can expose you to chemicals including ethylene oxide, which is known to the State of California to cause cancer and birth defects or other reproductive harm. For more information, go to [www.P65Warnings.ca.gov](http://www.P65Warnings.ca.gov).

**Appendix A: Supplemental Information**

**Table 1. Device and delivery sheath dimensions (sold separately)**

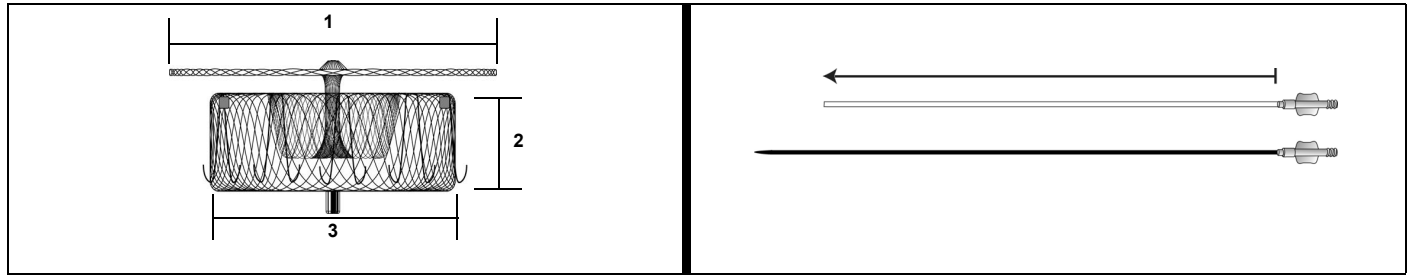

REF	Device Dimension 1	Device Dimension 2	Device Dimension 3	REF				
	mm	mm	mm		Fr	mm (in)	mm (in)	
9-ACP2-007-016	22	7.5	16	9-TV45X45-12F-080 or 9-TV45X45-14F-080	12	4.0 (0.157)	4.8 (0.189)	80
9-ACP2-007-018	24	7.5	18					
9-ACP2-007-020	26	7.5	20					
9-ACP2-007-022	28	7.5	22					
9-ACP2-010-025	32	10	25	9-TV45X45-14F-080	14	4.7 (0.184)	5.5 (0.215)	80
9-ACP2-010-028	35	10	28					
9-ACP2-010-031	38	10	31					
9-ACP2-010-034	41	10	34					

**Table 2. Sizing chart**

Landing Zone Width X <sup>a</sup>	Distance from Orifice Y	Device Size (Lobe Diameter) 3	Device Order Number
mm	mm	mm	
11.0 - 13.0	≥ 10	16	9-ACP2-007-016
13.0 - 15.0	≥ 10	18	9-ACP2-007-018
15.0 - 17.0	≥ 10	20	9-ACP2-007-020
17.0 - 19.0	≥ 10	22	9-ACP2-007-022
19.0 - 22.0	≥ 12	25	9-ACP2-010-025
22.0 - 25.0	≥ 12	28	9-ACP2-010-028
25.0 - 28.0	≥ 12	31	9-ACP2-010-031
28.0 - 31.0	≥ 12	34	9-ACP2-010-034

a. The landing zone is where the lobe of the device will be placed in the left atrial appendage.

<sup>™</sup> Indicates a trademark of the Abbott group of companies.

‡ Indicates a third-party trademark, which is property of its respective owner.

Pat. <http://www.abbott.com/patents>

©2021 Abbott. All Rights Reserved.



**Abbott Medical**

5050 Nathan Lane North  
Plymouth, MN 55442 USA

+1 855 478 5833

+1 651 756 5833





# Amplatzer™ Amulet™

Left Atrial Appendage Occluder



16 mm

Amplatzer™ Amulet™

Left Atrial Appendage Occluder



1904-01-31

REF

9-ACP2-016

LOT

12345678



(01)01234567890123(17)040131(10)12345678(9)1600145163(30)01

16 mm

UDI



(01)01234567890123(17)040131(10)12345678

	1904-01-31
REF	9-ACP2-016
LOT	12345678

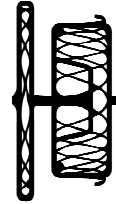

16mm



**Abbott Medical**  
 5050 Nathan Lane North  
 Plymouth, MN  
 55442 USA  
 +1 855 478 5833  
 +1 651 756 5833

Made in Costa Rica 600158287



1900-02-28

STERILE EO

## Amplatzer™ Amulet™ Left Atrial Appendage Occluder



16 mm

	1904-01-31
REF	9-ACP2-016
LOT	12345678



## Amplatzer™ Amulet™

Left Atrial Appendage Occluder

UDI



(01)01234567890123(17)040131(10)12345678

	1904-01-31
REF	9-ACP2-016
LOT	12345678

600158287

600145163

FROM:

TO:

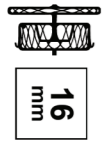

Amplatzer™ Amulet™  
1904-01-31  
REF 9-ACP2-016  
LOT 12345678  
(01)01234567890123(17)040131(10)12345678(9)1800145163(30)01



# Amplatzer™ Amulet™

Left Atrial Appendage Occluder

16 mm

UDI	(01)01234567890123(17)040131(10)12345678
1904-01-31	
REF	9-ACP2-016
LOT	12345678

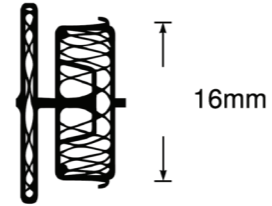

Abbott Medical  
5050 Nathan Lane North  
Plymouth, MN  
55442 USA  
+1 855 478 5833  
+1 651 756 5833

St. Jude Medical  
Costa Rica Ltda.  
Edificio #44  
Calle O, Ave. 2  
Zona Franca Coyoil  
El Coyoil, Alajuela  
Costa Rica

Made in Costa Rica 600158287



1900-02-28 **STERILE** **EO**

## Amplatzer™ Amulet™ Left Atrial Appendage Occluder

16 mm	1904-01-31		
REF	9-ACP2-016	LOT	12345678



UDI	(01)01234567890123(17)040131(10)12345678		
1904-01-31			
REF	9-ACP2-016	LOT	12345678

600158287

600145163

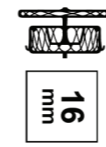

Amplatzer™ Amulet™  
1904-01-31  
REF 9-ACP2-016  
LOT 12345678  
(01)01234567890123(17)040131(10)12345678(9)1800145163(30)01



# Amplatzer™ Amulet™

Left Atrial Appendage Occluder

16 mm

UDI	(01)01234567890123(17)040131(10)12345678
1904-01-31	
REF	9-ACP2-016
LOT	12345678

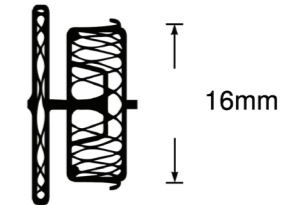

Abbott Medical  
5050 Nathan Lane North  
Plymouth, MN  
55442 USA  
+1 855 478 5833  
+1 651 756 5833

Made in Costa Rica 600158287



1900-02-28 **STERILE** **EO**

## Amplatzer™ Amulet™ Left Atrial Appendage Occluder

16 mm	1904-01-31		
REF	9-ACP2-016	LOT	12345678



UDI	(01)01234567890123(17)040131(10)12345678		
1904-01-31			
REF	9-ACP2-016	LOT	12345678

600158287

600145163



# Amplatzer™ Amulet™

Left Atrial Appendage Occluder



16 mm

Amplatzer™ Amulet™

Left Atrial Appendage Occluder



1904-01-31

REF

9-ACP2-016

LOT

12345678



(01)01234567890123(17)040131(10)12345678(9)1600145136(30)01

16 mm

UDI



(01)01234567890123(17)040131(10)12345678

	1904-01-31
REF	9-ACP2-016
LOT	12345678

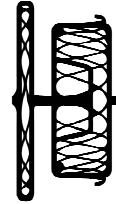

16mm



Abbott Medical  
5050 Nathan Lane North  
Plymouth, MN  
55442 USA  
+1 855 478 5833  
+1 651 756 5833



1900-02-28

STERILE EO

600158276

## Amplatzer™ Amulet™ Left Atrial Appendage Occluder



16 mm

	1904-01-31
REF	9-ACP2-016
LOT	12345678



## Amplatzer™ Amulet™

Left Atrial Appendage Occluder

UDI



(01)01234567890123(17)040131(10)12345678

	1904-01-31
REF	9-ACP2-016
LOT	12345678

600158276

600145136

# Amplatzer™ Amulet™

Left Atrial Appendage Occluder

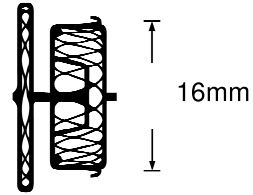

16  
mm

	<b>1904-01-31</b>
REF	9-ACP2-016
LOT	12345678



**Amplatzer™ Amulet™** **1904-01-31**  
 Left Atrial Appendage Occluder REF 9-ACP2-016  
 LOT 12345678  
 UDI (01)01234567890123(17)040131(10)12345678

**Amplatzer™ Amulet™** **1904-01-31**  
 Left Atrial Appendage Occluder REF 9-ACP2-016  
 LOT 12345678  
 UDI (01)01234567890123(17)040131(10)12345678

**Amplatzer™ Amulet™** **1904-01-31**  
 Left Atrial Appendage Occluder REF 9-ACP2-016  
 LOT 12345678  
 UDI (01)01234567890123(17)040131(10)12345678

**Amplatzer™ Amulet™** **1904-01-31**  
 Left Atrial Appendage Occluder REF 9-ACP2-016  
 LOT 12345678  
 UDI (01)01234567890123(17)040131(10)12345678

**Amplatzer™ Amulet™** **1904-01-31**  
 Left Atrial Appendage Occluder REF 9-ACP2-016  
 LOT 12345678  
 UDI (01)01234567890123(17)040131(10)12345678

**Amplatzer™ Amulet™** **1904-01-31**  
 Left Atrial Appendage Occluder REF 9-ACP2-016  
 LOT 12345678  
 UDI (01)01234567890123(17)040131(10)12345678



## FRONT

Brand Bar:  
Abbott Primary Blue

Horizontal Signature:  
0.83in Wide

Titles:  
Brandon Grotisque Bold, 6pt  
Abbott Primary Blue

Patient Name;  
Calibri Bold, 12pt

Body Text:  
Calibri Regular, 7-8pt

Header:  
Brandon Grotisque Medium, 9pt

**Abbott** Patient Identification Card

**PATIENT: JANE A. DOE**  
**DEVICE:** 0123456789

<b>SERIAL/LOT NUMBER</b>	<b>MODEL NUMBER</b>	<b>IMPLANT DATE</b>
123456789	1234	21/MAR/2018

**IMPLANTING PHYSICIAN:** JANE SMITH  
**HOSPITAL:** AUSTIN TX 78705-1103  
600162936 B [medical.abbott/manuals](http://medical.abbott/manuals)

## BACK

Header:  
Brandon Grotisque Bold, 7pt

2.13 in

### MRI Safety Information:

Non-clinical testing has demonstrated that the Amplatzer™ Amulet™ Left Atrial Appendage Occluder device is MR Conditional. A patient with the Amplatzer™ Amulet™ can be safely scanned in an MR system under the following conditions:

- Static magnetic fields of 1.5 Tesla (1.5T) and 3.0 Tesla (3.0T).
- Maximum spatial gradient field of 19 T/m (1900 G/cm).
- Maximum MR system reported, whole-body averaged specific absorption rate (SAR) of 2.0 W/kg (normal operating mode)

Under the scan conditions defined above, the device is expected to produce a maximum temperature rise of less than or equal to 4°C after 15 minutes of continuous scanning. In non-clinical testing, the image artifact caused by the device extends radially up to 20mm from the device when imaged with a gradient echo pulse sequence in 3.0T MR system.

 **Abbott Medical**  
5050 Nathan Lane North  
Plymouth, MN 55442 USA

Body Text:  
Brandon Grotisque Medium, 6pt

3.38 in

0.13 R  
(REF)

FROM:

FRONT

**Abbott** Patient Identification Card



**PATIENT: JANE A. DOE**  
**DEVICE: 0123456789**

SERIAL/LOT NUMBER	MODEL NUMBER	IMPLANT DATE
123456789	1234	21/MAR/2018

**IMPLANTING PHYSICIAN: JANE SMITH**  
**HOSPITAL: AUSTIN TX 78705-1103**

600162936 A    [medical.abbott/manuals](http://medical.abbott/manuals)

**Abbott Medical**  
 5050 Nathan Lane North  
 Plymouth, MN 55442 USA

BACK

~~The patient whose name appears on this card is implanted with a medical device.~~

**MRI Safety Information:**  
 Non-clinical testing has demonstrated that the Amplatzer™ Amulet™ Left Atrial Appendage Occluder device is MR Conditional. A patient with the Amplatzer™ Amulet™ can be safely scanned in an MR system under the following conditions:

- Static magnetic fields of 1.5 Tesla (1.5T) and 3.0 Tesla (3.0T).
- Maximum spatial gradient field of 19 T/m (1900 G/cm).
- Maximum MR system reported, whole-body averaged specific absorption rate (SAR) of 2.0 W/kg (normal operating mode)

Under the scan conditions defined above, the device is expected to produce a maximum temperature rise of less than or equal to 4°C after 15 minutes of continuous scanning. In non-clinical testing, the image artifact caused by the device extends radially up to 20mm from the device when imaged with a gradient echo pulse sequence in 3.0T MR system.



**Abbott Medical**  
 5050 Nathan Lane North  
 Plymouth, MN 55442 USA

TO:

FRONT

**Abbott** Patient Identification Card

**PATIENT: JANE A. DOE**  
**DEVICE: 0123456789**

SERIAL/LOT NUMBER	MODEL NUMBER	IMPLANT DATE
123456789	1234	21/MAR/2018

**IMPLANTING PHYSICIAN: JANE SMITH**  
**HOSPITAL: AUSTIN TX 78705-1103**

600162936 B    [medical.abbott/manuals](http://medical.abbott/manuals)



BACK

**MRI Safety Information:**  
 Non-clinical testing has demonstrated that the Amplatzer™ Amulet™ Left Atrial Appendage Occluder device is MR Conditional. A patient with the Amplatzer™ Amulet™ can be safely scanned in an MR system under the following conditions:

- Static magnetic fields of 1.5 Tesla (1.5T) and 3.0 Tesla (3.0T).
- Maximum spatial gradient field of 19 T/m (1900 G/cm).
- Maximum MR system reported, whole-body averaged specific absorption rate (SAR) of 2.0 W/kg (normal operating mode)

Under the scan conditions defined above, the device is expected to produce a maximum temperature rise of less than or equal to 4°C after 15 minutes of continuous scanning. In non-clinical testing, the image artifact caused by the device extends radially up to 20mm from the device when imaged with a gradient echo pulse sequence in 3.0T MR system.

**Abbott Medical**  
 5050 Nathan Lane North  
 Plymouth, MN 55442 USA

