



Edwards

## **Edwards SAPIEN 3 and SAPIEN 3 Ultra Transcatheter Heart Valve System**

### **Edwards SAPIEN 3 and Edwards SAPIEN 3 Ultra Transcatheter Heart Valve Edwards Commander Delivery System**

#### **Instructions for Use**

**CAUTION:** Federal (USA) law restricts these devices to sale by or on the order of a physician.

Implantation of the transcatheter heart valve should be performed only by physicians who have received Edwards Lifesciences training. The implanting physician should be experienced in balloon aortic valvuloplasty.

Please verify that you have the latest version of the instructions for use prior to using the device by visiting <http://THVIFU.edwards.com> or by calling 1.800.822.9837. In order to access the instructions for use, an IFU Code will be required.

**STERILE:** The valve is supplied sterilized with glutaraldehyde solution. The delivery system, sheath, and crimper are supplied sterilized with ethylene oxide gas.

---

Edwards, Edwards Lifesciences, the stylized E logo, Carpentier-Edwards, Edwards Commander, Edwards SAPIEN, Edwards SAPIEN XT, Edwards SAPIEN 3, Edwards SAPIEN 3 Ultra, INSPIRIS, INSPIRIS RESILIA, PARTNER, PARTNER II, PARTNER 3, Qualcrimp, RESILIA, SAPIEN, SAPIEN XT, SAPIEN 3, SAPIEN 3 Ultra, ThermoFix, and VFit are trademarks of Edwards Lifesciences Corporation. All other trademarks are the property of their respective owners.

## 1.0 Device Description

### Edwards SAPIEN 3 and SAPIEN 3 Ultra Transcatheter Heart Valve System

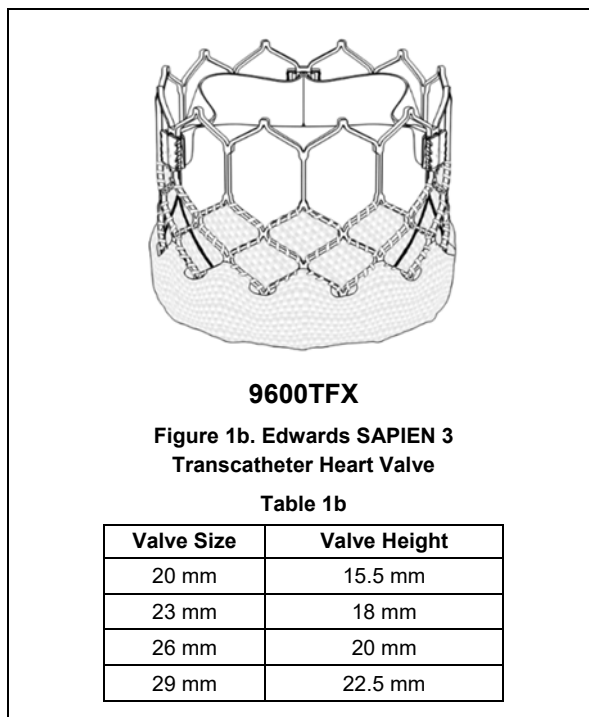
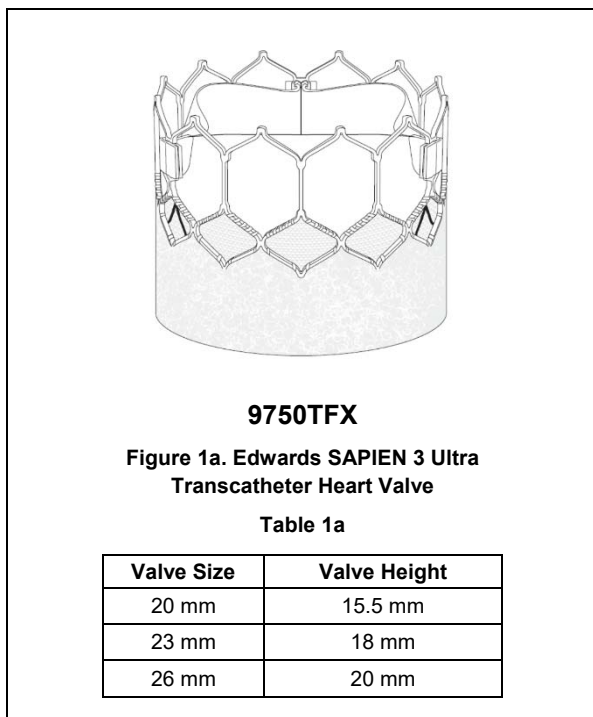
The Edwards SAPIEN 3 and SAPIEN 3 Ultra Transcatheter Heart Valve (THV) system consists of the Edwards SAPIEN 3 and SAPIEN 3 Ultra transcatheter heart valves and delivery systems.

- **Edwards SAPIEN 3 Ultra Transcatheter Heart Valve – (Figure 1a)**

The Edwards SAPIEN 3 Ultra transcatheter heart valve is comprised of a balloon-expandable, radiopaque, cobalt-chromium frame, trileaflet bovine pericardial tissue valve, and polyethylene terephthalate (PET) inner and outer fabric skirts. The leaflets are treated according to the Carpentier-Edwards ThermaFix process.

- **Edwards SAPIEN 3 Transcatheter Heart Valve (Figure 1b)**

The Edwards SAPIEN 3 transcatheter heart valve is comprised of a balloon-expandable, radiopaque, cobalt-chromium frame, trileaflet bovine pericardial tissue valve, and polyethylene terephthalate (PET) fabric skirt. The leaflets are treated according to the Carpentier-Edwards ThermaFix process.



Sizing recommendations for implanting the Edwards SAPIEN 3 and SAPIEN 3 Ultra transcatheter heart valves in a native annulus are provided in the table below:

**Table 2**

Native Valve Annulus Size (TEE)	Native Valve Annulus Size (CT)		THV Size
	Area	Area Derived Diameter	
16 – 19 mm	273 – 345 mm <sup>2</sup>	18.6 – 21 mm	20 mm
18 – 22 mm	338 – 430 mm <sup>2</sup>	20.7 – 23.4 mm	23 mm
21 – 25 mm	430 – 546 mm <sup>2</sup>	23.4 – 26.4 mm	26 mm
24 – 28 mm	540 – 683 mm <sup>2</sup>	26.2 – 29.5 mm	29 mm

Valve size recommendations are based on native valve annulus size, as measured by transesophageal echocardiography (TEE) or computed tomography (CT). Patient anatomical factors and multiple imaging modalities should be considered during valve size selection.  
 Note: Risks associated with undersizing and oversizing should be considered.

Sizing recommendations for implanting the Edwards SAPIEN 3 and SAPIEN 3 Ultra transcatheter heart valves in a failing surgical bioprosthesis, except for the INSPIRIS RESILIA aortic valve sizes 19-25 mm, are provided in the table below:

**Table 3a**

<b>Surgical Valve True Inner Diameter (ID)<sup>[1]</sup></b>	<b>THV Size</b>
16.5 – 19.0 mm	20 mm
18.5 – 22.0 mm	23 mm
22.0 – 25.0 mm	26 mm
25.0 – 28.5 mm	29 mm

**NOTE: Surgical valve ‘True ID’ may be smaller than the labeled valve size. For THV-in-THV, the native valve annulus size should be considered to determine the appropriate THV size to implant. For a failing stentless bioprosthesis, consider sizing recommendations for a native annulus. The dimensions of the failed bioprosthesis should be determined so that the appropriate THV size can be implanted; and is best determined by using computed tomography, magnetic resonance imaging, and/or transesophageal echocardiography.**

Sizing recommendations for implanting the Edwards SAPIEN 3 and SAPIEN 3 Ultra transcatheter heart valves in a failing INSPIRIS RESILIA aortic surgical bioprosthesis in sizes 19 – 25 mm are provided in the table below:

**Table 3b**

<b>INSPIRIS RESILIA Aortic Valve (model 11500A)* Labeled Size</b>	<b>THV Size</b>
19 mm	20 mm or 23 mm
21 mm	23 mm or 26 mm
23 mm	26 mm
25 mm	29 mm

\*INSPIRIS RESILIA aortic valve model 11500A sizes 19 – 25 mm incorporate VFit technology which consists of expandable bands and fluoroscopically visible size markers designed for potential future valve-in-valve procedures. Clinical data are not currently available on the INSPIRIS RESILIA aortic valve Model 11500A valve-in-valve procedure or expansion feature. The impact of tissue ingrowth on the expansion feature of the INSPIRIS RESILIA aortic valve has not been assessed.

**WARNING: Do not perform stand-alone balloon aortic valvuloplasty procedures in the INSPIRIS RESILIA aortic valve for the sizes 19-25 mm. This may expand the valve causing aortic incompetence, coronary embolism or annular rupture.**

**NOTE: INSPIRIS RESILIA aortic valve model 11500A sizes 27 – 29 mm do not incorporate VFit technology and therefore follow the surgical valve True ID sizing provided in table 3a.**

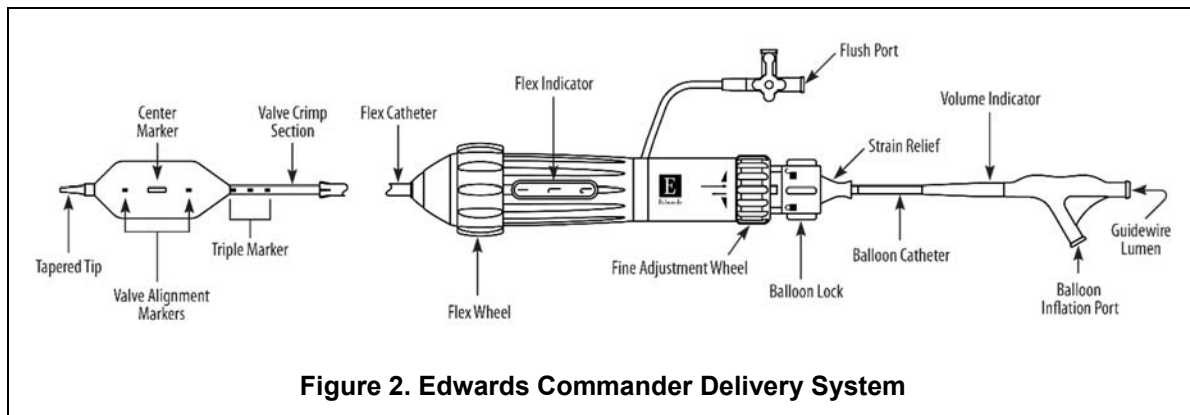
**NOTE: Exact volume required to deploy the THV may vary depending on the bioprosthesis inner diameter. Factors such as calcification and pannus tissue growth may not be accurately visualized in imaging and may reduce the effective inner diameter of the failing bioprosthesis to a size smaller than the ‘True ID’. These factors should be considered and assessed in order to determine the most appropriate THV size to achieve nominal THV deployment and sufficient anchoring. Do not exceed the rated burst pressure. See Table 4 for inflation parameters.**

• **Edwards Commander Delivery System (Figure 2)**

The Edwards Commander delivery system facilitates the placement of the bioprosthesis. It consists of a Flex Catheter to aid in valve alignment to the balloon, tracking, and positioning of the valve. The delivery system includes a tapered tip to facilitate crossing of the valve. The handle contains a Flex Wheel to control flexing of the Flex Catheter, and a Balloon Lock and Fine Adjustment Wheel to facilitate valve alignment and positioning of the valve within the target location. A stylet is included within the guidewire lumen of the delivery system. The Balloon Catheter has radiopaque Valve Alignment Markers defining the working length of the balloon. A radiopaque Center Marker in the balloon is provided to help with valve positioning. A radiopaque Triple Marker proximal to the balloon indicates the Flex Catheter position during deployment. The inflation parameters for valve deployment are:

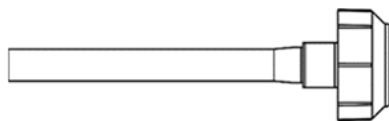
**Table 4**

Model	Nominal Balloon Diameter	Nominal Inflation Volume	Rated Burst Pressure (RBP)
9600LDS20 9750CM20	20 mm	11 mL	7 atm
9600LDS23 9750CM23	23 mm	17 mL	7 atm
9600LDS26 9750CM26	26 mm	23 mL	7 atm
9600LDS29	29 mm	33 mL	7 atm



**Figure 2. Edwards Commander Delivery System**

**Additional Accessories**



**Figure 3. Loader**



**Figure 4. Qualcrimp Crimping Accessory**

- **Loader**

The loader allows for the delivery of the crimped valve through the hemostasis valves of the sheath.

- **Edwards Sheath**

Refer to the provided Edwards sheath instructions for use for device description.

- **Edwards Crimper**

Refer to the Edwards Crimper instructions for use for device description.

## **2.0 Indications**

- 1) The Edwards SAPIEN 3 and SAPIEN 3 Ultra Transcatheter Heart Valve system is indicated for relief of aortic stenosis in patients with symptomatic heart disease due to severe native calcific aortic stenosis who are judged by a Heart Team, including a cardiac surgeon, to be appropriate for the transcatheter heart valve replacement therapy.
- 2) The Edwards SAPIEN 3 and SAPIEN 3 Ultra Transcatheter Heart Valve system is indicated for patients with symptomatic heart disease due to failing (stenosed, insufficient, or combined) of a surgical or transcatheter bioprosthetic aortic valve or surgical bioprosthetic mitral valve who are judged by a heart team, including a cardiac surgeon, to be at high or greater risk for open surgical therapy (i.e., predicted risk of surgical mortality  $\geq 8\%$  at 30 days, based on the Society of Thoracic Surgeons (STS) risk score and other clinical co-morbidities unmeasured by the STS risk calculator).

## **3.0 Contraindications**

The valve and delivery systems are contraindicated in patients who cannot tolerate an anticoagulation/antiplatelet regimen or who have active bacterial endocarditis or other active infections.

## **4.0 Warnings**

- Observation of the pacing lead throughout the procedure is essential to avoid the potential risk of pacing lead perforation.
- There may be an increased risk of stroke in transcatheter aortic valve replacement procedures, as compared to balloon aortic valvuloplasty or other standard treatments in high or greater risk patients.
- The devices are designed, intended, and distributed for single use only. **Do not resterilize or reuse the devices.** There are no data to support the sterility, nonpyrogenicity, and functionality of the devices after reprocessing.
- Incorrect sizing of the valve may lead to paravalvular leak, migration, embolization, residual gradient (patient-prosthesis mismatch) and/or annular rupture.
- Accelerated deterioration of the valve due to calcific degeneration may occur in children, adolescents, or young adults and in patients with an altered calcium metabolism.
- Prior to delivery, the valve must remain hydrated at all times and cannot be exposed to solutions other than its shipping storage solution and sterile physiologic rinsing solution. Valve leaflets mishandled or damaged during any part of the procedure will require replacement of the valve.
- Caution should be exercised in implanting a valve in patients with clinically significant coronary artery disease.
- Patients with pre-existing bioprostheses should be carefully assessed prior to implantation of the valve to ensure proper valve positioning and deployment.
- Do not use the valve if the tamper evident seal is broken, the storage solution does not completely cover the valve, the temperature indicator has been activated, the valve is damaged, or the expiration date has elapsed.
- Do not mishandle the delivery system or use it if the packaging or any components are not sterile, have been opened or are damaged (e.g. kinked or stretched), or the expiration date has elapsed.
- Use of excessive contrast media may lead to renal failure. Measure the patient's creatinine level prior to the procedure. Contrast media usage should be monitored.

- Patient injury could occur if the delivery system is not un-flexed prior to removal.
- Care should be exercised in patients with hypersensitivities to cobalt, nickel, chromium, molybdenum, titanium, manganese, silicon, and/or polymeric materials.
- The procedure should be conducted under fluoroscopic guidance. Some fluoroscopically guided procedures are associated with a risk of radiation injury to the skin. These injuries may be painful, disfiguring, and long-lasting.
- Valve recipients should be maintained on anticoagulant/antiplatelet therapy, except when contraindicated, as determined by their physician. This device has not been tested for use without anticoagulation.
- Do not add or apply antibiotics to the storage solution, rinse solutions, or to the valve.
- Balloon valvuloplasty should be avoided in the treatment of failing bioprostheses as this may result in embolization of bioprosthesis material and mechanical disruption of the valve leaflets.

## 5.0 Precautions

- Long-term durability has not been established for the valve. Regular medical follow-up is advised to evaluate valve performance.
- Limited clinical data are available for transcatheter aortic valve replacement in patients with a congenital bicuspid aortic valve who are deemed to be at low surgical risk. Anatomical characteristics should be considered when using the valve in this population. In addition, patient age should be considered as long-term durability of the valve has not been established.
- Glutaraldehyde may cause irritation of the skin, eyes, nose and throat. Avoid prolonged or repeated exposure to, or breathing of, the solution. Use only with adequate ventilation. If skin contact occurs, immediately flush the affected area with water; in the event of contact with eyes, seek immediate medical attention. For more information about glutaraldehyde exposure, refer to the Material Safety Data Sheet available from Edwards Lifesciences.
- To maintain proper valve leaflet coaptation, do not overinflate the deployment balloon.
- Appropriate antibiotic prophylaxis is recommended post-procedure in patients at risk for prosthetic valve infection and endocarditis.
- Additional precautions for transseptal replacement of a failed mitral valve bioprosthesis include, presence of devices or thrombus or other abnormalities in the caval vein precluding safe transvenous femoral access for transseptal approach; presence of Atrial Septal Occluder Device or calcium preventing safe transseptal access.
- Special care must be exercised in mitral valve replacement if chordal preservation techniques were used in the primary implantation to avoid entrapment of the subvalvular apparatus.
- Safety and effectiveness have not been established for patients with the following characteristics/comorbidities:
  - Non-calcified aortic annulus
  - Severe ventricular dysfunction with ejection fraction < 20%
  - Congenital unicuspid aortic valve
  - Pre-existing prosthetic ring in any position
  - Severe mitral annular calcification (MAC), severe (> 3+) mitral insufficiency, or Gorlin syndrome
  - Blood dyscrasias defined as: leukopenia (WBC < 3000 cells/mL), acute anemia (Hb < 9 g/dL), thrombocytopenia (platelet count < 50,000 cells/mL), or history of bleeding diathesis or coagulopathy
  - Hypertrophic cardiomyopathy with or without obstruction (HOCM)
  - Echocardiographic evidence of intracardiac mass, thrombus, or vegetation
  - A known hypersensitivity or contraindication to aspirin, heparin, ticlopidine (Ticlid™), or clopidogrel (Plavix™), or sensitivity to contrast media, which cannot be adequately premedicated
  - Significant aortic disease, including abdominal aortic or thoracic aneurysm defined as maximal luminal diameter

5 cm or greater; marked tortuosity (hyperacute bend), aortic arch atheroma (especially if thick [ $> 5$  mm], protruding, or ulcerated) or narrowing (especially with calcification and surface irregularities) of the abdominal or thoracic aorta, severe “unfolding” and tortuosity of the thoracic aorta

- Access characteristics that would preclude safe placement of the Edwards sheath, such as severe obstructive calcification or severe tortuosity
- Bulky calcified aortic valve leaflets in close proximity to coronary ostia
- A concomitant paravalvular leak where the failing bioprosthesis is not securely fixed in the native annulus or is not structurally intact (e.g. wireform frame fracture)
- A partially detached leaflet of the failing bioprosthesis that in the aortic position may obstruct a coronary ostium
- For Left axillary approach, a left subclavian takeoff angle  $\sim \geq 90^\circ$  from the aortic arch causes sharp angles, which may be responsible for potential sheath kinking, subclavian/axillary dissection and aortic arch damage.
- Ensure there is flow in Left Internal Mammary Artery (LIMA)/Right Internal Mammary Artery (RIMA) during procedure and monitor PA pressure in homolateral radial artery.
- Residual mean gradient may be higher in a “THV-in-failing bioprosthesis” configuration than that observed following implantation of the valve inside a native aortic annulus using the same size device. Patients with elevated mean gradient post procedure should be carefully followed. It is important that the manufacturer, model and size of the preexisting bioprosthetic valve be determined, so that the appropriate valve can be implanted and a prosthesis-patient mismatch be avoided. Additionally, pre-procedure imaging modalities must be employed to make as accurate a determination of the inner diameter as possible.

## 6.0 Potential Adverse Events

Potential risks associated with the overall procedure including potential access complications associated with standard cardiac catheterization, balloon valvuloplasty, the potential risks of conscious sedation and/or general anesthesia, and the use of angiography:

- Death
- Stroke/transient ischemic attack, clusters or neurological deficit
- Paralysis
- Permanent disability
- Respiratory insufficiency or respiratory failure
- Hemorrhage requiring transfusion or intervention
- Cardiovascular injury including perforation or dissection of vessels, ventricle, atrium, septum, myocardium or valvular structures that may require intervention
- Pericardial effusion or cardiac tamponade
- Thoracic bleeding
- Embolization including air, calcific valve material or thrombus
- Infection including septicemia and endocarditis
- Heart failure
- Myocardial infarction
- Renal insufficiency or renal failure
- Conduction system defect which may require a permanent pacemaker
- Arrhythmia
- Retroperitoneal bleed
- Arteriovenous (AV) fistula or pseudoaneurysm

- Reoperation
- Ischemia or nerve injury or brachial plexus injury
- Restenosis
- Pulmonary edema
- Pleural effusion
- Bleeding
- Anemia
- Abnormal lab values (including electrolyte imbalance)
- Hypertension or hypotension
- Allergic reaction to anesthesia, contrast media, or device materials
- Hematoma
- Syncope
- Pain or changes at the access site
- Exercise intolerance or weakness
- Inflammation
- Angina
- Heart murmur
- Fever

Additional potential risks associated with the use of the valve, delivery system, and/or accessories include:

- Cardiac arrest
- Cardiogenic shock
- Emergency cardiac surgery
- Cardiac failure or low cardiac output
- Coronary flow obstruction/transvalvular flow disturbance
- Device thrombosis requiring intervention
- Valve thrombosis
- Device embolization
- Device migration or malposition requiring intervention
- Left ventricular outflow tract obstruction
- Valve deployment in unintended location
- Valve stenosis
- Structural valve deterioration (wear, fracture, calcification, leaflet tear/tearing from the stent posts, leaflet retraction, suture line disruption of components of a prosthetic valve, thickening, stenosis)
- Device degeneration
- Paravalvular or transvalvular leak
- Valve regurgitation
- Hemolysis
- Device explants



- Nonstructural dysfunction
- Mechanical failure of delivery system, and/or accessories
- Non-emergent reoperation

## 7.0 Directions for Use

### 7.1 System Compatibility

**Table 5a**

Product Name	20 mm System	23 mm System	26 mm System
	Model		
Edwards SAPIEN 3 Ultra Transcatheter Heart Valve	9750TFX20	9750TFX23	9750TFX26
Edwards Commander Delivery System	9750CM20	9750CM23	9750CM26
Sheath provided by Edwards Lifesciences			
Inflation device, Qualcrimp crimping accessory, Crimp Stopper and Loader provided by Edwards Lifesciences			
Edwards Crimper	9600CR		

**Table 5b**

Product Name	20 mm System	23 mm System	26 mm System	29 mm System
	Model			
Edwards SAPIEN 3 Transcatheter Heart Valve	9600TFX20	9600TFX23	9600TFX26	9600TFX29
Edwards Commander Delivery System	9600LDS20	9600LDS23	9600LDS26	9600LDS29
Sheath provided by Edwards Lifesciences				
Inflation device, Qualcrimp crimping accessory, Crimp Stopper and Loader provided by Edwards Lifesciences				
Edwards Crimper	9600CR			

#### Additional Equipment:

- Balloon catheter, per the discretion of the physician
- 20 cc syringe or larger (x2)
- 50 cc syringe or larger
- High-pressure 3-way stopcock (x2)
- Standard cardiac catheterization lab equipment
- Fluoroscopy (fixed, mobile or semi-mobile fluoroscopy systems appropriate for use in percutaneous coronary interventions)
- Transesophageal or transthoracic echocardiography capabilities

- Exchange length 0.035 inch (0.89 mm) extra-stiff guidewire
- Temporary pacemaker (PM) and pacing lead
- Instrumentation for transseptal access and septostomy, as applicable
- Sterile rinsing basins, physiological saline, heparinized saline, 15% diluted radiopaque contrast medium
- Sterile table for valve and device preparation

## 7.2 Valve Handling and Preparation

Follow sterile technique during device preparation and implantation.

### 7.2.1 Valve Rinsing Procedure

Before opening the valve jar, carefully examine for evidence of damage (e.g. a cracked jar or lid, leakage, or broken or missing seals).

**CAUTION: Valves from containers found to be damaged, leaking, without adequate sterilant, or missing intact seals must not be used for implantation.**

Step	Procedure
1	Set up two (2) sterile bowls with at least 500 mL of sterile physiological saline to thoroughly rinse the glutaraldehyde sterilant from the valve.
2	Carefully remove the valve/holder assembly from the jar without touching the tissue. Verify the valve serial identification number with the number on the jar lid and record in the patient information documents. Inspect the valve for any signs of damage to the frame or tissue.
3	Rinse the valve as follows: Place the valve in the first bowl of sterile, physiological saline. Be sure the saline solution completely covers the valve and holder. With the valve and holder submerged, slowly agitate (to gently swirl the valve and holder) back and forth for a minimum of 1 minute. Transfer the valve and holder to the second rinsing bowl of sterile physiological saline and gently agitate for at least one more minute. Ensure the rinse solution in the first bowl is not used. The valve should be left in the final rinse solution until needed to prevent the tissue from drying.  <b>CAUTION: Do not allow the valve to come into contact with the bottom or sides of the rinse bowl during agitation or swirling in the rinse solution. Direct contact between the identification tag and valve is also to be avoided during the rinse procedure. No other objects should be placed in the rinse bowls. The valve should be kept hydrated to prevent the tissue from drying.</b>

### 7.2.2 Prepare the Components

Refer to the Edwards sheath, Edwards Crimper and Edwards Balloon Catheter instructions for use for device preparation.

Step	Procedure
1	Visually inspect all components for damage. Ensure the Edwards Commander delivery system is fully unflexed and the balloon catheter is fully advanced in the flex catheter.  <b>WARNING: To prevent possible damage to the balloon shaft, ensure that the proximal end of the balloon shaft is not subjected to bending.</b>
2	Flush the flex catheter.
3	Carefully remove the distal balloon cover from the delivery system.
4	Remove the stylet from the distal end of the guidewire lumen and set aside. Flush the guidewire lumen with heparinized saline and insert the stylet back into the distal end of the guidewire lumen.  <b>NOTE: Failure to insert the stylet back into the guidewire lumen may result in damage to the lumen during crimping process.</b>

Step	Procedure
5	Place the delivery system into the default position and make sure that the flex catheter tip is covered by the proximal balloon cover. Unscrew the loader cap from the loader tube and flush the loader cap. Place the loader cap over the proximal balloon cover and onto the flex catheter with the inside of the cap oriented towards the distal tip.
6	Fully advance the balloon catheter in the flex catheter. Peel off the proximal balloon cover over the blue section of the balloon shaft.
7	Attach a 3-way stopcock to the balloon inflation port. Partially fill a 50 cc or larger syringe with 15-20 mL diluted contrast medium and attach to the 3-way stopcock.
8	Fill the inflation device provided by Edwards Lifesciences with excess volume relative to the indicated inflation volume. Lock the inflation device and attach to the 3-way stopcock.
9	Close the 3-way stopcock to the inflation device provided by Edwards Lifesciences and de-air the system using the 50 cc or larger syringe. Slowly release the plunger and leave zero-pressure in the system. <b>WARNING: Ensure there is no residual fluid left in the balloon to avoid potential difficulty with valve alignment during the procedure.</b>
10	Close the stopcock to the delivery system. By rotating the knob of the inflation device provided by Edwards Lifesciences, transfer the contrast medium into the syringe to achieve the appropriate volume required to deploy the valve.
11	Close the stopcock to the 50 cc or larger syringe. Remove the syringe. Verify that the inflation volume is correct and lock the inflation device provided by Edwards Lifesciences. <b>CAUTION: Maintain the inflation device provided by Edwards Lifesciences in the locked position until valve deployment.</b>

### 7.2.3 Mount and Crimp the Valve on the Delivery System

Step	Procedure
1	Set up two (2) additional sterile bowls with at least 100 mL of sterile physiological saline to thoroughly rinse the Qualcrimp crimping accessory.
2	Completely submerge the Qualcrimp crimping accessory in the first bowl and gently compress it to ensure complete saline absorption. Slowly swirl the Qualcrimp crimping accessory for a minimum of 1 minute. Repeat this process in the second bowl.
3	Remove the valve from the holder and remove the ID tag.
4	Attach the 2-piece crimp stopper to the base of the crimper and click into place.
5	With the crimper in the open position, gently place the valve into the crimper aperture. Gradually crimp the valve until it fits into the Qualcrimp crimping accessory.
6	Place the Qualcrimp crimping accessory over the valve making sure the valve is parallel to the edge of the Qualcrimp crimping accessory.
7	Place the valve and Qualcrimp crimping accessory in crimper aperture. Insert the delivery system coaxially within the valve on the Valve Crimp Section (2-3 mm distal to the balloon shaft) with the orientation of the valve on the delivery system as described below: <b>Antegrade approach:</b> Inflow (outer skirt end) of the valve towards the proximal end of the delivery system. <b>Retrograde approach:</b> Inflow (outer skirt end) of the valve towards the distal end of the delivery system.
8	Crimp the valve until it reaches the Qualcrimp Stop located on the 2-piece Crimp Stopper.

Step	Procedure
9	Gently remove the Qualcrimp crimping accessory from the valve. Remove the Qualcrimp Stop from the Final Stop, leaving the Final Stop in place.
10	Fully crimp the valve until it reaches the Final Stop. <b>NOTE: Ensure that the Valve Crimp Section remains coaxial within the valve.</b>
11	Repeat the full crimp of the valve two more times for a total of three full crimps.
12	Pull the balloon shaft and lock in the default position.
13	Flush the loader with heparinized saline. Immediately advance the valve into the loader until it is completely inside the loader. <b>CAUTION: To prevent possible leaflet damage, the valve should not remain fully crimped and/or in the loader for over 15 minutes.</b>
14	Attach the loader cap to the loader, re-flush the delivery system through the flush port and close the stopcock to the delivery system. Remove the stylet and flush the guidewire lumen of the delivery system. <b>CAUTION: Keep the valve hydrated until ready for implantation.</b> <b>CAUTION: The physician must verify correct orientation of the valve prior to its implantation.</b>

### 7.3 Valvuloplasty and Valve Delivery

Valvuloplasty and valve delivery should be performed under conscious sedation and/or general anesthesia with hemodynamic monitoring in a catheterization lab/hybrid operating room with fluoroscopic and echocardiographic imaging capabilities.

Administer heparin to maintain the ACT at  $\geq 250$  sec during the procedure.

**Balloon valvuloplasty should be avoided in the treatment of failing bioprostheses as this may result in embolization of bioprosthesis material and mechanical disruption of the valve leaflets.**

**CAUTION: Use of excessive contrast media may lead to renal failure. Measure the patient's creatinine level prior to the procedure. Contrast media usage should be monitored.**

**CAUTION: Procedure may require an arterial cut-down with surgical closure of the puncture site due to the size of the arteriotomy.**

#### 7.3.1 Baseline Parameters

Step	Procedure
1	Perform an angiogram with fluoroscopic view perpendicular to the valve.
2	Evaluate the distance of the left and right coronary ostia from the aortic annulus in relation to the valve frame height.
3	Introduce a pacemaker (PM) lead and position appropriately.
4	Set the stimulation parameters to obtain 1:1 capture, and test pacing.

#### 7.3.2 Valvuloplasty

Pre-dilate the native aortic valve, per the discretion of the physician, according to the instructions for use for the selected balloon aortic valvuloplasty catheter.

**CAUTION: Valve implantation should not be carried out if the balloon cannot be fully inflated during valvuloplasty.**

### 7.3.3 Valve Delivery

Step	Procedure
1	Gain access using standard catheterization techniques.
2	Prepare and insert the Edwards sheath. Refer to the Edwards sheath IFU for information on device preparation and handling.
3	Insert the loader into the sheath until the loader stops.
4	<p>Advance the Edwards Commander delivery system, with the Edwards logo in the proper orientation (the delivery system articulates in a direction opposite from the flush port), through the sheath until the valve exits the sheath.</p> <p><b>NOTE: Maintain the proper orientation of the flex catheter throughout the procedure. The delivery system articulates in a direction opposite from the flush port.</b></p> <p><b>CAUTION: For iliofemoral access, the valve should not be advanced through the sheath if the sheath tip is not past the bifurcation.</b></p> <p><b>CAUTION: To prevent possible leaflet damage, the valve should not remain in the sheath for over 5 minutes.</b></p>
5	<p>In a straight section of the vasculature, initiate valve alignment by disengaging the Balloon Lock and pulling the balloon catheter straight back until part of the Warning Marker is visible. Do not pull past the Warning Marker.</p> <p><b>WARNING: To prevent possible damage to the balloon shaft, ensure that the proximal end of the balloon shaft is not subjected to bending.</b></p> <p>Engage the Balloon Lock.</p> <p>Use the Fine Adjustment Wheel to position the valve between the valve alignment markers.</p> <p><b>CAUTION: Do not turn the Fine Adjustment Wheel if the Balloon Lock is not engaged.</b></p> <p><b>WARNING: Do not position the valve past the distal Valve Alignment Marker. This will prevent proper valve deployment.</b></p> <p><b>CAUTION: Maintain guidewire position during valve alignment.</b></p> <p><b>WARNING: If valve alignment is not performed in a straight section, there may be difficulties performing this step which may lead to delivery system damage and inability to inflate the balloon. Utilizing alternate fluoroscopic views may help with assessing curvature of the anatomy. If excessive tension is experienced during valve alignment, repositioning the delivery system to a different straight section of the aorta and relieving compression (or tension) in the system will be necessary.</b></p>
6	<p>Advance the catheter and use the flex wheel, if needed, and cross the valve.</p> <p><b>NOTE: Verify the orientation of the Edwards logo to ensure proper articulation. The delivery system articulates in a direction opposite from the flush port.</b></p>
7	Disengage the Balloon Lock and retract the tip of the Flex Catheter to the center of the Triple Marker. Engage the Balloon Lock.
8	Verify the correct position of the valve with respect to the target location.
9	As necessary, utilize the Flex Wheel to adjust the co-axiality of the valve and the Fine Adjustment Wheel to adjust the position of the valve.
10	Before deployment, ensure that the valve is correctly positioned between the Valve Alignment Markers and the Flex Catheter tip is over the Triple Marker.

Step	Procedure
11	<p>Begin valve deployment:</p> <ul style="list-style-type: none"> <li>• Unlock the inflation device provided by Edwards Lifesciences.</li> <li>• Begin rapid pacing; once systolic blood pressure has decreased to 50 mmHg or below, balloon inflation can commence.</li> <li>• Deploy the valve by inflating the balloon with the entire volume in the inflation device provided by Edwards Lifesciences, hold for 3 seconds and confirm that the barrel of the inflation device is empty to ensure complete inflation of the balloon.</li> <li>• Deflate the balloon. When the balloon catheter has been completely deflated, turn off the pacemaker.</li> </ul>

### 7.3.4 System Removal

Step	Procedure
1	<p>Unflex the delivery system while retracting the device, if needed. Verify that the Flex Catheter tip is locked over the Triple Marker. Retract the loader to the proximal end of the delivery system and remove the delivery system from the sheath.</p> <p><b>NOTE: For subclavian-axillary approach, keep delivery system inside sheath until ready to remove all devices as one unit.</b></p> <p><b>CAUTION: Patient injury could occur if the delivery system is not unflexed prior to removal.</b></p>
2	Remove all devices when the ACT level is appropriate. Refer to the Edwards sheath instructions for use for device removal.
3	Close the access site.

## 8.0 How Supplied

STERILE: The valve is supplied sterilized with glutaraldehyde solution. The delivery system is supplied sterilized with ethylene oxide gas.

### 8.1 Storage

The valve must be stored at 10 °C to 25 °C (50 °F to 77 °F). Each jar is shipped in an enclosure containing a temperature indicator to detect exposure of the valve to extreme temperature.

The delivery system should be stored in a cool, dry place.

## 9.0 MR Safety



**MR Conditional**

Non-clinical testing has demonstrated that the Edwards SAPIEN 3 and SAPIEN 3 Ultra transcatheter heart valves are MR Conditional. A patient with this device can be scanned safely, immediately after placement of this device under the following conditions:

- Static magnetic field of 1.5T or 3.0T
- Maximum spatial gradient field of 2500 gauss/cm (25 T/m) or less
- Maximum MR system reported, whole body averaged specific absorption rate (SAR) of 2 W/kg (Normal Operating Mode)

Under the scan conditions defined above, the SAPIEN 3 and SAPIEN 3 Ultra transcatheter heart valves are expected to produce a maximum temperature rise of 3.0 °C after 15 minutes of continuous scanning.

In non-clinical testing, the image artifact caused by the device extends as far as 14.5 mm from the implant for spin echo

images and 30 mm for gradient echo images when scanned in a 3.0T MRI system. The artifact obscures the device lumen in gradient echo images.

The implant has not been evaluated in MR systems other than 1.5T or 3.0T.

For valve-in-valve implantation or in the presence of other implants, please refer to the MRI safety information for the surgical valve or other devices prior to MR imaging.

## **10.0 Patient Information**

Patient education brochures are provided to each site and should be given to the patient to inform them of the risks and benefits of the procedure and alternatives in adequate time before the procedure to be read and discussed with their physician. A copy of this brochure may also be obtained from Edwards Lifesciences by calling 1.800.822.9837. A patient implant card request form is provided with each transcatheter heart valve. After implantation, all requested information should be completed on this form. The serial number may be found on the package and on the identification tag attached to the transcatheter heart valve. The original form should be returned to the Edwards Lifesciences address indicated on the form and upon receipt, Edwards Lifesciences will provide an identification card to the patient.

## **11.0 Recovered Valve and Device Disposal**

The explanted valve should be placed into a suitable histological fixative such as 10% formalin or 2% glutaraldehyde and returned to the company. Refrigeration is not necessary under these circumstances. Contact Edwards Lifesciences to request an Explant Kit.

Used delivery system may be disposed of in the same manner that hospital waste and biohazardous materials are handled. There are no special risks related to the disposal of these devices.

## **12.0 Clinical Studies**

### **SUMMARY OF PRIMARY CLINICAL STUDY**

#### **The PARTNER II Trial Overview, SAPIEN 3 Valve**

SAPIEN 3 High Risk and Inoperable Cohort: The SAPIEN 3 High Risk and Inoperable Cohort of the PARTNER II trial (PIIS3HR) was a single arm, non-randomized, historical-controlled study to compare the third generation Edwards SAPIEN 3 system with the first generation Edwards SAPIEN valve system in patients who either have high risk for surgery or cannot undergo surgery (inoperable). The valve sizes used in the PIIS3HR trial included only the 23, 26 and 29 mm sizes. The 20 mm valve size was introduced into the trial after enrollment was completed with the three larger sizes, thus a separate nested registry, NR7, with identical inclusion/exclusion criteria as the PIIS3HR Cohort except for the aortic annulus diameter, was created to collect data for the 20 mm valve. Data from the PIIS3HR cohort and NR7 are pooled for the statistical analyses. For convenience, this combined cohort is referred to as "PIIS3HR" hereafter.

The database included 583 eligible patients enrolled at 29 investigational sites in the U.S.

The PIIS3HR study used an independent Data Safety Monitoring Board (DSMB) that was instructed to notify Edwards Lifesciences of any safety or compliance issues, a Clinical Events Committee (CEC) that was responsible for adjudicating endpoint related events reported during the trial per *a priori* established VARC 2 definitions<sup>[2]</sup>, an ECG core laboratory for independent analysis of rhythm, and an echocardiographic core laboratory for independently analyzing all echocardiograms.

SAPIEN 3 Intermediate Risk Cohort: The PIIS3i Cohort of the PARTNER II trial was a single arm, non-randomized, historical-controlled study to compare TAVR with the Edwards SAPIEN 3 system to the surgical aortic valve replacement (SAVR) arm from the previous PARTNER II trial Cohort A (PIIA-SAVR) in patients who were judged by a heart team to be at intermediate risk for open surgical therapy. The valve sizes used in the PIIS3i study included the 20, 23, 26, and 29 mm sizes.

Patients in PIIS3i were treated between February 2014 and September 2014. Patients in PIIA-SAVR were treated between January 2012 and November 2013. The database reflected data collected through December 10, 2015 and included 1,078 patients in PIIS3i enrolled at 51 investigational sites in the U.S. and 1,021 patients in PIIA-SAVR enrolled at 57 investigational sites in the U.S.

The PIIS3i study used an independent Data Safety Monitoring Board (DSMB) that was instructed to notify Edwards Lifesciences of any safety or compliance issues and a Clinical Events Committee (CEC) that was responsible for

adjudicating endpoint related events reported during the trial. The CEC adjudicated the events per pre-established definitions, which were primarily Valve Academic Research Consortium-1 VARC-2 definitions<sup>[2]</sup>, with the following exceptions:

- Prosthetic valve dysfunction was adjudicated per VARC-1
- Aortic valve reintervention was adjudicated per protocol definition
- Rehospitalization for symptoms of aortic stenosis and/or complications of the valve procedure were adjudicated using the protocol and VARC-2 definitions as guidelines

The events in the PIIA-SAVR cohort were adjudicated by the CEC in accordance with the pre-specified, primarily VARC-1 definitions, with the following exceptions:

- Acute Kidney Injury (AKI) was adjudicated with a modified VARC-1 definition in which the CEC applied the 72-hour staging window to any AKI event that occurred within 30-days
- Aortic valve reintervention were adjudicated per the protocol definition
- Rehospitalization for symptoms of AS and/or complications of the valve procedure were adjudicated using the protocol and VARC-1 as guidelines
- Bleeding events were adjudicated irrespective of whether there was an identifiable, overt source of bleeding

An electrocardiogram (ECG) core laboratory was used for independent analysis of rhythm, an echocardiographic core laboratory for echocardiograms, and a computerized tomography (CT) core laboratory for baseline CTs for annulus dimensions.

### **The PARTNER 3 Trial Overview, SAPIEN 3 Valve**

Patients were enrolled between March 2016 and June 2018. The database reflected data collected through December 21, 2018 and included 1000 patients. There were 71 investigational sites in the U.S, Australia, Canada, New Zealand, and Japan.

The PARTNER 3 trial was a prospective, randomized (1:1), controlled, multicenter study to compare TAVR with the Edwards SAPIEN 3 THV to SAVR. A subset of patients were enrolled in a computed tomography (CT) substudy to investigate the prevalence of Hypoattenuated Leaflet Thickening (HALT) and reduced leaflet mobility.

The PARTNER 3 trial used an independent Data Safety Monitoring Board (DSMB) that was instructed to notify the applicant of any safety or compliance issues and a Clinical Events Committee (CEC) that was responsible for adjudicating endpoint-related events reported during the trial. The CEC adjudicated the events per Valve Academic Research Consortium-2 (VARC-2) definitions<sup>[2]</sup>. A CT core laboratory was used for assessment of baseline CTs for annulus dimensions and the CT images acquired in the CT substudy.

### **Clinical Inclusion and Exclusion Criteria**

Patients in the database extract received a commercially available SAPIEN 3 transcatheter heart valve and surgical valves for symptomatic heart disease due to severe native calcific aortic stenosis who were deemed to be at low risk for surgical aortic valve replacement.

### **Clinical Endpoints**

The endpoints analyzed in this application included: death rate, adjudicated adverse events (stroke, TIA, and aortic valve reinterventions, rehospitalization), key site reported adverse events, atrial fibrillation, length of index hospitalization, valve performance based on echocardiographic data, New York Heart Association (NYHA) classification, 6-minute walk test, and the Kansas City Cardiomyopathy Questionnaire (KCCQ) score. The analyses in the application focused on the 30-day and/or one-year time points.

### **SAPIEN 3 THV IN BICUSPID AORTIC VALVE FOR PATIENTS AT INTERMEDIATE OR GREATER SURGICAL RISK – STS/ACC TRANSCATHETER VALVE THERAPY REGISTRY (TVTR) ANALYSIS**

A database extract was performed on November 15, 2017, which yielded 545 patients with bicuspid aortic valves that had been treated with an Edwards SAPIEN 3 transcatheter heart valve. The patients were treated between July 14, 2015 and August 15, 2016. The procedure was performed in 225 participating hospitals.

Adjudications were completed per the TVT Registry Coder's Data Dictionary by the Duke Clinical Research Institute (DCRI) for three adverse events: stroke, transient ischemic attack (TIA), and aortic valve reinterventions.



### Clinical Inclusion and Exclusion Criteria

Patients in the database extract received a commercially available SAPIEN 3 transcatheter heart valve for symptomatic heart disease associated with a bicuspid aortic valve. The patients were treated based on clinical judgement of their treating physicians.

### Follow-up Schedule

All patients were followed post implantation according to their local standards of care. The TVT Registry collects follow-up data at discharge, 30 days, and 1 year.

### Clinical Endpoints

Data entered into the TVT Registry were collected through standardized data collection forms. The endpoints analyzed in this application included: death rate, adjudicated adverse events (stroke, TIA, and aortic valve reinterventions), key site reported adverse events, valve performance based on echocardiographic data, New York Heart Association (NYHA) classification, 5-meter walk test, and the Kansas City Cardiomyopathy Questionnaire (KCCQ) score. The analyses in the application focused on the 30-day and one-year time points.

### **SAPIEN 3 THV IN BICUSPID AORTIC VALVE FOR PATIENTS AT LOW SURGICAL RISK – PARTNER 3 BICUSPID REGISTRY ANALYSIS**

Under the PARTNER 3 trial, a prospective, single-arm, registry was enrolled to establish a reasonable assurance of safety and effectiveness of TAVR with the Edwards SAPIEN 3 THV in patients with severe, native, calcific, aortic stenosis of a bicuspid aortic valve who are judged by a heart team to be at low risk for open surgical therapy. Patients were enrolled between October 2017 and May 2018, and data was collected through August 28, 2019 for 75 patients.

The data safety monitoring board and clinical events committee described in the PARTNER 3 trial above were also used in this registry.

### Clinical Inclusion and Exclusion Criteria

Patients in the trial received a commercially available SAPIEN 3 transcatheter heart valve for symptomatic heart disease due to severe native calcific aortic stenosis of a bicuspid aortic valve who were deemed to be at low risk for surgical aortic valve replacement.

### Follow-up Schedule

Patients were followed-up at discharge, 30 days, and 1 year, and will continue to be followed up to 10 years.

### Clinical Endpoints

The clinical endpoints were the same as those listed above in the PARTNER 3 trial.

### **SAPIEN 3 THV Valve-in-Valve – STS/ACC Transcatheter Valve Therapy Registry (TVTR) Analysis**

A database extract was performed on August 4, 2016, which yielded 314 patients that had been treated with an Edwards SAPIEN 3 transcatheter heart valve placed in a failed surgical aortic bioprosthesis (i.e., aortic valve-in-valve) and 311 patients that had been treated with an Edwards SAPIEN XT transcatheter heart valve (N = 241) or SAPIEN 3 THV (N = 70) placed in a failed surgical mitral bioprosthesis (i.e., mitral valve-in-valve). Patients who presented with an existing valve-in-valve that was failing were excluded from the database extract. The SAPIEN XT transcatheter heart valve was included in the database extract for the mitral valve-in-valve uses because there were fewer SAPIEN 3 transcatheter heart valve cases in the registry due to its relatively shorter commercial use history and the SAPIEN XT THV data were considered to be generally applicable to the SAPIEN 3 transcatheter heart valve due to their similarities in design. The aortic valve-in-valve patients were treated between July 23rd, 2015 and June 29th, 2016 at 130 participating hospitals; the mitral valve-in-valve patients were treated at 112 participating hospitals between July 10th, 2014 and June 27th, 2016 for the SAPIEN XT transcatheter heart valve and between June 23rd, 2015 and June 15th, 2016 for the SAPIEN 3 transcatheter heart valve.

Adjudications were completed per the TVT Registry Coder's Data Dictionary by the Duke Clinical Research Institute (DCRI) for three adverse events: readmission for heart failure, stroke/transient ischemic attack (TIA), and aortic and mitral valve reinterventions.

### Clinical Inclusion and Exclusion Criteria

Patients in the database extract received a commercially available SAPIEN 3 transcatheter heart valve (for both aortic and mitral valve-in-valve) or SAPIEN XT transcatheter heart valve (for mitral valve-in-valve only) for symptomatic heart disease associated with a failed (stenosed, insufficient, or combined) surgical bioprosthetic aortic or mitral valve. They were deemed to be at high or greater risk for open surgical therapy and were treated off-label based on the clinical judgement of their treating physicians.

### Follow-up Schedule

All patients were followed post implantation according to their local standards of care. The TVT Registry collects follow-up data at discharge, 30 days, and 1 year.

### Clinical Endpoints

Data entered into the TVT Registry were collected through standardized data collection forms. The endpoints analyzed in this application included: death rate, adjudicated adverse events (readmission for heart failure, stroke/TIA, and valve reinterventions), key site reported adverse events, valve performance based on echocardiographic data, New York Heart Association (NYHA) classification, 6-minute or 5-meter walk test, and the Kansas City Cardiomyopathy Questionnaire (KCCQ) score. The analyses in the application focused on the discharge and 30-day time points.

### **SAPIEN 3 and SAPIEN 3 Ultra THV THV-in-THV – STS/ACC Transcatheter Valve Therapy Registry (TVTR) Analysis**

A database extract was performed on August 9, 2019. Patients were excluded if their previous transcatheter aortic valve replacement (TAVR) procedure was performed prior to April 23, 2007 (first implant in the US under the PARTNER trial). The database extract yielded 404 patients that had undergone a THV-in-THV procedure with an Edwards SAPIEN 3 (N=402) or Edwards SAPIEN 3 Ultra (N=2). These patients were treated between August 4, 2015 and July 11, 2019 at 188 participating hospitals.

To obtain more complete 1-year follow-up data, a treatment cutoff date of June 9, 2018 was then applied to the data set obtained above, which yielded 263 patients (SAPIEN 3 THV only) treated at 138 participating hospitals. The cutoff date was 14 months before the database extract date, which included a +60-day window for the 1-year visit. These 263 patients constituted the clinical data set used to support this application.

### Clinical Inclusion and Exclusion Criteria

The initial database extract included all patients who received a commercially available Edwards SAPIEN 3 or Edwards SAPIEN 3 Ultra THV in an aortic THV-in-THV procedure. The final data set was a subset of the initial database extract as described above.

### Follow-up Schedule

All patients were followed post-implantation according to their local standards of care. The TVT Registry collects follow-up data at 30 days and 1 year.

### Clinical Endpoints

Data entered into the TVT Registry were collected through standardized data collection forms. The endpoints analyzed in this application included: death, stroke/transient ischemic attack (TIA), valve reinterventions, key site reported adverse events, valve performance based on echocardiographic data, New York Heart Association (NYHA) classification, and the Kansas City Cardiomyopathy Questionnaire (KCCQ) score. The analyses in the application focused on 30-day and 1-year time points.

### **SAPIEN 3 Ultra Confirmatory Study Overview**

A prospective, single-arm, multicenter clinical study was conducted to confirm the procedural safety and effectiveness of the SAPIEN 3 Ultra system in patients with severe, calcific aortic stenosis (AS) who are at intermediate operative risk for surgical aortic valve replacement (SAVR).

The study enrolled 40 patients in Canada and United Kingdom.

It utilized an echocardiographic core laboratory for echocardiograms.

### Follow-up Schedule

All patients were followed post implantation at discharge and 30 days, and will continue to be followed at 6 months, 1 year and annually thereafter for a minimum of 5 years.

#### Clinical Endpoints

The endpoints analyzed were procedure success (defined as freedom from mortality, conversion to surgery and moderate or severe paravalvular regurgitation at exit from the procedure room), key site reported adverse events, valve performance, and New York Heart Association (NYHA) classification.

### **PARTNER II SAPIEN 3 HIGH-RISK/INOPERABLE COHORT**

#### **Patient Accountability**

All 583 eligible patients were successfully implanted with a SAPIEN 3 valve, which constitutes the Valve Implant (VI) population. Among the VI population, 491 patients were implanted via the transfemoral (TF) access route, and 92 patients via the transapical (TA) or transaortic (TAo) access route.

**Table 6:  
Patient Accountability**

	<b>SAPIEN 3 Valve Overall</b>	<b>SAPIEN 3 Valve Transfemoral Access</b>	<b>SAPIEN 3 Valve Non-Transfemoral Access</b>
<b>Eligible Patient Population (EPP)</b>	583	491	92
<b>Valve Implant (VI) Population</b>	583	491	92

Eligible Patient Population (EPP) consists of all enrolled patients who received treatment assignment from the database and entered into the catheterization laboratory/hybrid suite and who remained eligible to receive the implant.

Valve Implant (VI) Population consists of all enrolled patients who received a SAPIEN 3 valve, and retained the valve upon leaving the catheterization laboratory/hybrid suite.

#### **Study Population Demographics and Baseline Parameters**

The demographics of the study population are summarized in Table 7, which are typical of a TAVR study performed in the U.S.

**Table 7:  
Patient Demographics and Baseline Characteristics –  
PIIS3HR VI Population**

<b>Characteristic</b>	<b>SAPIEN 3 Valve Overall (N = 583)</b>	<b>SAPIEN 3 Valve Transfemoral Access (N = 491)</b>	<b>SAPIEN 3 Valve Non-Transfemoral Access (N = 92)</b>
Age, yr	82.6 ± 8.1	82.8 ± 8.2	81.7 ± 7.5
Male sex, no. (%)	338 (58.0%)	277 (56.4%)	61 (66.3%)
STS score	8.6 ± 3.7	8.4 ± 3.5	10.0 ± 4.3
New York Heart Association (NYHA) class, no. (%):			
I/II	58 (9.9%)	51 (10.4%)	7 (7.6%)
III/IV	525 (90.1%)	440 (89.6%)	85 (92.4%)
Coronary artery disease, no. (%)	444 (76.2%)	360 (73.3%)	84 (91.3%)
Previous myocardial infarction, no. (%)	117 (20.1%)	87 (17.7%)	30 (32.6%)
Previous intervention, no. (%)			
Coronary-artery bypass grafting (CABG)	193 (33.1%)	145 (29.5%)	48 (52.2%)

Characteristic	SAPIEN 3 Valve Overall (N = 583)	SAPIEN 3 Valve Transfemoral Access (N = 491)	SAPIEN 3 Valve Non-Transfemoral Access (N = 92)
Percutaneous coronary intervention (PCI)	199 (34.1%)	163 (33.2%)	36 (39.1%)
Prior aortic valvuloplasty	62 (10.6%)	49 (10.0%)	13 (14.1%)
Cerebral vascular accident (CVA), no. (%)	64 (11.0%)	53 (10.8%)	11 (12.0%)
Peripheral vascular disease, no. (%)	205 (35.2%)	155 (31.6%)	50 (54.3%)
Chronic obstructive pulmonary disease (COPD), no. (%):			
Any	259 (44.6%)	216 (44.1%)	43 (47.3%)
Oxygen-dependent	68 (11.8%)	58 (11.9%)	10 (11.0%)
Atrial fibrillation, no. (%)	255 (43.7%)	212 (43.2%)	43 (46.7%)
Permanent pacemaker, no. (%)	95 (16.3%)	78 (15.9%)	17 (18.5%)
Severe pulmonary hypertension, no. (%)	30 (5.1%)	24 (4.9%)	6 (6.5%)
Frailty, no. (%)	180 (30.9%)	162 (33.0%)	18 (19.6%)
Chest deformities that preclude an open chest procedure, no. (%)	4 (0.7%)	3 (0.6%)	1 (1.1%)
Cirrhosis, no. (%)	11 (1.9%)	9 (1.8%)	2 (2.2%)
Echocardiographic findings			
Effective Orifice Area (EOA), cm <sup>2</sup>	0.7 ± 0.2	0.7 ± 0.2	0.7 ± 0.1
Mean aortic-valve gradient, mmHg	45.5 ± 14.3	45.7 ± 14.4	44.0 ± 13.2
Mean left ventricular ejection fraction (LVEF), %	56.4 ± 14.8	57.0 ± 14.5	53.2 ± 15.9
Moderate or severe mitral regurgitation, no./total no. (%)	69/541 (12.8%)	63/461 (13.7%)	6/80 (7.5%)

## Safety and Effectiveness Results

### Primary Endpoint

The composite rate of all-cause mortality, all stroke, and AI ≥ moderate at 30 days was 6.7% in the SAPIEN 3 cohort and 15.6% in the SAPIEN cohort, as shown in Table 8. The resulting proportion difference in the average treatment effect on the treated (ATT; <sup>[3]</sup>) was -6.9% (90% CI: [-13.3%, -0.5%]). Since the upper limit of the CI was < 7.5%, the non-inferiority was met.

**Table 8:**  
**Primary Endpoint Analysis –**  
**Non-Inferiority Test SAPIEN 3 Valve (PIIS3HR VI Population) vs. SAPIEN Valve**

Event at 30 days	SAPIEN 3 Valve (N = 583)	SAPIEN Valve (N = 326)	Weighted Proportion Difference in Average Treatment Effect on the Treated (ATT)
Composite of Death, Stroke and AI ≥ Moderate	6.7% [5.1%, 8.6%] <sup>1</sup>	15.6% [12.6%, 19.5%] <sup>1</sup>	-6.9% [-13.3%, -0.5%] <sup>2</sup>

<sup>1</sup> For each individual study, the two-sided 90% stratified Wilson confidence interval was provided.

<sup>2</sup> The Wald-type two-sided 90% confidence interval using weighted mean and SD is provided.

The Kaplan-Meier (K-M) estimates for all-cause mortality, cardiac mortality, and all stroke at 30 days for the SAPIEN 3 cohort and the SAPIEN cohort are provided in Table 9.

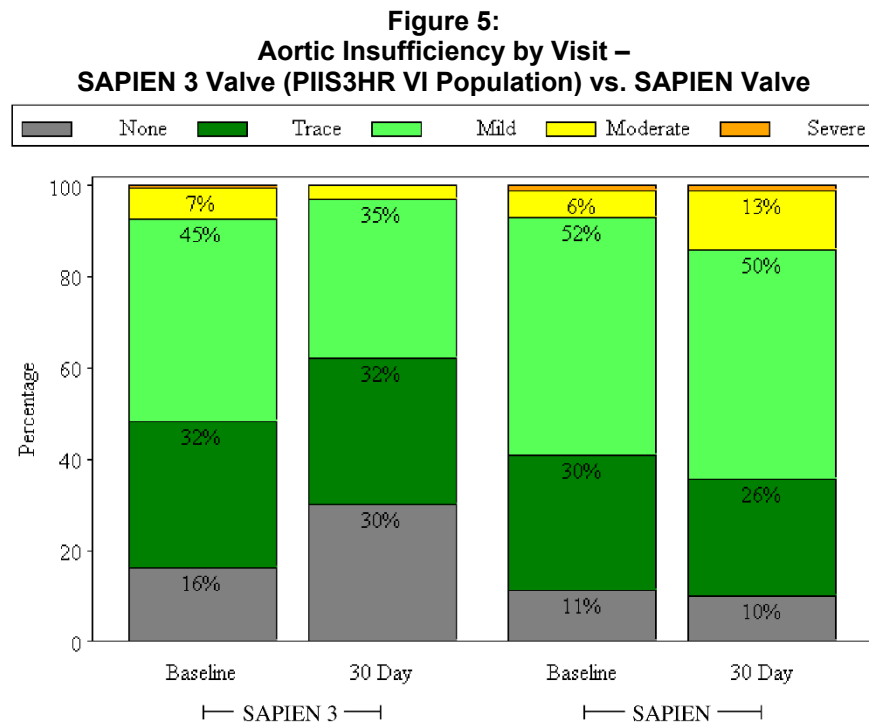
**Table 9:  
Death and Stroke at 30 Days –  
SAPIEN 3 Valve vs. SAPIEN Valve (VI Population)**

Event at 30 Days	SAPIEN 3 Valve (N = 583)			SAPIEN Valve (N = 326)		
	No. Events	No. Pts with Events	K-M Estimated Event Rate <sup>1</sup> (95% CI)	No. Events	No. Pts with Events	K-M Estimated Event Rate (95% CI)
Death	13	13	2.2% ([1.3%, 3.8%])	15	15	4.6% ([2.8%, 7.5%])
Cardiac Death	8	8	1.4% ([0.7%, 2.7%])	10	10	3.1% ([1.7%, 5.7%])
All Stroke	9	9	1.6% ([0.8%, 3.0%])	14	14	4.3% ([2.6%, 7.2%])

<sup>1</sup>Kaplan-Meier (K-M) estimates at 30 days used time to first event for each patient. Events occurring after 30 days were not included in this analysis.

Secondary Endpoints

Aortic insufficiency by visit is provided in Figure 5.



The proportion of patients with AI  $\geq$  moderate at 30 days was 3.0% in the SAPIEN 3 cohort and 14.3% in the SAPIEN cohort, which were found to be statistically significantly different ( $p=0.0051$ ; Table 10).

**Table 10:  
Aortic Insufficiency at 30 Days  
(SAPIEN 3 Valve vs. SAPIEN Valve VI Population)**

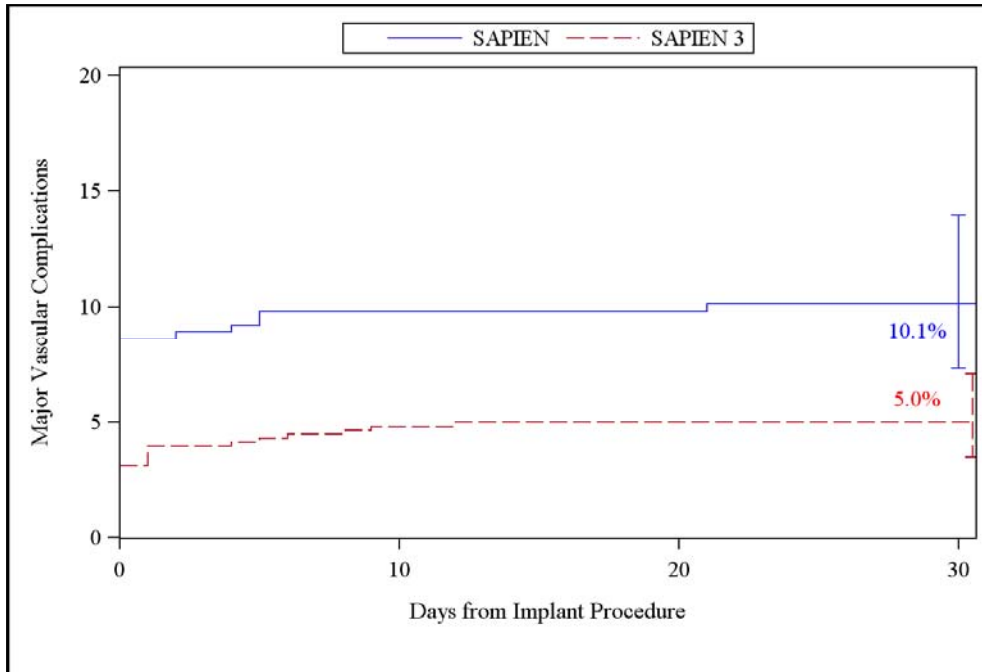
Event at 30 Days	SAPIEN 3 Valve (N = 583)	SAPIEN Valve (N = 326)	Weighted Proportion Difference in Average Treatment Effect on the Treated (ATT)	P-value
AI $\geq$ Moderate, n/Total no. (%) [95% CI]	16/532 (3.0%) [1.7%, 4.8%] <sup>1</sup>	40/280 (14.3%) [10.4%, 18.9%] <sup>1</sup>	-13.1% [-22.2%, -3.9%] <sup>2</sup>	0.0051

<sup>1</sup> 95% Clopper-Pearson Exact confidence interval.

<sup>2</sup> The Wald-type two-sided 90% confidence interval using weighted mean and SD is provided

The rate of major vascular complications at 30 days post implantation is shown in Figure 6. The rate was 5.0% for the SAPIEN 3 cohort and 10.1% for the SAPIEN cohort, which were found to be not statistically significantly different ( $p=0.0578$ ; Table 11).

**Figure 6:  
Major Vascular Complications at 30 Days –  
SAPIEN 3 Valve vs. SAPIEN Valve (VI Population)**



**Table 11:  
Major Vascular Complications at 30 Days –  
SAPIEN 3 Valve vs. SAPIEN Valve (VI Population)**

Event at 30 Day	SAPIEN 3 Valve (N = 583)	SAPIEN Valve (N = 326)	Weighted Proportion Difference in Average Treatment Effect on the Treated (ATT)	P-value
Major Vascular Complications, n/Total no. (%) [95% CI]	29/583 (5.0%) [3.4%, 7.1%]	33/326 (10.1%) [7.1%, 13.9%] <sup>1</sup>	-8.0% [-16.2%, 0.3%] <sup>2</sup>	0.0578

<sup>1</sup> 95% Clopper-Pearson Exact confidence interval.

<sup>2</sup> The Wald-type two-sided 90% confidence interval using weighted mean and SD is provided.

Table 12 lists the hypothesis testing of the two secondary endpoints conducted with p-values in descending order for the Hochberg multiplicity adjustment steps. The largest p-value (p=0.0578 from major vascular complications) was greater than 0.05. As such, the null hypothesis was not rejected for the testing of major vascular complications at 30 days. The subsequent testing of AI ≥ moderate at 30 days had a p-value of 0.0051, which was less than 0.025. As such, the null hypothesis was rejected for AI ≥ moderate at 30 days, indicating that the SAPIEN 3 cohort was superior over the SAPIEN cohort in regards to AI ≥ moderate at 30 days.

**Table 12:  
Secondary Endpoints for Labeling –  
SAPIEN 3 Valve vs. SAPIEN Valve (VI Population)**

<b>Endpoints</b>	<b>Original p-value</b>	<b>Inference</b>
Major Vascular Complications at 30 Days	0.0578	> 0.05; reject the alternative hypothesis. Proceed to the rest of testing
AI at 30 Days	0.0051	< 0.025; claim superiority

Adverse Events

The key CEC adjudicated adverse events at 30 days are presented in Table 13.

**Table 13:  
CEC Adjudicated Adverse Events at 30 Days  
(PIIS3HR VI Population)**

<b>30 Day Adverse Events</b>	<b>SAPIEN 3 Valve Overall</b>	<b>SAPIEN 3 Valve Transfemoral Access TF</b>	<b>SAPIEN 3 Valve Non-Transfemoral Access</b>
Composite Event Rate of Death, All Stroke and AI ≥ Moderate, n/N (%)	37/545 (6.8%)	27/463 (5.8%)	10/82 (12.2%)
Death			
From any cause, n/N (%)	13/583 (2.2%)	8/491 (1.6%)	5/92 (5.4%)
From cardiovascular cause, n/N (%)	8/583 (1.4%)	5/491 (1.0%)	3/92 (3.3%)
Stroke, n/N (%)	9/583 (1.5%)	8/491 (1.6%)	1/92 (1.1%)
AI ≥ moderate, n/N (%)	16/532 (3.0%)	12/455 (2.6%)	4/77 (5.2%)
Myocardial Infarction, n/N (%)	3/583 (0.5%)	2/491 (0.4%)	1/92 (1.1%)
Major Vascular Complications, n/N (%)	29/583 (5.0%)	26/491 (5.3%)	3/92 (3.3%)
Acute Kidney Injury, Stage III, n/N (%)	6/583 (1.0%)	4/491 (0.8%)	2/92 (2.2%)
Disabling Bleeding Event, n/N (%)	37/583 (6.3%)	27/491 (5.5%)	10/92 (10.9%)
Aortic Valve Re-Intervention, n/N (%)	6/583 (1.0%)	4/491 (0.8%)	2/92 (2.2%)
Endocarditis, n/N (%)	1/583 (0.2%)	1/491 (0.2%)	0/92 (0.0%)
Conduction Disturbance Requiring Permanent Pacemaker, n/N (%)	76/583 (13.0%)	65/491 (13.2%)	11/92 (12.0%)

Other Results

Procedural Information

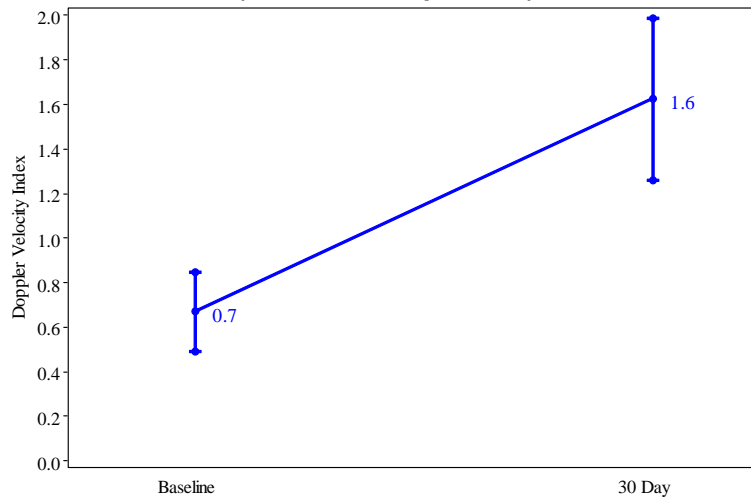
Overall, the mean duration in the catheterization laboratory/hybrid suite was 192.8 ± 59.3 min, the mean total procedure time was 86.3 ± 44.2 min, and the mean total anesthesia time was 193.7 ± 62.9 min. These duration times were slightly shorter in the TF patients. General anesthesia was used in the vast majority of cases; 15.9% of the TF patients had conscious sedation. Correct positioning of the valve was achieved in 99.1% of the patients. Five patients (0.9%; including 3 TF patients) were implanted with a second valve. One patient (0.2%) experienced valve embolization following rupture of the delivery balloon on annular calcium. This patient was converted to surgical aortic valve replacement and later died from aortic dissection.



Valve Performance

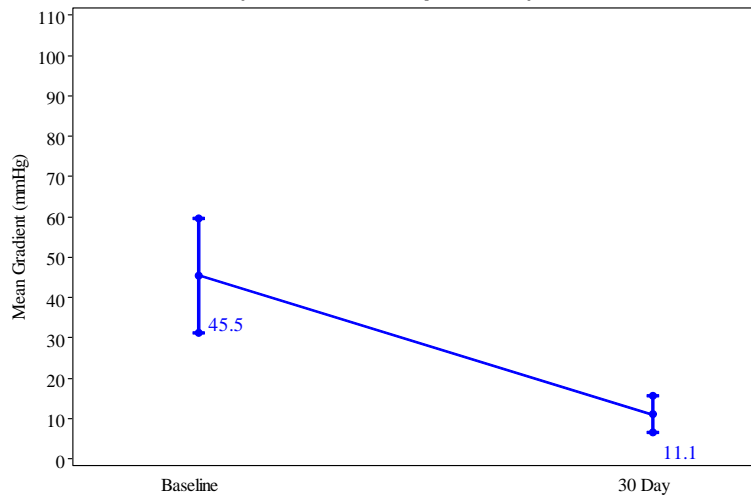
The mean EOA increased from  $0.7 \pm 0.2 \text{ cm}^2$  at baseline to  $1.6 \pm 0.4 \text{ cm}^2$  at 30 days, as shown in Figure 7.

**Figure 7:  
Effective Orifice Area  
(PIIS3HR VI Population)**



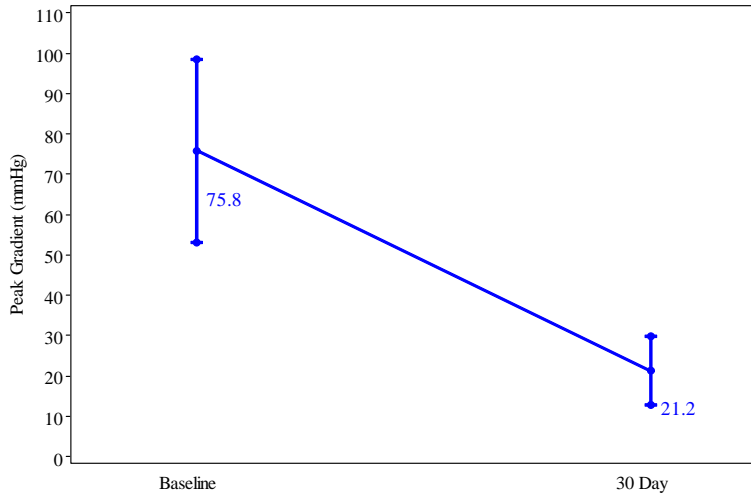
The average mean gradient decreased from  $45.5 \pm 14.3 \text{ mmHg}$  at baseline to  $11.1 \pm 4.5 \text{ mmHg}$  at 30 days, as shown in Figure 8.

**Figure 8:  
Mean Gradient  
(PIIS3HR VI Population)**



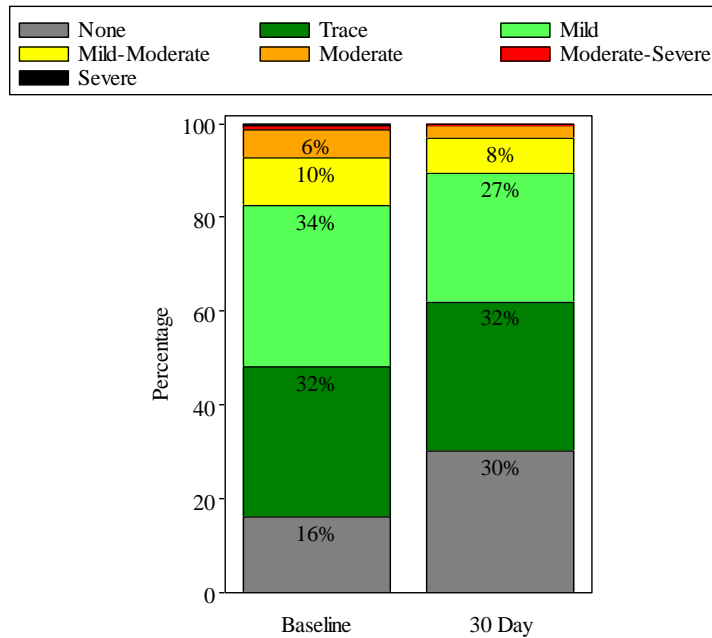
The mean peak gradient decreased from  $75.8 \pm 22.6$  mmHg at baseline to  $21.2 \pm 8.5$  mmHg at 30 days, as shown in Figure 9.

**Figure 9:  
Peak Gradient  
(PIIS3HR VI Population)**



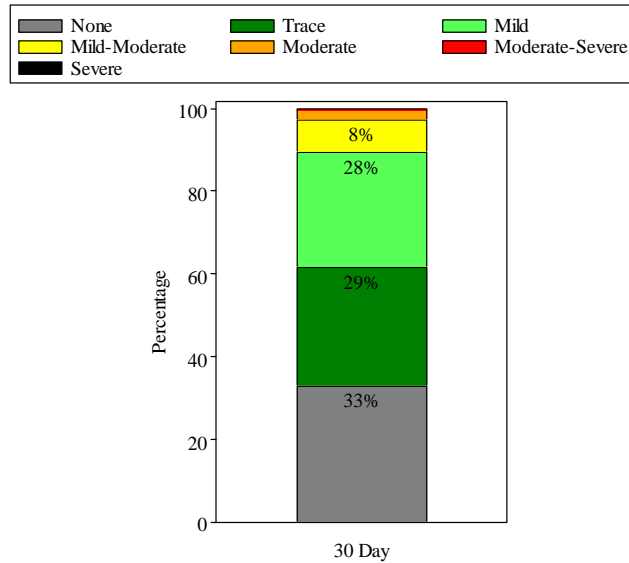
The proportion of patients with AI  $\geq$  moderate was 7.3% at baseline and 3.0% at 30 days, as shown in Figure 10.

**Figure 10:  
Aortic Insufficiency  
(PIIS3HR VI Population)**



The proportion of patients with aortic paravalvular leak (PVL)  $\geq$  moderate was 2.9% at 30 days, as shown in Figure 11.

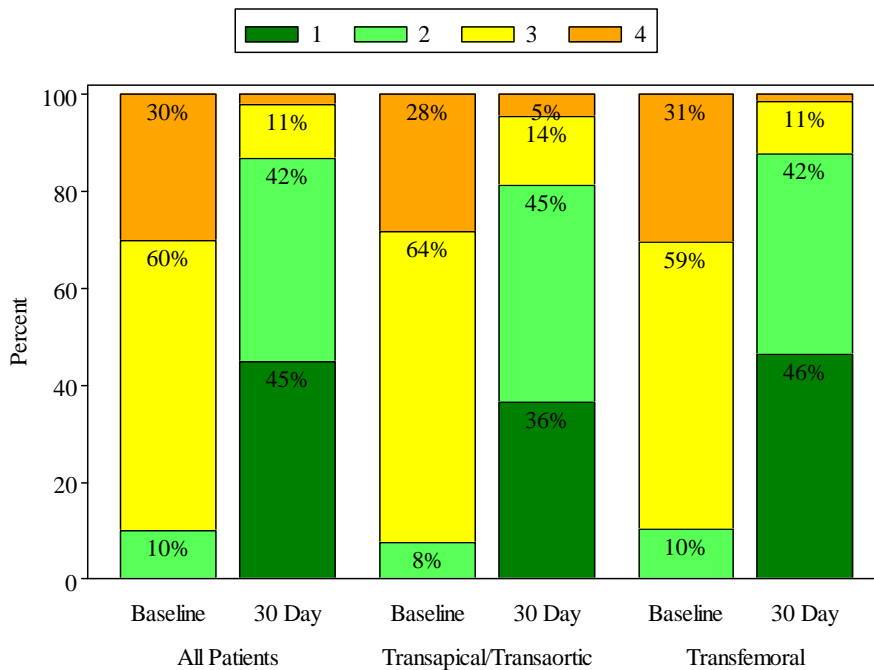
**Figure 11:  
Aortic Paravalvular Leak  
(PIIS3HR VI Population)**



**NYHA**

The NYHA class by visit is shown in Figure 12. For all patients, the mean NYHA class was  $3.2 \pm 0.6$  at baseline and  $1.7 \pm 0.7$  at 30 days.

**Figure 12:  
NYHA Class by Visit  
(PIIS3HR VI Population)**



### **Six Minute Walk Test (6MWT)**

The improvement in mean 6MWT distance was  $38.5 \pm 110.2$  meters from baseline to 30 days for all patients,  $42.6 \pm 107.8$  meters for all TF patients, and  $15.9 \pm 121.2$  meters for all TA/TAo patients.

### **Length of Stay (LoS)**

The overall mean LoS was  $6.8 \pm 4.8$  days, which included  $3.0 \pm 2.7$  days in the ICU. The mean LoS was  $6.1 \pm 4.3$  days (including  $2.7 \pm 2.3$  days in the ICU) for the TF patients and  $10.4 \pm 5.4$  days (including  $4.8 \pm 3.9$  days in the ICU) for the TA/TAo patients.

### **Quality of Life (QoL)**

QoL was measured using the visual analog scale (VAS) of the EuroQoL (EQ-5D) measure. The VAS is a self-assessment in which patients rate their well-being on a scale from 0 to 100 where 0 is the worst state they can imagine and 100 is the best state. During the trial, the mean improvement in VAS scale from baseline to 30 days was  $14.6 \pm 22.2$  for all patients,  $15.1 \pm 21.5$  for the TF patients, and  $11.5 \pm 25.7$  for the TA/TAo patients.

### **Additional QoL instruments**

The mean overall Kansas City Cardiomyopathy Questionnaire (KCCQ) summary score was  $46.9 \pm 22.6$  at baseline, and  $67.5 \pm 22.6$  at 30 days for the entire VI population. Except for self-efficacy which showed a small improvement, moderate to large improvements were observed in all other subscores at 30 days. In general, improvements in the TF patients were slightly larger compared to those observed in the TA/TAo patients.

Using the SF-36 norm based questionnaire, the physical component score for all patients improved from  $32.0 \pm 8.9$  at baseline to  $37.1 \pm 9.7$  at 30 days, and the mental component score improved from  $46.9 \pm 12.8$  at baseline to  $50.0 \pm 12.5$  at 30 days. In the TF patients, the physical component score improved from  $31.8 \pm 8.7$  at baseline to  $37.3 \pm 9.8$  at 30 days, and the mental component score improved from  $46.8 \pm 13.1$  at baseline to  $50.5 \pm 12.2$  at 30 days. In the TA/TAo patients, the physical component score improved from  $32.9 \pm 10.0$  at baseline to  $35.9 \pm 9.4$  at 30 days, and the mental component scores were  $47.2 \pm 11.1$  at baseline and  $47.2 \pm 14.0$  at 30 days.

## **SUMMARY OF SUPPLEMENTAL CLINICAL INFORMATION**

### **Supplemental Clinical Study Design**

Supplemental clinical data came from a study (referred to as "S3OUS" hereafter) conducted in Europe and Canada.

The S3OUS study was a non-randomized, prospective, multi-center study in inoperable, high surgical risk, and intermediate surgical risk patients who underwent implantation of the 23, 26, or 29 mm SAPIEN 3 valve.

Except the intermediate surgical risk patients, the inclusion/exclusion criteria of the S3OUS trial were largely similar to those of the PIIIS3HR trial. The S3OUS study had a minimum age requirement ( $\geq 75$  years) and the upper limit for AVA was higher ( $< 1 \text{ cm}^2$  instead of  $\leq 0.80 \text{ cm}^2$ ). Additionally, the S3OUS study included BAV within 30 days of the procedure (unless BAV was a bridge to procedure), patients with planned concomitant surgical or transcatheter ablation for atrial fibrillation, hemodynamic or respiratory instability requiring inotropic support, mechanical ventilation or mechanical heart assistance within 30 days of screening; and the need for emergency surgery for any reason. Furthermore, the exclusion criteria in the S3OUS study excluded senile dementia and any neurologic disease which severely affected the ability to walk or perform everyday activities, and shortened the time interval regarding confirmed stroke or TIA (within 3 months instead of 6 month of the procedure). The follow-up periods were discharge or 7 days, whichever comes first, 30 days, 1 year, and annually thereafter to a minimum of 5 years post procedure.

## **Patient Accountability**

Patients were treated at 14 investigational sites. Note that the intermediate risk patients enrolled in the S3OUS study were excluded from the analysis presented herein. The database included 102

“all treated” (AT) inoperable and high surgical risk patients. “All treated” population is defined to include all patients who were enrolled in the trial and for whom the study valve implantation procedures were started (i.e., the anesthesia was started).

One patient was excluded from the VI population. This patient experienced an aortic root rupture caused by displacement of a large lump of calcium with sharp edges through the native aortic annulus following balloon expansion of the SAPIEN 3 valve. The patient was subsequently converted to SAVR. After the patient was weaned off cardio-pulmonary bypass, bleeding in the region of the dorsal root occurred, and the patient died on the operating table.

A total of 56 patients were successfully implanted with a SAPIEN 3 valve via the transfemoral access route, and 45 via the transapical/transaortic access route, as shown in Table 14.

**Table 14:  
Patient Accountability (S3OUS)**

<b>SAPIEN 3 Valve Overall</b>		<b>SAPIEN 3 Valve Transfemoral Access</b>		<b>SAPIEN 3 Valve Non-Transfemoral Access</b>	
<b>All Treated (AT) Population</b>	<b>Valve Implant (VI) Population</b>	<b>All Treated (AT) Population</b>	<b>Valve Implant (VI) Population</b>	<b>All Treated (AT) Population</b>	<b>Valve Implant (VI) Population</b>
102	101	57	56	45	45

All Treated (AT) Population consists of all patients who were enrolled in the trial and for whom the study valve implantation procedures were started (i.e., anesthesia was started).

Valve Implant (VI) Population consists of all enrolled patients who received a SAPIEN 3 valve, and retained the valve upon leaving the catheterization laboratory/hybrid suite.

## **Study Population Demographics and Baseline Parameters**

The demographics of the S3OUS study population are shown in Table 15.

**Table 15:  
Patient Demographics and Baseline Characteristics  
(S3OUS AT Population)**

<b>Demographics and Baseline Characteristics</b>	<b>SAPIEN 3 Valve Overall (N = 102)</b>	<b>SAPIEN 3 Valve Transfemoral Access (N = 57)</b>	<b>SAPIEN 3 Valve Non-Transfemoral Access (N = 45)</b>
Age, yr	84.1 ± 5.0	85.1 ± 4.6	83.0 ± 5.3
Male sex, no.(%)	40 (39.2%)	23 (40.4%)	17 (37.8%)
STS score	8.0 ± 4.7	8.2 ± 4.2	7.9 ± 5.2
Logistic EuroSCORE	24.1 ± 13.0	22.3 ± 11.3	26.4 ± 14.7
New York Heart Association (NYHA) class, no.(%):			
I/II	11 (10.8%)	6 (10.5%)	5 (11.1%)
III/IV	91 (89.2%)	51 (89.5%)	40 (88.9%)
Coronary artery disease, no.(%)	68 (66.7%)	36 (63.2%)	32 (71.1%)
Previous myocardial infarction, no.(%)	20 (19.6%)	7 (12.3%)	13 (28.9%)
Previous intervention, no.(%)			
Coronary-artery bypass grafting (CABG)	24 (23.5%)	10 (17.5%)	14 (31.1%)
Percutaneous coronary intervention (PCI)	34 (33.3%)	16 (28.1%)	18 (40.0%)
Prior aortic valvuloplasty	10 (9.8%)	8 (14.0%)	2 (4.4%)
Stroke, no.(%)	7 (6.9%)	4 (7.0%)	3 (6.7%)
Peripheral vascular disease, no.(%)	27 (26.5%)	10 (17.5%)	17 (37.8%)
Chronic obstructive pulmonary disease (COPD), no.(%):			
Any	25 (24.5%)	13 (22.8%)	12 (26.7%)
Oxygen-dependent	1 (1.0%)	1 (1.8%)	0 (0%)
Atrial fibrillation, no.(%)	48 (47.1%)	22 (38.6%)	26 (57.8%)
Permanent pacemaker, no.(%)	15 (14.7%)	7 (12.3%)	8 (17.8%)
Severe pulmonary hypertension, no.(%)	10 (9.8%)	6 (10.5%)	4 (8.9%)
Severe liver disease / Cirrhosis, no.(%)	1 (1.0%)	1 (1.8%)	0 (0%)
Echocardiographic findings			
Effective Orifice Area (EOA), cm <sup>2</sup>	0.6 ± 0.2	0.6 ± 0.2	0.6 ± 0.1
Mean aortic-valve gradient, mmHg	44.8 ± 15.3	45.2 ± 14.7	44.2 ± 16.1
Mean left ventricular ejection fraction (LVEF), %	56.7 ± 9.1	57.7 ± 9.3	55.3 ± 8.7
Moderate or severe mitral regurgitation, no./total no. (%)	23/85 (27.1%)	9/48 (18.8%)	14/37 (37.8%)
Plus-minus values are means ± SD.			

## Safety and Effectiveness Results

### Key Adverse Events

Key adverse events as adjudicated by the CEC are presented in Table 16.

**Table 16:  
CEC Adjudicated Adverse Events at 1 Year  
(S3OUS AT Population)**

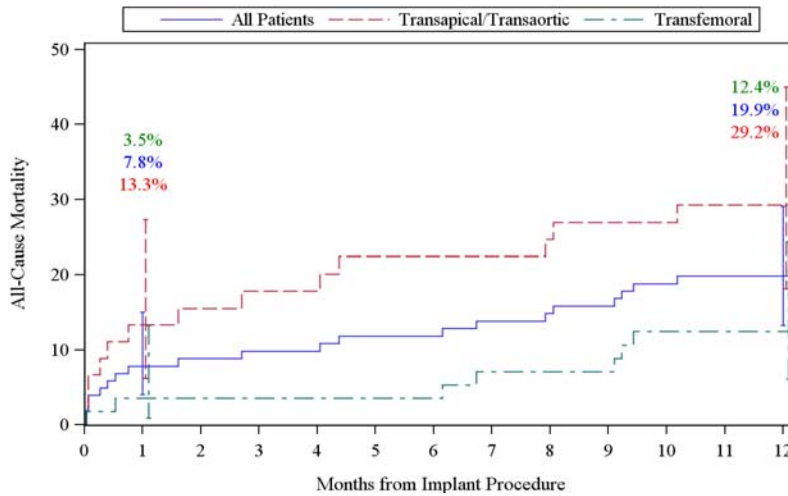
Outcomes	30 Day			1 Year		
	SAPIEN 3 Valve Overall	SAPIEN 3 Valve Transfemoral Access	SAPIEN 3 Valve Non-Transfemoral Access	SAPIEN 3 Valve Overall	SAPIEN 3 Valve Transfemoral Access	SAPIEN 3 Valve Non-Transfemoral Access
Composite Event Rate of Death, All Stroke and AI ≥ Moderate, n/N (%)	13/88 (14.8%)	3/50 (6.0%)	10/38 (26.3%)	25/82 (30.5%)	9/47 (19.1%)	16/35 (45.7%)
Death						
From any death, n/N (%)	8/102 (7.8%)	2/57 (3.5%)	6/45 (13.3%)	20/102 (19.6%)	7/57 (12.3%)	13/45 (28.9%)
From cardiovascular cause, n/N (%)	7/102 (6.9%)	2/57 (3.5%)	5/45 (11.1%)	9/102 (8.8%)	2/57 (3.5%)	7/45 (15.6%)
Stroke, n/N (%)	3/102 (2.9%)	1/57 (1.8%)	2/45 (4.4%)	5/102 (4.9%)	2/57 (3.5%)	3/45 (6.7%)
Aortic Insufficiency (AI) ≥ Moderate, n/N (%)	3/81 (3.7%)	1/49 (2.0%)	2/32 (6.3%)	1/62 (1.6%)	1/40 (2.5%)	0/22 (0.0%)
Disabling Stroke, n/N (%)	0/102 (0.0%)	0/57 (0.0%)	0/45 (0.0%)	1/102 (1.0%)	1/57 (1.8%)	0/45 (0.0%)
Myocardial Infarction, n/N (%)	2/102 (2.0%)	2/57 (3.5%)	0/45 (0.0%)	3/102 (2.9%)	2/57 (3.5%)	1/45 (2.2%)
Major Vascular Complications, n/N (%)	5/102 (4.9%)	1/57 (1.8%)	4/45 (8.9%)	N/A	N/A	N/A
Acute Kidney Injury - Stage III, n/N (%)	0/102 (0.0%)	0/57 (0.0%)	0/45 (0.0%)	N/A	N/A	N/A
Disabling Bleeding Event, n/N (%)	6/102 (5.9%)	3/57 (5.3%)	3/45 (6.7%)	N/A	N/A	N/A
Valve Dysfunction Requiring Intervention, n/N (%)	0/102 (0.0%)	0/57 (0.0%)	0/45 (0.0%)	N/A	N/A	N/A
Prosthetic Valve Endocarditis, n/N (%)	0/102 (0.0%)	0/57 (0.0%)	0/45 (0.0%)	1/102 (1.0%)	0/57 (0.0%)	1/45 (2.2%)
Conduction Abnormality Requiring Pacemaker, n/N (%)	14/102 (13.7%)	7/57 (12.3%)	7/45 (15.6%)	14/102 (13.7%)	7/57 (12.3%)	7/45 (15.6%)

The composite adverse event rate involving all-cause mortality, all stroke, and AI ≥ moderate at 30 days for all patients is higher in the S3OUS cohort than PIIS3HR cohort (14.8% vs. 6.8%). This disparity is due to the composition of the study populations, specifically the S3OUS cohort comprises 44.1% TA/TAo patients vs. 15.8% TA/TAo patients in the PIIS3HR

cohort. Note, the composite adverse event rate at 30 days for TF patients was similar, specifically, 6.0% in the S3OUS cohort and 5.8% in the PIIS3HR cohort.

The K-M estimates for all-cause mortality for all patients, the TF patients, and the TA/TAo patients are shown in Figure 13.

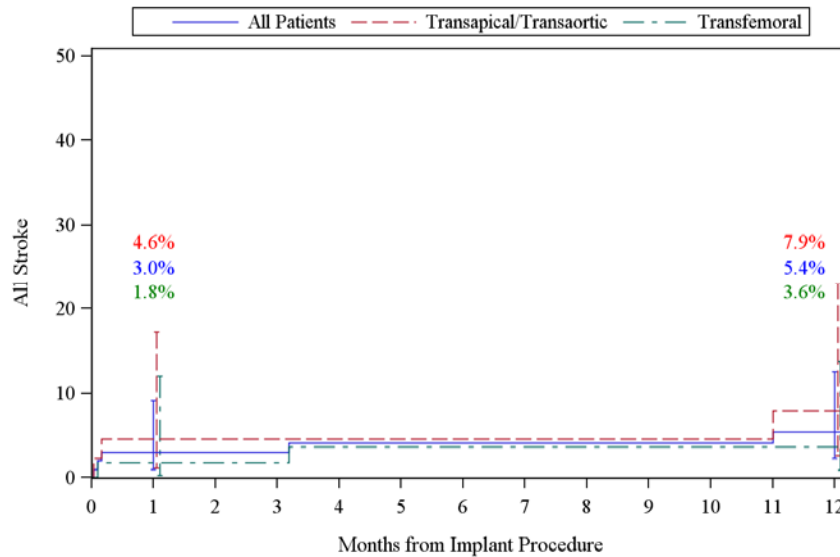
**Figure 13:  
All-Cause Mortality at 1 Year  
(S3OUS AT Population)**



**Note:** The confidence intervals are calculated without multiplicity adjustment. The adjusted confidence intervals could be wider than presented here. As such, confidence intervals are provided to illustrate the variability only and should not be used to draw any statistical conclusion.

The K-M estimates for the stroke rate for all patients, the TF patients, and the TA/TAo patients are shown in Figure 14.

**Figure 14:  
All Stroke at 1 Year  
(S3OUS AT Population)**



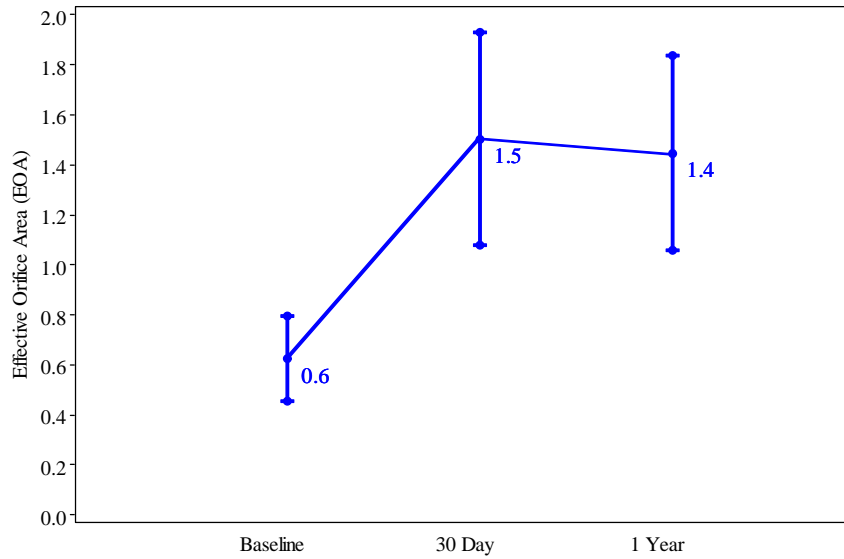
**Note:** The confidence intervals are calculated without multiplicity adjustment. The adjusted confidence intervals could be wider than presented here. As such, confidence intervals are provided to illustrate the variability only and should not be used to draw any statistical conclusion.



### Valve Performance

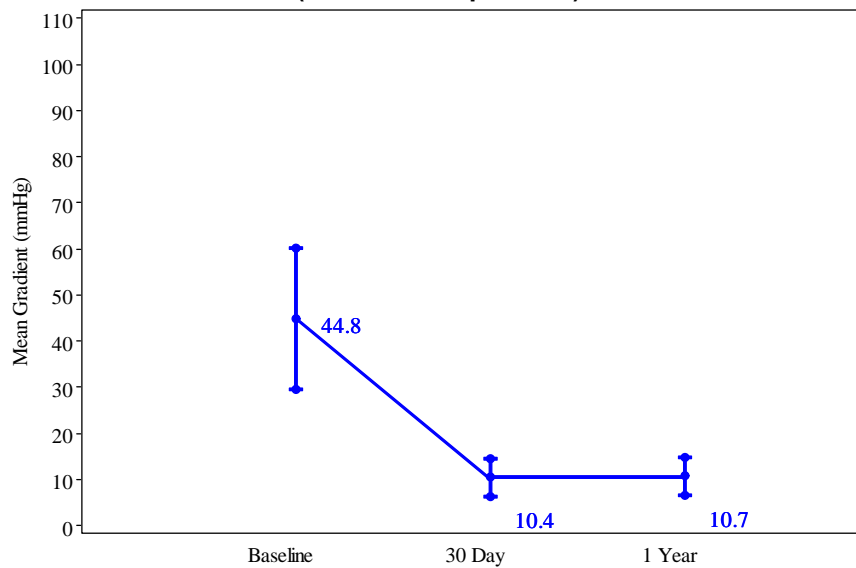
The mean EOA increased from  $0.6 \pm 0.2 \text{ cm}^2$  at baseline to  $1.5 \pm 0.4 \text{ cm}^2$  at 30 days and  $1.4 \pm 0.4 \text{ cm}^2$  at 1 year, as shown in Figure 15.

**Figure 15:**  
**Effective Orifice Area**  
**(S3OUS VI Population)**



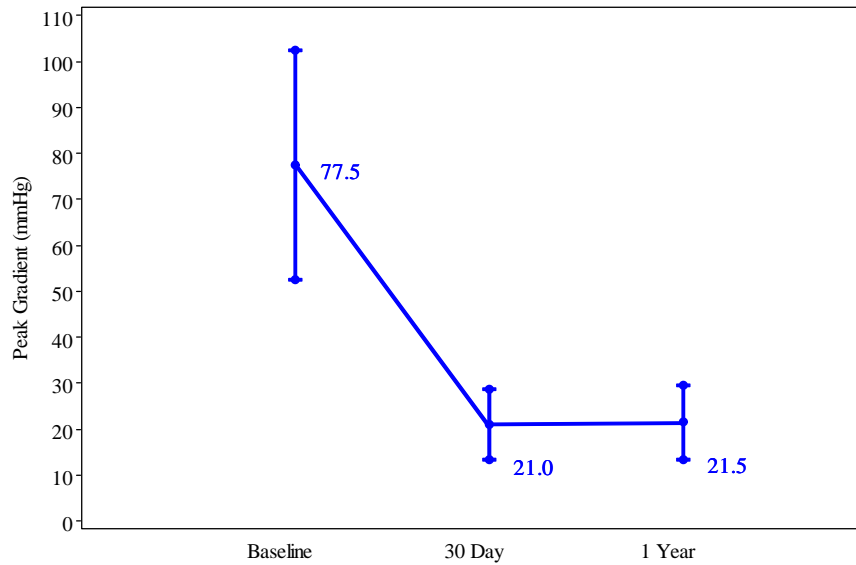
The average mean gradient decreased from  $44.8 \pm 15.4 \text{ mmHg}$  at baseline to  $10.4 \pm 4.1 \text{ mmHg}$  at 30 days and maintained at  $10.7 \pm 4.1 \text{ mmHg}$  at 1 year, as shown in Figure 16.

**Figure 16:**  
**Mean Gradient**  
**(S3OUS VI Population)**



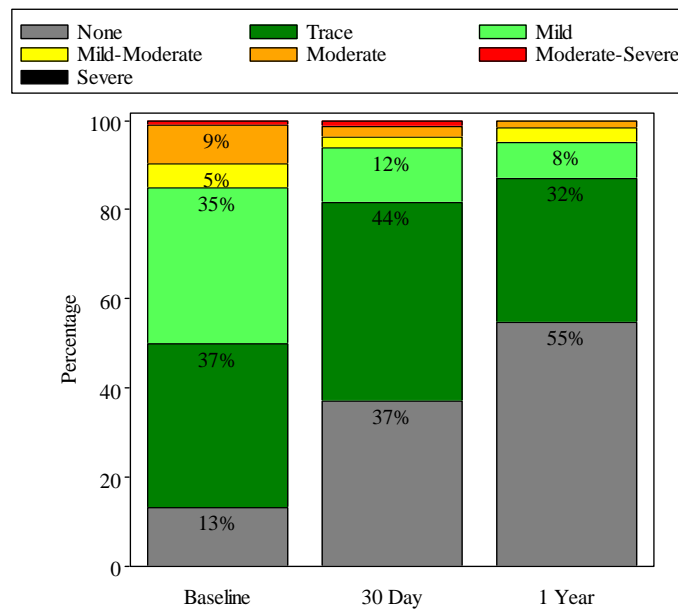
The mean peak gradient decreased from  $77.5 \pm 24.9$  mmHg at baseline to  $21.0 \pm 7.7$  mmHg at 30 days, and maintained at  $21.5 \pm 8.2$  mmHg at 1 year, as shown in Figure 17.

**Figure 17:  
Peak Gradient  
(S3OUS VI Population)**



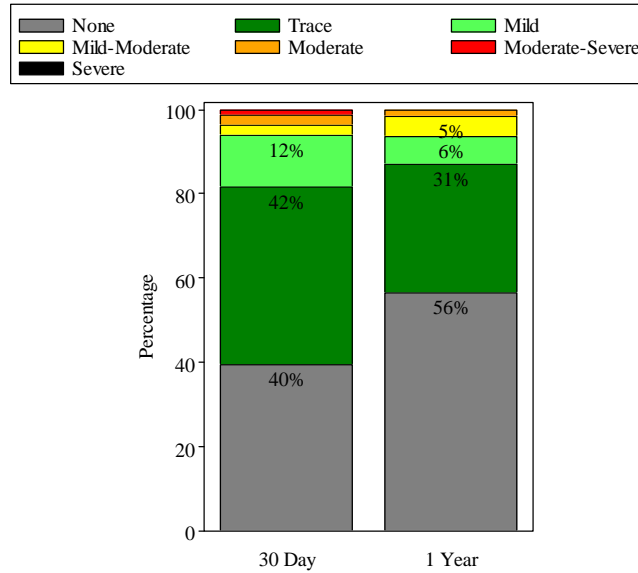
The proportion of patients with aortic insufficiency  $\geq$  moderate was 9.8% at baseline, 3.7% at 30 days, and 1.6% at 1 year, as shown in Figure 18.

**Figure 18:  
Aortic Insufficiency  
(S3OUS VI Population)**



The proportion of patients with aortic PVL  $\geq$  moderate was 3.7% at 30 days, and 1.6% at 1 year, as shown in Figure 19.

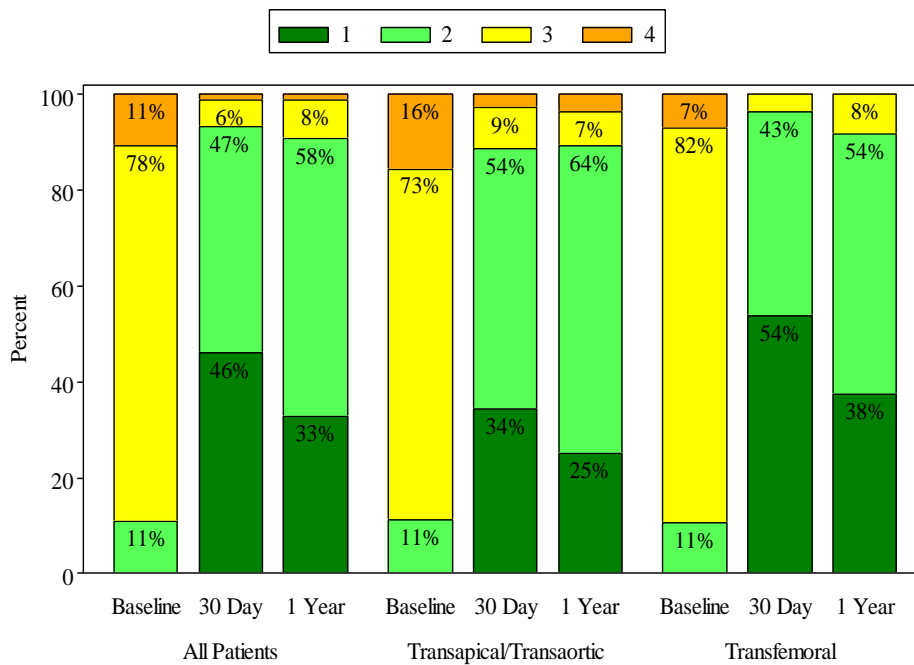
**Figure 19:  
Aortic Paravalvular Leak  
(S3OUS VI Population)**



NYHA

The NYHA class by visit is shown in Figure 20. For all patients, the mean NYHA class decreased from  $3.0 \pm 0.5$  at baseline to  $1.6 \pm 0.7$  at 30 days and  $1.8 \pm 0.6$  at 1 year.

**Figure 20:  
NYHA Class by Visit  
(S3OUS AT Population)**



## **PARTNER II SAPIEN 3 INTERMEDIATE RISK COHORT**

### **Patient Accountability**

At the time of database lock, of the 1078 patients enrolled in the PMA study (PIIS3i), 99.2% (1069) patients are available for analysis at the completion of the study, the 1-year post-operative visit. Table 17 presents patient accountability in the PIIS3i and PIIA-SAVR cohorts. Of the 1,074 eligible patients (Eligible Patient or EP Population) in PIIS3i, 1,069 were successfully implanted with a SAPIEN 3 valve and constitute the PIIS3i Valve Implant (VI) population. Among the VI population, 943 patients were implanted via the transfemoral (TF) access route, and 126 patients via a non-transfemoral (non-TF; mainly transapical and transaortic) access route. Of the 938 eligible patients in the PIIA-SAVR cohort, 936 were successfully implanted with a surgical valve and constitute the PIIA-SAVR VI population.

**Table 17:  
Patient Accountability**

	<b>All Enrolled Patients</b>	<b>Eligible Patient (EP) Population*</b>	<b>Valve Implant (VI) Population†</b>
SAPIEN 3 Cohort	1078	1074	1069
TF	952	948	943
Non-TF	126	126	126
PIIA SAVR	1021	938	936

\* Eligible Patient (EP) Population consists of all enrolled patients who were determined eligible after screening, entered into the catheterization laboratory and remained eligible to receive the assigned implant.

† Valve Implant (VI) Population is a subset of the EP Population who received the assigned valve, and retained the valve upon leaving the catheterization laboratory.

### **Study Population Demographics and Baseline Parameters**

The demographics of the study population are typical for an aortic stenosis valve replacement study performed in the US, as summarized in Table 18 for the PIIS3i and PIIA-SAVR EP populations.

**Table 18:  
Patient Demographics and Baseline Characteristics of the EP Population**

<b>Demographics &amp; Characteristics*</b>	<b>SAPIEN 3 Valve</b>			<b>PIIA-SAVR (N = 938)</b>
	<b>Overall (N = 1074)</b>	<b>TF Only (N = 948)</b>	<b>Non-TF Only (N = 126)</b>	
Age – years	81.9 ± 6.60	82.1 ± 6.57	80.7 ± 6.69	81.6 ± 6.73
Male sex	662/1074 (61.6%)	577/948 (60.9%)	85/126 (67.5%)	514/938 (54.8%)
Society of Thoracic Surgeons (STS) score	5.3 ± 1.29	5.3 ± 1.29	5.6 ± 1.28	5.8 ± 1.92
New York Heart Association (NYHA) class				
I/II	294/1074 (27.4%)	262/948 (27.6%)	32/126 (25.4%)	225/937 (24.0%)
III/IV	780/1074 (72.6%)	686/948 (72.4%)	94/126 (74.6%)	712/937 (76.0%)
Coronary artery disease	748/1074 (69.6%)	652/948 (68.8%)	96/126 (76.2%)	623/938 (66.4%)
Previous myocardial infarction	172/1074 (16.0%)	133/948 (14.0%)	39/126 (31.0%)	166/938 (17.7%)

Demographics & Characteristics*	SAPIEN 3 Valve			PIIA-SAVR (N = 938)
	Overall (N = 1074)	TF Only (N = 948)	Non-TF Only (N = 126)	
Previous intervention				
Coronary artery bypass grafting (CABG)	301/1074 (28.0%)	248/948 (26.2%)	53/126 (42.1%)	241/938 (25.7%)
Percutaneous coronary intervention (PCI)	344/1074 (32.0%)	299/948 (31.5%)	45/126 (35.7%)	254/938 (27.1%)
Prior aortic valvuloplasty	55/1074 (5.1%)	51/948 (5.4%)	4/126 (3.2%)	45/938 (4.8%)
Cerebral vascular accident (CVA)	97/1074 (9.0%)	81/948 (8.5%)	16/126 (12.7%)	96/938 (10.2%)
Peripheral vascular disease	304/1074 (28.3%)	231/948 (24.4%)	73/126 (57.9%)	301/938 (32.1%)
Chronic obstructive pulmonary disease (COPD)				
Any	321/1072 (29.9%)	270/946 (28.5%)	51/126 (40.5%)	279/932 (29.9%)
Oxygen-dependent	53/1067 (5.0%)	46/942 (4.9%)	7/125 (5.6%)	26/925 (2.8%)
Atrial fibrillation	385/1074 (35.8%)	342/948 (36.1%)	43/126 (34.1%)	326/938 (34.8%)
Permanent pacemaker	142/1074 (13.2%)	121/948 (12.8%)	21/126 (16.7%)	113/938 (12.0%)
Severe pulmonary hypertension	25/1074 (2.3%)	19/948 (2.0%)	6/126 (4.8%)	N/A
Frailty	92/1074 (8.6%)	86/948 (9.1%)	6/126 (4.8%)	15/938 (1.6%)
Porcelain aorta	1/1074 (0.1%)	1/948 (0.1%)	0/126 (0.0%)	0/938 (0.0%)
Chest deformities that preclude an open chest procedure	1/1074 (0.1%)	1/948 (0.1%)	0/126 (0.0%)	0/938 (0.0%)
Cirrhosis	4/1074 (0.4%)	4/948 (0.4%)	0/126 (0.0%)	4/938 (0.4%)
Echocardiographic findings (Valve Implant Population)				
Effective orifice area (EOA) - cm <sup>2</sup>	0.7 ± 0.17	0.7 ± 0.16	0.7 ± 0.18	0.7 ± 0.20
Mean aortic-valve gradient –mmHg	46.1 ± 12.63	46.1 ± 12.66	45.8 ± 12.47	44.7 ± 12.55
Mean left ventricular ejection fraction (LVEF) %	58.5 ± 13.36	58.8 ± 13.24	56.0 ± 14.05	55.4 ± 11.75
Moderate or severe mitral regurgitation	91/1033 (8.8%)	87/909 (9.6%)	4/124 (3.2%)	153/841 (18.2%)

\*Continuous measures - Mean ± SD; Categorical measures – n/total no. (%)

**Safety and Effectiveness Results**

**Primary Endpoints**

The primary endpoint was a composite of all-cause death, stroke, and AI ≥ moderate at 1 year. The weighted proportion difference of the primary endpoint was -9.2% (90% CI: [-12.4%, -6.0%]) using the average treatment effect on the treated (ATT) method [3], as shown in Table 19 and Figure 21. Since the upper limit of the CI was < 7.5%, non-inferiority was met.

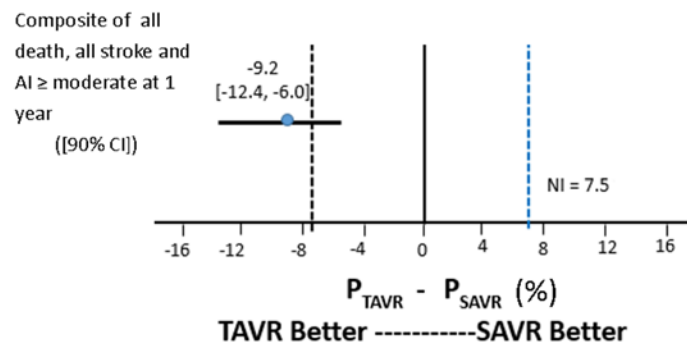
**Table 19:  
Primary Endpoint Non-Inferiority Test  
(VI Population)**

	Observed Event rate		Propensity Score Quintile Pooled Proportion Difference (ATT Method*) [90% CI]†	Margin	Conclusion for Non-Inferiority Test
	SAPIEN 3 (N = 1069)	PIIA-SAVR (N = 936)			
Composite of all-cause death, all stroke, and aortic insufficiency (AI) ≥ moderate at 1 year	13.0%	23.2%	-9.2% [-12.4%, -6.0%]	7.5%	Pass

\* ATT: average treatment effect on the treated

† Two-sided 90% Wald-type confidence interval

**Figure 21:  
Forest Plot – Composite of All Death, All Stroke and AI ≥ Moderate  
(VI Population)**



The Kaplan-Meier (KM) estimates for all-cause death and all stroke at 1 year for the PIIS3i cohort and the PIIA-SAVR cohort are provided in Table 20, as well as Figures 22 and 23, respectively.

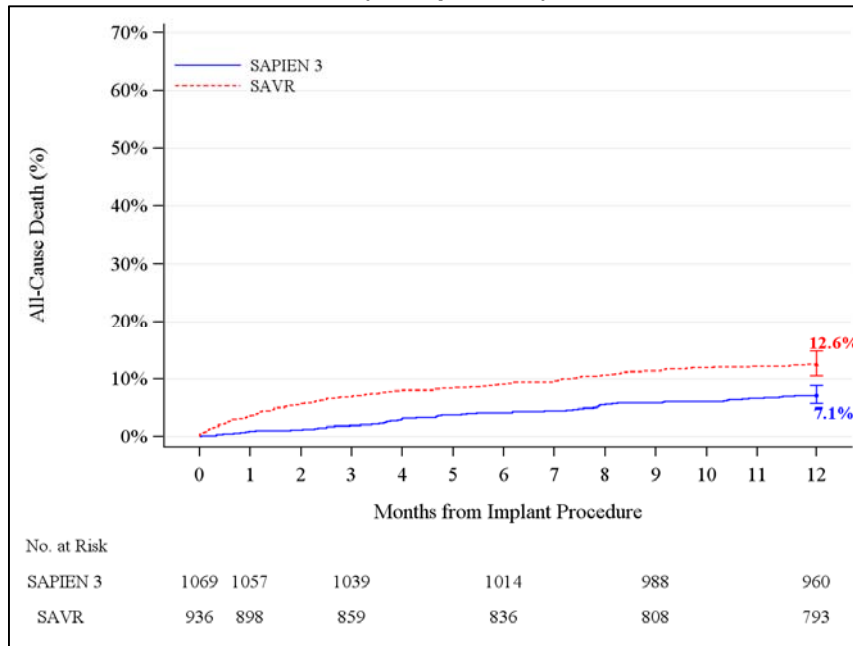
**Table 20:**  
**All-Cause Death and All Stroke at 1 Year**  
**(VI Population)**

Endpoints	SAPIEN 3 Valve (N = 1069)			PIIA-SAVR (N = 936)			Propensity Score Quintile Pooled Proportion Difference (ATT Method <sup>†</sup> )
	Observed Event Rate	Kaplan-Meier Event Rate*		Observed Event Rate	Kaplan-Meier Event Rate*		
		Point Estimate	Standard Error		Point Estimate	Standard Error	
All-cause death at 1 year	7.0%	7.1%	0.79%	12.4%	12.6%	1.09%	-5.2%
All stroke at 1 year	4.5%	4.6%	0.65%	7.9%	8.1%	0.91%	-3.5%

\* Kaplan-Meier estimates were calculated at 365 days and included only the first event for each patient. Events occurring after 365 days were not included in this analysis.

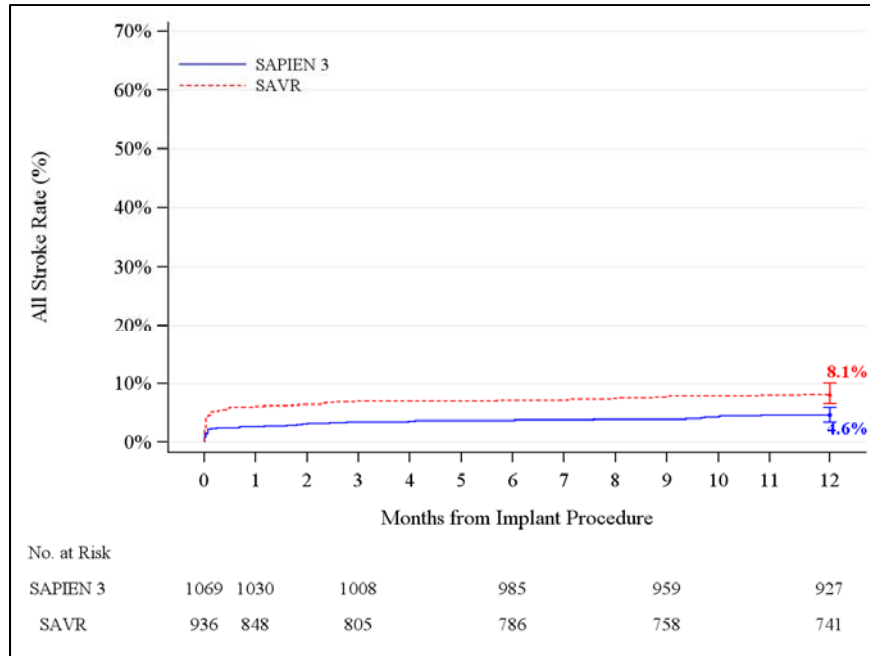
† ATT: average treatment effect on the treated

**Figure 22:**  
**All-Cause Death through 1 Year**  
**(VI Population)**



**Note:** The confidence intervals were calculated without multiplicity adjustment. The adjusted confidence intervals could be wider than presented here. As such, the confidence intervals are provided to illustrate the variability only and should not be used to draw any statistical conclusion.

**Figure 23:  
All Stroke through 1 Year  
(VI Population)**



**Note:** The confidence intervals were calculated without multiplicity adjustment. The adjusted confidence intervals could be wider than presented here. As such, the confidence intervals are provided to illustrate the variability only and should not be used to draw any statistical conclusion.

The proportion of patients with AI  $\geq$  moderate at 1 year was 1.6% for the PIIS3i cohort and 0.3% for the PIIA-SAVR cohort, as shown in Table 21.

**Table 21:  
Aortic Insufficiency (AI)  $\geq$  Moderate at 1 Year (VI Population)**

	Observed Event Rate		Propensity Score Quintile Pooled Proportion Difference (ATT Method <sup>*</sup> )
	SAPIEN 3 Valve (N = 1069)	SAVR (N = 936)	
Aortic insufficiency (AI) $\geq$ moderate	1.6%	0.3%	1.2%

\* ATT: average treatment effect on the treated

**Secondary Endpoints**

The secondary endpoints were examined in a pre-specified order adjusted for the propensity quintiles using the ATT method. Table 22 summarizes the statistical conclusions on the non-inferiority hypothesis testing of the five secondary endpoints for labeling that were evaluated using a gatekeeping/hierarchical multiplicity adjustment procedure to control the overall type I error to 0.05. For each secondary endpoint, the upper limit of the confidence interval was less than the respective non-inferiority margin. Therefore, for each of the secondary endpoints for labeling, the SAPIEN 3 valve was non-inferior to SAVR.



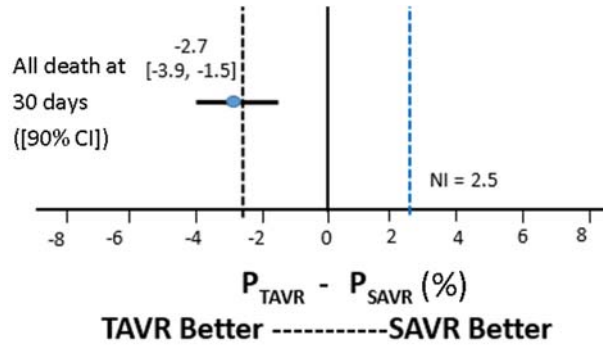
**Table 22:  
Secondary Endpoints for Labeling – Gatekeeping/Hierarchical Method  
(VI Population)**

Pre-Specified Order for Gatekeeping/Hierarchical Method	Endpoints	Observed Event Rate		Weighted Proportion Difference in Average Treatment Effect on the Treated [90% CI] <sup>†</sup>	Margin	Conclusion for Non-Inferiority Test
		SAPIEN 3 Valve (N = 1069)	PIIA-SAVR (N = 936)			
No. 1	Composite of all death, all strokes, life threatening (disabling)/ major bleeding and major vascular complication at 30 days	18.3%	79.4%	-60.5% [-63.5%, -57.4%]	7.5%	Pass
No. 2	Major vascular and access complications through 30 days	5.8%	5.3%	0.3% [-1.5%, 2.0%]	5.0%	Pass
No. 3	Life threatening (disabling)/ major bleeding through 30 days	14.6%	78.2%	-63.2% [-66.2%, -60.2%]	5.0%	Pass
No. 4	All-cause death through 30 days	0.9%	3.7%	-2.7% [-3.9%, -1.5%]	2.5%	Pass
No. 5	All stroke through 30 days	2.6%	6.1%	-3.2% [-4.7%, -1.6%]	2.5%	Pass

<sup>†</sup> Two-sided 90% Wald-type confidence interval.

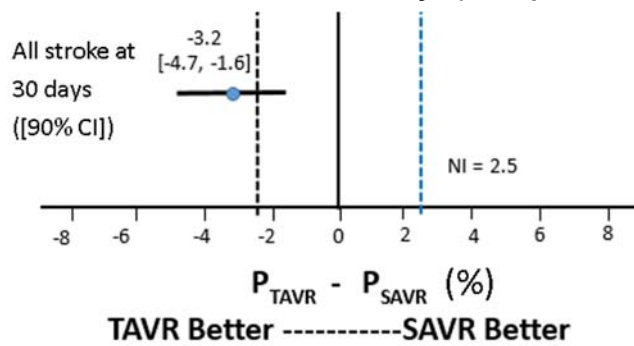
The forest plots for all-cause death and all stroke at 30 days are provided in Figures 24 and 25, respectively.

**Figure 24:**  
**Forest Plot – All-Cause Death at 30 Days**  
**(VI Population)**



**Note:** As part of a pre-specified hierarchy, the hypothesis for this endpoint was tested using a hierarchical gatekeeping approach. The confidence interval shown here was not adjusted for multiplicity per the gatekeeping approach.

**Figure 25:**  
**Forest Plot – All Stroke at 30 Days (VI Population)**



**Note:** As part of a pre-specified hierarchy, the hypothesis for this endpoint was tested using a hierarchical gatekeeping approach. The confidence interval shown here was not adjusted for multiplicity per the gatekeeping approach.

## Adverse Events

The key CEC-adjudicated adverse events through 1 year for the EP population are presented in Table 23.

**Table 23:  
CEC-Adjudicated Adverse Events through 1 Year  
(EP Population)**

Event*	SAPIEN 3 Valve			PIIA-SAVR
	Overall	TF Only	Non-TF Only	
<b>7 Days</b>				
Acute kidney injury: Stage III	5/1074 (0.5%)	3/948 (0.3%)	2/126 (1.6%)	N/A
<b>30 Days</b>				
Death	12/1074 (1.1%)	10/948 (1.1%)	2/126 (1.6%)	35/938 (3.7%)
Cardiac death	10/1074 (0.9%)	9/948 (0.9%)	1/126 (0.8%)	26/938 (2.8%)
Non-cardiac death	2/1074 (0.2%)	1/948 (0.1%)	1/126 (0.8%)	9/938 (1.0%)
Stroke	29/1074 (2.7%)	24/948 (2.5%)	5/126 (4.0%)	57/938 (6.1%)
Major (disabling) stroke	11/1074 (1.0%)	7/948 (0.7%)	4/126 (3.2%)	41/938 (4.4%)
Minor (non-disabling) stroke	18/1074 (1.7%)	17/948 (1.8%)	1/126 (0.8%)	16/938 (1.7%)
Myocardial infarction	3/1074 (0.3%)	3/948 (0.3%)	0/126 (0.0%)	17/938 (1.8%)
Major vascular complication	65/1074 (6.1%)	60/948 (6.3%)	5/126 (4.0%)	50/938 (5.3%)
Life threatening (disabling) or major bleeding	159/1074 (14.8%)	112/948 (11.8%)	47/126 (37.3%)	733/938 (78.1%)
Aortic valve re-intervention	1/1074 (0.1%)	1/948 (0.1%)	0/126 (0.0%)	0/938 (0.0%)
Any endocarditis	2/1074 (0.2%)	2/948 (0.2%)	0/126 (0.0%)	0/938 (0.0%)
Rhythm disturbance requiring permanent pacemaker	108/1074 (10.1%)	99/948 (10.4%)	9/126 (7.1%)	68/938 (7.2%)
<b>1 Year</b>				
Death	79/1074 (7.4%)	61/948 (6.4%)	18/126 (14.3%)	117/938 (12.5%)
Cardiac death	47/1074 (4.4%)	37/948 (3.9%)	10/126 (7.9%)	70/938 (7.5%)
Non-cardiac death	32/1074 (3.0%)	24/948 (2.5%)	8/126 (6.3%)	47/938 (5.0%)
Stroke	49/1074 (4.6%)	40/948 (4.2%)	9/126 (7.1%)	74/938 (7.9%)
Major (disabling) stroke	24/1074 (2.2%)	16/948 (1.7%)	8/126 (6.3%)	53/938 (5.7%)
Minor (non-disabling) stroke	25/1074 (2.3%)	24/948 (2.5%)	1/126 (0.8%)	22/938 (2.3%)
Aortic valve re-intervention	6/1074 (0.6%)	6/948 (0.6%)	0/126 (0.0%)	4/938 (0.4%)
Any endocarditis	8/1074 (0.7%)	7/948 (0.7%)	1/126 (0.8%)	6/938 (0.6%)

\*Categorical measures - n. / total no. (%).

In addition, site-reported new-onset atrial fibrillation was 5.9% in the PIIS3i EP population and 29.2% in the PIIA-SAVR EP population.

### Bleeding Rate

The bleeding rates utilizing the number of units transfused are presented in Table 24.

**Table 24:  
Bleeding Rate Using Site-Reported Units Transfused (EP Population)**

Event*	SAPIEN 3 Valve (N = 1074)	PIIA-SAVR (N = 938)
Transfusion units $\geq 2$ and $< 4$	47/1074 (4.4%)	184/938 (19.6%)
Transfusion units $\geq 4$	18/1074 (1.7%)	218/938 (23.2%)

\*Site-reported Transfusion at Day 0 or Day 1; Categorical measures - n. / total no. (%)

### Other Results

#### **Procedural Information**

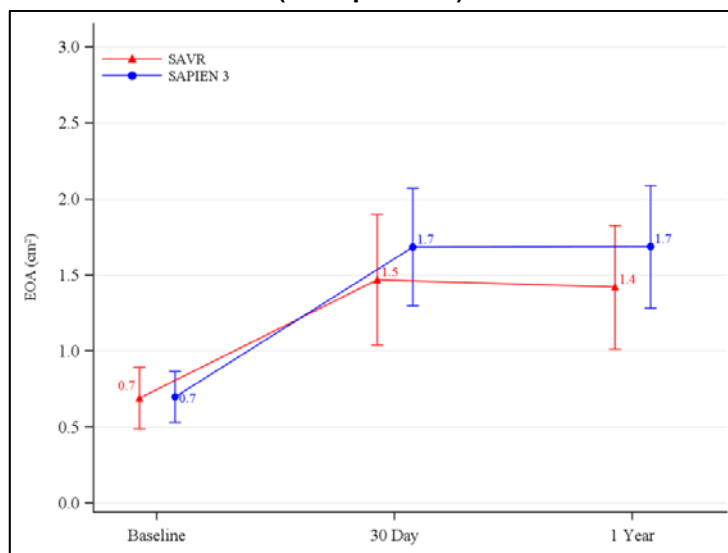
In the PIIS3i EP population the mean duration in the catheterization laboratory was  $187.3 \pm 53.2$  minutes, the mean total procedure time was  $84.2 \pm 40.7$  minutes, and the mean total anesthesia time was  $186.9 \pm 61.1$  minutes, all of which were slightly shorter in the TF group. General anesthesia was used in the vast majority of cases; 18.9% of the TF patients had conscious sedation. Correct positioning of the valve was achieved in 99.3% of the patients. Four (4) patients (0.4%, all TF patients) were implanted with a second valve. One (1) patient (0.1%) experienced valve embolization and two (2) patients (0.2%) experienced annular rupture.

In the PIIA-SAVR EP population, the mean duration in the operating room was  $333.2 \pm 96.4$  min, the mean total procedure time was  $237.5 \pm 86.58$  min, and the mean anesthesia time was  $333.5 \pm 108.42$  min. General anesthesia was used in all patients.

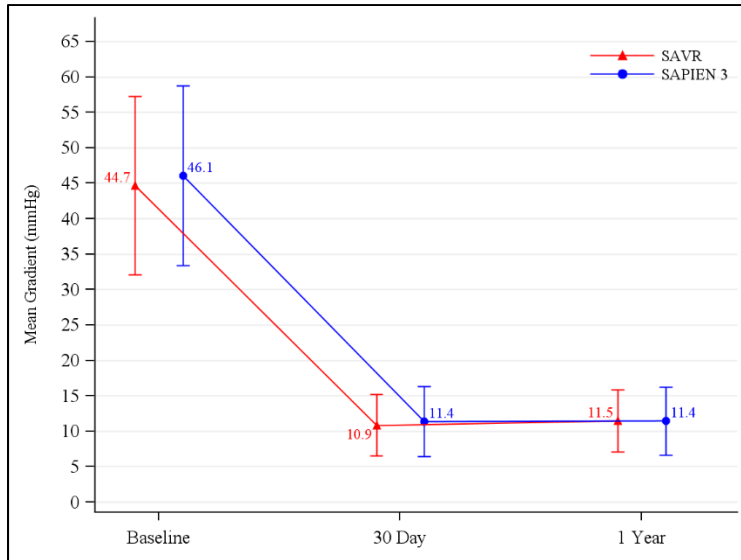
#### **Valve Performance**

The measurements of EOA, mean gradient, peak gradient, total aortic regurgitation (AR), and aortic paravalvular leak (PVL) are presented in Figures 26-30. The increase in EOA and decrease in gradient were sustained at 1 year. In PIIS3i, the proportion of patients with total AR  $\geq$  moderate was 6.2% at baseline, 3.9% at 30 days, and 1.6% at 1 year, while in PIIA-SAVR, the proportion of patients with total AR  $\geq$  moderate was 12.0% at baseline, 0.7% at 30 days, and 0.3% at 1 year. The proportion of patients with aortic PVL  $\geq$  moderate was 3.8% at 30 days and 1.5% at 1 year in PIIS3i, as compared to 0.5% at 30 days and 0.3% at 1 year in PIIA-SAVR.

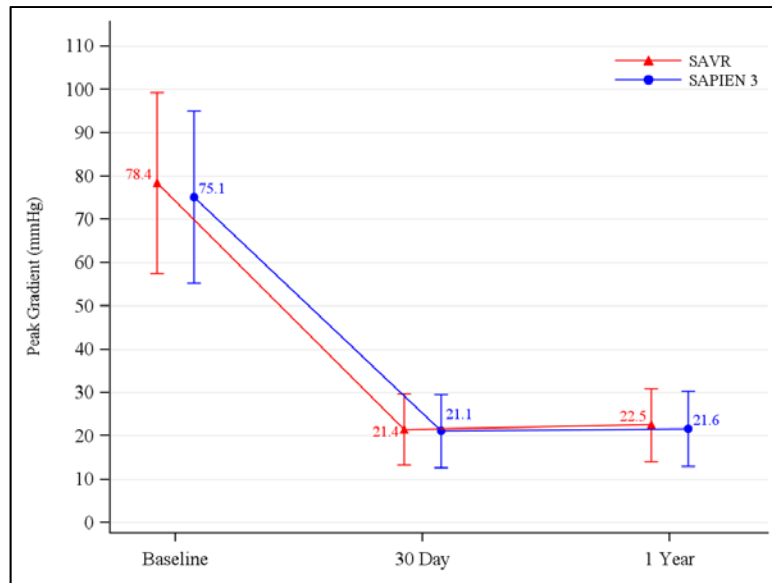
**Figure 26  
Effective Orifice Area  
(VI Population)**



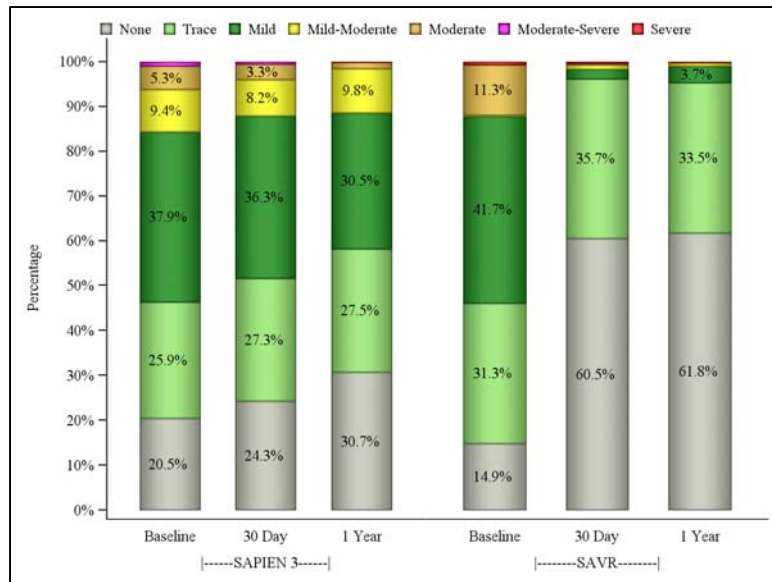
**Figure 27:  
Mean Gradient  
(VI Population)**



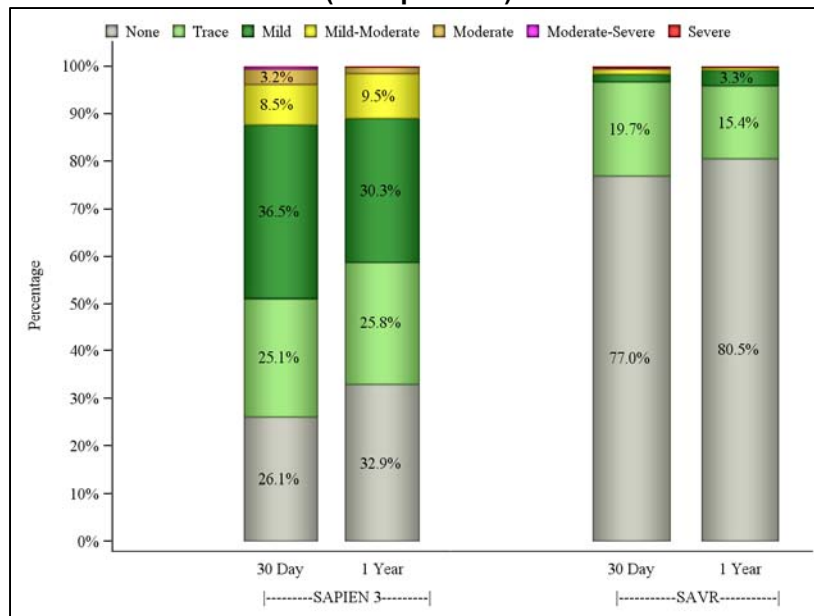
**Figure 28:  
Peak Gradient  
(VI Population)**



**Figure 29:  
Total Aortic Regurgitation  
(VI Population)**



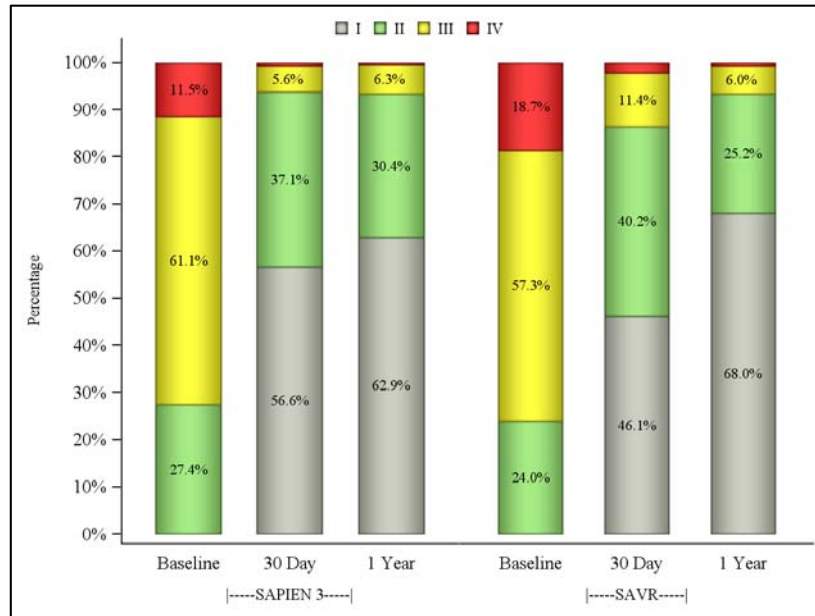
**Figure 30:  
Aortic Paravalvular Leak  
(VI Population)**



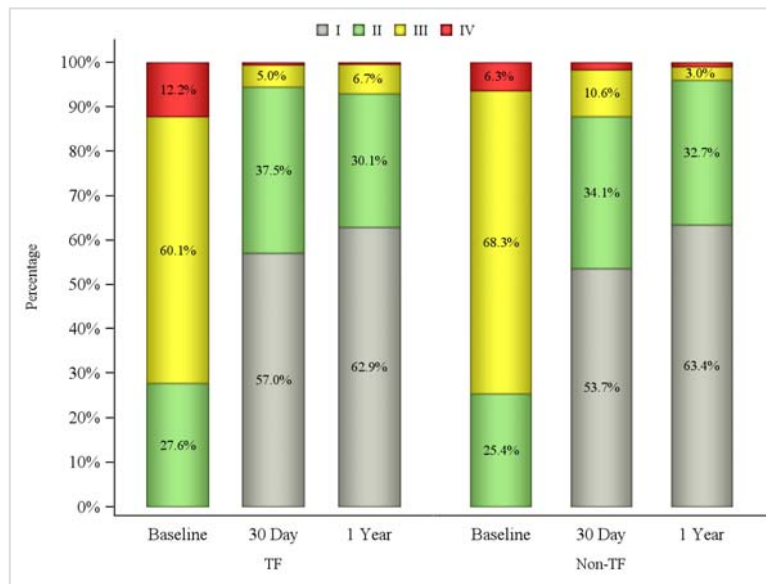
**NYHA**

The NYHA classifications by visit are presented in Figure 31. In PIIS3i, 72.6% of the patients were in NYHA Class III or IV at baseline, which reduced to 6.3% at 30 days and 6.7% at 1 year, while in PIIA-SAVR, the percentage of patients in NYHA Class III or IV was 76.0% at baseline, 13.6% at 30 days, and 6.7% at 1 year. A side-by-side comparison of the results by access approach is presented in Figure 32.

**Figure 31:  
NYHA Class by Visit  
(EP Population)**



**Figure 32:  
NYHA Class by Visit – TF versus non-TF Access  
(EP Population)**



### Six-Minute Walk Test (6MWT)

The improvements in mean 6MWT distance are presented in Table 25. The SAPIEN 3 valve patients had a similar increase in mean 6MWT distance from baseline to 1 year as the PIIA-SAVR patients.

**Table 25:  
6MWT Distance (EP Population)**

6MWT Distance (m)*	SAPIEN 3 Valve			PIIA-SAVR
	All	TF	Non-TF	
Baseline	193.9 ± 118.1	194.1 ± 117.2	192.5 ± 125.5	179.3 ± 123.2
30 days	230.6 ± 126.1	234.6 ± 123.6	199.0 ± 140.6	166.7 ± 126.4
1 year	227.7 ± 134.7	230.6 ± 133.6	202.8 ± 142.1	219.2 ± 133.8

\*Plus-minus values are means ± SD.

### Length of Stay (LoS)

The results for LoS are presented in Table 26. Overall, the SAPIEN 3 valve patients had shorter LoS than the PIIA-SAVR patients.

**Table 26:  
Length of Stay (EP Population)**

Length of Stay (days)*	SAPIEN 3 Valve			PIIA-SAVR
	All	TF	Non-TF	
Overall	5.5 ± 5.7	5.0 ± 5.2	9.3 ± 7.7	11.9 ± 7.6
ICU	2.7 ± 3.0	2.5 ± 2.6	4.2 ± 4.9	5.6 ± 6.1

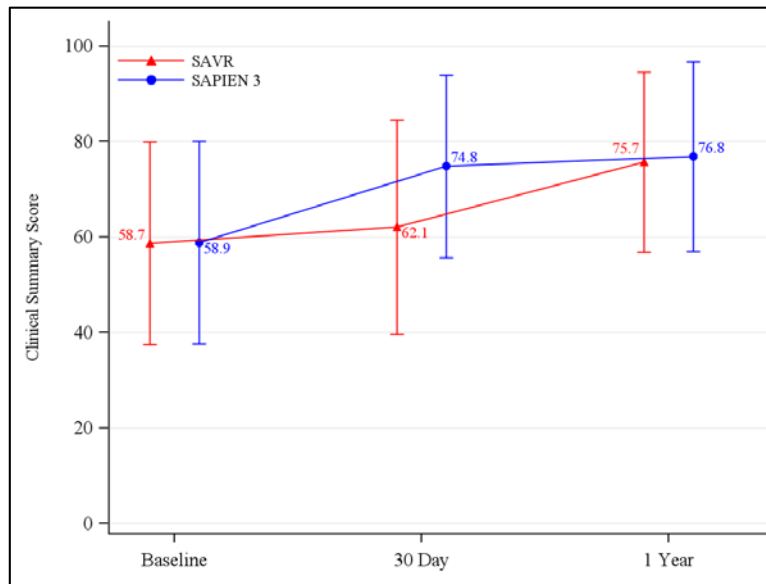
\*Plus-minus values are means ± SD.



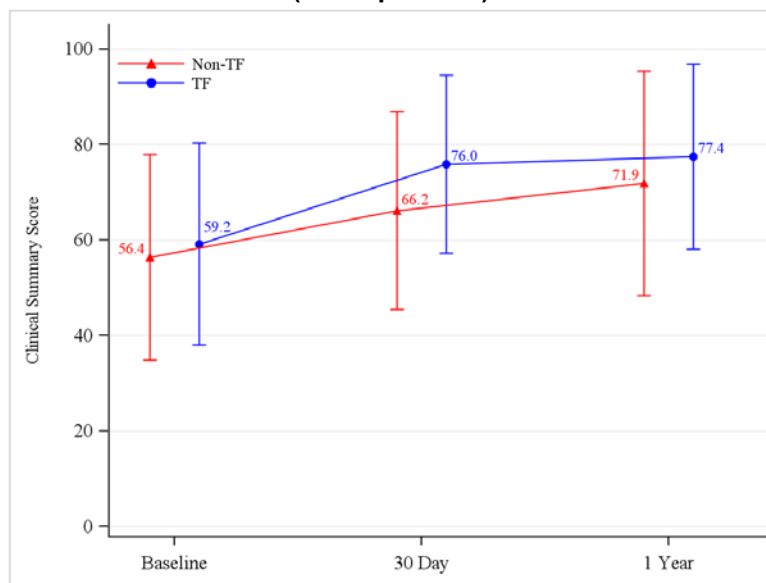
QoL

The QoL measurements using the Kansas City Cardiomyopathy Questionnaire (KCCQ) clinical summary score are presented in Figure 33. Except for self-efficacy which showed a small improvement, moderate to large improvements were observed in all other subscores at 30 days and were sustained at 1 year in the PIIS3i EP population. A side-by-side comparison of the results by access approach is presented in Figure 34. In general, improvements in the TF group were slightly larger as compared to those observed in the Non-TF group.

**Figure 33:  
KCCQ Clinical Summary Score (EP Population)**



**Figure 34:  
KCCQ Clinical Summary Score - TF versus non-TF Access  
(EP Population)**



Additional QoL instruments

QoL was also measured using the visual analog scale (VAS) of the EuroQoL (EQ-5D) measure and the SF-36 Health Status Questionnaire. The VAS is a self-assessment in which patients rate their well-being on a scale from 0 to 100 where 0 is the worst state they can imagine and 100 is the best state. SF-36 uses 36 questions to measure functional health and well-being from the patient's point of view and is generally reported in two (2) summary scores on a scale from 0 to 100 which evaluate physical (the Physical Summary Score) and mental (the Mental Summary Score) health, with higher scores representing better functional health and well-being. The results of the VAS and SF-36 measures are presented in Tables 27 and 28, respectively.

**Table 27:  
EQ-5D Visual Analog Scale  
(EP Population)**

EQ-5D Visual Analog Scale*	SAPIEN 3 Valve			PIIA-SAVR
	All	TF	Non-TF	
Baseline	60.3 ± 20.0	61.0 ± 19.8	55.1 ± 20.7	59.5 ± 20.5
30 days	74.0 ± 16.6	74.8 ± 16.6	68.5 ± 16.2	67.2 ± 19.5
1 year	74.4 ± 17.2	74.7 ± 17.1	71.8 ± 17.8	74.3 ± 16.7

\*Plus-minus values are means ± SD.

**Table 28:  
SF-36 Health Status Questionnaire Score  
(EP Population)**

SF-36 Health Status Questionnaire Score*	SAPIEN 3 Valve			PIIA-SAVR
	All	TF	Non-TF	
Physical Component Score				
Baseline	34.7 ± 9.1	35.0 ± 9.1	33.1 ± 8.5	34.3 ± 9.0
30 days	39.7 ± 9.8	40.3 ± 9.7	34.8 ± 9.2	34.5 ± 8.4
1 year	40.0 ± 10.3	40.4 ± 10.2	37.0 ± 10.8	39.5 ± 10.4
Mental Component Score				
Baseline	48.0 ± 11.8	48.1 ± 11.8	47.0 ± 12.3	48.0 ± 12.3
30 days	51.8 ± 10.6	52.3 ± 10.4	47.8 ± 11.3	45.5 ± 13.3
1 year	52.5 ± 10.7	52.7 ± 10.8	50.7 ± 10.1	52.0 ± 11.3

\*Plus-minus values are means ± SD.

**PARTNER 3 SAPIEN 3 Low Risk Cohort**

**A. Accountability of the PMA Cohort**

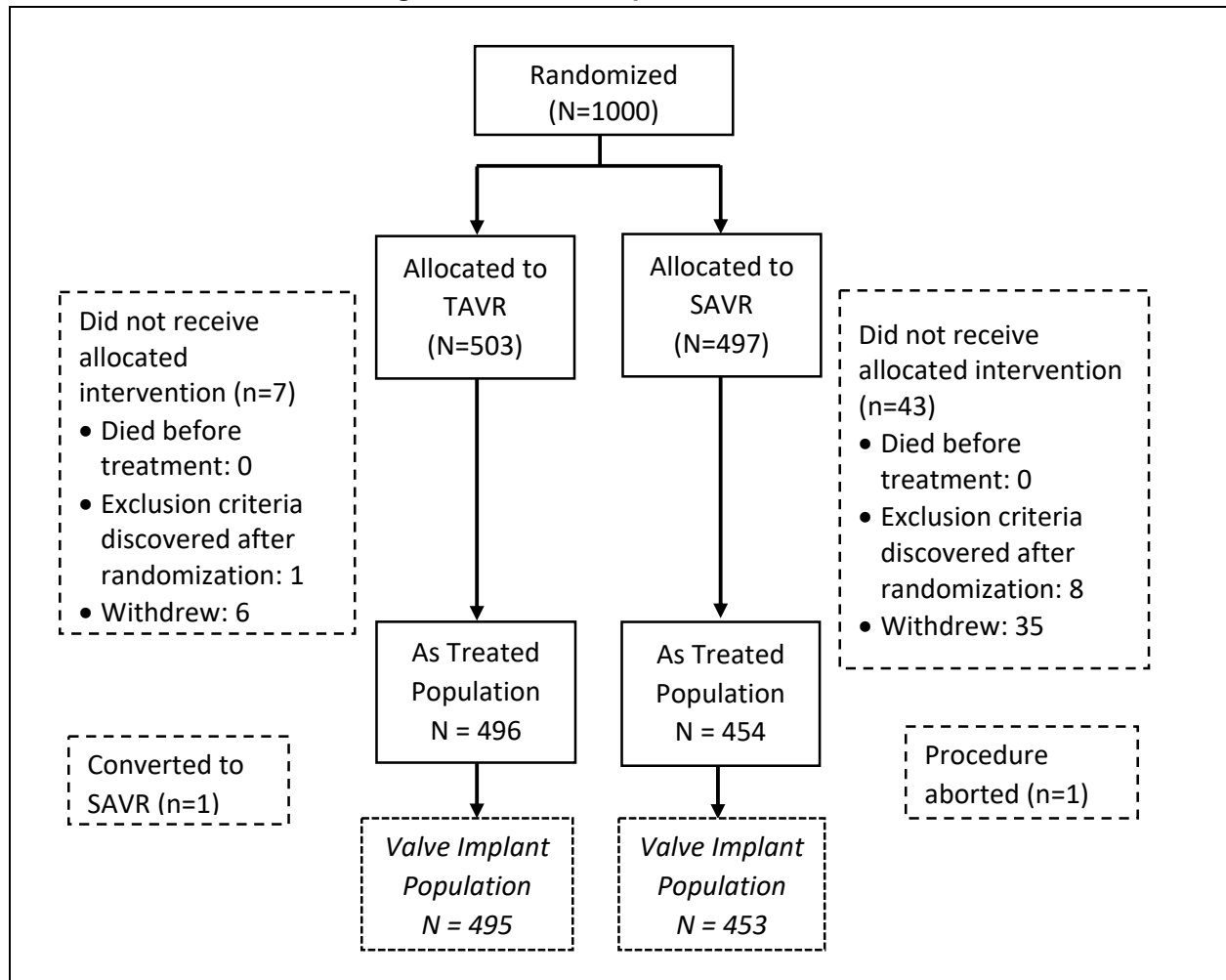
At the time of database lock, a total of 1000 subjects were randomized in the study, including 503 TAVR patients and 497 SAVR patients.

There were three different analysis populations defined in the protocol: Intention-to-Treat (ITT), As Treated (AT), and Valve Implant (VI), as summarized in Table 29 and Figure 35. The primary analysis was the AT analysis.

**Table 29: Analysis Populations**

Analysis Population	Definition	Number of Patients	
		TAVR	SAVR
Intention-To-Treat (ITT)	All randomized patients.	503	497
As Treated (AT)	All ITT patients for whom the index procedure was begun, whether or not the index procedure was completed.	496	454
Valve Implant (VI)	All AT patients who received and retained the intended valve during the index procedure.	495	453

**Figure 35: Patient Population Flowchart**



The overall follow-up compliance of the trial is summarized in Table 30.

**Table 30: Overall Study Compliance (AT Population)**

Patient Accountability	30-day Visit		1 Year Visit	
	TAVR (N=496)	SAVR (N=454)	TAVR (N=496)	SAVR (N=454)
Total patients	496	454	496	454
Non-eligible	2	11	6	30
Death	2	6	5	11
Withdrawal	0	3	0	12
Lost to follow-up	0	0	0	1
Exit with other reason	0	2	1	6
Visit not yet due	0	0	0	0
Eligible	494	443	490	424
Follow-up visit completed	96.5% (493)	96.5% (438)	97.8% (485)	91.2% (414)
Missed visit	0.2% (1)	1.1% (5)	1.0% (5)	2.2% (10)

## B. Study Population Demographics and Baseline Characteristics

The demographics and baseline characteristics of the study population are typical for a TAVR study performed in the U.S., as shown in Table 31. The treatment cohorts were generally well balanced with respect to age, gender, and STS risk score.

**Table 31:**  
**Patient Demographics and Baseline Characteristics**  
**(AT Population)**

Demographics and Baseline Characteristics	Summary Statistics*	
	TAVR (N = 496)	SAVR (N = 454)
Age - years	73.3 ± 5.8	73.6 ± 6.1
Male sex	67.5% (335/496)	71.1% (323/454)
Society of Thoracic Surgeons (STS) score	1.9 ± 0.7	1.9 ± 0.6
New York Heart Association (NYHA) class		
I/II	68.8% (341/496)	76.2% (346/454)
III/IV	31.1% (155/496)	23.8% (108/454)
Previous myocardial infarction	5.7% (28/495)	5.8% (26/452)
Previous intervention		
Coronary artery bypass grafting (CABG)	3.0% (15/494)	1.8% (8/451)
Percutaneous coronary intervention (PCI)	18.8% (93/494)	16.2% (73/452)
Stroke or cerebrovascular accident (CVA)	3.4% (17/496)	5.1% (23/453)
Peripheral vascular disease (PVD)	6.9% (34/494)	7.3% (33/453)
Atrial fibrillation	15.7% (78/496)	18.8% (85/453)
Atrial flutter	3.0% (15/496)	2.4% (11/452)
Permanent pacemaker or defibrillator	2.4% (12/496)	2.9% (13/454)
Hostile chest	0.0% (0/496)	0.0% (0/454)
Echocardiographic findings (Valve Implant Population)		
Valve area (cm <sup>2</sup> )	0.8 ± 0.2 (459)	0.8 ± 0.2 (424)
Mean gradient (mmHg)	49.4 ± 12.8 (484)	48.3 ± 11.8 (442)
Mean left ventricular ejection fraction (LVEF) %	65.7 ± 9.0 (472)	66.2 ± 8.6 (436)
Moderate or severe aortic regurgitation	3.9% (19/484)	2.5% (11/446)
Moderate or severe mitral regurgitation	1.3% (6/477)	3.2% (14/437)
* Continuous measures - Mean ± SD (Total no.); Categorical measures % (no./Total no.)		

### C. Safety and Effectiveness Results

#### 1. Primary Endpoint

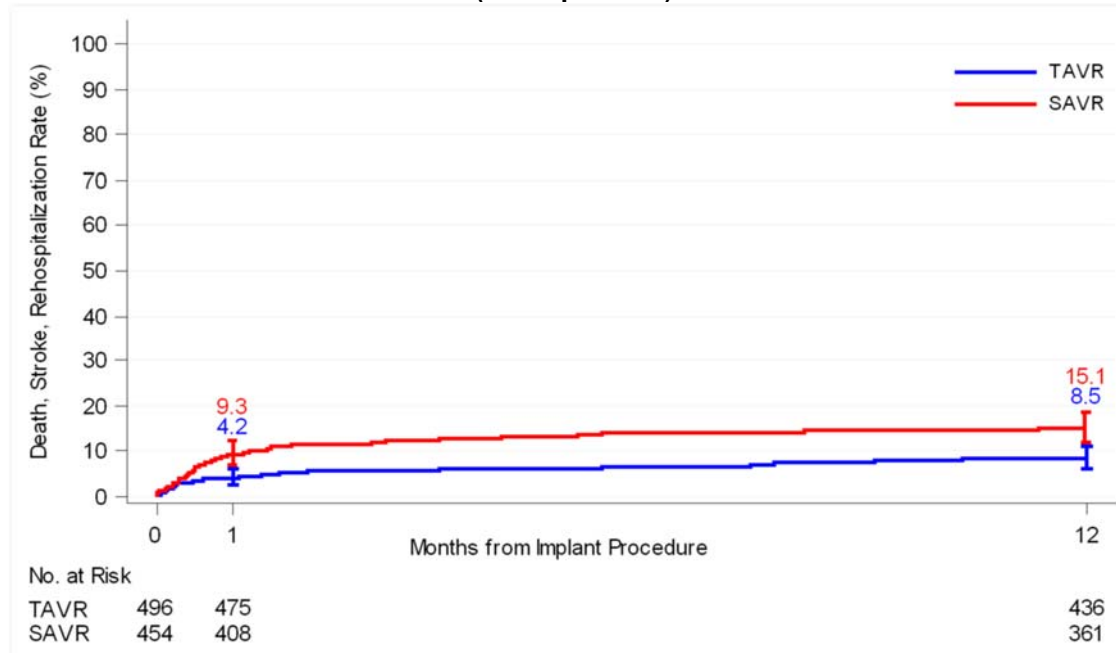
The primary endpoint results are presented in Table 32 and Figure 36. The rate of all-cause death, all stroke, or rehospitalization (valve-related or procedure-related and including heart failure) at 1-year was 8.5% in the TAVR group and 15.1% in the SAVR group. Since the upper limit of the 95% confidence interval for the difference in the primary endpoint event rate was < 6.0%, non-inferiority was achieved.

**Table 32:  
Primary Endpoint Analysis  
(AT Population)**

Event	Kaplan-Meier Rate*		Difference of KM Estimate (TAVR – SAVR)	95% CI* for the Difference	Non-inferiority Criterion
	TAVR (N=496)	SAVR (N=454)			
All-cause death, all stroke, or rehospitalization	8.5% (42)	15.1% (68)	-6.65%	[-10.77%, -2.52%]	Pass
All-cause death	1.0% (5)	2.5% (11)	-1.44%	[-3.13%, 0.24%]	
All stroke	1.2% (6)	3.1% (14)	-1.90%	[-3.77%, -0.02%]	
Rehospitalization	7.3% (36)	11.0% (49)	-3.74%	[-7.45%, -0.02%]	

\*Kaplan-Meier estimate - % (no. of subjects with the event)

**Figure 36: All-Cause Death, All Stroke, and Rehospitalization through 1 Year  
(AT Population)**



**Note:** The confidence intervals were calculated without multiplicity adjustment. The adjusted confidence intervals could be wider than presented here. As such, confidence intervals are provided to illustrate the variability only and should not be used to draw any statistical conclusion.

## 2. Secondary Endpoints

### Hypothesis testing:

Since the primary endpoint passed the non-inferiority testing, the prespecified superiority testing was carried out on the six select secondary endpoints sequentially. TAVR with the SAPIEN 3 valve was found to be superior to SAVR in all six secondary endpoints, as shown in Table 33.

**Table 33:  
Superiority Testing of Select Secondary Endpoints (AT Population)**

No.	Endpoint	Summary Statistics*		Difference (TAVR – SAVR)	95% CI for the Difference	p-value (Superiority Test Result)
		TAVR (N=496)	SAVR (N=454)			
1	New onset atrial fibrillation at 30 days†	5.0% (21/417)	39.3% (145/369)	-34.3%	[-39.7%, -28.9%]	<.0001 (pass)
2	Length of index hospitalization (days)	2.9 ± 0.1 (496)	7.4 ± 0.2 (454)	-4.5	[-4.8, -4.1]	<.0001 (pass)
3	All-cause death, all stroke, or rehospitalization at 1 year	8.5% (42)	15.1% (68)	-6.6%	[-10.8%, -2.5%]	0.0016 (pass)
4	Death, KCCQ < 45 or KCCQ decrease from baseline ≥ 10 points at 30 days	3.9% (19/492)	30.6% (133/435)	-26.7%	[-31.4%, -22.1%]	<.0001 (pass)
5	Death or all stroke at 30 days	1.0% (5/496)	3.3% (15/454)	-2.3%	[-4.2%, -0.4%]	0.0214 (pass)
6	All stroke at 30 days	0.6% (3/496)	2.4% (11/454)	-1.8%	[-3.4%, -0.2%]	0.0284 (pass)

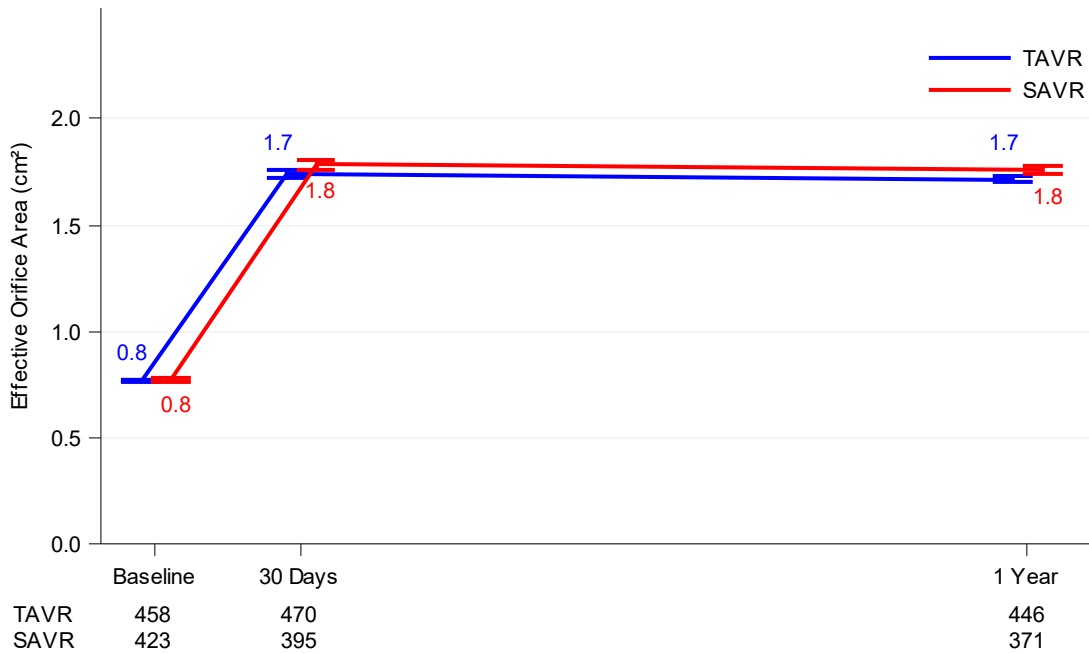
\*Continuous measures - Mean ± SE (Total no.); Categorical measures – observed rate, % (no./Total no.), except No. 3 - Kaplan-Meier rate, % (Total no.).

†Patients with pre-procedural atrial fibrillation were excluded from the analysis.

### Valve Performance

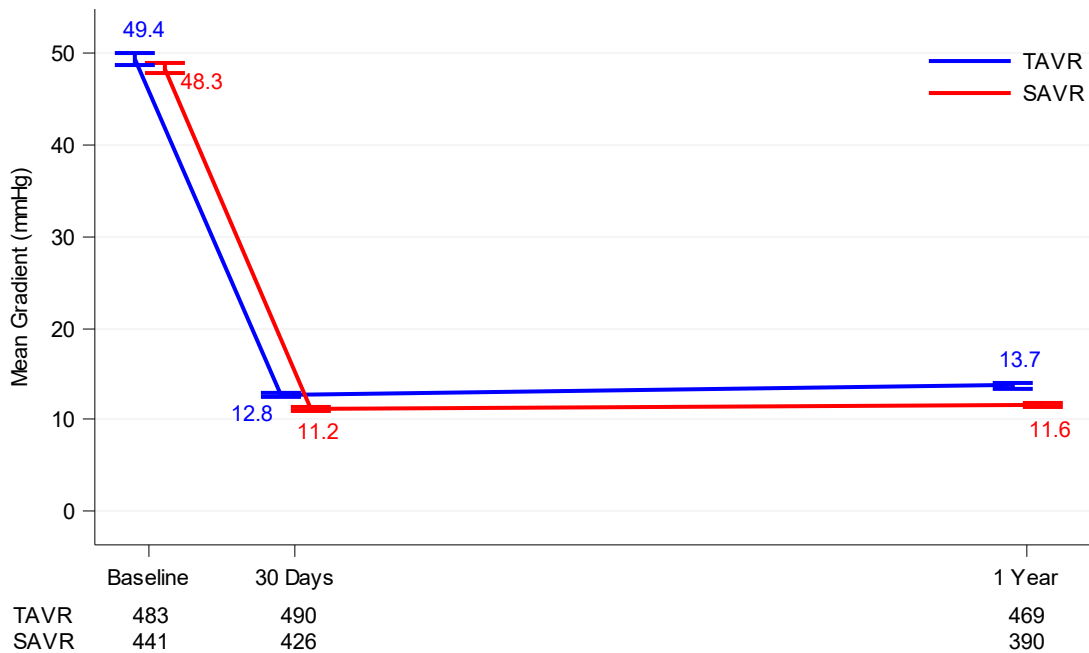
The effective orifice area (EOA), mean aortic gradient, total aortic regurgitation (AR), and paravalvular regurgitation values obtained over time for the TAVR and SAVR patients are shown in Figure 37 through Figure 40, respectively. The increase in EOA and decrease in gradient were sustained through 1 year in both cohorts. In the TAVR cohort, the proportion of patients with total AR ≥ moderate was 0.8% at 30 days and 1.1% at 1 year, while in the SAVR cohort, the corresponding proportion was 0.4% at 30 days and 0.6% at 1 year. The proportion of patients with paravalvular regurgitation ≥ moderate was 0.8% at 30 days and 0.6% at 1 year in the TAVR cohort, as compared to 0.0% at 30 days and 0.8% at 1 year in the SAVR cohort.

**Figure 37: Effective Orifice Area (VI Population)**



**Note:** Line plot with mean and standard error. The total number of patients at each visit time point only counted the patients with valid values.

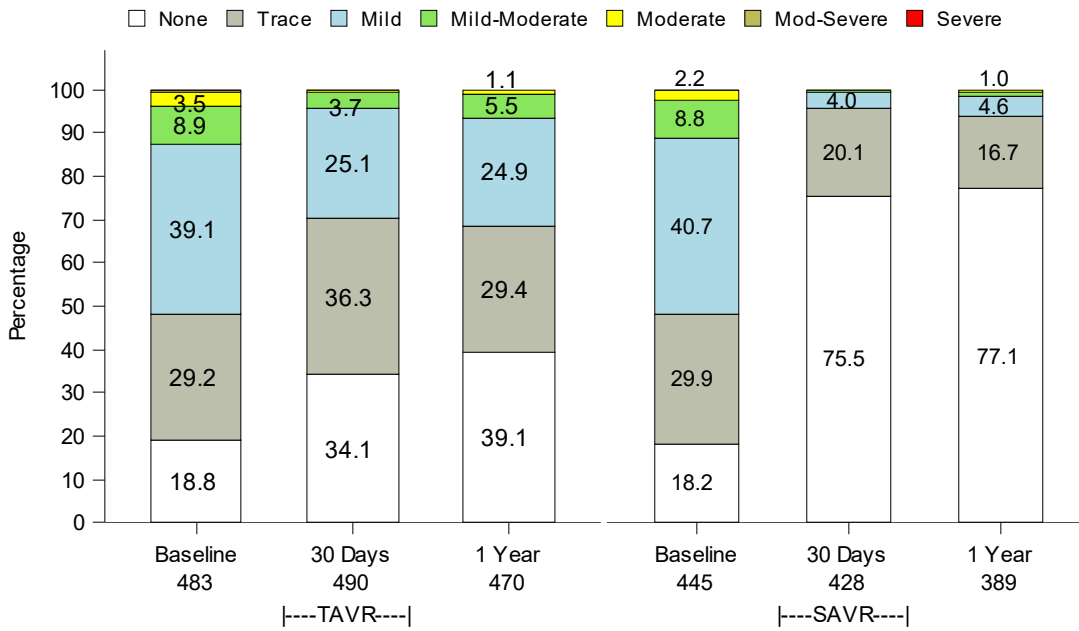
**Figure 38: Mean Aortic Gradient (VI Population)**



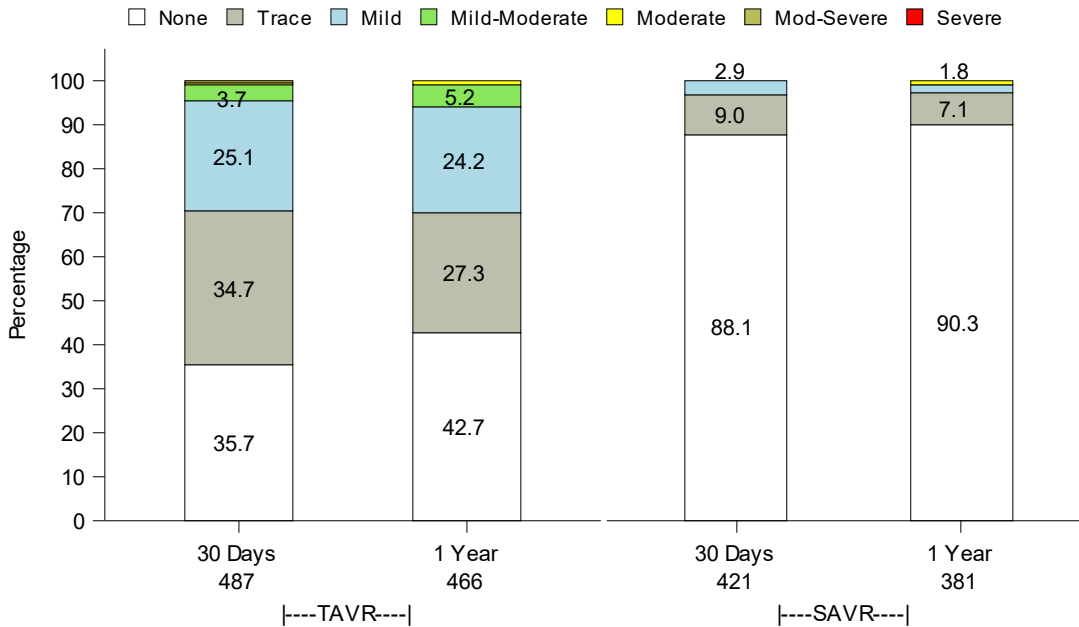
**Note:** Line plot with mean and standard error. The total number of patients at each visit time point only counted the patients with valid values.



**Figure 39: Total Aortic Regurgitation (VI Population)**



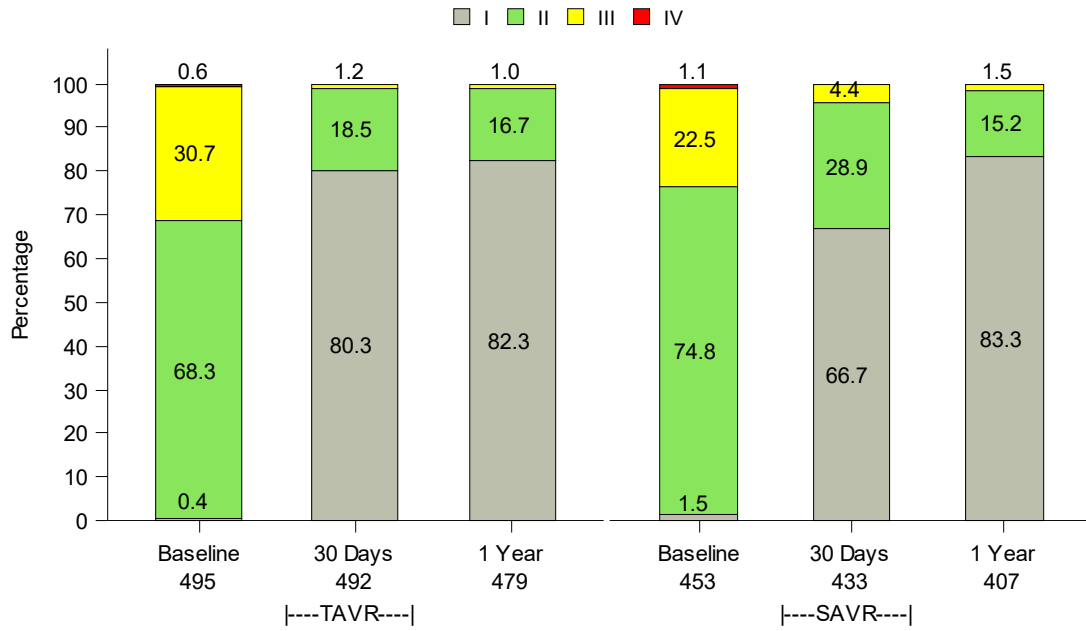
**Figure 40: Paravalvular Regurgitation (VI Population)**



**New York Heart Association (NYHA) Functional Class**

The NYHA classifications by visit are presented in Figure 41. At baseline, 31.3% of TAVR patients and 23.6% of SAVR patients were in NYHA III/IV. At 1 year the majority (~99%) of TAVR and SAVR patients were in NYHA Class I/II.

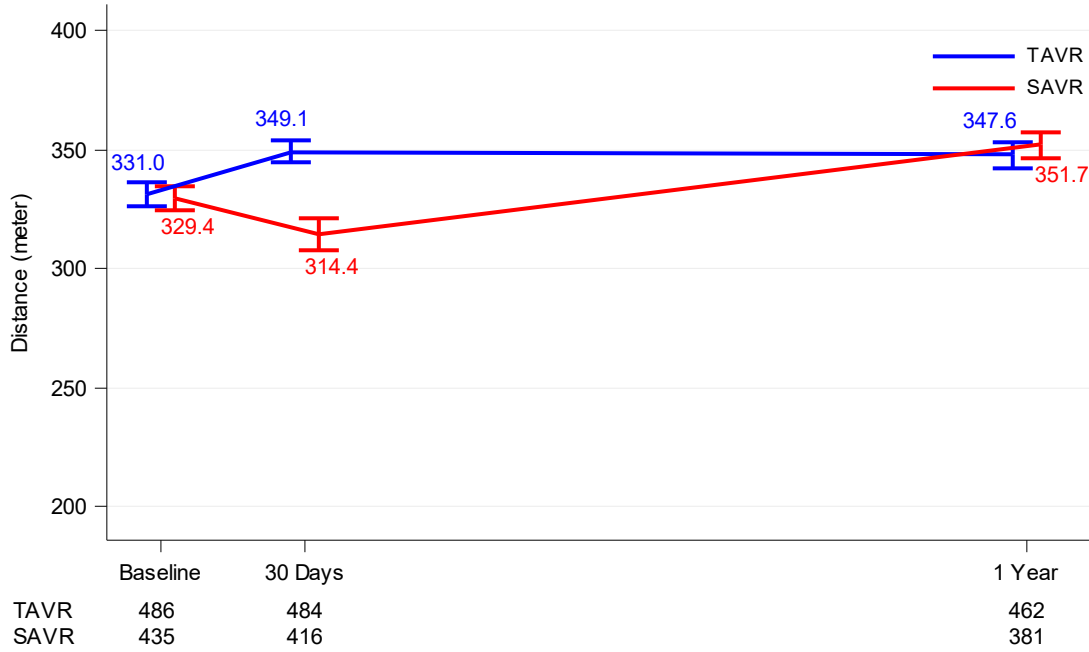
**Figure 41: NYHA Class by Visit (VI Population)**



**Six-Minute Walk Test (6MWT)**

The results for the 6MWT distance are presented in Figure 42. The TAVR patients showed an increase in mean 6MWT distance from 331.0 m at baseline to 349.1 m at 30 days, while SAVR patients showed a decrease from 329.4 m at baseline to 314.4 m at 30 days. The two cohorts had similar values at 1 year (347.6 m for TAVR and 351.7 m for SAVR).

**Figure 42: 6MWT Distance (VI Population)**



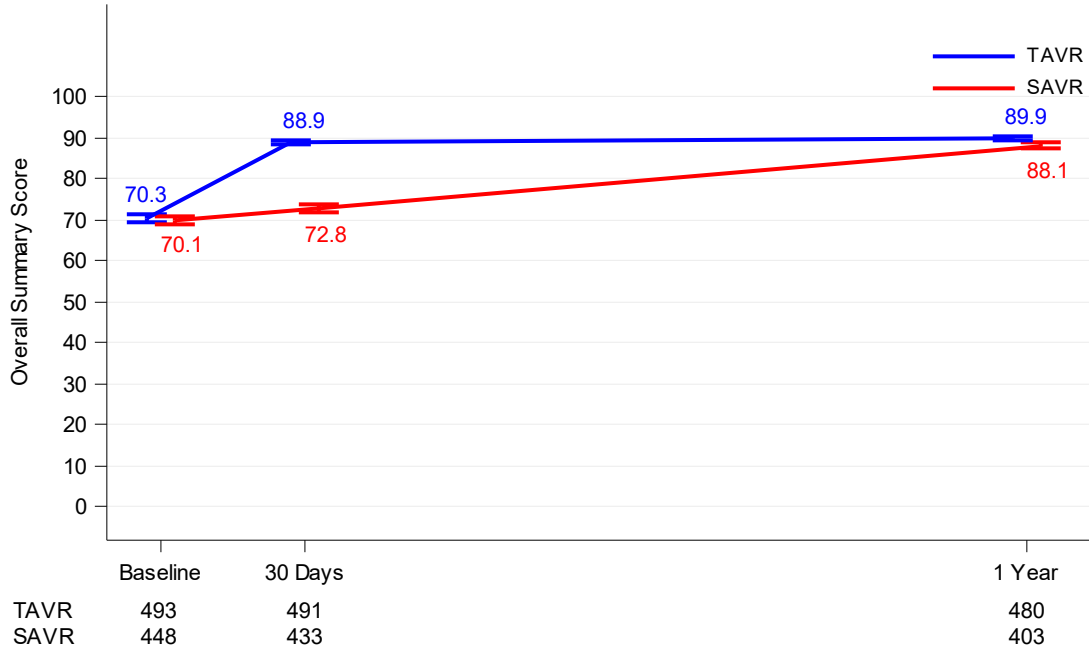
**Note:** Line plot with mean and standard error. The total number of patients at each visit time point only counted the patients with valid values.

### Quality of Life (QoL)

#### KCCQ

The results for the KCCQ overall summary score are presented in Figure 43. The mean score increased from 70.3 at baseline to 88.9 at 30 days and 89.9 at 1 year in TAVR patients and from 70.1 at baseline to 72.8 at 30 days and 88.1 at 1 year in SAVR patients.

**Figure 43: KCCQ Overall Summary Score (VI Population)**

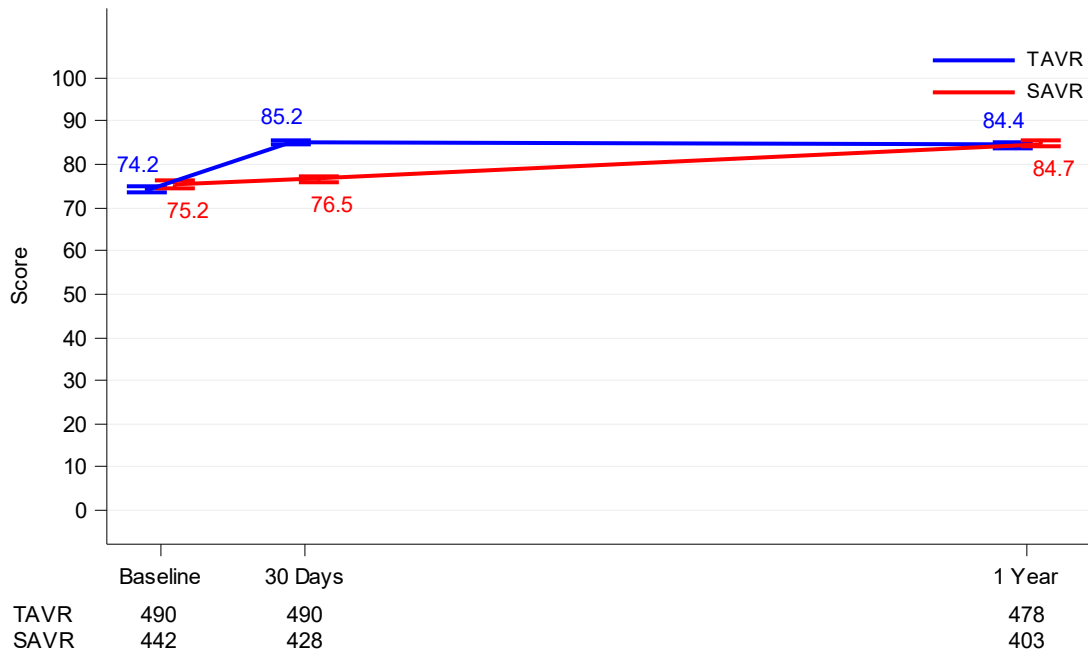


**Note:** Line plot with mean and standard error. The total number of patients at each visit time point only counted the patients with valid values.

### EuroQoI (EQ-5D)

The results for the EQ-5D visual analog score (VAS) are presented in Figure 44. The mean score was 74.2 at baseline, 85.2 at 30 days, and 84.4 at 1 year in TAVR patients as compared to 75.2 at baseline, 76.5 at 30 days, and 84.7 at 1 year in SAVR patients.

**Figure 44: EQ-5D Visual Analog Score (VI Population)**

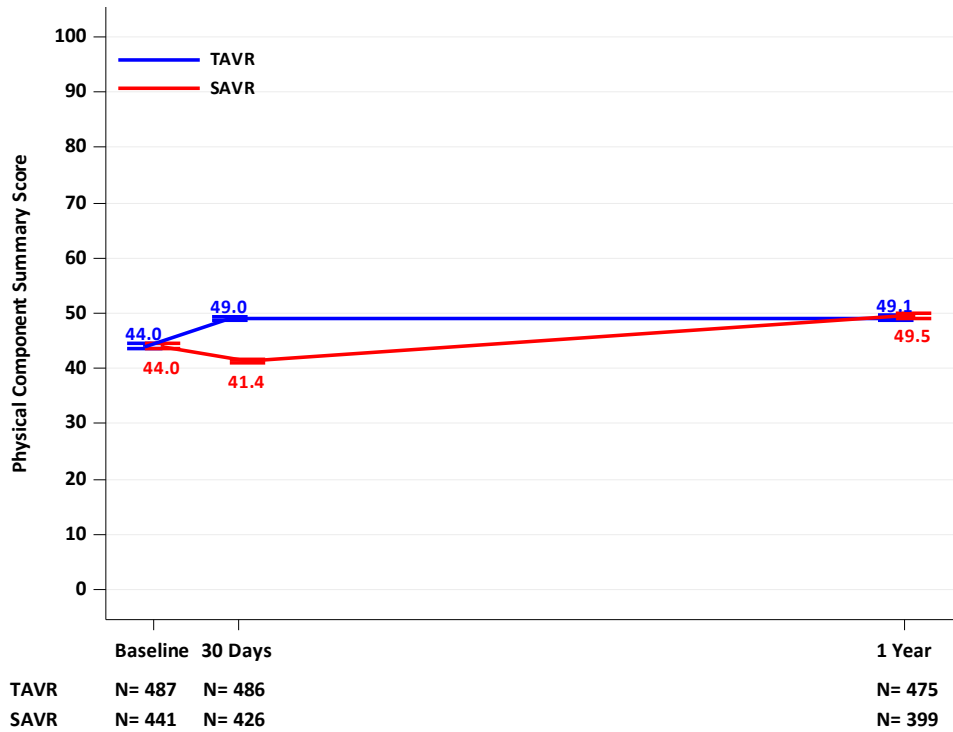


**Note:** Line plot with mean and standard error. The total number of patients at each visit time point only counted the patients with valid values.

### Short Form (SF)-36

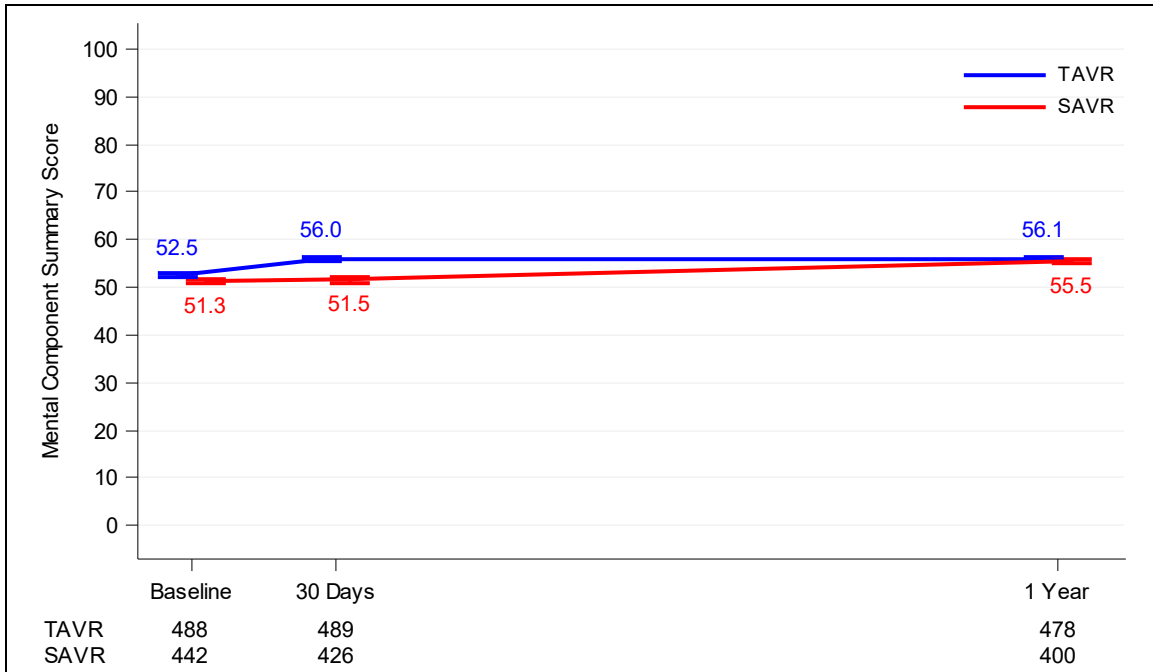
The results for the SF-36 physical component summary score and mental component summary score are presented in Figure 45 and Figure 46, respectively.

**Figure 45: SF-36 Physical Component Summary Score (VI Population)**



**Note:** Line plot with mean and standard error. The total number of patients at each visit time point only counted the patients with valid values.

**Figure 46: SF-36 Mental Component Summary  
(VI Population)**



**Note:** Line plot with mean and standard error. The total number of patients at each visit time point only counted the patients with valid values.

### 3. Adverse Events

The Kaplan-Meier estimates of the CEC-adjudicated adverse events through 1 year are presented in Table 34.

**Table 34: CEC-Adjudicated Adverse Events through 1 Year (AT Population)**

Event	Kaplan-Meier Rate*			
	30 Days		1 Year	
	TAVR (N=496)	SAVR (N=454)	TAVR (N=496)	SAVR (N=454)
All cause death	0.4% (2, 2)	1.1% (5, 5)	1.0% (5, 5)	2.5% (11, 11)
Cardiovascular death	0.4% (2, 2)	0.9% (4, 4)	0.8% (4, 4)	2.0% (9, 9)
All stroke	0.6% (3, 3)	2.4% (11, 11)	1.2% (6, 6)	3.1% (14, 14)
Disabling stroke	0.0% (0, 0)	0.4% (2, 2)	0.2% (1, 1)	0.9% (4, 4)
Non-disabling stroke	0.6% (3, 3)	2.0% (9, 9)	1.0% (5, 5)	2.2% (10, 10)
Death or stroke	1.0% (5, 5)	3.3% (16, 15)	1.8% (11, 9)	4.9% (25, 22)
Death or disabling stroke	0.4% (2, 2)	1.3% (7, 6)	1.0% (6, 5)	2.9% (15, 13)
Major vascular complications	2.2% (12, 11)	1.5% (8, 7)	2.8% (15, 14)	1.5% (8, 7)
Life-threatening / disabling, or major bleeding	3.6% (22, 18)	24.5% (123, 111)	7.7% (45, 38)	25.9% (132, 117)
Life-threatening / disabling bleeding	1.2% (9, 6)	11.9% (58, 54)	2.8% (17, 14)	12.8% (63, 58)
Major bleeding	2.6% (13, 13)	13.5% (65, 61)	5.3% (28, 26)	14.2% (69, 64)
Myocardial infarction	1.0% (5, 5)	1.3% (6, 6)	1.2% (6, 6)	2.2% (10, 10)
Requirement for renal replacement†	0.2% (1, 1)	0.7% (3, 3)	0.2% (1, 1)	0.7% (3, 3)
New permanent pacemaker implantation resulting from new or worsened conduction disturbances‡	6.5% (32, 32)	4.0% (18, 18)	7.3% (36, 36)	5.4% (24, 24)
Coronary obstruction requiring intervention	0.2% (1, 1)	0.7% (3, 3)	0.2% (1, 1)	0.7% (3, 3)
New onset atrial fibrillation	5.0% (21, 21)	39.5% (145, 145)	7.0% (29, 29)	40.9% (150, 150)
Rehospitalization <sup>  </sup>	3.4% (18, 17)	6.5% (30, 29)	7.3% (39, 36)	11.0% (59, 49)

\*Kaplan-Meier rate (no. of events, no. of patients with the event).

†Requirement for renal replacement was based on the site-reported event. All the other events were based on the CEC-adjudicated results.

‡Patients with pacemaker or ICD at baseline were not counted as new events.

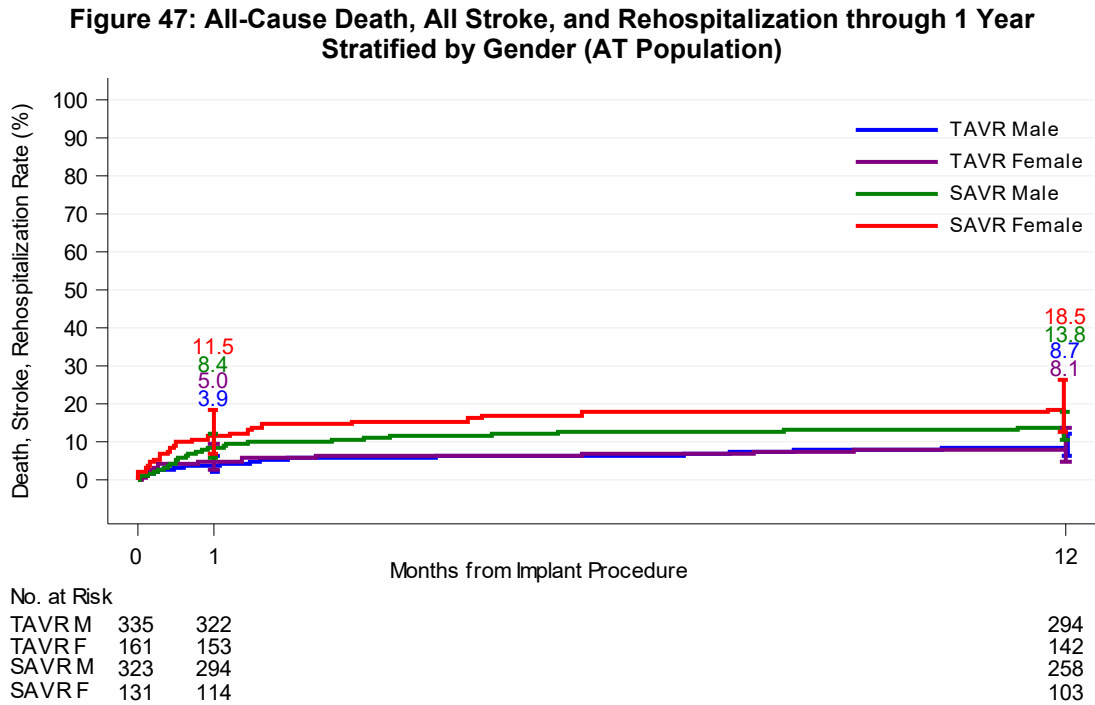
<sup>||</sup>Rehospitalization (valve-related or procedure-related and including heart failure).



4. Subgroup Analysis

Gender Analysis

The protocol specified a subgroup analysis on gender. The primary endpoint result stratified by gender is presented in Figure 47.



**Note:** The confidence intervals were calculated without multiplicity adjustment. The adjusted confidence intervals could be wider than presented here. As such, confidence intervals are provided to illustrate the variability only and should not be used to draw any statistical conclusion.

## 5. Other Study Observations

### Procedural Information

The general procedural data are summarized in Table 35. Conscious sedation was used in the majority of TAVR patients (65.1%). The mean procedure time was significantly lower for TAVR compared to SAVR (58.6 minutes vs. 208.3 minutes). There were less concomitant (planned) procedures performed for TAVR patients compared to SAVR patients (6.9% vs. 26.4%). Additional TAVR and SAVR specific procedural data are presented in Table 36 and 37, respectively.

**Table 35:  
General Procedural Data  
(AT Population)**

Variable	Summary Statistics*	
	TAVR (N=496)	SAVR (N=454)
Subject treated according to their treatment assignment	99.8% (495/496)	99.8% (453/454)
Procedure aborted	0	1
Subject was assigned to TAVR but received SAVR	1	0
Procedure time (min)	58.6 ± 1.6 (496)	208.3 ± 2.9 (454)
Anesthesia type		
General	33.3% (165/496)	100.0% (454/454)
Conscious sedation	65.1% (323/496)	NA
Conversion from conscious sedation to general anesthesia during the procedure	1.6% (8/496)	NA
Anesthesia time (min)	138.7 ± 2.20 (496)	309.7 ± 3.7 (454)
Concomitant procedures	6.9% (34/496)	26.4% (120/454)
Annular area (mm <sup>2</sup> )	473.5 ± 83.3 (486)	479.6 ± 87.6 (441)

\*Continuous measures – mean ± SE (n) for procedure and anesthesia time, mean ± SD (n) for annular area; Categorical measures - % (no./Total no.)

**Table 36:  
TAVR Procedure Data  
(AT Population)**

Variable	Summary Statistics*
	TAVR (N=496)
Valve size	
20 mm	2.2% (11/496)
23 mm	29.2% (145/496)
26 mm	47.6% (236/496)
29 mm	21.0% (104/496)
Successful access, delivery and retrieval of the device delivery system	99.8% (494/495)
Arterial access method	
Left percutaneous	22.2% (109/490)
Right percutaneous	76.7% (376/490)
Left surgical cutdown	0.0% (0/490)
Right surgical cutdown	1.0% (5/490)
Total fluoroscopy time (min)	13.9 ± 0.3 (487)
BAV performed	57.8% (286/495)
Post dilatation performed	20.9% (103/494)
Number of post dilatations	
1	89.3% (92/103)
2	8.7% (9/103)
3	1.9% (2/103)
More than one SAPIEN 3 THV implanted	0.2% (1/495)

\*Continuous measures - mean ± SE (n); categorical measures - % (no./Total no.).  
For patients in whom the procedure was aborted or who were converted to surgery, the rest of the procedure data except valve size were not collected.

**Table 37:  
SAVR Procedure Data  
(AT Population)**

Variable	Summary Statistics*
	SAVR (N=454)
Procedure aborted†	0.2% (1/454)
Valve size	
19 mm	2.9% (13/453)
21 mm	17.2% (78/453)
23 mm	36.6% (166/453)
25 mm	35.5% (161/453)
27 mm	6.8% (31/453)
29 mm	0.9% (4/453)
Total aortic cross clamp time (min)	74.3 ± 1.3 (453)
Total pump time (min)	97.7 ± 1.6 (453)
SAVR approach	
Sternotomy	95.4% (432/453)
Thoracotomy	0.9% (4/453)
Mini right upper thoracotomy	2.9% (13/453)
Port access	0.2% (1/453)
Other	0.7% (3/453)
Successful implantation of the surgical valve	100.0% (453/453)

\*Continuous measures - mean ± SE (n); categorical measures - % (no./Total no.).

†For patients in whom the procedure was aborted, the rest of the procedure data were not collected.

### **Computed Tomography (CT) Sub-Study**

There were 184 TAVR and 162 SAVR patients at 30 days and 160 and 134 patients at 1 year, respectively, who had at least one adequate CT for leaflet assessments. The HALT and leaflet mobility imaging findings are summarized in Table 38, along with the associated mean aortic pressure gradients. The mean aortic pressure gradients at 1 year stratified by HALT and leaflet mobility at 30 days are summarized in Table 39 and Table 40, respectively. The rate of death, stroke or TIA at 1 year stratified by HALT and leaflet mobility at 30 days are summarized in Table 41 and Table 42, respectively. The CT substudy was not powered to compare the relative incidence or the severity of HALT or reduced leaflet mobility between the TAVR and SAVR cohorts, or to determine whether late clinical outcomes were affected by the presence of HALT or reduced leaflet mobility.

**Table 38: HALT and Leaflet Mobility Findings and Associated Mean Gradients**

Findings	Summary Statistics*			
	30 Days		1 Year	
	TAVR (N=184)	SAVR (N=162)	TAVR (N=160)	SAVR (N=134)
Proportion of patients on oral anticoagulants at time of scan	6.0% (11/184)	21.0% (34/162)	8.1% (13/160)	13.4% (18/134)
<b>HALT<sup>†</sup></b>				
No thickening	84.8% (156/184)	95.7% (155/162)	74.4% (119/160)	82.1% (110/134)
Mean gradient (mmHg)	12.5 ± 0.3 (156)	10.8 ± 0.3 (155)	13.7 ± 0.4 (115)	11.7 ± 0.4 (106)
< 25% leaflet length thickened	4.9% (9/184)	1.2% (2/162)	11.3% (18/160)	7.5% (10/134)
Mean gradient (mmHg)	11.4 ± 0.9 (9)	16.5 ± NA (1)	12.9 ± 0.7 (18)	9.3 ± 1.8 (8)
25%-50% leaflet length thickened	3.3% (6/184)	1.9% (3/162)	6.3% (10/160)	5.2% (7/134)
Mean gradient (mmHg)	13.7 ± 1.7 (6)	9.4 ± 1.4 (3)	13.2 ± 1.8 (10)	15.1 ± 2.4 (7)
50%-75% leaflet length thickened	6.5% (12/184)	0.6% (1/162)	5.0% (8/160)	3.7% (5/134)
Mean gradient (mmHg)	15.2 ± 1.9 (12)	9.8 ± NA (1)	16.9 ± 3.3 (8)	16.1 ± 4.0 (5)
> 75% leaflet length thickened	0.5% (1/184)	0.6% (1/162)	3.1% (5/160)	1.5% (2/134)
Mean gradient (mmHg)	10.2 ± NA (1)	16.8 ± NA (1)	20.2 ± 6.2 (5)	9.0 ± 4.2 (2)
Number of leaflets with HALT	6.7% (37/552)	2.3% (11/486)	12.7% (61/480)	8.2% (33/402)
0 leaflets thickening	156	155	119	110
1 leaflet thickening	21	4	26	15
2 leaflets thickening	5	2	10	9
3 leaflets thickening	2	1	5	0
<b>Leaflet mobility<sup>‡</sup></b>				
Unrestricted	85.3% (145/170)	96.8% (149/154)	77.6% (118/152)	83.0% (108/129)
Mean gradient (mmHg)	12.2 ± 0.3 (145)	10.7 ± 0.3 (148)	13.3 ± 0.4 (114)	12.0 ± 0.5 (105)
Partially restricted, restriction limited to base	5.3% (9/170)	1.3% (2/154)	11.8% (18/152)	8.5% (11/129)
Mean gradient (mmHg)	11.4 ± 0.9 (9)	14.6 ± 1.9 (2)	12.5 ± 0.6 (18)	9.9 ± 1.6 (9)
Partially restricted (< 50%)	5.3% (9/170)	1.3% (2/154)	3.9% (6/152)	3.1% (4/129)
Mean gradient (mmHg)	15.5 ± 2.4 (9)	10.3 ± 0.5 (2)	14.0 ± 2.8 (6)	15.6 ± 3.0 (4)
Partially restricted (50%-75%)	3.5% (6/170)	0.0% (0/154)	4.6% (7/152)	3.9% (5/129)
Mean gradient (mmHg)	12.8 ± 1.7 (6)	NA	21.8 ± 3.9 (7)	11.3 ± 3.6 (5)
Largely immobile	0.6% (1/170)	0.6% (1/154)	2.0% (3/152)	0.8% (1/129)
Mean gradient (mmHg)	13.3 ± NA (1)	16.8 ± NA (1)	19.5 ± 8.1 (3)	13.1 ± NA (1)
<b>Number of leaflets partially restricted or largely immobile</b>				
0 leaflet	145	149	118	108
1 leaflet	21	2	22	13
2 leaflets	4	2	8	8
3 leaflets	0	1	4	0

\*Continuous measures - mean ± SE (n); categorical measures - % (no./Total no.). The analysis population included all the patients enrolled in the CT substudy and had at least one adequate CT for leaflet assessments.

†HALT was defined as: the presence of any hypopatterned leaflet thickening in any singular leaflet as identified by an independent CT core laboratory. The extent of the hypoattenuated leaflet thickening was graded with regards to the entire leaflet as: None, < 25%, 25-50%, 50-75%, or > 75%. If more than one leaflet had the appearance of HALT, the thickening measure of the most impacted leaflet was used. Presence of any degree of HALT on any one leaflet rendered a finding.

‡Leaflet mobility was determined by an independent CT core laboratory and included: unrestricted, partially restricted mobility limited to the base of a leaflet, partially restricted mobility involving more than the base of the leaflet but less than 50% of the leaflet, partially restricted mobility involving more than 50% of the leaflet but less than 75% of the leaflet, and/or a largely immobile leaflet. Presence of any degree of restriction or immobility on any one leaflet rendered a finding.

**Table 39: Mean Aortic Gradient at 1 Year Stratified by HALT at 30 Days**

	Summary Statistics*			
	HALT at 30 Days		No HALT at 30 Days	
	TAVR (N=28)	SAVR (N=7)	TAVR (N=156)	SAVR (N=155)
Mean gradient	13.6 ± 1.2 (24)	13.7 ± 2.7 (5)	13.6 ± 0.4 (137)	11.8 ± 0.4 (125)

\*Mean ± SE (n). The analysis population included all the patients enrolled in the CT substudy and had an adequate CT for leaflet assessments at 30 days.

**Table 40: Mean Aortic Gradient at 1 Year Stratified by Leaflet Mobility at 30 Days**

	Summary Statistics*			
	Reduced Leaflet Mobility at 30 Days		Unrestricted at 30 Days	
	TAVR (N=25)	SAVR (N=5)	TAVR (N=145)	SAVR (N=149)
Mean gradient	13.7 ± 1.28 (23)	14.2 ± 3.48 (4)	13.3 ± 0.4 (124)	11.7 ± 0.4 (119)

\*Mean ± SE (n). The analysis population included all the patients enrolled in the CT substudy and had an adequate CT for leaflet assessments at 30 days.

**Table 41: All-Cause Mortality, All Stroke or TIA at 1 Year Stratified by HALT at 30 Days**

1-Year Endpoint	Kaplan-Meier Rate*			
	HALT at 30 Days		No HALT at 30 Days	
	TAVR (N=28)	SAVR (N=7)	TAVR (N=156)	SAVR (N=155)
All-cause mortality	0.0% (0)	0.0% (0)	1.3% (2)	1.4% (2)
All stroke	0.0% (0)	0.0% (0)	0.7% (1)	0.0% (0)
TIA	5.6% (1)	0.0% (0)	1.3% (2)	0.0% (0)
All-cause mortality or all stroke or TIA	5.6% (1)	0.0% (0)	3.3% (5)	1.4% (2)

1-Year Endpoint	Kaplan-Meier Rate*			
	HALT at 30 Days		No HALT at 30 Days	
	TAVR (N=28)	SAVR (N=7)	TAVR (N=156)	SAVR (N=155)

\*Kaplan-Meier rate (no. of patients with event). The analysis population included all the patients enrolled in the CT substudy and had an adequate CT for leaflet assessments at 30 days. The Kaplan-Meier analysis used the CT test date as the start date in determining time to event. Presence of any degree of HALT on any one leaflet rendered a finding and inclusion in the HALT cohort.

**Table 42: All-Cause Mortality, All Stroke or TIA at 1 Year Stratified by Leaflet Mobility at 30 Days**

1-Year Endpoint	Kaplan-Meier Rate*			
	Reduced Leaflet Mobility at 30 Days		Unrestricted at 30 Days	
	TAVR (N=25)	SAVR (N=5)	TAVR (N=145)	SAVR (N=149)
All-cause mortality	0.0% (0)	0.0% (0)	0.0% (0)	0.0% (0)
All stroke	0.0% (0)	0.0% (0)	0.0% (0)	0.0% (0)
TIA	6.3% (1)	0.0% (0)	6.3% (1)	0.0% (0)
All-cause mortality or all stroke or TIA	6.3% (1)	0.0% (0)	3.6% (5)	1.4% (2)

\*Kaplan-Meier rate (no. of patients with event). The analysis population included all the patients enrolled in the CT substudy and an adequate CT for leaflet assessments at 30 days. The Kaplan-Meier analysis used the CT test date as the start date in determining time to event. Reduced leaflet mobility included any of the following assessments: partially restricted limited to base, partially restricted involving more than the base but less than 50% of the leaflet, partially restricted involving more than 50% but less than 75% of the leaflet, and/or largely immobile. Presence of any degree of restriction or immobility on any one leaflet rendered a finding and inclusion in the reduced leaflet mobility cohort.

**SAPIEN 3 THV IN BICUSPID AORTIC VALVE FOR PATIENTS AT INTERMEDIATE OR GREATER SURGICAL RISK – STS/ACC TRANSCATHETER VALVE THERAPY REGISTRY (TVTR) ANALYSIS**

**Patient Accountability**

At the time of database extract, of the 545 patients in the bicuspid aortic valve cohort, 527 patients were eligible for the 30-day visit, and 486 (92.2%) patients paid a visit within the 30-day follow-up window defined as the period between 21 and 75 days post-procedure. Of the 465 patients eligible for the 1 year visit, 309 (66.5%) paid a visit within the 1 year follow-up window defined as the period between 305 and 425 days post-procedure. A detailed summary of the patient accountability at 30 days and 1 year is shown in Table 43.

**Table 43:  
Patient Visit Accountability**

	30-day Visit	1-year Visit
Total patients	545	545
Non-eligible*	18	80
-Death	14	43
-Withdrawal	2	8
-Lost to follow-up	2	29

	30-day Visit	1-year Visit
-Visit not yet due‡	0	0
Eligible	527	465
-Follow-up visit completed	486 (92.2%)	309 (66.5%)
-Missed visit†	41 (7.8%)	156 (33.5%)

\* This includes all patients who exited the study prior to the end of the follow-up visit window and those who have not had the visit.

‡ Patients have not reached the end of the visit window and have not completed the follow-up visit yet.

† Data extract date has exceeded the end of the visit window and the patients have not reported the visit data.

The “Attempted Implant” population consisted of all patients entered into the registry with a bicuspid aortic valve. The “Valve Implant” population consisted of those patients for whom the valve implant procedure has started and a “No” was indicated for both “procedure aborted” and “conversion to open heart surgery.” The “Valve Implant” population consists of 540 patients as 5 patients were converted to open heart surgery and did not receive the SAPIEN 3 transcatheter heart valve.

### Patient Demographics and Baseline Characteristics

The demographics and baseline characteristics of bicuspid aortic valve patients, as shown in Table 44, present a multimorbid cohort of patients with a mean STS score of  $5.5 \pm 4.0$ .

**Table 44:**  
**Patient Demographics and Baseline Characteristics - Bicuspid Population**  
**(Attempted Implant Population)**

Demographics and Baseline Characteristics	Summary Statistics*
Age - years	73.4 $\pm$ 11.1 (545)
Male sex	349 / 545
Society of Thoracic Surgeons (STS) score	5.5 $\pm$ 4.0 (538)
New York Heart Association (NYHA) class	
I/II	106 / 535 (19.8%)
III/IV	429 / 535 (80.2%)
Previous myocardial infarction	119 / 544 (21.9%)
Previous intervention	
Coronary artery bypass grafting (CABG)	101 / 543 (18.6%)
Percutaneous coronary intervention (PCI)	138 / 545 (25.3%)
Prior aortic valvuloplasty	34 / 545 (6.2%)
Cerebrovascular accident (CVA)	56 / 545 (10.3%)
Peripheral vascular disease	128 / 544 (23.5%)
Atrial fibrillation	183 / 545 (33.6%)
Permanent pacemaker	54 / 545 (9.9%)
Porcelain aorta	12 / 545 (2.2%)
Hostile chest	44 / 545 (8.1%)
Echocardiographic findings (Valve Implant Population)	
Valve area - cm <sup>2</sup>	0.7 $\pm$ 0.2 (524)
Mean aortic valve gradient - mmHg	44.9 $\pm$ 15.5 (535)
Mean left ventricular ejection fraction (LVEF) %	52.9 $\pm$ 15.5 (534)



Demographics and Baseline Characteristics	Summary Statistics*
Moderate or severe aortic regurgitation	91 / 536 (17.0%)
Moderate or severe mitral regurgitation	101 / 438 (23.1%)

\*Continuous measures - Mean ± SD (Total no.); categorical measures - n. / Total no. (%).

## Safety and Effectiveness Results

### Safety Endpoints

The mortality rates at discharge, 30 days, one-year and the Kaplan-Meier curve for all-cause mortality are shown in Table 45 and Figure 48, respectively. There were a total of 12 deaths reported at 30 days and 43 deaths reported at one year.

**Table 45:**  
**Death Rate - Bicuspid Population (Attempted Implant Population)**

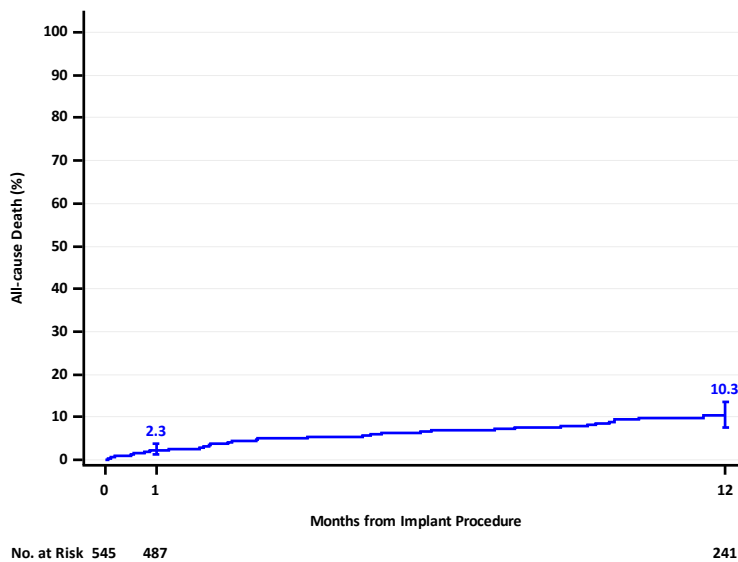
	Discharge*	30 Days†	1 Year†
All-cause death‡	1.8% (10)	2.3% (12)	10.3% (43)
Cardiac death	1.1% (6)	1.3% (7)	3.0% (13)

\*Observed rate - % (n).

† Kaplan-Meier estimate - % (n)

‡ Includes all deaths reported in TVTR and identified through CMS linkage.

**Figure 48:**  
**All-Cause Death Rate - Bicuspid Population (Attempted Implant Population)**



The DCRI adjudicated events, including all strokes, TIAs and aortic valve reinterventions at discharge, 30 days and one year are shown in Table 46.

**Table 46:  
Duke Clinical Research Institute Adjudicated Events - Bicuspid Population  
(Attempted Implant Population)**

<b>Events</b>	<b>Discharge*</b>	<b>30 Days†</b>	<b>1 Year†</b>
All strokes	1.5% (8, 8)	1.9% (10, 10)	2.7% (13, 13)
Ischemic stroke	1.5% (8, 8)	1.9% (10, 10)	2.7% (13, 13)
Hemorrhagic stroke	0.0% (0, 0)	0.0% (0, 0)	0.0% (0, 0)
Transient ischemic attack (TIA)	0.2% (1, 1)	0.2% (1, 1)	0.2% (1, 1)
Aortic valve reintervention	0.2% (1, 1)	0.2% (1, 1)	0.8% (3, 3)

\*Observed rate - % (no. of events, no. of subjects with the event)

†Kaplan-Meier estimate - % (no. of events, no. of subjects with the event)

Note: At the time of this extract, there is one stroke and one aortic valve reintervention that are pending adjudication.

### Site Reported Adverse Events

The site reported adverse events at discharge, 30 days and one year for the bicuspid population are shown in Table 47.

**Table 47:  
Site Reported Adverse Events - Bicuspid Population  
(Attempted Implant Population)**

<b>Events</b>	<b>Discharge*</b>	<b>30 Days†</b>	<b>1 Year†</b>
Non-valve related readmission	NA‡	8.7% (50, 45)	26.8% (164, 110)
Conduction/native pacemaker disturbance req pacemaker	7.3% (40, 40)	8.6% (46, 46)	9.7% (50, 50)
Minor vascular complication	4.6% (25, 25)	5.0% (28, 27)	5.0% (28, 27)
Unplanned vascular surgery or intervention	3.5% (19, 19)	3.5% (19, 19)	3.8% (20, 20)
Cardiac arrest	2.9% (16, 16)	3.0% (16, 16)	3.0% (16, 16)
Atrial fibrillation	2.4% (13, 13)	2.4% (13, 13)	2.4% (13, 13)
Hematoma at access site	2.2% (12, 12)	2.2% (12, 12)	2.2% (12, 12)
Ischemic Stroke	1.5% (8, 8)	2.0% (11, 11)	2.6% (13, 13)
Other bleed	2.0% (12, 11)	2.0% (12, 11)	2.0% (12, 11)
Unplanned other cardiac surgery or intervention	1.3% (7, 7)	1.9% (10, 10)	3.3% (16, 15)
Bleeding at access site	1.8% (10, 10)	1.8% (10, 10)	1.8% (10, 10)
Major vascular complication	1.1% (6, 6)	1.1% (6, 6)	1.1% (6, 6)
Perforation with or w/o tamponade	1.1% (6, 6)	1.1% (6, 6)	1.1% (6, 6)
Myocardial infarction	0.7% (4, 4)	0.9% (5, 5)	1.5% (7, 7)
Percutaneous coronary intervention (PCI)	0.7% (5, 4)	0.9% (6, 5)	1.2% (7, 6)
Valve Related Readmission	NA‡	0.8% (5, 4)	2.1% (12, 9)
Coronary Compression or Obstruction	0.7% (4, 4)	0.7% (4, 4)	0.7% (4, 4)
New requirement for dialysis	0.4% (2, 2)	0.6% (3, 3)	0.9% (4, 4)
Major Bleeding Event	NA‡	0.4% (2, 2)	1.3% (6, 5)
Conduction/native pacemaker disturbance requiring implantable cardioverter defibrillator (ICD)	0.2% (1, 1)	0.4% (2, 2)	1.6% (6, 6)

Events	Discharge*	30 Days†	1 Year†
Genitourinary (GU) Bleed	0.4% (2, 2)	0.4% (2, 2)	0.4% (2, 2)
Annular Dissection	0.4% (2, 2)	0.4% (2, 2)	0.4% (2, 2)
Aortic Valve Reintervention	0.2% (1, 1)	0.2% (1, 1)	1.0% (4, 4)
Transient Ischemic Attack	0.2% (1, 1)	0.2% (1, 1)	0.2% (1, 1)
Aortic Dissection	0.2% (1, 1)	0.2% (1, 1)	0.2% (1, 1)
Device recapture or retrieval	0.2% (1, 1)	0.2% (1, 1)	0.2% (1, 1)
Retroperitoneal bleeding	0.2% (1, 1)	0.2% (1, 1)	0.2% (1, 1)
Endocarditis	0.0% (0, 0)	0.0% (0, 0)	0.6% (2, 2)
Device Thrombosis	0.0% (0, 0)	0.0% (0, 0)	0.2% (1, 1)
Undetermined Stroke	0.0% (0, 0)	0.0% (0, 0)	0.3% (1, 1)

\*Observed rate - % (no. of events, no. of subjects with the event)

† Kaplan-Meier estimate - % (no. of events, no. of subjects with the event)

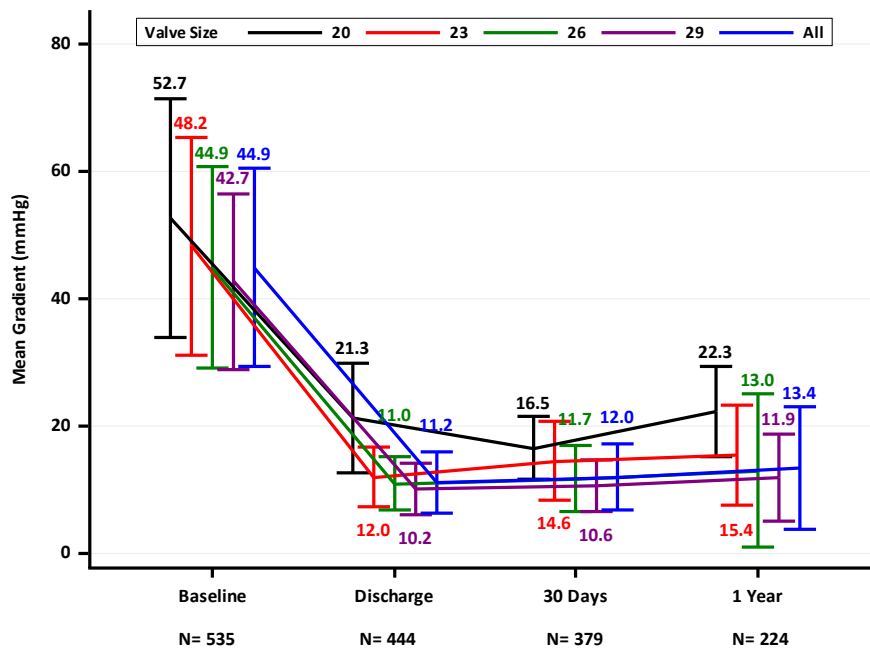
‡ N/A = Event not collected on case report form at the time period. % (no. of events, no. of subjects with the event)

## Effectiveness Endpoints

### Valve Performance

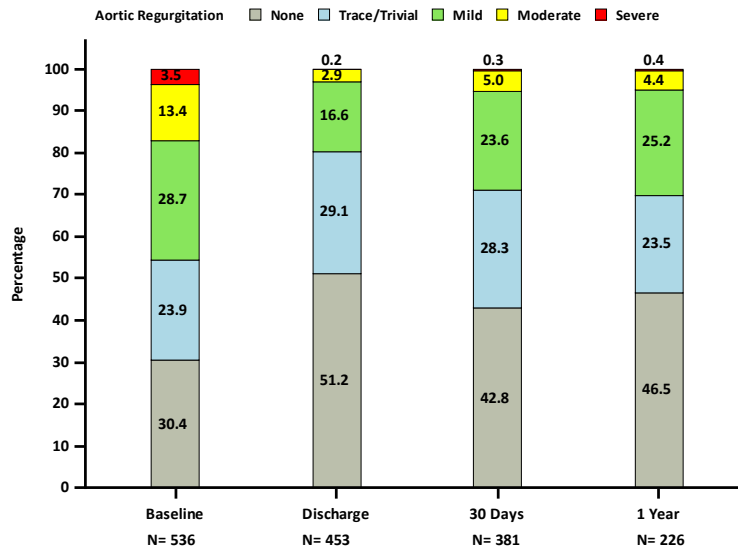
The bicuspid aortic valve echocardiographic performance data are summarized in Figures 49-51. The mean gradients  $44.9 \pm 15.5$  mmHg at baseline to  $12.0 \pm 5.2$  mmHg at 30 days and  $13.4 \pm 9.6$  mmHg at one year. Moderate/severe PVL was observed in 4.8% of the patients at 30 days and 5.1% of the patients at one year.

**Figure 49:**  
**Aortic Mean Gradient - Bicuspid Population**  
**(Valve Implant Population)**



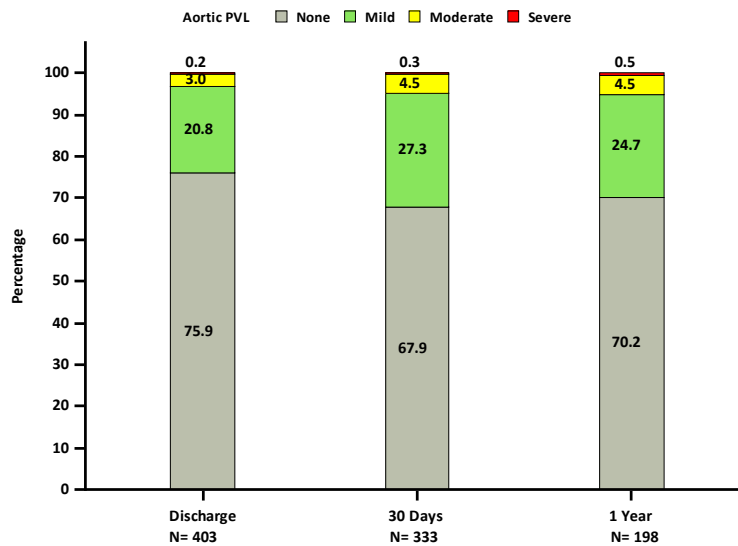
Note: Line plot with mean and standard deviation. The total number of patients at each time point only counted the patients with valid values.

**Figure 50:  
Aortic Regurgitation - Bicuspid Population  
(Valve Implant Population)**



Note: The total number of patients at each time point only counted the patients with valid values.

**Figure 51:  
Aortic Paravalvular Leak - Bicuspid Population  
(Valve Implant Population)**

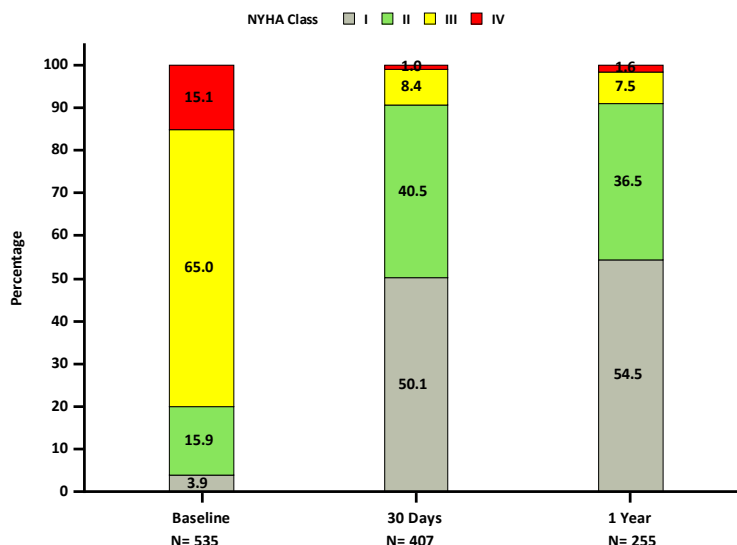


Note: The total number of patients at each time point only counted the patients with valid values.

### NYHA Class

The NYHA class distributions at baseline, 30-day visit and one-year visit and the NYHA class changes from baseline to the 30-day visit and to one-year visit are shown in Figure 52 and Table 48, respectively. The majority (84.0% and 82.5%) of the patients had an improved NYHA class at the 30-day visit and one year visit, respectively.

**Figure 52:  
NYHA Functional Class - Bicuspid Population  
(Valve Implant Population)**



Note: The total number of patients at each time point only counted the patients with valid values.

**Table 48:  
NYHA Changes - Bicuspid Population  
(Valve Implant Population)**

	NYHA Class Change*		
	Improved	Same	Worsened
Baseline to 30-day visit	340/405 (84.0%)	54/405 (13.3%)	11/405 (2.7%)
Baseline to 1-year visit	208/252 (82.5%)	32/252 (12.7%)	12/252 (4.8%)

\*n/Total no. (%); the total no. only counted the patients with valid values.

### Five Meter Walk Test

The results of the five-meter walk test are summarized in Table 49.

**Table 49:  
Five-Meter Walk Test - Bicuspid Population  
(Valve Implant Population)**

Visit	Five Meter Walk Time(seconds)*
Baseline	8.0 ± 4.8 (411)
30-day visit	6.7 ± 2.8 (119)
Change from baseline to 30-day visit	-1.2 ± 3.5 (101)
1-year visit	6.2 ± 2.4 (43)
Change from baseline to 1-year visit	-1.6 ± 3.6 (35)

\*Mean ± SD (Total no.). The total number of patients at each time point only counted the patients with valid values.

## Length of Stay

The mean index hospitalization stay was 4.7 days, which included an average of 1.6 days in the intensive care unit (ICU), as summarized in Table 50.

**Table 50:**  
**Index Hospitalization Stay - Bicuspid Population**  
**(Attempted Implant Population)**

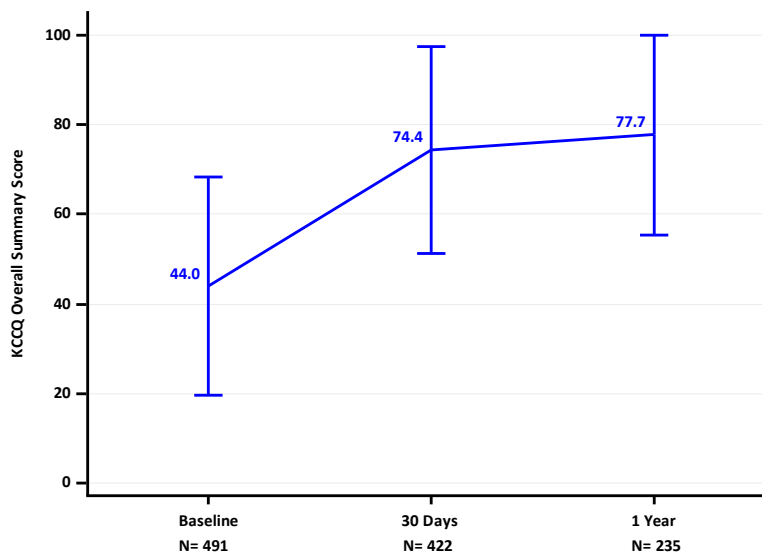
	Length (days)*
Index hospitalization duration (day)	4.7 ± 3.8 (545)
Intensive care stay (day)	1.6 ± 2.6 (537)

\*Mean ± SD (Total no.).

## Quality of Life (QoL)

The QoL at baseline, 30 days and one year as measured by the KCCQ overall summary score, is shown in Figure 53. The mean KCCQ summary score improved from 44.0 at baseline to 77.7 at one year.

**Figure 53:**  
**KCCQ Overall Summary - Bicuspid Population**  
**(Valve Implant Population)**



Note: Line plot with mean and standard deviation. The total number of patients at each time point only counted the patients with valid values.

## Procedural Information

The procedure information is presented in Table 51. The most common delivery approach for the bicuspid population was the transfemoral approach, which was used in 94.7% (516/545) of cases, followed by the transapical and transaortic in 1.3% (7/545) and 1.3% (7/545) of cases, respectively, and other alternative approaches (subclavian, transcarotid, and other) in 2.8% (15/545). The device was successfully implanted in 539/544 (99.1%) of patients; five patients were converted to open heart surgery 0.9% (5/545) due to ventricular rupture (1 patient), annulus rupture (1 patient), coronary occlusion (1 patient) and other (2 patients). There were no cases of valve embolization. Device implant success is defined as correct positioning of a single prosthetic heart valve in the proper anatomical location.

**Table 51:  
Procedural Data Summary - Bicuspid Population  
(Attempted Implant Population)**

	<b>Summary Statistics*</b>
<b>Operator reason for procedure</b>	
Inoperable/Extreme risk	115/545 (21.1%)
High risk	394/545 (72.3%)
Intermediate risk	24/545 (4.4%)
Low risk	12/545 (2.2%)
<b>Implant approach</b>	
Transfemoral	516/545 (94.7%)
Transapical	7/545 (1.3%)
Transaortic	7/545 (1.3%)
Subclavian/axillary	9/545 (1.7%)
Transcarotid	3/545 (0.6%)
Other	3/545 (0.6%)
<b>Procedure status</b>	
Elective	497/545 (91.2%)
Urgent	47/545 (8.6%)
Emergency	1/545 (0.2%)
<b>Valve size</b>	
20 mm	16/545 (2.9%)
23 mm	95/545 (17.4%)
26 mm	220/545 (40.4%)
29 mm	214/545 (39.3%)
<b>Primary procedure indication</b>	
Aortic stenosis (Primary)	535/545 (98.2%)
Aortic insufficiency (Primary)	1/545 (0.2%)
Mixed aortic stenosis/aortic insufficiency	9/545 (1.7%)
<b>Cardiopulmonary bypass (CPB)</b>	
CPB status	
Elective	2/5 (40.0%)
Emergent	3/5 (60.0%)
CPB time (min)	52.2 ± 24.2 (5)
<b>Type of anesthesia</b>	
General anesthesia	389/545 (71.4%)

	<b>Summary Statistics*</b>
Moderate sedation	151/545 (27.7%)
Epidural	1/545 (0.2%)
Combination	4/545 (0.7%)
Total procedure time (min)	109.3 ± 49.5 (545)
Fluoroscopy time (min)	19.9 ± 10.4 (528)
Device implanted successfully	539/544 (99.1%)
Procedure aborted	0/545 (0.0%)
Conversion to open heart surgery	5/545 (0.9%)
Ventricular rupture	1/5 (20.0%)
Annulus rupture	1/5 (20.0%)
Coronary occlusion	1/5 (20.0%)
Other	2/5 (40.0%)
Mechanical assist device in place at start of procedure	5/545 (0.9%)
Intra-aortic balloon pump (IABP)	3/5 (60.0%)
Catheter based assist device	2/5 (40.0%)

\*Categorical measures – no./Total no. (%); continuous measures - mean ± SD (Total no.). The total no. only counted the patients with valid values at the time point.

### **SAPIEN 3 THV IN BICUSPID AORTIC VALVE FOR PATIENTS AT LOW SURGICAL RISK – PARTNER 3 BICUSPID REGISTRY ANALYSIS**

#### **A. Patient Accountability**

At the time of the database lock, a total of 75 patients were enrolled in the registry.

There were three different analysis populations reflective of the single-arm study design: All Enrolled, Attempted Implant (AI), and Valve Implant (VI), which are defined in Table 52.

**Table 52: Analysis Populations**

<b>Analysis Population</b>	<b>Definition</b>	<b>Number of Patients</b>
All Enrolled	All patients who were approved by the Case Review Board and enrolled in the study.	75
Attempted Implant (AI)	All enrolled patients in whom the index procedure had begun, whether or not the procedure was completed.	71
Valve Implant (VI)	All AI patients who received and retained the study valve during the index procedure.	71



The overall follow-up compliance of the registry is summarized in Table 53.

**Table 53: Bicuspid Registry Study Compliance (AI Population)**

Patient Disposition and Visit Status	30-Day Visit	1-Year Visit
Total patients	71	71
Ineligible*	0	1
Death	0	1
Withdrawn	0	0
Lost to follow-up	0	0
Exit with other reason	0	0
Eligible†	71	70
Follow-up visit completed	71 (100.0%)	69 (97.2%)

\*Ineligible includes patients who exited the study prior to the visit or had a pending visit status

†Eligible patients = analysis population N – ineligible patients.

### **B. Study Population Demographics and Baseline Characteristics**

The demographics and baseline characteristics of the study population are typical for a TAVR study performed in the U.S., as shown in Table 54.

**Table 54: Patient Demographics and Baseline Characteristics (AI Population)**

Demographics and Baseline Characteristics	Summary Statistics* (N=71)
Age (years)	68.5 ± 6.6
Gender	
Male	69.0% (49/71)
Female	31.0% (22/71)
Society of Thoracic Surgeons (STS) score (%)	1.4 ± 0.59
New York Heart Association (NYHA) class	
I/II	76.1% (54/71)
III/IV	23.9% (17/71)
Previous myocardial infarction	7.0% (5/71)
Previous intervention	
Coronary artery bypass grafting (CABG)	0.0% (0/71)
Percutaneous coronary intervention (PCI)	7.0% (5/71)
Stroke or cerebrovascular accident (CVA)	2.8% (2/71)
Peripheral vascular disease (PVD)	5.6% (4/71)
Atrial fibrillation	4.2% (3/71)
Permanent pacemaker or defibrillator	1.4% (1/71)
Hostile chest	0.0% (0/71)
Echocardiographic findings	
Valve area (cm <sup>2</sup> )	0.7 ± 0.2 (65)
Mean gradient (mmHg)	56.1 ± 15.5 (71)

Demographics and Baseline Characteristics	Summary Statistics* (N=71)
Mean left ventricular ejection fraction (LVEF), %	64.0 ± 11.1 (66)
Moderate or severe aortic regurgitation	5.6% (4/71)
Moderate or severe mitral regurgitation	1.4% (1/70)
Morphology	
Bicuspid Sievers Type 0	14.1% (10/71)
Bicuspid Sievers Type 1	84.5% (60/71)
Bicuspid Sievers Type 2	1.4% (1/71)

\* Continuous measures - mean ± SD (Total no.); Categorical measures - % (no./Total no.)

### C. Safety and Effectiveness Results

#### 1. Primary Endpoint

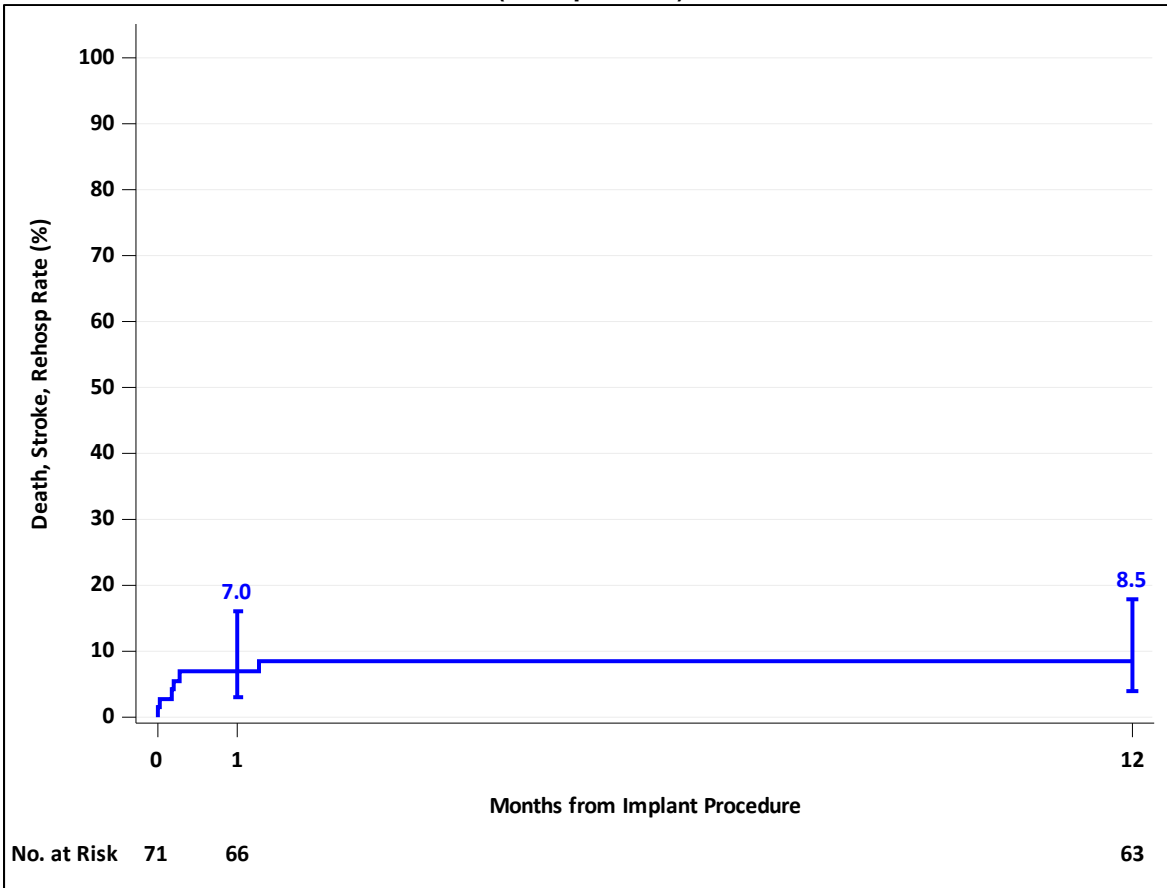
The primary endpoint results are presented in Table 55 and Figure 54. The rate of all-cause death, all stroke, and rehospitalization (valve-related or procedure-related and including heart failure) at 1 year was 8.5%.

**Table 55: Primary Endpoint Analysis (AI Population)**

Endpoint	Kaplan-Meier Rate* (N=71)
All-cause death, all stroke, or rehospitalization	8.5% (7, 6)
All-cause death	1.4% (1, 1)
All stroke	2.8% (2, 2)
Rehospitalization	5.6% (4, 4)

\*Kaplan-Meier rate (no. of events, no. of patients with the event).

**Figure 54: All-Cause Death, All Stroke, and Rehospitalization through 1 Year (AI Population)**



**Note:** Vertical bar represents 95% confidence interval. The confidence intervals are calculated without multiplicity adjustment. The adjusted confidence intervals could be wider than presented here. As such, confidence intervals are provided to illustrate the variability only and should not be used to draw any statistical conclusion.

## 2. Secondary Endpoints

A summary of the secondary endpoints is shown in Table 56. No formal statistical tests were performed.

**Table 56: Secondary Endpoints Analysis (AI Population)**

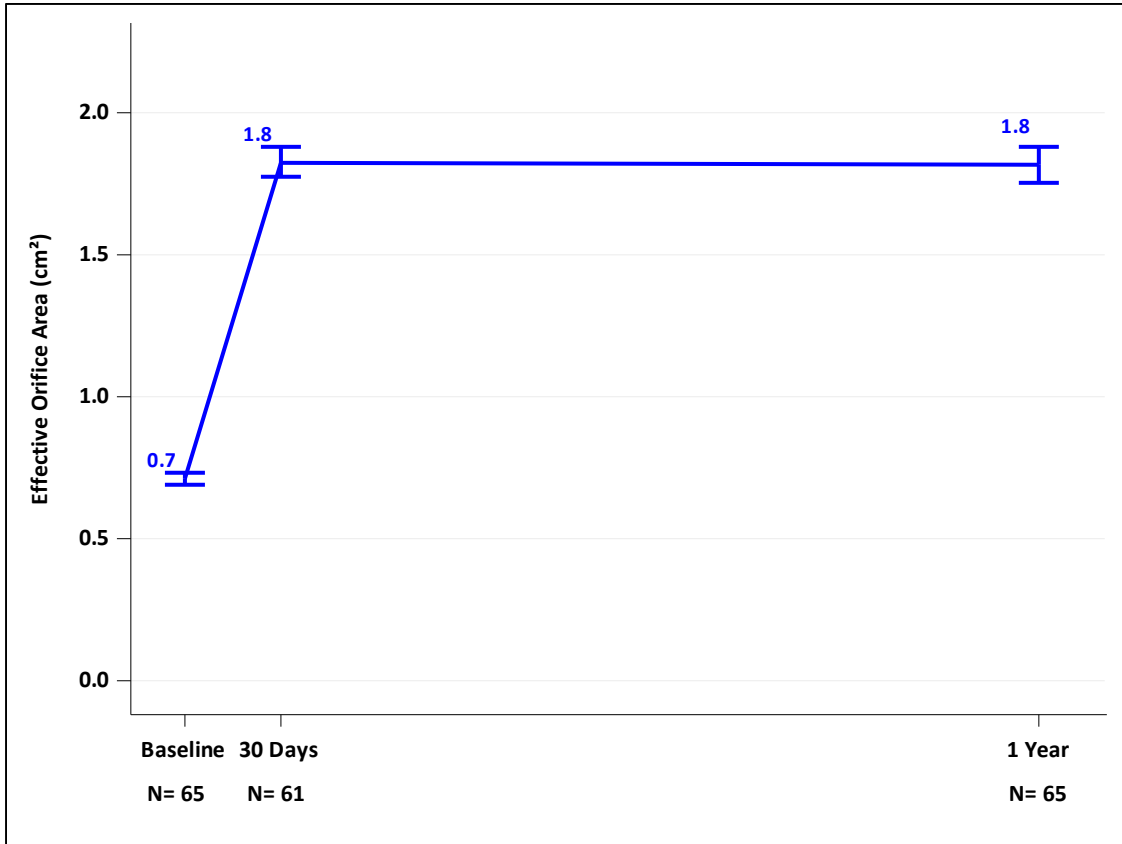
No.	Endpoint	Summary Statistics*
1	New onset atrial fibrillation at 30 days	4.2% (3/71)
2	Length of index hospitalization (days)	2.6 ± 0.1 (71)
3	Death, KCCQ < 45 or KCCQ decrease from baseline ≥ 10 points at 30 days	1.4% (1/71)
4	Death or all stroke at 30 days	2.8% (2/71)
5	All stroke at 30 days	2.8% (2/71)

\*Continuous measures - mean ± SE (Total no.); Categorical measures – observed rate, % (no./Total no.)

### Valve Performance

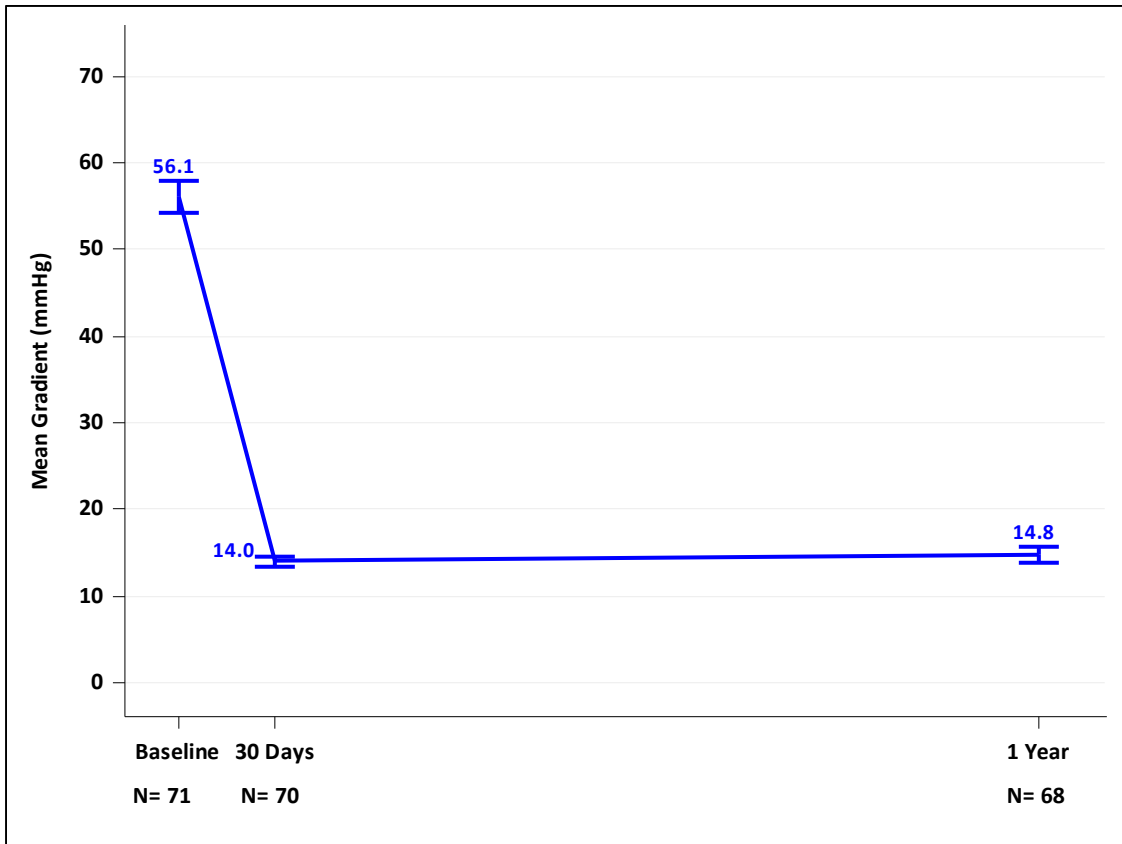
The increase in EOA and decrease in gradient were sustained through 1 year. The proportion of patients with total AR ≥ moderate was 1.4% at 30 days and 1.5% at 1 year. The proportion of patients with paravalvular regurgitation ≥ moderate was 1.4% at 30 days and 0.0% at 1 year. Prosthesis patient mismatch (PPM) was measured per VARC-2. The percentages of patients with moderate and severe PPM were 21.5% and 9.2%, respectively. However, no deaths were reported in these patients at 1 year. It should be noted that there are limitations in echocardiogram measurement of PPM in TAVR patients, such as errors in stroke volume calculation, inherent limitations in the Bernoulli equation for deriving post-implant gradients, which will overstate the degree of PPM. Relying on the echocardiogram-derived iEOA alone to estimate PPM without taking into consideration the aortic valve velocity and gradient will lead to conflicting PPM assessment and outcomes post-TAVR<sup>[4]</sup>. Accounting for pressure recovery, using predicted versus measured iEOA, and using more accurate CT-LVOT area measurement may be required in the assessment of PPM and prosthetic valve function. Thus, interpretation of the PPM rate should take into consideration the current methodological limitations in PPM measurement and the totality of the clinical outcomes data of the device.

Figure 55: Effective Orifice Area (VI Population)



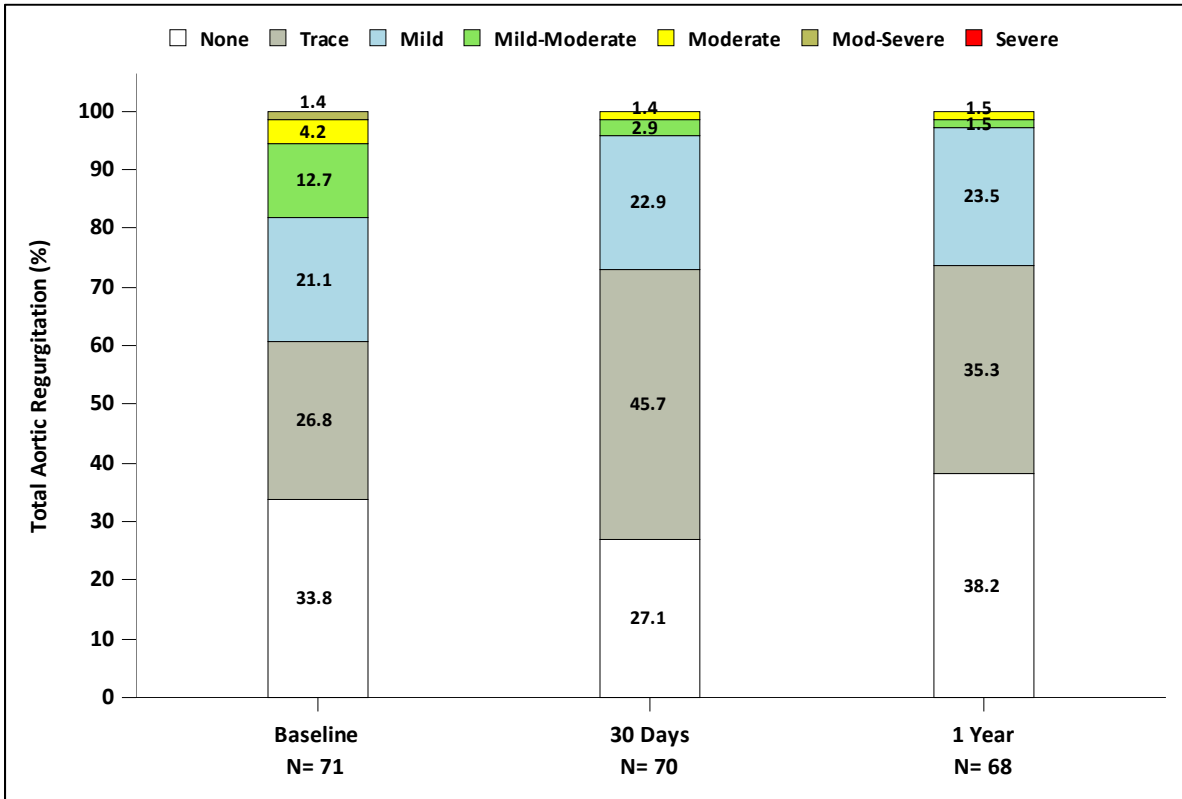
**Note:** Line plot with mean and standard error. The total number of patients at each visit time point only counted the patients with valid values.

**Figure 56: Mean Aortic Gradient (VI Population)**

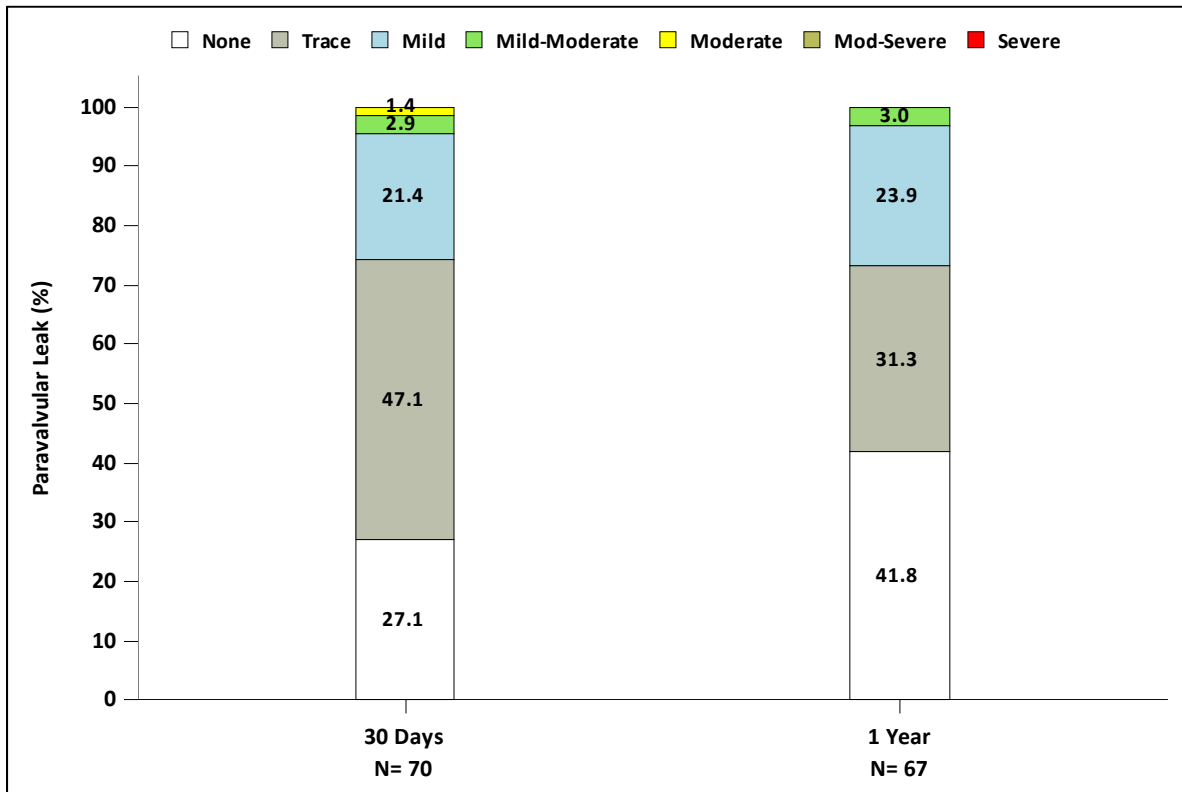


**Note:** Line plot with mean and standard error. The total number of patients at each visit time point only counted the patients with valid values.

**Figure 57: Total Aortic Regurgitation (VI Population)**



**Figure 58: Paravalvular Regurgitation (VI Population)**

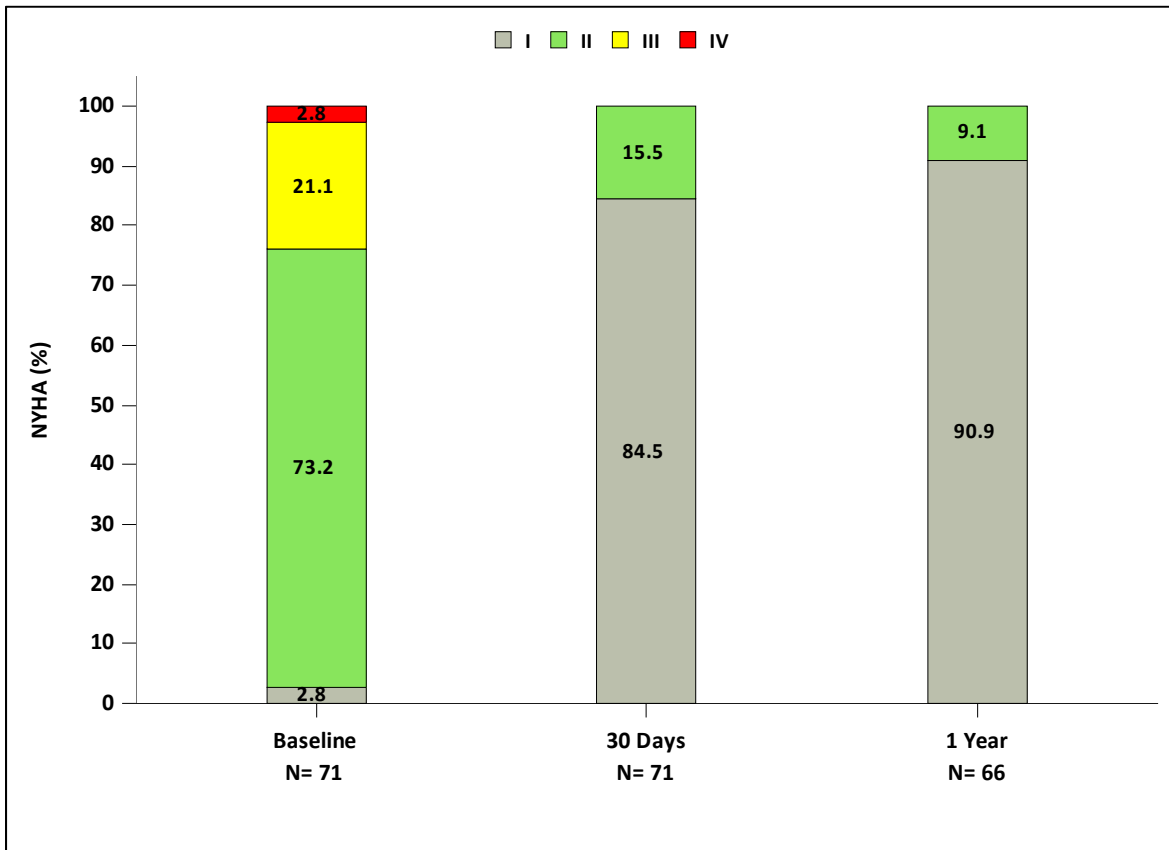


New York Heart Association (NYHA) Class

The NYHA classifications by visit are presented in Figure 59. At baseline, 23.9% of patients were in NYHA class III/IV. At 1 year, all patients (100.0%) were in NYHA class I/II.



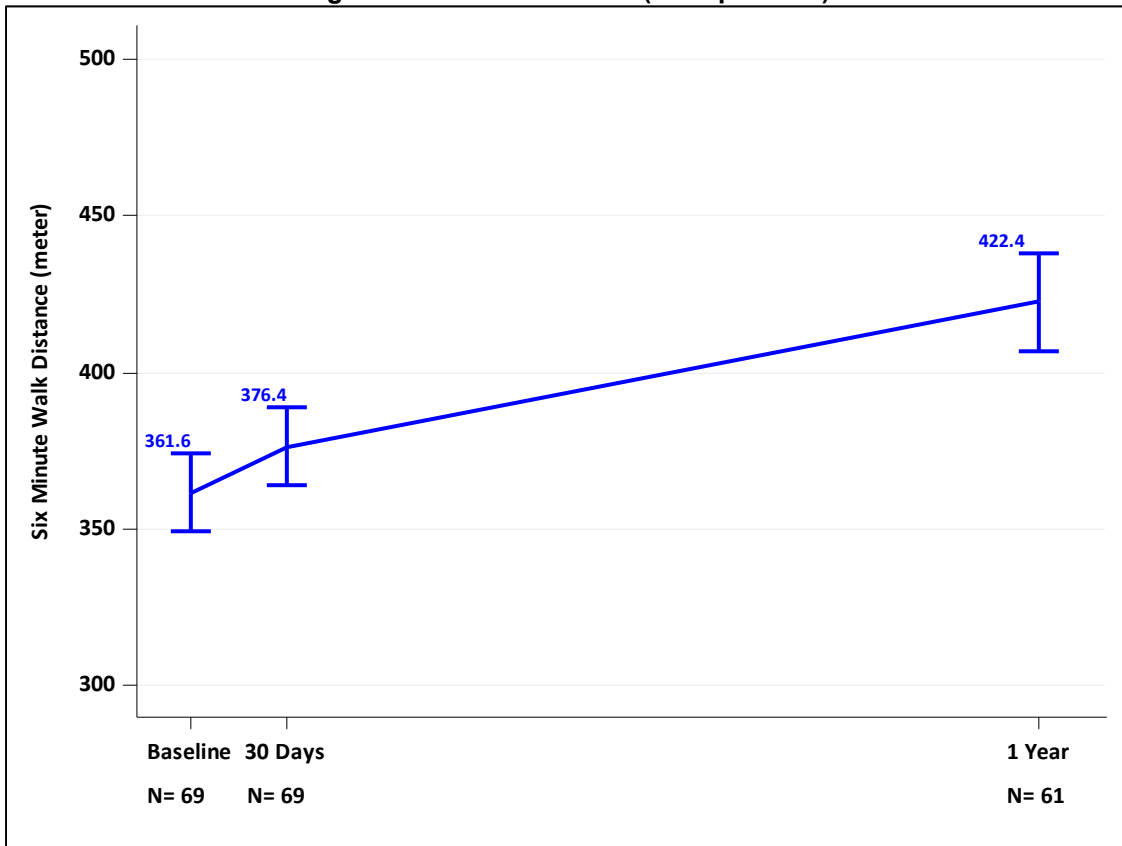
Figure 59: NYHA Class by Visit (VI Population)



Six-Minute Walk Test (6MWT)

The results for the 6MWT are presented in Figure 60. The patients showed an increase in mean 6MWT distance from 361.6 meters at baseline to 376.4 meters at 30 days and 422.4 meters at 1 year.

Figure 60: 6MWT Distance (VI Population)



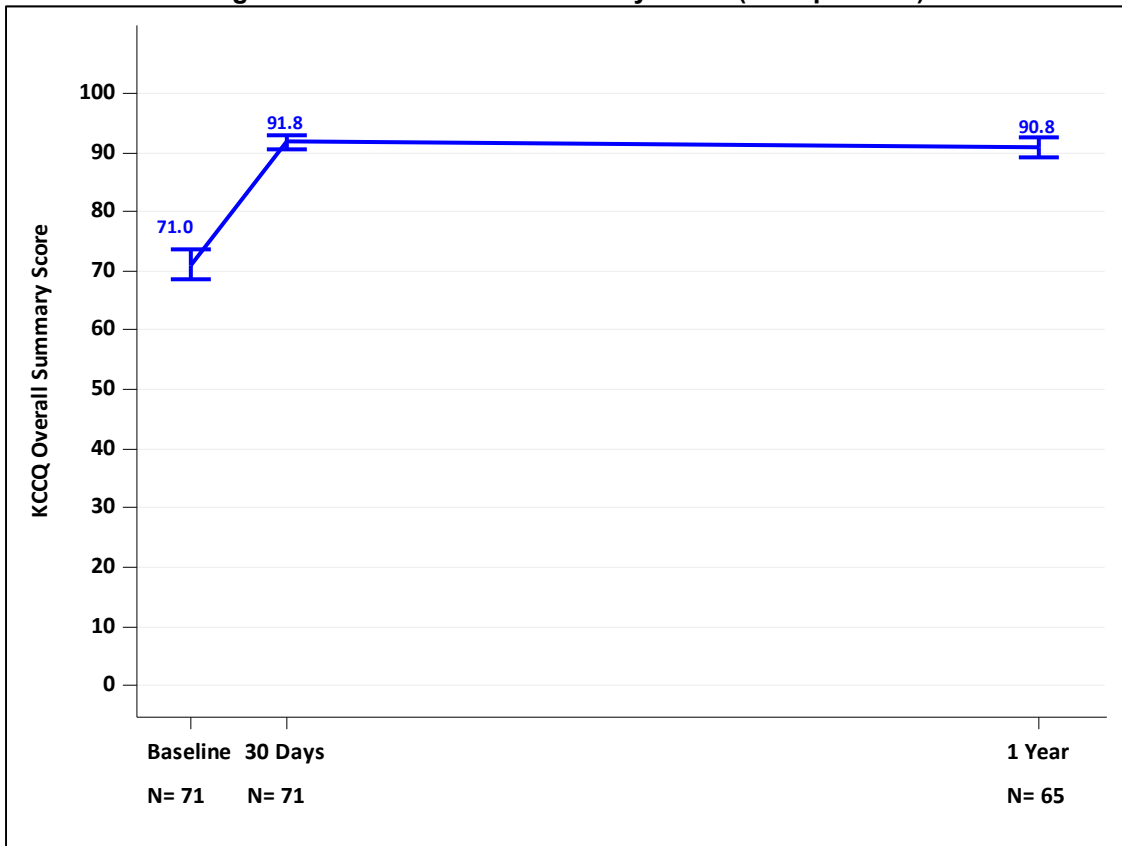
**Note:** Line plot with mean and standard error. The total number of patients at each visit time point only counted the patients with valid values.

### Quality of Life

#### KCCQ

The results for the KCCQ overall summary score are presented in Figure 61. The mean score increased from 71.0 at baseline to 91.8 at 30 days and 90.8 at 1 year.

Figure 61: KCCQ Overall Summary Score (VI Population)

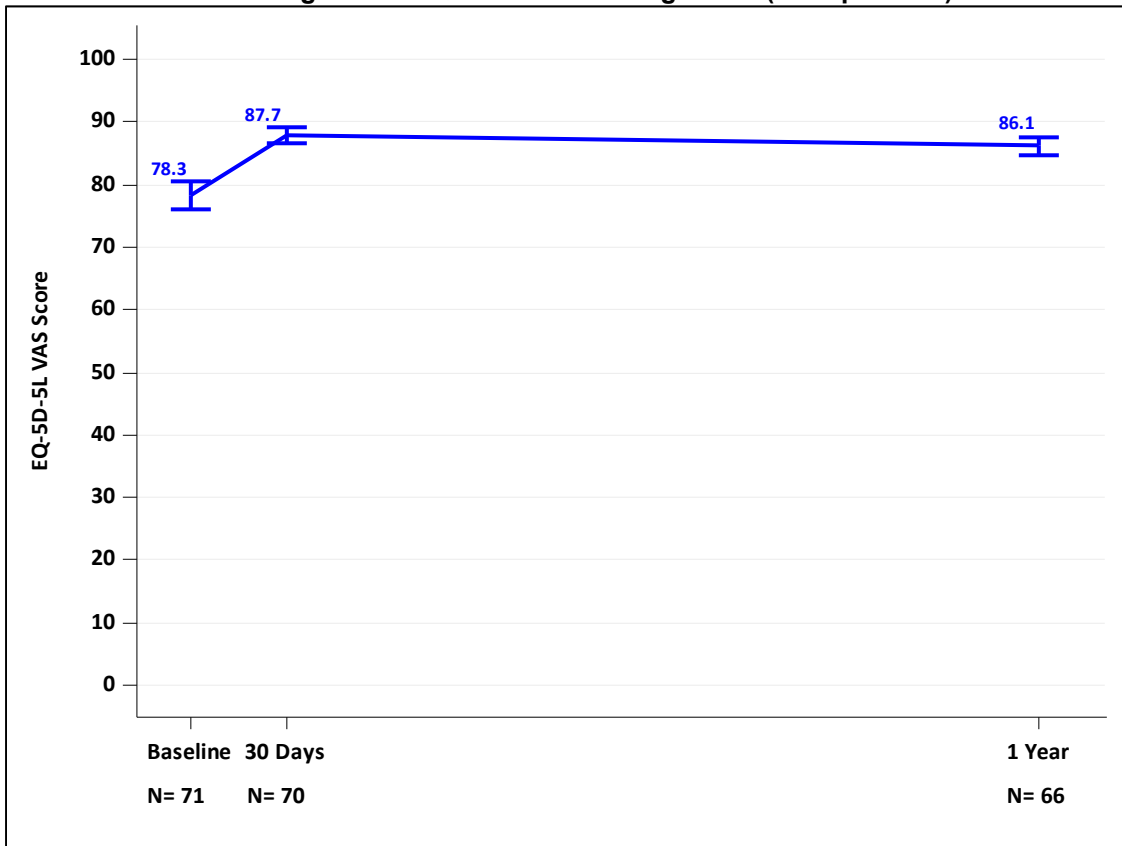


**Note:** Line plot with mean and standard error. The total number of patients at each visit time point only counted the patients with valid values.

*EuroQol (EQ-5D)*

The results for the EQ-5D visual analog score (VAS) are presented in Figure 62. The mean score was 78.3 at baseline, 87.7 at 30 days, and 86.1 at 1 year.

Figure 62: EQ-5D Visual Analog Score (VI Population)

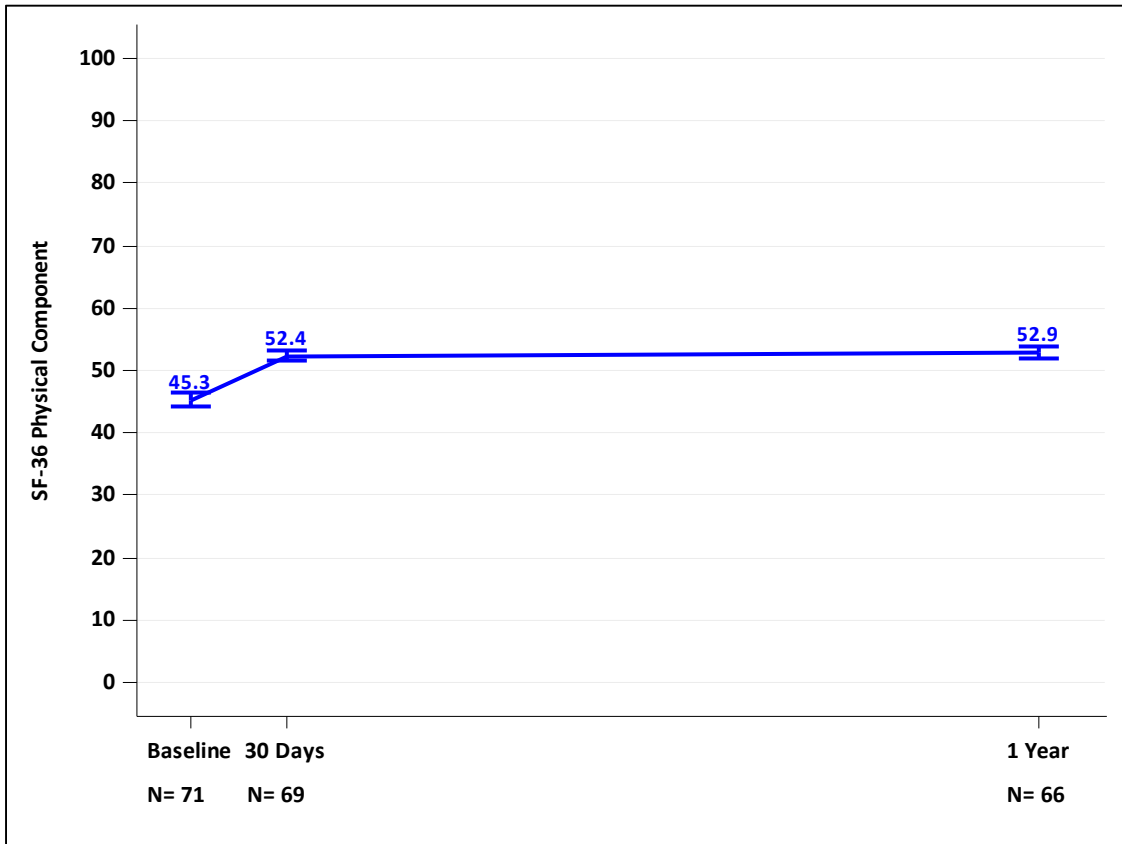


**Note:** Line plot with mean and standard error. The total number of patients at each visit time point only counted the patients with valid values.

*Short Form (SF)-36*

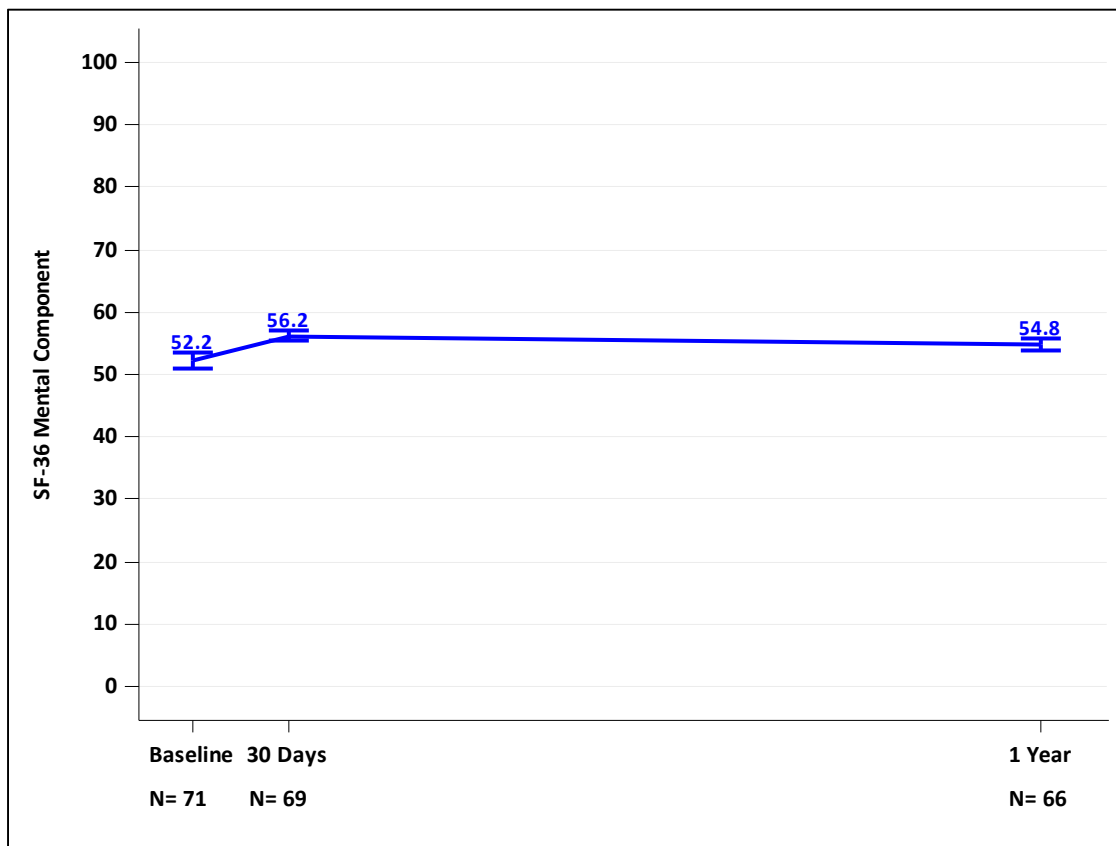
The results for the SF-36 physical component summary score and mental component summary score are presented in Figure 63 and Figure 64, respectively.

**Figure 63: SF-36 Physical Component Summary Score (VI Population)**



**Note:** Line plot with mean and standard error. The total number of patients at each visit time point only counted the patients with valid values.

**Figure 64: SF-36 Mental Component Summary Score (VI Population)**



**Note:** Line plot with mean and standard error. The total number of patients at each visit time point only counted the patients with valid values.

### 3. Adverse Events

The Kaplan-Meier estimates of the CEC-adjudicated adverse events through 1 year are shown in Table 57.

**Table 57: CEC-Adjudicated Adverse Events through 1 Year (AI Population)**

Event	Kaplan-Meier Rate*	
	30 Days	1 Year
All-cause death	0.0% (0, 0)	1.4% (1, 1)
Cardiovascular death	0.0% (0, 0)	1.4% (1, 1)
All stroke	2.8% (2, 2)	2.8% (2, 2)
Disabling stroke	0.0% (0, 0)	0.0% (0, 0)
Non-disabling stroke	2.8% (2, 2)	2.8% (2, 2)
Death or stroke	2.8% (2, 2)	2.8% (3, 2)
Death or disabling stroke	0.0% (0, 0)	1.4% (1, 1)
Major vascular complications	0.0% (0, 0)	0.0% (0, 0)
Life-threatening / disabling, or major bleeding	1.4% (1, 1)	1.4% (1, 1)

Event	Kaplan-Meier Rate*	
	30 Days	1 Year
Life-threatening /disabling bleeding	0.0% (0, 0)	0.0% (0, 0)
Major bleeding	1.4% (1, 1)	1.4% (1, 1)
Myocardial infarction	0.0% (0, 0)	0.0% (0, 0)
Requirement for renal replacement†	0.0% (0, 0)	0.0% (0, 0)
New permanent pacemaker implantation resulting from new or worsened conduction disturbances‡	9.9% (7, 7)	11.3% (8, 8)
Coronary obstruction requiring intervention	0.0% (0, 0)	0.0% (0, 0)
New onset atrial fibrillation	2.9% (2, 2)	4.4% (3, 3)
Rehospitalization§	4.2% (3, 3)	5.6% (4, 4)

\*Kaplan-Meier rate (no. of events, no. of patients with the event).

†Requirement for renal replacement was based on the site-reported event. All the other events were based on the CEC-adjudicated results.

‡Patients with pacemaker or ICD at baseline were not counted as new events.

§Rehospitalization (valve-related or procedure-related and including heart failure).

#### 4. Other Study Observations

##### Procedural Information

The procedural data are summarized in Table 58. The mean procedure time was 57.5 minutes. Conscious sedation was used in the majority of patients (62.0%).

**Table 58: Procedure (AI Population)**

Variable	Summary Statistics* (N=71)
Procedure time (min)	57.5 ± 29.4 (71)
Anesthesia type	
General	36.6% (26/71)
Conscious sedation	62.0% (44/71)
Conversion from conscious sedation to general anesthesia during the procedure	1.4% (1/71)
Anesthesia time (min)	140.8 ± 47.0 (71)
Concomitant Procedures	12.7% (9/71)
Procedure aborted	0.0% (0/71)
Conversion from TAVR to SAVR	0.0% (0/71)
Valve size	
20 mm	0.0% (0/71)
23 mm	28.2% (20/71)
26 mm	43.7% (31/71)
29 mm	28.2% (20/71)
Successful access, delivery and retrieval of the device delivery system	100.0% (71/71)

Variable	Summary Statistics* (N=71)
Specify arterial access	
Left percutaneous	17.4% (12/69)
Right percutaneous	82.6% (57/69)
Total fluoroscopy time (min)	17.0 ± 11.2 (71)
BAV performed	54.9% (39/71)
Post dilatation performed	19.7% (14/71)
Number of post dilatations	
1	92.9% (13/14)
2	7.1% (1/14)
3	0.0% (0/14)
More than one SAPIEN 3 THV implanted	0.0% (0/71)

\*Continuous measures - mean ± SD (n); Categorical measures - % (no./Total no.).

## **SAPIEN 3 THV VALVE-IN-VALVE – STS/ACC TRANSCATHETER VALVE THERAPY REGISTRY (TVTR) ANALYSIS**

### **Patient Accountability**

At the time of database extract, of the 314 patients in the aortic valve-in-valve cohort, 299 patients were eligible for the 30-day visit, and 252 (84.3%) patients paid a visit within the 30-day follow-up window defined as the period between the discharge + 1 day or 21 days post-procedure (whichever occurred first) and 75 days post-procedure; of the 311 patients (SAPIEN XT and SAPIEN 3 valve patients combined) in the mitral valve-in-valve cohort, 290 patients were eligible for the 30-day visit, and 244 (84.1%) patients paid a visit within the 30-day follow-up window. A detailed summary of the patient accountability at 30 days for the two cohorts is shown in Table 59.

**Table 59:  
Patient Accountability at 30-Day Follow-Up Visit**

	Aortic Valve-in-Valve	Mitral Valve-in-Valve		
		SAPIEN XT	SAPIEN 3	All
Total patients	314	241	70	311
Non-eligible	15	15	6	21
-Death	11	15	4	19
-Withdrawal	0	0	0	0
-Lost to follow-up	1	0	2	2
-Visit not yet due	3	0	0	0
Eligible	299	226	64	290
-Follow-up visit completed	252 (84.3%)	196 (86.7%)	48 (75.0%)	244 (84.1%)
-Missed Visit	47 (15.7%)	30 (13.3%)	16 (25.0%)	46 (15.9%)

The “Attempted Implant” population consisted of all patients for whom the first vascular access was attempted. The “Valve Implant” population consisted of those patients for whom the valve implant procedure has started and a “No” was indicated for both “procedure aborted” and “conversion to open heart surgery.” The number of patients in each analysis population of the aortic valve-in-valve and mitral valve-in-valve cohorts is shown in Table 60.



**Table 60:  
Analysis Populations**

Analysis Population	Aortic Valve-in-Valve	Mitral Valve-in-Valve		
		SAPIEN XT	SAPIEN 3	All
All Enrolled population	314	241	70	311
Attempted Implant population	314	241	70	311
Valve Implant population	314	236	69	305

**Study Population Demographics and Baseline Characteristics**

The demographics and baseline characteristics of both the aortic and mitral valve-in-valve patients, as shown in Tables 61 and 62, present an elderly, multimorbid cohort of patients, consistent with the high operative risk of the populations.

**Table 61:  
Patient Demographics and Baseline Characteristics - Aortic Valve-in-Valve  
(Attempted Implant Population)**

Demographics and Baseline Characteristics	Summary Statistics*
Age – years	74.3 ± 12.10 (313)
Male sex	188/314
Society of Thoracic Surgeons (STS) score	9.0 ± 8.0 (304)
New York Heart Association (NYHA) class	
I/II	45/312 (14.4%)
III/IV	267/312 (85.6%)
Previous myocardial infarction	62/313 (19.8%)
Previous intervention	
Coronary artery bypass grafting (CABG)	119/314 (37.9%)
Percutaneous coronary intervention (PCI)	56/314 (17.8%)
Prior aortic valvuloplasty	10/306 (3.3%)
Cerebrovascular accident (CVA)	46/313 (14.7%)
Peripheral vascular disease	79/314 (25.2%)
Atrial fibrillation	126/314 (40.1%)
Permanent pacemaker	53/314 (16.9%)
Porcelain aorta	19/314 (6.1%)
Hostile chest	58/314 (18.5%)
Echocardiographic findings (Valve Implant Population)	
Valve area - cm <sup>2</sup>	0.8 ± 0.4 (230)
Mean aortic-valve gradient – mmHg	39.3 ± 15.8 (251)
Mean left ventricular ejection fraction (LVEF)%	52.2 ± 13.1 (308)
Moderate or severe aortic regurgitation	168/310 (54.2%)
Moderate or severe mitral regurgitation	126/261 (48.3%)

\*Continuous measures - Mean ± SD (Total no.); Categorical measures - n. / Total no. (%)

**Table 62:  
Patient Demographics and Baseline Characteristics - Mitral Valve-in-Valve  
(Attempted Implant Population)**

Demographics and Baseline Characteristics	Summary Statistics*		
	SAPIEN XT	SAPIEN 3	All
Age - years	73.9 ± 12.4 (241)	71.5 ± 15.0 (70)	73.4 ± 13.1 (311)
Male sex	88/241 (36.5%)	32/70 (45.7%)	120/311 (38.6%)
Society of Thoracic Surgeons (STS) score	13.2 ± 9.1 (237)	12.2 ± 8.7 (65)	13.0 ± 8.98 (302)
New York Heart Association (NYHA) class			
I/II	30/238 (12.6%)	3/70 (4.3%)	33/308 (10.7%)
III/IV	208/238 (87.4%)	67/70 (95.7%)	275/308 (89.3%)
Previous myocardial infarction	47/239 (19.7%)	18/70 (25.7%)	65/309 (21.0%)
Previous intervention			
Coronary artery bypass grafting (CABG)	93/236 (39.4%)	28/69 (40.6%)	121/305 (39.7%)
Percutaneous coronary intervention (PCI)	32/238 (13.4%)	9/69 (13.0%)	41/307 (13.4%)
Cerebrovascular accident (CVA)	45/241 (18.7%)	15/70 (21.4%)	60/311 (19.3%)
Peripheral vascular disease	42/239 (17.6%)	6/70 (8.6%)	48/309 (15.5%)
Atrial fibrillation/flutter	155/241 (64.3%)	50/70 (71.4%)	205/311 (65.9%)
Permanent pacemaker	74/240 (30.8%)	20/69 (29.0%)	94/309 (30.4%)
Porcelain aorta	6/240 (2.5%)	1/69 (1.4%)	7/309 (2.3%)
Hostile chest	41/241 (17.0%)	6/70 (8.6%)	47/311 (15.1%)
Echocardiographic findings (Valve Implant Population)			
Mitral valve area - cm <sup>2</sup>	1.5 ± 0.9 (153)	1.4 ± 1.0 (46)	1.5 ± 0.88 (199)
Mean mitral-valve gradient - mmHg	12.7 ± 5.5 (215)	13.7 ± 6.2 (65)	12.9 ± 5.65 (280)
Mean left ventricular ejection fraction (LVEF), %	54.4 ± 11.7 (230)	53.8 ± 13.9 (67)	54.3 ± 12.2 (297)
Moderate or severe aortic regurgitation	35/231 (15.2%)	7/67 (10.5%)	42/298 (14.1%)
Moderate or severe mitral regurgitation	149/233 (63.9%)	39/68 (57.4%)	188/301 (62.5%)

\*Continuous measures - Mean ± SD (Total no.); categorical measures - n. / Total no. (%). The total no. only counted the patients with valid values.

**Safety and Effectiveness Results**

**Aortic Valve-in-Valve**

**Safety Endpoints**

The mortality rates at discharge and 30 days and the Kaplan-Meier curve for all-cause mortality for the aortic valve-in-valve cohort are shown in Table 63 and Figure 65, respectively. There were a total of 12 deaths reported at 30 days.

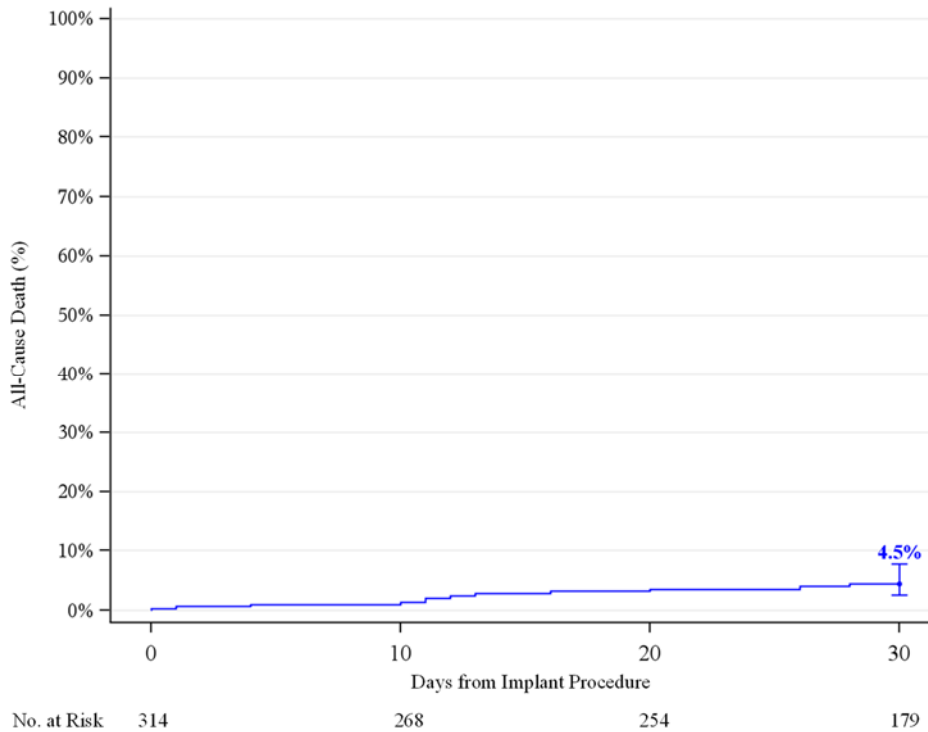
**Table 63:  
Death Rate - Aortic Valve-in-Valve (Attempted Implant Population)**

	<b>Discharge*</b>	<b>30 Days†</b>
All-cause death	2.5% (8)	4.5% (12)
Cardiac death	1.3% (4)	2.2% (6)

\*Observed rate - % (n)

†Kaplan-Meier estimate - % (n)

**Figure 65:  
All-Cause Death Rate - Aortic Valve-in-Valve  
(Attempted Implant Population)**



The DCRI adjudicated events, including all strokes/TIAs and aortic valve reinterventions at discharge and 30 days for the aortic valve-in-valve cohort, are shown in Table 64.

**Table 64:**  
**Duke Clinical Research Institute Adjudicated Events - Aortic Valve-in-Valve**  
**(Attempted Implant Population)**

Events	Discharge*	30 Days†
All stroke	1.0% (3, 3)	1.0% (3, 3)
Ischemic stroke	1.0% (3, 3)	1.0% (3, 3)
Hemorrhagic stroke	0.0% (0, 0)	0.0% (0, 0)
Transient ischemic attack (TIA)	0.0% (0, 0)	0.0% (0, 0)
Aortic valve reintervention	0.3% (1, 1)	0.3% (1, 1)

\*Observed rate - % (no. of events, no. of subjects with the event)

†Kaplan-Meier estimate - % (no. of events, no. of subjects with the event)

### Site Reported Adverse Events

The site reported adverse events at discharge and 30 days for the aortic valve-in-valve cohort is shown in Table 65.

**Table 65:**  
**Site Reported Adverse Events - Aortic Valve-in-Valve**  
**(Attempted Implant Population)**

Events	Discharge*	30 Days†
Non-valve related readmission	N/A	5.9% (15, 15)
Minor vascular complication	3.8% (12, 12)	4.3% (13, 13)
Conduction/native pacer disturbance requiring pacer	2.9% (9, 9)	3.0% (9, 9)
Hematoma at access site	2.9% (9, 9)	2.9% (9, 9)
Atrial fibrillation	2.5% (8, 8)	2.6% (8, 8)
Bleeding at access site	2.5% (8, 8)	2.5% (8, 8)
Cardiac arrest	2.5% (8, 8)	2.5% (8, 8)
Unplanned vascular surgery or intervention	1.6% (5, 5)	2.0% (7, 6)
Percutaneous coronary intervention (PCI)	1.3% (4, 4)	1.7% (5, 5)
Other bleed	1.3% (4, 4)	1.3% (4, 4)
Coronary compression or obstruction	1.0% (3, 3)	1.0% (3, 3)
Hemorrhagic stroke	0.6% (2, 2)	1.1% (3, 3)
Life threatening bleeding	N/A	1.1% (3, 3)
Unplanned other cardiac surgery or intervention	1.0% (3, 3)	1.0% (3, 3)
Major bleeding event	N/A	0.8% (2, 2)
Major vascular complication	0.6% (2, 2)	0.6% (3, 2)
Myocardial infarction	0.3% (1, 1)	0.7% (2, 2)
New requirement for dialysis	0.6% (2, 2)	0.8% (2, 2)
Other device related event	0.6% (2, 2)	0.6% (2, 2)
Aortic valve re-intervention	0.0% (0, 0)	0.4% (1, 1)
Conduction/native pacer disturbance requiring implantable cardioverter defibrillator (ICD)	0.3% (1, 1)	0.3% (1, 1)
Device migration	0.3% (1, 1)	0.3% (1, 1)
Gastrointestinal bleeding (GI) bleed	0.3% (1, 1)	0.3% (1, 1)
Transapical related event	0.3% (1, 1)	0.3% (1, 1)

Events	Discharge*	30 Days†
Valve related readmission	N/A	0.4% (1, 1)
Device thrombosis	0.0% (0, 0)	0.0% (0, 0)

\*Observed rate - % (no. of events, no. of subjects with the event)

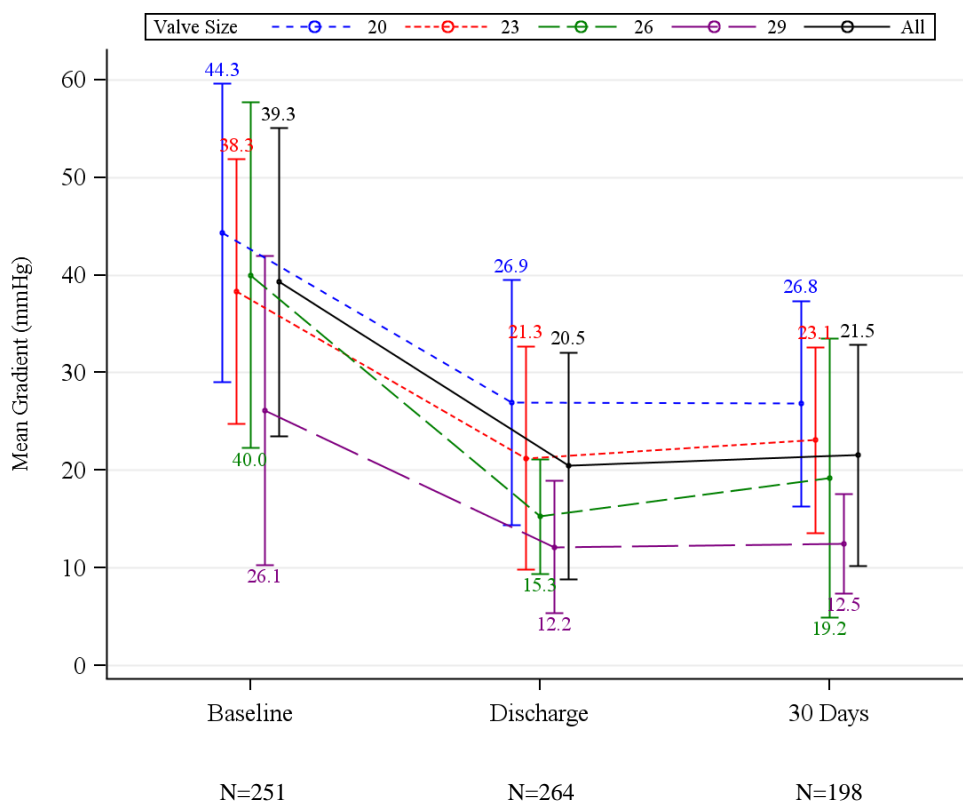
†Kaplan-Meier estimate - % (no. of events, no. of subjects with the event)

## Effectiveness Endpoints

### Valve Performance

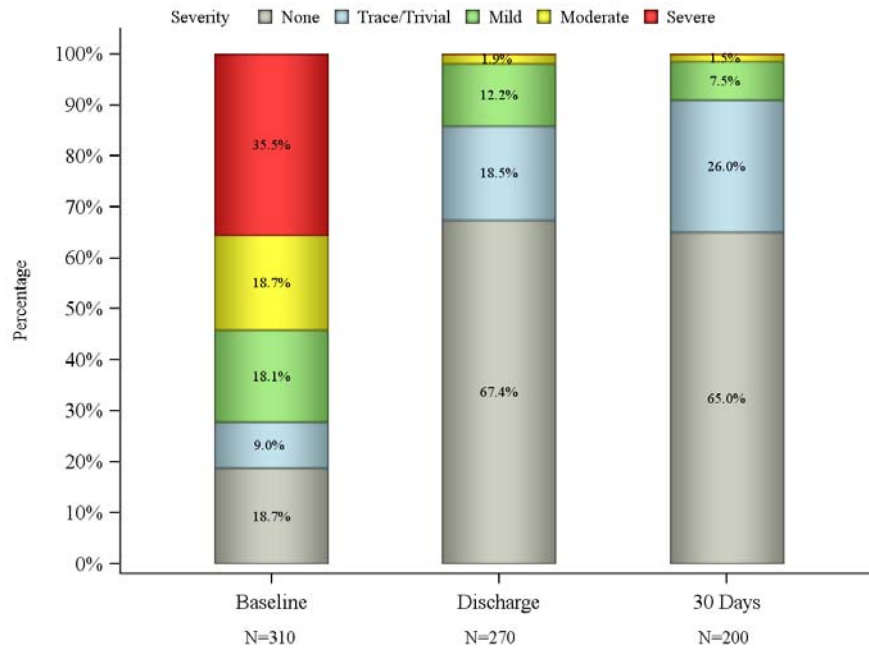
The aortic valve-in-valve echocardiographic performance data are summarized in Figures 66-68. The mean gradients improved from  $39.3 \pm 15.8$  mmHg at baseline to  $21.5 \pm 11.3$  mmHg at 30 days. Moderate/severe aortic regurgitation was observed in 54.2% of the patients at baseline, which decreased to 1.5% of the patients at 30 days.

**Figure 66:**  
**Mean Gradient by Visit - Aortic Valve-in-Valve**  
**(Valve Implant Population)**



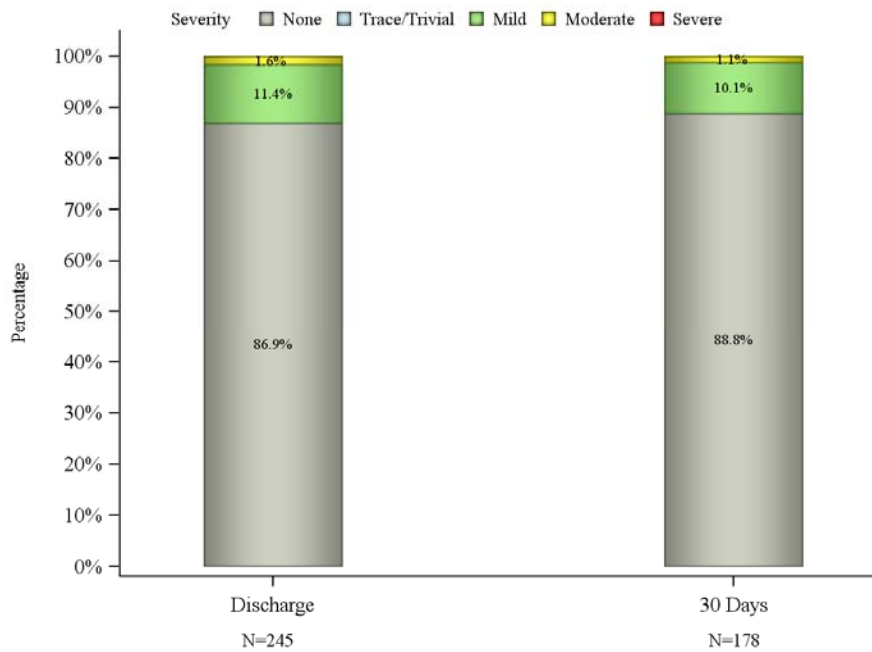
Note: Line plot with mean and standard deviation. The total number of patients at each time point only counted the patients with valid values.

**Figure 67**  
**Aortic Regurgitation by Visit - Aortic Valve-in-Valve**  
**(Valve Implant Population)**



Note: The total number of patients at each time point only counted the patients with valid values.

**Figure 68:**  
**Paravalvular Regurgitation by Visit - Aortic Valve-in-Valve**  
**(Valve Implant Population)**

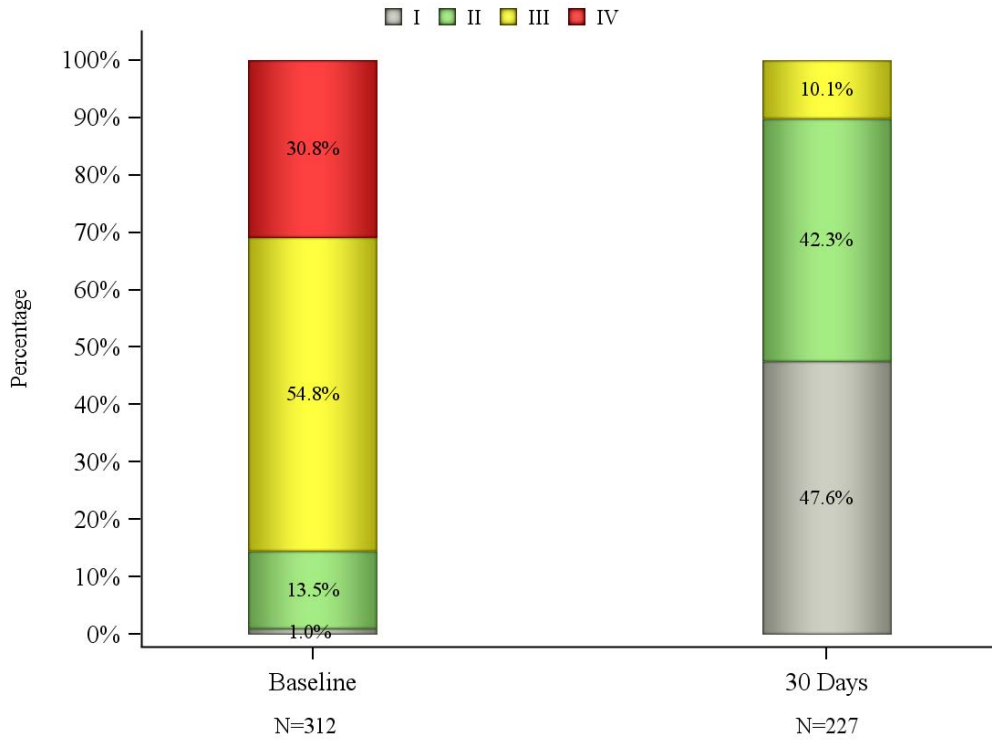


Note: The total number of patients at each time point only counted the patients with valid values.

**NYHA Class**

The NYHA class distributions at baseline and the 30-day visit and the NYHA class changes from baseline to the 30-day visit are shown in Figure 69 and Table 66, respectively. The majority (85.4%) of the patients had an improved NYHA class at the 30-day visit.

**Figure 69:  
NYHA Functional Class - Aortic Valve-in-Valve  
(Valve Implant Population)**



Note: The total number of patients at each time point only counted the patients with valid values.

**Table 66:  
NYHA Class Change - Aortic Valve-in-Valve  
(Valve Implant Population)**

	NYHA Class Change*		
	Improved	Same	Worsened
Baseline to 30-day visit	193/226 (85.4%)	31/226 (13.7%)	2/226 (0.9%)

\*n/Total no. (%); the total no. only counted the patients with valid values.

### Five-Meter Walk Test

The results of the five-meter walk test are summarized in Table 67.

**Table 67:**  
**Five-Meter Walk Test - Aortic Valve-in-Valve (Valve Implant Population)**

Visit*	Five Meter Walk Time (seconds)†
Baseline	7.6 ± 3.9 (209)
30-day visit	5.9 ± 2.4 (68)
Change from baseline to 30 day visit	-1.4 ± 2.9 (51)

\*There were up to 3 five-meter walk tests for each patient at each visit, and the results were averaged.

†Mean ± SD (Total no.). The total number of patients at each time point only counted the patients with valid values.

### Length of Stay

The mean index hospitalization stay was 4.9 days, which included an average of 1.8 days in the intensive care unit (ICU), as summarized in Table 68.

**Table 68:**  
**Index Hospitalization Stay - Aortic Valve-in-Valve  
(Attempted Implant Population)**

	Length (days)*
Index Hospitalization Stay	4.9 ± 3.9 (314)
Intensive Care Stay	1.8 ± 2.6 (311)

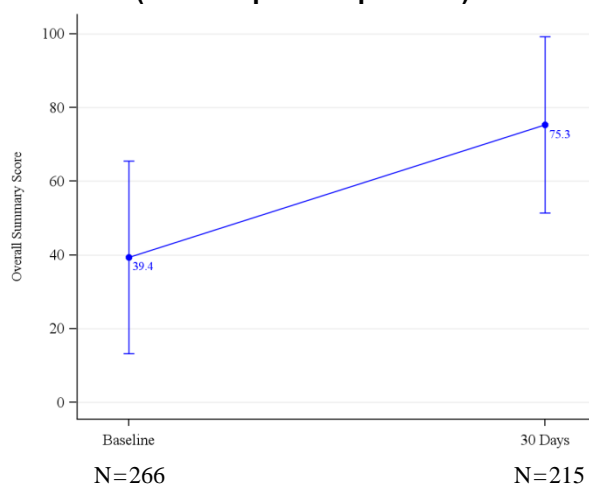
\*Mean ± SD (Total no.).

### Quality of Life (QoL)

The QoL at baseline and 30 days as measured by the KCCQ clinical summary score is shown in Figure 70. The mean KCCQ summary score improved from 39.4 at baseline to 75.3 at 30 days.



**Figure 70:**  
**KCCQ Overall Summary Score - Aortic Valve-in-Valve**  
**(Valve Implant Population)**



Note: Line plot with mean and standard deviation. The total number of patients at each time point only counted the patients with valid values.

### Procedural Information

The procedure information is presented in Table 69. The most common delivery approach for the aortic valve-in-valve implantation was the transfemoral approach, which was used in 93.0% (292/314) of cases, followed by the transapical approach in 4.1% (13/314) of cases, and other alternative approaches (transaortic, subclavian, and other) in 2.9% (9/314) of cases. There were no aborted procedures or conversions to open heart surgery. The overall device success rate was 88.9% (272/306), which was defined as the following:

- Successful vascular access, delivery, and deployment of the device and successful retrieval of the delivery system, and
- Correct position of the device in the proper anatomical location, and
- Intended performance of the prosthetic heart valve (aortic valve area > 1.2 cm<sup>2</sup> and mean aortic valve gradient < 20 mmHg or peak velocity < 3 m/s, without moderate or severe prosthetic valve regurgitation), and
- Only one valve implanted in the proper anatomical location.

**Table 69:**  
**Procedural Data Summary - Aortic Valve-in-Valve**  
**(Attempted Implant Population)**

Procedural Data	Summary Statistics*
<b>Operator Reason for Procedure</b>	
Inoperable/extreme risk	80/313 (25.6%)
High risk	219/313 (70.0%)
Intermediate risk	10/313 (3.2%)
Low risk	4/313 (1.3%)
<b>Implant Approach</b>	
Transfemoral	292/314 (93.0%)
Transapical	13/314 (4.1%)
Transaortic	1/314 (0.3%)
Subclavian/axillary	6/314 (1.9%)
Other†	2/314 (0.6%)

Procedural Data	Summary Statistics*
Prior Valve Type	
Bioprosthetic stented	159/308 (51.6%)
Bioprosthetic stentless	79/308 (25.6%)
Procedure Status	
Elective	231/314 (73.6%)
Urgent	74/314 (23.6%)
Emergency	8/314 (2.5%)
Salvage	1/314 (0.3%)
Valve Size	
20 mm	83/314 (26.4%)
23 mm	130/314 (41.4%)
26 mm	57/314 (18.2%)
29 mm	44/314 (14.0%)
Primary Procedure Indication	
Aortic stenosis (Primary)	95/313 (30.4%)
Aortic insufficiency (Primary)	19/313 (6.1%)
Mixed aortic stenosis/aortic insufficiency	10/313 (3.2%)
Failed bioprosthetic valve	189/313 (60.4%)
Cardiopulmonary Bypass (CPB)	
CPB status	
Elective	4/5 (80.0%)
Emergent	1/5 (20.0%)
CPB time (min)	90.5 ± 140.9 (4)
Type of Anesthesia	
General anesthesia	240/314 (76.4%)
Moderate sedation	72/314 (22.9%)
Epidural	0/314 (0.0%)
Combination	2/314 (0.6%)
Total procedure time (min)	110.7 ± 63.0 (314)
Fluoroscopy time (min)	21.2 ± 16.1 (304)
Device success	272/306 (88.9%)
Procedure aborted	0/314 (0.0%)
Conversion to open heart surgery	0/314 (0.0%)
Mechanical assist device in place at start of procedure	
Intra-aortic balloon pump (IABP)	2/5 (40.0%)
Catheter based assist device	3/5 (60.0%)

\*Categorical measures – no./Total no. (%); continuous measures - mean ± SD (Total no.). The total no. only counted the patients with valid values at the time point.

†The data collection form was changed in February 2013 to specify non-transfemoral (non-TF), non-transapical (non-TA) approaches rather than “other”; hence, “other” likely included the non-TF and non-TA approaches.

## Mitral Valve-in-Valve

### Safety Endpoints

The mortality rates at discharge and 30 days and the Kaplan-Meier curve for all-cause mortality for the mitral valve-in-valve cohort are shown in Table 70 and Figure 71, respectively. There were 16 reported deaths in the SAPIEN XT valve patients and 4 in the SAPIEN 3 valve patients at 30 days.

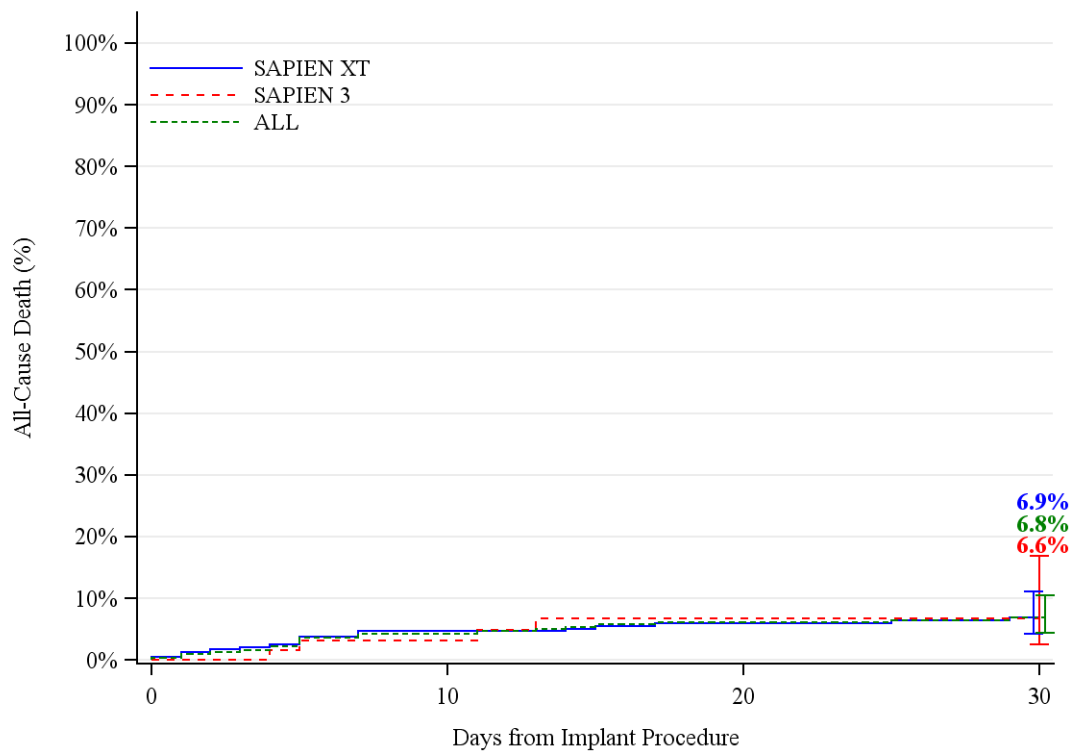
**Table 70:**  
**Death Rate - Mitral Valve-in-Valve (Attempted Implant Population)**

Event	Discharge*			30 Days†		
	SAPIEN XT	SAPIEN 3	All	SAPIEN XT	SAPIEN 3	All
All-cause death	5.0% (12)	5.7% (4)	5.1% (16)	6.9% (16)	6.6% (4)	6.8% (20)
Cardiac death	3.7% (9)	4.3% (3)	3.9% (12)	4.2% (10)	4.9% (3)	4.3% (13)

\*Observed rate - % (n)

†Kaplan-Meier estimate - % (n)

**Figure 71:**  
**All-Cause Death Rate - Mitral Valve-in-Valve**  
**(Attempted Implant Population)**



No. at Risk				
SAPIEN XT	241	216	209	186
SAPIEN 3	70	56	52	45
ALL	311	272	261	231

The DCRI-adjudicated events, including all strokes/TIAs, heart failure readmissions, and mitral valve reinterventions at discharge and 30 days, for the mitral valve-in-valve cohort are shown in Table 71.

**Table 71:  
Duke Clinical Research Institute Adjudicated Events - Mitral Valve-in-Valve  
(Attempted Implant Population)**

Events	Discharge*			30 Day†		
	SAPIEN XT	SAPIEN 3	All	SAPIEN XT	SAPIEN 3	All
All stroke	0.4% (1, 1)	1.4% (1, 1)	0.6% (2, 2)	0.4% (1, 1)	1.5% (1, 1)	0.7% (2, 2)
Ischemic stroke	0.4% (1, 1)	1.4% (1, 1)	0.6% (2, 2)	0.4% (1, 1)	1.5% (1, 1)	0.7% (2, 2)
Hemorrhagic stroke	0.0% (0, 0)	0.0% (0, 0)	0.0% (0, 0)	0.0% (0, 0)	0.0% (0, 0)	0.0% (0, 0)
Transient ischemic attack (TIA)	0.0% (0, 0)	0.0% (0, 0)	0.0% (0, 0)	0.0% (0, 0)	0.0% (0, 0)	0.0% (0, 0)
Readmission - heart failure	N/A	N/A	N/A	1.0% (2, 2)	0.0% (0, 0)	0.8% (2, 2)
Mitral valve reintervention	0.0% (0, 0)	0.0% (0, 0)	0.0% (0, 0)	0.5% (1, 1)	0.0% (0, 0)	0.4% (1, 1)

\*Observed rate - % (no. of events, no. of subjects with the event)

†Kaplan-Meier estimate - % (no. of events, no. of subjects with the event)

#### Site Reported Adverse Events

The site reported adverse events at discharge and 30 days for the mitral valve-in-valve cohort are shown in Table 72.

**Table 72:  
Site Reported Adverse Events - Mitral Valve-in-Valve  
(Attempted Implant Population)**

Events	Discharge*			30 Day†		
	SAPIEN XT	SAPIEN 3	All	SAPIEN XT	SAPIEN 3	All
Other bleed	5.4% (13, 13)	4.3% (3, 3)	5.1% (16, 16)	6.1% (14, 14)	4.4% (3, 3)	5.8% (17, 17)
Readmission - not cardiac	N/A	N/A	N/A	5.8% (12, 12)	0.0% (0, 0)	4.6% (12, 12)
Atrial septal defect closure following transseptal catheterization	4.6% (11, 11)	5.7% (4, 4)	4.8% (15, 15)	4.6% (11, 11)	5.7% (4, 4)	4.9% (15, 15)
Cardiac arrest	4.1% (10, 10)	2.9% (2, 2)	3.9% (12, 12)	4.2% (10, 10)	3.2% (2, 2)	4.0% (12, 12)
Unplanned other cardiac surgery or intervention	3.3% (8, 8)	0.0% (0, 0)	2.6% (8, 8)	3.8% (9, 9)	0.0% (0, 0)	3.0% (9, 9)
Atrial fibrillation	3.3% (8, 8)	1.4% (1, 1)	2.9% (9, 9)	3.4% (8, 8)	1.5% (1, 1)	2.9% (9, 9)
New requirement for dialysis	2.9% (7, 7)	1.4% (1, 1)	2.6% (8, 8)	3.0% (7, 7)	1.6% (1, 1)	2.7% (8, 8)
Bleeding at access site	2.5% (6, 6)	1.4% (1, 1)	2.3% (7, 7)	2.5% (6, 6)	1.4% (1, 1)	2.3% (7, 7)
Unplanned vascular surgery or intervention	2.5% (6, 6)	2.9% (2, 2)	2.6% (8, 8)	2.5% (6, 6)	3.2% (2, 2)	2.6% (8, 8)

Events	Discharge*			30 Day†		
	SAPIEN XT	SAPIEN 3	All	SAPIEN XT	SAPIEN 3	All
Perforation with or w/o tamponade	2.1% (5, 5)	0.0% (0, 0)	1.6% (5, 5)	2.1% (5, 5)	0.0% (0, 0)	1.6% (5, 5)
Hematoma at access site	1.2% (3, 3)	0.0% (0, 0)	1.0% (3, 3)	1.3% (3, 3)	0.0% (0, 0)	1.0% (3, 3)
Minor vascular complication	1.2% (3, 3)	1.4% (1, 1)	1.3% (4, 4)	1.2% (3, 3)	1.7% (1, 1)	1.3% (4, 4)
Transapical related event	1.2% (3, 3)	0.0% (0, 0)	1.0% (3, 3)	1.2% (3, 3)	0.0% (0, 0)	1.0% (3, 3)
Transseptal related event	1.2% (3, 3)	0.0% (0, 0)	1.0% (3, 3)	1.2% (3, 3)	0.0% (0, 0)	1.0% (3, 3)
Gastrointestinal bleed	0.8% (2, 2)	1.4% (1, 1)	1.0% (3, 3)	0.9% (2, 2)	1.4% (1, 1)	1.1% (3, 3)
Major vascular complication	0.8% (2, 2)	0.0% (0, 0)	0.6% (2, 2)	0.8% (2, 2)	0.0% (0, 0)	0.6% (2, 2)
Readmission - cardiac	N/A	N/A	N/A	0.9% (2, 2)	0.0% (0, 0)	0.8% (2, 2)
Device embolization	0.0% (0, 0)	0.0% (0, 0)	0.0% (0, 0)	0.5% (1, 1)	0.0% (0, 0)	0.4% (1, 1)
Device migration	0.0% (0, 0)	1.4% (1, 1)	0.3% (1, 1)	0.5% (1, 1)	1.4% (1, 1)	0.7% (2, 2)
Device recapture or retrieval	0.0% (0, 0)	1.4% (1, 1)	0.3% (1, 1)	0.5% (1, 1)	1.4% (1, 1)	0.7% (2, 2)
Genitourinary bleed	0.4% (1, 1)	0.0% (0, 0)	0.3% (1, 1)	0.4% (1, 1)	0.0% (0, 0)	0.3% (1, 1)
Major bleeding event	N/A	N/A	N/A	0.5% (1, 1)	0.0% (0, 0)	0.4% (1, 1)
Non-valve related readmission	N/A	N/A	N/A	0.5% (1, 1)	0.0% (0, 0)	0.4% (1, 1)
Conduction/native pacer disturbance requiring pacer	0.0% (0, 0)	1.4% (1, 1)	0.3% (1, 1)	0.0% (0, 0)	1.5% (1, 1)	0.3% (1, 1)
Device thrombosis	0.0% (0, 0)	0.0% (0, 0)	0.0% (0, 0)	0.0% (0, 0)	0.0% (0, 0)	0.0% (0, 0)
Endocarditis	0.0% (0, 0)	0.0% (0, 0)	0.0% (0, 0)	0.0% (0, 0)	0.0% (0, 0)	0.0% (0, 0)
Life threatening bleeding	N/A	N/A	N/A	0.0% (0, 0)	0.0% (0, 0)	0.0% (0, 0)
Myocardial infarction	0.0% (0, 0)	1.4% (1, 1)	0.3% (1, 1)	0.0% (0, 0)	1.4% (1, 1)	0.3% (1, 1)
Other device related event	0.0% (0, 0)	1.4% (1, 1)	0.3% (1, 1)	0.0% (0, 0)	1.4% (1, 1)	0.3% (1, 1)
Transient ischemic attack	0.4% (1, 1)	0.0% (0, 0)	0.3% (1, 1)	0.4% (1, 1)	0.0% (0, 0)	0.3% (1, 1)
Ischemic stroke	0.4% (1, 1)	1.4% (1, 1)	0.6% (2, 2)	0.4% (1, 1)	1.5% (1, 1)	0.7% (2, 2)
Readmission - heart failure	N/A	N/A	N/A	1.0% (2, 2)	3.8% (2, 2)	1.6% (4, 4)

\*Observed rate,% (no. of events, no. of subjects with the event)

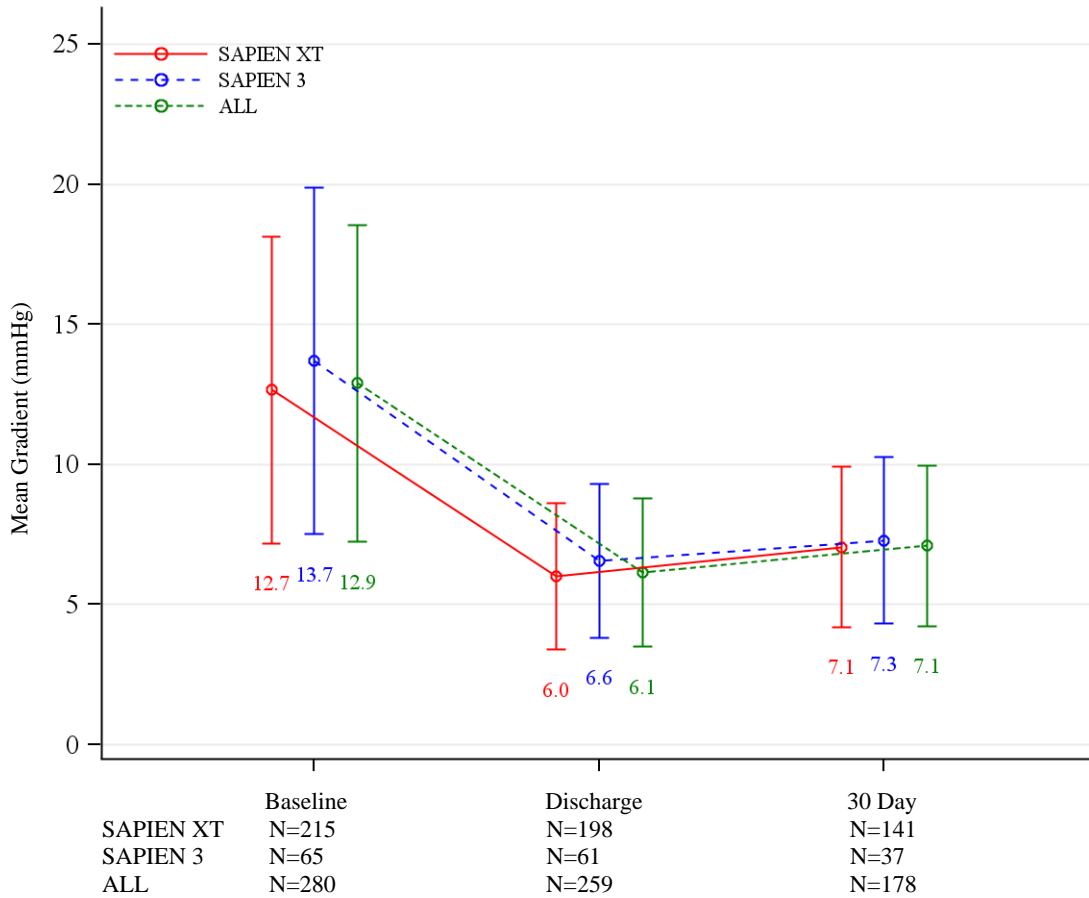
†Kaplan-Meier estimate,% (no. of events, no. of subjects with the event)

## Effectiveness Endpoints

### Valve Performance

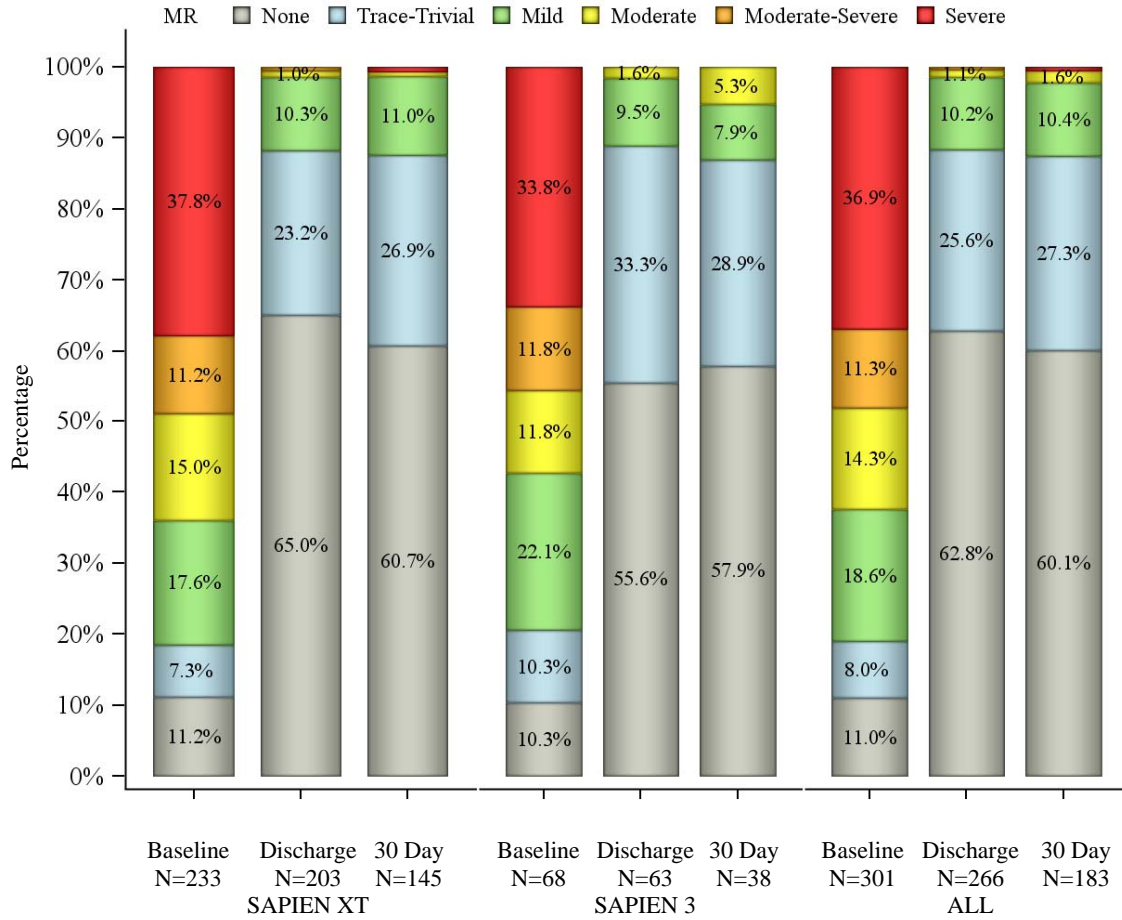
The mitral valve-in-valve echocardiographic performance data are summarized in Figures 72-74. The mean gradients improved from 12.9 mmHg at baseline to 7.1 mmHg at 30 days. Moderate/severe mitral regurgitation was observed in 62.5% of the patients at baseline, which decreased to 2.2% of the patients at 30 days.

**Figure 72:  
Mean Gradient by Visit - Mitral Valve-in-Valve  
(Valve Implant Population)**



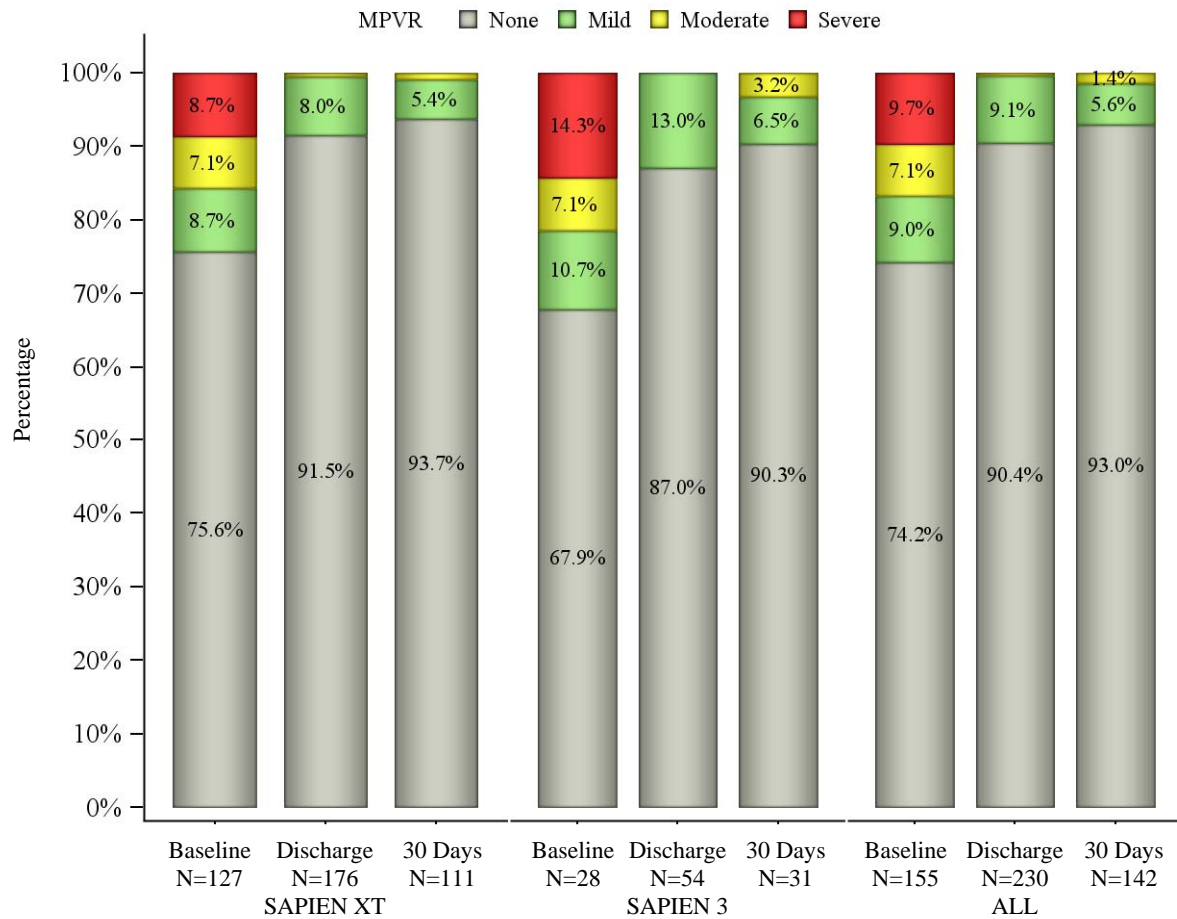
Note: Line plot with mean and standard deviation. The total number of patients at each time point only counted the patients with valid values.

**Figure 73:  
Mitral Regurgitation by Visit - Mitral Valve-in-Valve  
(Valve Implant Population)**



Note: Values that are < 1.0% are not labeled in the bar chart. The total number of patients at each time point only counted the patients with valid values.

**Figure 74:**  
**Paravalvular Regurgitation by Visit - Mitral Valve-in-Valve**  
**(Valve Implant Population)**



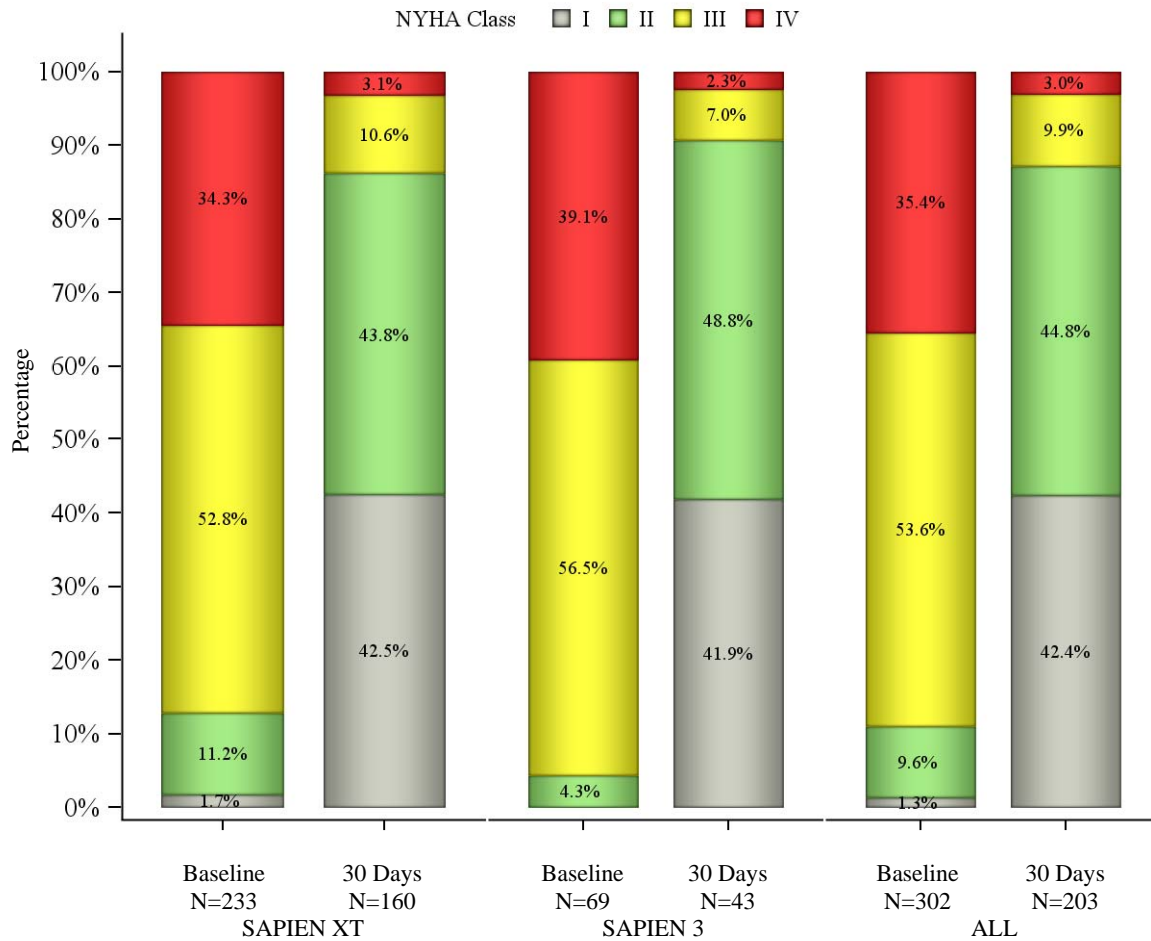
Note: Values that are < 1.0% are not labeled in the bar chart. The total number of patients at each time point only counted the patients with valid values.

**NYHA Class**

The NYHA class distributions at baseline and the 30-day visit and the NYHA class changes from baseline to the 30-day visit are shown in Figure 75 and Table 73, respectively. The majority (85.6%) of the patients had an improved NYHA class at the 30-day visit.



**Figure 75:**  
**NYHA Functional Class - Mitral Valve-in-Valve**  
**(Valve Implant Population)**



Note: The total number of patients at each time point only counted the patients with valid values.

**Table 73:**  
**NYHA Class Change - Mitral Valve-in-Valve**  
**(Valve Implant Population)**

		NYHA Class Change*		
		Improved	Same	Worsened
Baseline to 30-day visit	SAPIEN XT	133/159 (83.6%)	24/159 (15.1%)	2/159 (1.3%)
	SAPIEN 3	40/43 (93.0%)	3/43 (7.0%)	0/43 (0.0%)
	All	173/202 (85.6%)	27/202 (13.4%)	2/202 (1.0%)

\*n/Total no. (%); the total no. only counted the patients with valid values.

### Six-Minute Walk Test (6MWT)

The results of the 6MWT are summarized in Table 74.

**Table 74:**  
**Six-Minute Walk Test - Mitral Valve-in-Valve (Valve Implant Population)**

Visit	6-Minute Walk Distance (feet)*		
	SAPIEN XT	SAPIEN 3	All
Baseline	240.5 ± 366.2 (77)	375.6 ± 370.4 (32)	280.2 ± 370.9 (109)
30-day visit	768.7 ± 480.6 (34)	977.5 ± 597.4 (8)	808.5 ± 503.7 (42)
Change from baseline to 30 days	479.0 ± 471.3 (20)	457.6 ± 348.1 (5)	474.7 ± 442.9 (25)

\*Mean ± SD (Total no.). The total number of patients at each time point only counted the patients with valid values. The 6-minute walk distance was counted as 0 for the 6-minute walk tests not performed due to cardiac reasons.

### Length of Stay

The mean index hospitalization stay was 8.5 days, which included an average of 3.4 days in the intensive care unit (ICU), as summarized in Table 75.

**Table 75:**  
**Index Hospitalization Stay - Mitral Valve-in-Valve (Attempted Implant Population)**

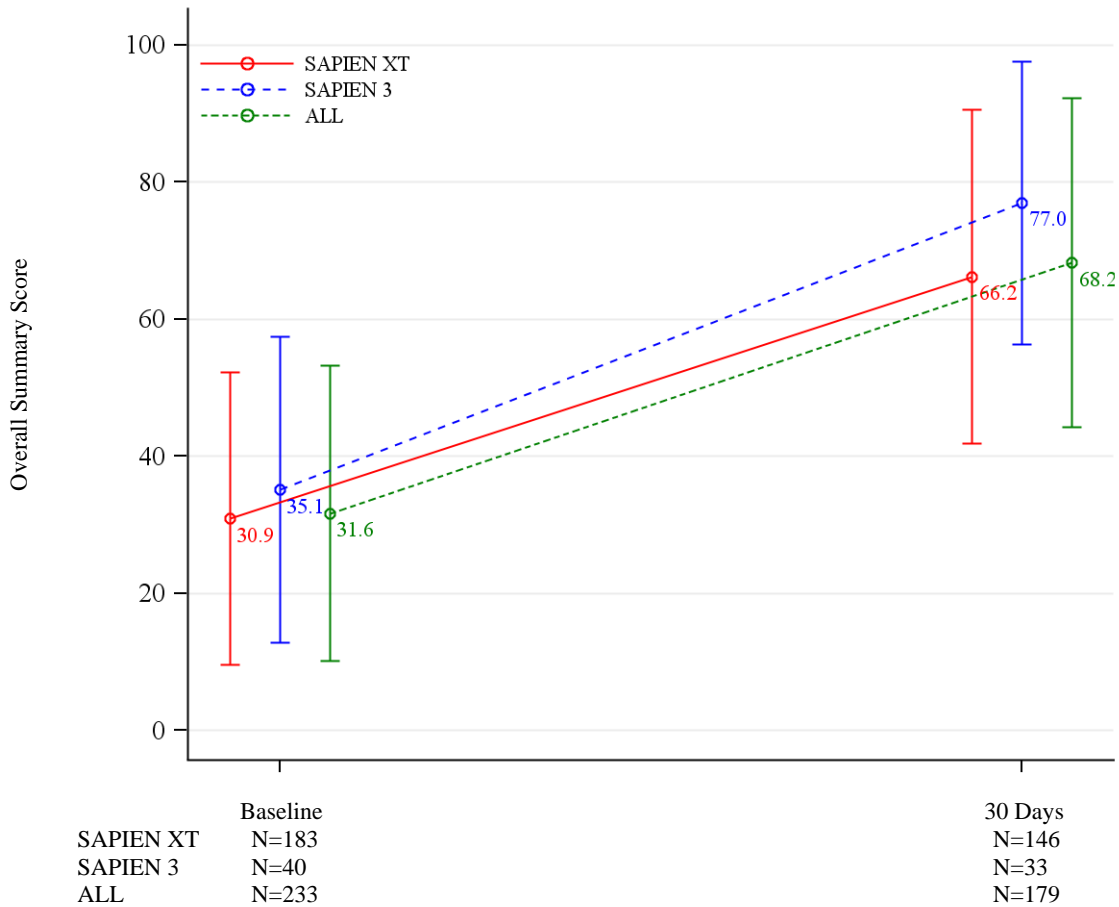
	Length (days)		
	SAPIEN XT	SAPIEN 3	All
Index hospitalization stay	8.8 ± 7.1 (241)	7.6 ± 7.4 (70)	8.5 ± 7.1 (311)
Intensive care stay	3.3 ± 4.8 (234)	3.7 ± 7.1 (63)	3.4 ± 5.3 (297)

\*Mean ± SD (Total no.).

### Quality of Life (QoL)

The KCCQ clinical summary scores at baseline and 30 days are shown in Figure 76. The mean KCCQ summary score improved from 31.6 at baseline to 68.2 at 30 days.

**Figure 76:**  
**KCCQ Overall Summary Score - Mitral Valve-in-Valve (Valve Implant Population)**



Note: Line plot with mean and standard deviation. The total number of patients at each time point only counted the patients with valid values.

**Procedural Information**

The procedural information is presented in Table 76. The most common delivery approach for the mitral valve-in-valve implantation was the transapical approach, which was used in 65.3% (203 of 311) of cases, followed by the transseptal approach in 27.0% (84 of 311) of cases, the transfemoral approach in 6.1% (19/311) of cases, and other alternative approaches in 1.6% (5 of 311) of cases. The procedures were considered elective in 71.0% (220/310) of cases, urgent in 27.7% (86/310) of cases, and emergent or salvage in 1.3% (4/310) of cases. Two (2) cases were aborted and 5 were converted to open heart surgery. Overall, the device was implanted successfully in 97.4% (303/311) of the cases, which was defined as correct positioning of a single prosthetic heart valve in the proper anatomical location.

**Table 76:  
Procedural Data Summary - Mitral Valve-in-Valve  
(Attempted Implant Population)**

Procedural Data	Summary Statistics*		
	SAPIEN XT	SAPIEN 3	All
Operator reason for procedure			
Inoperable/extreme risk	96/241 (39.8%)	11/69 (15.9%)	107/310 (34.5%)
High risk	141/241 (58.5%)	52/69 (75.4%)	193/310 (62.3%)
Intermediate risk	4/241 (1.7%)	5/69 (7.2%)	9/310 (2.9%)
Low risk	0/241 (0.0%)	1/69 (1.4%)	1/310 (0.3%)
Implant approach			
Transapical	192/241 (79.7%)	11/70 (15.7%)	203/311 (65.3%)
Transseptal	43/241 (17.8%)	41/70 (58.6%)	84/311 (27.0%)
Femoral artery	4/241 (1.7%)	15/70 (21.4%)	19/311 (6.1%)
Other	2/241 (0.8%)	3/70 (4.3%)	5/311 (1.6%)
Prior valve type			
Bioprosthetic stented	143/180 (79.4%)	35/41 (85.4%)	178/221 (80.5%)
Bioprosthetic stentless	37/180 (20.6%)	6/41 (14.6%)	43/221 (19.5%)
Procedure status			
Elective	173/241 (71.8%)	47/69 (68.1%)	220/310 (71.0%)
Urgent	64/241 (26.6%)	22/69 (31.9%)	86/310 (27.7%)
Emergency	2/241 (0.8%)	0/69 (0.0%)	2/310 (0.6%)
Salvage	2/241 (0.8%)	0/69 (0.0%)	2/310 (0.6%)
Valve size			
23 mm	22/241 (9.1%)	5/70 (7.1%)	27/311 (8.7%)
26 mm	93/241 (38.6%)	24/70 (34.3%)	117/311 (37.6%)
29 mm	126/241 (52.3%)	41/70 (58.6%)	167/311 (53.7%)
Cardiopulmonary bypass	25/241 (10.4%)	2/69 (2.9%)	27/310 (8.7%)
Status of CP Bypass			
Elective	20/25 (80.0%)	0/2 (0.0%)	20/27 (74.1%)
Emergent	5/25 (20.0%)	2/2 (100.0%)	7/27 (25.9%)
CP Bypass Time (min)	38.3 ± 51.2 (24)	148.0 ± 157.0 (2)	46.7 ± 65.4 (26)
Type of anesthesia			
General anesthesia	240/241 (99.6%)	68/69 (98.6%)	308/310 (99.4%)
Moderate sedation	0/241 (0.0%)	1/69 (1.4%)	1/310 (0.3%)
Epidural	0/241 (0.0%)	0/69 (0.0%)	0/310 (0.0%)
Combination	1/241 (0.4%)	0/69 (0.0%)	1/310 (0.3%)
Total procedure time (min)	143.6 ± 60.4 (240)	157.7 ± 107.2 (69)	146.7 ± 73.5 (309)
Fluoroscopy time (min)	23.9 ± 20.7 (223)	36.9 ± 27.3 (63)	26.8 ± 22.9 (286)
Device implanted successfully	234/241 (97.1%)	69/70 (98.6%)	303/311 (97.4%)
Procedure aborted	1/241 (0.4%)	1/70 (1.4%)	2/311 (0.6%)
Procedure aborted reason			
Navigation issue after successful access	1/1 (100.0%)	0/1 (0.0%)	1/2 (50.0%)
Other	0/1 (0.0%)	1/1 (100.0%)	1/2 (50.0%)

Procedural Data	Summary Statistics*		
	SAPIEN XT	SAPIEN 3	All
Procedure aborted action			
Conversion to open heart surgery	0/1 (0.0%)	1/1 (100.0%)	1/2 (50.0%)
Other	1/1 (100.0%)	0/1 (0.0%)	1/2 (50.0%)
Conversion to open heart surgery	4/241 (1.7%)	1/70 (1.4%)	5/311 (1.6%)
Tamponade/bleeding in the heart	4/4 (100.0%)	0/1 (0.0%)	4/5 (80.0%)
Other	0/4 (0.0%)	1/1 (100.0%)	1/5 (20.0%)
Mechanical assist device in place at start of procedure	9/241 (3.7%)	4/70 (5.7%)	13/311 (4.2%)
IABP	7/9 (77.8%)	3/4 (75.0%)	10/13 (76.9%)
Catheter-based assist device	2/9 (22.2%)	1/4 (25.0%)	3/13 (23.1%)

\*Categorical measures – no./Total no. (%); continuous measures - mean ± SD (Total no.). The total no. only counted the patients with valid values at the time point.

### **SAPIEN 3 and SAPIEN 3 Ultra THV THV-in-THV – STS/ACC Transcatheter Valve Therapy Registry (TVTR) Analysis**

#### Accountability of PMA Cohorts

At the time of database extract, 242 of the 263 patients were eligible for the 30-day visit and 216 (89.3%) completed the visit within the 30-day follow-up window, defined as the period between 21 days post-procedure and 75 days post-procedure. At 1 year, 200 patients were eligible for the 1-year visit and 136 (68.0%) completed the visit within the follow-up window, defined as the period between 305 days post-procedure and 425 days post-procedure. A detailed summary of the patient accountability at 30 days and 1 year is shown in Table 77.

**Table 77:  
Patient Visit Accountability (AI Population)**

	30-day Visit	1-year Visit
Total patients	263	263
Non-eligible	21	63
Death	19	47
Withdrawal	1	3
Lost to follow-up	1	13
Eligible	242	200
Follow-up visit completed	89.3% (216)	68.0% (136)
Missed visit	10.7% (26)	32.0% (64)

The “Attempted Implant” population consisted of all patients for whom the first vascular access was attempted. The “Valve Implant” population consisted of those patients for whom the valve implant procedure has started and a “No” was indicated for both ‘procedure aborted’ and “conversion to open heart surgery”. The number of patients in the analysis population is shown in Table 78.

**Table 78: Analysis Populations**

Analysis Population	Number of Patients
Attempted Implant Population	263
Valve Implant Population	261

## **Study Population Demographics and Baseline Characteristics**

The demographics and baseline characteristics of the patients, as shown in Table 79, present an elderly, multimorbid cohort of patients, consistent with the high operative risk of the populations.

**Table 79: Patient Demographics and Baseline Characteristics (AI Population)**

<b>Demographics and Baseline Characteristics</b>	<b>Summary Statistics* (N = 263)</b>
Age - years	78.9 ± 10.5
Male sex	55.1% (145/263)
Society of Thoracic Surgeons (STS) score	10.2 ± 8.6 (242)
New York Heart Association (NYHA) class	
I/II	12.3% (32/261)
III/IV	87.7% (229/261)
Previous myocardial infarction	26.6% (70/263)
Previous intervention	
Coronary artery bypass grafting (CABG)	28.1% (74/263)
Percutaneous coronary intervention (PCI)	34.0% (89/262)
Prior aortic valvuloplasty	13.7% (36/263)
Stroke or Cerebrovascular accident (CVA)	18.3% (48/263)
Peripheral vascular disease (PVD)	32.1% (84/262)
Atrial fibrillation/flutter	48.7% (128/263)
Permanent pacemaker	32.2% (84/261)
Porcelain aorta	8.0% (21/262)
Hostile chest	8.7% (23/263)
Echocardiographic findings (Valve Implant Population)	
Valve area (cm <sup>2</sup> )	1.0 ± 0.5 (115)
Mean gradient (mmHg)	29.4 ± 19.0 (135)
Mean left ventricular ejection fraction (LVEF), %	49.3 ± 15.1 (257)
Moderate or severe aortic regurgitation	79.3% (207/261)
Moderate or severe mitral regurgitation	42.1% (98/233)

\*Continuous measures - Mean ± SD (Total no.); Categorical measures – % (no./Total no.)

## **Safety and Effectiveness Results**

### **Safety Endpoints**

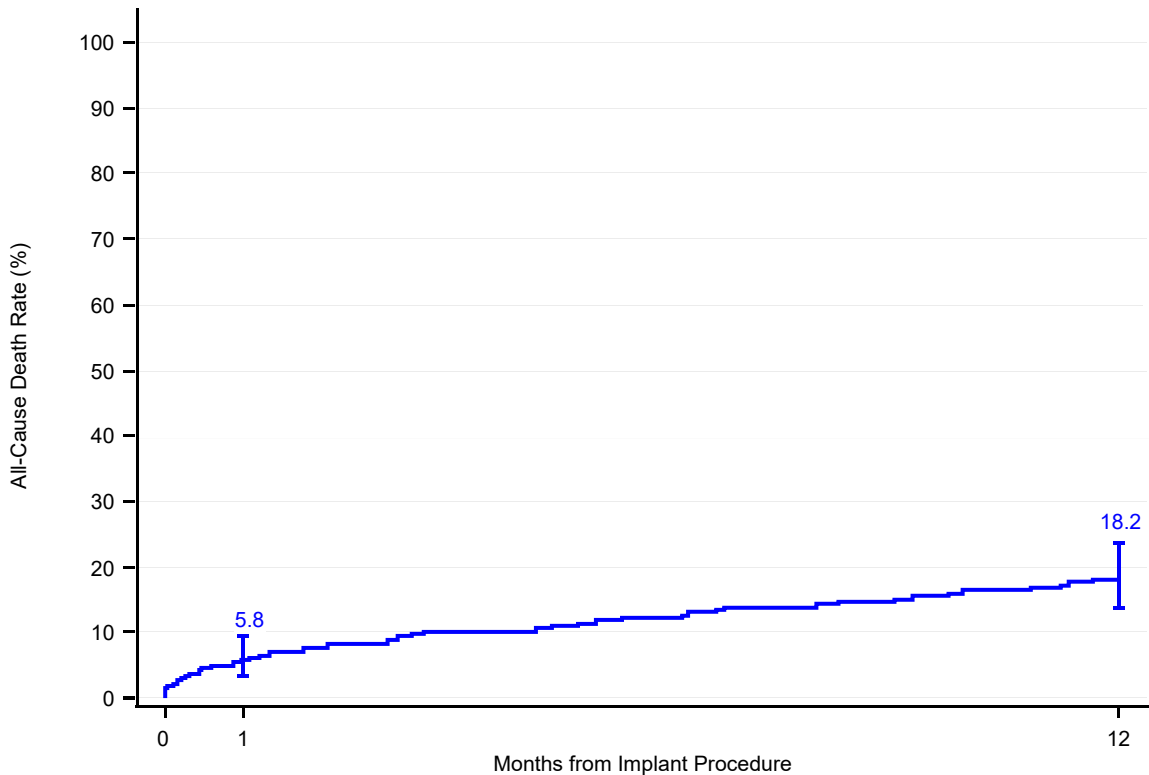
The Kaplan-Meier estimates of site-reported adverse events through 1 year are presented in Table 80. The Kaplan-Meier curve for all-cause mortality is shown in Figure 77. The all-cause mortality rate was 5.8% at 30 days and 18.2% at 1 year, including a cardiovascular death rate of 2.7% at 30 days and 5.4% at 1 year. Other relatively more frequent adverse events included conduction/native pacer disturbance requiring pacer (8.2% at 30 days and 10.6% at 1 year) and valve-related readmission (4.3% at 30 days and 8.6% at 1 year).

**Table 80:  
Site Reported Adverse Events (AI Population)**

Adverse Event	Kaplan-Meier Rate*	
	30 Days (N=263)	1 Year (N=263)
All-cause death	5.8% (15, 15)	18.2% (45, 45)
Cardiovascular death	2.7% (7, 7)	5.4% (13, 13)
All stroke	2.3% (6, 6)	2.8% (7, 7)
Ischemic stroke	1.9% (5, 5)	2.4% (6, 6)
Undetermined stroke	0.4% (1, 1)	0.4% (1, 1)
Transient ischemic attack (TIA)	0.8% (2, 2)	1.9% (4, 4)
Major vascular complication	0.4% (1, 1)	1.0% (2, 2)
Major bleeding	1.2% (3, 3)	2.5% (7, 5)
Myocardial infarction	0.8% (3, 2)	3.1% (6, 5)
New requirement for dialysis	0.4% (1, 1)	1.6% (3, 3)
Conduction/native pacemaker disturbance requiring pacemaker	8.2% (21, 21)	10.6% (25, 25)
Conduction/native pacemaker disturbance requiring implantable cardioverter defibrillator (ICD)	0.4% (1, 1)	2.2% (4, 4)
Aortic valve re-intervention	0.4% (1, 1)	1.2% (2, 2)
Unplanned other cardiac surgery or intervention	2.4% (6, 6)	4.5% (9, 9)
Unplanned vascular surgery or intervention	1.5% (4, 4)	2.6% (6, 6)
Device thrombosis	0.4% (1, 1)	1.0% (2, 2)
Valve-related readmission	4.3% (11, 11)	8.6% (22, 18)

\*Kaplan-Meier rate - (no. of events, no. of patients with the event).

**Figure 77:**  
**All-Cause Mortality through 1 Year (AI Population)**



No. at Risk 263 241

177

**Note:** The 95% confidence intervals were calculated without multiplicity adjustment. The adjusted confidence intervals could be wider than presented here. As such, confidence intervals are provided to illustrate the variability only and should not be used to draw any statistical conclusion.

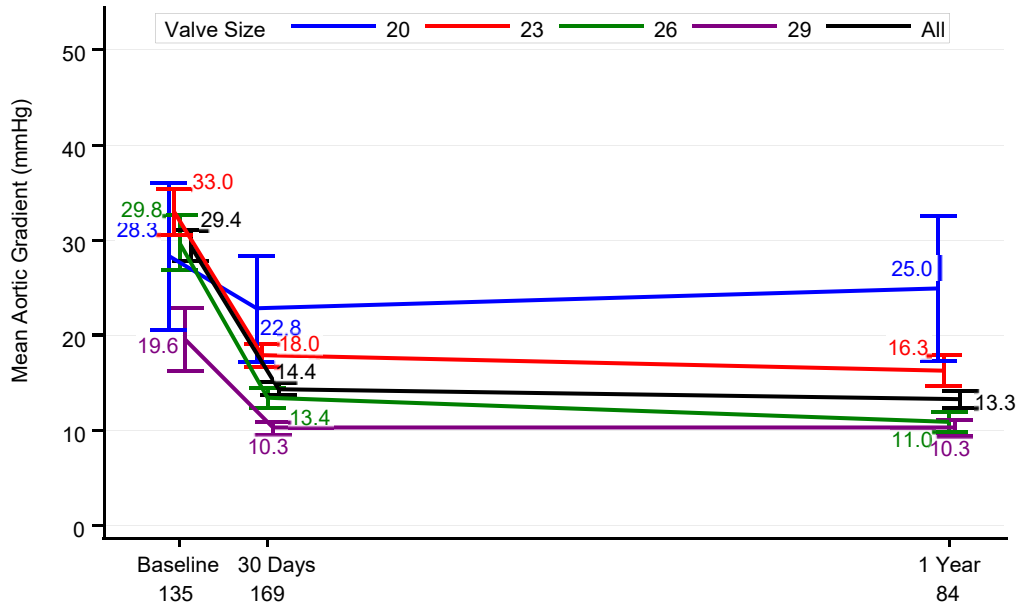
### Effectiveness Endpoints

#### Valve Performance

The echocardiographic valve performance results are shown in Figures 78-80. The decrease in gradients were sustained through 1 year. The mean aortic gradient decreased from 29.4 mmHg at baseline to 14.4 mmHg at 30 days, which was maintained through 1 year (13.3 mmHg). Moderate or severe total aortic regurgitation was observed in 79.3% of the patients at baseline, which decreased to 4.6% at 30 days and 3.4% at 1 year. The proportion of patients with  $\geq$  moderate paravalvular regurgitation was 4.5% at 30 days and 2.6% at 1 year.

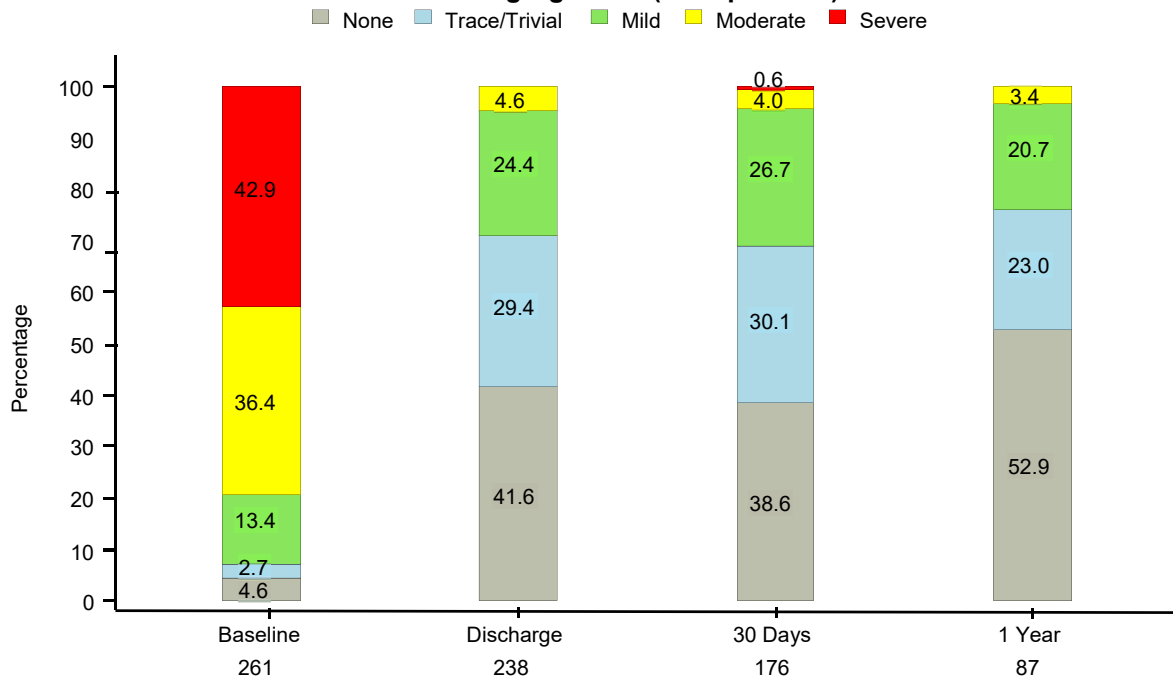


**Figure 78:**  
**Mean Aortic Gradient (VI Population)**

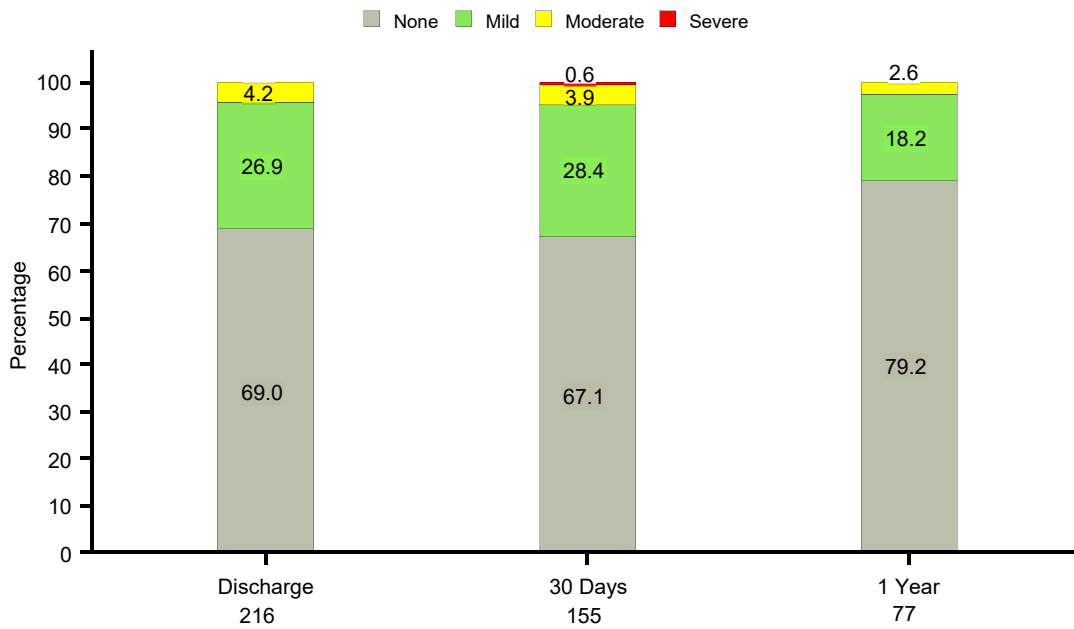


**Note:** Line plot with mean and standard error. The total number of patients at each visit time point only counted the patients with valid values.

**Figure 79:**  
**Total Aortic Regurgitation (VI Population)**



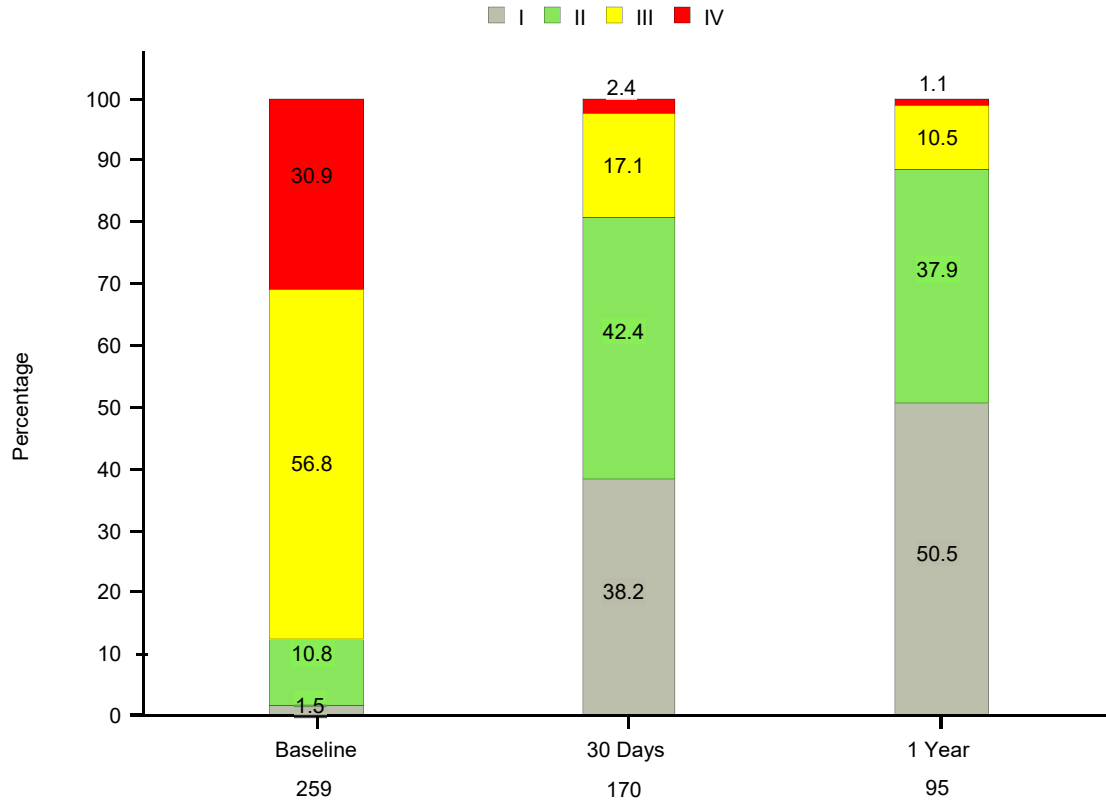
**Figure 80:  
Paravalvular Regurgitation (VI Population)**



**NYHA Functional Class**

The NYHA functional class distributions by visit are presented in Figure 81. At baseline, 87.7% of patients were in NYHA III/IV. At 1 year, the majority (88.4%) of patients were in NYHA I/II.

**Figure 81:  
NYHA Class by Visit (VI Population)**



### Length of Stay

The mean index hospitalization stay was 4.9 days, which included an average of 1.7 days in the intensive care unit (ICU), as summarized in Table 81.

**Table 81:  
Index Hospitalization (AI Population)**

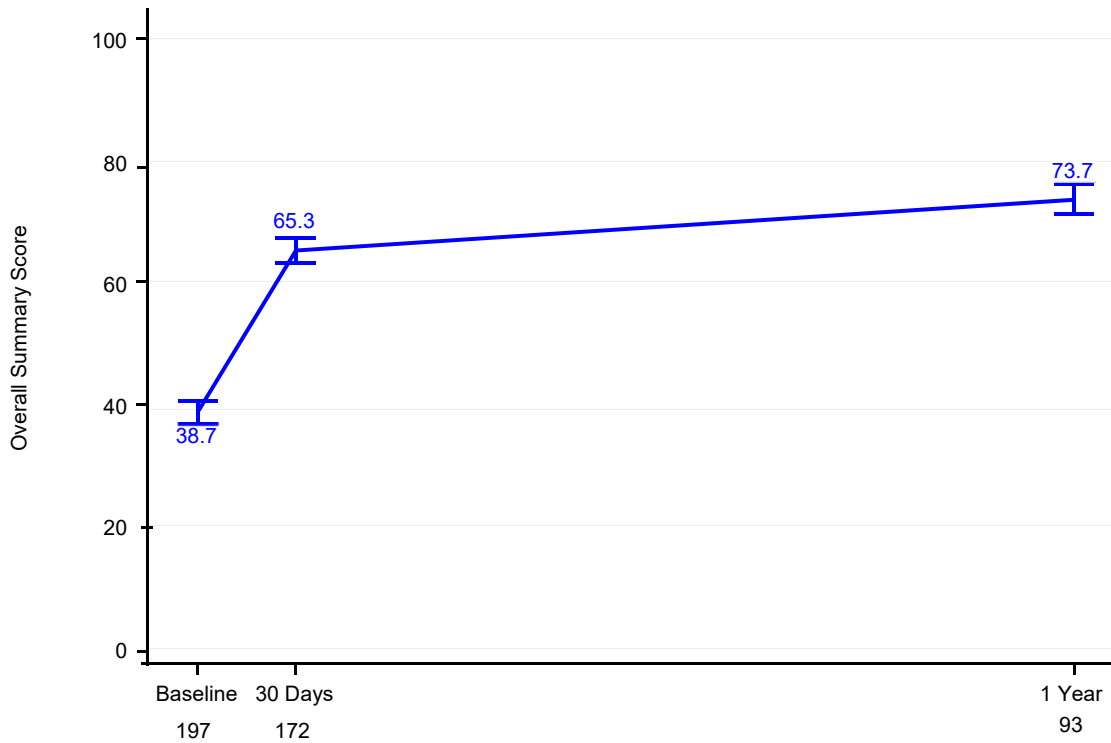
	Length of Stay (days)*
Index hospitalization duration	4.9 ± 0.3 (263)
Intensive care stay	1.7 ± 0.2 (255)

\*Mean ± SE (Total no.)

### Quality of Life

The results for the KCCQ overall summary score are presented in Figure 82. The mean score increased from 38.7 at baseline to 65.3 and 73.7 at 30 days and 1 year, respectively.

**Figure 82:  
KCCQ Overall Summary Score (VI Population)**



**Note:** Line plot with mean and standard error. The total number of patients at each time point only counted patients with valid values.

**Other Study Observations**

Procedural Information

The procedural information is summarized in Table 82. General anesthesia was used in the majority (70%) of patients. Conversion to open heart surgery occurred in two patients due to ventricular rupture and annulus rupture, respectively.

**Table 82:  
Procedural Data Summary (AI Population)**

Procedural Data	Summary Statistics*
Operator reason for procedure	
Inoperable/extreme risk	20.8% (54/259)
High risk	69.1% (179/259)
Intermediate risk	9.7% (25/259)
Low risk	0.4% (1/259)
Implant approach	
Transfemoral	95.8% (252/263)
Transapical	1.1% (3/263)
Transaortic	0.8% (2/263)

Procedural Data	Summary Statistics*
Subclavian/axillary	0.8% (2/263)
Transseptal	0.4% (1/263)
Transcarotid	1.1% (3/263)
Valve size	
20 mm	2.3% (6/263)
23 mm	35.0% (92/263)
26 mm	30.8% (81/263)
29 mm	31.9% (84/263)
Cardiopulmonary bypass	0.4% (1/263)
Cardiopulmonary bypass status	
Emergent	100.0% (1/1)
Cardiopulmonary bypass time, minutes	254.0 ± NA (1)
Type of anesthesia	
General anesthesia	70.0% (184/263)
Moderate sedation	29.7% (78/263)
Combination	0.4% (1/263)
Total procedure time, minutes	108.5 ± 4.3 (263)
Device implanted successfully	98.9% (260/263)
Procedure aborted	0.0% (0/263)
Conversion to open heart surgery	0.8% (2/263)
Ventricular rupture	1
Annulus rupture	1
Mechanical assist device in place at start of procedure	
Catheter-based assist device	100.0% (1/1)

\*Continuous measures - mean ± SE (n); categorical measures - % (no./Total no.)

## **SAPIEN 3 Ultra System**

### **Patient Accountability**

At the time of the database extract, all 40 patients enrolled were implanted, discharged and completed 30 day follow-up.

Patient Demographics and Baseline Characteristics

The demographics and baseline characteristics are shown in Table 83.

**Table 83:  
Patient Demographics and Baseline Characteristics**

Demographics and Baseline Characteristic	Summary Statistics
Age - years	83.4 ± 5.13 (40)
Male sex	24/40 (60.0%)
Society of Thoracic Surgeons (STS) score	3.4 ± 1.27 (40)

Demographics and Baseline Characteristic	Summary Statistics
New York Heart Association (NYHA) class	
I/II	20/40 (50.0%)
III/IV	20/40 (50.0%)
Previous myocardial infarction	1/40 (2.5%)
Previous intervention	9/40 (22.5%)
Coronary artery bypass grafting (CABG)	3/40 (7.5%)
Percutaneous bypass intervention (PCI)	8/40 (20.0%)
Prior aortic valvuloplasty	0/40 (0.0%)
Cerebrovascular accident (CVA)	1/40 (2.5%)
Peripheral vascular disease	4/40 (10.0%)
Atrial fibrillation	19/40 (47.5%)
Prior pacemaker	5/40 (12.5%)
Porcelain aorta	0/40 (0.0%)
Echocardiographic findings	
Valve area - cm <sup>2</sup>	0.7 ± 0.16 (40)
Mean aortic-valve gradient -mmHg	51.0 ± 13.17 (40)
Mean left ventricular ejection fraction (LVEF) %	60.6 ± 7.06 (40)
Moderate or severe aortic regurgitation	1/39 (2.6%)
*Continuous measures—Mean ± SD (Total no.); Categorical measures—n./Total no. (%)	

## **Safety and Effectiveness Results**

### **Primary Endpoint**

The primary endpoint was procedural success, defined as freedom from mortality, conversion to surgery, and moderate or severe PVR at exit from the procedure room which was achieved in all subjects as outlined in Table 84.

**Table 84:  
Primary Endpoint Analysis.**

Primary Endpoint	Results
Overall procedural success	40/40 (100.0%)
Freedom from mortality at exit from procedure room	40/40 (100.0%)
Freedom from conversion to surgery at exit from procedure room	40/40 (100.0%)
Freedom from moderate or severe paravalvular regurgitation at exit from procedure room	40/40 (100.0%)

### **Secondary Endpoints**

There were no major vascular complications, valve migrations, or embolizations through discharge.

### **Adverse Events**

There were no deaths or strokes through 30-days. The selected adverse events for the treated population are presented in Table 85.

**Table 85:  
Selected Adverse Events**

<b>Adverse Event</b>	<b>Discharge*</b>	<b>30 Days†</b>
Major vascular complications	0.0% (0,0)	0.0% (0,0)
Acute kidney injury (Stage III)	0.0% (0,0)	0.0% (0,0)
Life threatening bleeding	0.0% (0,0)	0.0% (0,0)
Major bleeding	5.0% (2,2)	5.0% (2,2)
Hematoma	5.0% (2,2)	5.0% (2,2)
Bleeding at access site	15.0% (6,6)	15.0% (6,6)
Dissection	2.5% (1,1)	2.5% (1,1)
Pseudoaneurysm	2.5% (1,1)	2.5% (1,1)
Aortic-valve reintervention	0.0% (0,0)	0.0% (0,0)
Endocarditis	0.0% (0,0)	0.0% (0,0)
Device thrombosis	0.0% (0,0)	0.0% (0,0)
*Observed rate,% (no. of events, no. of subjects with the event) †Kaplan-Meier estimate,% (no. of events, no. of subjects with the event)		

The new conduction abnormalities requiring permanent pacemaker implantation through 30-days for the first 20 subjects and the last 20 subjects are presented in Table 86.

**Table 86:  
New Conduction Abnormalities Requiring Permanent Pacemaker Implantation**

<b>Adverse Event</b>	<b>First 20 Subjects</b>		<b>Last 20 Subjects</b>	
	<b>Discharge*</b>	<b>30 Days†</b>	<b>Discharge*</b>	<b>30 Days†</b>
Conduction disturbance requiring permanent pacemaker‡	29.4% (5,5)	29.4% (5,5)	5.6% (1,1)	5.6% (1,1)
‡5 Subjects (3 from First 20 subject cohort and 2 from Last 20 subject cohort) with baseline pacemaker were excluded from the analysis. *Observed rate,% (no. of events, no. of subjects with the event) †Kaplan-Meier estimate,% (no. of events, no. of subjects with the event)				

## Other Results

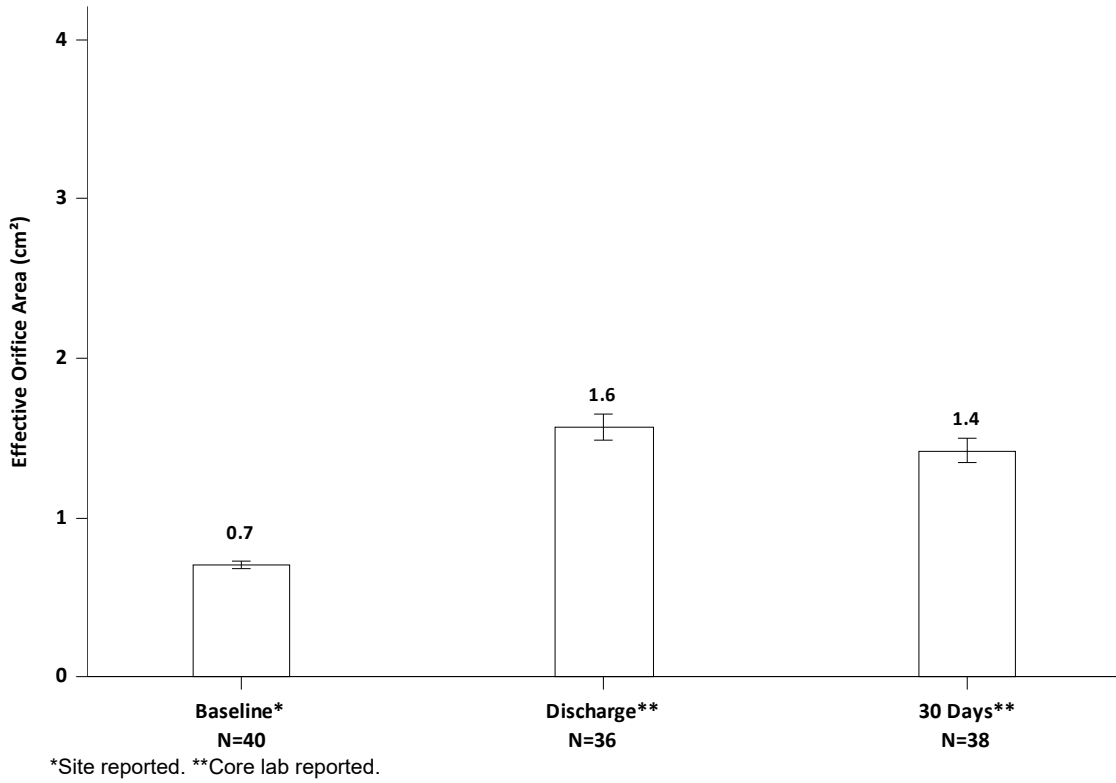
### Procedural Information

Overall, the mean procedure time was 56.5 ± 26.8 minutes. Conscious sedation was utilized in 95% of the patients with one patient converted to general anesthesia. The valve was placed in the intended position in all cases, there were no aborted implantation procedures or conversion to open heart surgery. Successful access, delivery and retrieval of the device and delivery system occurred in all cases. The average length of stay was 4.1 ± 2.4 days.

### Valve Performance

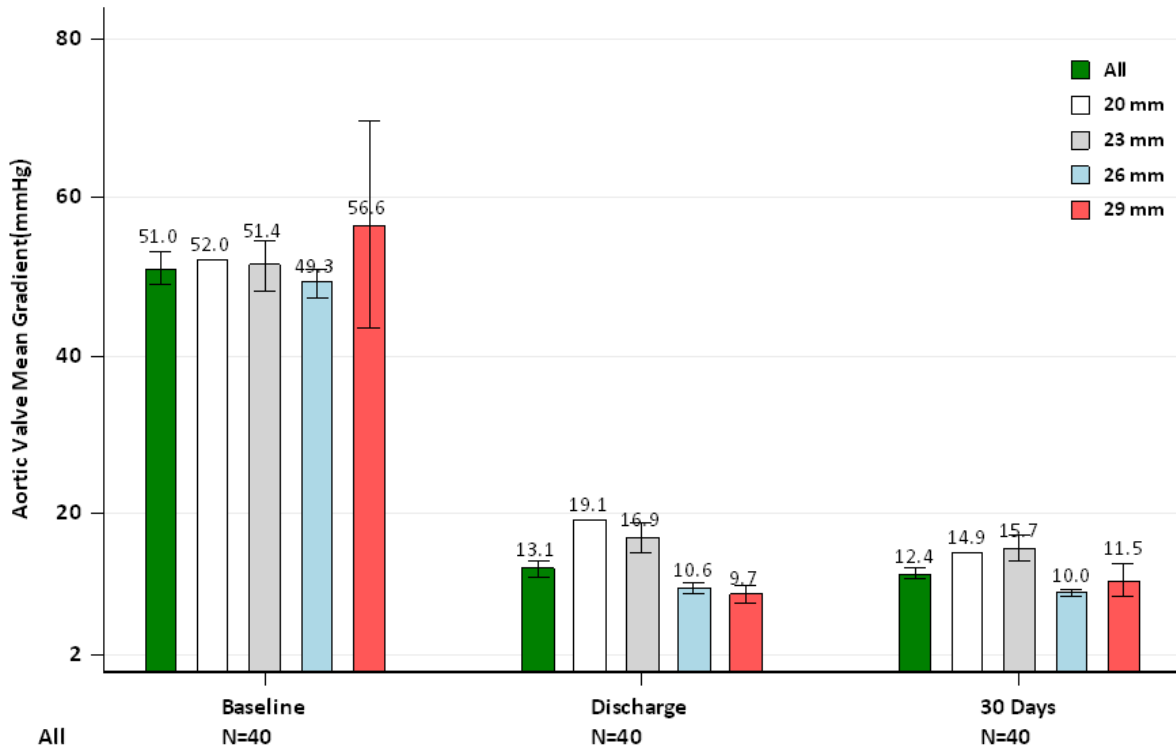
The measurements of effective orifice area, mean gradient, total aortic regurgitation, aortic paravalvular regurgitation (PVL) are presented in Figures 83-86. Mean EOA increased and gradients decreased. PVL was trace or none in 85% of the patients.

**Figure 83:  
Effective Orifice Area**

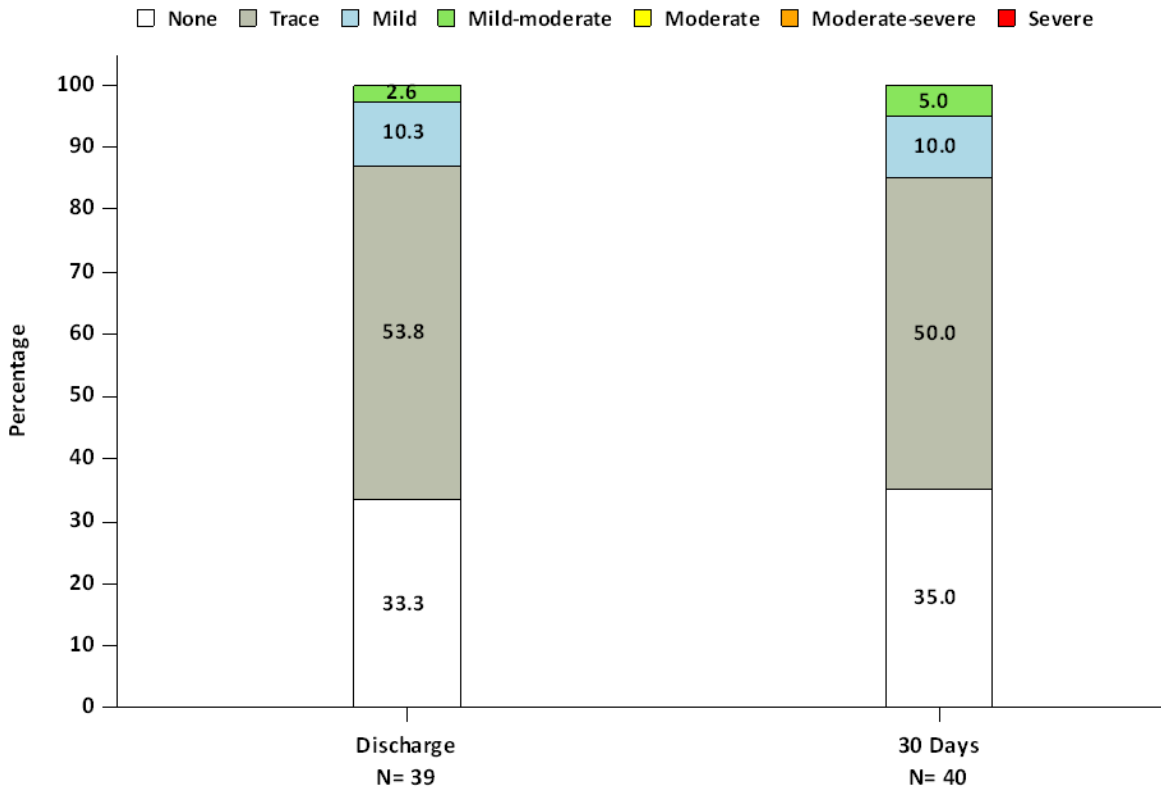




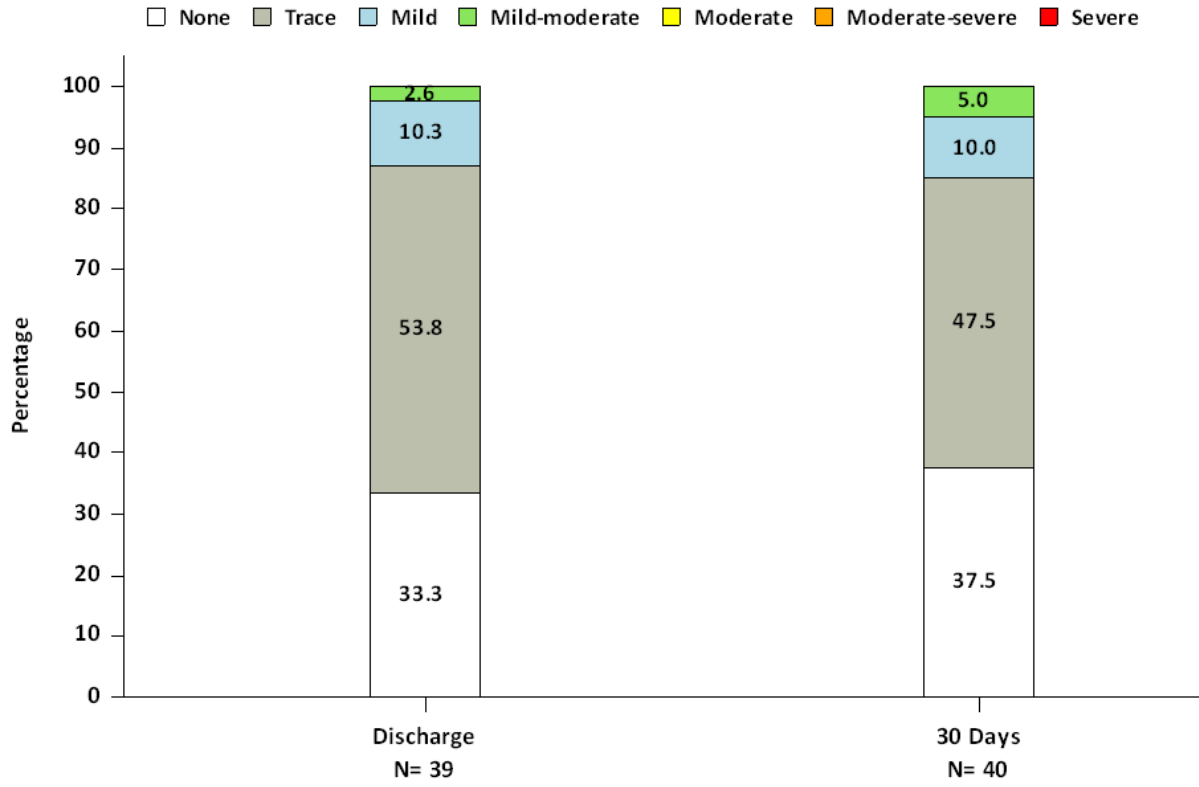
**Figure 84:  
Mean Gradient by Valve Size**



**Figure 85:  
Total Aortic Regurgitation**

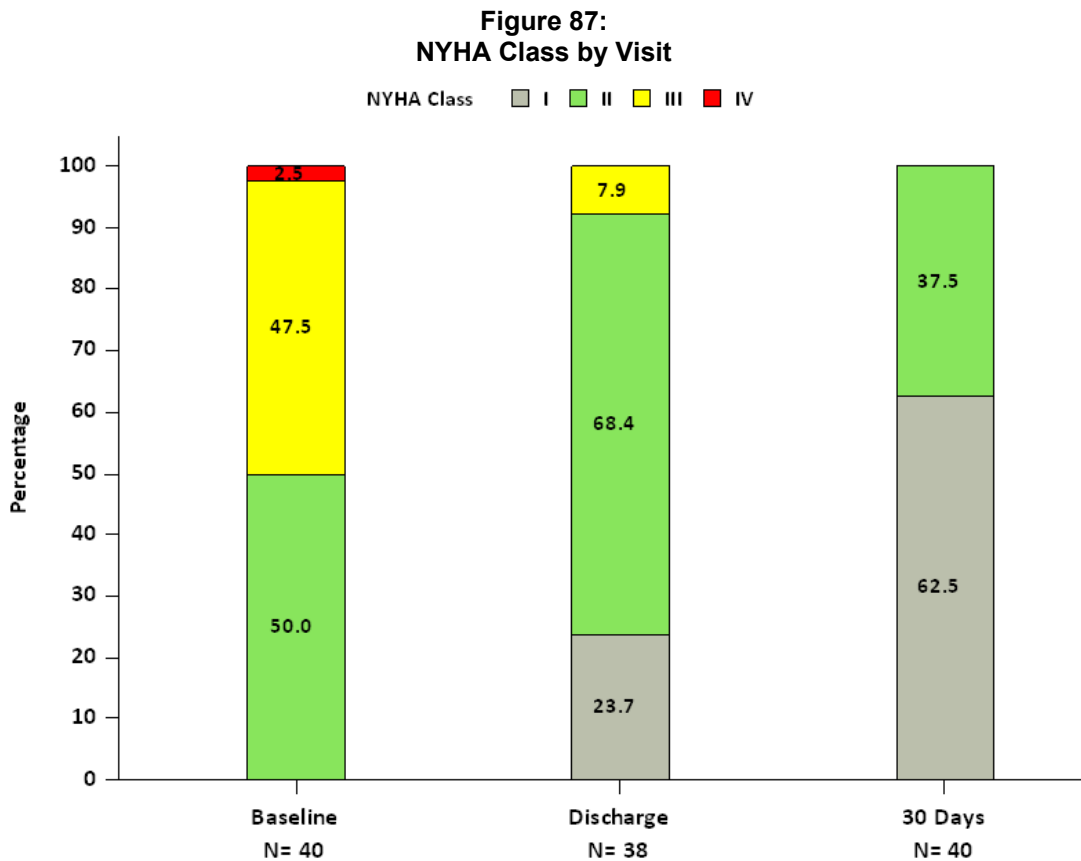


**Figure 86:  
Aortic Paravalvular Regurgitation**



## NYHA

The NYHA Functional Class summary is shown in Figure 87. At 30-day follow-up, 80.0% of subjects experienced improvement in NYHA Class and all subjects were in Class I/II.



## REFERENCES

- [1] Bapat V, Attia R, Thomas M. Effect of Valve Design on the Stent Internal Diameter of a Bioprosthetic Valve: A Concept of True Internal Diameter and Its Implications for the Valve-in-Valve Procedure. *JACC: Cardiovascular Interventions*. Vol. 7, No. 2 2014: 115-127
- [2] Kappetein AP, Head SJ, Génèreux P, et al. Updated standardized endpoint definitions for transcatheter aortic valve implantation: the Valve Academic Research Consortium-2 consensus document (VARC-2). *Eur J Cardiothorac Surg* 2012;42: S45-60.
- [3] Imbens G. W. (2004) Nonparametric Estimation of Average Treatment Effects under Exogeneity: A Review. *The Review of Economics and Statistics*, February 2004, 86(1): 4–29.
- [4] Abbas AE, et al. (2020) Hemodynamic principles of prosthetic aortic valve evaluation in the transcatheter aortic valve replacement era. *Echocardiography*, 2020;37:738-757.

These products are manufactured and sold under one or more of the following US patent(s): US Patent No. 7,530,253; 7,780,723; 7,895,876; 8,382,826; 8,591,575; 8,690,936; 8,790,387; 9,061,119; 9,301,840; 9,301,841; 9,339,384; 9,393,110; and corresponding foreign patents.



09/2020  
© Copyright 2020, Edwards Lifesciences LLC  
All rights reserved.

---


Manufacturer   
**Edwards Lifesciences LLC**  
One Edwards Way  
Irvine, CA 92614 USA

Telephone 949.250.2500  
800.424.3278  
FAX 949.250.2525

Web IFU  
10033859005 A



**Vendor: Do Not Print This Page.  
For Internal Edwards Lifesciences Use Only.**

	Title: IFU,S3 COMMANDER DS, LOW RISK	Page: 124 of 124
	Label Item/Revision: 10033859005/A	
	Visual Representation/Revision:	
	Drawing/Specification: DOC-0001941	
	English Master/Revision: N/A	
	eIFU Visual Representation: N/A	
	Refer to supporting material for signatures.	

**NOTE**

**1. ALL ART PRINTS 100% BLACK UNLESS OTHERWISE NOTED.**

**INKS**

**BLACK**

**GRAYSCALE 55% BLACK**



Edwards

## **Edwards SAPIEN 3 and SAPIEN 3 Ultra Transcatheter Heart Valve System**

### **SAPIEN 3 and SAPIEN 3 Ultra Transcatheter Heart Valve Edwards Certitude Delivery System**

#### **Instructions for Use**

**CAUTION:** Federal (USA) law restricts these devices to sale by or on the order of a physician.

Implantation of the transcatheter heart valve should be performed only by physicians who have received Edwards Lifesciences training. The implanting physician should be experienced in balloon aortic valvuloplasty.

Please verify that you have the latest version of the instructions for use prior to using the device by visiting <http://THVIFU.edwards.com> or by calling 1.800.822.9837. In order to access the instructions for use, an IFU Code will be required.

**STERILE:** The valve is supplied sterilized with glutaraldehyde solution. The delivery system, introducer sheath set, and crimper are supplied sterilized with ethylene oxide gas.

## 1.0 Device Description

### Edwards SAPIEN 3 and SAPIEN 3 Ultra Transcatheter Heart Valve (THV) System

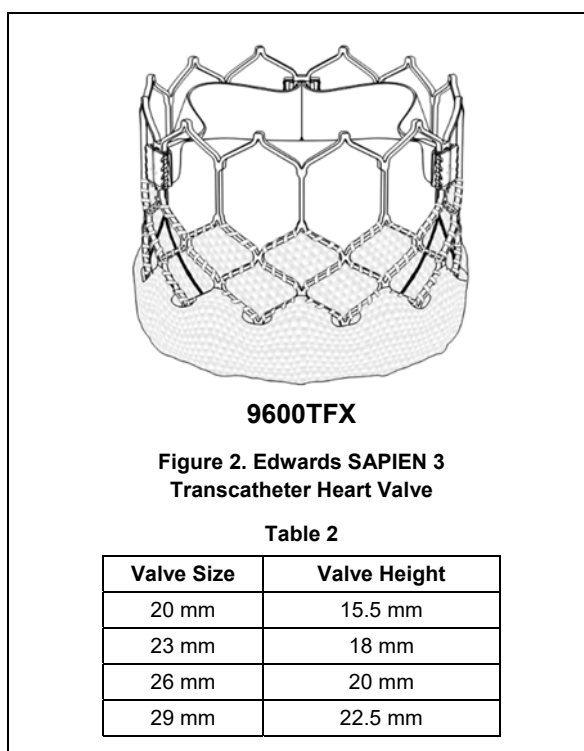
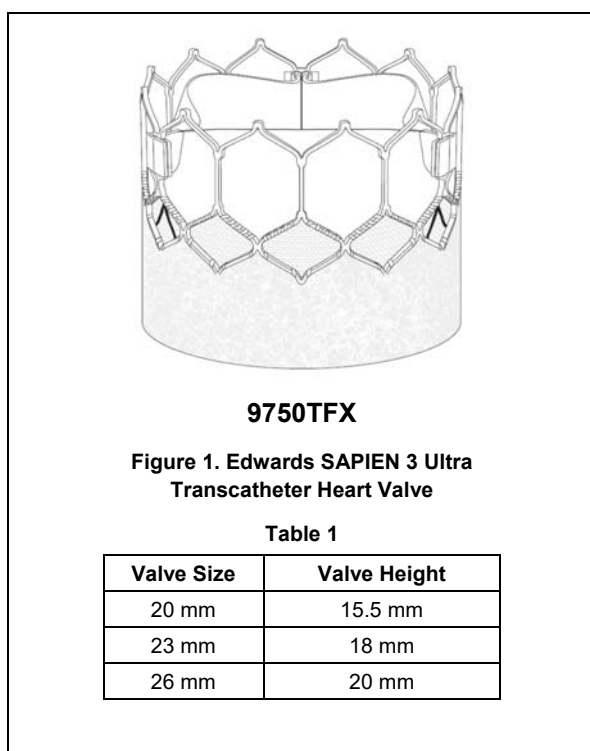
The Edwards SAPIEN 3 and SAPIEN 3 Ultra Transcatheter Heart Valve system consists of the Edwards SAPIEN 3 and SAPIEN 3 Ultra transcatheter heart valves and delivery systems.

- **Edwards SAPIEN 3 Ultra Transcatheter Heart Valve – (Figure 1)**

The Edwards SAPIEN 3 Ultra transcatheter heart valve is comprised of a balloon-expandable, radiopaque, cobalt-chromium frame, trileaflet bovine pericardial tissue valve, and polyethylene terephthalate (PET) inner and outer fabric skirts. The leaflets are treated according to the Carpentier-Edwards ThermaFix process.

- **Edwards SAPIEN 3 Transcatheter Heart Valve – (Figure 2)**

The Edwards SAPIEN 3 transcatheter heart valve is comprised of a balloon-expandable, radiopaque, cobalt-chromium frame, trileaflet bovine pericardial tissue valve, and polyethylene terephthalate (PET) fabric skirt. The leaflets are treated according to the Carpentier-Edwards ThermaFix process.



Sizing recommendations for implanting the Edwards SAPIEN 3 Ultra transcatheter heart valve and the Edwards SAPIEN 3 transcatheter heart valve in a native annulus are provided in the table below:

**Table 3**

Native Valve Annulus Size (TEE)	Native Valve Annulus Size (CT)		THV Size
	Area	Area Derived Diameter	
16 – 19 mm	273 – 345 mm <sup>2</sup>	18.6 – 21 mm	20 mm
18 – 22 mm	338 – 430 mm <sup>2</sup>	20.7 – 23.4 mm	23 mm
21 – 25 mm	430 – 546 mm <sup>2</sup>	23.4 – 26.4 mm	26 mm
24 – 28 mm	540 – 683 mm <sup>2</sup>	26.2 – 29.5 mm	29 mm

Valve size recommendations are based on native valve annulus size, as measured by transesophageal echocardiography (TEE) or computed tomography (CT). Patient anatomical factors and multiple imaging modalities should be considered during valve size selection.

**NOTE:** Risks associated with undersizing and oversizing should be considered.

Sizing recommendations for implanting the Edwards SAPIEN 3 Ultra transcatheter heart valve and the Edwards SAPIEN 3 transcatheter heart valve in a failing surgical bioprosthesis, except for the INSPIRIS RESILIA aortic valve sizes 19-25 mm, are provided in the table below:

**Table 4a**

<b>Surgical Valve True Inner Diameter (ID)<sup>[1]</sup></b>	<b>THV Size</b>
16.5 – 19.0 mm	20 mm
18.5 – 22.0 mm	23 mm
22.0 – 25.0 mm	26 mm
25.0 – 28.5 mm	29 mm

**NOTE: Surgical valve ‘True ID’ may be smaller than the labeled valve size. For THV-in-THV, the native valve annulus size should be considered to determine the appropriate THV size to implant. For a failing stentless bioprosthesis, consider sizing recommendations for a native annulus. The dimensions of the failed bioprosthesis should be determined so that the appropriate THV size can be implanted; and is best determined by using computed tomography, magnetic resonance imaging, and/or transesophageal echocardiography.**

Sizing recommendations for implanting the Edwards SAPIEN 3 Ultra transcatheter heart valve and the SAPIEN 3 transcatheter heart valve in a failing INSPIRIS RESILIA aortic surgical bioprosthesis in sizes 19 – 25 mm are provided in the table below:

**Table 4b**

<b>INSPIRIS RESILIA Aortic Valve (model 11500A)* Labeled Size</b>	<b>THV Size</b>
19 mm	20 mm or 23 mm
21 mm	23 mm or 26 mm
23 mm	26 mm
25 mm	29 mm

\*INSPIRIS RESILIA aortic valve model 11500A sizes 19 – 25 mm incorporate VFit technology which consists of expandable bands and fluoroscopically visible size markers designed for potential future valve-in-valve procedures. Clinical data are not currently available on the INSPIRIS RESILIA aortic valve Model 11500A valve-in-valve procedure or expansion feature. The impact of tissue ingrowth on the expansion feature of the INSPIRIS RESILIA aortic valve has not been assessed.

**WARNING: Do not perform stand-alone balloon aortic valvuloplasty procedures in the INSPIRIS RESILIA aortic valve for the sizes 19-25 mm. This may expand the valve causing aortic incompetence, coronary embolism or annular rupture.**

**NOTE: INSPIRIS RESILIA aortic valve model 11500A sizes 27 – 29 mm do not incorporate VFit technology and therefore follow the surgical valve True ID sizing provided in table 4a.**

**NOTE: Exact volume required to deploy the THV may vary depending on the bioprosthesis inner diameter. Factors such as calcification and pannus tissue growth may not be accurately visualized in imaging and may reduce the effective inner diameter of the failing bioprosthesis to a size smaller than the ‘True ID’. These factors should be considered and assessed in order to determine the most appropriate THV size to achieve nominal THV deployment and sufficient anchoring. Do not exceed the rated burst pressure. See Table 5 for inflation parameters.**

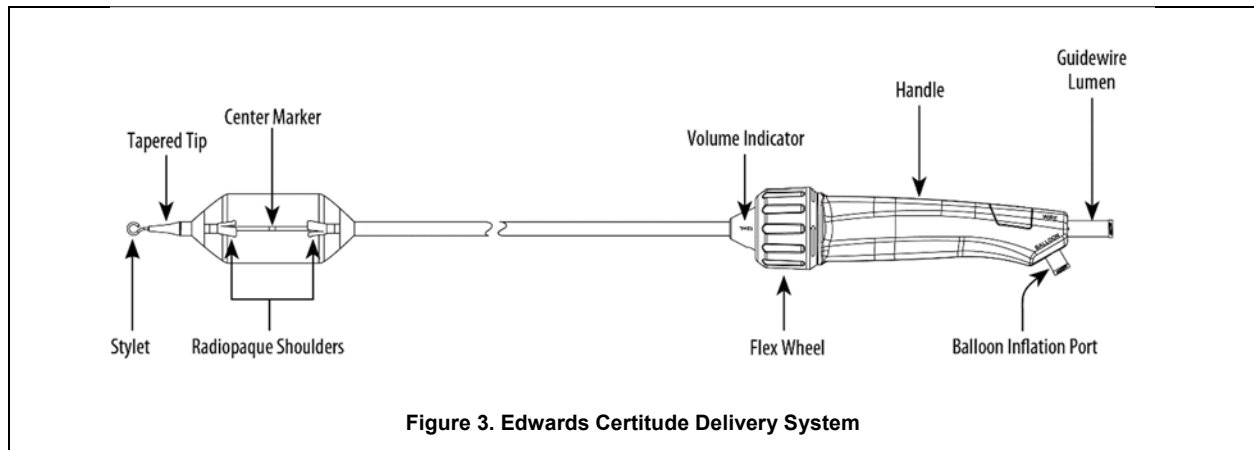


• **Edwards Certitude Delivery System (Figure 3)**

The Edwards Certitude delivery system facilitates the placement of the bioprosthesis. The delivery system consists of a Flex Catheter to aid in tracking and valve positioning. The delivery system includes a tapered tip to facilitate crossing of the valve. The handle contains a Flex Wheel to control flexing of the balloon catheter. A stylet is included within the guidewire lumen of the delivery system. A radiopaque Center Marker in the balloon is provided to assist with valve positioning. The inflation parameters for valve deployment are:

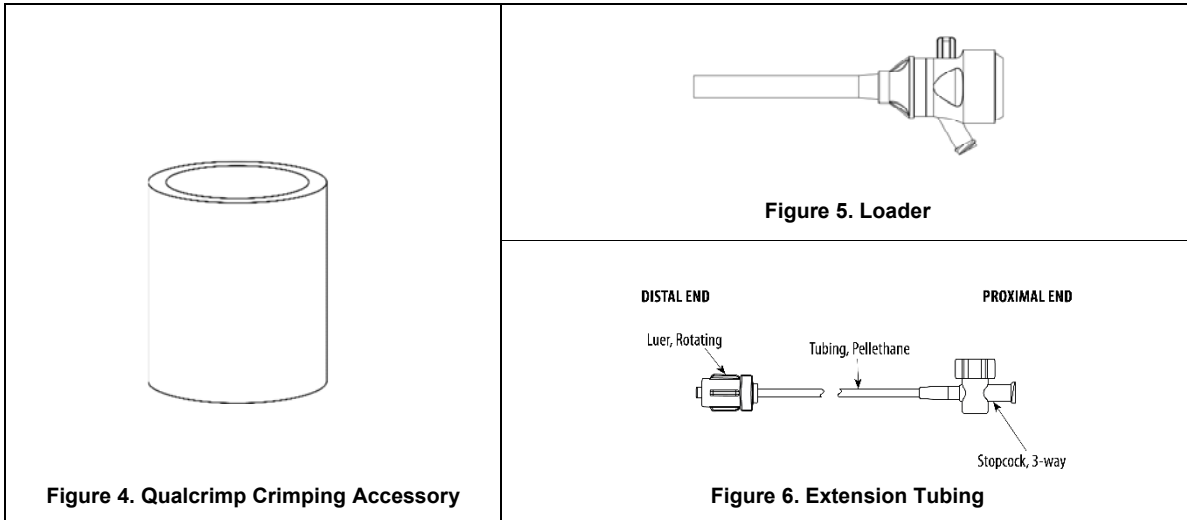
**Table 5**

Model	Nominal Balloon Diameter	Nominal Inflation Volume	Rated Burst Pressure (RBP)
9630TA20 9600SDS20	20 mm	12 mL	7 atm
9630TA23 9600SDS23	23 mm	17 mL	7 atm
9630TA26 9600SDS26	26 mm	23 mL	7 atm
9630TA29 9600SDS29	29 mm	30 mL	7 atm



**Figure 3. Edwards Certitude Delivery System**

**Additional Accessories**



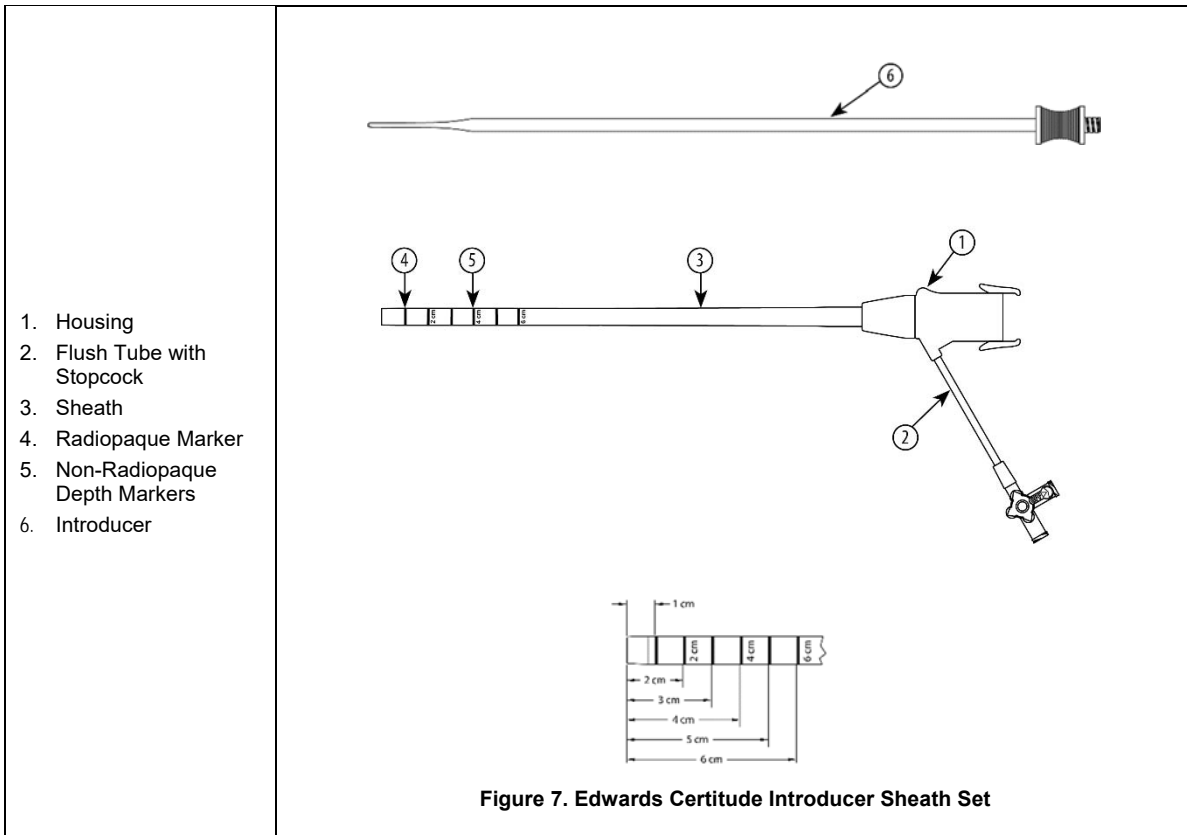
**Figure 4. Qualcrimp Crimping Accessory**

**Figure 5. Loader**

**Figure 6. Extension Tubing**

**• Edwards Certitude Introducer Sheath Set (Figure 7)**

The Edwards Certitude introducer sheath set facilitates the introduction and removal of devices utilized with the SAPIEN 3 and SAPIEN 3 Ultra transcatheter heart valves. The sheath has a radiopaque marker for visualization of the sheath tip and non-radiopaque depth markings on the distal end of the body of the sheath. The proximal end of the sheath includes a flush tube and three hemostasis valves. An introducer is supplied with the sheath. The entire introducer is radiopaque.



**Figure 7. Edwards Certitude Introducer Sheath Set**

**Edwards Crimper**

Refer to the Edwards Crimper instructions for use for device description.

## 2.0 Indications

- 1) The Edwards SAPIEN 3 and SAPIEN 3 Ultra Transcatheter Heart Valve system is indicated for relief of aortic stenosis in patients with symptomatic heart disease due to severe native calcific aortic stenosis who are judged by a Heart Team, including a cardiac surgeon, to be appropriate for the transcatheter heart valve replacement therapy.
- 2) The Edwards SAPIEN 3 and SAPIEN 3 Ultra Transcatheter Heart Valve system is indicated for patients with symptomatic heart disease due to failing (stenosed, insufficient, or combined) of a surgical or transcatheter bioprosthetic aortic valve or a surgical bioprosthetic mitral valve who are judged by a heart team, including a cardiac surgeon, to be at high or greater risk for open surgical therapy (i.e., predicted risk of surgical mortality  $\geq$  8% at 30 days, based on the Society of Thoracic Surgeons (STS) risk score and other clinical co-morbidities unmeasured by the STS risk calculator).

## 3.0 Contraindications

The valve and delivery systems are contraindicated in patients who cannot tolerate an anticoagulation/antiplatelet regimen or who have active bacterial endocarditis or other active infections.

## 4.0 Warnings

- Observation of the pacing lead throughout the procedure is essential to avoid the potential risk of pacing lead perforation.
- There may be an increased risk of stroke in transcatheter aortic valve replacement procedures, as compared to balloon aortic valvuloplasty or other standard treatments in high or greater risk patients.
- The devices are designed, intended, and distributed for single use only. **Do not resterilize or reuse the devices.** There are no data to support the sterility, nonpyrogenicity, and functionality of the devices after reprocessing.
- Incorrect sizing of the valve may lead to paravalvular leak, migration, embolization, residual gradient (patient-prosthesis mismatch) and/or annular rupture.
- Accelerated deterioration of the valve may occur in patients with an altered calcium metabolism.
- Prior to delivery, the valve must remain hydrated at all times and cannot be exposed to solutions other than its shipping storage solution and sterile physiologic rinsing solution. Valve leaflets mishandled or damaged during any part of the procedure will require replacement of the valve.
- Caution should be exercised in implanting a valve in patients with clinically significant coronary artery disease.
- Patients with pre-existing prostheses should be carefully assessed prior to implantation of the valve to ensure proper valve positioning and deployment.
- Do not use the valve if the tamper evident seal is broken, the storage solution does not completely cover the valve, the temperature indicator has been activated, the valve is damaged, or the expiration date has elapsed.
- Do not mishandle the delivery system or use it if the packaging or any components are not sterile, have been opened or are damaged (e.g. kinked or stretched), or the expiration date has elapsed.
- Use of excessive contrast media may lead to renal failure. Measure the patient's creatinine level prior to the procedure. Contrast media usage should be monitored.
- Care should be exercised in patients with hypersensitivities to cobalt, nickel, chromium, molybdenum, titanium, manganese, silicon, and/or polymeric materials.
- The procedure should be conducted under fluoroscopic guidance. Some fluoroscopically guided procedures are associated with a risk of radiation injury to the skin. These injuries may be painful, disfiguring, and long-lasting.
- Valve recipients should be maintained on anticoagulant/antiplatelet therapy, except when contraindicated, as determined by their physician. This device has not been tested for use without anticoagulation.
- Do not add or apply antibiotics to the storage solution, rinse solutions, or to the valve.
- Balloon valvuloplasty should be avoided in the treatment of failing bioprostheses as this may result in embolization of bioprosthesis material and mechanical disruption of the valve leaflets.

## 5.0 Precautions

- Long-term durability has not been established for the valve. Regular medical follow-up is advised to evaluate valve performance.

- Limited clinical data are available for transcatheter aortic valve replacement in patients with a congenital bicuspid valve who are deemed to be low surgical risk. Anatomical characteristics should be considered when using this valve in this population. In addition, patient age should be considered as long-term durability for this valve has not been established.
- Glutaraldehyde may cause irritation of the skin, eyes, nose and throat. Avoid prolonged or repeated exposure to, or breathing of, the solution. Use only with adequate ventilation. If skin contact occurs, immediately flush the affected area with water; in the event of contact with eyes, seek immediate medical attention. For more information about glutaraldehyde exposure, refer to the Material Safety Data Sheet available from Edwards Lifesciences.
- To maintain proper valve leaflet coaptation, do not overinflate the deployment balloon.

Appropriate antibiotic prophylaxis is recommended post-procedure in patients at risk for prosthetic valve infection and endocarditis. Special care must be exercised in mitral valve replacement if chordal preservation techniques were used in the primary implantation to avoid entrapment of the subvalvular apparatus.

- Safety and effectiveness have not been established for patients with the following characteristics/comorbidities:
  - Non-calcified aortic annulus
  - Severe ventricular dysfunction with ejection fraction < 20%
  - Congenital unicuspid aortic valve
  - Pre-existing prosthetic ring in any position
  - Severe mitral annular calcification (MAC), severe (> 3+) mitral insufficiency, or Gorlin syndrome
  - Blood dyscrasias defined as: leukopenia (WBC < 3,000 cells/mL), acute anemia (Hb < 9 g/dL), thrombocytopenia (platelet count < 50,000 cells/mL), or history of bleeding diathesis or coagulopathy
  - Hypertrophic cardiomyopathy with or without obstruction (HOCM)
  - Echocardiographic evidence of intracardiac mass, thrombus, or vegetation
  - A known hypersensitivity or contraindication to aspirin, heparin, ticlopidine (Ticlid™), or clopidogrel (Plavix™), or sensitivity to contrast media, which cannot be adequately premedicated
  - Excessive calcification at access site
  - Bulky calcified aortic valve leaflets in close proximity to coronary ostia
  - A concomitant paravalvular leak where the failing bioprosthesis is not securely fixed in the native annulus or is not structurally intact (e.g. wireform frame fracture)
  - A partially detached leaflet of the failing bioprosthesis that in the aortic position may obstruct a coronary ostium
  - Residual mean gradient may be higher in a “THV-in-failing bioprosthesis” configuration than that observed following implantation of the valve inside a native aortic annulus using the same size device. Patients with elevated mean gradient post procedure should be carefully followed. It is important that the manufacturer, model and size of the preexisting bioprosthetic valve be determined, so that the appropriate valve can be implanted and a prosthesis-patient mismatch be avoided. Additionally, pre-procedure imaging modalities must be employed to make as accurate a determination of the inner diameter as possible.

## 6.0 Potential Adverse Events

Potential risks associated with the overall procedure including potential access complications associated with standard cardiac catheterization, balloon valvuloplasty, the potential risks of conscious sedation and/or general anesthesia, and the use of angiography:

- Death
- Stroke/transient ischemic attack, clusters or neurological deficit
- Paralysis
- Permanent disability

- Respiratory insufficiency or respiratory failure
- Hemorrhage requiring transfusion or intervention
- Cardiovascular injury including perforation or dissection of vessels, ventricle, atrium, myocardium or valvular structures that may require intervention
- Pericardial effusion or cardiac tamponade
- Embolization including air, calcific valve material or thrombus
- Infection including septicemia and endocarditis
- Heart failure
- Myocardial infarction
- Renal insufficiency or renal failure
- Conduction system defect which may require a permanent pacemaker
- Arrhythmia
- Retroperitoneal bleed
- Arteriovenous (AV) fistula or pseudoaneurysm
- Reoperation
- Ischemia or nerve injury
- Restenosis
- Pulmonary edema
- Pleural effusion
- Bleeding
- Anemia
- Abnormal lab values (including electrolyte imbalance)
- Hypertension or hypotension
- Allergic reaction to anesthesia, contrast media, or device materials
- Hematoma
- Syncope
- Pain or changes at the access site
- Exercise intolerance or weakness
- Inflammation
- Angina
- Heart murmur
- Fever

Additional potential risks associated with the use of the valve, delivery system, and/or accessories include:

- Cardiac arrest
- Cardiogenic shock
- Emergency cardiac surgery
- Cardiac failure or low cardiac output
- Coronary flow obstruction/transvalvular flow disturbance
- Device thrombosis requiring intervention
- Valve thrombosis
- Device embolization
- Device migration or malposition requiring intervention
- Left ventricular outflow tract obstruction

- Valve deployment in unintended location
- Valve stenosis
- Structural valve deterioration (wear, fracture, calcification, leaflet tear/tearing from the stent posts, leaflet retraction, suture line disruption of components of a prosthetic valve, thickening, stenosis)
- Device degeneration
- Paravalvular or transvalvular leak
- Valve regurgitation
- Hemolysis
- Injury to the mitral valve
- Device explants
- Mediastinitis
- Mediastinal bleeding
- Nonstructural dysfunction
- Mechanical failure of delivery system, and/or accessories
- Non-emergent reoperation

## 7.0 Directions for Use

### 7.1 System Compatibility

**Table 6.**

Product Name	20 mm System	23 mm System	26 mm System
	Model		
Edwards SAPIEN 3 Ultra Transcatheter Heart Valve	9750TFX20	9750TFX23	9750TFX26
Edwards Certitude Delivery System	9630TA20	9630TA23	9630TA26
Edwards Certitude Introducer Sheath Set	9600IS18	9600IS21	
Inflation device, Qualcrimp crimping accessory, 2-piece crimp stopper, loader and extension tubing provided by Edwards Lifesciences			
Edwards Crimper	9600CR		

**Table 7.**

Product Name	20 mm System	23 mm System	26 mm System	29 mm System
	Model			
Edwards SAPIEN 3 Transcatheter Heart Valve	9600TFX20	9600TFX23	9600TFX26	9600TFX29
Edwards Certitude Delivery System	9600SDS20	9600SDS23	9600SDS26	9600SDS29
Edwards Certitude Introducer Sheath Set	9600IS18			9600IS21
Inflation device, Qualcrimp crimping accessory, 2-piece crimp stopper, loader and extension tubing provided by Edwards Lifesciences				
Edwards Crimper	9600CR			

#### Additional Equipment:

- Balloon catheter, per the discretion of the physician
- 20 cc syringe or larger (x2)
- 50 cc syringe or larger

- Standard cardiac catheterization lab equipment
- Fluoroscopy (fixed, mobile or semi-mobile fluoroscopy systems appropriate for use in percutaneous coronary interventions)
- Transesophageal or transthoracic echocardiography capabilities
- 18 gauge Seldinger needle (for transaortic)
- 145 cm x 0.035 inch (0.89 mm) soft guidewire
- 180 cm or 260 cm x 0.035 inch (0.89 mm) & Exchange length 0.035 inch (0.89 mm) extra-stiff guidewire
- Temporary pacemaker (PM) and pacing lead
- Sterile rinsing basins, physiological saline, heparinized saline, 15% diluted radiopaque contrast medium
- Sterile table for valve and device preparation

## 7.2 Valve Handling and Preparation

Follow sterile technique during device preparation and implantation.

### 7.2.1 Valve Rinsing Procedure

Before opening the valve jar, carefully examine for evidence of damage (e.g. a cracked jar or lid, leakage, or broken or missing seals).

**CAUTION: Valves from containers found to be damaged, leaking, without adequate sterilant, or missing intact seals must not be used for implantation.**

Step	Procedure
1	Set up two (2) sterile bowls with at least 500 mL of sterile physiological saline to thoroughly rinse the glutaraldehyde sterilant from the valve.
2	Carefully remove the valve/holder assembly from the jar without touching the tissue. Verify the valve serial identification number with the number on the jar lid and record in the patient information documents. Inspect the valve for any signs of damage to the frame or tissue.
3	Rinse the valve as follows: Place the valve in the first bowl of sterile, physiological saline. Be sure the saline solution completely covers the valve and holder. With the valve and holder submerged, slowly agitate (to gently swirl the valve and holder) back and forth for a minimum of 1 minute. Transfer the valve and holder to the second rinsing bowl of sterile, physiological saline and gently agitate for at least one more minute. Ensure the rinse solution in the first bowl is not used. The valve should be left in the final rinse solution until needed to prevent the tissue from drying.  <b>CAUTION: Do not allow the valve to come into contact with the bottom or sides of the rinse bowl during agitation or swirling in the rinse solution. Direct contact between the identification tag and valve is also to be avoided during the rinse procedure. No other objects should be placed in the rinse bowls. The valve should be kept hydrated to prevent the tissue from drying.</b>

### 7.2.2 Prepare the Components

Refer to the Edwards Crimper instructions for use for device preparation.

Step	Procedure
1	Visually inspect all components for damage. Ensure the Edwards Certitude delivery system is fully unflexed.
2	Prime and flush the introducer and sheath with heparinized saline. Hydrate the length of the introducer and sheath.
3	Advance the introducer fully into the sheath housing.
4	Unscrew the loader cap from the loader and flush the loader cap with heparinized saline.
5	Place the loader cap onto the delivery system with the inside of the cap oriented towards the tapered tip.
6	Flush the extension tubing and connect to the delivery system.
7	Partially fill a 50 mL or larger syringe with diluted contrast medium, and connect to the extension tubing.

Step	Procedure
8	Fill the inflation device with 20 mL of diluted contrast medium, lock the inflation device, and connect to the extension tubing. Close 3-way stopcock to inflation device.
9	De-air the delivery system using the luer lock syringe. Leave zero-pressure in the system. Close the 3-way stopcock to the luer lock syringe.
10	Remove 3 mL fluid from the delivery system by turning the knob of the locked inflation device. Keep the inflation device locked for valve crimping steps.

### 7.2.3 Mount and Crimp the Valve on the Delivery System

Step	Procedure
1	Set up two (2) additional sterile bowls with at least 100 mL of sterile, physiological saline to thoroughly rinse the Qualcrimp crimping accessory.
2	Completely submerge the Qualcrimp crimping accessory in the first bowl and gently compress it to ensure complete saline absorption. Slowly swirl the Qualcrimp crimping accessory for a minimum of 1 minute. Repeat this process in the second bowl.
3	Remove the valve from the holder and remove the ID tag.
4	Attach the 2-piece crimp stopper to the base of the crimper and click into place.
5	With the crimper in the open position, gently place the valve into the crimper aperture. Gradually crimp the valve (if necessary) until it fits into the Qualcrimp crimping accessory.
6	Place the Qualcrimp crimping accessory over the valve making sure the valve is parallel to the edge of the Qualcrimp crimping accessory.
7	Place the valve and Qualcrimp crimping accessory in the crimper aperture. Insert the delivery system coaxially within the valve. The orientation of the valve on the delivery system is described below: <b>Antegrade approach:</b> Inflow (outer skirt end) of the valve towards the proximal end of the delivery system. <b>Retrograde approach:</b> Inflow (outer skirt end) of the valve towards the distal end of the delivery system.
8	Crimp the valve between the two internal shoulders of the delivery system until it reaches the Qualcrimp Stop located on the 2-piece Crimp Stopper.
9	Gently remove the Qualcrimp crimping accessory from the valve. Remove the Qualcrimp Stop from the Final Stop, leaving the Final Stop in place.
10	Fully crimp the valve until it reaches the Final Stop. <b>NOTE: Ensure that the delivery system remains coaxial within the valve.</b>
11	Repeat the full crimp of the valve two more times for a total of three full crimps.
12	Flush the loader with heparinized saline. Immediately advance the valve into the loader until the tapered tip of the delivery system is exposed and the valve is within the distal end of the loader tube. <b>CAUTION: To prevent possible leaflet damage, the valve should not remain fully crimped and/or in the loader for over 15 minutes.</b>
13	Attach the loader cap to the loader and flush through the port on the loader. <b>CAUTION: Keep the valve hydrated until ready for implantation.</b> <b>CAUTION: The physician must verify correct orientation of the valve prior to its implantation.</b>
14	With 3-way stopcock still closed to the luer lock syringe, unlock the inflation device. Allow the delivery system to reach zero-pressure.



Step	Procedure															
15	Close the 3-way stopcock to the delivery system. Use the luer lock syringe to de-air the inflation device if necessary															
16	Adjust the inflation device to the inflation volume required to deploy the valve, per the following: <table border="1" data-bbox="404 296 1321 737"> <thead> <tr> <th>Delivery System</th> <th>Valve</th> <th>Inflation Volume</th> </tr> </thead> <tbody> <tr> <td>Model 9630TA20 9600SDS20</td> <td>20 mm</td> <td>12 mL</td> </tr> <tr> <td>Model 9630TA23 9600SDS23</td> <td>23 mm</td> <td>17 mL</td> </tr> <tr> <td>Model 9630TA26 9600SDS26</td> <td>26 mm</td> <td>23 mL</td> </tr> <tr> <td>Model 9630TA29 9600SDS29</td> <td>29 mm</td> <td>30 mL</td> </tr> </tbody> </table> <p>Re-lock the inflation device. Close the 3-way stopcock to the luer lock syringe and remove syringe.</p> <p><b>CAUTION: Maintain the inflation device in a locked position until valve deployment.</b></p>	Delivery System	Valve	Inflation Volume	Model 9630TA20 9600SDS20	20 mm	12 mL	Model 9630TA23 9600SDS23	23 mm	17 mL	Model 9630TA26 9600SDS26	26 mm	23 mL	Model 9630TA29 9600SDS29	29 mm	30 mL
Delivery System	Valve	Inflation Volume														
Model 9630TA20 9600SDS20	20 mm	12 mL														
Model 9630TA23 9600SDS23	23 mm	17 mL														
Model 9630TA26 9600SDS26	26 mm	23 mL														
Model 9630TA29 9600SDS29	29 mm	30 mL														
17	Remove the stylet and flush the guidewire lumen of the delivery system.															

### 7.3 Valvuloplasty and Valve Delivery

Valvuloplasty and valve delivery should be performed under conscious sedation and/or general anesthesia with hemodynamic monitoring in a catheterization lab/hybrid operating room with fluoroscopic and echocardiographic imaging capabilities.

The following table shows the minimum required distances from the valvular plane to the distal tip of the sheath to allow the Edwards Certitude delivery system balloon to inflate properly during valve deployment. These distances do not include sheath insertion depth, which should be considered during the transaortic approach when selecting the access site on the ascending aorta.

Delivery System	Valve	Minimum Required Distance From Sheath Tip to Valvular Plane
9630TA20 9600SDS20	20 mm	3.5 cm
9630TA23 9600SDS23	23 mm	3.5 cm
9630TA26 9600SDS26	26 mm	3.5 cm
9630TA29 9600SDS29	29 mm	4.0 cm

Administer heparin to maintain the ACT at  $\geq 250$  sec during the procedure.

**Balloon valvuloplasty should be avoided in the treatment of failing bioprostheses as this may result in embolization of bioprosthesis material and mechanical disruption of the valve leaflets.**

**CAUTION: Use of excessive contrast media may lead to renal failure. Measure the patient's creatinine level prior to the procedure. Contrast media usage should be monitored.**

**CAUTION: Care should be taken to avoid damage to soft tissue, chordae, aorta, native leaflet or ventricular wall during insertion, positioning and removal of devices.**

### 7.3.1 Baseline Parameters

Step	Procedure
1	Perform an angiogram with fluoroscopic view perpendicular to the valve.
2	Evaluate the distance of the left and right coronary ostia from the aortic annulus in relation to the valve frame height.
3	Introduce a pacemaker (PM) lead and position appropriately.
4	Set the stimulation parameters to obtain 1:1 capture, and test pacing.

### 7.3.2 Access

Step	Procedure
1	Gain access using standard catheterization techniques.
2	Using the sheath depth markers, advance the introducer and sheath over the guidewire to the desired depth while following its progression on fluoroscopy.
3	Withdraw the introducer slowly, keeping the sheath in place. Maintain guidewire position across the valve.

### 7.3.3 Valvuloplasty

Pre-dilate the native aortic valve, per the discretion of the physician, according to the instructions for use for the selected balloon aortic valvuloplasty catheter.

**CAUTION: Valve implantation should not be carried out if the balloon cannot be fully inflated during valvuloplasty.**

### 7.3.4 Valve Delivery

Step	Procedure
1	Confirm that the valve is oriented properly and the volume in the inflation device matches the indicated volume.
2	Advance the valve/balloon assembly with the loader over the guidewire.
3	Engage loader into sheath housing while maintaining a firm grip.
4	Advance the valve out of the loader into the large section of the sheath. Tap on the sheath housing to release air bubbles to the proximal end of the loader. Depress button valve on loader to de-air.
5	Advance the valve/balloon assembly through the sheath and position within the target valve. If needed, rotate the flex wheel on the handle to articulate the valve/balloon assembly into position. <b>CAUTION: To prevent possible leaflet damage, the valve should not remain in the sheath for over 5 minutes.</b>
6	Ensure that the valve is correctly positioned between the two internal shoulders of the delivery system.
7	Begin valve deployment: <ul style="list-style-type: none"> <li>• Unlock the Inflation device provided by Edwards Lifesciences.</li> <li>• Begin rapid pacing; once systolic blood pressure has decreased to 50 mmHg or below, balloon inflation can commence.</li> <li>• Deploy the valve by inflating the balloon with the entire volume in the Inflation device provided by Edwards Lifesciences, hold for 3 seconds and confirm that the barrel of the inflation device is empty to ensure complete inflation of the balloon.</li> <li>• Deflate the balloon. When the balloon has been completely deflated, turn off the pacemaker.</li> </ul>

### 7.3.5 System Removal

Step	Procedure
1	If articulation was used, completely unflex the delivery system. Retract the delivery system and guidewire into the sheath. Remove the loader and delivery system from the sheath. <b>CAUTION: Properly deflate the balloon and unflex the delivery system prior to removal.</b>
2	Remove all devices when the ACT level is appropriate.
3	Remove the sheath from the access site, close the access site and confirm hemostasis.

## 8.0 How Supplied

STERILE: The valve is supplied sterilized with glutaraldehyde solution. The delivery system is supplied sterilized with ethylene oxide gas.

### 8.1 Storage

The valve must be stored at 10 °C to 25 °C (50 °F to 77 °F). Each jar is shipped in an enclosure containing a temperature indicator to detect exposure of the valve to extreme temperature.

The delivery system should be stored in a cool, dry place.

## 9.0 MR Safety



### MR Conditional

Non-clinical testing has demonstrated that the Edwards SAPIEN 3 Ultra transcatheter heart valve and the Edwards SAPIEN 3 transcatheter heart valve are MR Conditional. A patient with this device can be scanned safely, immediately after placement of this device under the following conditions:

- Static magnetic field of 1.5 tesla or 3 tesla.
- Maximum spatial gradient field of 2500 gauss/cm (25 T/m) or less.
- Maximum MR system reported, whole body averaged specific absorption rate (SAR) of 2 W/kg (Normal Operating Mode).

Under the scan conditions defined above, the transcatheter heart valve is expected to produce a maximum temperature rise of 3.0 °C after 15 minutes of continuous scanning.

In non-clinical testing, the image artifact caused by the device extends as far as 14.5 mm from the implant for spin echo images and 30 mm for gradient echo images when scanned in a 3.0 T MRI system. The artifact obscures the device lumen in gradient echo images.

The implant has not been evaluated in MR systems other than 1.5 or 3.0 T.

For valve-in-valve implantation or in the presence of other implants, please refer to the MRI safety information for the surgical valve or other devices prior to MR imaging.

## 10.0 Patient Information

Patient education brochures are provided to each site and should be given to the patient to inform them of the risks and benefits of the procedure and alternatives in adequate time before the procedure to be read and discussed with their physician. A copy of this brochure may also be obtained from Edwards Lifesciences by calling 1.800.822.9837. A patient implant card request form is provided with each transcatheter heart valve. After implantation, all requested information should be completed on this form. The serial number may be found on the package and on the identification tag attached to the transcatheter heart valve. The original form should be returned to the Edwards Lifesciences address indicated on the form and upon receipt, Edwards Lifesciences will provide an identification card to the patient.

## 11.0 Recovered Valve and Device Disposal

The explanted valve should be placed into a suitable histological fixative such as 10% formalin or 2% glutaraldehyde and returned to the company. Refrigeration is not necessary under these circumstances. Contact Edwards Lifesciences to request an Explant Kit.

Used delivery system may be disposed of in the same manner that hospital waste and biohazardous materials are handled. There are no special risks related to the disposal of these devices.

## 12.0 Clinical Studies

### SUMMARY OF PRIMARY CLINICAL STUDY

#### The PARTNER II Trial Overview, SAPIEN 3 Valve

SAPIEN 3 High Risk and Inoperable Cohort: The SAPIEN 3 High Risk and Inoperable Cohort of the PARTNER II trial (PIIS3HR) was a single arm, non-randomized, historical-controlled study to compare the third generation Edwards SAPIEN 3 system with the first generation Edwards SAPIEN system in patients who either have high risk for surgery or cannot undergo surgery (inoperable). The valve sizes used in the PIIS3HR trial included only the 23, 26 and 29 mm sizes. The 20 mm valve size was introduced into the trial after enrollment was completed with the three larger sizes, thus a separate nested registry, NR7, with identical inclusion/exclusion criteria as the PIIS3HR Cohort except for the aortic annulus diameter, was created to collect data for the 20 mm valve. Data from the PIIS3HR cohort and NR7 are pooled for the statistical analyses. For convenience, this combined cohort is referred to as "PIIS3HR" hereafter.

The database included 583 eligible patients enrolled at 29 investigational sites in the U.S.

The PIIS3HR study used an independent Data Safety Monitoring Board (DSMB) that was instructed to notify Edwards Lifesciences of any safety or compliance issues, a Clinical Events Committee (CEC) that was responsible for adjudicating endpoint related events reported during the trial per *a priori* established VARC 2 definitions<sup>[2]</sup>, an ECG core laboratory for independent analysis of rhythm, and an echocardiographic core laboratory for independently analyzing all echocardiograms.

SAPIEN 3 Intermediate Risk Cohort: The PIIS3i Cohort of the PARTNER II trial was a single arm, non-randomized, historical-controlled study to compare TAVR with the Edwards SAPIEN 3 system to the surgical aortic valve replacement (SAVR) arm from the previous PARTNER II trial Cohort A (PIIA-SAVR) in patients who were judged by a heart team to be at intermediate risk for open surgical therapy. The valve sizes used in the PIIS3i study included the 20, 23, 26, and 29 mm sizes.

Patients in PIIS3i were treated between February 2014 and September 2014. Patients in PIIA-SAVR were treated between January 2012 and November 2013. The database reflected data collected through December 10, 2015 and included 1,078 patients in PIIS3i enrolled at 51 investigational sites in the U.S. and 1,021 patients in PIIA-SAVR enrolled at 57 investigational sites in the U.S.

The PIIS3i study used an independent Data Safety Monitoring Board (DSMB) that was instructed to notify Edwards Lifesciences of any safety or compliance issues and a Clinical Events Committee (CEC) that was responsible for adjudicating endpoint related events reported during the trial. The CEC adjudicated the events per pre-established definitions, which were primarily Valve Academic Research Consortium-1 VARC-2 definitions<sup>[2]</sup>, with the following exceptions:

- Prosthetic valve dysfunction was adjudicated per VARC-1
- Aortic valve reintervention was adjudicated per protocol definition
- Rehospitalization for symptoms of aortic stenosis and/or complications of the valve procedure were adjudicated using the protocol and VARC-2 definitions as guidelines

The events in the PIIA-SAVR cohort were adjudicated by the CEC in accordance with the pre-specified, primarily VARC-1 definitions, with the following exceptions:

- Acute Kidney Injury (AKI) was adjudicated with a modified VARC-1 definition in which the CEC applied the 72-hour staging window to any AKI event that occurred within 30-days
- Aortic valve reintervention was adjudicated per the protocol definition
- Rehospitalization for symptoms of AS and/or complications of the valve procedure were adjudicated using the protocol and VARC-1 as guidelines
- Bleeding events were adjudicated irrespective of whether there was an identifiable, overt source of bleeding

An electrocardiogram (ECG) core laboratory was used for independent analysis of rhythm, an echocardiographic core laboratory for echocardiograms, and a computerized tomography (CT) core laboratory for baseline CTs for annulus dimensions.

### **The PARTNER 3 Trial Overview, SAPIEN 3 Valve**

Patients were enrolled between March 2016 and June 2018. The database reflected data collected through December 21, 2018 and included 1000 patients. There were 71 investigational sites in the U.S, Australia, Canada, New Zealand, and Japan.

The PARTNER 3 trial was a prospective, randomized (1:1), controlled, multicenter study to compare TAVR with the Edwards SAPIEN 3 THV to SAVR. A subset of patients were enrolled in a computed tomography (CT) substudy to investigate the prevalence of Hypoattenuated Leaflet Thickening (HALT) and reduced leaflet mobility.

The PARTNER 3 trial used an independent Data Safety Monitoring Board (DSMB) that was instructed to notify the applicant of any safety or compliance issues and a Clinical Events Committee (CEC) that was responsible for adjudicating endpoint-related events reported during the trial. The CEC adjudicated the events per Valve Academic Research Consortium-2 (VARC-2) definitions<sup>[2]</sup>. A CT core laboratory was used for assessment of baseline CTs for annulus dimensions and the CT images acquired in the CT substudy.

### **Clinical Inclusion and Exclusion Criteria**

Patients in the database extract received a commercially available SAPIEN 3 transcatheter heart valve and surgical valves for symptomatic heart disease due to severe native calcific aortic stenosis who were deemed to be at low risk for surgical aortic valve replacement.

### **Clinical Endpoints**

The endpoints analyzed in this application included: death rate, adjudicated adverse events (stroke, TIA, and aortic valve reinterventions, rehospitalization), key site reported adverse events, atrial fibrillation, length of index hospitalization, valve performance based on echocardiographic data, New York Heart Association (NYHA) classification, 6-minute walk test, and the Kansas City Cardiomyopathy Questionnaire (KCCQ) score. The analyses in the application focused on the 30-day and/or one-year time points.

### **SAPIEN 3 THV IN BICUSPID AORTIC VALVE FOR PATIENTS AT INTERMEDIATE OR GREATER SURGICAL RISK–STS/ACC TRANSCATHETER VALVE THERAPY REGISTRY (TVTR) ANALYSIS**

A database extract was performed on November 15, 2017, which yielded 545 patients with bicuspid aortic valves that had been treated with an Edwards SAPIEN 3 transcatheter heart valve. The patients were treated between July 14, 2015 and August 15, 2016. The procedure was performed in 225 participating hospitals.

Adjudications were completed per the TVT Registry Coder's Data Dictionary by the Duke Clinical Research Institute (DCRI) for three adverse events: stroke, transient ischemic attack (TIA), and aortic valve reinterventions.

### **Clinical Inclusion and Exclusion Criteria**

Patients in the database extract received a commercially available SAPIEN 3 transcatheter heart valve for symptomatic heart disease associated with a bicuspid aortic valve. The patients were treated based on clinical judgement of their treating physicians.

### Follow-up Schedule

All patients were followed post implantation according to their local standards of care. The TVT Registry collects follow-up data at discharge, 30 days, and 1 year.

### Clinical Endpoints

Data entered into the TVT Registry were collected through standardized data collection forms. The endpoints analyzed in this application included: death rate, adjudicated adverse events (stroke, TIA, and aortic valve reinterventions), key site reported adverse events, valve performance based on echocardiographic data, New York Heart Association (NYHA) classification, 5-meter walk test, and the Kansas City Cardiomyopathy Questionnaire (KCCQ) score. The analyses in the application focused on the 30-day and one-year time points.

### **SAPIEN 3 THV IN BICUSPID AORTIC VALVE FOR PATIENTS AT LOW SURGICAL RISK – PARTNER 3 BICUSPID REGISTRY ANALYSIS**

Under the PARTNER 3 trial, a prospective, single-arm, registry was enrolled to establish a reasonable assurance of safety and effectiveness of TAVR with the Edwards SAPIEN 3 THV in patients with severe, native, calcific, aortic stenosis of a bicuspid aortic valve who are judged by a heart team to be at low risk for open surgical therapy. Patients were enrolled between October 2017 and May 2018, and data was collected through August 28, 2019 for 75 patients.

The data safety monitoring board and clinical events committee described in the PARTNER 3 trial above were also used in this registry.

### Clinical Inclusion and Exclusion Criteria

Patients in the trial received a commercially available SAPIEN 3 transcatheter heart valve for symptomatic heart disease due to severe native calcific aortic stenosis of a bicuspid aortic valve who were deemed to be at low risk for surgical aortic valve replacement.

### Follow-up Schedule

Patients were followed-up at discharge, 30 days, and 1 year, and will continue to be followed up to 10 years.

### Clinical Endpoints

The clinical endpoints were the same as those listed above in the PARTNER 3 trial.

### **SAPIEN 3 THV Valve-in-Valve – STS/ACC Transcatheter Valve Therapy Registry (TVTR) Analysis**

A database extract was performed on August 4, 2016, which yielded 314 patients that had been treated with an Edwards SAPIEN 3 transcatheter heart valve placed in a failed surgical aortic bioprosthesis (i.e., aortic valve-in-valve) and 311 patients that had been treated with an Edwards SAPIEN XT transcatheter heart valve (N = 241) or SAPIEN 3 transcatheter heart valve (N = 70) placed in a failed surgical mitral bioprosthesis (i.e., mitral valve-in-valve). Patients who presented with an existing valve-in-valve that was failing were excluded from the database extract. The SAPIEN XT transcatheter heart valve was included in the database extract for the mitral valve-in-valve uses because there were fewer SAPIEN 3 transcatheter heart valve cases in the registry due to its relatively shorter commercial use history and the SAPIEN XT transcatheter heart valve data were considered to be generally applicable to the SAPIEN 3 transcatheter heart valve due to their similarities in design. The aortic valve-in-valve patients were treated between July 23rd, 2015 and June 29th, 2016 at 130 participating hospitals; the mitral valve-in-valve patients were treated at 112 participating hospitals between July 10th, 2014 and June 27th, 2016 for the SAPIEN XT transcatheter heart valve and between June 23rd, 2015 and June 15th, 2016 for the SAPIEN 3 transcatheter heart valve.

Adjudications were completed per the TVT Registry Coder's Data Dictionary by the Duke Clinical Research Institute (DCRI) for three adverse events: readmission for heart failure, stroke/transient ischemic attack (TIA), and aortic and mitral valve reinterventions.

### Clinical Inclusion and Exclusion Criteria

Patients in the database extract received a commercially available SAPIEN 3 transcatheter heart valve (for both aortic and mitral valve-in-valve) or SAPIEN XT transcatheter heart valve (for mitral valve-in-valve only) for symptomatic heart disease associated with a failed (stenosed, insufficient, or combined) surgical bioprosthetic aortic or mitral valve. They were deemed to be at high or greater risk for open surgical therapy and were treated off-label based on the clinical judgement of their treating physicians.

### Follow-up Schedule

All patients were followed post implantation according to their local standards of care. The TVT Registry collects follow-up data at discharge, 30 days, and 1 year.

### Clinical Endpoints

Data entered into the TVT Registry were collected through standardized data collection forms. The endpoints analyzed in this application included: death rate, adjudicated adverse events (readmission for heart failure, stroke/TIA, and valve reinterventions), key site reported adverse events, valve performance based on echocardiographic data, New York Heart Association (NYHA) classification, 6-minute or 5-meter walk test, and the Kansas City Cardiomyopathy Questionnaire (KCCQ) score. The analyses in the application focused on the discharge and 30-day time points.

### **SAPIEN 3 and SAPIEN 3 Ultra THV THV-in-THV – STS/ACC Transcatheter Valve Therapy Registry (TVTR) Analysis**

A database extract was performed on August 9, 2019. Patients were excluded if their previous transcatheter aortic valve replacement (TAVR) procedure was performed prior to April 23, 2007 (first implant in the US under the PARTNER trial). The database extract yielded 404 patients that had undergone a THV-in-THV procedure with an Edwards SAPIEN 3 (N=402) or Edwards SAPIEN 3 Ultra (N=2). These patients were treated between August 4, 2015 and July 11, 2019 at 188 participating hospitals.

To obtain more complete 1-year follow-up data, a treatment cutoff date of June 9, 2018 was then applied to the data set obtained above, which yielded 263 patients (SAPIEN 3 THV only) treated at 138 participating hospitals. The cutoff date was 14 months before the database extract date, which included a +60-day window for the 1-year visit. These 263 patients constituted the clinical data set used to support this application.

### Clinical Inclusion and Exclusion Criteria

The initial database extract included all patients who received a commercially available Edwards SAPIEN 3 or Edwards SAPIEN 3 Ultra THV in an aortic THV-in-THV procedure. The final data set was a subset of the initial database extract as described above.

### Follow-up Schedule

All patients were followed post-implantation according to their local standards of care. The TVT Registry collects follow-up data at 30 days and 1 year.

### Clinical Endpoints

Data entered into the TVT Registry were collected through standardized data collection forms. The endpoints analyzed in this application included: death, stroke/transient ischemic attack (TIA), valve reinterventions, key site reported adverse events, valve performance based on echocardiographic data, New York Heart Association (NYHA) classification, and the Kansas City Cardiomyopathy Questionnaire (KCCQ) score. The analyses in the application focused on 30-day and 1-year time points.

### **SAPIEN 3 Ultra Confirmatory Study Overview**

A prospective, single-arm, multicenter clinical study was conducted to confirm the procedural safety and effectiveness of the SAPIEN 3 Ultra system in patients with severe, calcific aortic stenosis (AS) who are at intermediate operative risk for surgical aortic valve replacement (SAVR).

The study enrolled 40 patients in Canada and United Kingdom.

It utilized an echocardiographic core laboratory for echocardiograms.

### Follow-up Schedule

All patients were followed post implantation at discharge and 30 days, and will continue to be followed at 6 months, 1 year and annually thereafter for a minimum of 5 years.

### Clinical Endpoints

The endpoints analyzed were procedure success (defined as freedom from mortality, conversion to surgery and moderate or severe paravalvular regurgitation at exit from the procedure room), key site reported adverse events, valve performance, and New York Heart Association (NYHA) classification.

### **PARTNER II SAPIEN 3 HIGH-RISK/INOPERABLE COHORT**

#### **Patient Accountability**

All 583 eligible patients were successfully implanted with a SAPIEN 3 valve, which constitutes the Valve Implant (VI) population. Among the VI population, 491 patients were implanted via the transfemoral (TF) access route, and 92 patients via the transapical (TA) or transaortic (TAo) access route.

**Table 8:  
Patient Accountability**

	<b>SAPIEN 3 Valve Overall</b>	<b>SAPIEN 3 Valve Transfemoral Access</b>	<b>SAPIEN 3 Valve Non-Transfemoral Access</b>
<b>Eligible Patient Population (EPP)</b>	583	491	92
<b>Valve Implant (VI) Population</b>	583	491	92

Eligible Patient Population (EPP) consists of all enrolled patients who received treatment assignment from the database and entered into the catheterization laboratory/hybrid suite and who remained eligible to receive the implant.

Valve Implant (VI) Population consists of all enrolled patients who received a SAPIEN 3 valve, and retained the valve upon leaving the catheterization laboratory/hybrid suite.



## Study Population Demographics and Baseline Parameters

The demographics of the study population are summarized in Table 9, which are typical of a TAVR study performed in the U.S.

**Table 9:  
Patient Demographics and Baseline Characteristics –  
PIIS3HR VI Population**

Characteristic	SAPIEN 3 Valve Overall (N = 583)	SAPIEN 3 Valve Transfemoral Access (N = 491)	SAPIEN 3 Valve Non-Transfemoral Access (N = 92)
Age, yr	82.6 ± 8.1	82.8 ± 8.2	81.7 ± 7.5
Male sex, no. (%)	338 (58.0%)	277 (56.4%)	61 (66.3%)
STS score	8.6 ± 3.7	8.4 ± 3.5	10.0 ± 4.3
New York Heart Association (NYHA) class, no. (%):			
I/II	58 (9.9%)	51 (10.4%)	7 (7.6%)
III/IV	525 (90.1%)	440 (89.6%)	85 (92.4%)
Coronary artery disease, no. (%)	444 (76.2%)	360 (73.3%)	84 (91.3%)
Previous myocardial infarction, no. (%)	117 (20.1%)	87 (17.7%)	30 (32.6%)
Previous intervention, no. (%)			
Coronary-artery bypass grafting (CABG)	193 (33.1%)	145 (29.5%)	48 (52.2%)
Percutaneous coronary intervention (PCI)	199 (34.1%)	163 (33.2%)	36 (39.1%)
Prior aortic valvuloplasty	62 (10.6%)	49 (10.0%)	13 (14.1%)
Cerebral vascular accident (CVA), no. (%)	64 (11.0%)	53 (10.8%)	11 (12.0%)
Peripheral vascular disease, no. (%)	205 (35.2%)	155 (31.6%)	50 (54.3%)
Chronic obstructive pulmonary disease (COPD), no. (%):			
Any	259 (44.6%)	216 (44.1%)	43 (47.3%)
Oxygen-dependent	68 (11.8%)	58 (11.9%)	10 (11.0%)
Atrial fibrillation, no. (%)	255 (43.7%)	212 (43.2%)	43 (46.7%)
Permanent pacemaker, no. (%)	95 (16.3%)	78 (15.9%)	17 (18.5%)
Severe pulmonary hypertension, no. (%)	30 (5.1%)	24 (4.9%)	6 (6.5%)
Frailty, no. (%)	180 (30.9%)	162 (33.0%)	18 (19.6%)
Chest deformities that preclude an open chest procedure, no. (%)	4 (0.7%)	3 (0.6%)	1 (1.1%)
Cirrhosis, no. (%)	11 (1.9%)	9 (1.8%)	2 (2.2%)
Echocardiographic findings			
Effective Orifice Area (EOA), cm <sup>2</sup>	0.7 ± 0.2	0.7 ± 0.2	0.7 ± 0.1
Mean aortic-valve gradient, mmHg	45.5 ± 14.3	45.7 ± 14.4	44.0 ± 13.2
Mean left ventricular ejection fraction (LVEF), %	56.4 ± 14.8	57.0 ± 14.5	53.2 ± 15.9
Moderate or severe mitral regurgitation, no./total no. (%)	69/541 (12.8%)	63/461 (13.7%)	6/80 (7.5%)

## Safety and Effectiveness Results

### Primary Endpoint

The composite rate of all-cause mortality, all stroke, and AI  $\geq$  moderate at 30 days was 6.7% in the SAPIEN 3 cohort and 15.6% in the SAPIEN cohort, as shown in Table 10. The resulting proportion difference in the average treatment effect on the treated (ATT; <sup>1</sup>) was -6.9% (90% CI: [-13.3%, -0.5%]). Since the upper limit of the CI was  $<$  7.5%, the non-inferiority was met.

**Table 10:  
Primary Endpoint Analysis –  
Non-Inferiority Test SAPIEN 3 Valve (PIIS3HR VI Population) vs. SAPIEN Valve**

Event at 30 days	SAPIEN 3 Valve (N = 583)	SAPIEN Valve (N = 326)	Weighted Proportion Difference in Average Treatment Effect on the Treated (ATT)
Composite of Death, Stroke and AI $\geq$ Moderate	6.7% [5.1%, 8.6%] <sup>1</sup>	15.6% [12.6%, 19.5%] <sup>1</sup>	-6.9% [-13.3%, -0.5%] <sup>2</sup>

<sup>1</sup>For each individual study, the two-sided 90% stratified Wilson confidence interval was provided.

<sup>2</sup>The Wald-type two-sided 90% confidence interval using weighted mean and SD is provided.

The Kaplan-Meier (K-M) estimates for all-cause mortality, cardiac mortality, and all stroke at 30 days for the SAPIEN 3 cohort and the SAPIEN cohort are provided in Table 11.

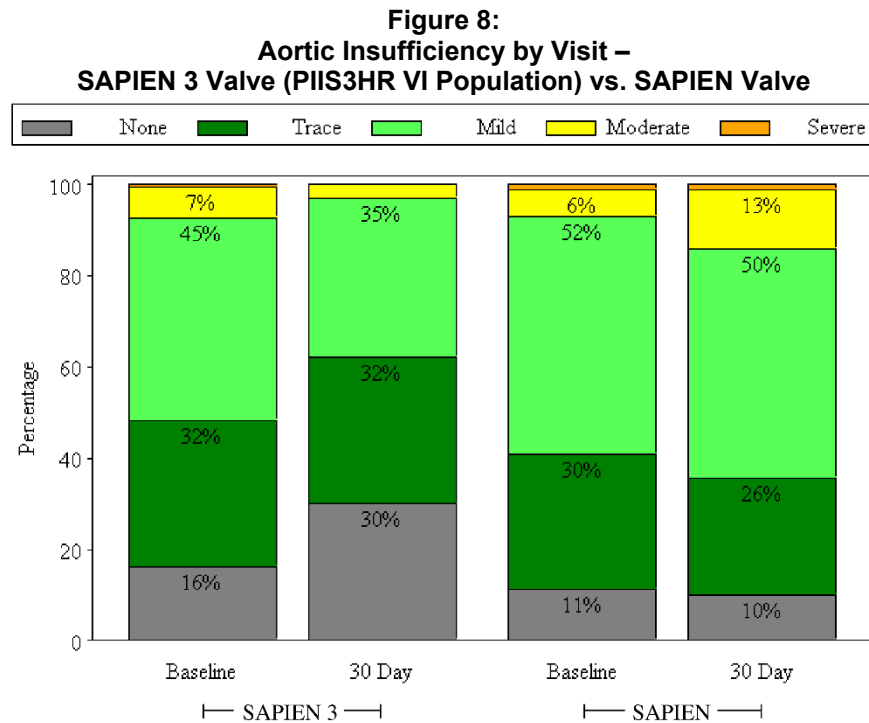
**Table 11:  
Death and Stroke at 30 Days –  
SAPIEN 3 Valve vs. SAPIEN Valve (VI Population)**

Event at 30 Days	SAPIEN 3 Valve (N = 583)			SAPIEN Valve (N = 326)		
	No. Events	No. Pts with Events	K-M Estimated Event Rate <sup>1</sup> (95% CI)	No. Events	No. Pts with Events	K-M Estimated Event Rate (95% CI)
Death	13	13	2.2% ([1.3%, 3.8%])	15	15	4.6% ([2.8%, 7.5%])
Cardiac Death	8	8	1.4% ([0.7%, 2.7%])	10	10	3.1% ([1.7%, 5.7%])
All Stroke	9	9	1.6% ([0.8%, 3.0%])	14	14	4.3% ([2.6%, 7.2%])

<sup>1</sup>Kaplan-Meier (K-M) estimates at 30 days used time to first event for each patient. Events occurring after 30 days were not included in this analysis.

Secondary Endpoints

Aortic insufficiency by visit is provided in Figure 8.



The proportion of patients with AI  $\geq$  moderate at 30 days was 3.0% in the SAPIEN 3 cohort and 14.3% in the SAPIEN cohort, which were found to be statistically significantly different ( $p=0.0051$ ; Table 12).

**Table 12:  
Aortic Insufficiency at 30 Days  
(SAPIEN 3 Valve vs. SAPIEN Valve VI Population)**

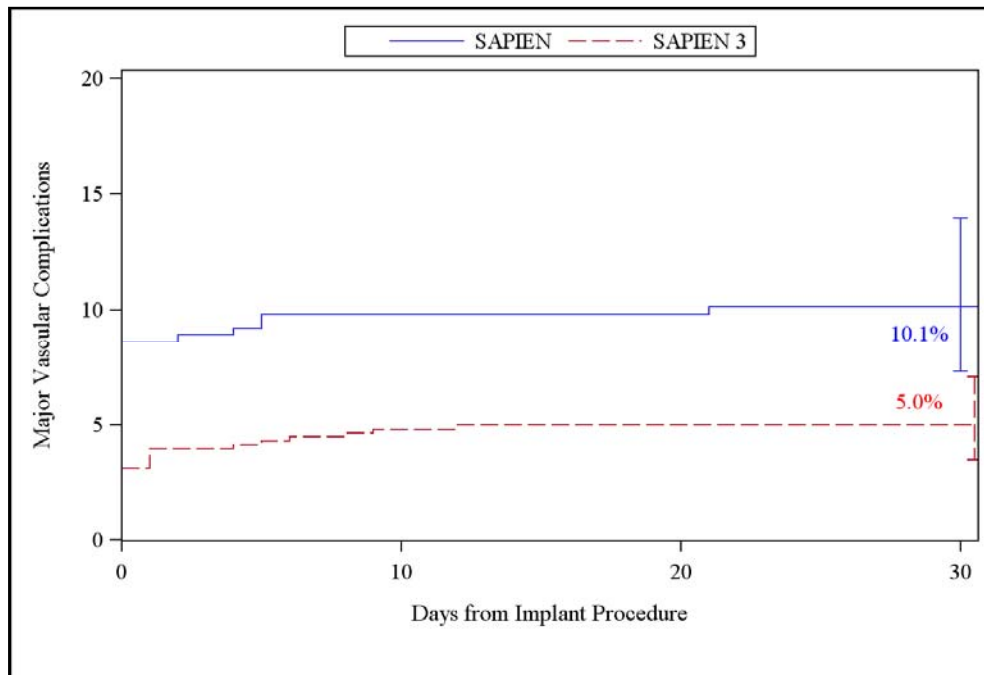
Event at 30 Days	SAPIEN 3 Valve (N = 583)	SAPIEN Valve (N = 326)	Weighted Proportion Difference in Average Treatment Effect on the Treated (ATT)	P-value
AI $\geq$ Moderate, n/Total no. (%) [95% CI]	16/532 (3.0%) [1.7%, 4.8%] <sup>1</sup>	40/280 (14.3%) [10.4%, 18.9%] <sup>1</sup>	-13.1% [-22.2%, -3.9%] <sup>2</sup>	0.0051

<sup>1</sup> 95% Clopper-Pearson Exact confidence interval.

<sup>2</sup> The Wald-type two-sided 90% confidence interval using weighted mean and SD is provided.

The rate of major vascular complications at 30 days post implantation is shown in Figure 9. The rate was 5.0% for the SAPIEN 3 cohort and 10.1% for the SAPIEN cohort, which were found to be not statistically significantly different ( $p=0.0578$ ; Table 13).

**Figure 9:**  
**Major Vascular Complications at 30 Days –**  
**SAPIEN 3 Valve vs. SAPIEN Valve (VI Population)**



**Table 13:**  
**Major Vascular Complications at 30 Days –**  
**SAPIEN 3 Valve vs. SAPIEN Valve (VI Population)**

Event at 30 Day	SAPIEN 3 Valve (N = 583)	SAPIEN Valve (N = 326)	Weighted Proportion Difference in Average Treatment Effect on the Treated (ATT)	P-value
Major Vascular Complications, n/Total no. (%) [95% CI]	29/583 (5.0%) [3.4%, 7.1%]	33/326 (10.1%) [7.1%, 13.9%] <sup>1</sup>	-8.0% [-16.2%, 0.3%] <sup>2</sup>	0.0578

<sup>1</sup> 95% Clopper-Pearson Exact confidence interval.

<sup>2</sup> The Wald-type two-sided 90% confidence interval using weighted mean and SD is provided.

Table 14 lists the hypothesis testing of the two secondary endpoints conducted with p-values in descending order for the Hochberg multiplicity adjustment steps. The largest p-value ( $p=0.0578$  from major vascular complications) was greater than 0.05. As such, the null hypothesis was not rejected for the testing of major vascular complications at 30 days. The subsequent testing of  $AI \geq moderate$  at 30 days had a p-value of 0.0051, which was less than 0.025. As such, the null hypothesis was rejected for  $AI \geq moderate$  at 30 days, indicating that the SAPIEN 3 cohort was superior over the SAPIEN cohort in regards to  $AI \geq moderate$  at 30 days.

**Table 14:  
Secondary Endpoints for Labeling –  
SAPIEN 3 Valve vs. SAPIEN Valve (VI Population)**

Endpoints	Original p-value	Inference
Major Vascular Complications at 30 Days	0.0578	> 0.05; reject the alternative hypothesis. Proceed to the rest of testing
AI at 30 Days	0.0051	< 0.025; claim superiority

Adverse Events

The key CEC adjudicated adverse events at 30 days are presented in Table 15.

**Table 15:  
CEC Adjudicated Adverse Events at 30 Days  
(PIIS3HR VI Population)**

30 Day Adverse Events	SAPIEN 3 Valve Overall	SAPIEN 3 Valve Transfemoral Access TF	SAPIEN 3 Valve Non-Transfemoral Access
Composite Event Rate of Death, All Stroke and AI ≥ Moderate, n/N (%)	37/545 (6.8%)	27/463 (5.8%)	10/82 (12.2%)
Death			
From any cause, n/N (%)	13/583 (2.2%)	8/491 (1.6%)	5/92 (5.4%)
From cardiovascular cause, n/N (%)	8/583 (1.4%)	5/491 (1.0%)	3/92 (3.3%)
Stroke, n/N (%)	9/583 (1.5%)	8/491 (1.6%)	1/92 (1.1%)
AI ≥ moderate, n/N (%)	16/532 (3.0%)	12/455 (2.6%)	4/77 (5.2%)
Myocardial Infarction, n/N (%)	3/583 (0.5%)	2/491 (0.4%)	1/92 (1.1%)
Major Vascular Complications, n/N (%)	29/583 (5.0%)	26/491 (5.3%)	3/92 (3.3%)
Acute Kidney Injury, Stage III, n/N (%)	6/583 (1.0%)	4/491 (0.8%)	2/92 (2.2%)
Disabling Bleeding Event, n/N (%)	37/583 (6.3%)	27/491 (5.5%)	10/92 (10.9%)
Aortic Valve Re-Intervention, n/N (%)	6/583 (1.0%)	4/491 (0.8%)	2/92 (2.2%)
Endocarditis, n/N (%)	1/583 (0.2%)	1/491 (0.2%)	0/92 (0.0%)
Conduction Disturbance Requiring Permanent Pacemaker, n/N (%)	76/583 (13.0%)	65/491 (13.2%)	11/92 (12.0%)

Other Results

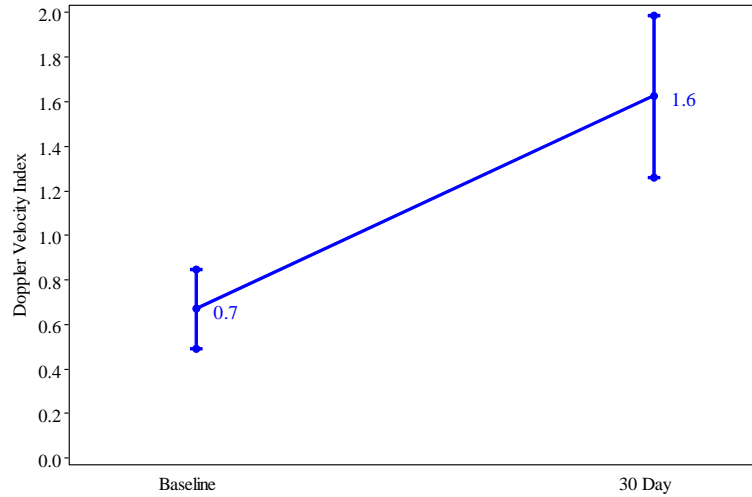
Procedural Information

Overall, the mean duration in the catheterization laboratory/hybrid suite was 192.8 ± 59.3 min, the mean total procedure time was 86.3 ± 44.2 min, and the mean total anesthesia time was 193.7 ± 62.9 min. These duration times were slightly shorter in the TF patients. General anesthesia was used in the vast majority of cases; 15.9% of the TF patients had conscious sedation. Correct positioning of the valve was achieved in 99.1% of the patients. Five patients (0.9%; including 3 TF patients) were implanted with a second valve. One patient (0.2%) experienced valve embolization following rupture of the delivery balloon on annular calcium. This patient was converted to surgical aortic valve replacement and later died from aortic dissection.

Valve Performance

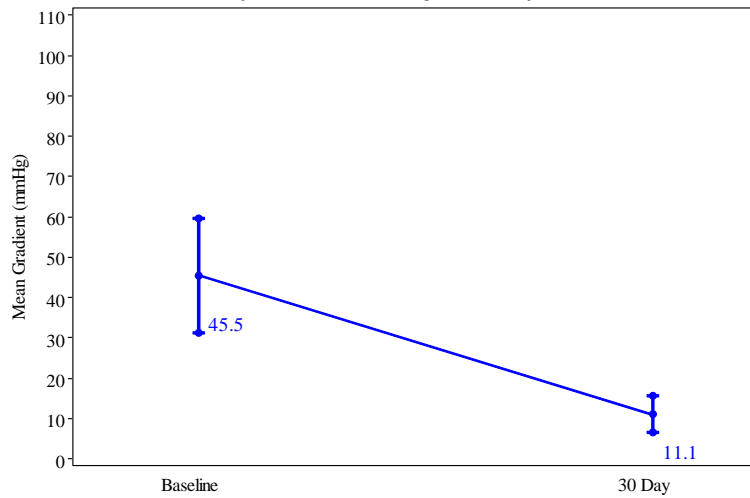
The mean EOA increased from  $0.7 \pm 0.2 \text{ cm}^2$  at baseline to  $1.6 \pm 0.4 \text{ cm}^2$  at 30 days, as shown in Figure 10.

**Figure 10:  
Effective Orifice Area  
(PIIS3HR VI Population)**



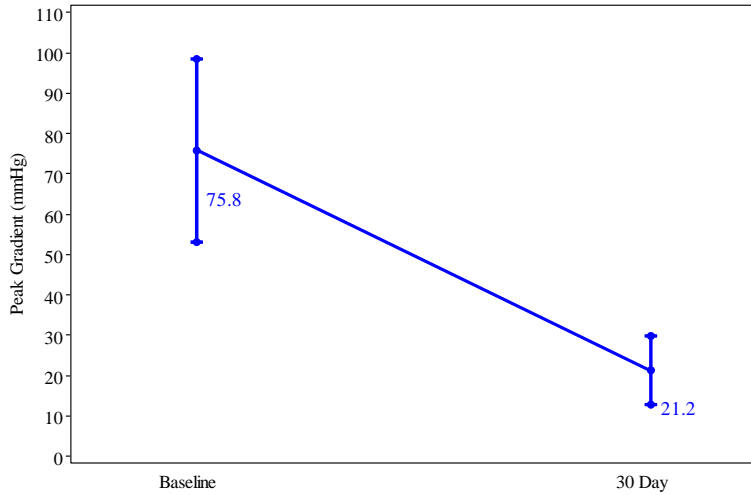
The average mean gradient decreased from  $45.5 \pm 14.3 \text{ mmHg}$  at baseline to  $11.1 \pm 4.5 \text{ mmHg}$  at 30 days, as shown in Figure 11.

**Figure 11:  
Mean Gradient  
(PIIS3HR VI Population)**



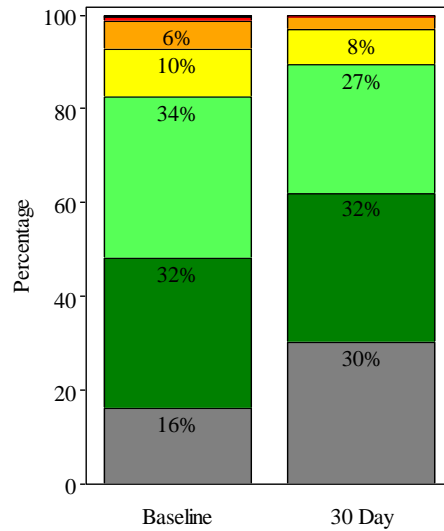
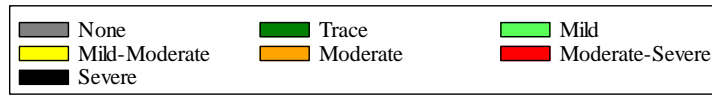
The mean peak gradient decreased from  $75.8 \pm 22.6$  mmHg at baseline to  $21.2 \pm 8.5$  mmHg at 30 days, as shown in Figure 12.

**Figure 12:**  
**Peak Gradient**  
**(PIIS3HR VI Population)**



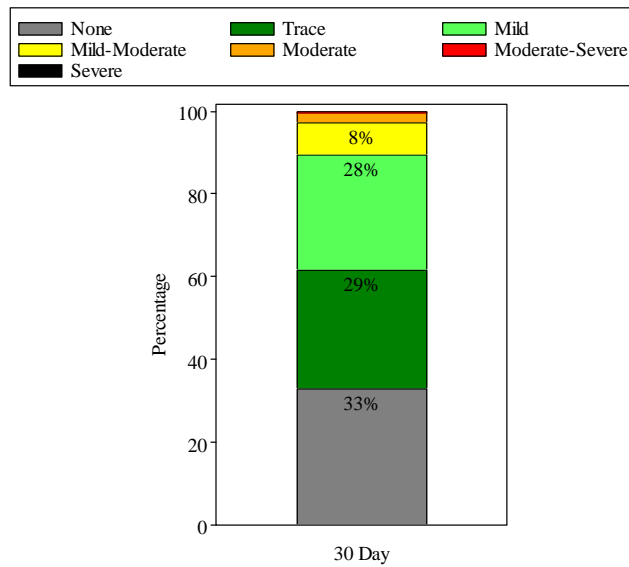
The proportion of patients with AI  $\geq$  moderate was 7.3% at baseline and 3.0% at 30 days, as shown in Figure 13.

**Figure 13:**  
**Aortic Insufficiency**  
**(PIIS3HR VI Population)**



The proportion of patients with aortic paravalvular leak (PVL)  $\geq$  moderate was 2.9% at 30 days, as shown in Figure 14.

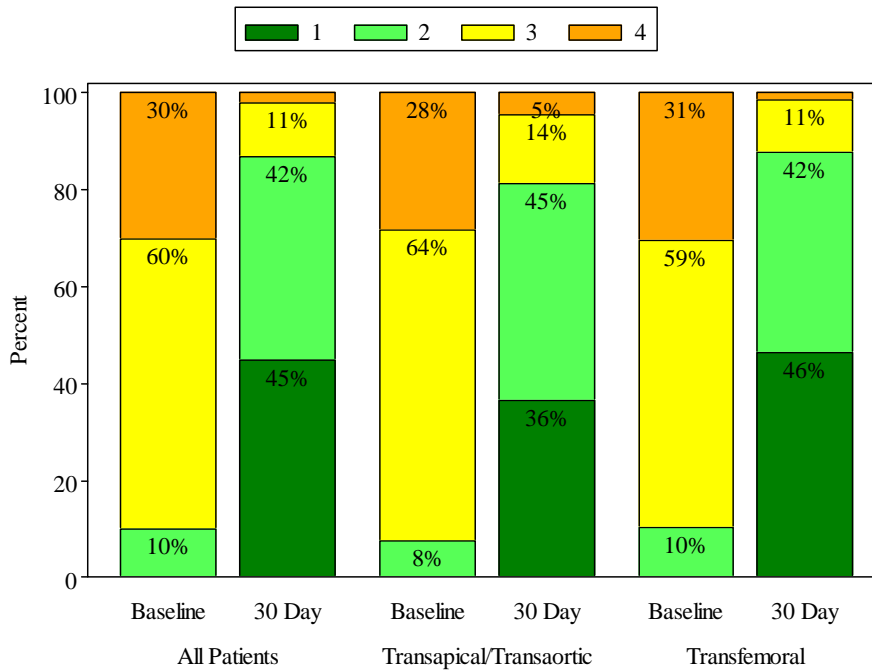
**Figure 14:  
Aortic Paravalvular Leak  
(PIIS3HR VI Population)**



NYHA

The NYHA class by visit is shown in Figure 15. For all patients, the mean NYHA class was  $3.2 \pm 0.6$  at baseline and  $1.7 \pm 0.7$  at 30 days.

**Figure 15:  
NYHA Class by Visit  
(PIIS3HR VI Population)**



**Six Minute Walk Test (6MWT)**

The improvement in mean 6MWT distance was  $38.5 \pm 110.2$  meters from baseline to 30 days for all patients,  $42.6 \pm 107.8$  meters for all TF patients, and  $15.9 \pm 121.2$  meters for all TA/TAo patients.



## **Length of Stay (LoS)**

The overall mean LoS was  $6.8 \pm 4.8$  days, which included  $3.0 \pm 2.7$  days in the ICU. The mean LoS was  $6.1 \pm 4.3$  days (including  $2.7 \pm 2.3$  days in the ICU) for the TF patients and  $10.4 \pm 5.4$  days (including  $4.8 \pm 3.9$  days in the ICU) for the TA/TAo patients.

## **Quality of Life (QoL)**

QoL was measured using the visual analog scale (VAS) of the EuroQoL (EQ-5D) measure. The VAS is a self-assessment in which patients rate their well-being on a scale from 0 to 100 where 0 is the worst state they can imagine and 100 is the best state. During the trial, the mean improvement in VAS scale from baseline to 30 days was  $14.6 \pm 22.2$  for all patients,  $15.1 \pm 21.5$  for the TF patients, and  $11.5 \pm 25.7$  for the TA/TAo patients.

## **Additional QoL instruments**

The mean overall Kansas City Cardiomyopathy Questionnaire (KCCQ) summary score was  $46.9 \pm 22.6$  at baseline, and  $67.5 \pm 22.6$  at 30 days for the entire VI population. Except for self-efficacy which showed a small improvement, moderate to large improvements were observed in all other subscores at 30 days. In general, improvements in the TF patients were slightly larger compared to those observed in the TA/TAo patients.

Using the SF-36 norm based questionnaire, the physical component score for all patients improved from  $32.0 \pm 8.9$  at baseline to  $37.1 \pm 9.7$  at 30 days, and the mental component score improved from  $46.9 \pm 12.8$  at baseline to  $50.0 \pm 12.5$  at 30 days. In the TF patients, the physical component score improved from  $31.8 \pm 8.7$  at baseline to  $37.3 \pm 9.8$  at 30 days, and the mental component score improved from  $46.8 \pm 13.1$  at baseline to  $50.5 \pm 12.2$  at 30 days. In the TA/TAo patients, the physical component score improved from  $32.9 \pm 10.0$  at baseline to  $35.9 \pm 9.4$  at 30 days, and the mental component scores were  $47.2 \pm 11.1$  at baseline and  $47.2 \pm 14.0$  at 30 days.

## **SUMMARY OF SUPPLEMENTAL CLINICAL INFORMATION**

### **Supplemental Clinical Study Design**

Supplemental clinical data came from a study (referred to as “S3OUS” hereafter) conducted in Europe and Canada.

The S3OUS study was a non-randomized, prospective, multi-center study in inoperable, high surgical risk, and intermediate surgical risk patients who underwent implantation of the 23, 26, or 29 mm SAPIEN 3 valve.

Except the intermediate surgical risk patients, the inclusion/exclusion criteria of the S3OUS trial were largely similar to those of the PIIS3HR trial. The S3OUS study had a minimum age requirement ( $\geq 75$  years) and the upper limit for AVA was higher ( $< 1 \text{ cm}^2$  instead of  $\leq 0.80 \text{ cm}^2$ ). Additionally, the S3OUS study included BAV within 30 days of the procedure (unless BAV was a bridge to procedure), patients with planned concomitant surgical or transcatheter ablation for atrial fibrillation, hemodynamic or respiratory instability requiring inotropic support, mechanical ventilation or mechanical heart assistance within 30 days of screening; and the need for emergency surgery for any reason. Furthermore, the exclusion criteria in the S3OUS study excluded senile dementia and any neurologic disease which severely affected the ability to walk or perform everyday activities, and shortened the time interval regarding confirmed stroke or TIA (within 3 months instead of 6 month of the procedure). The follow-up periods were discharge or 7 days, whichever comes first, 30 days, 1 year, and annually thereafter to a minimum of 5 years post procedure.

### **Patient Accountability**

Patients were treated at 14 investigational sites. Note that the intermediate risk patients enrolled in the S3OUS study were excluded from the analysis presented herein. The database included 102 “all treated” (AT) inoperable and high surgical risk patients. “All treated” population is defined to include all patients who were enrolled in the trial and for whom the study valve implantation procedures were started (i.e., the anesthesia was started).

One patient was excluded from the VI population. This patient experienced an aortic root rupture caused by displacement of a large lump of calcium with sharp edges through the native aortic annulus following balloon expansion of the SAPIEN 3 valve. The patient was subsequently converted to SAVR. After the patient was weaned off cardio-pulmonary bypass, bleeding in the region of the dorsal root occurred, and the patient died on the operating table.

A total of 56 patients were successfully implanted with a SAPIEN 3 valve via the transfemoral access route, and 45 via the transapical/transaortic access route, as shown in Table 16.

**Table 16:  
Patient Accountability (S3OUS)**

<b>SAPIEN 3 Valve Overall</b>		<b>SAPIEN 3 Valve Transfemoral Access</b>		<b>SAPIEN 3 Valve Non-Transfemoral Access</b>	
<b>All Treated (AT) Population</b>	<b>Valve Implant (VI) Population</b>	<b>All Treated (AT) Population</b>	<b>Valve Implant (VI) Population</b>	<b>All Treated (AT) Population</b>	<b>Valve Implant (VI) Population</b>
102	101	57	56	45	45

All Treated (AT) Population consists of all patients who were enrolled in the trial and for whom the study valve implantation procedures were started (i.e., anesthesia was started).

Valve Implant (VI) Population consists of all enrolled patients who received a SAPIEN 3 valve, and retained the valve upon leaving the catheterization laboratory/hybrid suite.

## Study Population Demographics and Baseline Parameters

The demographics of the S3OUS study population are shown in Table 17.

**Table 17:  
Patient Demographics and Baseline Characteristics  
(S3OUS AT Population)**

<b>Demographics and Baseline Characteristics</b>	<b>SAPIEN 3 Valve Overall (N = 102)</b>	<b>SAPIEN 3 Valve Transfemoral Access (N = 57)</b>	<b>SAPIEN 3 Valve Non-Transfemoral Access (N = 45)</b>
Age, yr	84.1 ± 5.0	85.1 ± 4.6	83.0 ± 5.3
Male sex, no.(%)	40 (39.2%)	23 (40.4%)	17 (37.8%)
STS score	8.0 ± 4.7	8.2 ± 4.2	7.9 ± 5.2
Logistic EuroSCORE	24.1 ± 13.0	22.3 ± 11.3	26.4 ± 14.7
New York Heart Association (NYHA) class, no.(%):			
I/II	11 (10.8%)	6 (10.5%)	5 (11.1%)
III/IV	91 (89.2%)	51 (89.5%)	40 (88.9%)
Coronary artery disease, no.(%)	68 (66.7%)	36 (63.2%)	32 (71.1%)
Previous myocardial infarction, no.(%)	20 (19.6%)	7 (12.3%)	13 (28.9%)
Previous intervention, no.(%)			
Coronary-artery bypass grafting (CABG)	24 (23.5%)	10 (17.5%)	14 (31.1%)
Percutaneous coronary intervention (PCI)	34 (33.3%)	16 (28.1%)	18 (40.0%)
Prior aortic valvuloplasty	10 (9.8%)	8 (14.0%)	2 (4.4%)
Stroke, no.(%)	7 (6.9%)	4 (7.0%)	3 (6.7%)
Peripheral vascular disease, no.(%)	27 (26.5%)	10 (17.5%)	17 (37.8%)
Chronic obstructive pulmonary disease (COPD), no.(%):			
Any	25 (24.5%)	13 (22.8%)	12 (26.7%)
Oxygen-dependent	1 (1.0%)	1 (1.8%)	0 (0%)
Atrial fibrillation, no.(%)	48 (47.1%)	22 (38.6%)	26 (57.8%)
Permanent pacemaker, no.(%)	15 (14.7%)	7 (12.3%)	8 (17.8%)
Severe pulmonary hypertension, no.(%)	10 (9.8%)	6 (10.5%)	4 (8.9%)
Severe liver disease / Cirrhosis, no.(%)	1 (1.0%)	1 (1.8%)	0 (0%)
Echocardiographic findings			
Effective Orifice Area (EOA), cm <sup>2</sup>	0.6 ± 0.2	0.6 ± 0.2	0.6 ± 0.1
Mean aortic-valve gradient, mmHg	44.8 ± 15.3	45.2 ± 14.7	44.2 ± 16.1
Mean left ventricular ejection fraction (LVEF), %	56.7 ± 9.1	57.7 ± 9.3	55.3 ± 8.7
Moderate or severe mitral regurgitation, no./total no. (%)	23/85 (27.1%)	9/48 (18.8%)	14/37 (37.8%)
Plus-minus values are means ± SD.			

## Safety and Effectiveness Results

### Key Adverse Events

Key adverse events as adjudicated by the CEC are presented in Table 18.

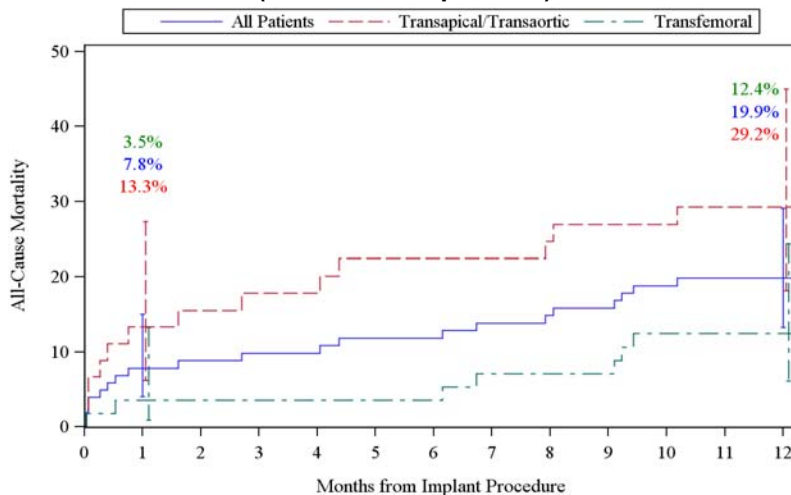
**Table 18:  
CEC Adjudicated Adverse Events at 1 Year  
(S3OUS AT Population)**

Outcomes	30 Day			1 Year		
	SAPIEN 3 Valve Overall	SAPIEN 3 Valve Transfemoral Access	SAPIEN 3 Valve Non-Transfemoral Access	SAPIEN 3 Valve Overall	SAPIEN 3 Valve Transfemoral Access	SAPIEN 3 Valve Non-Transfemoral Access
Composite Event Rate of Death, All Stroke and AI $\geq$ Moderate, n/N (%)	13/88 (14.8%)	3/50 (6.0%)	10/38 (26.3%)	25/82 (30.5%)	9/47 (19.1%)	16/35 (45.7%)
Death						
From any death, n/N (%)	8/102 (7.8%)	2/57 (3.5%)	6/45 (13.3%)	20/102 (19.6%)	7/57 (12.3%)	13/45 (28.9%)
From cardiovascular cause, n/N (%)	7/102 (6.9%)	2/57 (3.5%)	5/45 (11.1%)	9/102 (8.8%)	2/57 (3.5%)	7/45 (15.6%)
Stroke, n/N (%)	3/102 (2.9%)	1/57 (1.8%)	2/45 (4.4%)	5/102 (4.9%)	2/57 (3.5%)	3/45 (6.7%)
Aortic Insufficiency (AI) $\geq$ Moderate, n/N (%)	3/81 (3.7%)	1/49 (2.0%)	2/32 (6.3%)	1/62 (1.6%)	1/40 (2.5%)	0/22 (0.0%)
Disabling Stroke, n/N (%)	0/102 (0.0%)	0/57 (0.0%)	0/45 (0.0%)	1/102 (1.0%)	1/57 (1.8%)	0/45 (0.0%)
Myocardial Infarction, n/N (%)	2/102 (2.0%)	2/57 (3.5%)	0/45 (0.0%)	3/102 (2.9%)	2/57 (3.5%)	1/45 (2.2%)
Major Vascular Complications, n/N (%)	5/102 (4.9%)	1/57 (1.8%)	4/45 (8.9%)	N/A	N/A	N/A
Acute Kidney Injury - Stage III, n/N (%)	0/102 (0.0%)	0/57 (0.0%)	0/45 (0.0%)	N/A	N/A	N/A
Disabling Bleeding Event, n/N (%)	6/102 (5.9%)	3/57 (5.3%)	3/45 (6.7%)	N/A	N/A	N/A
Valve Dysfunction Requiring Intervention, n/N (%)	0/102 (0.0%)	0/57 (0.0%)	0/45 (0.0%)	N/A	N/A	N/A
Prosthetic Valve Endocarditis, n/N (%)	0/102 (0.0%)	0/57 (0.0%)	0/45 (0.0%)	1/102 (1.0%)	0/57 (0.0%)	1/45 (2.2%)
Conduction Abnormality Requiring Pacemaker, n/N (%)	14/102 (13.7%)	7/57 (12.3%)	7/45 (15.6%)	14/102 (13.7%)	7/57 (12.3%)	7/45 (15.6%)

The composite adverse event rate involving all-cause mortality, all stroke, and AI  $\geq$  moderate at 30 days for all patients is higher in the S3OUS cohort than PIIS3HR cohort (14.8% vs. 6.8%). This disparity is due to the composition of the study populations, specifically the S3OUS cohort comprises 44.1% TA/TAo patients vs. 15.8% TA/TAo patients in the PIIS3HR cohort. Note, the composite adverse event rate at 30 days for TF patients was similar, specifically, 6.0% in the S3OUS cohort and 5.8% in the PIIS3HR cohort.

The K-M estimates for all-cause mortality for all patients, the TF patients, and the TA/TAo patients are shown in Figure 16.

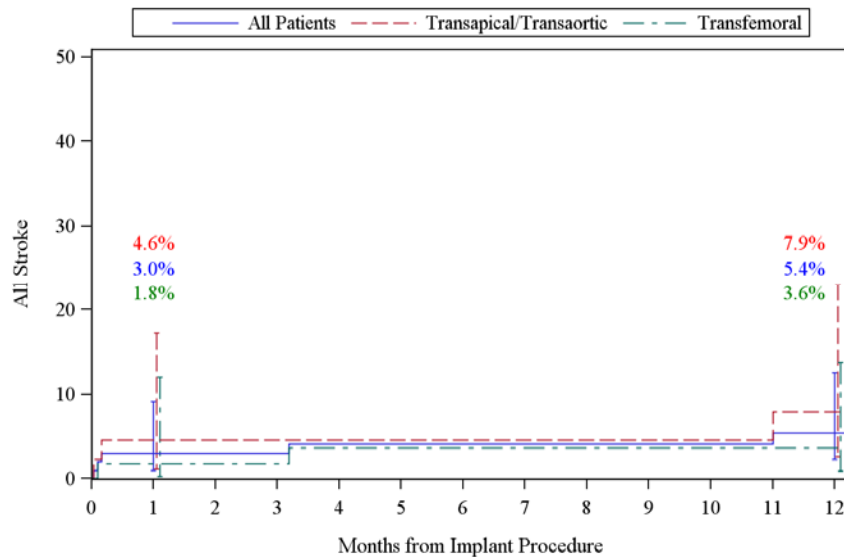
**Figure 16:  
All-Cause Mortality at 1 Year  
(S3OUS AT Population)**



**Note:** The confidence intervals are calculated without multiplicity adjustment. The adjusted confidence intervals could be wider than presented here. As such, confidence intervals are provided to illustrate the variability only and should not be used to draw any statistical conclusion.

The K-M estimates for the stroke rate for all patients, the TF patients, and the T/TAo patients are shown in Figure 17.

**Figure 17:  
All Stroke at 1 Year  
(S3OUS AT Population)**

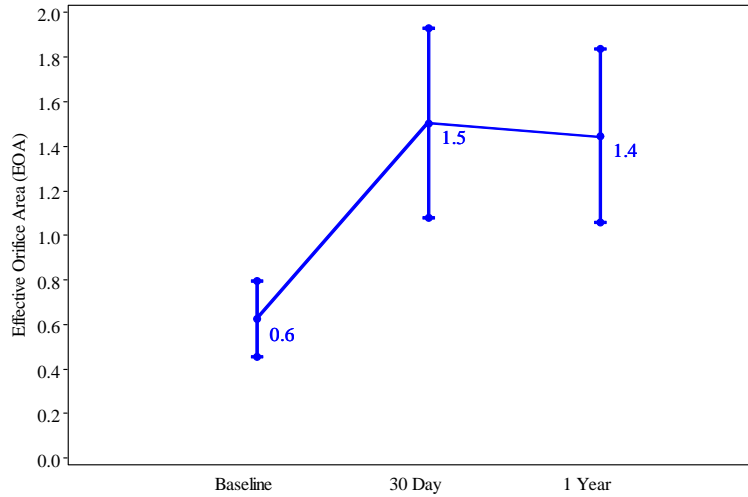


**Note:** The confidence intervals are calculated without multiplicity adjustment. The adjusted confidence intervals could be wider than presented here. As such, confidence intervals are provided to illustrate the variability only and should not be used to draw any statistical conclusion.

## Valve Performance

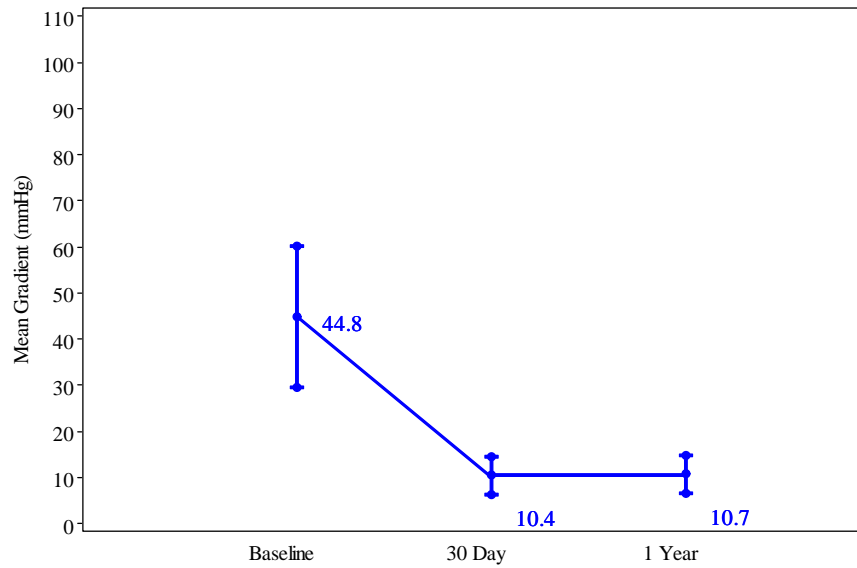
The mean EOA increased from  $0.6 \pm 0.2 \text{ cm}^2$  at baseline to  $1.5 \pm 0.4 \text{ cm}^2$  at 30 days and  $1.4 \pm 0.4 \text{ cm}^2$  at 1 year, as shown in Figure 18.

**Figure 18:**  
**Effective Orifice Area**  
**(S3OUS VI Population)**



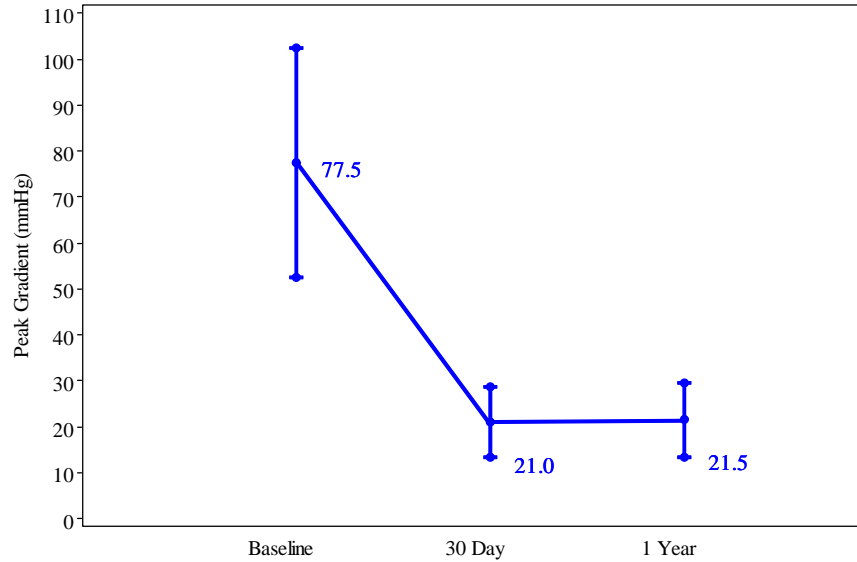
The average mean gradient decreased from  $44.8 \pm 15.4 \text{ mmHg}$  at baseline to  $10.4 \pm 4.1 \text{ mmHg}$  at 30 days and maintained at  $10.7 \pm 4.1 \text{ mmHg}$  at 1 year, as shown in Figure 19.

**Figure 19:**  
**Mean Gradient**  
**(S3OUS VI Population)**



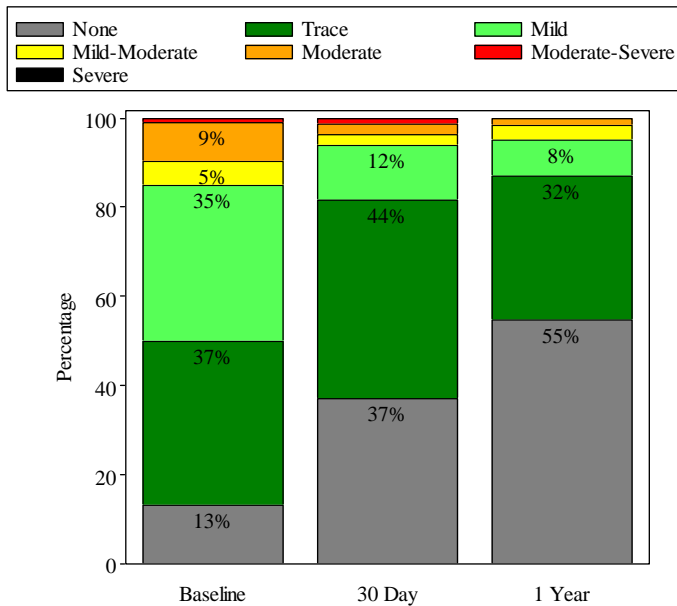
The mean peak gradient decreased from  $77.5 \pm 24.9$  mmHg at baseline to  $21.0 \pm 7.7$  mmHg at 30 days, and maintained at  $21.5 \pm 8.2$  mmHg at 1 year, as shown in Figure 20.

**Figure 20:  
Peak Gradient  
(S3OUS VI Population)**



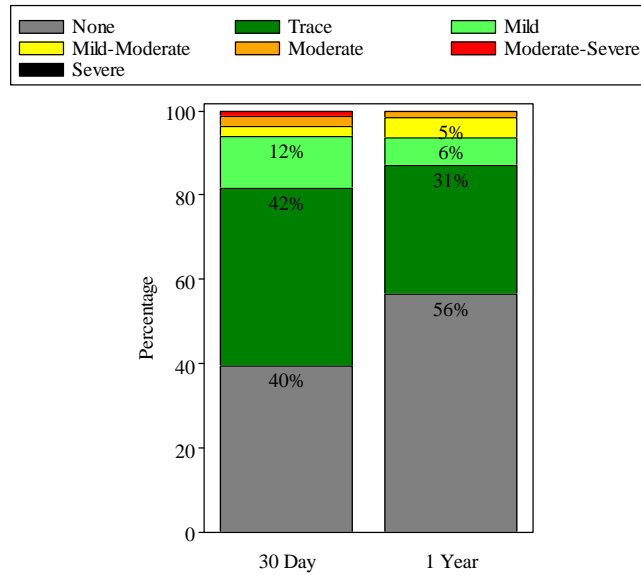
The proportion of patients with aortic insufficiency  $\geq$  moderate was 9.8% at baseline, 3.7% at 30 days, and 1.6% at 1 year, as shown in Figure 21.

**Figure 21:  
Aortic Insufficiency  
(S3OUS VI Population)**



The proportion of patients with aortic PVL  $\geq$  moderate was 3.7% at 30 days, and 1.6% at 1 year, as shown in Figure 22.

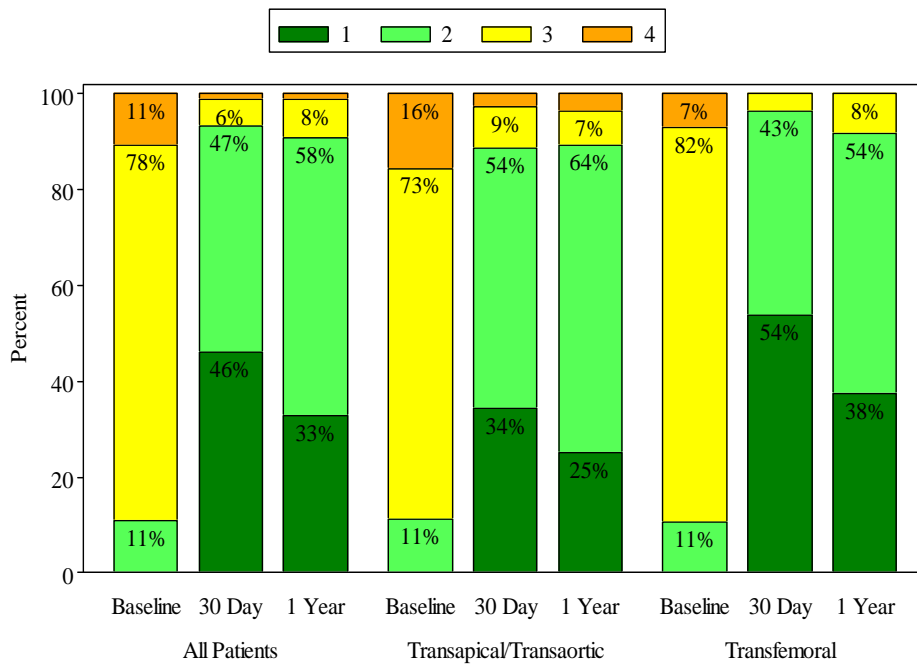
**Figure 22:  
Aortic Paravalvular Leak  
(S3OUS VI Population)**



NYHA

The NYHA class by visit is shown in Figure 23. For all patients, the mean NYHA class decreased from  $3.0 \pm 0.5$  at baseline to  $1.6 \pm 0.7$  at 30 days and  $1.8 \pm 0.6$  at 1 year.

**Figure 23:  
NYHA Class by Visit  
(S3OUS AT Population)**





## **PARTNER II SAPIEN 3 INTERMEDIATE RISK COHORT**

### **Patient Accountability**

At the time of database lock, of the 1078 patients enrolled in the PMA study (PIIS3i), 99.2% (1069) patients are available for analysis at the completion of the study, the 1-year post-operative visit. Table 19 presents patient accountability in the PIIS3i and PIIA-SAVR cohorts. Of the 1,074 eligible patients (Eligible Patient or EP Population) in PIIS3i, 1,069 were successfully implanted with a SAPIEN 3 valve and constitute the PIIS3i Valve Implant (VI) population. Among the VI population, 943 patients were implanted via the transfemoral (TF) access route, and 126 patients via a non-transfemoral (non-TF; mainly transapical and transaortic) access route. Of the 938 eligible patients in the PIIA-SAVR cohort, 936 were successfully implanted with a surgical valve and constitute the PIIA-SAVR VI population.

**Table 19:  
Patient Accountability**

	<b>All Enrolled Patients</b>	<b>Eligible Patient (EP) Population*</b>	<b>Valve Implant (VI) Population†</b>
SAPIEN 3 Cohort	1078	1074	1069
TF	952	948	943
Non-TF	126	126	126
PIIA SAVR	1021	938	936

\* Eligible Patient (EP) Population consists of all enrolled patients who were determined eligible after screening, entered into the catheterization laboratory and remained eligible to receive the assigned implant.

† Valve Implant (VI) Population is a subset of the EP Population who received the assigned valve, and retained the valve upon leaving the catheterization laboratory.

### **Study Population Demographics and Baseline Parameters**

The demographics of the study population are typical for an aortic stenosis valve replacement study performed in the US, as summarized in Table 20 for the PIIS3i and PIIA-SAVR EP populations.

**Table 20:  
Patient Demographics and Baseline Characteristics of the EP Population**

<b>Demographics &amp; Characteristics*</b>	<b>SAPIEN 3 Valve</b>			<b>PIIA-SAVR (N = 938)</b>
	<b>Overall (N = 1074)</b>	<b>TF Only (N = 948)</b>	<b>Non-TF Only (N = 126)</b>	
Age – years	81.9 ± 6.60	82.1 ± 6.57	80.7 ± 6.69	81.6 ± 6.73
Male sex	662/1074 (61.6%)	577/948 (60.9%)	85/126 (67.5%)	514/938 (54.8%)
Society of Thoracic Surgeons (STS) score	5.3 ± 1.29	5.3 ± 1.29	5.6 ± 1.28	5.8 ± 1.92
New York Heart Association (NYHA) class				
I/II	294/1074 (27.4%)	262/948 (27.6%)	32/126 (25.4%)	225/937 (24.0%)
III/IV	780/1074 (72.6%)	686/948 (72.4%)	94/126 (74.6%)	712/937 (76.0%)
Coronary artery disease	748/1074 (69.6%)	652/948 (68.8%)	96/126 (76.2%)	623/938 (66.4%)
Previous myocardial infarction	172/1074 (16.0%)	133/948 (14.0%)	39/126 (31.0%)	166/938 (17.7%)
Previous intervention				
Coronary artery bypass grafting (CABG)	301/1074 (28.0%)	248/948 (26.2%)	53/126 (42.1%)	241/938 (25.7%)
Percutaneous coronary intervention (PCI)	344/1074 (32.0%)	299/948 (31.5%)	45/126 (35.7%)	254/938 (27.1%)

Demographics & Characteristics*	SAPIEN 3 Valve			PIIA-SAVR (N = 938)
	Overall (N = 1074)	TF Only (N = 948)	Non-TF Only (N = 126)	
Prior aortic valvuloplasty	55/1074 (5.1%)	51/948 (5.4%)	4/126 (3.2%)	45/938 (4.8%)
Cerebral vascular accident (CVA)	97/1074 (9.0%)	81/948 (8.5%)	16/126 (12.7%)	96/938 (10.2%)
Peripheral vascular disease	304/1074 (28.3%)	231/948 (24.4%)	73/126 (57.9%)	301/938 (32.1%)
Chronic obstructive pulmonary disease (COPD)				
Any	321/1072 (29.9%)	270/946 (28.5%)	51/126 (40.5%)	279/932 (29.9%)
Oxygen-dependent	53/1067 (5.0%)	46/942 (4.9%)	7/125 (5.6%)	26/925 (2.8%)
Atrial fibrillation	385/1074 (35.8%)	342/948 (36.1%)	43/126 (34.1%)	326/938 (34.8%)
Permanent pacemaker	142/1074 (13.2%)	121/948 (12.8%)	21/126 (16.7%)	113/938 (12.0%)
Severe pulmonary hypertension	25/1074 (2.3%)	19/948 (2.0%)	6/126 (4.8%)	N/A
Frailty	92/1074 (8.6%)	86/948 (9.1%)	6/126 (4.8%)	15/938 (1.6%)
Porcelain aorta	1/1074 (0.1%)	1/948 (0.1%)	0/126 (0.0%)	0/938 (0.0%)
Chest deformities that preclude an open chest procedure	1/1074 (0.1%)	1/948 (0.1%)	0/126 (0.0%)	0/938 (0.0%)
Cirrhosis	4/1074 (0.4%)	4/948 (0.4%)	0/126 (0.0%)	4/938 (0.4%)
Echocardiographic findings (Valve Implant Population)				
Effective orifice area (EOA) - cm <sup>2</sup>	0.7 ± 0.17	0.7 ± 0.16	0.7 ± 0.18	0.7 ± 0.20
Mean aortic-valve gradient –mmHg	46.1 ± 12.63	46.1 ± 12.66	45.8 ± 12.47	44.7 ± 12.55
Mean left ventricular ejection fraction (LVEF) %	58.5 ± 13.36	58.8 ± 13.24	56.0 ± 14.05	55.4 ± 11.75
Moderate or severe mitral regurgitation	91/1033 (8.8%)	87/909 (9.6%)	4/124 (3.2%)	153/841 (18.2%)

\*Continuous measures - Mean ± SD; Categorical measures – n/total no. (%)

## Safety and Effectiveness Results

### Primary Endpoints

The primary endpoint was a composite of all-cause death, stroke, and AI  $\geq$  moderate at 1 year. The weighted proportion difference of the primary endpoint was -9.2% (90% CI: [-12.4%, -6.0%]) using the average treatment effect on the treated (ATT) method<sup>[3]</sup>, as shown in Table 21 and Figure 24. Since the upper limit of the CI was  $<$  7.5%, non-inferiority was met.

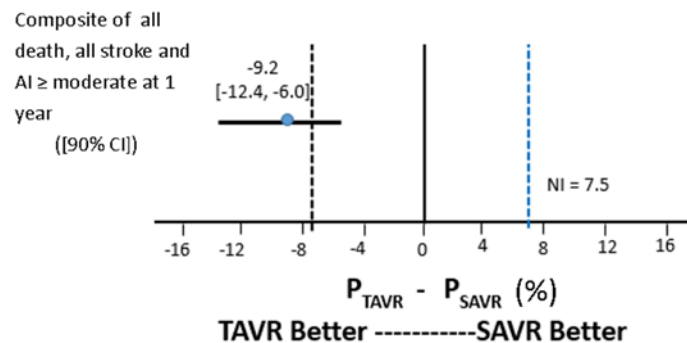
**Table 21:**  
**Primary Endpoint Non-Inferiority Test**  
**(VI Population)**

	Observed Event rate		Propensity Score Quintile Pooled Proportion Difference (ATT Method*) [90% CI] <sup>†</sup>	Margin	Conclusion for Non-Inferiority Test
	SAPIEN 3 (N = 1069)	PIIA-SAVR (N = 936)			
Composite of all-cause death, all stroke, and aortic insufficiency (AI) $\geq$ moderate at 1 year	13.0%	23.2%	-9.2% [-12.4%, -6.0%]	7.5%	Pass

\* ATT: average treatment effect on the treated

<sup>†</sup> Two-sided 90% Wald-type confidence interval

**Figure 24:**  
**Forest Plot – Composite of All Death, All Stroke and AI  $\geq$  Moderate**  
**(VI Population)**



The Kaplan-Meier (KM) estimates for all-cause death and all stroke at 1 year for the PIIS3i cohort and the PIIA-SAVR cohort are provided in Table 22, as well as Figures 25 and 26, respectively.

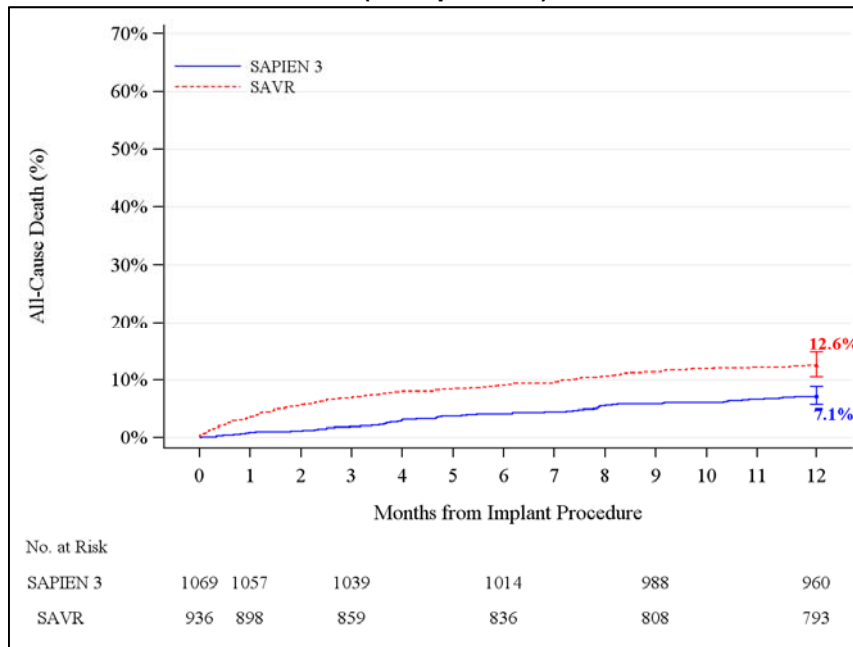
**Table 22:**  
**All-Cause Death and All Stroke at 1 Year**  
**(VI Population)**

Endpoints	SAPIEN 3 Valve (N = 1069)			PIIA-SAVR (N = 936)			Propensity Score Quintile Pooled Proportion Difference (ATT Method <sup>†</sup> )
	Observed Event Rate	Kaplan-Meier Event Rate <sup>*</sup>		Observed Event Rate	Kaplan-Meier Event Rate <sup>*</sup>		
		Point Estimate	Standard Error		Point Estimate	Standard Error	
All-cause death at 1 year	7.0%	7.1%	0.79%	12.4%	12.6%	1.09%	-5.2%
All stroke at 1 year	4.5%	4.6%	0.65%	7.9%	8.1%	0.91%	-3.5%

\* Kaplan-Meier estimates were calculated at 365 days and included only the first event for each patient. Events occurring after 365 days were not included in this analysis.

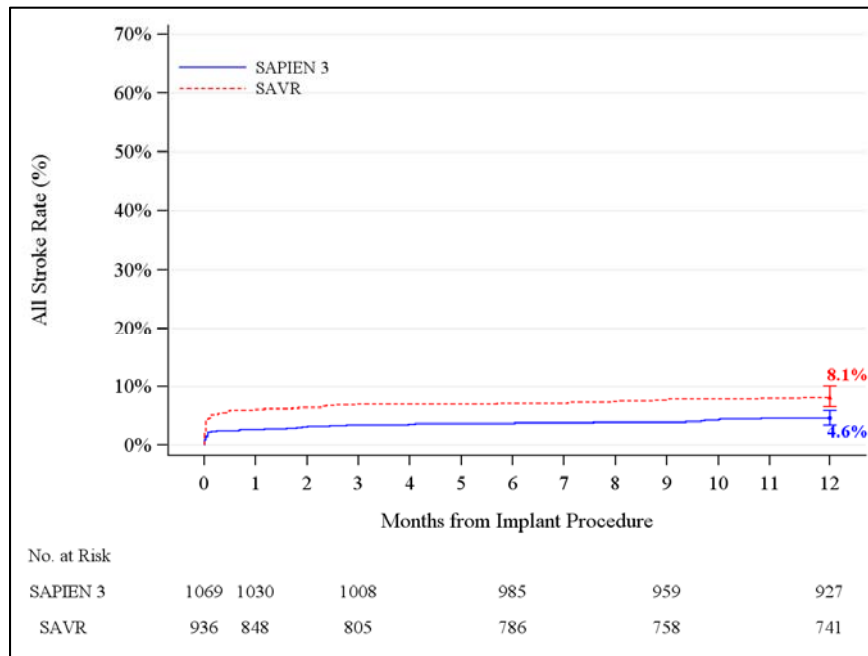
<sup>†</sup> ATT: average treatment effect on the treated

**Figure 25:  
All-Cause Death through 1 Year  
(VI Population)**



**Note:** The confidence intervals were calculated without multiplicity adjustment. The adjusted confidence intervals could be wider than presented here. As such, the confidence intervals are provided to illustrate the variability only and should not be used to draw any statistical conclusion.

**Figure 26:  
All Stroke through 1 Year  
(VI Population)**



**Note:** The confidence intervals were calculated without multiplicity adjustment. The adjusted confidence intervals could be wider than presented here. As such, the confidence intervals are provided to illustrate the variability only and should not be used to draw any statistical conclusion.

The proportion of patients with AI  $\geq$  moderate at 1 year was 1.6% for the PIIS3i cohort and 0.3% for the PIIA-SAVR cohort, as shown in Table 23.

**Table 23:  
Aortic Insufficiency (AI)  $\geq$  Moderate at 1 Year (VI Population)**

	Observed Event Rate		Propensity Score Quintile Pooled Proportion Difference (ATT Method*)
	SAPIEN 3 Valve (N = 1069)	SAVR (N = 936)	
Aortic insufficiency (AI) $\geq$ moderate	1.6%	0.3%	1.2%

\* ATT: average treatment effect on the treated

Secondary Endpoints

The secondary endpoints were examined in a pre-specified order adjusted for the propensity quintiles using the ATT method. Table 24 summarizes the statistical conclusions on the non-inferiority hypothesis testing of the five secondary endpoints for labeling that were evaluated using a gatekeeping/hierarchical multiplicity adjustment procedure to control the overall type I error to 0.05. For each secondary endpoint, the upper limit of the confidence interval was less than the respective non-inferiority margin. Therefore, for each of the secondary endpoints for labeling, the SAPIEN 3 valve was non-inferior to SAVR.

**Table 24:  
Secondary Endpoints for Labeling – Gatekeeping/Hierarchical Method (VI Population)**

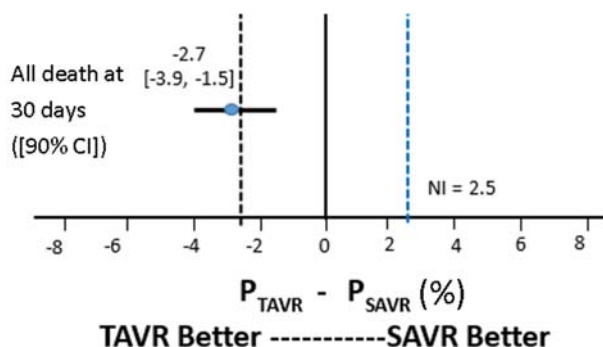
Pre-Specified Order for Gatekeeping/Hierarchical Method	Endpoints	Observed Event Rate		Weighted Proportion Difference in Average Treatment Effect on the Treated [90% CI]†	Margin	Conclusion for Non-Inferiority Test
		SAPIEN 3 Valve (N = 1069)	PIIA-SAVR (N = 936)			
No. 1	Composite of all death, all strokes, life threatening (disabling)/ major bleeding and major vascular complication at 30 days	18.3%	79.4%	-60.5% [-63.5%, -57.4%]	7.5%	Pass
No. 2	Major vascular and access complications through 30 days	5.8%	5.3%	0.3% [-1.5%, 2.0%]	5.0%	Pass
No. 3	Life threatening (disabling)/ major bleeding through 30 days	14.6%	78.2%	-63.2% [-66.2%, -60.2%]	5.0%	Pass
No. 4	All-cause death through 30 days	0.9%	3.7%	-2.7% [-3.9%, -1.5%]	2.5%	Pass

Pre-Specified Order for Gatekeeping/ Hierarchical Method	Endpoints	Observed Event Rate		Weighted Proportion Difference in Average Treatment Effect on the Treated [90% CI] <sup>†</sup>	Margin	Conclusion for Non-Inferiority Test
		SAPIEN 3 Valve (N = 1069)	PIIA-SAVR (N = 936)			
No. 5	All stroke through 30 days	2.6%	6.1%	-3.2% [-4.7%, -1.6%]	2.5%	Pass

<sup>†</sup> Two-sided 90% Wald-type confidence interval.

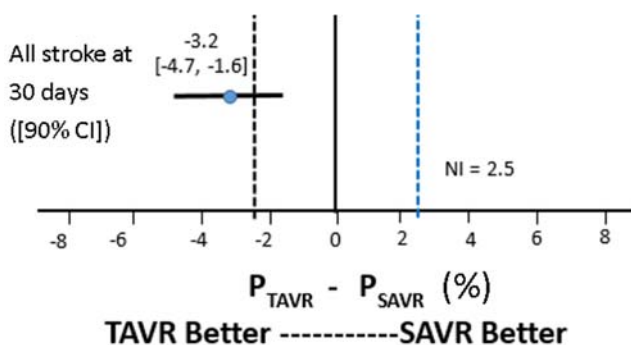
The forest plots for all-cause death and all stroke at 30 days are provided in Figures 27 and 28, respectively.

**Figure 27:**  
**Forest Plot – All-Cause Death at 30 Days (VI Population)**



**Note:** As part of a pre-specified hierarchy, the hypothesis for this endpoint was tested using a hierarchical gatekeeping approach. The confidence interval shown here was not adjusted for multiplicity per the gatekeeping approach.

**Figure 28:**  
**Forest Plot – All Stroke at 30 Days (VI Population)**



**Note:** As part of a pre-specified hierarchy, the hypothesis for this endpoint was tested using a hierarchical gatekeeping approach. The confidence interval shown here was not adjusted for multiplicity per the gatekeeping approach.

## Adverse Events

The key CEC-adjudicated adverse events through 1 year for the EP population are presented in Table 25.

**Table 25:  
CEC-Adjudicated Adverse Events through 1 Year  
(EP Population)**

Event*	SAPIEN 3 Valve			PIIA-SAVR
	Overall	TF Only	Non-TF Only	
<b>7 Days</b>				
Acute kidney injury: Stage III	5/1074 (0.5%)	3/948 (0.3%)	2/126 (1.6%)	N/A
<b>30 Days</b>				
Death	12/1074 (1.1%)	10/948 (1.1%)	2/126 (1.6%)	35/938 (3.7%)
Cardiac death	10/1074 (0.9%)	9/948 (0.9%)	1/126 (0.8%)	26/938 (2.8%)
Non-cardiac death	2/1074 (0.2%)	1/948 (0.1%)	1/126 (0.8%)	9/938 (1.0%)
Stroke	29/1074 (2.7%)	24/948 (2.5%)	5/126 (4.0%)	57/938 (6.1%)
Major (disabling) stroke	11/1074 (1.0%)	7/948 (0.7%)	4/126 (3.2%)	41/938 (4.4%)
Minor (non-disabling) stroke	18/1074 (1.7%)	17/948 (1.8%)	1/126 (0.8%)	16/938 (1.7%)
Myocardial infarction	3/1074 (0.3%)	3/948 (0.3%)	0/126 (0.0%)	17/938 (1.8%)
Major vascular complication	65/1074 (6.1%)	60/948 (6.3%)	5/126 (4.0%)	50/938 (5.3%)
Life threatening (disabling) or major bleeding	159/1074 (14.8%)	112/948 (11.8%)	47/126 (37.3%)	733/938 (78.1%)
Aortic valve re-intervention	1/1074 (0.1%)	1/948 (0.1%)	0/126 (0.0%)	0/938 (0.0%)
Any endocarditis	2/1074 (0.2%)	2/948 (0.2%)	0/126 (0.0%)	0/938 (0.0%)
Rhythm disturbance requiring permanent pacemaker	108/1074 (10.1%)	99/948 (10.4%)	9/126 (7.1%)	68/938 (7.2%)
<b>1 Year</b>				
Death	79/1074 (7.4%)	61/948 (6.4%)	18/126 (14.3%)	117/938 (12.5%)
Cardiac death	47/1074 (4.4%)	37/948 (3.9%)	10/126 (7.9%)	70/938 (7.5%)
Non-cardiac death	32/1074 (3.0%)	24/948 (2.5%)	8/126 (6.3%)	47/938 (5.0%)
Stroke	49/1074 (4.6%)	40/948 (4.2%)	9/126 (7.1%)	74/938 (7.9%)
Major (disabling) stroke	24/1074 (2.2%)	16/948 (1.7%)	8/126 (6.3%)	53/938 (5.7%)
Minor (non-disabling) stroke	25/1074 (2.3%)	24/948 (2.5%)	1/126 (0.8%)	22/938 (2.3%)
Aortic valve re-intervention	6/1074 (0.6%)	6/948 (0.6%)	0/126 (0.0%)	4/938 (0.4%)
Any endocarditis	8/1074 (0.7%)	7/948 (0.7%)	1/126 (0.8%)	6/938 (0.6%)

\*Categorical measures - n. / total no. (%).

In addition, site-reported new-onset atrial fibrillation was 5.9% in the PIIS3i EP population and 29.2% in the PIIA-SAVR EP population.

Bleeding Rate

The bleeding rates utilizing the number of units transfused are presented in Table 26.

**Table 26:  
Bleeding Rate Using Site-Reported Units Transfused (EP Population)**

Event*	SAPIEN 3 Valve (N = 1074)	PIIA-SAVR (N = 938)
Transfusion units ≥ 2 and < 4	47/1074 (4.4%)	184/938 (19.6%)
Transfusion units ≥ 4	18/1074 (1.7%)	218/938 (23.2%)

\*Site-reported Transfusion at Day 0 or Day 1; Categorical measures - n. / total no. (%)

**Other Results**

**Procedural Information**

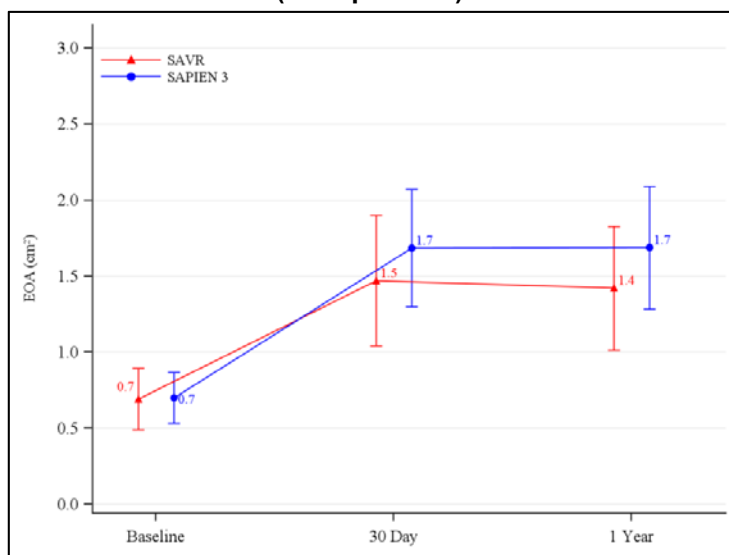
In the PIIS3i EP population the mean duration in the catheterization laboratory was 187.3 ± 53.2 minutes, the mean total procedure time was 84.2 ± 40.7 minutes, and the mean total anesthesia time was 186.9 ± 61.1 minutes, all of which were slightly shorter in the TF group. General anesthesia was used in the vast majority of cases; 18.9% of the TF patients had conscious sedation. Correct positioning of the valve was achieved in 99.3% of the patients. Four (4) patients (0.4%, all TF patients) were implanted with a second valve. One (1) patient (0.1%) experienced valve embolization and two (2) patients (0.2%) experienced annular rupture.

In the PIIA-SAVR EP population, the mean duration in the operating room was 333.2 ± 96.4 min, the mean total procedure time was 237.5 ± 86.58 min, and the mean anesthesia time was 333.5 ± 108.42 min. General anesthesia was used in all patients.

**Valve Performance**

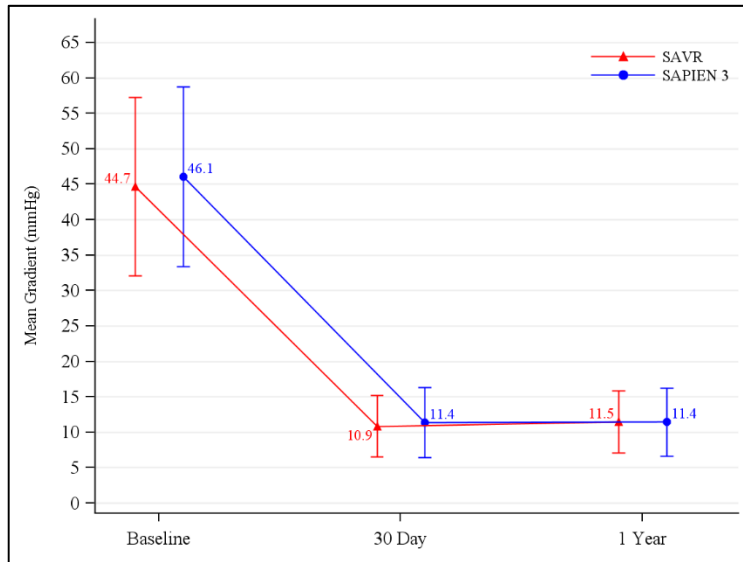
The measurements of EOA, mean gradient, peak gradient, total aortic regurgitation (AR), and aortic paravalvular leak (PVL) are presented in Figures 29-33. The increase in EOA and decrease in gradient were sustained at 1 year. In PIIS3i, the proportion of patients with total AR ≥ moderate was 6.2% at baseline, 3.9% at 30 days, and 1.6% at 1 year, while in PIIA-SAVR, the proportion of patients with total AR ≥ moderate was 12.0% at baseline, 0.7% at 30 days, and 0.3% at 1 year. The proportion of patients with aortic PVL ≥ moderate was 3.8% at 30 days and 1.5% at 1 year in PIIS3i, as compared to 0.5% at 30 days and 0.3% at 1 year in PIIA-SAVR.

**Figure 29:  
Effective Orifice Area  
(VI Population)**

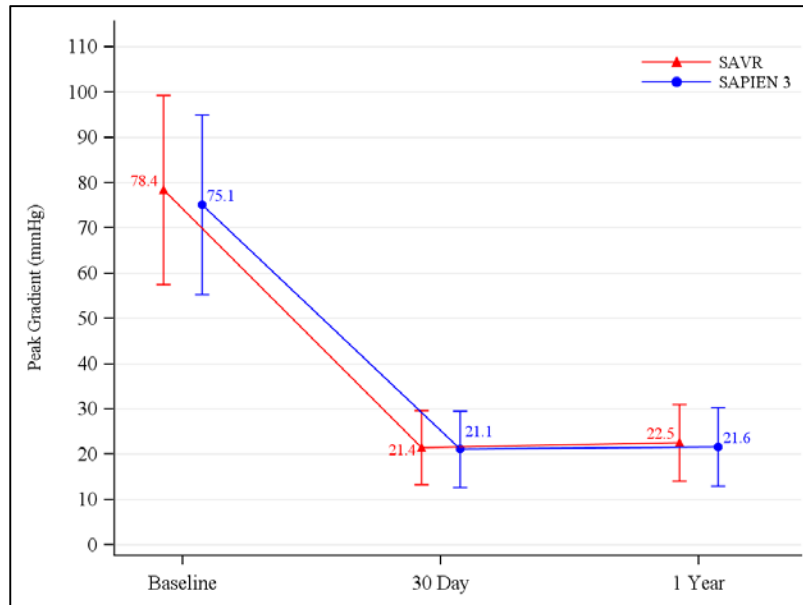




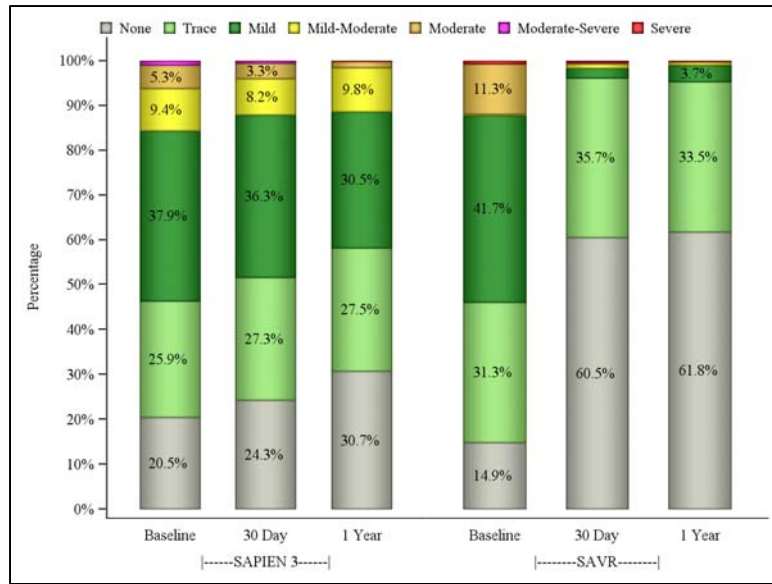
**Figure 30:  
Mean Gradient  
(VI Population)**



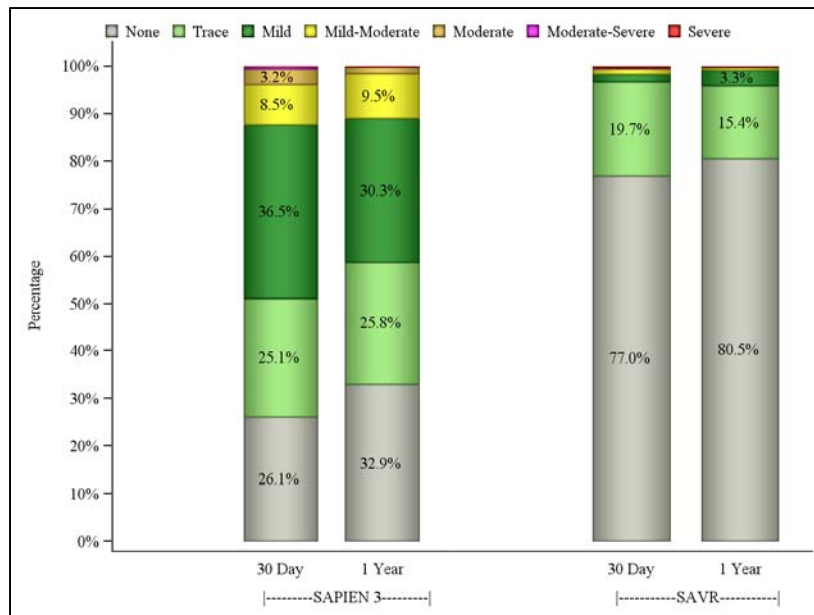
**Figure 31:  
Peak Gradient  
(VI Population)**



**Figure 32:  
Total Aortic Regurgitation  
(VI Population)**



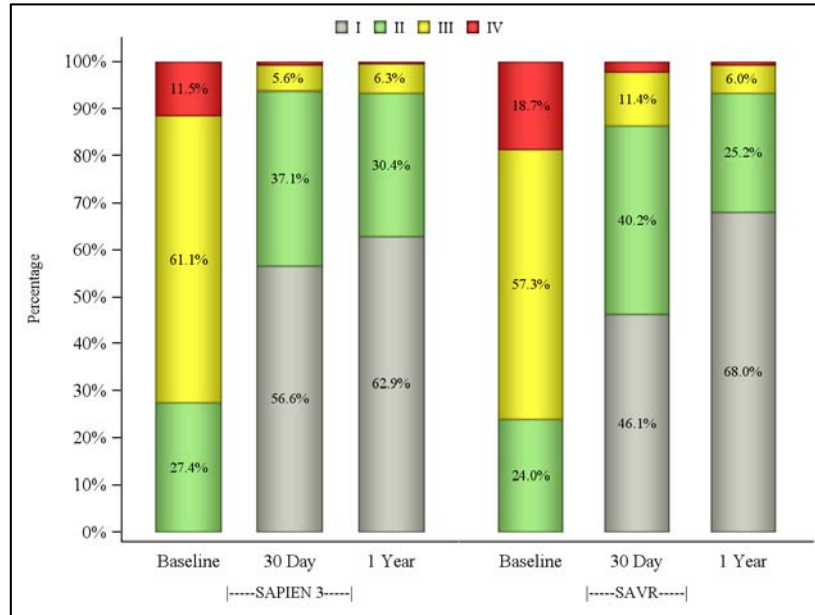
**Figure 33:  
Aortic Paravalvular Leak  
(VI Population)**



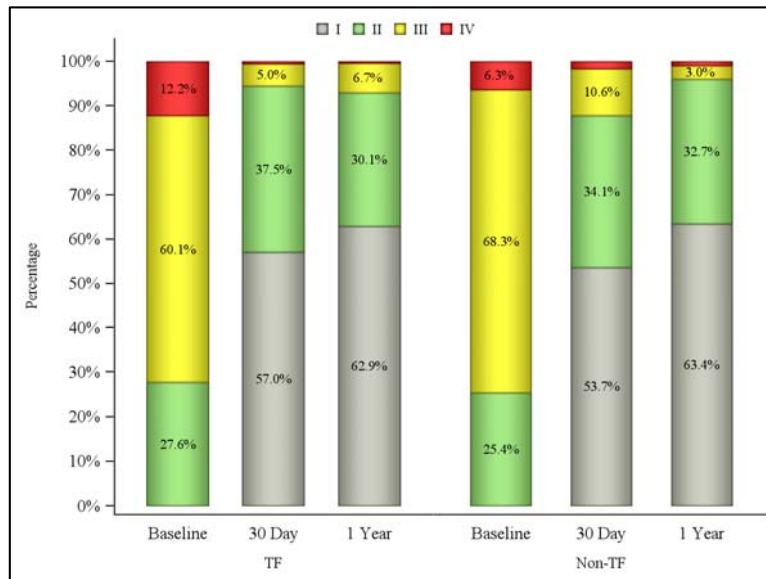
**NYHA**

The NYHA classifications by visit are presented in Figure 34. In PIIS3i, 72.6% of the patients were in NYHA Class III or IV at baseline, which reduced to 6.3% at 30 days and 6.7% at 1 year, while in PIIA-SAVR, the percentage of patients in NYHA Class III or IV was 76.0% at baseline, 13.6% at 30 days, and 6.7% at 1 year. A side-by-side comparison of the results by access approach is presented in Figure 35.

**Figure 34:  
NYHA Class by Visit  
(EP Population)**



**Figure 35:  
NYHA Class by Visit – TF versus non-TF Access  
(EP Population)**



### Six-Minute Walk Test (6MWT)

The improvements in mean 6MWT distance are presented in Table 27. The SAPIEN 3 valve patients had a similar increase in mean 6MWT distance from baseline to 1 year as the PIIA-SAVR patients.

**Table 27:  
6MWT Distance (EP Population)**

6MWT Distance (m)*	SAPIEN 3 Valve			PIIA-SAVR
	All	TF	Non-TF	
Baseline	193.9 ± 118.1	194.1 ± 117.2	192.5 ± 125.5	179.3 ± 123.2
30 days	230.6 ± 126.1	234.6 ± 123.6	199.0 ± 140.6	166.7 ± 126.4
1 year	227.7 ± 134.7	230.6 ± 133.6	202.8 ± 142.1	219.2 ± 133.8

\*Plus-minus values are means ± SD.

### Length of Stay (LoS)

The results for LoS are presented in Table 28. Overall, the SAPIEN 3 valve patients had shorter LoS than the PIIA-SAVR patients.

**Table 28:  
Length of Stay (EP Population)**

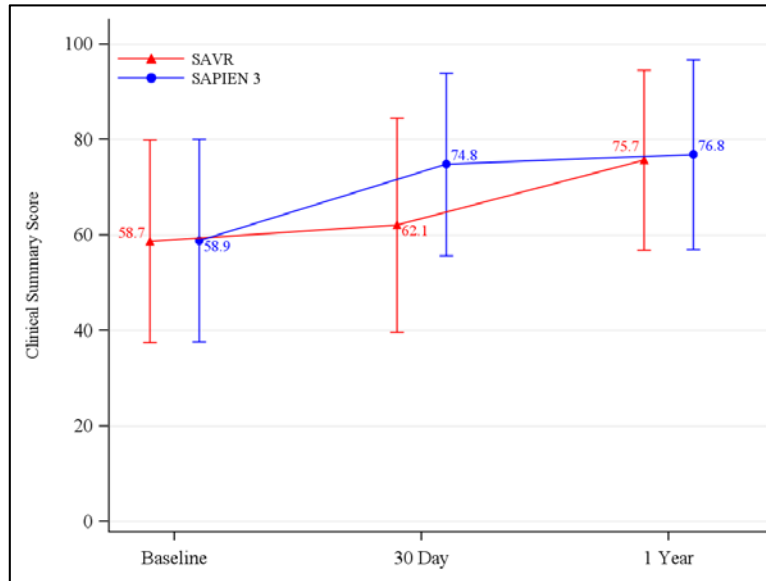
Length of Stay (days)*	SAPIEN 3 Valve			PIIA-SAVR
	All	TF	Non-TF	
Overall	5.5 ± 5.7	5.0 ± 5.2	9.3 ± 7.7	11.9 ± 7.6
ICU	2.7 ± 3.0	2.5 ± 2.6	4.2 ± 4.9	5.6 ± 6.1

\*Plus-minus values are means ± SD.

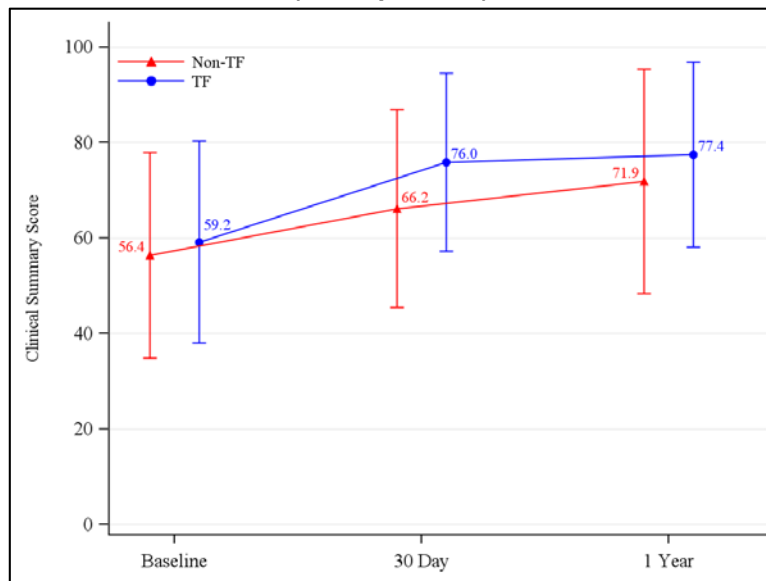
## QoL

The QoL measurements using the Kansas City Cardiomyopathy Questionnaire (KCCQ) clinical summary score are presented in Figure 36. Except for self-efficacy which showed a small improvement, moderate to large improvements were observed in all other subscores at 30 days and were sustained at 1 year in the PIIS3i EP population. A side-by-side comparison of the results by access approach is presented in Figure 37. In general, improvements in the TF group were slightly larger as compared to those observed in the Non-TF group.

**Figure 36:**  
**KCCQ Clinical Summary Score (EP Population)**



**Figure 37:**  
**KCCQ Clinical Summary Score - TF versus non-TF Access (EP Population)**



Additional QoL instruments

QoL was also measured using the visual analog scale (VAS) of the EuroQoL (EQ-5D) measure and the SF-36 Health Status Questionnaire. The VAS is a self-assessment in which patients rate their well-being on a scale from 0 to 100 where 0 is the worst state they can imagine and 100 is the best state. SF-36 uses 36 questions to measure functional health and well-being from the patient's point of view and is generally reported in two (2) summary scores on a scale from 0 to 100 which evaluate physical (the Physical Summary Score) and mental (the Mental Summary Score) health, with higher scores representing better functional health and well-being. The results of the VAS and SF-36 measures are presented in Tables 29 and 30, respectively.

**Table 29:  
EQ-5D Visual Analog Scale  
(EP Population)**

EQ-5D Visual Analog Scale*	SAPIEN 3 Valve			PIIA-SAVR
	All	TF	Non-TF	
Baseline	60.3 ± 20.0	61.0 ± 19.8	55.1 ± 20.7	59.5 ± 20.5
30 days	74.0 ± 16.6	74.8 ± 16.6	68.5 ± 16.2	67.2 ± 19.5
1 year	74.4 ± 17.2	74.7 ± 17.1	71.8 ± 17.8	74.3 ± 16.7

\*Plus-minus values are means ± SD.

**Table 30:  
SF-36 Health Status Questionnaire Score  
(EP Population)**

SF-36 Health Status Questionnaire Score*	SAPIEN 3 Valve			PIIA-SAVR
	All	TF	Non-TF	
Physical Component Score				
Baseline	34.7 ± 9.1	35.0 ± 9.1	33.1 ± 8.5	34.3 ± 9.0
30 days	39.7 ± 9.8	40.3 ± 9.7	34.8 ± 9.2	34.5 ± 8.4
1 year	40.0 ± 10.3	40.4 ± 10.2	37.0 ± 10.8	39.5 ± 10.4
Mental Component Score				
Baseline	48.0 ± 11.8	48.1 ± 11.8	47.0 ± 12.3	48.0 ± 12.3
30 days	51.8 ± 10.6	52.3 ± 10.4	47.8 ± 11.3	45.5 ± 13.3
1 year	52.5 ± 10.7	52.7 ± 10.8	50.7 ± 10.1	52.0 ± 11.3

\*Plus-minus values are means ± SD.

**PARTNER 3 SAPIEN 3 Low Risk Cohort**

**A. Accountability of the PMA Cohort**

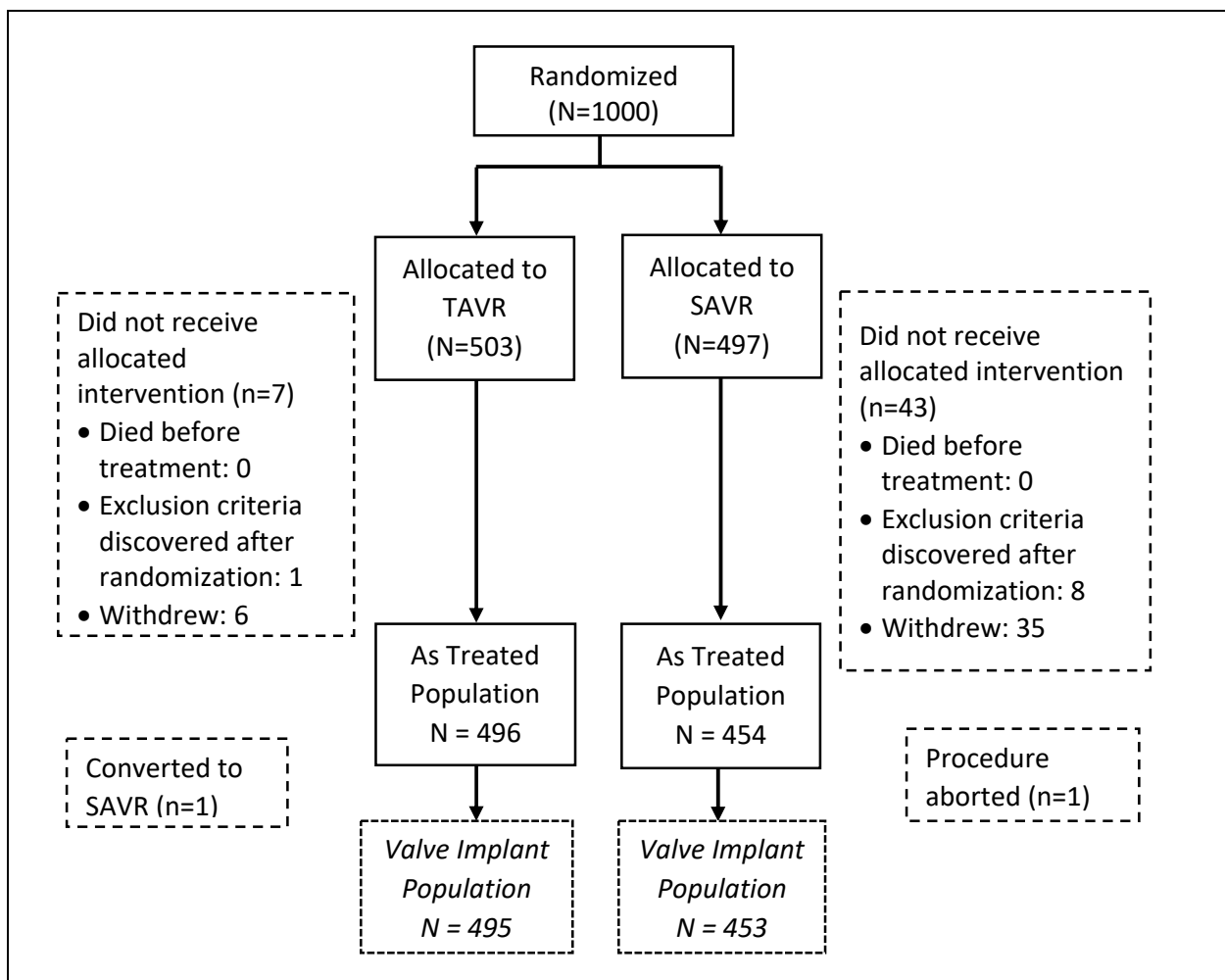
At the time of database lock, a total of 1000 subjects were randomized in the study, including 503 TAVR patients and 497 SAVR patients.

There were three different analysis populations defined in the protocol: Intention-to-Treat (ITT), As Treated (AT), and Valve Implant (VI), as summarized in Table 31 and Figure 38. The primary analysis was the AT analysis.

**Table 31: Analysis Populations**

Analysis Population	Definition	Number of Patients	
		TAVR	SAVR
Intention-To-Treat (ITT)	All randomized patients.	503	497
As Treated (AT)	All ITT patients for whom the index procedure was begun, whether or not the index procedure was completed.	496	454
Valve Implant (VI)	All AT patients who received and retained the intended valve during the index procedure.	495	453

**Figure 38: Patient Population Flowchart**



The overall follow-up compliance of the trial is summarized in Table 32.

**Table 32: Overall Study Compliance (AT Population)**

Patient Accountability	30-day Visit		1 Year Visit	
	TAVR (N=496)	SAVR (N=454)	TAVR (N=496)	SAVR (N=454)
Total patients	496	454	496	454
Non-eligible	2	11	6	30
Death	2	6	5	11
Withdrawal	0	3	0	12
Lost to follow-up	0	0	0	1
Exit with other reason	0	2	1	6
Visit not yet due	0	0	0	0
Eligible	494	443	490	424
Follow-up visit completed	96.5% (493)	96.5% (438)	97.8% (485)	91.2% (414)
Missed visit	0.2% (1)	1.1% (5)	1.0% (5)	2.2% (10)



## B. Study Population Demographics and Baseline Characteristics

The demographics and baseline characteristics of the study population are typical for a TAVR study performed in the U.S., as shown in Table 33. The treatment cohorts were generally well balanced with respect to age, gender, and STS risk score.

**Table 33:**  
**Patient Demographics and Baseline Characteristics**  
**(AT Population)**

Demographics and Baseline Characteristics	Summary Statistics*	
	TAVR (N = 496)	SAVR (N = 454)
Age - years	73.3 ± 5.8	73.6 ± 6.1
Male sex	67.5% (335/496)	71.1% (323/454)
Society of Thoracic Surgeons (STS) score	1.9 ± 0.7	1.9 ± 0.6
New York Heart Association (NYHA) class		
I/II	68.8% (341/496)	76.2% (346/454)
III/IV	31.1% (155/496)	23.8% (108/454)
Previous myocardial infarction	5.7% (28/495)	5.8% (26/452)
Previous intervention		
Coronary artery bypass grafting (CABG)	3.0% (15/494)	1.8% (8/451)
Percutaneous coronary intervention (PCI)	18.8% (93/494)	16.2% (73/452)
Stroke or cerebrovascular accident (CVA)	3.4% (17/496)	5.1% (23/453)
Peripheral vascular disease (PVD)	6.9% (34/494)	7.3% (33/453)
Atrial fibrillation	15.7% (78/496)	18.8% (85/453)
Atrial flutter	3.0% (15/496)	2.4% (11/452)
Permanent pacemaker or defibrillator	2.4% (12/496)	2.9% (13/454)
Hostile chest	0.0% (0/496)	0.0% (0/454)
Echocardiographic findings (Valve Implant Population)		
Valve area (cm <sup>2</sup> )	0.8 ± 0.2 (459)	0.8 ± 0.2 (424)
Mean gradient (mmHg)	49.4 ± 12.8 (484)	48.3 ± 11.8 (442)
Mean left ventricular ejection fraction (LVEF) %	65.7 ± 9.0 (472)	66.2 ± 8.6 (436)
Moderate or severe aortic regurgitation	3.9% (19/484)	2.5% (11/446)
Moderate or severe mitral regurgitation	1.3% (6/477)	3.2% (14/437)
* Continuous measures - Mean ± SD (Total no.); Categorical measures % (no./Total no.)		

### C. Safety and Effectiveness Results

#### 1. Primary Endpoint

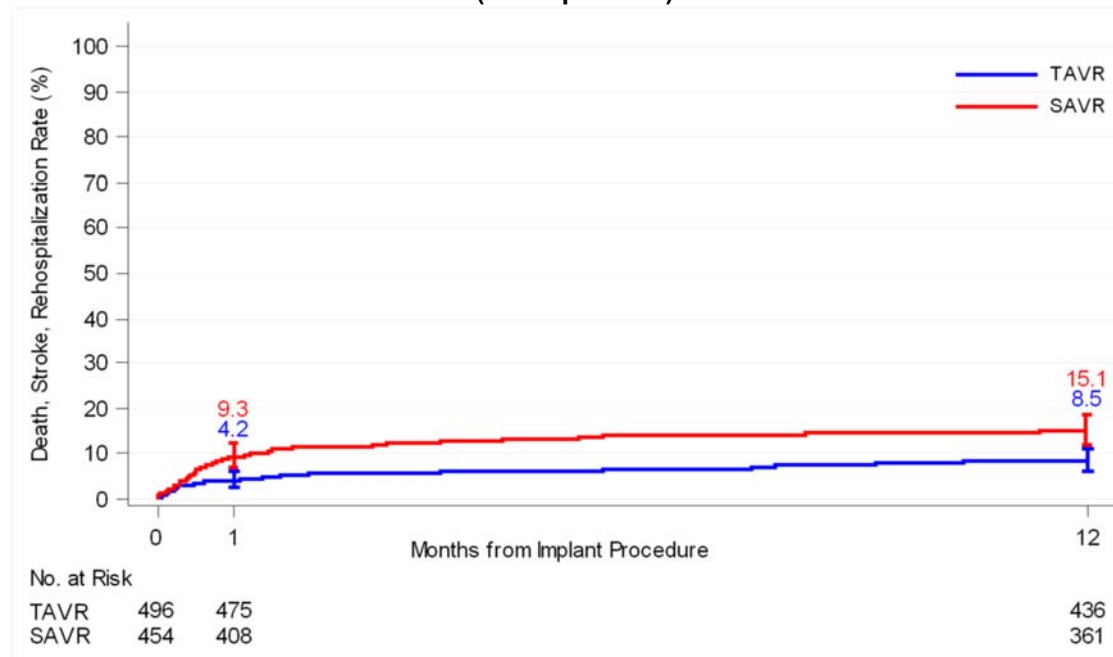
The primary endpoint results are presented in Table 34 and Figure 39. The rate of all-cause death, all stroke, or rehospitalization (valve-related or procedure-related and including heart failure) at 1-year was 8.5% in the TAVR group and 15.1% in the SAVR group. Since the upper limit of the 95% confidence interval for the difference in the primary endpoint event rate was < 6.0%, non-inferiority was achieved.

**Table 34:  
Primary Endpoint Analysis  
(AT Population)**

Event	Kaplan-Meier Rate*		Difference of KM Estimate (TAVR – SAVR)	95% CI* for the Difference	Non-inferiority Criterion
	TAVR (N=496)	SAVR (N=454)			
All-cause death, all stroke, or rehospitalization	8.5% (42)	15.1% (68)	-6.65%	[-10.77%, -2.52%]	Pass
All-cause death	1.0% (5)	2.5% (11)	-1.44%	[-3.13%, 0.24%]	
All stroke	1.2% (6)	3.1% (14)	-1.90%	[-3.77%, -0.02%]	
Rehospitalization	7.3% (36)	11.0% (49)	-3.74%	[-7.45%, -0.02%]	

\*Kaplan-Meier estimate - % (no. of subjects with the event)

**Figure 39: All-Cause Death, All Stroke, and Rehospitalization through 1 Year (AT Population)**



**Note:** The confidence intervals were calculated without multiplicity adjustment. The adjusted confidence intervals could be wider than presented here. As such, confidence intervals are provided to illustrate the variability only and should not be used to draw any statistical conclusion.

## 2. Secondary Endpoints

### Hypothesis testing:

Since the primary endpoint passed the non-inferiority testing, the prespecified superiority testing was carried out on the six select secondary endpoints sequentially. TAVR with the SAPIEN 3 valve was found to be superior to SAVR in all six secondary endpoints, as shown in Table 35.

**Table 35:  
Superiority Testing of Select Secondary Endpoints (AT Population)**

No.	Endpoint	Summary Statistics*		Difference (TAVR – SAVR)	95% CI for the Difference	p-value (Superiority Test Result)
		TAVR (N=496)	SAVR (N=454)			
1	New onset atrial fibrillation at 30 days <sup>†</sup>	5.0% (21/417)	39.3% (145/369)	-34.3%	[-39.7%, -28.9%]	<.0001 (pass)
2	Length of index hospitalization (days)	2.9 ± 0.1 (496)	7.4 ± 0.2 (454)	-4.5	[-4.8, -4.1]	<.0001 (pass)
3	All-cause death, all stroke, or rehospitalization at 1 year	8.5% (42)	15.1% (68)	-6.6%	[-10.8%, -2.5%]	0.0016 (pass)
4	Death, KCCQ < 45 or KCCQ decrease from baseline ≥ 10 points at 30 days	3.9% (19/492)	30.6% (133/435)	-26.7%	[-31.4%, -22.1%]	<.0001 (pass)
5	Death or all stroke at 30 days	1.0% (5/496)	3.3% (15/454)	-2.3%	[-4.2%, -0.4%]	0.0214 (pass)
6	All stroke at 30 days	0.6% (3/496)	2.4% (11/454)	-1.8%	[-3.4%, -0.2%]	0.0284 (pass)

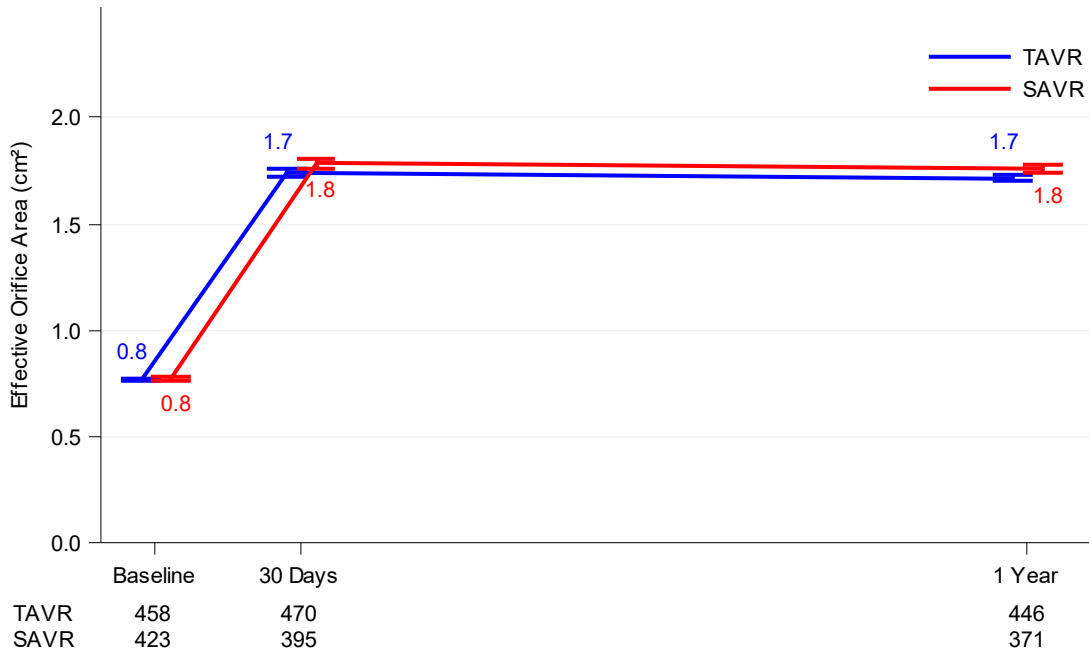
\*Continuous measures - Mean ± SE (Total no.); Categorical measures – observed rate, % (no./Total no.), except No. 3 - Kaplan-Meier rate, % (Total no.).

<sup>†</sup>Patients with pre-procedural atrial fibrillation were excluded from the analysis.

### Valve Performance

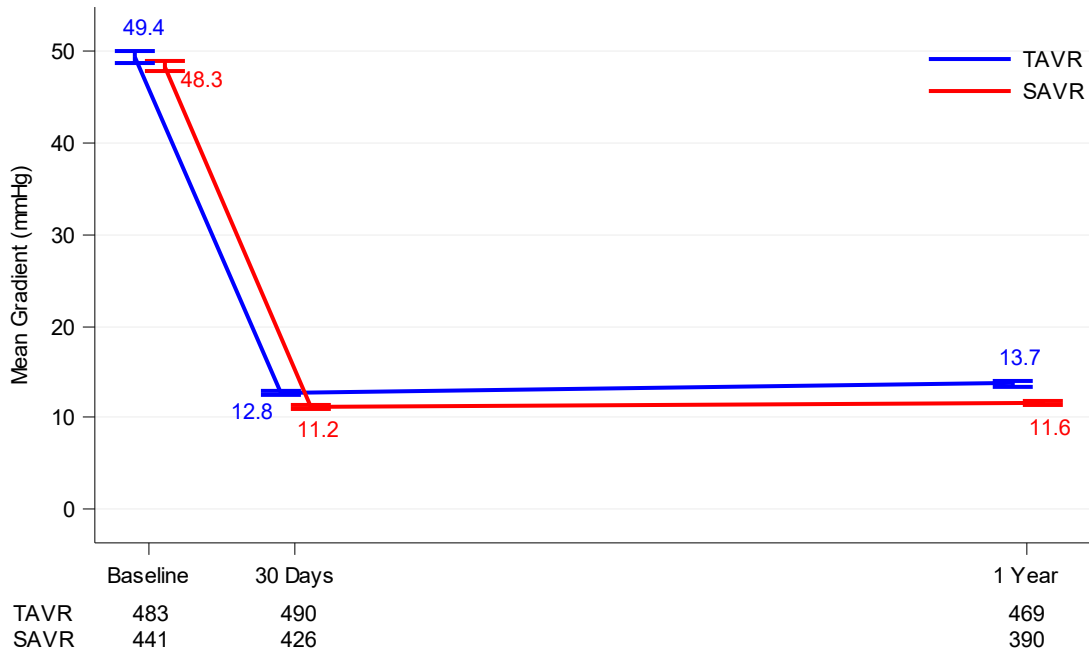
The effective orifice area (EOA), mean aortic gradient, total aortic regurgitation (AR), and paravalvular regurgitation values obtained over time for the TAVR and SAVR patients are shown in Figure 40 through Figure 43, respectively. The increase in EOA and decrease in gradient were sustained through 1 year in both cohorts. In the TAVR cohort, the proportion of patients with total AR ≥ moderate was 0.8% at 30 days and 1.1% at 1 year, while in the SAVR cohort, the corresponding proportion was 0.4% at 30 days and 0.6% at 1 year. The proportion of patients with paravalvular regurgitation ≥ moderate was 0.8% at 30 days and 0.6% at 1 year in the TAVR cohort, as compared to 0.0% at 30 days and 0.8% at 1 year in the SAVR cohort.

**Figure 40: Effective Orifice Area (VI Population)**



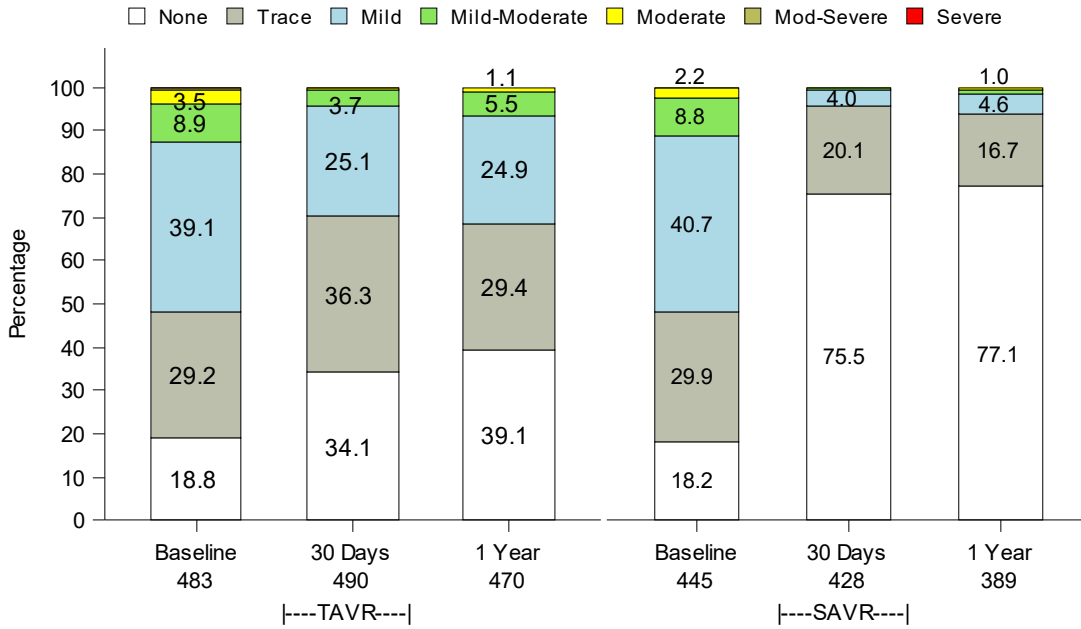
**Note:** Line plot with mean and standard error. The total number of patients at each visit time point only counted the patients with valid values.

**Figure 41: Mean Aortic Gradient (VI Population)**

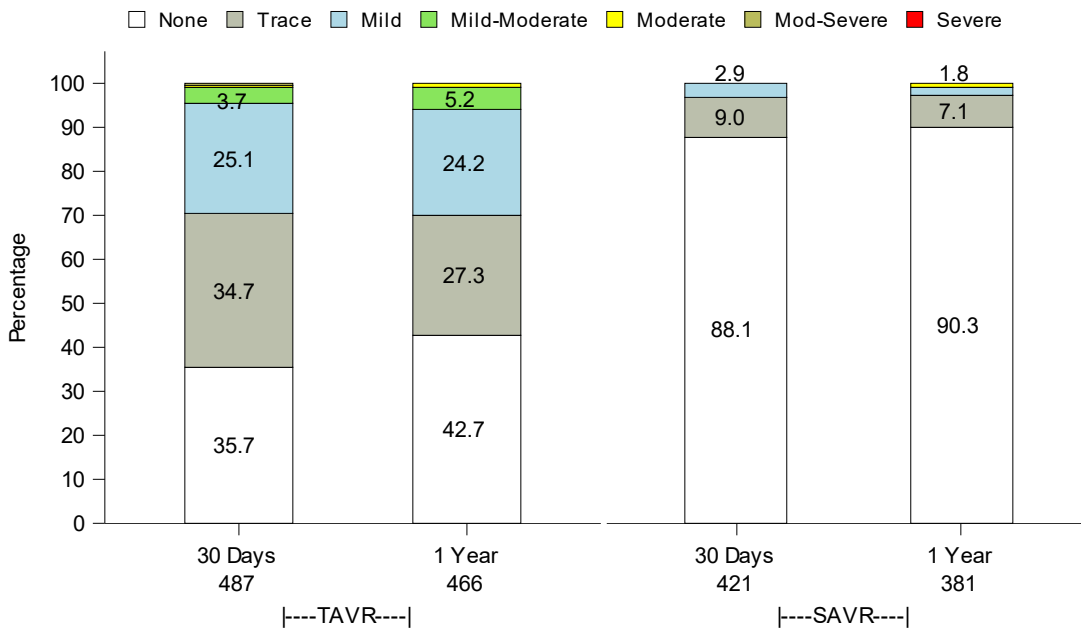


**Note:** Line plot with mean and standard error. The total number of patients at each visit time point only counted the patients with valid values.

**Figure 42: Total Aortic Regurgitation (VI Population)**



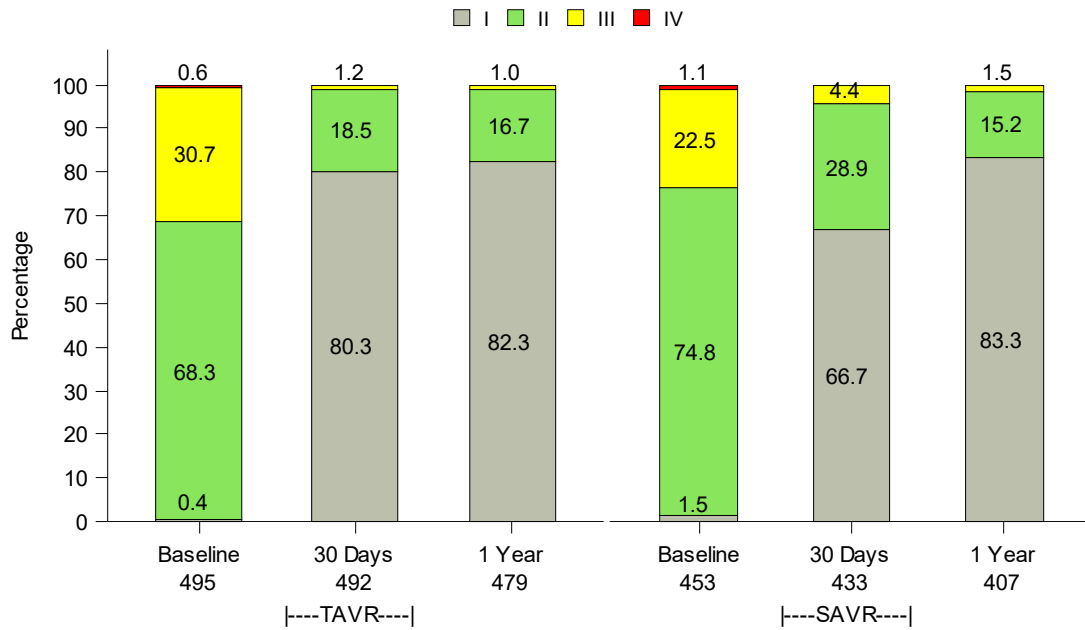
**Figure 43: Paravalvular Regurgitation (VI Population)**



**New York Heart Association (NYHA) Functional Class**

The NYHA classifications by visit are presented in Figure 44. At baseline, 31.3% of TAVR patients and 23.6% of SAVR patients were in NYHA III/IV. At 1 year the majority (~99%) of TAVR and SAVR patients were in NYHA Class I/II.

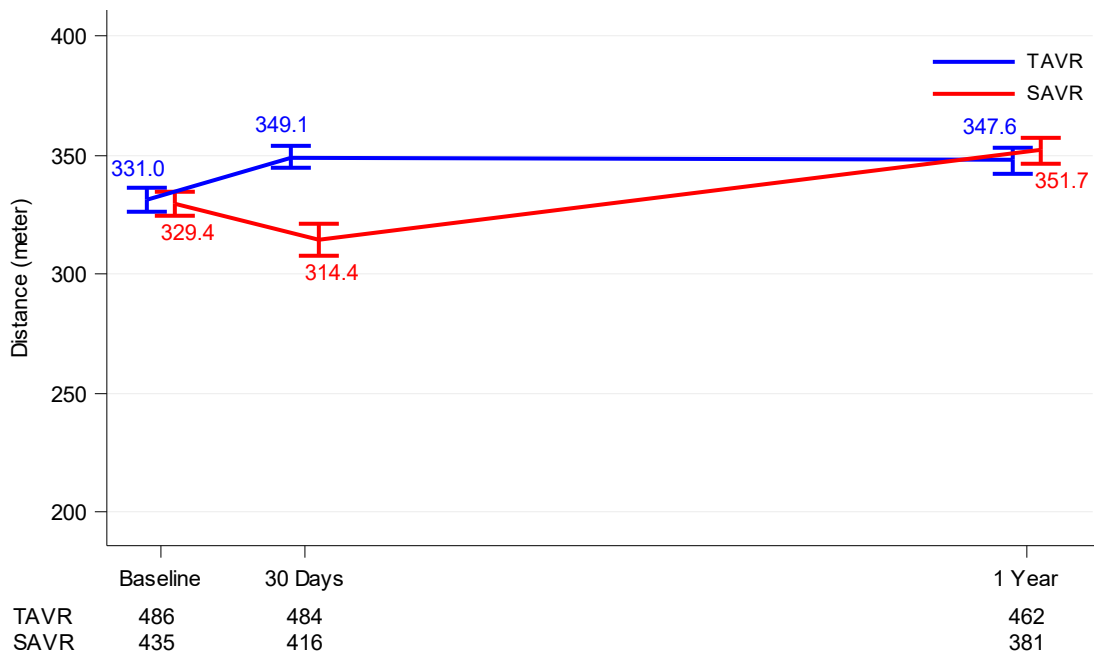
**Figure 44: NYHA Class by Visit (VI Population)**



**Six-Minute Walk Test (6MWT)**

The results for the 6MWT distance are presented in Figure 45. The TAVR patients showed an increase in mean 6MWT distance from 331.0 m at baseline to 349.1 m at 30 days, while SAVR patients showed a decrease from 329.4 m at baseline to 314.4 m at 30 days. The two cohorts had similar values at 1 year (347.6 m for TAVR and 351.7 m for SAVR).

**Figure 45: 6MWT Distance (VI Population)**



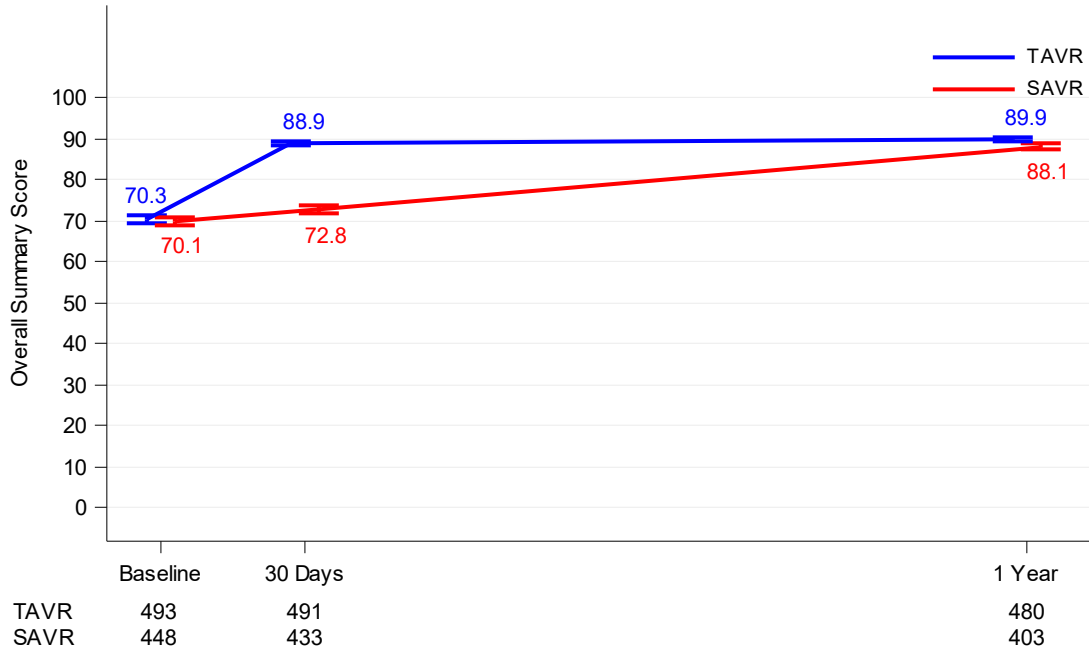
**Note:** Line plot with mean and standard error. The total number of patients at each visit time point only counted the patients with valid values.

**Quality of Life (QoL)**

KCCQ

The results for the KCCQ overall summary score are presented in Figure 46. The mean score increased from 70.3 at baseline to 88.9 at 30 days and 89.9 at 1 year in TAVR patients and from 70.1 at baseline to 72.8 at 30 days and 88.1 at 1 year in SAVR patients.

**Figure 46: KCCQ Overall Summary Score (VI Population)**

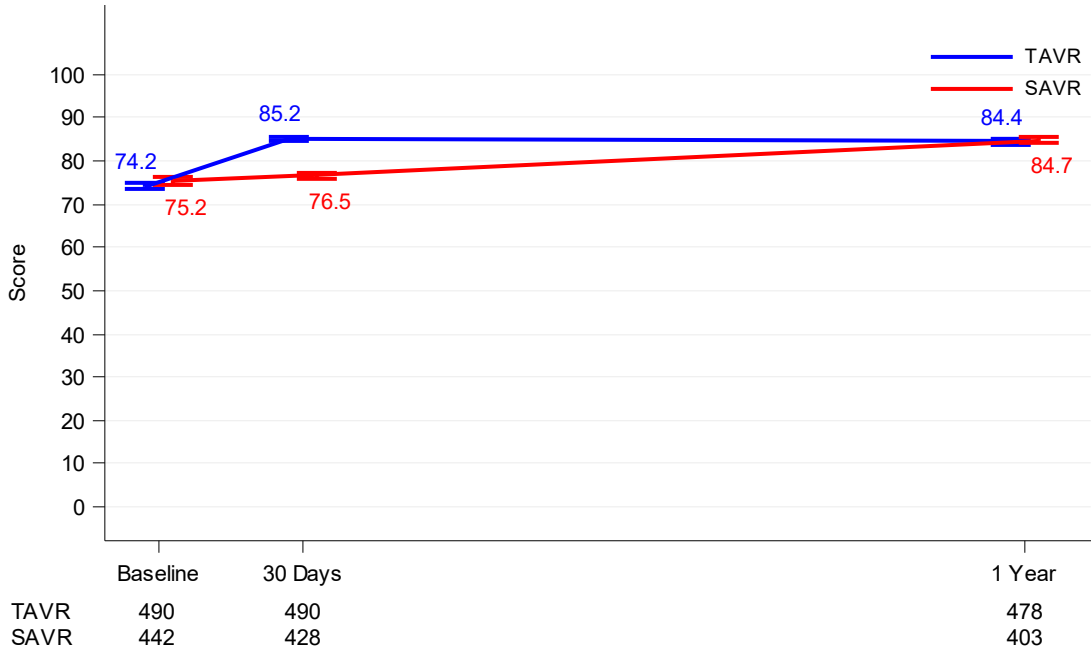


**Note:** Line plot with mean and standard error. The total number of patients at each visit time point only counted the patients with valid values.

## EuroQol (EQ-5D)

The results for the EQ-5D visual analog score (VAS) are presented in Figure 47. The mean score was 74.2 at baseline, 85.2 at 30 days, and 84.4 at 1 year in TAVR patients as compared to 75.2 at baseline, 76.5 at 30 days, and 84.7 at 1 year in SAVR patients.

**Figure 47: EQ-5D Visual Analog Score (VI Population)**



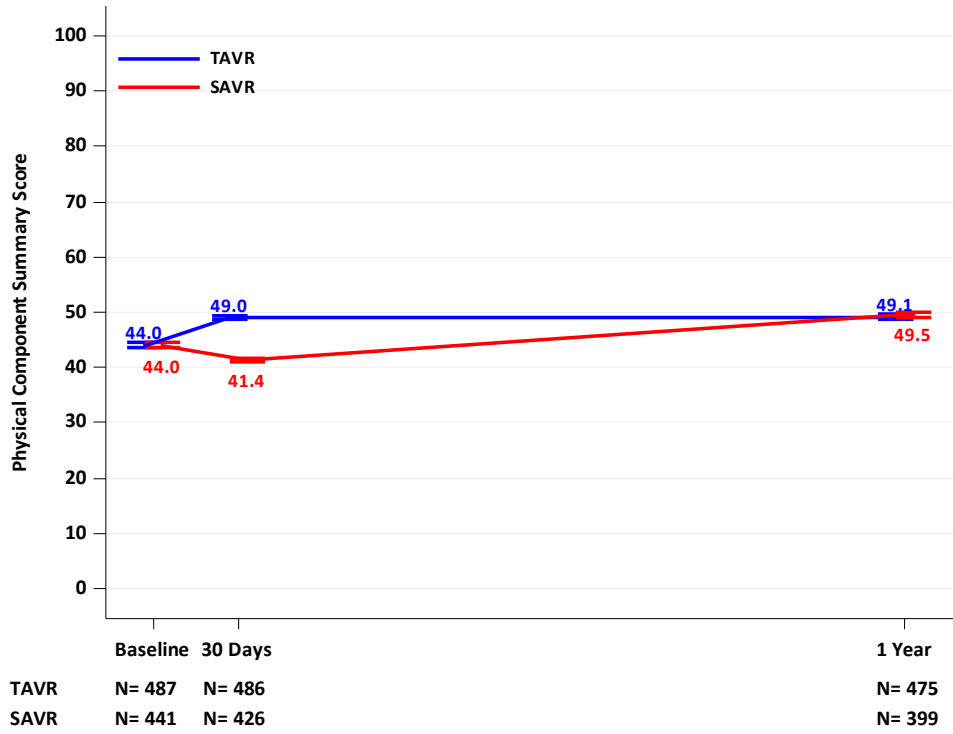
**Note:** Line plot with mean and standard error. The total number of patients at each visit time point only counted the patients with valid values.



### Short Form (SF)-36

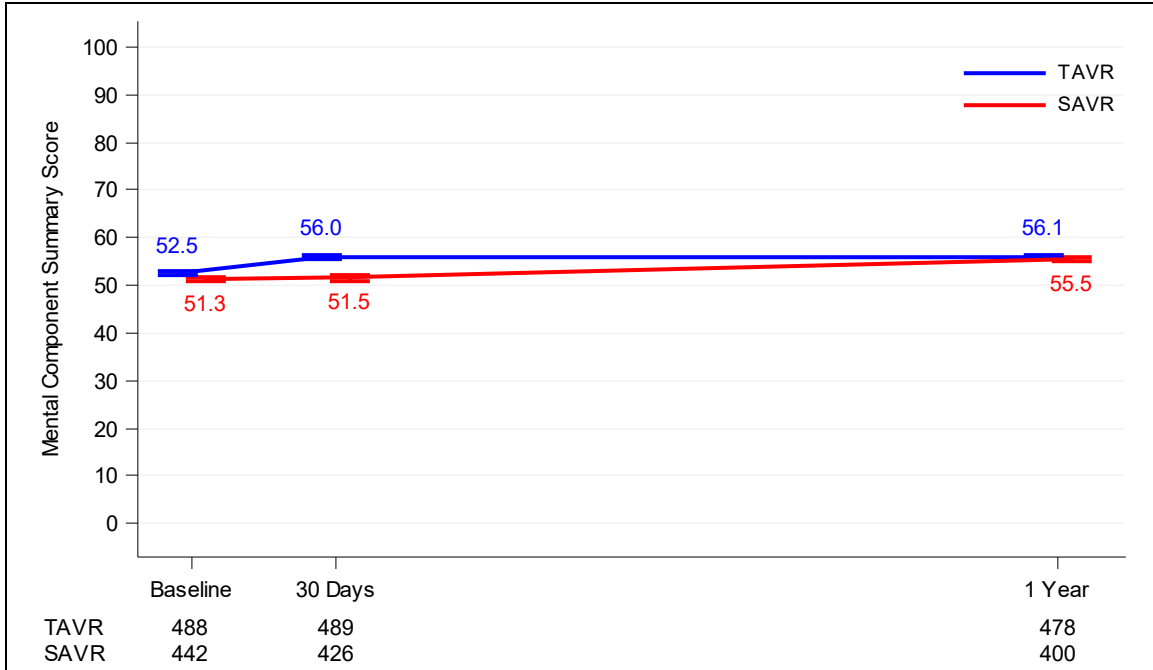
The results for the SF-36 physical component summary score and mental component summary score are presented in Figure 48 and Figure 49, respectively.

**Figure 48: SF-36 Physical Component Summary Score (VI Population)**



**Note:** Line plot with mean and standard error. The total number of patients at each visit time point only counted the patients with valid values.

**Figure 49: SF-36 Mental Component Summary  
(VI Population)**



**Note:** Line plot with mean and standard error. The total number of patients at each visit time point only counted the patients with valid values.

### 3. Adverse Events

The Kaplan-Meier estimates of the CEC-adjudicated adverse events through 1 year are presented in Table 36.

**Table 36: CEC-Adjudicated Adverse Events through 1 Year (AT Population)**

Event	Kaplan-Meier Rate*			
	30 Days		1 Year	
	TAVR (N=496)	SAVR (N=454)	TAVR (N=496)	SAVR (N=454)
All cause death	0.4% (2, 2)	1.1% (5, 5)	1.0% (5, 5)	2.5% (11, 11)
Cardiovascular death	0.4% (2, 2)	0.9% (4, 4)	0.8% (4, 4)	2.0% (9, 9)
All stroke	0.6% (3, 3)	2.4% (11, 11)	1.2% (6, 6)	3.1% (14, 14)
Disabling stroke	0.0% (0, 0)	0.4% (2, 2)	0.2% (1, 1)	0.9% (4, 4)
Non-disabling stroke	0.6% (3, 3)	2.0% (9, 9)	1.0% (5, 5)	2.2% (10, 10)
Death or stroke	1.0% (5, 5)	3.3% (16, 15)	1.8% (11, 9)	4.9% (25, 22)
Death or disabling stroke	0.4% (2, 2)	1.3% (7, 6)	1.0% (6, 5)	2.9% (15, 13)
Major vascular complications	2.2% (12, 11)	1.5% (8, 7)	2.8% (15, 14)	1.5% (8, 7)
Life-threatening / disabling, or major bleeding	3.6% (22, 18)	24.5% (123, 111)	7.7% (45, 38)	25.9% (132, 117)
Life-threatening / disabling bleeding	1.2% (9, 6)	11.9% (58, 54)	2.8% (17, 14)	12.8% (63, 58)
Major bleeding	2.6% (13, 13)	13.5% (65, 61)	5.3% (28, 26)	14.2% (69, 64)
Myocardial infarction	1.0% (5, 5)	1.3% (6, 6)	1.2% (6, 6)	2.2% (10, 10)
Requirement for renal replacement†	0.2% (1, 1)	0.7% (3, 3)	0.2% (1, 1)	0.7% (3, 3)
New permanent pacemaker implantation resulting from new or worsened conduction disturbances‡	6.5% (32, 32)	4.0% (18, 18)	7.3% (36, 36)	5.4% (24, 24)
Coronary obstruction requiring intervention	0.2% (1, 1)	0.7% (3, 3)	0.2% (1, 1)	0.7% (3, 3)
New onset atrial fibrillation	5.0% (21, 21)	39.5% (145, 145)	7.0% (29, 29)	40.9% (150, 150)
Rehospitalization <sup>  </sup>	3.4% (18, 17)	6.5% (30, 29)	7.3% (39, 36)	11.0% (59, 49)

\*Kaplan-Meier rate (no. of events, no. of patients with the event).

†Requirement for renal replacement was based on the site-reported event. All the other events were based on the CEC-adjudicated results.

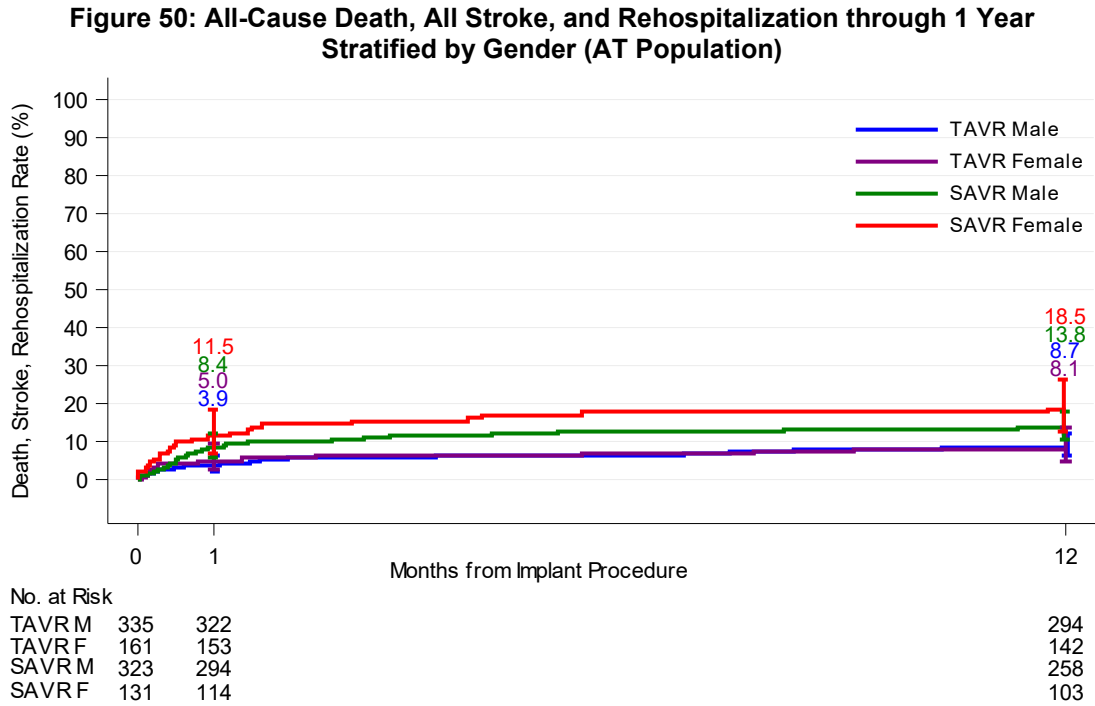
‡Patients with pacemaker or ICD at baseline were not counted as new events.

<sup>||</sup>Rehospitalization (valve-related or procedure-related and including heart failure).

#### 4. Subgroup Analysis

##### Gender Analysis

The protocol specified a subgroup analysis on gender. The primary endpoint result stratified by gender is presented in Figure 50.



**Note:** The confidence intervals were calculated without multiplicity adjustment. The adjusted confidence intervals could be wider than presented here. As such, confidence intervals are provided to illustrate the variability only and should not be used to draw any statistical conclusion.

## 5. Other Study Observations

### Procedural Information

The general procedural data are summarized in Table 37. Conscious sedation was used in the majority of TAVR patients (65.1%). The mean procedure time was significantly lower for TAVR compared to SAVR (58.6 minutes vs. 208.3 minutes). There were less concomitant (planned) procedures performed for TAVR patients compared to SAVR patients (6.9% vs. 26.4%). Additional TAVR and SAVR specific procedural data are presented in Table 38 and 39, respectively.

**Table 37:  
General Procedural Data  
(AT Population)**

Variable	Summary Statistics*	
	TAVR (N=496)	SAVR (N=454)
Subject treated according to their treatment assignment	99.8% (495/496)	99.8% (453/454)
Procedure aborted	0	1
Subject was assigned to TAVR but received SAVR	1	0
Procedure time (min)	58.6 ± 1.6 (496)	208.3 ± 2.9 (454)
Anesthesia type		
General	33.3% (165/496)	100.0% (454/454)
Conscious sedation	65.1% (323/496)	NA
Conversion from conscious sedation to general anesthesia during the procedure	1.6% (8/496)	NA
Anesthesia time (min)	138.7 ± 2.20 (496)	309.7 ± 3.7 (454)
Concomitant procedures	6.9% (34/496)	26.4% (120/454)
Annular area (mm <sup>2</sup> )	473.5 ± 83.3 (486)	479.6 ± 87.6 (441)

\*Continuous measures – mean ± SE (n) for procedure and anesthesia time, mean ± SD (n) for annular area; Categorical measures - % (no./Total no.)

**Table 38:  
TAVR Procedure Data  
(AT Population)**

Variable	Summary Statistics*
	TAVR (N=496)
Valve size	
20 mm	2.2% (11/496)
23 mm	29.2% (145/496)
26 mm	47.6% (236/496)
29 mm	21.0% (104/496)
Successful access, delivery and retrieval of the device delivery system	99.8% (494/495)
Arterial access method	
Left percutaneous	22.2% (109/490)
Right percutaneous	76.7% (376/490)
Left surgical cutdown	0.0% (0/490)
Right surgical cutdown	1.0% (5/490)
Total fluoroscopy time (min)	13.9 ± 0.3 (487)
BAV performed	57.8% (286/495)
Post dilatation performed	20.9% (103/494)
Number of post dilatations	
1	89.3% (92/103)
2	8.7% (9/103)
3	1.9% (2/103)
More than one SAPIEN 3 THV implanted	0.2% (1/495)

\*Continuous measures - mean ± SE (n); categorical measures - % (no./Total no.). For patients in whom the procedure was aborted or who were converted to surgery, the rest of the procedure data except valve size were not collected.

**Table 39:  
SAVR Procedure Data  
(AT Population)**

Variable	Summary Statistics*
	SAVR (N=454)
Procedure aborted†	0.2% (1/454)
Valve size	
19 mm	2.9% (13/453)
21 mm	17.2% (78/453)
23 mm	36.6% (166/453)
25 mm	35.5% (161/453)
27 mm	6.8% (31/453)
29 mm	0.9% (4/453)
Total aortic cross clamp time (min)	74.3 ± 1.3 (453)
Total pump time (min)	97.7 ± 1.6 (453)
SAVR approach	
Sternotomy	95.4% (432/453)
Thoracotomy	0.9% (4/453)
Mini right upper thoracotomy	2.9% (13/453)
Port access	0.2% (1/453)
Other	0.7% (3/453)
Successful implantation of the surgical valve	100.0% (453/453)

\*Continuous measures - mean ± SE (n); categorical measures - % (no./Total no.).

†For patients in whom the procedure was aborted, the rest of the procedure data were not collected.

### **Computed Tomography (CT) Sub-Study**

There were 184 TAVR and 162 SAVR patients at 30 days and 160 and 134 patients at 1 year, respectively, who had at least one adequate CT for leaflet assessments. The HALT and leaflet mobility imaging findings are summarized in Table 40, along with the associated mean aortic pressure gradients. The mean aortic pressure gradients at 1 year stratified by HALT and leaflet mobility at 30 days are summarized in Table 41 and Table 42, respectively. The rate of death, stroke or TIA at 1 year stratified by HALT and leaflet mobility at 30 days are summarized in Table 43 and Table 44, respectively. The CT substudy was not powered to compare the relative incidence or the severity of HALT or reduced leaflet mobility between the TAVR and SAVR cohorts, or to determine whether late clinical outcomes were affected by the presence of HALT or reduced leaflet mobility.

**Table 40: HALT and Leaflet Mobility Findings and Associated Mean Gradients**

Findings	Summary Statistics*			
	30 Days		1 Year	
	TAVR (N=184)	SAVR (N=162)	TAVR (N=160)	SAVR (N=134)
Proportion of patients on oral anticoagulants at time of scan	6.0% (11/184)	21.0% (34/162)	8.1% (13/160)	13.4% (18/134)
<b>HALT<sup>†</sup></b>				
No thickening	84.8% (156/184)	95.7% (155/162)	74.4% (119/160)	82.1% (110/134)
Mean gradient (mmHg)	12.5 ± 0.3 (156)	10.8 ± 0.3 (155)	13.7 ± 0.4 (115)	11.7 ± 0.4 (106)
<25% leaflet length thickened	4.9% (9/184)	1.2% (2/162)	11.3% (18/160)	7.5% (10/134)
Mean gradient (mmHg)	11.4 ± 0.9 (9)	16.5 ± NA (1)	12.9 ± 0.7 (18)	9.3 ± 1.8 (8)
25%-50% leaflet length thickened	3.3% (6/184)	1.9% (3/162)	6.3% (10/160)	5.2% (7/134)
Mean gradient (mmHg)	13.7 ± 1.7 (6)	9.4 ± 1.4 (3)	13.2 ± 1.8 (10)	15.1 ± 2.4 (7)
50%-75% leaflet length thickened	6.5% (12/184)	0.6% (1/162)	5.0% (8/160)	3.7% (5/134)
Mean gradient (mmHg)	15.2 ± 1.9 (12)	9.8 ± NA (1)	16.9 ± 3.3 (8)	16.1 ± 4.0 (5)
>75% leaflet length thickened	0.5% (1/184)	0.6% (1/162)	3.1% (5/160)	1.5% (2/134)
Mean gradient (mmHg)	10.2 ± NA (1)	16.8 ± NA (1)	20.2 ± 6.2 (5)	9.0 ± 4.2 (2)
Number of leaflets with HALT	6.7% (37/552)	2.3% (11/486)	12.7% (61/480)	8.2% (33/402)
0 leaflets thickening	156	155	119	110
1 leaflet thickening	21	4	26	15
2 leaflets thickening	5	2	10	9
3 leaflets thickening	2	1	5	0
<b>Leaflet mobility<sup>‡</sup></b>				
Unrestricted	85.3% (145/170)	96.8% (149/154)	77.6% (118/152)	83.0% (108/129)
Mean gradient (mmHg)	12.2 ± 0.3 (145)	10.7 ± 0.3 (148)	13.3 ± 0.4 (114)	12.0 ± 0.5 (105)
Partially restricted, restriction limited to base	5.3% (9/170)	1.3% (2/154)	11.8% (18/152)	8.5% (11/129)
Mean gradient (mmHg)	11.4 ± 0.9 (9)	14.6 ± 1.9 (2)	12.5 ± 0.6 (18)	9.9 ± 1.6 (9)
Partially restricted (<50%)	5.3% (9/170)	1.3% (2/154)	3.9% (6/152)	3.1% (4/129)
Mean gradient (mmHg)	15.5 ± 2.4 (9)	10.3 ± 0.5 (2)	14.0 ± 2.8 (6)	15.6 ± 3.0 (4)
Partially restricted (50%-75%)	3.5% (6/170)	0.0% (0/154)	4.6% (7/152)	3.9% (5/129)
Mean gradient (mmHg)	12.8 ± 1.7 (6)	NA	21.8 ± 3.9 (7)	11.3 ± 3.6 (5)
Largely immobile	0.6% (1/170)	0.6% (1/154)	2.0% (3/152)	0.8% (1/129)
Mean gradient (mmHg)	13.3 ± NA (1)	16.8 ± NA (1)	19.5 ± 8.1 (3)	13.1 ± NA (1)
<b>Number of leaflets partially restricted or largely immobile</b>				
0 leaflet	145	149	118	108
1 leaflet	21	2	22	13
2 leaflets	4	2	8	8
3 leaflets	0	1	4	0



Findings	Summary Statistics*			
	30 Days		1 Year	
	TAVR (N=184)	SAVR (N=162)	TAVR (N=160)	SAVR (N=134)

\*Continuous measures - mean  $\pm$  SE (n); categorical measures - % (no./Total no.). The analysis population included all the patients enrolled in the CT substudy and had at least one adequate CT for leaflet assessments.

†HALT was defined as: the presence of any hypopatterned leaflet thickening in any singular leaflet as identified by an independent CT core laboratory. The extent of the hypoattenuated leaflet thickening was graded with regards to the entire leaflet as: None, <25%, 25-50%, 50-75%, or >75%. If more than one leaflet had the appearance of HALT, the thickening measure of the most impacted leaflet was used. Presence of any degree of HALT on any one leaflet rendered a finding.

‡Leaflet mobility was determined by an independent CT core laboratory and included: unrestricted, partially restricted mobility limited to the base of a leaflet, partially restricted mobility involving more than the base of the leaflet but less than 50% of the leaflet, partially restricted mobility involving more than 50% of the leaflet but less than 75% of the leaflet, and/or a largely immobile leaflet. Presence of any degree of restriction or immobility on any one leaflet rendered a finding.

**Table 41: Mean Aortic Gradient at 1 Year Stratified by HALT at 30 Days**

	Summary Statistics*			
	HALT at 30 Days		No HALT at 30 Days	
	TAVR (N=28)	SAVR (N=7)	TAVR (N=156)	SAVR (N=155)
Mean gradient	13.6 $\pm$ 1.2 (24)	13.7 $\pm$ 2.7 (5)	13.6 $\pm$ 0.4 (137)	11.8 $\pm$ 0.4 (125)

\*Mean  $\pm$  SE (n). The analysis population included all the patients enrolled in the CT substudy and had an adequate CT for leaflet assessments at 30 days.

**Table 42: Mean Aortic Gradient at 1 Year Stratified by Leaflet Mobility at 30 Days**

	Summary Statistics*			
	Reduced Leaflet Mobility at 30 Days		Unrestricted at 30 Days	
	TAVR (N=25)	SAVR (N=5)	TAVR (N=145)	SAVR (N=149)
Mean gradient	13.7 $\pm$ 1.28 (23)	14.2 $\pm$ 3.48 (4)	13.3 $\pm$ 0.4 (124)	11.7 $\pm$ 0.4 (119)

\*Mean  $\pm$  SE (n). The analysis population included all the patients enrolled in the CT substudy and had an adequate CT for leaflet assessments at 30 days.

**Table 43: All-Cause Mortality, All Stroke or TIA at 1 Year Stratified by HALT at 30 Days**

1-Year Endpoint	Kaplan-Meier Rate*			
	HALT at 30 Days		No HALT at 30 Days	
	TAVR (N=28)	SAVR (N=7)	TAVR (N=156)	SAVR (N=155)
All-cause mortality	0.0% (0)	0.0% (0)	1.3% (2)	1.4% (2)
All stroke	0.0% (0)	0.0% (0)	0.7% (1)	0.0% (0)
TIA	5.6% (1)	0.0% (0)	1.3% (2)	0.0% (0)
All-cause mortality or all stroke or TIA	5.6% (1)	0.0% (0)	3.3% (5)	1.4% (2)

\*Kaplan-Meier rate (no. of patients with event). The analysis population included all the patients enrolled in the CT substudy and had an adequate CT for leaflet assessments at 30 days. The Kaplan-Meier analysis used the CT test date as the start date in determining time to event. Presence of any degree of HALT on any one leaflet rendered a finding and inclusion in the HALT cohort.

**Table 44: All-Cause Mortality, All Stroke or TIA at 1 Year Stratified by Leaflet Mobility at 30 Days**

1-Year Endpoint	Kaplan-Meier Rate*			
	Reduced Leaflet Mobility at 30 Days		Unrestricted at 30 Days	
	TAVR (N=25)	SAVR (N=5)	TAVR (N=145)	SAVR (N=149)
All-cause mortality	0.0% (0)	0.0% (0)	0.0% (0)	0.0% (0)
All stroke	0.0% (0)	0.0% (0)	0.0% (0)	0.0% (0)
TIA	6.3% (1)	0.0% (0)	6.3% (1)	0.0% (0)
All-cause mortality or all stroke or TIA	6.3% (1)	0.0% (0)	3.6% (5)	1.4% (2)

\*Kaplan-Meier rate (no. of patients with event). The analysis population included all the patients enrolled in the CT substudy and had an adequate CT for leaflet assessments at 30 days. The Kaplan-Meier analysis used the CT test date as the start date in determining time to event. Reduced leaflet mobility included any of the following assessments: partially restricted limited to base, partially restricted involving more than the base but less than 50% of the leaflet, partially restricted involving more than 50% but less than 75% of the leaflet, and/or largely immobile. Presence of any degree of restriction or immobility on any one leaflet rendered a finding and inclusion in the reduced leaflet mobility cohort.

**SAPIEN 3 THV IN BICUSPID AORTIC VALVE FOR PATIENTS AT INTERMEDIATE OR GREATER SURGICAL RISK-STS/ACC TRANSCATHETER VALVE THERAPY REGISTRY (TVTR) ANALYSIS**

**Patient Accountability**

At the time of database extract, of the 545 patients in the bicuspid aortic valve cohort, 527 patients were eligible for the 30-day visit, and 486 (92.2%) patients paid a visit within the 30-day follow-up window defined as the period between 21 and 75 days post-procedure. Of the 465 patients eligible for the 1 year visit, 309 (66.5%) paid a visit within the 1 year follow-up window defined as the period between 305 and 425 days post-procedure. A detailed summary of the patient accountability at 30 days and 1 year is shown in Table 45.

**Table 45:  
Patient Visit Accountability**

	<b>30-day Visit</b>	<b>1-year Visit</b>
Total patients	545	545
Non-eligible*	18	80
-Death	14	43
-Withdrawal	2	8
-Lost to follow-up	2	29
-Visit not yet due‡	0	0
Eligible	527	465
-Follow-up visit completed	486 (92.2%)	309 (66.5%)
-Missed visit†	41 (7.8%)	156 (33.5%)

\* This includes all patients who exited the study prior to the end of the follow-up visit window and those who have not had the visit.

‡ Patients have not reached the end of the visit window and have not completed the follow-up visit yet.

† Data extract date has exceeded the end of the visit window and the patients have not reported the visit data.

The “Attempted Implant” population consisted of all patients entered into the registry with a bicuspid aortic valve. The “Valve Implant” population consisted of those patients for whom the valve implant procedure has started and a “No” was indicated for both “procedure aborted” and “conversion to open heart surgery.” The “Valve Implant” population consists of 540 patients as 5 patients were converted to open heart surgery and did not receive the SAPIEN 3 transcatheter heart valve.

#### **Patient Demographics and Baseline Characteristics**

The demographics and baseline characteristics of bicuspid aortic valve patients, as shown in Table 46, present a multimorbid cohort of patients with a mean STS score of  $5.5 \pm 4.0$ .

**Table 46:  
Patient Demographics and Baseline Characteristics - Bicuspid Population  
(Attempted Implant Population)**

<b>Demographics and Baseline Characteristics</b>	<b>Summary Statistics*</b>
Age - years	73.4 ± 11.1 (545)
Male sex	349 / 545
Society of Thoracic Surgeons (STS) score	5.5 ± 4.0 (538)
New York Heart Association (NYHA) class	
I/II	106 / 535 (19.8%)
III/IV	429 / 535 (80.2%)
Previous myocardial infarction	119 / 544 (21.9%)
Previous intervention	
Coronary artery bypass grafting (CABG)	101 / 543 (18.6%)
Percutaneous coronary intervention (PCI)	138 / 545 (25.3%)
Prior aortic valvuloplasty	34 / 545 (6.2%)
Cerebrovascular accident (CVA)	56 / 545 (10.3%)
Peripheral vascular disease	128 / 544 (23.5%)
Atrial fibrillation	183 / 545 (33.6%)
Permanent pacemaker	54 / 545 (9.9%)
Porcelain aorta	12 / 545 (2.2%)
Hostile chest	44 / 545 (8.1%)
Echocardiographic findings (Valve Implant Population)	

Demographics and Baseline Characteristics	Summary Statistics*
Valve area - cm <sup>2</sup>	0.7 ± 0.2 (524)
Mean aortic valve gradient - mmHg	44.9 ± 15.5 (535)
Mean left ventricular ejection fraction (LVEF) %	52.9 ± 15.5 (534)
Moderate or severe aortic regurgitation	91 / 536 (17.0%)
Moderate or severe mitral regurgitation	101 / 438 (23.1%)

\*Continuous measures - Mean ± SD (Total no.); categorical measures - n. / Total no. (%).

## Safety and Effectiveness Results

### Safety Endpoints

The mortality rates at discharge, 30 days, one-year and the Kaplan-Meier curve for all-cause mortality are shown in Table 47 and Figure 51, respectively. There were a total of 12 deaths reported at 30 days and 43 deaths reported at one year.

**Table 47:**  
**Death Rate - Bicuspid Population (Attempted Implant Population)**

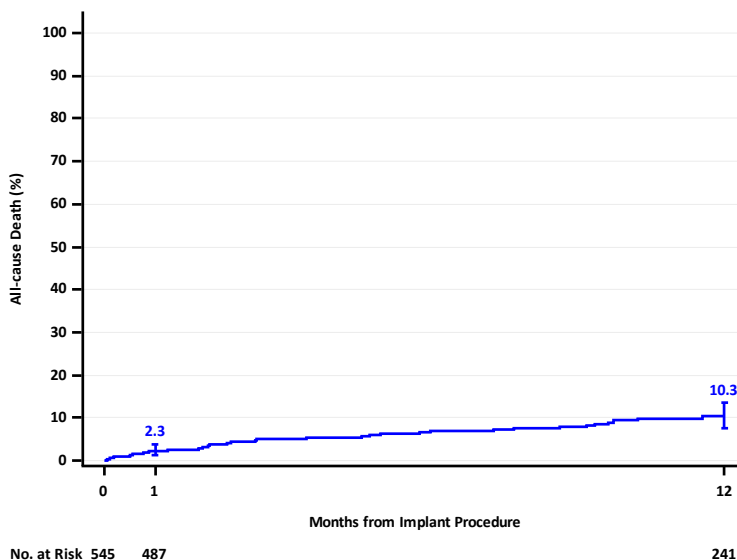
	Discharge*	30 Days†	1 Year‡
All-cause death‡	1.8% (10)	2.3% (12)	10.3% (43)
Cardiac death	1.1% (6)	1.3% (7)	3.0% (13)

\*Observed rate - % (n).

† Kaplan-Meier estimate - % (n)

‡ Includes all deaths reported in TVTR and identified through CMS linkage.

**Figure 51:**  
**All-Cause Death Rate - Bicuspid Population**  
**(Attempted Implant Population)**



The DCRI adjudicated events, including all strokes, TIAs and aortic valve reinterventions at discharge, 30 days and one year are shown in Table 48.

**Table 48:**  
**Duke Clinical Research Institute Adjudicated Events - Bicuspid Population**  
**(Attempted Implant Population)**

Events	Discharge*	30 Days†	1 Year†
All strokes	1.5% (8, 8)	1.9% (10, 10)	2.7% (13, 13)
Ischemic stroke	1.5% (8, 8)	1.9% (10, 10)	2.7% (13, 13)
Hemorrhagic stroke	0.0% (0, 0)	0.0% (0, 0)	0.0% (0, 0)
Transient ischemic attack (TIA)	0.2% (1, 1)	0.2% (1, 1)	0.2% (1, 1)
Aortic valve reintervention	0.2% (1, 1)	0.2% (1, 1)	0.8% (3, 3)

\*Observed rate - % (no. of events, no. of subjects with the event)

†Kaplan-Meier estimate - % (no. of events, no. of subjects with the event)

Note: At the time of this extract, there is one stroke and one aortic valve reintervention that are pending adjudication.

### Site Reported Adverse Events

The site reported adverse events at discharge, 30 days and one year for the bicuspid population are shown in Table 49.

**Table 49:**  
**Site Reported Adverse Events - Bicuspid Population**  
**(Attempted Implant Population)**

Events	Discharge*	30 Days†	1 Year†
Non-valve related readmission	N/A‡	8.7% (50, 45)	26.8% (164, 110)
Conduction/native pacer disturbance req pacer	7.3% (40, 40)	8.6% (46, 46)	9.7% (50, 50)
Minor vascular complication	4.6% (25, 25)	5.0% (28, 27)	5.0% (28, 27)
Unplanned vascular surgery or intervention	3.5% (19, 19)	3.5% (19, 19)	3.8% (20, 20)
Cardiac arrest	2.9% (16, 16)	3.0% (16, 16)	3.0% (16, 16)
Atrial fibrillation	2.4% (13, 13)	2.4% (13, 13)	2.4% (13, 13)
Hematoma at access site	2.2% (12, 12)	2.2% (12, 12)	2.2% (12, 12)
Ischemic Stroke	1.5% (8, 8)	2.0% (11, 11)	2.6% (13, 13)
Other bleed	2.0% (12, 11)	2.0% (12, 11)	2.0% (12, 11)
Unplanned other cardiac surgery or intervention	1.3% (7, 7)	1.9% (10, 10)	3.3% (16, 15)
Bleeding at access site	1.8% (10, 10)	1.8% (10, 10)	1.8% (10, 10)
Major vascular complication	1.1% (6, 6)	1.1% (6, 6)	1.1% (6, 6)
Perforation with or w/o tamponade	1.1% (6, 6)	1.1% (6, 6)	1.1% (6, 6)
Myocardial infarction	0.7% (4, 4)	0.9% (5, 5)	1.5% (7, 7)
Percutaneous coronary intervention (PCI)	0.7% (5, 4)	0.9% (6, 5)	1.2% (7, 6)
Valve Related Readmission	N/A‡	0.8% (5, 4)	2.1% (12, 9)
Coronary Compression or Obstruction	0.7% (4, 4)	0.7% (4, 4)	0.7% (4, 4)
New requirement for dialysis	0.4% (2, 2)	0.6% (3, 3)	0.9% (4, 4)
Major Bleeding Event	N/A‡	0.4% (2, 2)	1.3% (6, 5)
Conduction/native pacer disturbance requiring implantable cardioverter defibrillator (ICD)	0.2% (1, 1)	0.4% (2, 2)	1.6% (6, 6)
Genitourinary (GU) Bleed	0.4% (2, 2)	0.4% (2, 2)	0.4% (2, 2)
Annular Dissection	0.4% (2, 2)	0.4% (2, 2)	0.4% (2, 2)

Events	Discharge*	30 Days†	1 Year†
Aortic Valve Reintervention	0.2% (1, 1)	0.2% (1, 1)	1.0% (4, 4)
Transient Ischemic Attack	0.2% (1, 1)	0.2% (1, 1)	0.2% (1, 1)
Aortic Dissection	0.2% (1, 1)	0.2% (1, 1)	0.2% (1, 1)
Device recapture or retrieval	0.2% (1, 1)	0.2% (1, 1)	0.2% (1, 1)
Retroperitoneal bleeding	0.2% (1, 1)	0.2% (1, 1)	0.2% (1, 1)
Endocarditis	0.0% (0, 0)	0.0% (0, 0)	0.6% (2, 2)
Device Thrombosis	0.0% (0, 0)	0.0% (0, 0)	0.2% (1, 1)
Undetermined Stroke	0.0% (0, 0)	0.0% (0, 0)	0.3% (1, 1)

\*Observed rate - % (no. of events, no. of subjects with the event)

† Kaplan-Meier estimate - % (no. of events, no. of subjects with the event)

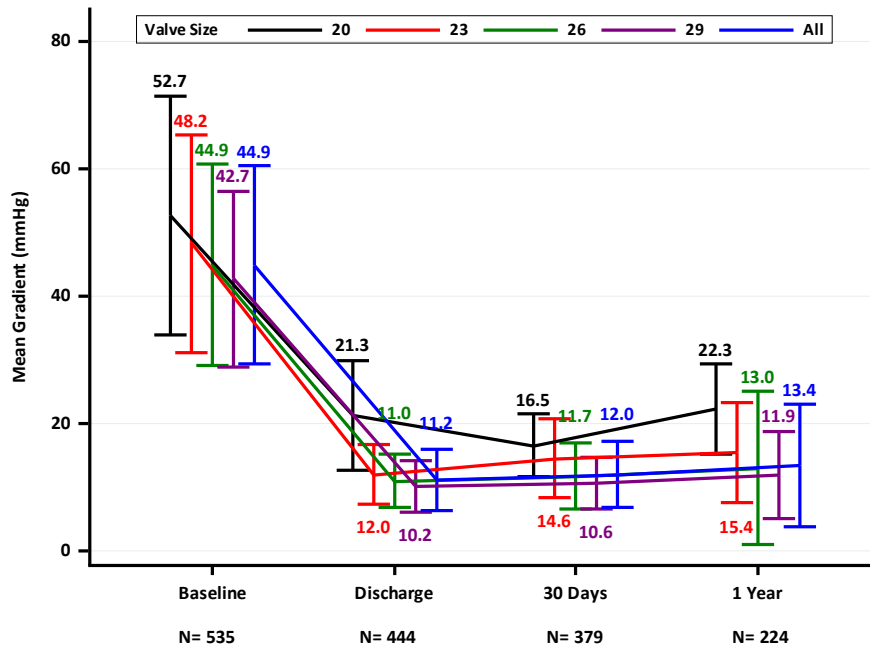
‡ N/A = Event not collected on case report form at the time period. % (no. of events, no. of subjects with the event)

## Effectiveness Endpoints

### Valve Performance

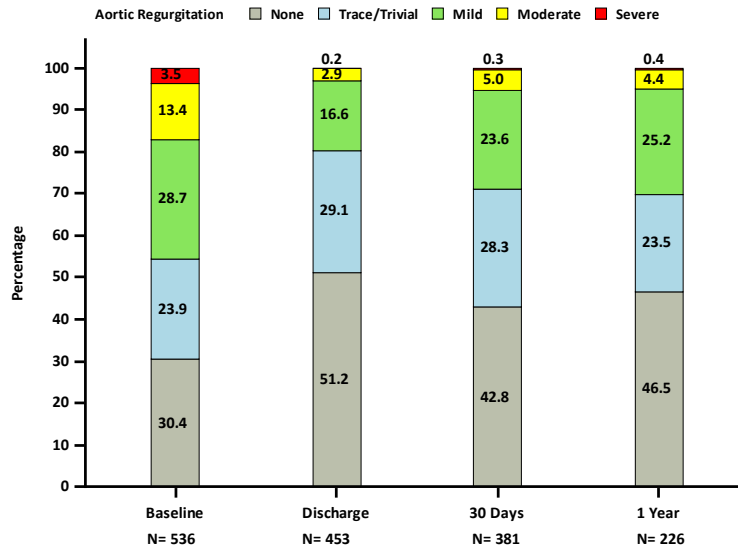
The bicuspid aortic valve echocardiographic performance data are summarized in Figures 52-54. The mean gradients  $44.9 \pm 15.5$  mmHg at baseline to  $12.0 \pm 5.2$  mmHg at 30 days and  $13.4 \pm 9.6$  mmHg at one year. Moderate/severe PVL was observed in 4.8% of the patients at 30 days and 5.1% of the patients at one year.

**Figure 52:**  
**Aortic Mean Gradient - Bicuspid Population**  
**(Valve Implant Population)**



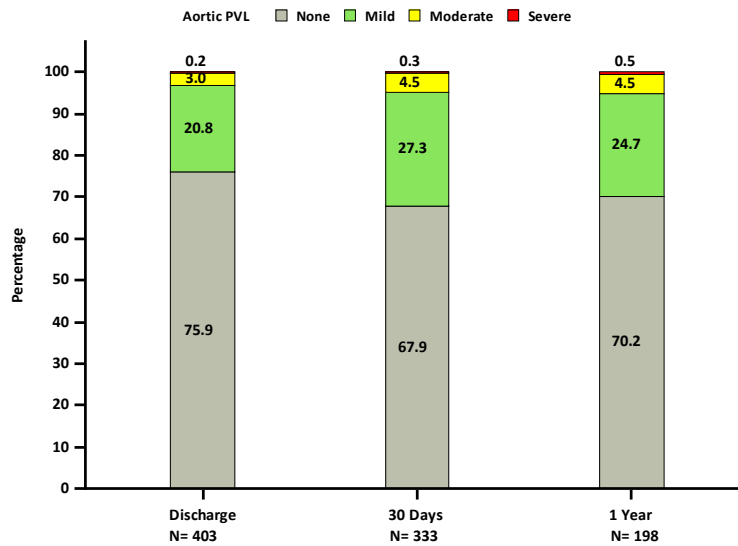
Note: Line plot with mean and standard deviation. The total number of patients at each time point only counted the patients with valid values.

**Figure 53:  
Aortic Regurgitation - Bicuspid Population  
(Valve Implant Population)**



Note: The total number of patients at each time point only counted the patients with valid values.

**Figure 54:  
Aortic Paravalvular Leak - Bicuspid Population  
(Valve Implant Population)**

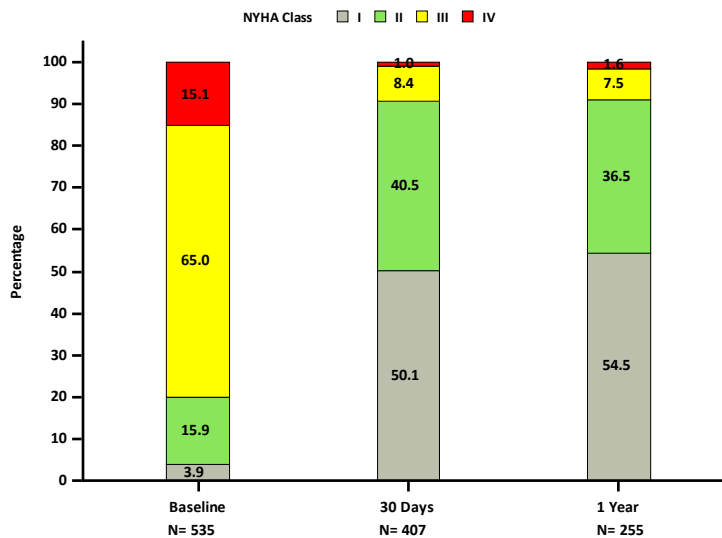


Note: The total number of patients at each time point only counted the patients with valid values.

## NYHA Class

The NYHA class distributions at baseline, 30-day visit and one-year visit and the NYHA class changes from baseline to the 30-day visit and to one-year visit are shown in Figure 55 and Table 50, respectively. The majority (84.0% and 82.5%) of the patients had an improved NYHA class at the 30-day visit and one year visit, respectively.

**Figure 55:**  
**NHYA Functional Class - Bicuspid Population**  
**(Valve Implant Population)**



Note: The total number of patients at each time point only counted the patients with valid values.

**Table 50:**  
**NHYA Changes - Bicuspid Population**  
**(Valve Implant Population)**

	NYHA Class Change*		
	Improved	Same	Worsened
Baseline to 30-day visit	340/405 (84.0%)	54/405 (13.3%)	11/405 (2.7%)
Baseline to 1-year visit	208/252 (82.5%)	32/252 (12.7%)	12/252 (4.8%)

\*n/Total no. (%); the total no. only counted the patients with valid values.

## Five Meter Walk Test

The results of the five-meter walk test are summarized in Table 51.

**Table 51:**  
**Five-Meter Walk Test - Bicuspid Population**  
**(Valve Implant Population)**

Visit	Five Meter Walk Time (seconds)*
Baseline	8.0 ± 4.8 (411)
30-day visit	6.7 ± 2.8 (119)
Change from baseline to 30-day visit	-1.2 ± 3.5 (101)
1-year visit	6.2 ± 2.4 (43)
Change from baseline to 1-year visit	-1.6 ± 3.6 (35)

\*Mean ± SD (Total no.). The total number of patients at each time point only counted the patients with valid values.



## Length of Stay

The mean index hospitalization stay was 4.7 days, which included an average of 1.6 days in the intensive care unit (ICU), as summarized in Table 52.

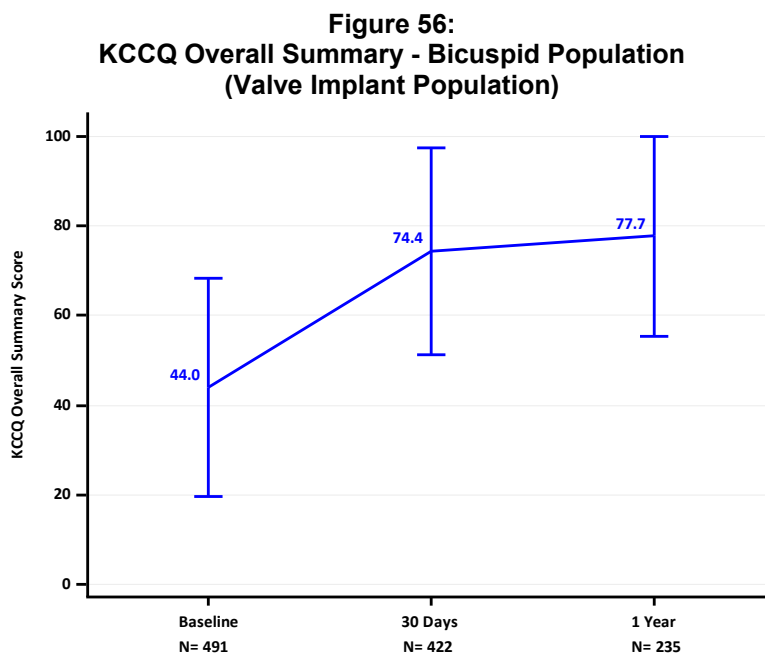
**Table 52:**  
**Index Hospitalization Stay - Bicuspid Population**  
**(Attempted Implant Population)**

	Length (days)*
Index hospitalization duration (day)	4.7 ± 3.8 (545)
Intensive care stay (day)	1.6 ± 2.6 (537)

\*Mean ± SD (Total no.).

## Quality of Life (QoL)

The QoL at baseline, 30 days and one year as measured by the KCCQ overall summary score, is shown in Figure 56. The mean KCCQ summary score improved from 44.0 at baseline to 77.7 at one year.



Note: Line plot with mean and standard deviation. The total number of patients at each time point only counted the patients with valid values.

## Procedural Information

The procedure information is presented in Table 53. The most common delivery approach for the bicuspid population was the transfemoral approach, which was used in 94.7% (516/545) of cases, followed by the transapical and transaortic in 1.3% (7/545) and 1.3% (7/545) of cases, respectively, and other alternative approaches (subclavian, transcrotid, and other) in 2.8% (15/545). The device was successfully implanted in 539/544 (99.1%) of patients; five patients were converted to open heart surgery 0.9% (5/545) due to ventricular rupture (1 patient), annulus rupture (1 patient), coronary occlusion (1 patient) and other (2 patients). There were no cases of valve embolization. Device implant success is defined as correct positioning of a single prosthetic heart valve in the proper anatomical location.

**Table 53:  
Procedural Data Summary - Bicuspid Population  
(Attempted Implant Population)**

	<b>Summary Statistics*</b>
<b>Operator reason for procedure</b>	
Inoperable/Extreme risk	115/545 (21.1%)
High risk	394/545 (72.3%)
Intermediate risk	24/545 (4.4%)
Low risk	12/545 (2.2%)
<b>Implant approach</b>	
Transfemoral	516/545 (94.7%)
Transapical	7/545 (1.3%)
Transaortic	7/545 (1.3%)
Subclavian/axillary	9/545 (1.7%)
Transcarotid	3/545 (0.6%)
Other	3/545 (0.6%)
<b>Procedure status</b>	
Elective	497/545 (91.2%)
Urgent	47/545 (8.6%)
Emergency	1/545 (0.2%)
<b>Valve size</b>	
20 mm	16/545 (2.9%)
23 mm	95/545 (17.4%)
26 mm	220/545 (40.4%)
29 mm	214/545 (39.3%)
<b>Primary procedure indication</b>	
Aortic stenosis (Primary)	535/545 (98.2%)
Aortic insufficiency (Primary)	1/545 (0.2%)
Mixed aortic stenosis/aortic insufficiency	9/545 (1.7%)
<b>Cardiopulmonary bypass (CPB)</b>	
<b>CPB status</b>	
Elective	2/5 (40.0%)
Emergent	3/5 (60.0%)
CPB time (min)	52.2 ± 24.2 (5)
<b>Type of anesthesia</b>	
General anesthesia	389/545 (71.4%)
Moderate sedation	151/545 (27.7%)
Epidural	1/545 (0.2%)
Combination	4/545 (0.7%)

	Summary Statistics*
Total procedure time (min)	109.3 ± 49.5 (545)
Fluoroscopy time (min)	19.9 ± 10.4 (528)
Device implanted successfully	539/544 (99.1%)
Procedure aborted	0/545 (0.0%)
Conversion to open heart surgery	5/545 (0.9%)
Ventricular rupture	1/5 (20.0%)
Annulus rupture	1/5 (20.0%)
Coronary occlusion	1/5 (20.0%)
Other	2/5 (40.0%)
Mechanical assist device in place at start of procedure	5/545 (0.9%)
Intra-aortic balloon pump (IABP)	3/5 (60.0%)
Catheter based assist device	2/5 (40.0%)

\*Categorical measures – no./Total no. (%); continuous measures - mean ± SD (Total no.). The total no. only counted the patients with valid values at the time point.

### **SAPIEN 3 THV IN BICUSPID AORTIC VALVE FOR PATIENTS AT LOW SURGICAL RISK – PARTNER 3 BICUSPID REGISTRY ANALYSIS**

#### **A. Patient Accountability**

At the time of the database lock, a total of 75 patients were enrolled in the registry.

There were three different analysis populations reflective of the single-arm study design: All Enrolled, Attempted Implant (AI), and Valve Implant (VI), which are defined in Table 54.

**Table 54: Analysis Populations**

Analysis Population	Definition	Number of Patients
All Enrolled	All patients who were approved by the Case Review Board and enrolled in the study.	75
Attempted Implant (AI)	All enrolled patients in whom the index procedure had begun, whether or not the procedure was completed.	71
Valve Implant (VI)	All AI patients who received and retained the study valve during the index procedure.	71

The overall follow-up compliance of the registry is summarized in Table 55.

**Table 55: Bicuspid Registry Study Compliance (AI Population)**

Patient Disposition and Visit Status	30-Day Visit	1-Year Visit
Total patients	71	71
Ineligible*	0	1
Death	0	1
Withdrawn	0	0
Lost to follow-up	0	0
Exit with other reason	0	0

Patient Disposition and Visit Status	30-Day Visit	1-Year Visit
Eligible <sup>†</sup>	71	70
Follow-up visit completed	71 (100.0%)	69 (97.2%)

<sup>\*</sup>Ineligible includes patients who exited the study prior to the visit or had a pending visit status

<sup>†</sup>Eligible patients = analysis population N – ineligible patients.

### B. Study Population Demographics and Baseline Characteristics

The demographics and baseline characteristics of the study population are typical for a TAVR study performed in the U.S., as shown in Table 56.

**Table 56: Patient Demographics and Baseline Characteristics (All Population)**

Demographics and Baseline Characteristics	Summary Statistics* (N=71)
Age (years)	68.5 ± 6.6
Gender	
Male	69.0% (49/71)
Female	31.0% (22/71)
Society of Thoracic Surgeons (STS) score (%)	1.4 ± 0.59
New York Heart Association (NYHA) class	
I/II	76.1% (54/71)
III/IV	23.9% (17/71)
Previous myocardial infarction	7.0% (5/71)
Previous intervention	
Coronary artery bypass grafting (CABG)	0.0% (0/71)
Percutaneous coronary intervention (PCI)	7.0% (5/71)
Stroke or cerebrovascular accident (CVA)	2.8% (2/71)
Peripheral vascular disease (PVD)	5.6% (4/71)
Atrial fibrillation	4.2% (3/71)
Permanent pacemaker or defibrillator	1.4% (1/71)
Hostile chest	0.0% (0/71)
Echocardiographic findings	
Valve area (cm <sup>2</sup> )	0.7 ± 0.2 (65)
Mean gradient (mmHg)	56.1 ± 15.5 (71)
Mean left ventricular ejection fraction (LVEF), %	64.0 ± 11.1 (66)
Moderate or severe aortic regurgitation	5.6% (4/71)
Moderate or severe mitral regurgitation	1.4% (1/70)
Morphology	
Bicuspid Sievers Type 0	14.1% (10/71)
Bicuspid Sievers Type 1	84.5% (60/71)
Bicuspid Sievers Type 2	1.4% (1/71)

\* Continuous measures - mean ± SD (Total no.); Categorical measures - % (no./Total no.)

**C. Safety and Effectiveness Results**

1. Primary Endpoint

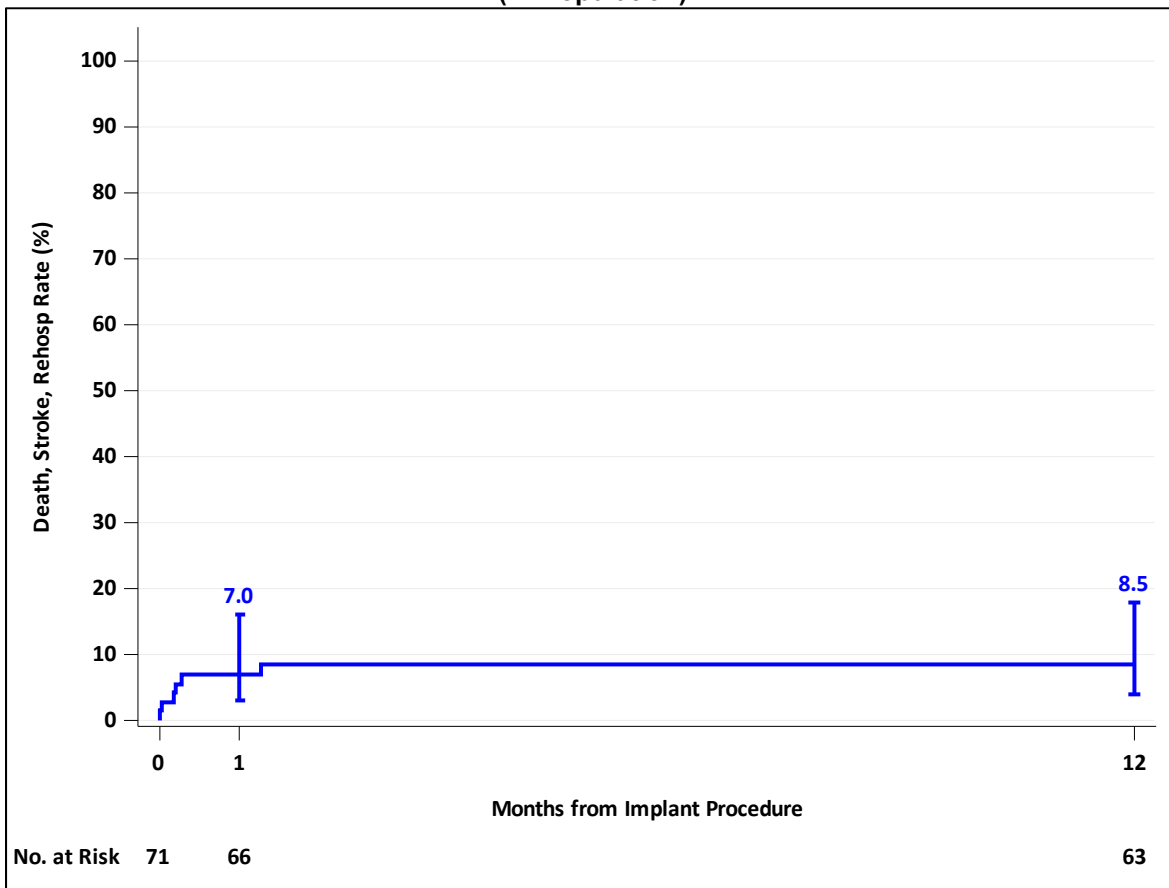
The primary endpoint results are presented in Table 57 and Figure 57. The rate of all-cause death, all stroke, and rehospitalization (valve-related or procedure-related and including heart failure) at 1 year was 8.5%.

**Table 57: Primary Endpoint Analysis (AI Population)**

Endpoint	Kaplan-Meier Rate* (N=71)
All-cause death, all stroke, or rehospitalization	8.5% (7, 6)
All-cause death	1.4% (1, 1)
All stroke	2.8% (2, 2)
Rehospitalization	5.6% (4, 4)

\*Kaplan-Meier rate (no. of events, no. of patients with the event).

**Figure 57: All-Cause Death, All Stroke, and Rehospitalization through 1 Year (AI Population)**



**Note:** Vertical bar represents 95% confidence interval. The confidence intervals are calculated without multiplicity adjustment. The adjusted confidence intervals could be wider than presented here. As such, confidence intervals are provided to illustrate the variability only and should not be used to draw any statistical conclusion.

## 2. Secondary Endpoints

A summary of the secondary endpoints is shown in Table 58. No formal statistical tests were performed.

**Table 58: Secondary Endpoints Analysis (AI Population)**

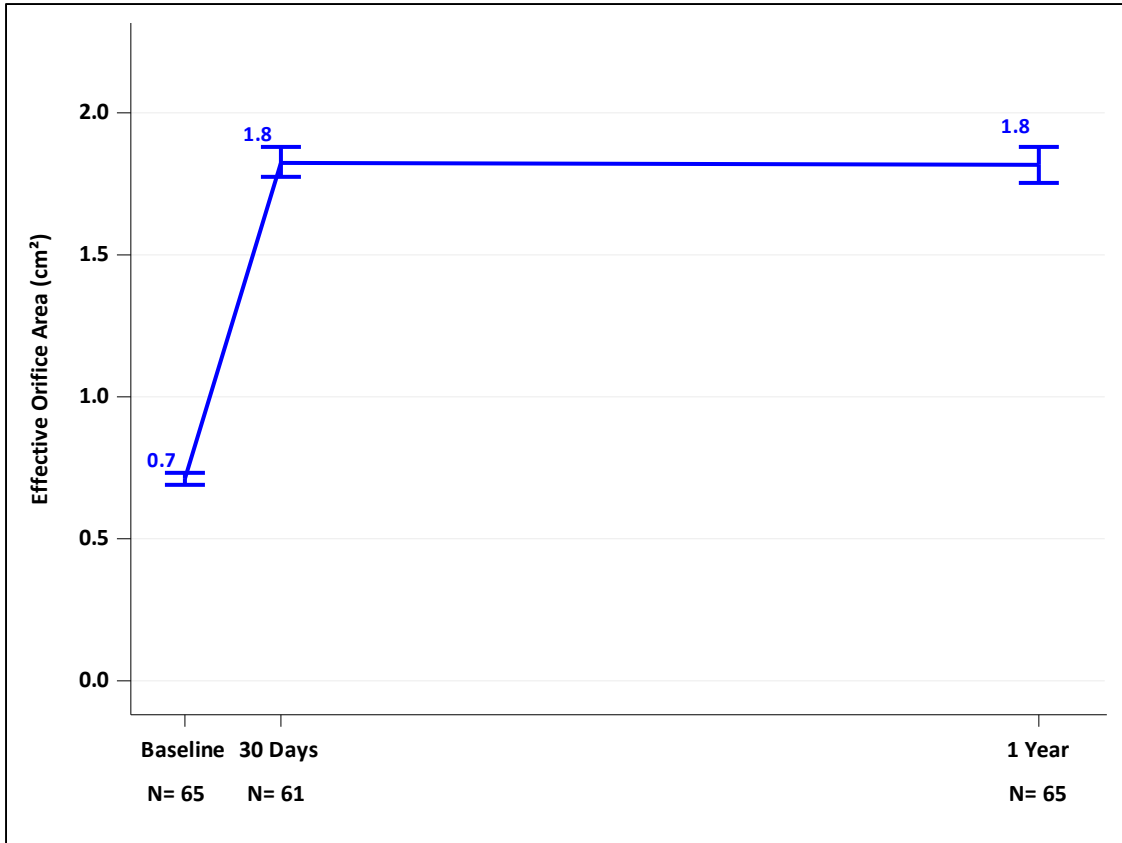
No.	Endpoint	Summary Statistics*
1	New onset atrial fibrillation at 30 days	4.2% (3/71)
2	Length of index hospitalization (days)	2.6 ± 0.1 (71)
3	Death, KCCQ < 45 or KCCQ decrease from baseline ≥ 10 points at 30 days	1.4% (1/71)
4	Death or all stroke at 30 days	2.8% (2/71)
5	All stroke at 30 days	2.8% (2/71)

\*Continuous measures - mean ± SE (Total no.); Categorical measures – observed rate, % (no./Total no.)

### Valve Performance

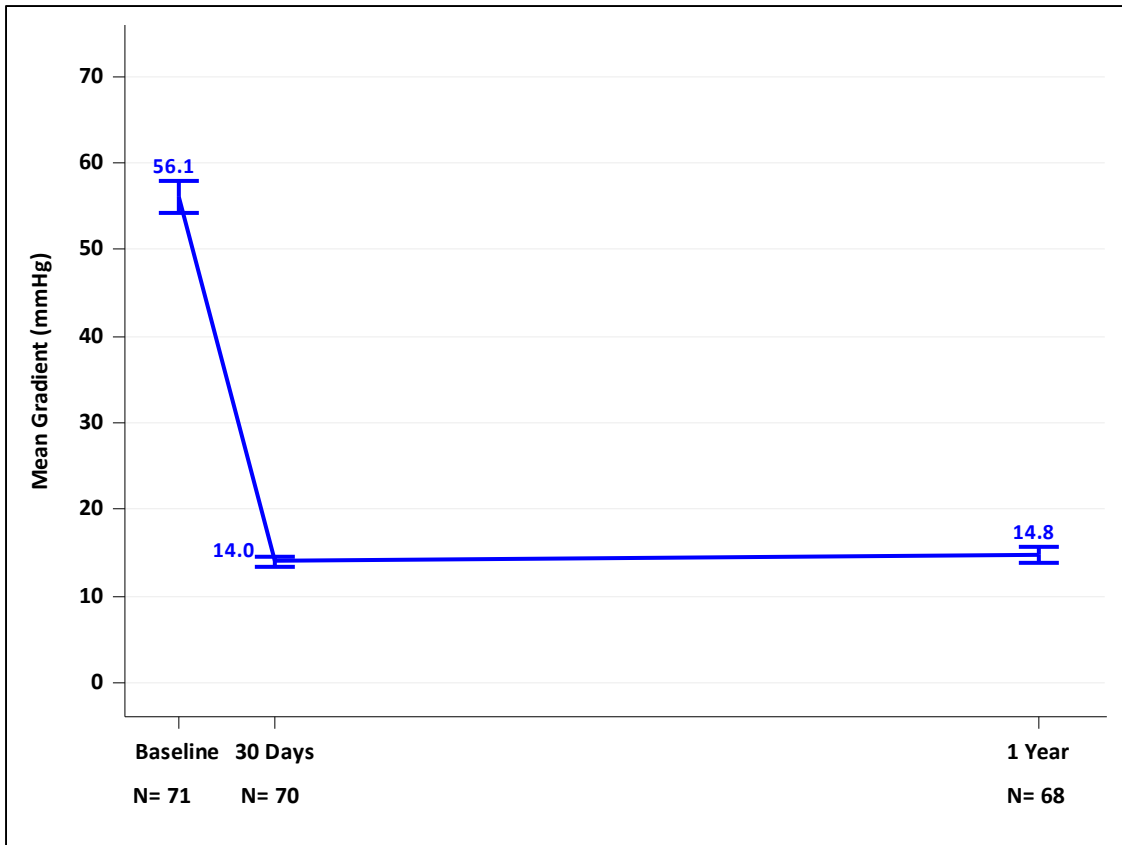
The increase in EOA and decrease in gradient were sustained through 1 year. The proportion of patients with total AR ≥ moderate was 1.4% at 30 days and 1.5% at 1 year. The proportion of patients with paravalvular regurgitation ≥ moderate was 1.4% at 30 days and 0.0% at 1 year. Prosthesis patient mismatch (PPM) was measured per VARC-2. The percentages of patients with moderate and severe PPM were 21.5% and 9.2%, respectively. However, no deaths were reported in these patients at 1 year. It should be noted that there are limitations in echocardiogram measurement of PPM in TAVR patients, such as errors in stroke volume calculation, inherent limitations in the Bernoulli equation for deriving post-implant gradients, which will overstate the degree of PPM. Relying on the echocardiogram-derived iEOA alone to estimate PPM without taking into consideration the aortic valve velocity and gradient will lead to conflicting PPM assessment and outcomes post-TAVR<sup>[4]</sup>. Accounting for pressure recovery, using predicted versus measured iEOA, and using more accurate CT-LVOT area measurement may be required in the assessment of PPM and prosthetic valve function. Thus, interpretation of the PPM rate should take into consideration the current methodological limitations in PPM measurement and the totality of the clinical outcomes data of the device.

Figure 58: Effective Orifice Area (VI Population)



**Note:** Line plot with mean and standard error. The total number of patients at each visit time point only counted the patients with valid values.

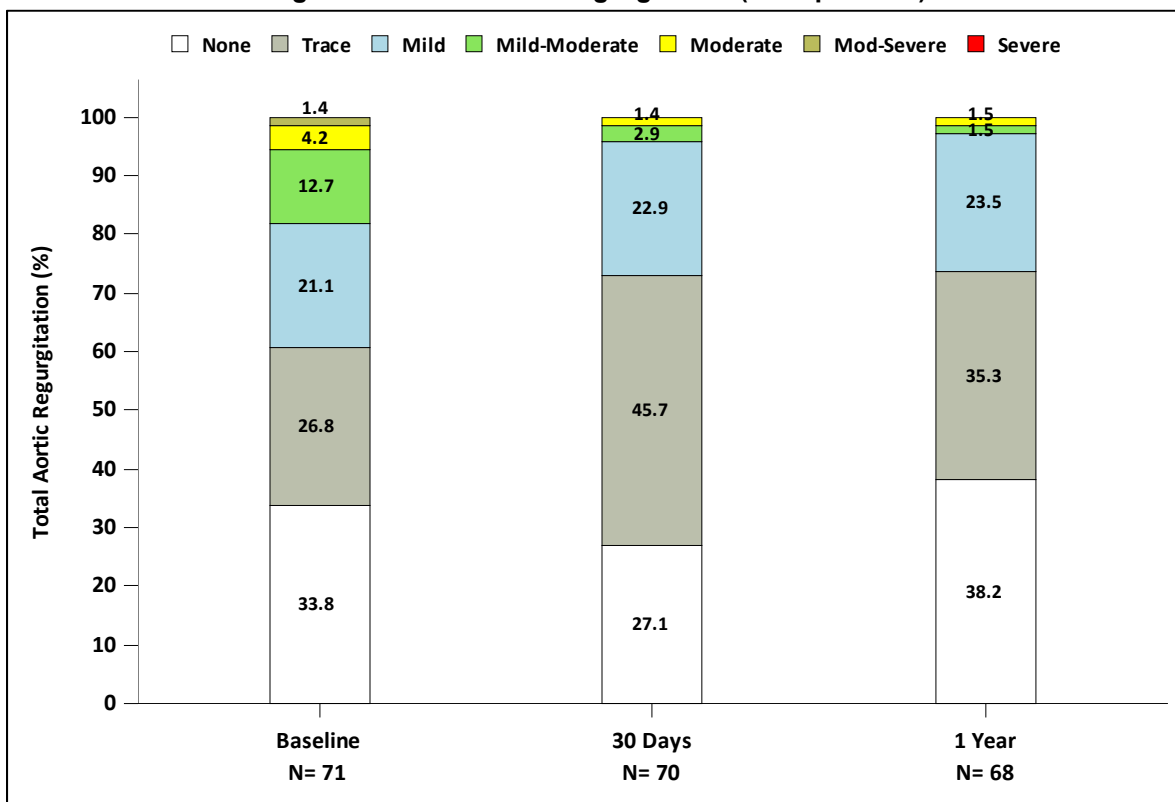
Figure 59: Mean Aortic Gradient (VI Population)



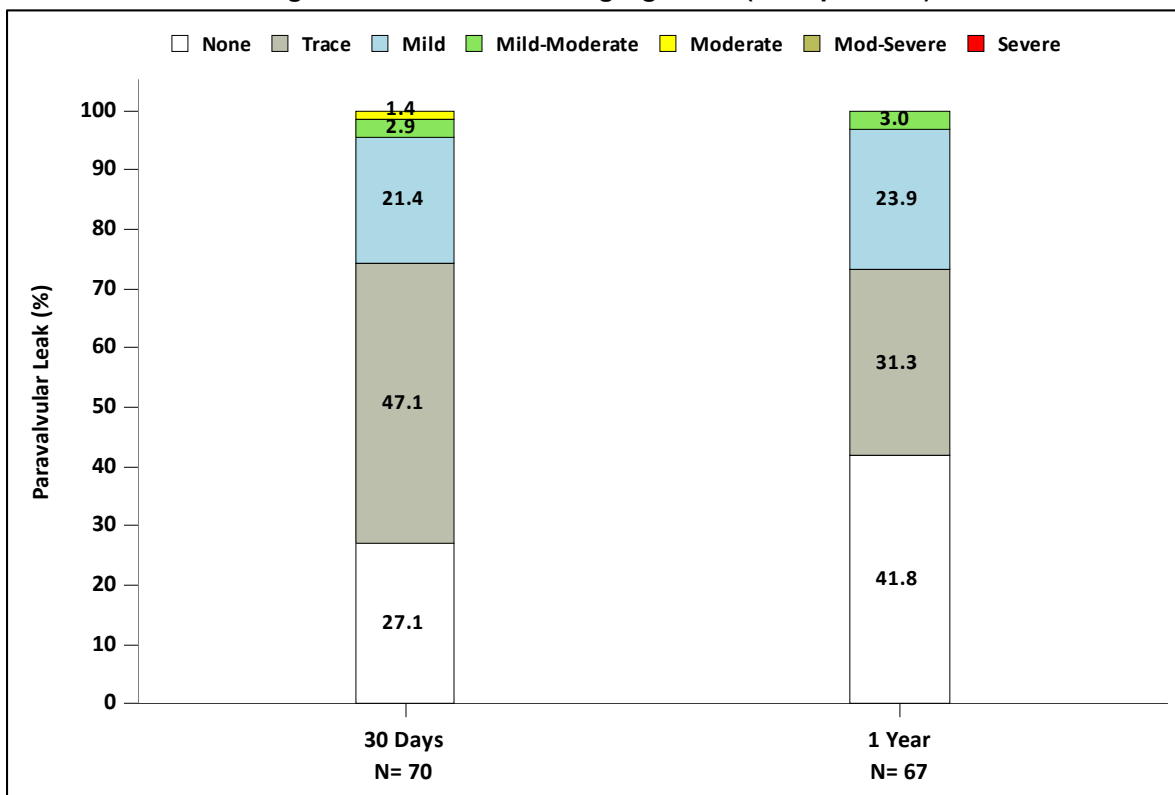
**Note:** Line plot with mean and standard error. The total number of patients at each visit time point only counted the patients with valid values.



**Figure 60: Total Aortic Regurgitation (VI Population)**



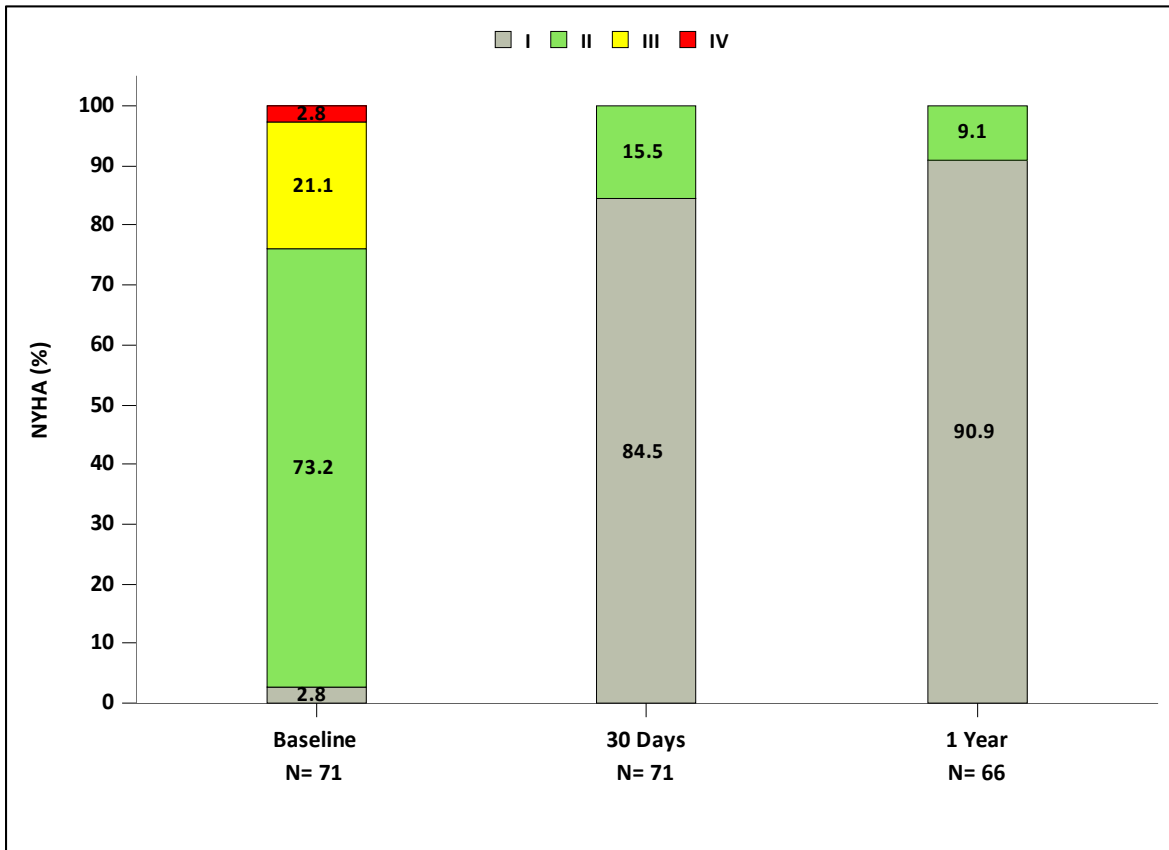
**Figure 61: Paravalvular Regurgitation (VI Population)**



New York Heart Association (NYHA) Class

The NYHA classifications by visit are presented in Figure 62. At baseline, 23.9% of patients were in NYHA class III/IV. At 1 year, all patients (100.0%) were in NYHA class I/II.

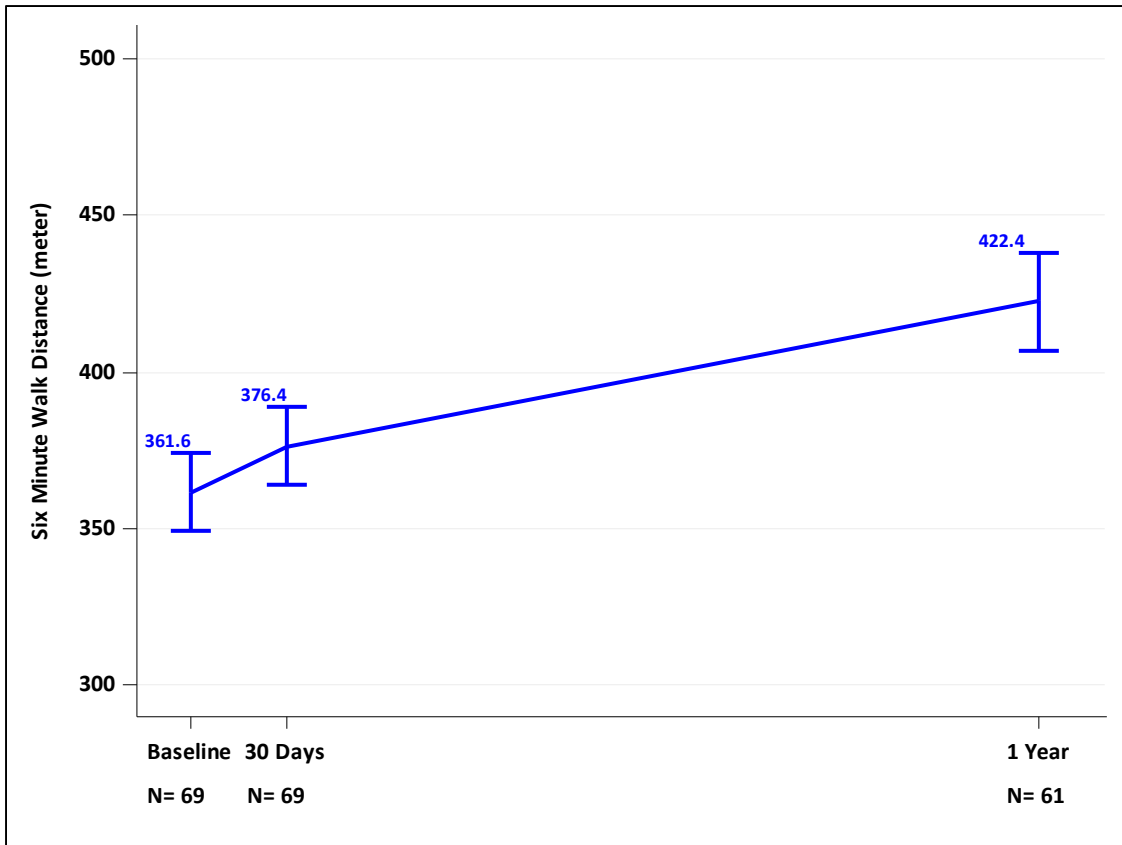
**Figure 62: NYHA Class by Visit (VI Population)**



Six-Minute Walk Test (6MWT)

The results for the 6MWT are presented in Figure 63. The patients showed an increase in mean 6MWT distance from 361.6 meters at baseline to 376.4 meters at 30 days and 422.4 meters at 1 year.

Figure 63: 6MWT Distance (VI Population)



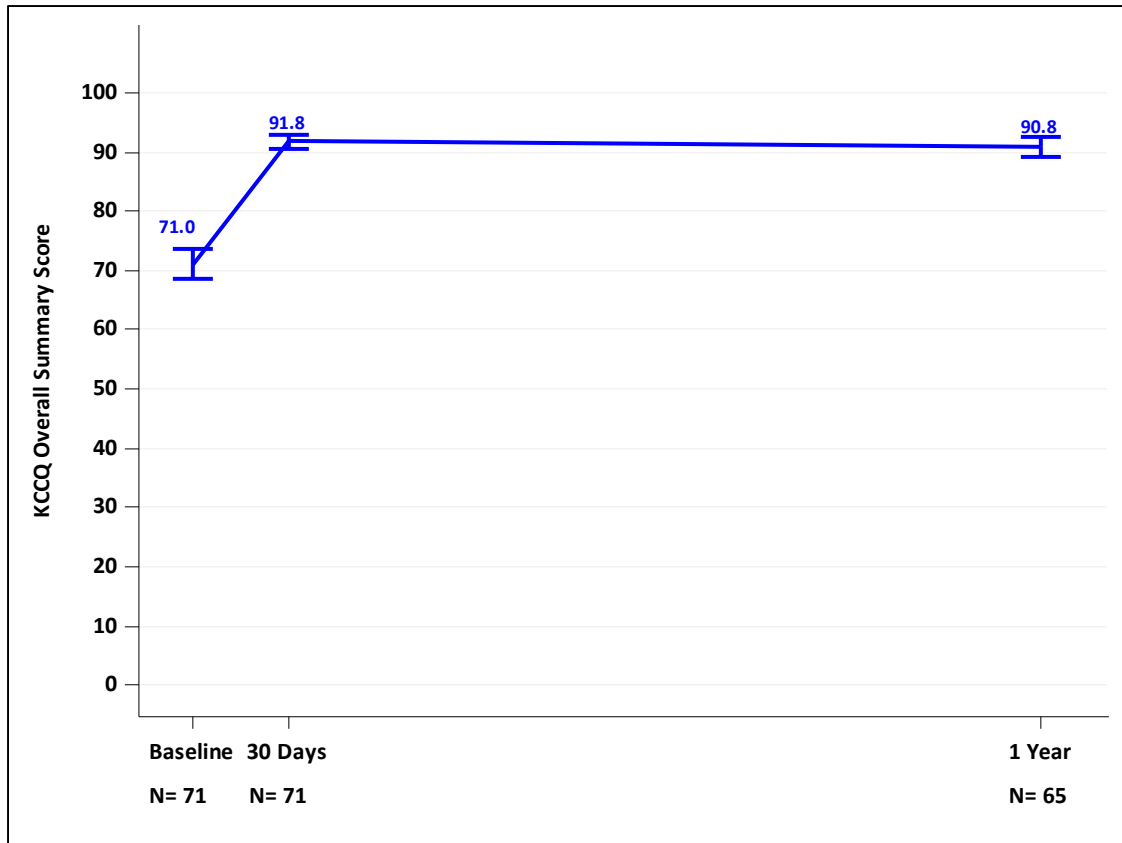
**Note:** Line plot with mean and standard error. The total number of patients at each visit time point only counted the patients with valid values.

### Quality of Life

#### *KCCQ*

The results for the KCCQ overall summary score are presented in Figure 64. The mean score increased from 71.0 at baseline to 91.8 at 30 days and 90.8 at 1 year.

Figure 64: KCCQ Overall Summary Score (VI Population)

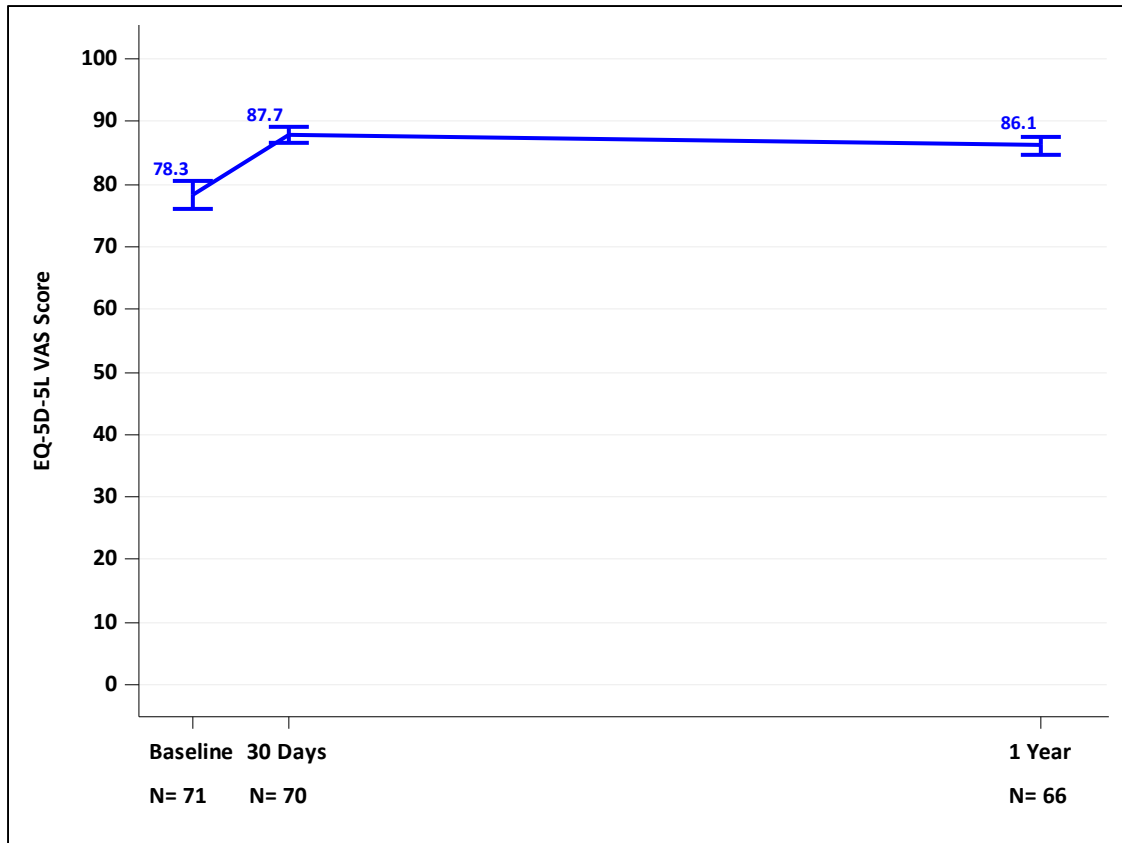


**Note:** Line plot with mean and standard error. The total number of patients at each visit time point only counted the patients with valid values.

*EuroQol (EQ-5D)*

The results for the EQ-5D visual analog score (VAS) are presented in Figure 65. The mean score was 78.3 at baseline, 87.7 at 30 days, and 86.1 at 1 year.

Figure 65: EQ-5D Visual Analog Score (VI Population)

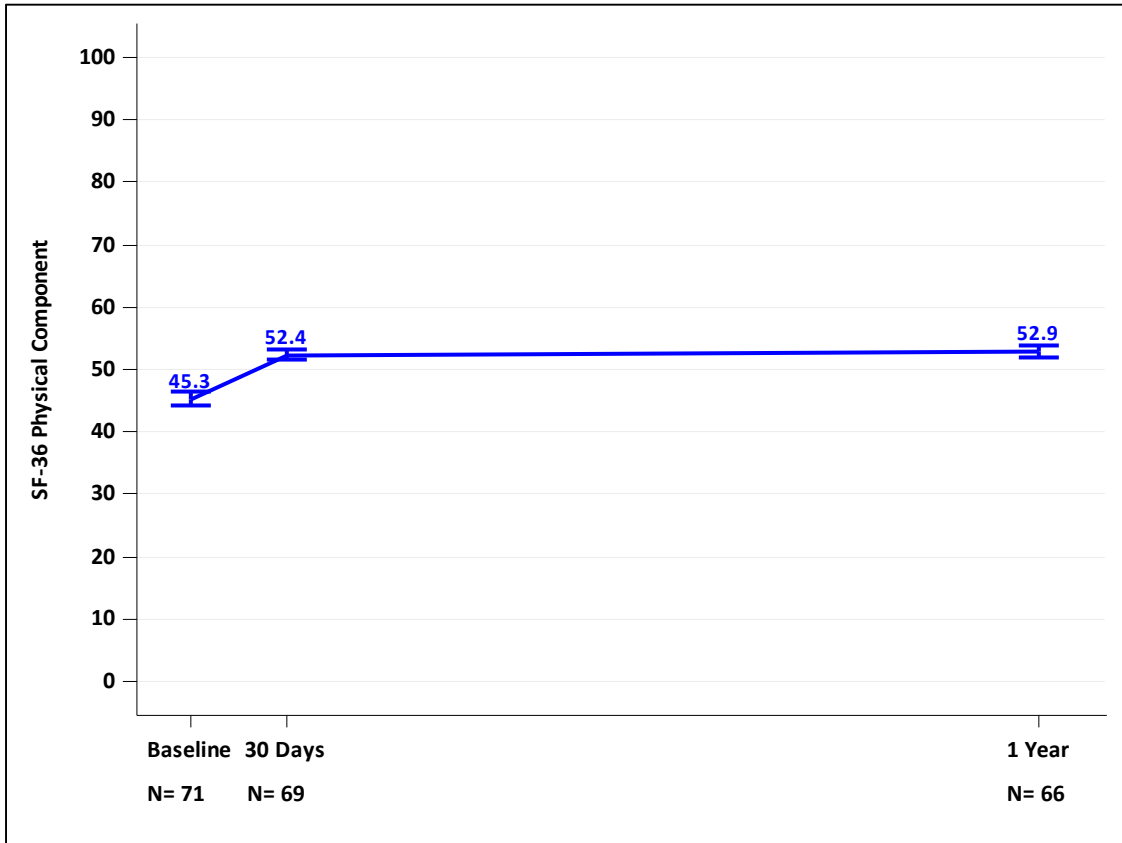


**Note:** Line plot with mean and standard error. The total number of patients at each visit time point only counted the patients with valid values.

*Short Form (SF)-36*

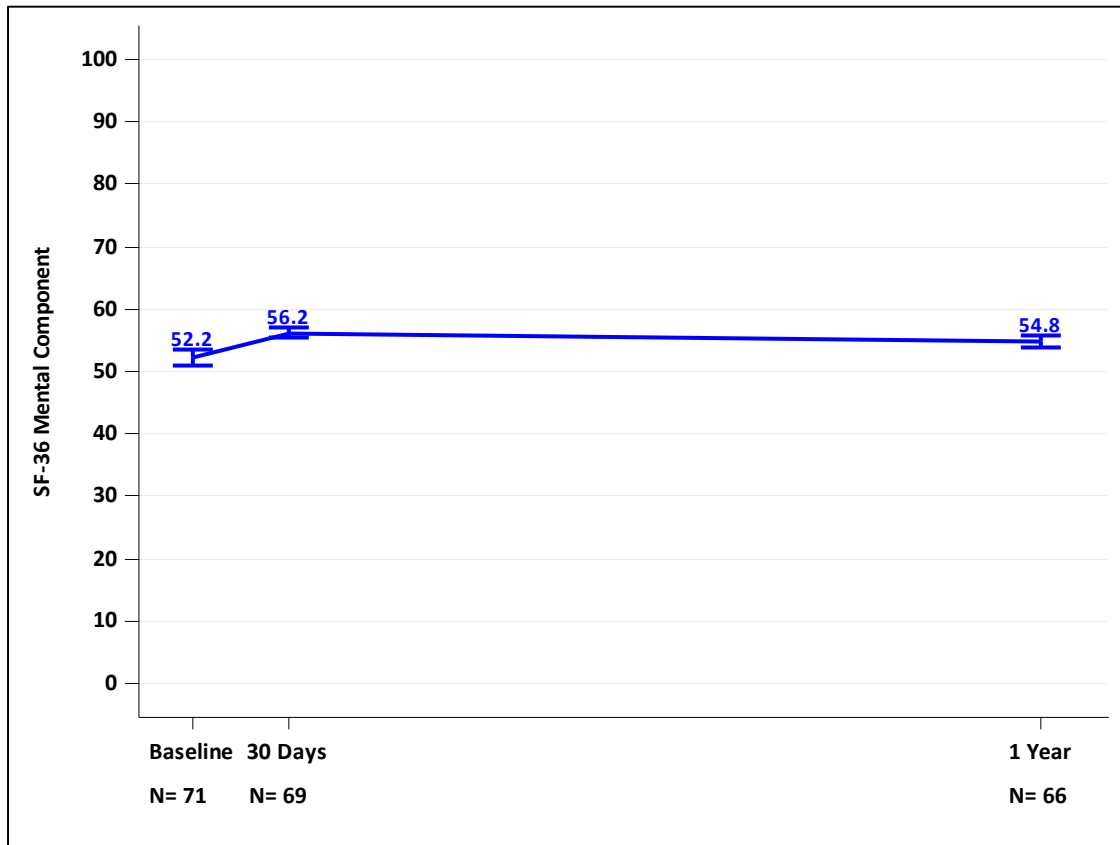
The results for the SF-36 physical component summary score and mental component summary score are presented in Figure 66 and Figure 67, respectively.

Figure 66: SF-36 Physical Component Summary Score (VI Population)



**Note:** Line plot with mean and standard error. The total number of patients at each visit time point only counted the patients with valid values.

**Figure 67: SF-36 Mental Component Summary Score (VI Population)**



**Note:** Line plot with mean and standard error. The total number of patients at each visit time point only counted the patients with valid values.

### 3. Adverse Events

The Kaplan-Meier estimates of the CEC-adjudicated adverse events through 1 year are shown in Table 59.

**Table 59: CEC-Adjudicated Adverse Events through 1 Year (AI Population)**

Event	Kaplan-Meier Rate*	
	30 Days	1 Year
All-cause death	0.0% (0, 0)	1.4% (1, 1)
Cardiovascular death	0.0% (0, 0)	1.4% (1, 1)
All stroke	2.8% (2, 2)	2.8% (2, 2)
Disabling stroke	0.0% (0, 0)	0.0% (0, 0)
Non-disabling stroke	2.8% (2, 2)	2.8% (2, 2)
Death or stroke	2.8% (2, 2)	2.8% (3, 2)
Death or disabling stroke	0.0% (0, 0)	1.4% (1, 1)
Major vascular complications	0.0% (0, 0)	0.0% (0, 0)
Life-threatening / disabling, or major bleeding	1.4% (1, 1)	1.4% (1, 1)

Event	Kaplan-Meier Rate*	
	30 Days	1 Year
Life-threatening /disabling bleeding	0.0% (0, 0)	0.0% (0, 0)
Major bleeding	1.4% (1, 1)	1.4% (1, 1)
Myocardial infarction	0.0% (0, 0)	0.0% (0, 0)
Requirement for renal replacement†	0.0% (0, 0)	0.0% (0, 0)
New permanent pacemaker implantation resulting from new or worsened conduction disturbances‡	9.9% (7, 7)	11.3% (8, 8)
Coronary obstruction requiring intervention	0.0% (0, 0)	0.0% (0, 0)
New onset atrial fibrillation	2.9% (2, 2)	4.4% (3, 3)
Rehospitalization§	4.2% (3, 3)	5.6% (4, 4)

\*Kaplan-Meier rate (no. of events, no. of patients with the event).

†Requirement for renal replacement was based on the site-reported event. All the other events were based on the CEC-adjudicated results.

‡Patients with pacemaker or ICD at baseline were not counted as new events.

§Rehospitalization (valve-related or procedure-related and including heart failure).

#### 4. Other Study Observations

##### Procedural Information

The procedural data are summarized in Table 60. The mean procedure time was 57.5 minutes. Conscious sedation was used in the majority of patients (62.0%).

**Table 60: Procedure (AI Population)**

Variable	Summary Statistics* (N=71)
Procedure time (min)	57.5 ± 29.4 (71)
Anesthesia type	
General	36.6% (26/71)
Conscious sedation	62.0% (44/71)
Conversion from conscious sedation to general anesthesia during the procedure	1.4% (1/71)
Anesthesia time (min)	140.8 ± 47.0 (71)
Concomitant Procedures	12.7% (9/71)
Procedure aborted	0.0% (0/71)
Conversion from TAVR to SAVR	0.0% (0/71)
Valve size	
20 mm	0.0% (0/71)
23 mm	28.2% (20/71)
26 mm	43.7% (31/71)
29 mm	28.2% (20/71)
Successful access, delivery and retrieval of the device delivery system	100.0% (71/71)
Specify arterial access	
Left percutaneous	17.4% (12/69)
Right percutaneous	82.6% (57/69)
Total fluoroscopy time (min)	17.0 ± 11.2 (71)



Variable	Summary Statistics* (N=71)
BAV performed	54.9% (39/71)
Post dilatation performed	19.7% (14/71)
Number of post dilatations	
1	92.9% (13/14)
2	7.1% (1/14)
3	0.0% (0/14)
More than one SAPIEN 3 THV implanted	0.0% (0/71)

\*Continuous measures - mean  $\pm$  SD (n); Categorical measures - % (no./Total no.).

## **SAPIEN 3 THV VALVE-IN-VALVE – STS/ACC TRANSCATHETER VALVE THERAPY REGISTRY (TVTR) ANALYSIS**

### **Patient Accountability**

At the time of database extract, of the 314 patients in the aortic valve-in-valve cohort, 299 patients were eligible for the 30-day visit, and 252 (84.3%) patients paid a visit within the 30-day follow-up window defined as the period between the discharge + 1 day or 21 days post-procedure (whichever occurred first) and 75 days post-procedure; of the 311 patients (SAPIEN XT and SAPIEN 3 valve patients combined) in the mitral valve-in-valve cohort, 290 patients were eligible for the 30-day visit, and 244 (84.1%) patients paid a visit within the 30-day follow-up window. A detailed summary of the patient accountability at 30 days for the two cohorts is shown in Table 61.

**Table 61:  
Patient Accountability at 30-Day Follow-Up Visit**

	Aortic Valve-in-Valve	Mitral Valve-in-Valve		
		SAPIEN XT	SAPIEN 3	All
Total patients	314	241	70	311
Non-eligible	15	15	6	21
-Death	11	15	4	19
-Withdrawal	0	0	0	0
-Lost to follow-up	1	0	2	2
-Visit not yet due	3	0	0	0
Eligible	299	226	64	290
-Follow-up visit completed	252 (84.3%)	196 (86.7%)	48 (75.0%)	244 (84.1%)
-Missed Visit	47 (15.7%)	30 (13.3%)	16 (25.0%)	46 (15.9%)

The “Attempted Implant” population consisted of all patients for whom the first vascular access was attempted. The “Valve Implant” population consisted of those patients for whom the valve implant procedure has started and a “No” was indicated for both “procedure aborted” and “conversion to open heart surgery.” The number of patients in each analysis population of the aortic valve-in-valve and mitral valve-in-valve cohorts is shown in Table 62.

**Table 62:  
Analysis Populations**

Analysis Population	Aortic Valve-in-Valve	Mitral Valve-in-Valve		
		SAPIEN XT	SAPIEN 3	All
All Enrolled population	314	241	70	311
Attempted Implant population	314	241	70	311
Valve Implant population	314	236	69	305

**Study Population Demographics and Baseline Characteristics**

The demographics and baseline characteristics of both the aortic and mitral valve-in-valve patients, as shown in Tables 63 and 64, present an elderly, multimorbid cohort of patients, consistent with the high operative risk of the populations.

**Table 63:  
Patient Demographics and Baseline Characteristics - Aortic Valve-in-Valve  
(Attempted Implant Population)**

Demographics and Baseline Characteristics	Summary Statistics*
Age – years	74.3 ± 12.10 (313)
Male sex	188/314
Society of Thoracic Surgeons (STS) score	9.0 ± 8.0 (304)
New York Heart Association (NYHA) class	
I/II	45/312 (14.4%)
III/IV	267/312 (85.6%)
Previous myocardial infarction	62/313 (19.8%)
Previous intervention	
Coronary artery bypass grafting (CABG)	119/314 (37.9%)
Percutaneous coronary intervention (PCI)	56/314 (17.8%)
Prior aortic valvuloplasty	10/306 (3.3%)
Cerebrovascular accident (CVA)	46/313 (14.7%)
Peripheral vascular disease	79/314 (25.2%)
Atrial fibrillation	126/314 (40.1%)
Permanent pacemaker	53/314 (16.9%)
Porcelain aorta	19/314 (6.1%)
Hostile chest	58/314 (18.5%)
Echocardiographic findings (Valve Implant Population)	
Valve area - cm <sup>2</sup>	0.8 ± 0.4 (230)
Mean aortic-valve gradient – mmHg	39.3 ± 15.8 (251)
Mean left ventricular ejection fraction (LVEF)%	52.2 ± 13.1 (308)
Moderate or severe aortic regurgitation	168/310 (54.2%)
Moderate or severe mitral regurgitation	126/261 (48.3%)

\*Continuous measures - Mean ± SD (Total no.); Categorical measures - n. / Total no. (%)

**Table 64:  
Patient Demographics and Baseline Characteristics - Mitral Valve-in-Valve  
(Attempted Implant Population)**

Demographics and Baseline Characteristics	Summary Statistics*		
	SAPIEN XT	SAPIEN 3	All
Age - years	73.9 ± 12.4 (241)	71.5 ± 15.0 (70)	73.4 ± 13.1 (311)
Male sex	88/241 (36.5%)	32/70 (45.7%)	120/311 (38.6%)
Society of Thoracic Surgeons (STS) score	13.2 ± 9.1 (237)	12.2 ± 8.7 (65)	13.0 ± 8.98 (302)
New York Heart Association (NYHA) class			
I/II	30/238 (12.6%)	3/70 (4.3%)	33/308 (10.7%)
III/IV	208/238 (87.4%)	67/70 (95.7%)	275/308 (89.3%)
Previous myocardial infarction	47/239 (19.7%)	18/70 (25.7%)	65/309 (21.0%)
Previous intervention			
Coronary artery bypass grafting (CABG)	93/236 (39.4%)	28/69 (40.6%)	121/305 (39.7%)
Percutaneous coronary intervention (PCI)	32/238 (13.4%)	9/69 (13.0%)	41/307 (13.4%)
Cerebrovascular accident (CVA)	45/241 (18.7%)	15/70 (21.4%)	60/311 (19.3%)
Peripheral vascular disease	42/239 (17.6%)	6/70 (8.6%)	48/309 (15.5%)
Atrial fibrillation/flutter	155/241 (64.3%)	50/70 (71.4%)	205/311 (65.9%)
Permanent pacemaker	74/240 (30.8%)	20/69 (29.0%)	94/309 (30.4%)
Porcelain aorta	6/240 (2.5%)	1/69 (1.4%)	7/309 (2.3%)
Hostile chest	41/241 (17.0%)	6/70 (8.6%)	47/311 (15.1%)
Echocardiographic findings (Valve Implant Population)			
Mitral valve area - cm <sup>2</sup>	1.5 ± 0.9 (153)	1.4 ± 1.0 (46)	1.5 ± 0.88 (199)
Mean mitral-valve gradient - mmHg	12.7 ± 5.5 (215)	13.7 ± 6.2 (65)	12.9 ± 5.65 (280)
Mean left ventricular ejection fraction (LVEF), %	54.4 ± 11.7 (230)	53.8 ± 13.9 (67)	54.3 ± 12.2 (297)
Moderate or severe aortic regurgitation	35/231 (15.2%)	7/67 (10.5%)	42/298 (14.1%)
Moderate or severe mitral regurgitation	149/233 (63.9%)	39/68 (57.4%)	188/301 (62.5%)

\*Continuous measures - Mean ± SD (Total no.); categorical measures - n. / Total no. (%). The total no. only counted the patients with valid values.

## Safety and Effectiveness Results

### Aortic Valve-in-Valve

#### Safety Endpoints

The mortality rates at discharge and 30 days and the Kaplan-Meier curve for all-cause mortality for the aortic valve-in-valve cohort are shown in Table 65 and Figure 68, respectively. There were a total of 12 deaths reported at 30 days.

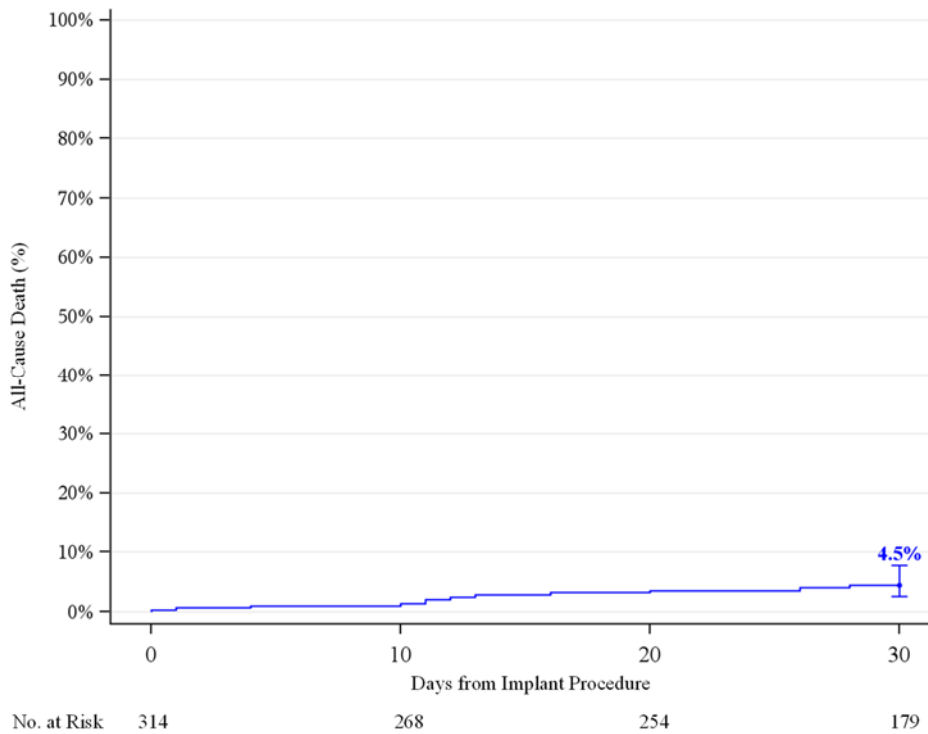
**Table 65:**  
**Death Rate - Aortic Valve-in-Valve (Attempted Implant Population)**

	Discharge*	30 Days†
All-cause death	2.5% (8)	4.5% (12)
Cardiac death	1.3% (4)	2.2% (6)

\*Observed rate - % (n)

†Kaplan-Meier estimate - % (n)

**Figure 68:**  
**All-Cause Death Rate - Aortic Valve-in-Valve**  
**(Attempted Implant Population)**



The DCRI adjudicated events, including all strokes/TIAs and aortic valve reinterventions at discharge and 30 days for the aortic valve-in-valve cohort, are shown in Table 66.

**Table 66:**  
**Duke Clinical Research Institute Adjudicated Events - Aortic Valve-in-Valve**  
**(Attempted Implant Population)**

Events	Discharge*	30 Days†
All stroke	1.0% (3, 3)	1.0% (3, 3)
Ischemic stroke	1.0% (3, 3)	1.0% (3, 3)
Hemorrhagic stroke	0.0% (0, 0)	0.0% (0, 0)
Transient ischemic attack (TIA)	0.0% (0, 0)	0.0% (0, 0)
Aortic valve reintervention	0.3% (1, 1)	0.3% (1, 1)

\*Observed rate - % (no. of events, no. of subjects with the event)

†Kaplan-Meier estimate - % (no. of events, no. of subjects with the event)

### Site Reported Adverse Events

The site reported adverse events at discharge and 30 days for the aortic valve-in-valve cohort is shown in Table 67.

**Table 67:**  
**Site Reported Adverse Events - Aortic Valve-in-Valve**  
**(Attempted Implant Population)**

Events	Discharge*	30 Days†
Non-valve related readmission	N/A	5.9% (15, 15)
Minor vascular complication	3.8% (12, 12)	4.3% (13, 13)
Conduction/native pacer disturbance requiring pacer	2.9% (9, 9)	3.0% (9, 9)
Hematoma at access site	2.9% (9, 9)	2.9% (9, 9)
Atrial fibrillation	2.5% (8, 8)	2.6% (8, 8)
Bleeding at access site	2.5% (8, 8)	2.5% (8, 8)
Cardiac arrest	2.5% (8, 8)	2.5% (8, 8)
Unplanned vascular surgery or intervention	1.6% (5, 5)	2.0% (7, 6)
Percutaneous coronary intervention (PCI)	1.3% (4, 4)	1.7% (5, 5)
Other bleed	1.3% (4, 4)	1.3% (4, 4)
Coronary compression or obstruction	1.0% (3, 3)	1.0% (3, 3)
Hemorrhagic stroke	0.6% (2, 2)	1.1% (3, 3)
Life threatening bleeding	N/A	1.1% (3, 3)
Unplanned other cardiac surgery or intervention	1.0% (3, 3)	1.0% (3, 3)
Major bleeding event	N/A	0.8% (2, 2)
Major vascular complication	0.6% (2, 2)	0.6% (3, 2)
Myocardial infarction	0.3% (1, 1)	0.7% (2, 2)
New requirement for dialysis	0.6% (2, 2)	0.8% (2, 2)
Other device related event	0.6% (2, 2)	0.6% (2, 2)
Aortic valve re-intervention	0.0% (0, 0)	0.4% (1, 1)
Conduction/native pacer disturbance requiring implantable cardioverter defibrillator (ICD)	0.3% (1, 1)	0.3% (1, 1)
Device migration	0.3% (1, 1)	0.3% (1, 1)
Gastrointestinal bleeding (GI) bleed	0.3% (1, 1)	0.3% (1, 1)
Transapical related event	0.3% (1, 1)	0.3% (1, 1)
Valve related readmission	N/A	0.4% (1, 1)
Device thrombosis	0.0% (0, 0)	0.0% (0, 0)

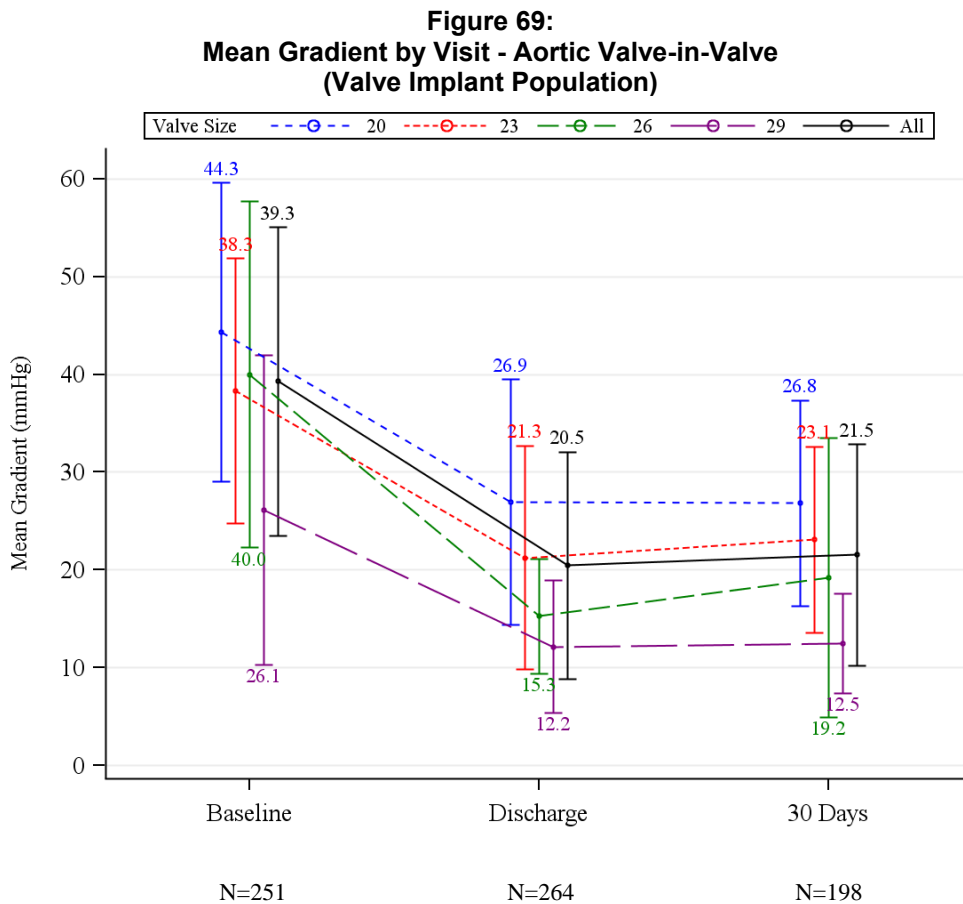
\*Observed rate - % (no. of events, no. of subjects with the event)

†Kaplan-Meier estimate - % (no. of events, no. of subjects with the event)

## Effectiveness Endpoints

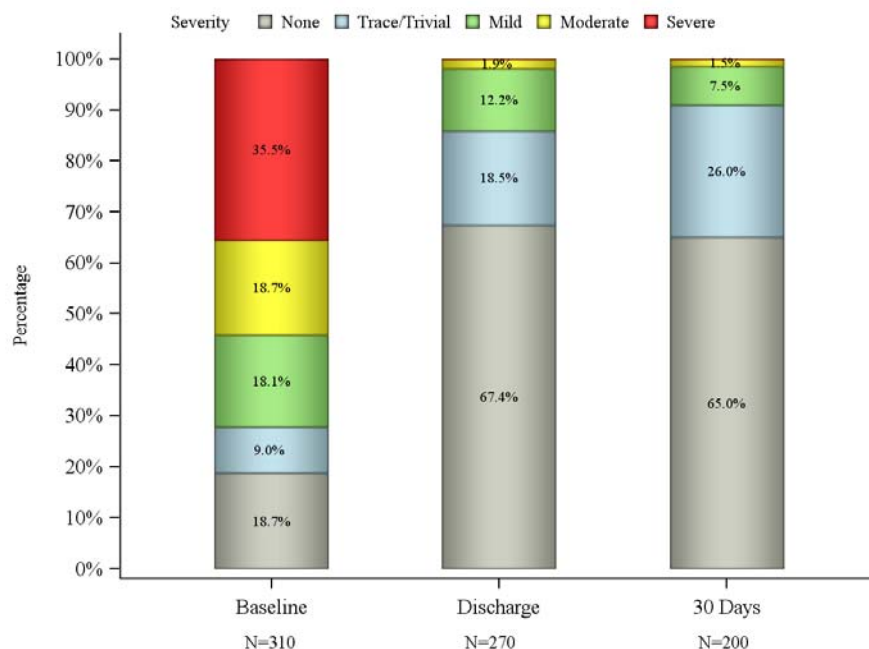
### Valve Performance

The aortic valve-in-valve echocardiographic performance data are summarized in Figures 69-71. The mean gradients improved from  $39.3 \pm 15.8$  mmHg at baseline to  $21.5 \pm 11.3$  mmHg at 30 days. Moderate/severe aortic regurgitation was observed in 54.2% of the patients at baseline, which decreased to 1.5% of the patients at 30 days.



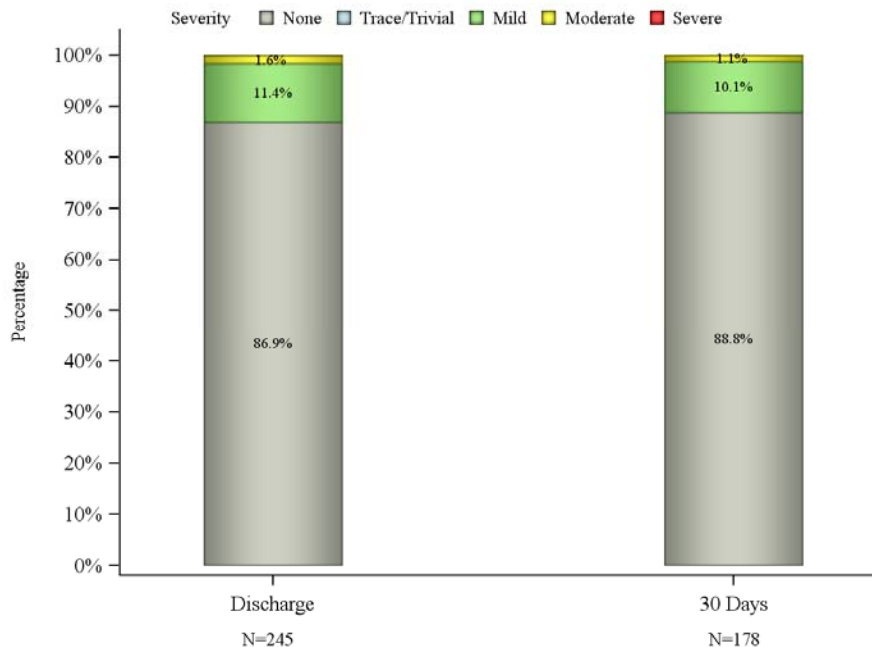
Note: Line plot with mean and standard deviation. The total number of patients at each time point only counted the patients with valid values.

**Figure 70:  
Aortic Regurgitation by Visit - Aortic Valve-in-Valve  
(Valve Implant Population)**



Note: The total number of patients at each time point only counted the patients with valid values.

**Figure 71:  
Paravalvular Regurgitation by Visit - Aortic Valve-in-Valve  
(Valve Implant Population)**

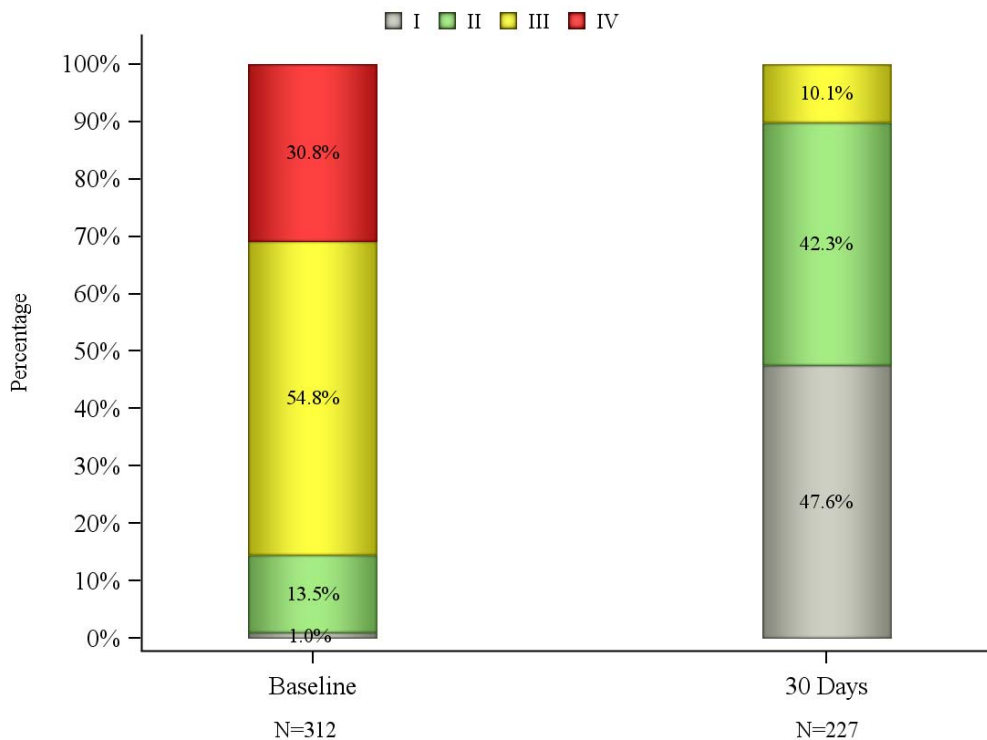


Note: The total number of patients at each time point only counted the patients with valid values.

## NYHA Class

The NYHA class distributions at baseline and the 30-day visit and the NYHA class changes from baseline to the 30-day visit are shown in Figure 72 and Table 68, respectively. The majority (85.4%) of the patients had an improved NYHA class at the 30-day visit.

**Figure 72:**  
**NYHA Functional Class - Aortic Valve-in-Valve**  
**(Valve Implant Population)**



Note: The total number of patients at each time point only counted the patients with valid values.

**Table 68:**  
**NYHA Class Change - Aortic Valve-in-Valve**  
**(Valve Implant Population)**

	NYHA Class Change*		
	Improved	Same	Worsened
Baseline to 30-day visit	193/226 (85.4%)	31/226 (13.7%)	2/226 (0.9%)

\*n/Total no. (%); the total no. only counted the patients with valid values.

## Five-Meter Walk Test

The results of the five-meter walk test are summarized in Table 69.

**Table 69:**  
**Five-Meter Walk Test - Aortic Valve-in-Valve (Valve Implant Population)**

Visit*	Five Meter Walk Time (seconds)†
Baseline	7.6 ± 3.9 (209)
30-day visit	5.9 ± 2.4 (68)
Change from baseline to 30 day visit	-1.4 ± 2.9 (51)

\*There were up to 3 five-meter walk tests for each patient at each visit, and the results were averaged.

†Mean ± SD (Total no.). The total number of patients at each time point only counted the patients with valid values.



## Length of Stay

The mean index hospitalization stay was 4.9 days, which included an average of 1.8 days in the intensive care unit (ICU), as summarized in Table 70.

**Table 70:**  
**Index Hospitalization Stay - Aortic Valve-in-Valve  
(Attempted Implant Population)**

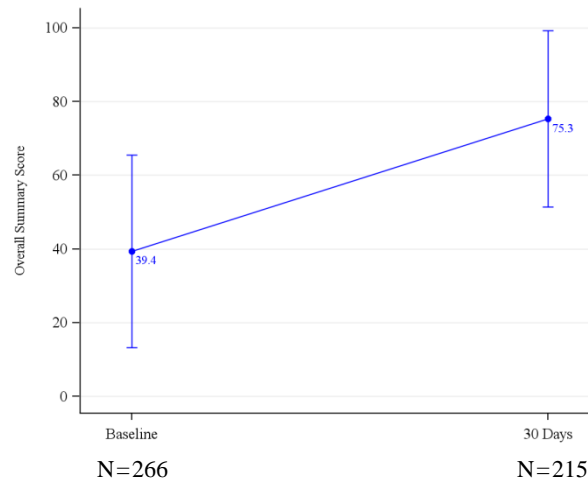
	Length (days)*
Index Hospitalization Stay	4.9 ± 3.9 (314)
Intensive Care Stay	1.8 ± 2.6 (311)

\*Mean ± SD (Total no.).

## Quality of Life (QoL)

The QoL at baseline and 30 days as measured by the KCCQ clinical summary score is shown in Figure 73. The mean KCCQ summary score improved from 39.4 at baseline to 75.3 at 30 days.

**Figure 73:**  
**KCCQ Overall Summary Score - Aortic Valve-in-Valve  
(Valve Implant Population)**



Note: Line plot with mean and standard deviation. The total number of patients at each time point only counted the patients with valid values.

## Procedural Information

The procedure information is presented in Table 71. The most common delivery approach for the aortic valve-in-valve implantation was the transfemoral approach, which was used in 93.0% (292/314) of cases, followed by the transapical approach in 4.1% (13/314) of cases, and other alternative approaches (transaortic, subclavian, and other) in 2.9% (9/314) of cases. There were no aborted procedures or conversions to open heart surgery. The overall device success rate was 88.9% (272/306), which was defined as the following:

- Successful vascular access, delivery, and deployment of the device and successful retrieval of the delivery system, and
- Correct position of the device in the proper anatomical location, and
- Intended performance of the prosthetic heart valve (aortic valve area > 1.2 cm<sup>2</sup> and mean aortic valve gradient < 20 mmHg or peak velocity < 3 m/s, without moderate or severe prosthetic valve regurgitation), and
- Only one valve implanted in the proper anatomical location.

**Table 71:  
Procedural Data Summary - Aortic Valve-in-Valve  
(Attempted Implant Population)**

Procedural Data	Summary Statistics*
Operator Reason for Procedure	
Inoperable/extreme risk	80/313 (25.6%)
High risk	219/313 (70.0%)
Intermediate risk	10/313 (3.2%)
Low risk	4/313 (1.3%)
Implant Approach	
Transfemoral	292/314 (93.0%)
Transapical	13/314 (4.1%)
Transaortic	1/314 (0.3%)
Subclavian/axillary	6/314 (1.9%)
Other†	2/314 (0.6%)
Prior Valve Type	
Bioprosthetic stented	159/308 (51.6%)
Bioprosthetic stentless	79/308 (25.6%)
Procedure Status	
Elective	231/314 (73.6%)
Urgent	74/314 (23.6%)
Emergency	8/314 (2.5%)
Salvage	1/314 (0.3%)
Valve Size	
20 mm	83/314 (26.4%)
23 mm	130/314 (41.4%)
26 mm	57/314 (18.2%)
29 mm	44/314 (14.0%)
Primary Procedure Indication	
Aortic stenosis (Primary)	95/313 (30.4%)
Aortic insufficiency (Primary)	19/313 (6.1%)
Mixed aortic stenosis/aortic insufficiency	10/313 (3.2%)
Failed bioprosthetic valve	189/313 (60.4%)
Cardiopulmonary Bypass (CPB)	
CPB status	
Elective	4/5 (80.0%)
Emergent	1/5 (20.0%)
CPB time (min)	90.5 ± 140.9 (4)
Type of Anesthesia	
General anesthesia	240/314 (76.4%)
Moderate sedation	72/314 (22.9%)
Epidural	0/314 (0.0%)
Combination	2/314 (0.6%)
Total procedure time (min)	110.7 ± 63.0 (314)
Fluoroscopy time (min)	21.2 ± 16.1 (304)
Device success	272/306 (88.9%)
Procedure aborted	0/314 (0.0%)
Conversion to open heart surgery	0/314 (0.0%)

<b>Procedural Data</b>	<b>Summary Statistics*</b>
Mechanical assist device in place at start of procedure	5/313 (1.6%)
Intra-aortic balloon pump (IABP)	2/5 (40.0%)
Catheter based assist device	3/5 (60.0%)

\*Categorical measures – no./Total no. (%); continuous measures - mean ± SD (Total no.). The total no. only counted the patients with valid values at the time point.

†The data collection form was changed in February 2013 to specify non-transfemoral (non-TF), non-transapical (non-TA) approaches rather than “other”; hence, “other” likely included the non-TF and non-TA approaches.

## **Mitral Valve-in-Valve**

### **Safety Endpoints**

The mortality rates at discharge and 30 days and the Kaplan-Meier curve for all-cause mortality for the mitral valve-in-valve cohort are shown in Table 72 and Figure 74, respectively. There were 16 reported deaths in the SAPIEN XT valve patients and 4 in the SAPIEN 3 valve patients at 30 days.

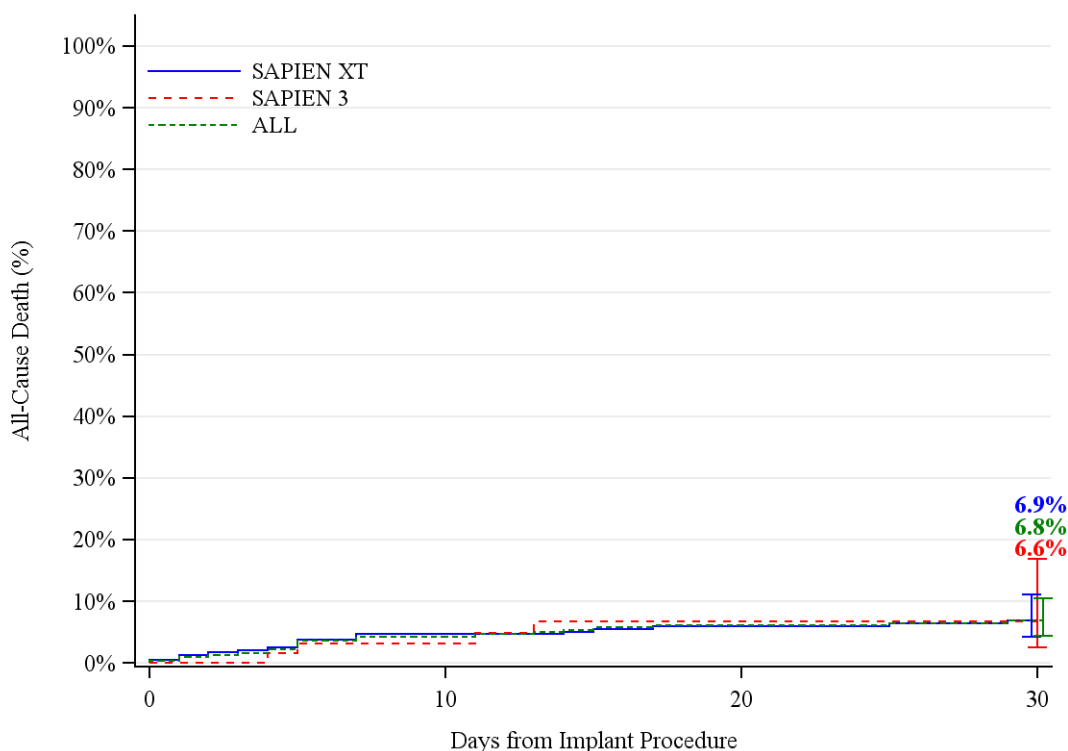
**Table 72:  
Death Rate - Mitral Valve-in-Valve (Attempted Implant Population)**

<b>Event</b>	<b>Discharge*</b>			<b>30 Days†</b>		
	<b>SAPIEN XT</b>	<b>SAPIEN 3</b>	<b>All</b>	<b>SAPIEN XT</b>	<b>SAPIEN 3</b>	<b>All</b>
All-cause death	5.0% (12)	5.7% (4)	5.1% (16)	6.9% (16)	6.6% (4)	6.8% (20)
Cardiac death	3.7% (9)	4.3% (3)	3.9% (12)	4.2% (10)	4.9% (3)	4.3% (13)

\*Observed rate - % (n)

†Kaplan-Meier estimate - % (n)

**Figure 74:  
All-Cause Death Rate - Mitral Valve-in-Valve  
(Attempted Implant Population)**



No. at Risk				
SAPIEN XT	241	216	209	186
SAPIEN 3	70	56	52	45
ALL	311	272	261	231

The DCRI-adjudicated events, including all strokes/TIAs, heart failure readmissions, and mitral valve reinterventions at discharge and 30 days, for the mitral valve-in-valve cohort are shown in Table 73.

**Table 73:  
Duke Clinical Research Institute Adjudicated Events - Mitral Valve-in-Valve  
(Attempted Implant Population)**

Events	Discharge*			30 Day†		
	SAPIEN XT	SAPIEN 3	All	SAPIEN XT	SAPIEN 3	All
All stroke	0.4% (1, 1)	1.4% (1, 1)	0.6% (2, 2)	0.4% (1, 1)	1.5% (1, 1)	0.7% (2, 2)
Ischemic stroke	0.4% (1, 1)	1.4% (1, 1)	0.6% (2, 2)	0.4% (1, 1)	1.5% (1, 1)	0.7% (2, 2)
Hemorrhagic stroke	0.0% (0, 0)	0.0% (0, 0)	0.0% (0, 0)	0.0% (0, 0)	0.0% (0, 0)	0.0% (0, 0)
Transient ischemic attack (TIA)	0.0% (0, 0)	0.0% (0, 0)	0.0% (0, 0)	0.0% (0, 0)	0.0% (0, 0)	0.0% (0, 0)
Readmission - heart failure	N/A	N/A	N/A	1.0% (2, 2)	0.0% (0, 0)	0.8% (2, 2)
Mitral valve reintervention	0.0% (0, 0)	0.0% (0, 0)	0.0% (0, 0)	0.5% (1, 1)	0.0% (0, 0)	0.4% (1, 1)

\*Observed rate - % (no. of events, no. of subjects with the event)

†Kaplan-Meier estimate - % (no. of events, no. of subjects with the event)

#### Site Reported Adverse Events

The site reported adverse events at discharge and 30 days for the mitral valve-in-valve cohort are shown in Table 74.

**Table 74:  
Site Reported Adverse Events - Mitral Valve-in-Valve  
(Attempted Implant Population)**

Events	Discharge*			30 Day†		
	SAPIEN XT	SAPIEN 3	All	SAPIEN XT	SAPIEN 3	All
Other bleed	5.4% (13, 13)	4.3% (3, 3)	5.1% (16, 16)	6.1% (14, 14)	4.4% (3, 3)	5.8% (17, 17)
Readmission - not cardiac	N/A	N/A	N/A	5.8% (12, 12)	0.0% (0, 0)	4.6% (12, 12)
Atrial septal defect closure following transeptal catheterization	4.6% (11, 11)	5.7% (4, 4)	4.8% (15, 15)	4.6% (11, 11)	5.7% (4, 4)	4.9% (15, 15)
Cardiac arrest	4.1% (10, 10)	2.9% (2, 2)	3.9% (12, 12)	4.2% (10, 10)	3.2% (2, 2)	4.0% (12, 12)
Unplanned other cardiac surgery or intervention	3.3% (8, 8)	0.0% (0, 0)	2.6% (8, 8)	3.8% (9, 9)	0.0% (0, 0)	3.0% (9, 9)
Atrial fibrillation	3.3% (8, 8)	1.4% (1, 1)	2.9% (9, 9)	3.4% (8, 8)	1.5% (1, 1)	2.9% (9, 9)
New requirement for dialysis	2.9% (7, 7)	1.4% (1, 1)	2.6% (8, 8)	3.0% (7, 7)	1.6% (1, 1)	2.7% (8, 8)
Bleeding at access site	2.5% (6, 6)	1.4% (1, 1)	2.3% (7, 7)	2.5% (6, 6)	1.4% (1, 1)	2.3% (7, 7)
Unplanned vascular surgery or intervention	2.5% (6, 6)	2.9% (2, 2)	2.6% (8, 8)	2.5% (6, 6)	3.2% (2, 2)	2.6% (8, 8)
Perforation with or w/o tamponade	2.1% (5, 5)	0.0% (0, 0)	1.6% (5, 5)	2.1% (5, 5)	0.0% (0, 0)	1.6% (5, 5)
Hematoma at access site	1.2% (3, 3)	0.0% (0, 0)	1.0% (3, 3)	1.3% (3, 3)	0.0% (0, 0)	1.0% (3, 3)
Minor vascular complication	1.2% (3, 3)	1.4% (1, 1)	1.3% (4, 4)	1.2% (3, 3)	1.7% (1, 1)	1.3% (4, 4)
Transapical related event	1.2% (3, 3)	0.0% (0, 0)	1.0% (3, 3)	1.2% (3, 3)	0.0% (0, 0)	1.0% (3, 3)
Transseptal related event	1.2% (3, 3)	0.0% (0, 0)	1.0% (3, 3)	1.2% (3, 3)	0.0% (0, 0)	1.0% (3, 3)
Gastrointestinal bleed	0.8% (2, 2)	1.4% (1, 1)	1.0% (3, 3)	0.9% (2, 2)	1.4% (1, 1)	1.1% (3, 3)
Major vascular complication	0.8% (2, 2)	0.0% (0, 0)	0.6% (2, 2)	0.8% (2, 2)	0.0% (0, 0)	0.6% (2, 2)
Readmission - cardiac	N/A	N/A	N/A	0.9% (2, 2)	0.0% (0, 0)	0.8% (2, 2)
Device embolization	0.0% (0, 0)	0.0% (0, 0)	0.0% (0, 0)	0.5% (1, 1)	0.0% (0, 0)	0.4% (1, 1)
Device migration	0.0% (0, 0)	1.4% (1, 1)	0.3% (1, 1)	0.5% (1, 1)	1.4% (1, 1)	0.7% (2, 2)
Device recapture or retrieval	0.0% (0, 0)	1.4% (1, 1)	0.3% (1, 1)	0.5% (1, 1)	1.4% (1, 1)	0.7% (2, 2)
Genitourinary bleed	0.4% (1, 1)	0.0% (0, 0)	0.3% (1, 1)	0.4% (1, 1)	0.0% (0, 0)	0.3% (1, 1)
Major bleeding event	N/A	N/A	N/A	0.5% (1, 1)	0.0% (0, 0)	0.4% (1, 1)
Non-valve related readmission	N/A	N/A	N/A	0.5% (1, 1)	0.0% (0, 0)	0.4% (1, 1)
Conduction/native pacer disturbance requiring pacer	0.0% (0, 0)	1.4% (1, 1)	0.3% (1, 1)	0.0% (0, 0)	1.5% (1, 1)	0.3% (1, 1)

Events	Discharge*			30 Day†		
	SAPIEN XT	SAPIEN 3	All	SAPIEN XT	SAPIEN 3	All
Device thrombosis	0.0% (0, 0)	0.0% (0, 0)	0.0% (0, 0)	0.0% (0, 0)	0.0% (0, 0)	0.0% (0, 0)
Endocarditis	0.0% (0, 0)	0.0% (0, 0)	0.0% (0, 0)	0.0% (0, 0)	0.0% (0, 0)	0.0% (0, 0)
Life threatening bleeding	N/A	N/A	N/A	0.0% (0, 0)	0.0% (0, 0)	0.0% (0, 0)
Myocardial infarction	0.0% (0, 0)	1.4% (1, 1)	0.3% (1, 1)	0.0% (0, 0)	1.4% (1, 1)	0.3% (1, 1)
Other device related event	0.0% (0, 0)	1.4% (1, 1)	0.3% (1, 1)	0.0% (0, 0)	1.4% (1, 1)	0.3% (1, 1)
Transient ischemic attack	0.4% (1, 1)	0.0% (0, 0)	0.3% (1, 1)	0.4% (1, 1)	0.0% (0, 0)	0.3% (1, 1)
Ischemic stroke	0.4% (1, 1)	1.4% (1, 1)	0.6% (2, 2)	0.4% (1, 1)	1.5% (1, 1)	0.7% (2, 2)
Readmission - heart failure	N/A	N/A	N/A	1.0% (2, 2)	3.8% (2, 2)	1.6% (4, 4)

\*Observed rate - % (no. of events, no. of subjects with the event)

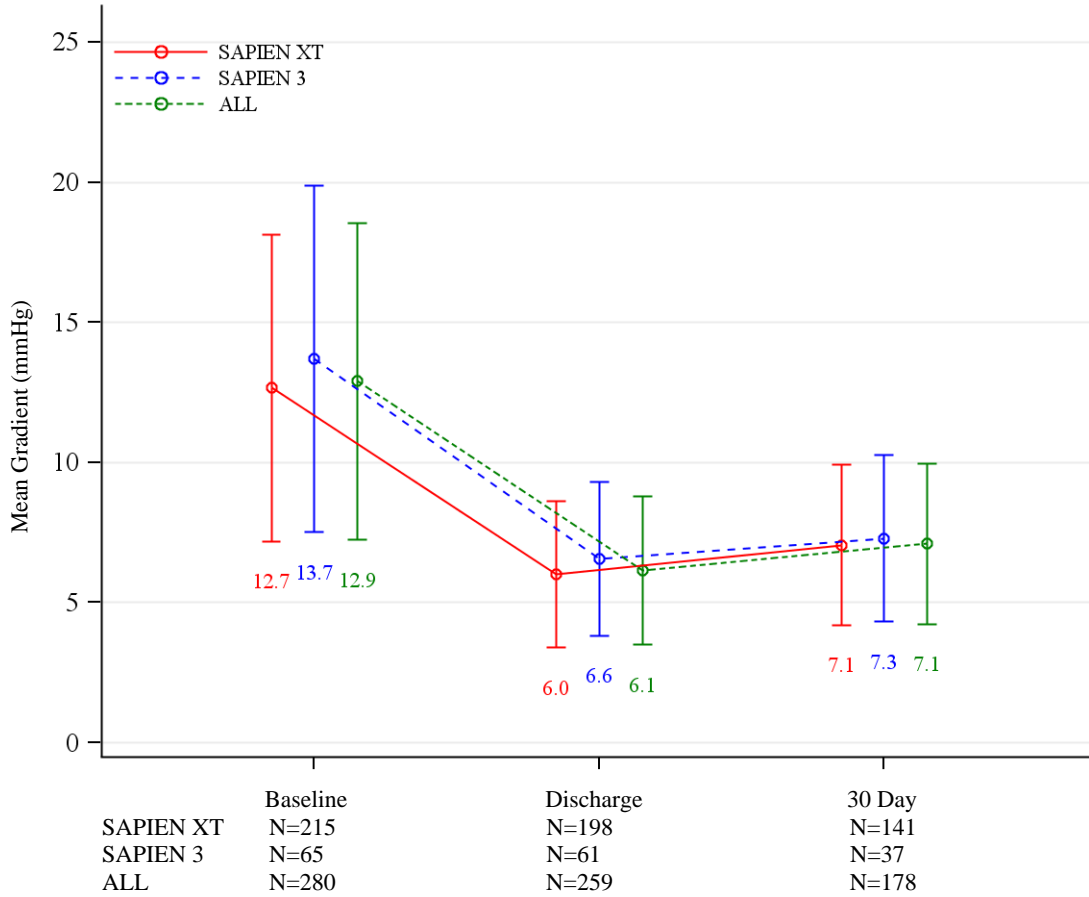
†Kaplan-Meier estimate - % (no. of events, no. of subjects with the event)

## Effectiveness Endpoints

### Valve Performance

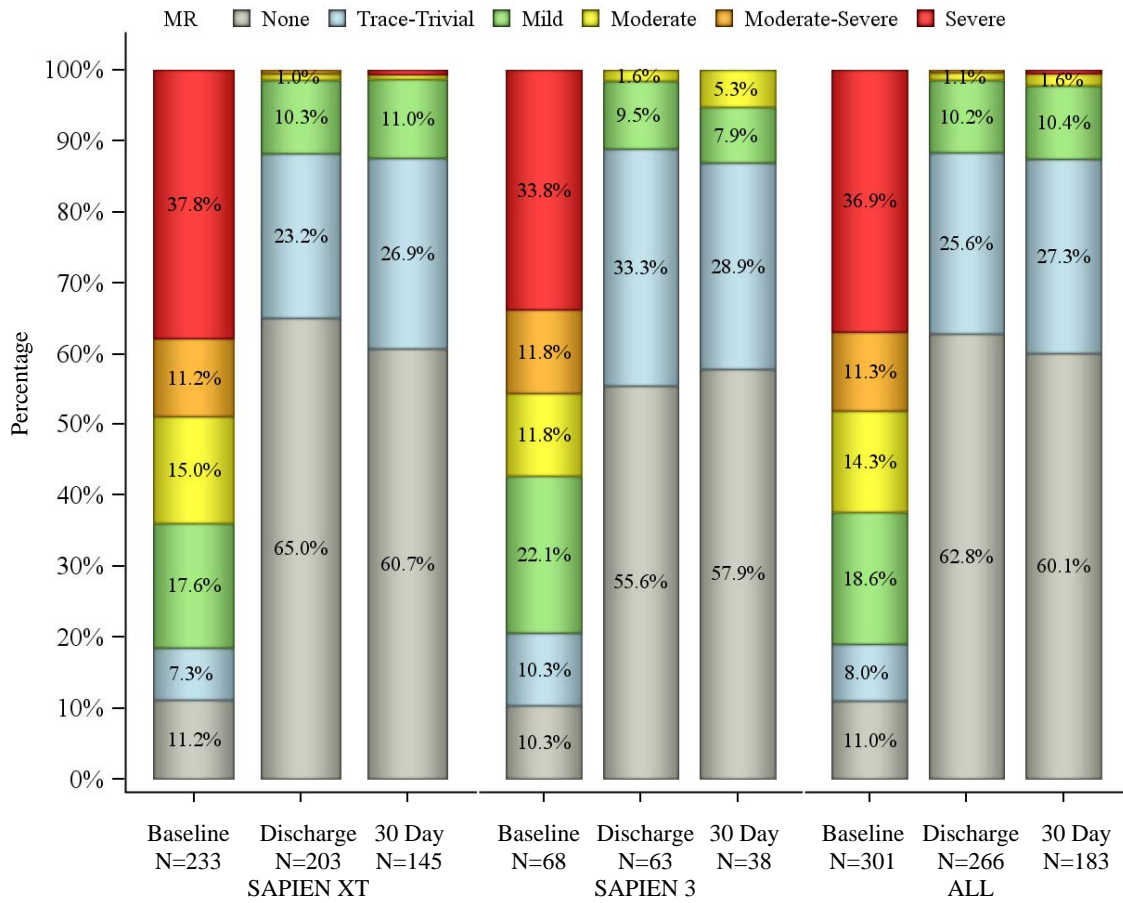
The mitral valve-in-valve echocardiographic performance data are summarized in Figures 75-77. The mean gradients improved from 12.9 mmHg at baseline to 7.1 mmHg at 30 days. Moderate/severe mitral regurgitation was observed in 62.5% of the patients at baseline, which decreased to 2.2% of the patients at 30 days.

**Figure 75:**  
**Mean Gradient by Visit - Mitral Valve-in-Valve**  
**(Valve Implant Population)**



Note: Line plot with mean and standard deviation. The total number of patients at each time point only counted the patients with valid values.

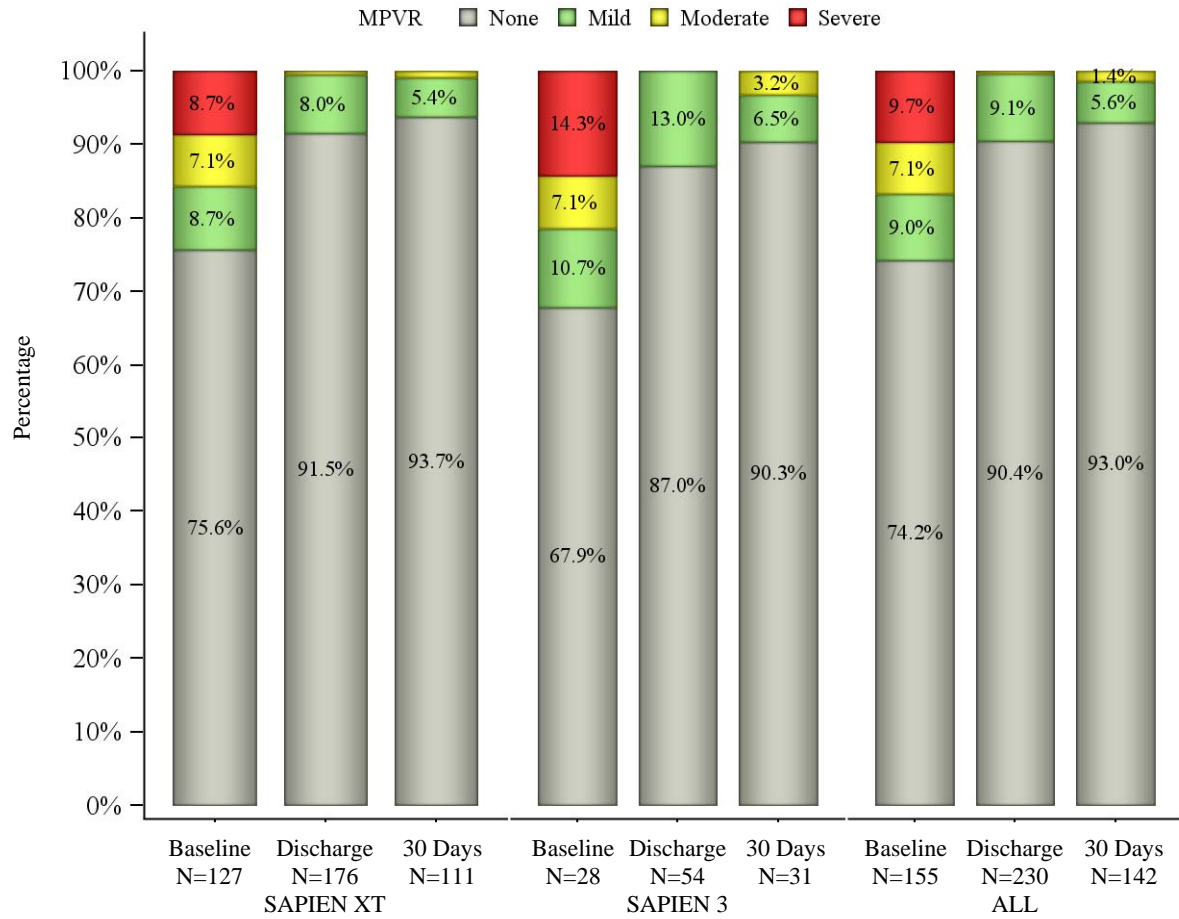
**Figure 76:  
Mitral Regurgitation by Visit - Mitral Valve-in-Valve  
(Valve Implant Population)**



Note: Values that are < 1.0% are not labeled in the bar chart. The total number of patients at each time point only counted the patients with valid values.



**Figure 77:  
Paravalvular Regurgitation by Visit - Mitral Valve-in-Valve  
(Valve Implant Population)**

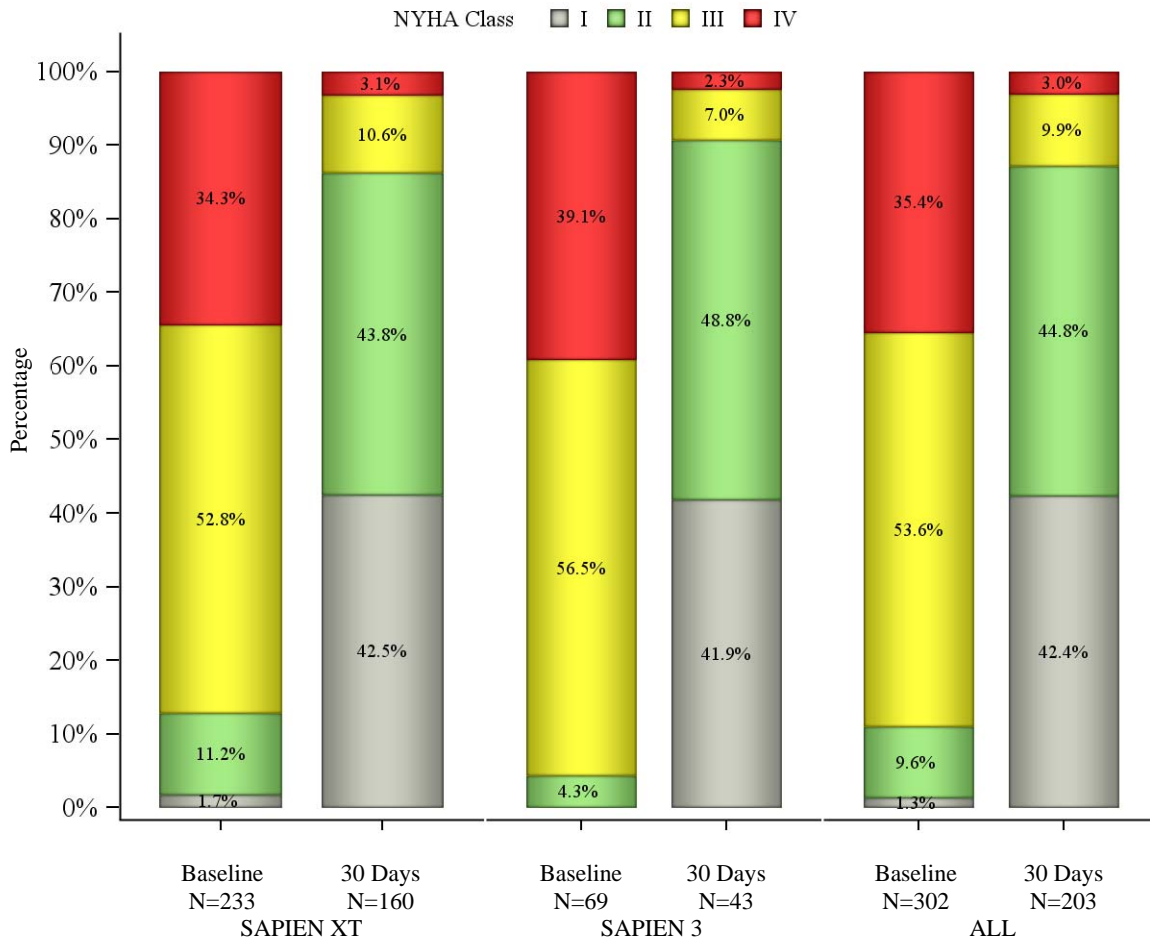


Note: Values that are < 1.0% are not labeled in the bar chart. The total number of patients at each time point only counted the patients with valid values.

## NYHA Class

The NYHA class distributions at baseline and the 30-day visit and the NYHA class changes from baseline to the 30-day visit are shown in Figure 78 and Table 75, respectively. The majority (85.6%) of the patients had an improved NYHA class at the 30-day visit.

**Figure 78:**  
**NYHA Functional Class - Mitral Valve-in-Valve**  
**(Valve Implant Population)**



Note: The total number of patients at each time point only counted the patients with valid values.

**Table 75:  
NYHA Class Change - Mitral Valve-in-Valve  
(Valve Implant Population)**

		NYHA Class Change*		
		Improved	Same	Worsened
Baseline to 30-day visit	SAPIEN XT	133/159 (83.6%)	24/159 (15.1%)	2/159 (1.3%)
	SAPIEN 3	40/43 (93.0%)	3/43 (7.0%)	0/43 (0.0%)
	All	173/202 (85.6%)	27/202 (13.4%)	2/202 (1.0%)

\*n/Total no. (%); the total no. only counted the patients with valid values.

### Six-Minute Walk Test (6MWT)

The results of the 6MWT are summarized in Table 76.

**Table 76:  
Six-Minute Walk Test - Mitral Valve-in-Valve (Valve Implant Population)**

Visit	6-Minute Walk Distance (feet)*		
	SAPIEN XT	SAPIEN 3	All
Baseline	240.5 ± 366.2 (77)	375.6 ± 370.4 (32)	280.2 ± 370.9 (109)
30-day visit	768.7 ± 480.6 (34)	977.5 ± 597.4 (8)	808.5 ± 503.7 (42)
Change from baseline to 30 days	479.0 ± 471.3 (20)	457.6 ± 348.1 (5)	474.7 ± 442.9 (25)

\*Mean ± SD (Total no.). The total number of patients at each time point only counted the patients with valid values. The 6-minute walk distance was counted as 0 for the 6-minute walk tests not performed due to cardiac reasons.

### Length of Stay

The mean index hospitalization stay was 8.5 days, which included an average of 3.4 days in the intensive care unit (ICU), as summarized in Table 77.

**Table 77:  
Index Hospitalization Stay - Mitral Valve-in-Valve  
(Attempted Implant Population)**

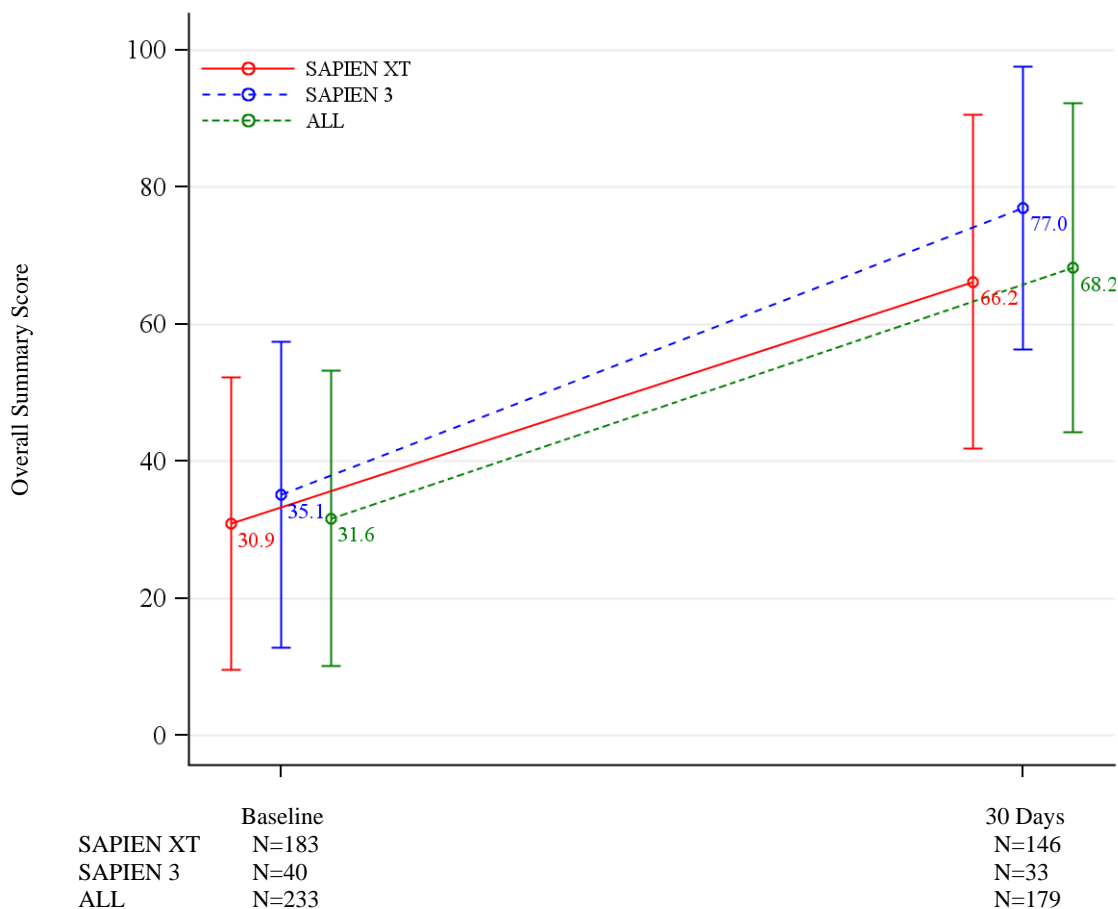
	Length (days)*		
	SAPIEN XT	SAPIEN 3	All
Index hospitalization stay	8.8 ± 7.1 (241)	7.6 ± 7.4 (70)	8.5 ± 7.1 (311)
Intensive care stay	3.3 ± 4.8 (234)	3.7 ± 7.1 (63)	3.4 ± 5.3 (297)

\*Mean ± SD (Total no.).

### Quality of Life (QoL)

The KCCQ clinical summary scores at baseline and 30 days are shown in Figure 79. The mean KCCQ summary score improved from 31.6 at baseline to 68.2 at 30 days.

**Figure 79:**  
**KCCQ Overall Summary Score - Mitral Valve-in-Valve (Valve Implant Population)**



Note: Line plot with mean and standard deviation. The total number of patients at each time point only counted the patients with valid values.

### Procedural Information

The procedural information is presented in Table 78. The most common delivery approach for the mitral valve-in-valve implantation was the transapical approach, which was used in 65.3% (203 of 311) of cases, followed by the transseptal approach in 27.0% (84 of 311) of cases, the transfemoral approach in 6.1% (19/311) of cases, and other alternative approaches in 1.6% (5 of 311) of cases. The procedures were considered elective in 71.0% (220/310) of cases, urgent in 27.7% (86/310) of cases, and emergent or salvage in 1.3% (4/310) of cases. Two (2) cases were aborted and 5 were converted to open heart surgery. Overall, the device was implanted successfully in 97.4% (303/311) of the cases, which was defined as correct positioning of a single prosthetic heart valve in the proper anatomical location.

**Table 78:  
Procedural Data Summary - Mitral Valve-in-Valve  
(Attempted Implant Population)**

Procedural Data	Summary Statistics*		
	SAPIEN XT	SAPIEN 3	All
Operator reason for procedure			
Inoperable/extreme risk	96/241 (39.8%)	11/69 (15.9%)	107/310 (34.5%)
High risk	141/241 (58.5%)	52/69 (75.4%)	193/310 (62.3%)
Intermediate risk	4/241 (1.7%)	5/69 (7.2%)	9/310 (2.9%)
Low risk	0/241 (0.0%)	1/69 (1.4%)	1/310 (0.3%)
Implant approach			
Transapical	192/241 (79.7%)	11/70 (15.7%)	203/311 (65.3%)
Transseptal	43/241 (17.8%)	41/70 (58.6%)	84/311 (27.0%)
Femoral artery	4/241 (1.7%)	15/70 (21.4%)	19/311 (6.1%)
Other	2/241 (0.8%)	3/70 (4.3%)	5/311 (1.6%)
Prior valve type			
Bioprosthetic stented	143/180 (79.4%)	35/41 (85.4%)	178/221 (80.5%)
Bioprosthetic stentless	37/180 (20.6%)	6/41 (14.6%)	43/221 (19.5%)
Procedure status			
Elective	173/241 (71.8%)	47/69 (68.1%)	220/310 (71.0%)
Urgent	64/241 (26.6%)	22/69 (31.9%)	86/310 (27.7%)
Emergency	2/241 (0.8%)	0/69 (0.0%)	2/310 (0.6%)
Salvage	2/241 (0.8%)	0/69 (0.0%)	2/310 (0.6%)
Valve size			
23 mm	22/241 (9.1%)	5/70 (7.1%)	27/311 (8.7%)
26 mm	93/241 (38.6%)	24/70 (34.3%)	117/311 (37.6%)
29 mm	126/241 (52.3%)	41/70 (58.6%)	167/311 (53.7%)
Cardiopulmonary bypass	25/241 (10.4%)	2/69 (2.9%)	27/310 (8.7%)
Status of CP Bypass			
Elective	20/25 (80.0%)	0/2 (0.0%)	20/27 (74.1%)
Emergent	5/25 (20.0%)	2/2 (100.0%)	7/27 (25.9%)
CP Bypass Time (min)	38.3 ± 51.2 (24)	148.0 ± 157.0 (2)	46.7 ± 65.4 (26)
Type of anesthesia			
General anesthesia	240/241 (99.6%)	68/69 (98.6%)	308/310 (99.4%)
Moderate sedation	0/241 (0.0%)	1/69 (1.4%)	1/310 (0.3%)
Epidural	0/241 (0.0%)	0/69 (0.0%)	0/310 (0.0%)
Combination	1/241 (0.4%)	0/69 (0.0%)	1/310 (0.3%)
Total procedure time (min)	143.6 ± 60.4 (240)	157.7 ± 107.2 (69)	146.7 ± 73.5 (309)
Fluoroscopy time (min)	23.9 ± 20.7 (223)	36.9 ± 27.3 (63)	26.8 ± 22.9 (286)
Device implanted successfully	234/241 (97.1%)	69/70 (98.6%)	303/311 (97.4%)
Procedure aborted	1/241 (0.4%)	1/70 (1.4%)	2/311 (0.6%)
Procedure aborted reason			
Navigation issue after successful access	1/1 (100.0%)	0/1 (0.0%)	1/2 (50.0%)
Other	0/1 (0.0%)	1/1 (100.0%)	1/2 (50.0%)
Procedure aborted action			
Conversion to open heart surgery	0/1 (0.0%)	1/1 (100.0%)	1/2 (50.0%)
Other	1/1 (100.0%)	0/1 (0.0%)	1/2 (50.0%)

Procedural Data	Summary Statistics*		
	SAPIEN XT	SAPIEN 3	All
Conversion to open heart surgery	4/241 (1.7%)	1/70 (1.4%)	5/311 (1.6%)
Tamponade/bleeding in the heart	4/4 (100.0%)	0/1 (0.0%)	4/5 (80.0%)
Other	0/4 (0.0%)	1/1 (100.0%)	1/5 (20.0%)
Mechanical assist device in place at start of procedure	9/241 (3.7%)	4/70 (5.7%)	13/311 (4.2%)
IABP	7/9 (77.8%)	3/4 (75.0%)	10/13 (76.9%)
Catheter-based assist device	2/9 (22.2%)	1/4 (25.0%)	3/13 (23.1%)

\*Categorical measures – no./Total no. (%); continuous measures - mean ± SD (Total no.). The total no. only counted the patients with valid values at the time point.

### **SAPIEN 3 and SAPIEN 3 Ultra THV THV-in-THV – STS/ACC Transcatheter Valve Therapy Registry (TVTR) Analysis**

#### Accountability of PMA Cohorts

At the time of database extract, 242 of the 263 patients were eligible for the 30-day visit and 216 (89.3%) completed the visit within the 30-day follow-up window, defined as the period between 21 days post-procedure and 75 days post-procedure. At 1 year, 200 patients were eligible for the 1-year visit and 136 (68.0%) completed the visit within the follow-up window, defined as the period between 305 days post-procedure and 425 days post-procedure. A detailed summary of the patient accountability at 30 days and 1 year is shown in Table 79.

**Table 79:  
Patient Visit Accountability (AI Population)**

	30-day Visit	1-year Visit
Total patients	263	263
Non-eligible	21	63
Death	19	47
Withdrawal	1	3
Lost to follow-up	1	13
Eligible	242	200
Follow-up visit completed	89.3% (216)	68.0% (136)
Missed visit	10.7% (26)	32.0% (64)

The “Attempted Implant” population consisted of all patients for whom the first vascular access was attempted. The “Valve Implant” population consisted of those patients for whom the valve implant procedure has started and a “No” was indicated for both ‘procedure aborted’ and “conversion to open heart surgery”. The number of patients in the analysis population is shown in Table 80.

**Table 80: Analysis Populations**

Analysis Population	Number of Patients
Attempted Implant Population	263
Valve Implant Population	261

## **Study Population Demographics and Baseline Characteristics**

The demographics and baseline characteristics of the patients, as shown in Table 81, present an elderly, multimorbid cohort of patients, consistent with the high operative risk of the populations.

**Table 81: Patient Demographics and Baseline Characteristics (AI Population)**

<b>Demographics and Baseline Characteristics</b>	<b>Summary Statistics* (N = 263)</b>
Age - years	78.9 ± 10.5
Male sex	55.1% (145/263)
Society of Thoracic Surgeons (STS) score	10.2 ± 8.6 (242)
New York Heart Association (NYHA) class	
I/II	12.3% (32/261)
III/IV	87.7% (229/261)
Previous myocardial infarction	26.6% (70/263)
Previous intervention	
Coronary artery bypass grafting (CABG)	28.1% (74/263)
Percutaneous coronary intervention (PCI)	34.0% (89/262)
Prior aortic valvuloplasty	13.7% (36/263)
Stroke or Cerebrovascular accident (CVA)	18.3% (48/263)
Peripheral vascular disease (PVD)	32.1% (84/262)
Atrial fibrillation/flutter	48.7% (128/263)
Permanent pacemaker	32.2% (84/261)
Porcelain aorta	8.0% (21/262)
Hostile chest	8.7% (23/263)
Echocardiographic findings (Valve Implant Population)	
Valve area (cm <sup>2</sup> )	1.0 ± 0.5 (115)
Mean gradient (mmHg)	29.4 ± 19.0 (135)
Mean left ventricular ejection fraction (LVEF), %	49.3 ± 15.1 (257)
Moderate or severe aortic regurgitation	79.3% (207/261)
Moderate or severe mitral regurgitation	42.1% (98/233)

\*Continuous measures - Mean ± SD (Total no.); Categorical measures – % (no./Total no.)

## **Safety and Effectiveness Results**

### **Safety Endpoints**

The Kaplan-Meier estimates of site-reported adverse events through 1 year are presented in Table 82. The Kaplan-Meier curve for all-cause mortality is shown in Figure 80. The all-cause mortality rate was 5.8% at 30 days and 18.2% at 1 year, including a cardiovascular death rate of 2.7% at 30 days and 5.4% at 1 year. Other relatively more frequent adverse events included conduction/native pacer disturbance requiring pacer (8.2% at 30 days and 10.6% at 1 year) and valve-related readmission (4.3% at 30 days and 8.6% at 1 year).

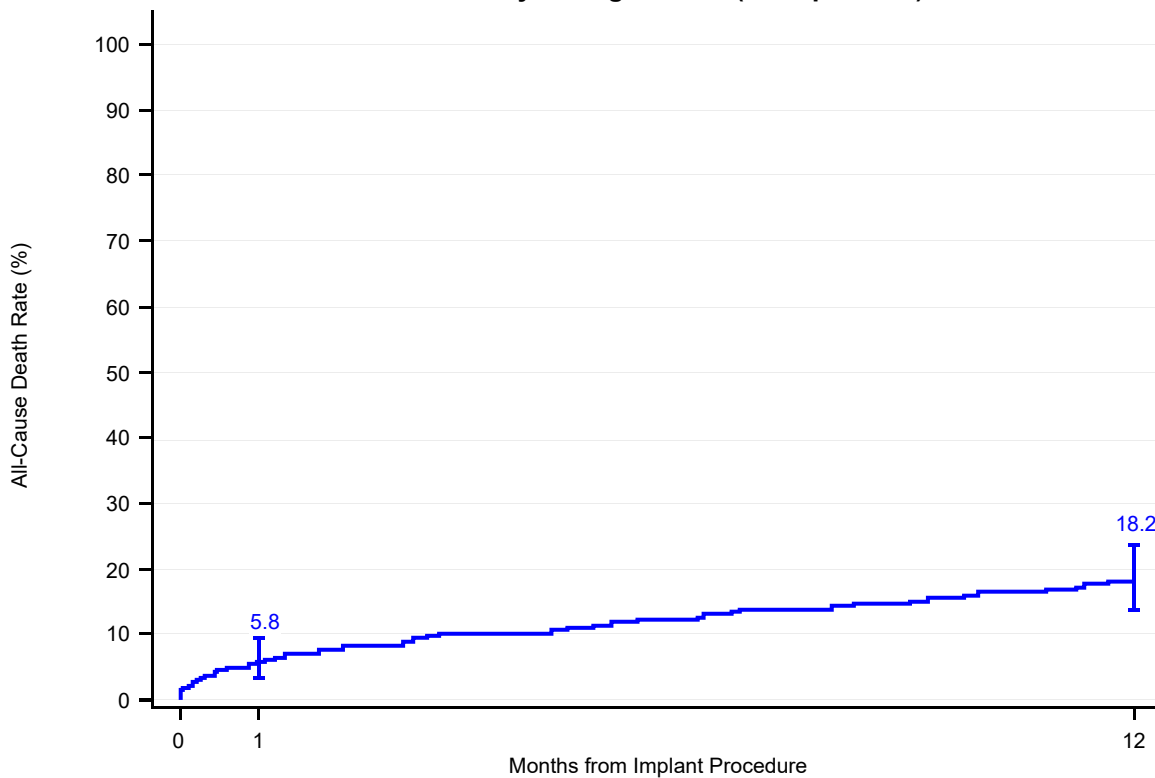
**Table 82: Site Reported Adverse Events (AI Population)**

Adverse Event	Kaplan-Meier Rate*	
	30 Days (N=263)	1 Year (N=263)
All-cause death	5.8% (15, 15)	18.2% (45, 45)
Cardiovascular death	2.7% (7, 7)	5.4% (13, 13)
All stroke	2.3% (6, 6)	2.8% (7, 7)
Ischemic stroke	1.9% (5, 5)	2.4% (6, 6)
Undetermined stroke	0.4% (1, 1)	0.4% (1, 1)
Transient ischemic attack (TIA)	0.8% (2, 2)	1.9% (4, 4)
Major vascular complication	0.4% (1, 1)	1.0% (2, 2)
Major bleeding	1.2% (3, 3)	2.5% (7, 5)
Myocardial infarction	0.8% (3, 2)	3.1% (6, 5)
New requirement for dialysis	0.4% (1, 1)	1.6% (3, 3)
Conduction/native pacemaker disturbance requiring pacemaker	8.2% (21, 21)	10.6% (25, 25)
Conduction/native pacemaker disturbance requiring implantable cardioverter defibrillator (ICD)	0.4% (1, 1)	2.2% (4, 4)
Aortic valve re-intervention	0.4% (1, 1)	1.2% (2, 2)
Unplanned other cardiac surgery or intervention	2.4% (6, 6)	4.5% (9, 9)
Unplanned vascular surgery or intervention	1.5% (4, 4)	2.6% (6, 6)
Device thrombosis	0.4% (1, 1)	1.0% (2, 2)
Valve-related readmission	4.3% (11, 11)	8.6% (22, 18)

\*Kaplan-Meier rate - (no. of events, no. of patients with the event).



**Figure 80:  
All-Cause Mortality through 1 Year (AI Population)**



No. at Risk 263 241

177

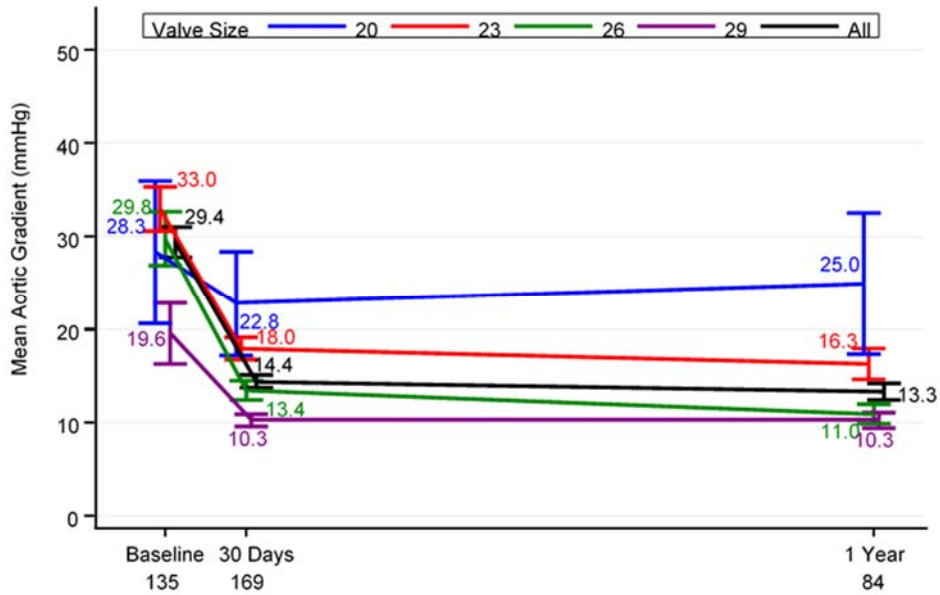
**Note:** The 95% confidence intervals were calculated without multiplicity adjustment. The adjusted confidence intervals could be wider than presented here. As such, confidence intervals are provided to illustrate the variability only and should not be used to draw any statistical conclusion.

### Effectiveness Endpoints

#### Valve Performance

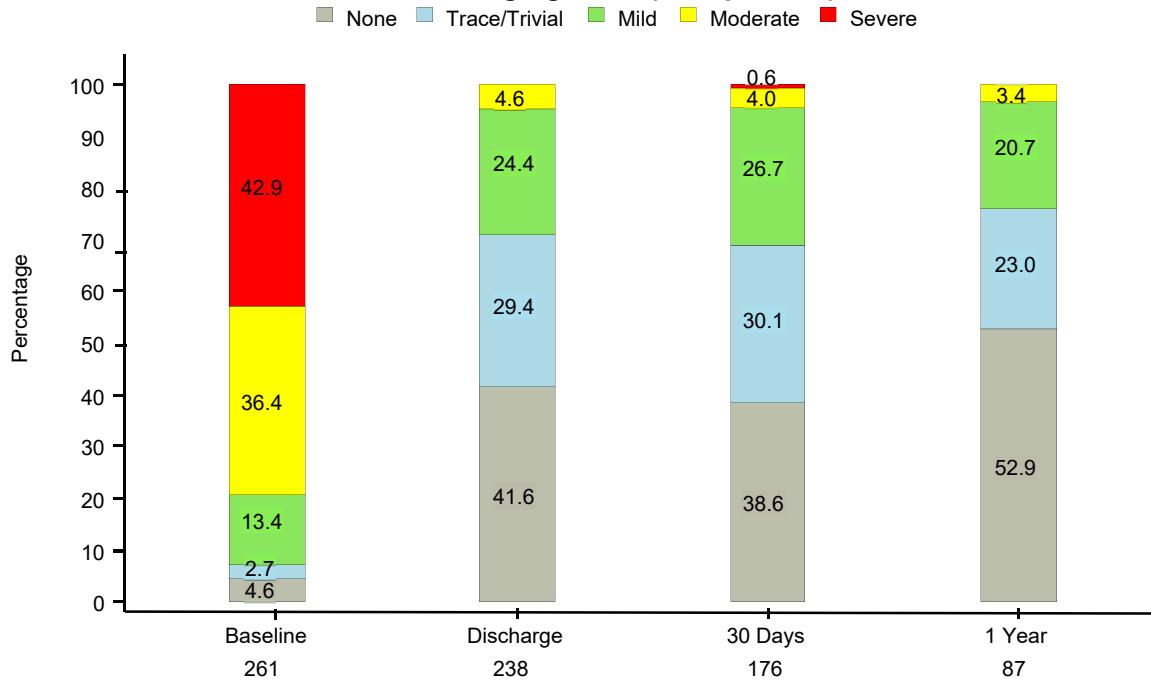
The echocardiographic valve performance results are shown in Figures 81-83. The decrease in gradients were sustained through 1 year. The mean aortic gradient decreased from 29.4 mmHg at baseline to 14.4 mmHg at 30 days, which was maintained through 1 year (13.3 mmHg). Moderate or severe total aortic regurgitation was observed in 79.3% of the patients at baseline, which decreased to 4.6% at 30 days and 3.4% at 1 year. The proportion of patients with  $\geq$  moderate paravalvular regurgitation was 4.5% at 30 days and 2.6% at 1 year.

**Figure 81:**  
**Mean Aortic Gradient (VI Population)**

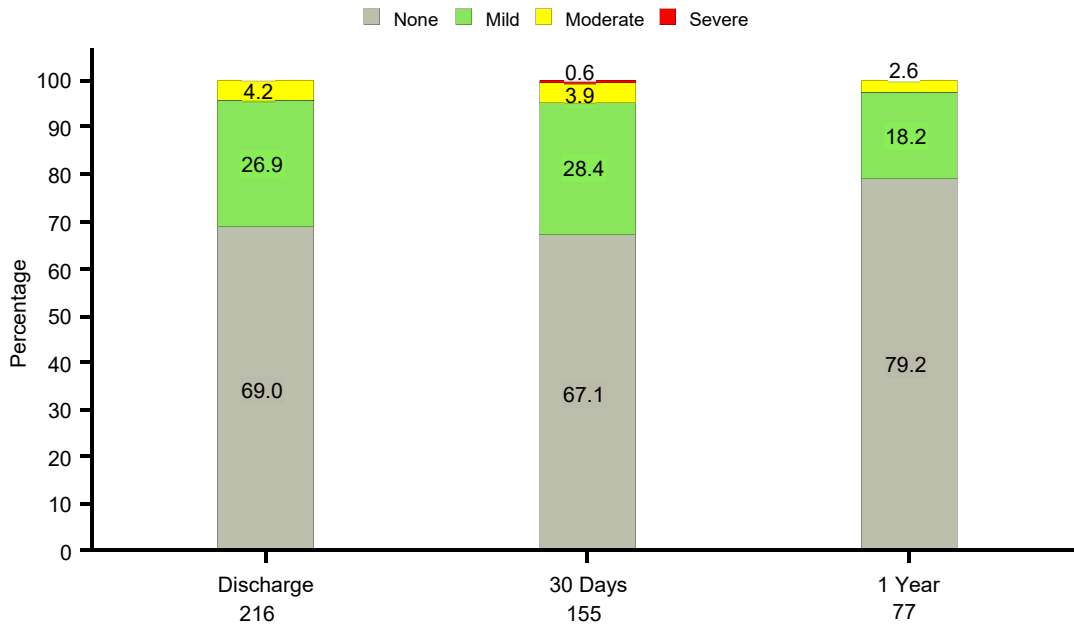


**Note:** Line plot with mean and standard error. The total number of patients at each visit time point only counted the patients with valid values.

**Figure 82:**  
**Total Aortic Regurgitation (VI Population)**

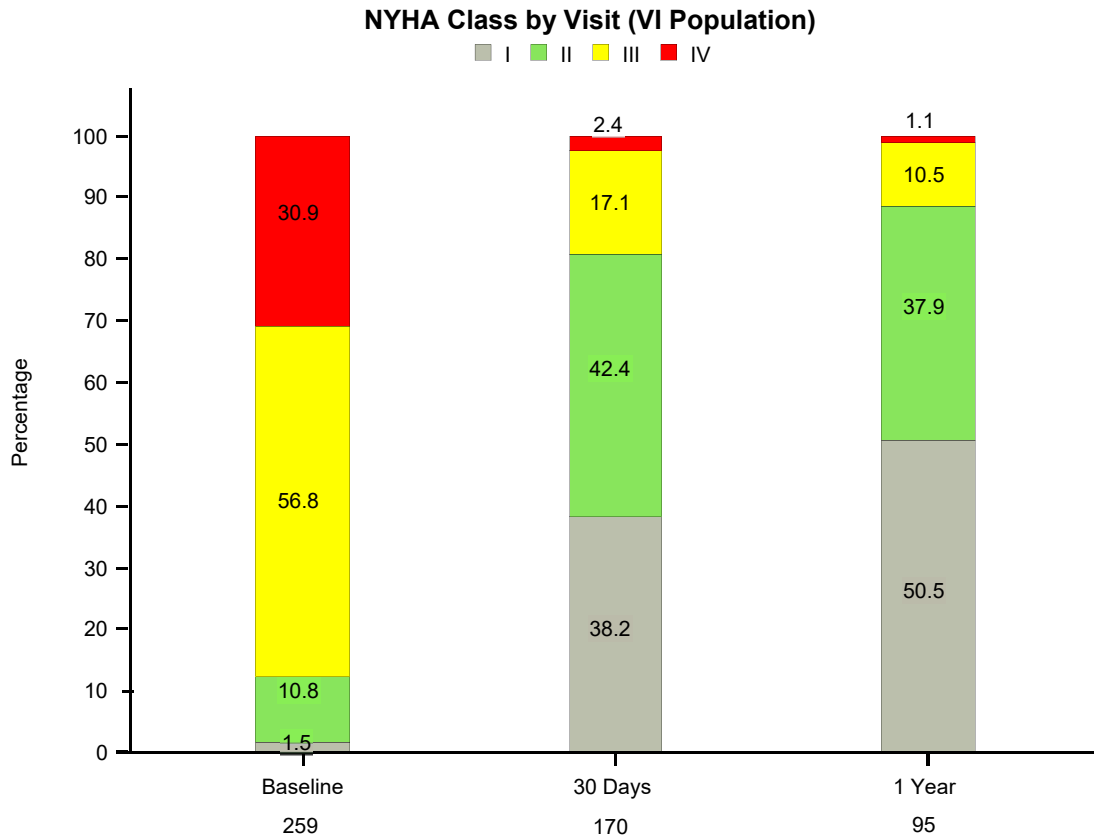


**Figure 83:  
Paravalvular Regurgitation (VI Population)**



**NYHA Functional Class**

The NYHA functional class distributions by visit are presented in Figure 84. At baseline, 87.7% of patients were in NYHA III/IV. At 1 year, the majority (88.4%) of patients were in NYHA I/II.



Length of Stay

The mean index hospitalization stay was 4.9 days, which included an average of 1.7 days in the intensive care unit (ICU), as summarized in Table 83.

**Table 83:**  
**Index Hospitalization (AI Population)**

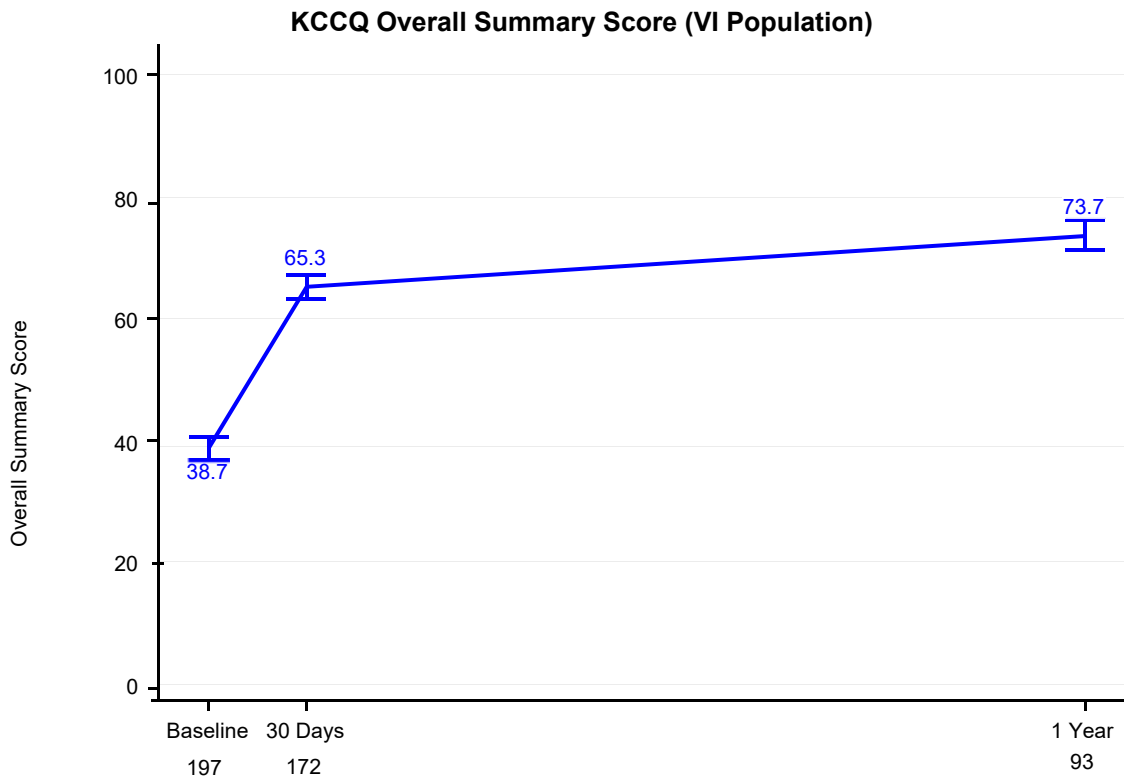
	Length of Stay (days)*
Index hospitalization duration	4.9 ± 0.3 (263)
Intensive care stay	1.7 ± 0.2 (255)

\*Mean ± SE (Total no.).

Quality of Life

The results for the KCCQ overall summary score are presented in Figure 85. The mean score increased from 38.7 at baseline to 65.3 and 73.7 at 30 days and 1 year, respectively.

**Figure 85:**



**Note:** Line plot with mean and standard error. The total number of patients at each time point only counted patients with valid values.

### Other Study Observations

#### Procedural Information

The procedural information is summarized in Table 84. General anesthesia was used in the majority (70%) of patients. Conversion to open heart surgery occurred in two patients due to ventricular rupture and annulus rupture, respectively.

**Table 84:  
Procedural Data Summary (AI Population)**

Procedural Data	Summary Statistics*
Operator reason for procedure	
Inoperable/extreme risk	20.8% (54/259)
High risk	69.1% (179/259)
Intermediate risk	9.7% (25/259)
Low risk	0.4% (1/259)
Implant approach	
Transfemoral	95.8% (252/263)
Transapical	1.1% (3/263)
Transaortic	0.8% (2/263)
Subclavian/axillary	0.8% (2/263)
Transseptal	0.4% (1/263)
Transcarotid	1.1% (3/263)
Valve size	

Procedural Data	Summary Statistics*
20 mm	2.3% (6/263)
23 mm	35.0% (92/263)
26 mm	30.8% (81/263)
29 mm	31.9% (84/263)
Cardiopulmonary bypass	0.4% (1/263)
Cardiopulmonary bypass status	
Emergent	100.0% (1/1)
Cardiopulmonary bypass time, minutes	254.0 ± NA (1)
Type of anesthesia	
General anesthesia	70.0% (184/263)
Moderate sedation	29.7% (78/263)
Combination	0.4% (1/263)
Total procedure time, minutes	108.5 ± 4.3 (263)
Device implanted successfully	98.9% (260/263)
Procedure aborted	0.0% (0/263)
Conversion to open heart surgery	0.8% (2/263)
Ventricular rupture	1
Annulus rupture	1
Mechanical assist device in place at start of procedure	0.4% (1/263)
Catheter-based assist device	100.0% (1/1)

\*Continuous measures - mean ± SE (n); categorical measures - % (no./Total no.)

### **SAPIEN 3 Ultra System**

#### **Patient Accountability**

At the time of the database extract, all 40 patients enrolled were implanted, discharged and completed 30 day follow-up.

Patient Demographics and Baseline Characteristics

The demographics and baseline characteristics are shown in Table 85.

**Table 85:  
Patient Demographics and Baseline Characteristics**

Demographics and Baseline Characteristic	Summary Statistics
Age - years	83.4 ± 5.13 (40)
Male sex	24/40 (60.0%)
Society of Thoracic Surgeons (STS) score	3.4 ± 1.27 (40)
New York Heart Association (NYHA) class	
I/II	20/40 (50.0%)
III/IV	20/40 (50.0%)
Previous myocardial infarction	1/40 (2.5%)
Previous intervention	9/40 (22.5%)
Coronary artery bypass grafting (CABG)	3/40 (7.5%)
Percutaneous bypass intervention (PCI)	8/40 (20.0%)
Prior aortic valvuloplasty	0/40 (0.0%)

Demographics and Baseline Characteristic	Summary Statistics
Cerebrovascular accident (CVA)	1/40 (2.5%)
Peripheral vascular disease	4/40 (10.0%)
Atrial fibrillation	19/40 (47.5%)
Prior pacemaker	5/40 (12.5%)
Porcelain aorta	0/40 (0.0%)
Echocardiographic findings	
Valve area - cm <sup>2</sup>	0.7 ± 0.16 (40)
Mean aortic-valve gradient -mmHg	51.0 ± 13.17 (40)
Mean left ventricular ejection fraction (LVEF) %	60.6 ± 7.06 (40)
Moderate or severe aortic regurgitation	1/39 (2.6%)
*Continuous measures—Mean ± SD (Total no.); Categorical measures—n./Total no. (%)	

## **Safety and Effectiveness Results**

### **Primary Endpoint**

The primary endpoint was procedural success, defined as freedom from mortality, conversion to surgery, and moderate or severe PVR at exit from the procedure room which was achieved in all subjects as outlined in Table 86.

**Table 86:  
Primary Endpoint Analysis.**

Primary Endpoint	Results
Overall procedural success	40/40 (100.0%)
Freedom from mortality at exit from procedure room	40/40 (100.0%)
Freedom from conversion to surgery at exit from procedure room	40/40 (100.0%)
Freedom from moderate or severe paravalvular regurgitation at exit from procedure room	40/40 (100.0%)

### **Secondary Endpoints**

There were no major vascular complications, valve migrations, or embolizations through discharge.

### **Adverse Events**

There were no deaths or strokes through 30-days. The selected adverse events for the treated population are presented in Table 87.

**Table 87:  
Selected Adverse Events**

Adverse Event	Discharge*	30 Days <sup>†</sup>
Major vascular complications	0.0% (0,0)	0.0% (0,0)
Acute kidney injury (Stage III)	0.0% (0,0)	0.0% (0,0)
Life threatening bleeding	0.0% (0,0)	0.0% (0,0)
Major bleeding	5.0% (2,2)	5.0% (2,2)
Hematoma	5.0% (2,2)	5.0% (2,2)
Bleeding at access site	15.0% (6,6)	15.0% (6,6)
Dissection	2.5% (1,1)	2.5% (1,1)
Pseudoaneurysm	2.5% (1,1)	2.5% (1,1)
Aortic-valve reintervention	0.0% (0,0)	0.0% (0,0)

**Table 87:  
Selected Adverse Events**

<b>Adverse Event</b>	<b>Discharge*</b>	<b>30 Days†</b>
Endocarditis	0.0% (0,0)	0.0% (0,0)
Device thrombosis	0.0% (0,0)	0.0% (0,0)
*Observed rate,% (no. of events, no. of subjects with the event)		
†Kaplan-Meier estimate,% (no. of events, no. of subjects with the event)		



The new conduction abnormalities requiring permanent pacemaker implantation through 30-days for the first 20 subjects and the last 20 subjects are presented in Table 88.

**Table 88:  
New Conduction Abnormalities Requiring Permanent Pacemaker Implantation**

Adverse Event	First 20 Subjects		Last 20 Subjects	
	Discharge*	30 Days†	Discharge*	30 Days†
Conduction disturbance requiring permanent pacemaker‡	29.4% (5,5)	29.4% (5,5)	5.6% (1,1)	5.6% (1,1)
‡5 Subjects (3 from First 20 subject cohort and 2 from Last 20 subject cohort) with baseline pacemaker were excluded from the analysis. *Observed rate,% (no. of events, no. of subjects with the event) †Kaplan-Meier estimate,% (no. of events, no. of subjects with the event)				

Other Results

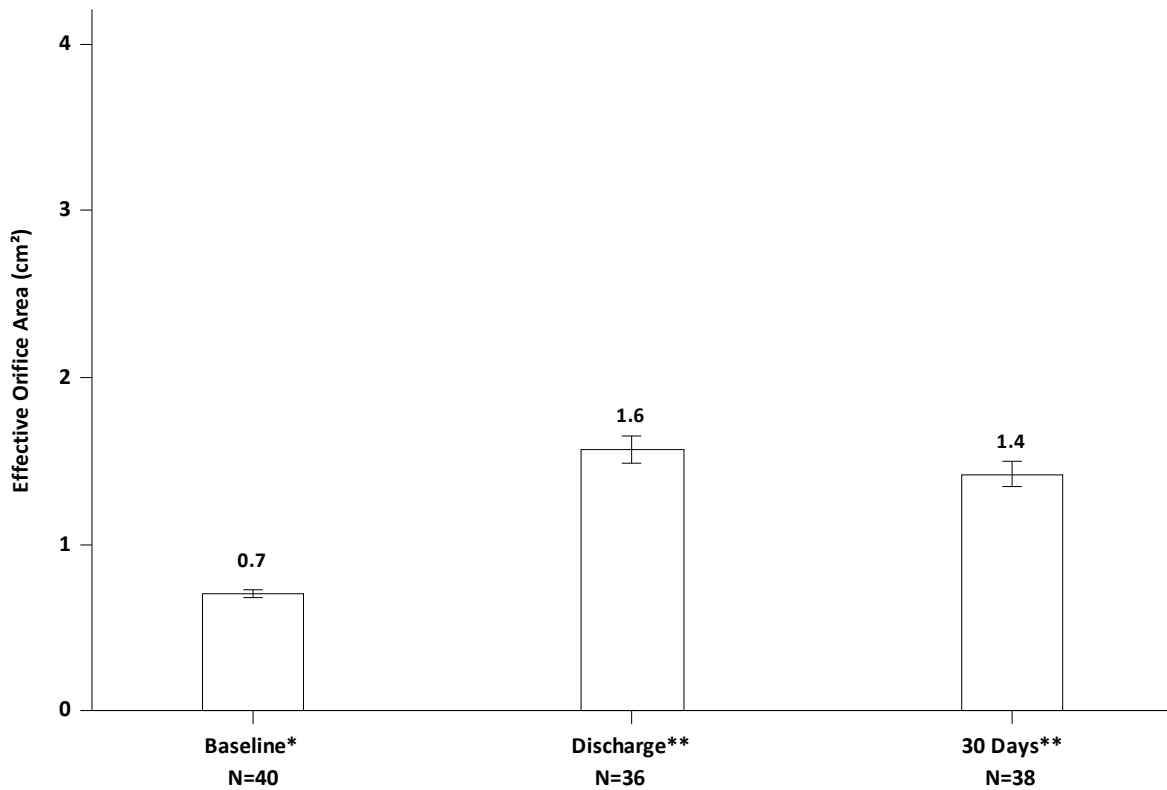
Procedural Information

Overall, the mean procedure time was 56.5 ± 26.8 minutes. Conscious sedation was utilized in 95% of the patients with one patient converted to general anesthesia. The valve was placed in the intended position in all cases, there were no aborted implantation procedures or conversion to open heart surgery. Successful access, delivery and retrieval of the device and delivery system occurred in all cases. The average length of stay was 4.1 ± 2.4 days.

Valve Performance

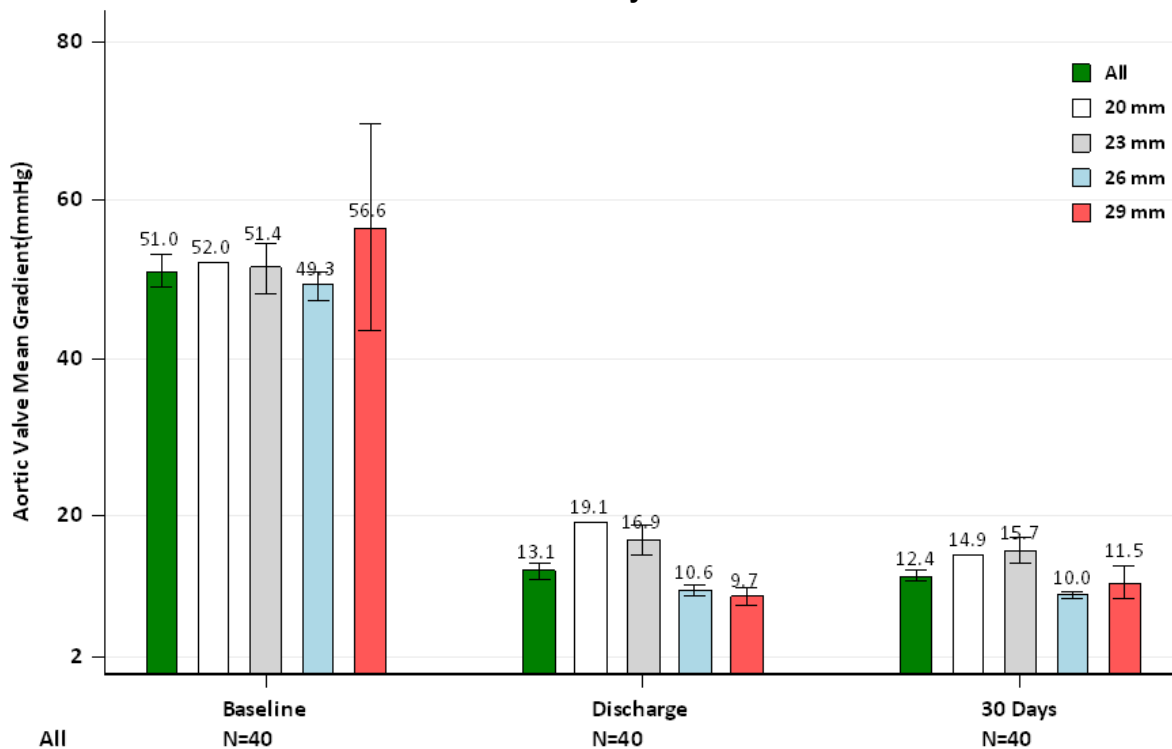
The measurements of effective orifice area, mean gradient, total aortic regurgitation, aortic paravalvular regurgitation (PVL) are presented in Figures 86-89. Mean EOA increased and gradients decreased. PVL was trace or none in 85% of the patients.

**Figure 86:  
Effective Orifice Area**

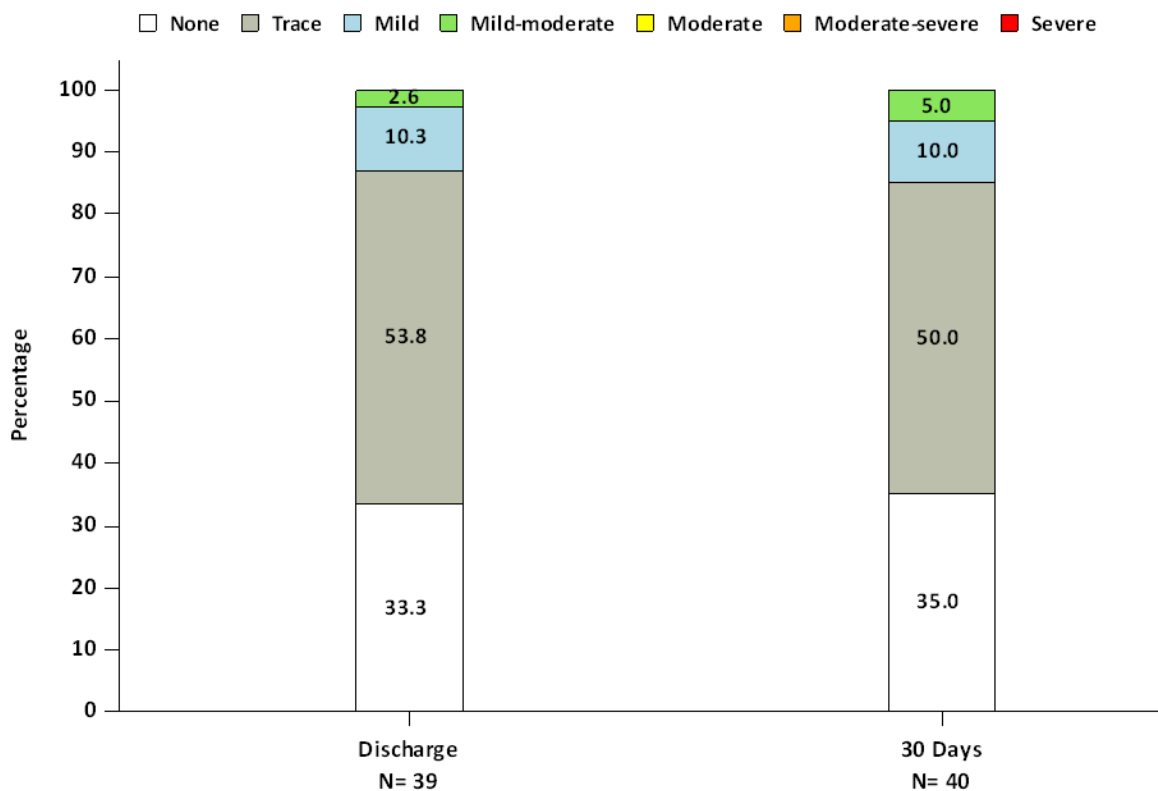


\*Site reported. \*\*Core lab reported.

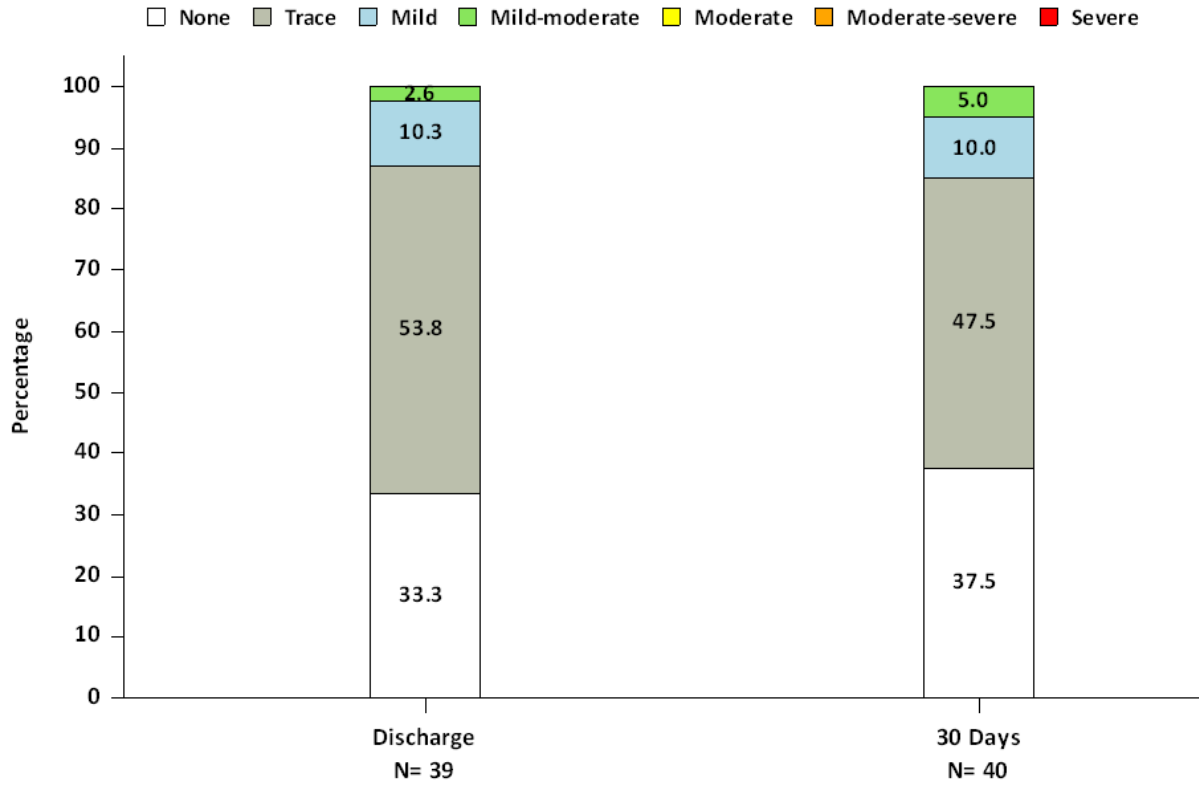
**Figure 87:  
Mean Gradient by Valve Size**



**Figure 88:  
Total Aortic Regurgitation**

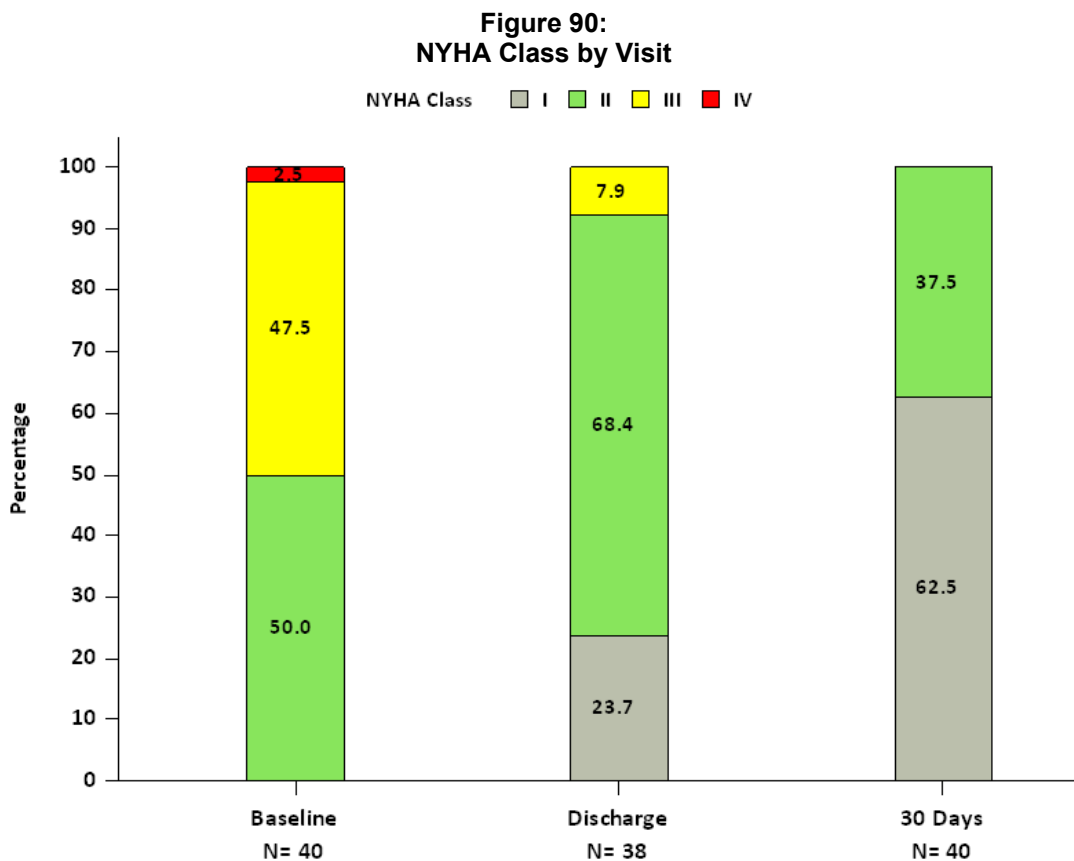


**Figure 89:  
Aortic Paravalvular Regurgitation**



## NYHA

The NYHA Functional Class summary is shown in Figure 90. At 30-day follow-up, 80.0% of subjects experienced improvement in NYHA Class and all subjects were in Class I/II.



## REFERENCES

- [1] Bapat V, Attia R, Thomas M. Effect of Valve Design on the Stent Internal Diameter of a Bioprosthetic Valve: A Concept of True Internal Diameter and Its Implications for the Valve-in-Valve Procedure. *JACC: Cardiovascular Interventions*. Vol. 7, No. 2 2014: 115-127
- [2] Kappetein AP, Head SJ, Génèreux P, et al. Updated standardized endpoint definitions for transcatheter aortic valve implantation: the Valve Academic Research Consortium-2 consensus document (VARC-2). *Eur J Cardiothorac Surg* 2012;42: S45-60.
- [3] Imbens G. W. (2004) Nonparametric Estimation of Average Treatment Effects under Exogeneity: A Review. *The Review of Economics and Statistics*, February 2004, 86(1): 4–29.
- [4] Abbas AE, et al. (2020) Hemodynamic principles of prosthetic aortic valve evaluation in the transcatheter aortic valve replacement era. *Echocardiography*, 2020;37:738-757.

These products are manufactured and sold under one or more of the following US patent(s): US Patent No. 7,530,253; 7,780,723; 7,895,876; 8,382,826; 8,591,575; 8,690,936; 8,790,387; 9,061,119; 9,301,840; 9,301,841; 9,339,384; 9,393,110; and corresponding foreign patents.



Edwards

09/2020  
© Copyright 2020, Edwards Lifesciences LLC  
All rights reserved.

---

Manufacturer   
**Edwards Lifesciences LLC**  
One Edwards Way  
Irvine, CA 92614 USA


Telephone 949.250.2500  
800.424.3278  
FAX 949.250.2525

Web IFU  
10033860003 A



**Vendor: Do Not Print This Page.**

**For Internal Edwards Lifesciences Use Only.**

 Edwards	Title: IFU S3/S3U, CERTITUDE DS	Page: 132 of 132
	Label Item/Revision:	10033860003/A
	Visual Representation/Revision:	/A
	Drawing/Specification:	DOC-0001941
	English Master/Revision:	N/A
	eIFU Visual Representation/Revision:	N/A
	Refer to supporting material for signatures.	

**NOTE**

**1. ALL ART PRINTS 100% BLACK UNLESS OTHERWISE NOTED.**

**INKS**

**BLACK**

**GRAYSCALE 55% BLACK**