

Aveir™

Leadless Pacemaker
Model LSP112V

Aveir™

Delivery Catheter
Model LSCD111

Instructions for Use



CAUTION: Federal (USA) law restricts this device to sale by or on the order of a physician.



WARNING: This product can expose you to chemicals including ethylene oxide, which is known to the State of California to cause cancer and birth defects or other reproductive harm. For more information, go to www.P65Warnings.ca.gov.

[™] Indicates a trademark of the Abbott group of companies.

‡ Indicates a third-party trademark, which is property of its respective owner.

Pat. <http://www.abbott.com/patents>

© 2021 Abbott. All Rights Reserved.

Contents

Prescription and Safety Information.....	1
Product Description	19
Instructions for Use.	30
Managing and Following Patients	57
Specifications and Characteristics.....	61
Data Security.....	73
Technical Support.....	74
Symbols.....	75

Prescription and Safety Information

Read this section to gather important prescription and safety information.

Intended Use

The Aveir™ Leadless Pacemaker (LP) is designed to provide bradycardia pacing as a pulse generator with built-in battery and electrodes for implantation in the right ventricle. The LP is intended to provide sensing of intrinsic cardiac signals and delivery of cardiac pacing therapy to the target patient population.

The Aveir™ Delivery Catheter is intended to be used in the peripheral vasculature and the cardiovascular system to deliver and manipulate an LP. Delivery and manipulation includes implanting an LP within the target chamber of the heart.

Indications for Use

The Aveir™ Leadless Pacemaker system is indicated for patients with significant bradycardia and:

- Normal sinus rhythm with rare episodes of A-V block or sinus arrest
- Chronic atrial fibrillation
- Severe physical disability

Rate-Modulated Pacing is indicated for patients with chronotropic incompetence, and for those who would benefit from increased stimulation rates concurrent with physical activity.

MR Conditional Aveir™ Leadless Pacemaker is conditionally safe for use in the MRI environment and

according to the instructions in the MRI-Ready Leadless System Manual.

Aveir™ Delivery Catheter: The Aveir Delivery Catheter is intended to be used in the peripheral vasculature and the cardiovascular system to deliver and manipulate an LP. Delivery and manipulation include implanting an LP within the target chamber of the heart.

Aveir™ Link Module: The Aveir Link Module is intended to be used in conjunction with a Merlin™ PCS Programmer to interrogate and program an Aveir LP and to monitor LP function during an implant, retrieval, or follow-up procedure.

Contraindications

Use of the Aveir™ Leadless Pacemaker is contraindicated in these cases:

- Use of any pacemaker is contraindicated in patients with a co-implanted ICD because high-voltage shocks could damage the pacemaker and the pacemaker could reduce shock effectiveness.
- Single-chamber ventricular demand pacing is relatively contraindicated in patients who have demonstrated pacemaker syndrome, have retrograde VA conduction, or suffer a drop in arterial blood pressure with the onset of ventricular pacing.
- Programming of rate-responsive pacing is contraindicated in patients with intolerance of high sensor-driven rates.
- Use is contraindicated in patients with an implanted vena cava filter or mechanical tricuspid valve because of interference between these devices and the delivery system during implantation.
- Persons with known history of allergies to any of the components of this device may suffer an allergic reaction to this device. Prior to use on the patient, the patient should be counseled on the materials (listed in Product Materials (page 71)) contained in the device and a thorough history of allergies must be discussed.

For the MRI contraindications for patients implanted with Aveir Leadless Pacemaker, refer to the MRI-Ready Leadless System Manual.

There are no contraindications for use of the Aveir Link Module

Clinical Benefit

The Aveir™ Leadless Pacemaker system offers all the clinical benefits provided by traditional pacemakers:

- Sensing the heart's intrinsic signals and delivering cardiac pacing therapy
- Long-term management of chronic symptomatic sinus bradycardia and various forms of atrioventricular conduction abnormalities
- Improved health-related quality of life (QOL) and decreased morbidity and mortality

The Aveir™ Leadless Pacemaker system provides additional benefits when compared to a traditional single-chamber transvenous lead and IPG pacemaker, including:

- No lead-related complications (such as infection, lead fracture, or insulation problems)
- No pocket-related complications (such as infection, skin erosion, or keloid formation)
- Elimination of pectoral scars and generator bulge
- Improved health-related quality of life (QOL)

The Aveir™ Leadless Pacemaker system also enables patients to have the option to undergo an MRI scan, when clinically necessary, under defined conditions for use.

Patient Target Group

The Aveir™ Leadless Pacemaker is intended to treat the same patient population as the conventional single-chamber pacemaker does. The single-chamber pacing therapy is specifically recommended for:

- Symptomatic patients with atrioventricular (AV) block who have chronic atrial fibrillation (AF) or other atrial tachyarrhythmia (AT) or when maintenance of AV synchrony during pacing is not necessary.
- Select patients with AV block who require permanent pacing in whom frequent ventricular pacing is not expected, or who have significant comorbidities that are likely to determine clinical outcomes and that may limit the benefit of dual chamber pacing.
- Symptomatic patients with sinus node dysfunction (SND) with evidence for impaired AV conduction or concern over future development of AV block, while maintaining AV synchrony during pacing is not necessary.
- Symptomatic patients with SND in which frequent ventricular pacing is not expected or the patient has significant comorbidities that are otherwise likely to determine the survival and clinical outcomes.
- Patients with atrial fibrillation and AV block who have an indication for permanent pacing with a LVEF between 36% and 50% and are expected to require ventricular pacing less than 40% of the time and where AV synchrony during pacing is not needed.

Leadless pacing therapy can also be recommended for patients with difficult upper extremity venous access or at increased risk for infection (for example, hemodialysis patients, history of recurrent device infections).

Physicians are responsible for selecting the appropriate pacing therapy for their patients. The decision is directed by evidence-based guidelines.

MRI Safety Information

The Aveir™ Leadless Pacemaker is conditionally safe for use in the MRI environment when used according to the instructions in the MRI-Ready Leadless System Manual (which includes equipment settings, scanning procedures, and a listing of conditionally approved components). Scanning under different conditions may result in severe patient injury, death, or device malfunction.

Pre-Implantation Considerations

Consider the following before implanting the Aveir™ Leadless Pacemaker.

Co-existing active implantable medical devices. The LP has not been tested in the presence of other electrically-active, non-Aveir™, implantable medical devices (such as neurostimulators). Patient evaluation and the decision to implant the LP should take into account the presence of other active implantable devices and should include consultation with the involved physician(s) or manufacturer of the co-existing device.

Refer to the Aveir™ Link Module Instructions for Use for additional safety information regarding possible interference with other active implantable devices during implantation or follow-up telemetry. For further questions on co-existing Abbott Medical implantable devices, contact Abbott Medical Technical Support (page 74).

Warnings

The following warnings apply to the Aveir™ Leadless Pacemaker:

Prior surgical intervention. Careful consideration should be given to patients who have had cardiovascular or peripheral vascular surgery/intervention within the last 30 days because these patients may have a higher risk of complications.

Previous clinical events. Implant of an LP should not be attempted in the presence of an active perforation. Implant sites where a previous clinical event such as perforation or lead extraction with myocardial tissue removal should be avoided as this may result in a higher rate of perforation.

Risk of perforation. Do not put excessive forward pressure on the protective sleeve or the delivery catheter when implanting the LP because perforation may result.

Do not turn the LP more than 1 1/2 turns during implantation, because perforation may result.

Risk of dislodgement. Use of an LP could involve risk of dislodgement resulting in inadvertent migration of the pacemaker into the lungs and possible compromised pulmonary reserve.

Contact between devices. When implanting a new LP in the presence of a previously-implanted LP, the LPs should not be touching. The consequences of potential short-term and long-term mechanical and electrical interactions between the LPs are not known.

During the implant procedure, avoid contact between the delivery catheter or its attached LP and any previously-implanted LP as this could result in dislodgement of the existing LP and possible embolization.

Do not implant a new LP in the presence of an implanted transvenous lead because this has not been tested.

When implanting a new traditional implant (pacemaker or ICD) in the presence of a previously-implanted LP, the transvenous leads associated with the new implant should not come in contact with the LP. The combination of a deactivated LP and a transvenous lead has not been tested and could result in patient injury.

Chronic retrievals. Limited testing has been performed for retrieval of a chronically implanted LP. Attempted removal of an LP that has been implanted chronically could result in patient injury.

Precautions

The following precautions apply to the Aveir™ Leadless Pacemaker:

Patient selection. Patients with coagulopathy, including those who are chronically anticoagulated, or other conditions that could add significant risk in the unlikely event of surgical management of an incident such as perforation, should be evaluated carefully for suitability for leadless pacing.

Cover the helix during implantation. Do not advance the LP through the vasculature without the delivery catheter's protective sleeve fully covering the LP helix. Damage to the LP helix and injury to peripheral structures and heart structures may occur if the LP helix is not covered.

Use fluoroscopy to confirm LP placement. Confirm the placement of the LP at the desired implant site in the endocardium of the right ventricle, via multiple plane fluoroscopy prior to release of the LP from the

delivery catheter, to verify that inadvertent placement of the LP through a patent foramen ovale or septal defect did not occur.

Use by a single operator. When the LP is in the heart, the delivery catheter should only be manipulated by a single operator.

LP deployment. Do not turn the LP release knob until ready to deploy the LP after fixation in the endocardium; otherwise, loss of pacing and/or embolization could result.

Storage and Handling

- Store the LP at room temperature, 25°C (77°F). Excursions are permitted between 15°C and 30°C (59°F and 86°F).
During transportation and handling, the LP can be safely exposed to temperatures between -20°C and 60°C (-4°F and 140°F) that last up to 24 hours. Storage outside of this range may result in LP reset.
- Store the LP in a clean area, away from magnets, kits containing magnets, and sources of electromagnetic interference to avoid device damage.
- Do not implant an LP that has been dropped on a hard surface while outside of its intact shelf package, or from a height of more than 24 inches (61 cm) while within its intact shelf package. Sterility, integrity, or function cannot be guaranteed under these conditions, and the LP should be returned to Abbott Medical for inspection.
- Keep the delivery catheter in a cool, dry place. Do not expose to sunlight.

Sterilization

The package contents have been sterilized with ethylene oxide before shipment. The LP and delivery catheter are FOR SINGLE USE ONLY and are not intended to be resterilized.

Any attempt to resterilize and reuse may compromise the integrity of this system. Adverse effects associated with resterilization and reuse of components may include, but are not limited to:

- Local and/or systemic infection
- Mechanical damage
- Inaccurate functionality

Do not implant the LP when the sterility indicator within the inner package is purple, because it might not have been sterilized, or when the storage package has been pierced or altered, because this could have rendered it non-sterile.

Environmental and Medical Therapy Hazards

Abbott Medical devices are equipped with special shielding and filters which significantly reduce the adverse effects of electromagnetic interference (EMI) on the operation of the LP.

Patients should be directed to exercise reasonable caution in avoidance of strong electric or magnetic fields. If the LP inhibits or reverts to asynchronous operation while in the presence of EMI, the patient should move away from the EMI source or turn the source off.

Advise patients to seek medical guidance before entering environments which could adversely affect the operation of the LP, including areas protected by a warning notice preventing entry by pacemaker patients.

Medical Procedures and Environments

In general, pacemaker patients should not be exposed to hospital equipment that produces high electromagnetic field strength signals, such as diathermy machines and electrosurgical units. Exposure to devices that generate strong electric or magnetic interference (EMI) could cause LP reset, malfunction or damage. Contact Abbott Medical Technical Support (page 74) for additional information.

External defibrillation. The electronic circuitry in the LP provides protection from defibrillation discharges. Nevertheless, do not place defibrillator paddles directly over the LP. Following defibrillation, ensure that the LP is operating correctly.

Magnetic resonance imaging (MRI). Leadless pacemakers are conditionally safe for use in the MRI environment when used according to the instructions in the MRI-Ready Leadless System Manual.

Ionizing Radiation. Therapeutic ionizing radiation (for example, used in linear accelerators and cobalt machines) can permanently damage the LP's circuitry. The effect of ionizing radiation is cumulative; the potential for damage to the LP is proportional to the patient's total radiation dosage. If the patient must be exposed to ionizing radiation, protect the LP during the procedure with local radiation shielding. Before and after exposure to radiation, evaluate the LP operation to identify any adverse consequences.

Transcutaneous electrical nerve stimulation (TENS). To reduce the possibility of interference with LP operation, place the TENS electrodes close to one another and as far from the LP as possible. Before allowing unrestricted use of TENS in a home or other setting, screen the patient in a monitored environment for possible interaction.

Therapeutic diathermy. Avoid diathermy, even if the LP is programmed off, as it may damage tissue around the implanted electrodes or may permanently damage the LP.

Electrosurgical cautery. This can induce ventricular arrhythmias and/or fibrillation or may cause asynchronous or inhibited LP operation. If use of electrocautery is necessary, the current path and ground plate should be kept as far away from the LP as possible. The axis of the electrocautery should be perpendicular to the electrode axis. A bipolar cauterizer may minimize these effects. Following electrocautery, conduct a thorough assessment of the LP.

RF ablation. Delivery of intra-cardiac radiofrequency (RF) energy during an RF ablation procedure in patients with a cardiac implantable electronic device may cause:

- Pacing above or below the programmed rate
- Reversion to asynchronous operation
- LP electrical reset
- Premature triggering of the recommended replacement (RRT) indicator
- Permanent LP malfunction and/or damage

RF ablation risks may be minimized by:

- Programming an asynchronous, non-rate responsive pacing mode prior to the RF ablation procedure
- Avoiding direct contact between the ablation catheter tip and the LP
- Positioning the grounding patch/pad so that the current pathway does not pass through or near the LP (for example, placing the ground plate under the patient's buttocks or legs)

- Having a programmer system readily available
- Monitoring the patient during and immediately after the procedure
- Having external pacing or defibrillation equipment available

Therapeutic ultrasound. The LP should not be exposed to therapeutic levels of ultrasound energy, as the LP can inadvertently concentrate the ultrasound field and cause harm that might not be immediately detectable. Diagnostic ultrasound treatment is not known to affect the operation of the LP.

Temporary pacing. Care should be taken when implanting a new LP in conjunction with a temporary pacing lead to avoid any electrical or mechanical interaction.

Patient Environments

Advise patients to exercise reasonable caution in avoidance of strong electric or magnetic fields. Exposure to these strong electric or magnetic fields could result in LP reset.

If the LP inhibits or reverts to asynchronous operation while in the presence of electromagnetic interference (EMI), the patient should move away from the EMI source or turn the source off.

Advise patients to seek medical guidance before entering environments that could adversely affect the operation of the LP, including areas protected by a warning notice preventing entry by pacemaker patients.

High-voltage transmission lines and equipment, arc or resistance welders, induction furnaces, and similar equipment may generate substantial EMI fields which may interfere with LP operation.

Communication equipment such as microwave transmitters ¹, linear power amplifiers, or high-power amateur transmitters may generate sufficient EMI to interfere with LP operation. Advise patients to move away from this equipment to resume normal LP operation.

Home appliances that are in good working order and properly grounded do not usually produce enough EMI to interfere with LP operation. Electric vibrators, razors, and hand tools held directly over the device may disturb LP operation.

Electronic Article Surveillance (EAS). Advise patients that Electronic Article Surveillance (EAS) systems such as those at the point of sale and entrances or exits of stores, libraries, banks, etc., emit signals that may interact with pacemakers. It is very unlikely that these systems will interact with their LP significantly. However, to minimize the possibility of interaction, advise patients to simply walk through these areas at a normal pace and avoid lingering near or leaning on these systems.

¹ Home appliance microwave ovens do not interfere with LP operation.

No Pacer symbol. Caution patients implanted with an LP to avoid areas marked with the No Pacer symbol.

Figure 1. No Pacer symbol



Cellular phones. The LP has been tested for compatibility with handheld wireless transmitters in accordance with the requirements of ISO 14117. This testing covered the operating frequencies (385 MHz-3 GHz). Based on the results of this testing, the normal operation of cellular phones should not affect the LP.

- Advise patients not to carry a cellular phone in a breast pocket or other location if they are over the LP. Some accessories for cellular phones may contain magnets, such as cases with magnetic clasps. See Pacing Rates Following Magnet Detection (page 70).
- Advise patients to avoid interference between cell phones or smart watches and the LP by keeping them at least 15 centimeters (6 inches) away from the LP.

Portable electronic devices.

- Advise patients not to carry electronic portable devices such as e-cigarettes, or key cards, credit cards or other items with magnetic strips in their breast pocket or near the heart.
- Advise patients not to carry earbuds or headphones in their breast pocket or near the heart, and not to allow earbuds or headphones to drape around the patient's neck so they hang on the chest. These devices may contain a magnet or magnetic material, or may emit RF signals that can interfere with the LP.

For further questions, contact Abbott Medical Technical Support (page 74).

Environmental conditions. Advise patients to avoid environments that may cause a sudden change in body temperature, which could affect rate response if Sensor mode is turned on.

The LP is designed to withstand absolute ambient pressures between at least 50 kPa (0.5 atm) and 304 kPa (3 atm). Advise patients to avoid environments that could subject the LP to atmospheric pressures outside of this range.

Adverse Events

Potential complications associated with the use of the Aveir™ Leadless Pacemaker system are the same as with the use of single chamber pacemakers with active fixation pacing leads including, but not limited to:

- Cardiac perforation
- Cardiac tamponade
- Pericardial effusion
- Pericarditis
- Valve damage and/or regurgitation
- Heart failure
- Pneumothorax/hemothorax
- Cardiac arrhythmias
- Diaphragmatic/phrenic nerve stimulation / extra-cardiac stimulation
- Palpitations
- Hypotension

- Syncope
- Cerebrovascular accident
- Infection
- Hypersensitivity reaction to device materials, medications, or direct toxic effect of contrast media on kidney function
- Pacemaker syndrome
- Inability to interrogate or program the LP due to programmer or LP malfunction
- Intermittent or complete loss of pacing and/or sensing due to dislodgement or mechanical malfunction of the LP (non-battery related)
- Loss of capture or sensing due to embolization or fibrotic tissue response at the electrode
- Increased capture threshold
- Inappropriate sensor response
- Interruption of desired LP function due to electrical interference, either electromyogenic or electromagnetic
- Battery malfunction/ premature battery depletion
- Device-related complications:

- Premature deployment
- Device dislodgement/embolization of foreign material
- Helix distortion
- Death

As with any percutaneous catheterization procedure, potential complications include, but are not limited to:

- Vascular access complications; such as perforation, dissection, puncture, groin pain
- Bleeding or hematoma
- Thrombus formation
- Thromboembolism
- Air embolism
- Local and systemic infection
- Peripheral nerve damage
- General surgery risks and complications from comorbidities; such as hypotension, dyspnea, respiratory failure, syncope, pneumonia, hypertension, cardiac failure, reaction to sedation, renal failure, anemia, and death

Incident Reporting

If, in the course of use of this device, you have reason to believe that a serious incident occurred, please report it to the manufacturer. For customers in the European Union, report the serious incident to your national authority as well as to the manufacturer.

Product Description

This section describes the Aveir™ Leadless Pacemaker and Aveir™ Delivery Catheter.

Table 1. Product models

Name	Model	Description	
Aveir™ Leadless Pacemaker	LSP112V	Leadless pacemaker	RV (right ventricular)
Aveir™ Delivery Catheter	LSCD111	Delivery catheter	

Package Contents

The LP and delivery catheter are supplied in individual sterile packs:

- A pack that contains a tray that holds the LP inside the loading tool.
- A pack that contains a tray that holds the delivery catheter tray.

The trays are sterile (via ethylene oxide), for single-use only, and may not be re-sterilized.

If the sterile package has been compromised, do not use it. Contact Abbott Medical Technical Support (page 74) for return instructions.

Leadless Pacemaker

The Aveir™ Leadless Pacemaker (LP) provides bradycardia pacing as a pulse generator with a built-in battery and electrodes for implantation in the right ventricle.

As a leadless device, it does not need a connector, pacing lead, or pulse generator pocket. A distal non-retractable helix affixes the LP to the endocardium. Three additional features on the outside of the LP nosecone are designed to provide secondary fixation securement. Sensing and pacing occur between a distal electrode near the helix and the external can of the LP. The LP's proximal end has a feature for docking to delivery and retrieval catheters, providing for repositioning and retrieval capability.

The LP communicates bi-directionally with the programmer system via electrical signals conducted between the implanted LP's electrodes and skin electrodes applied to the patient's chest and connected to the programmer system. Consequently, the LP transmits signals using circuits and electrodes already provided for pacing, with data encoded in pulses delivered during the heart's refractory period.

The LP senses right-ventricular blood temperature to provide an increase in pacing rate with increased metabolic demand.

NOTE: The LP device electronics are designed to BE enabled by FUTURE software to support dual-chamber pacing in the future.

Figure 2. Leadless pacemaker (LP)



1. Docking button
2. Helix

The tip electrode includes a single dose of dexamethasone sodium phosphate (DSP), intended to reduce inflammation.

The LP is supplied contained inside the loading tool.

Figure 3. Loading tool

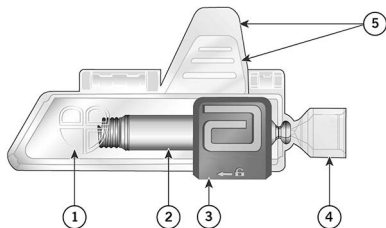

1. Chamber icon
2. LP inside loading tool
3. Latch
4. Funnel
5. Curved wings

Delivery Catheter

The Aveir™ Delivery Catheter (delivery catheter) includes a steerable delivery catheter, an integrated guiding catheter with a protective sleeve designed to protect an attached LP's fixation helix and electrode, and a valve bypass tool to dilate the 25 Fr inner diameter (ID) introducer sheath hemostasis valve and advance the system into the femoral vein.

Figure 4. Delivery catheter

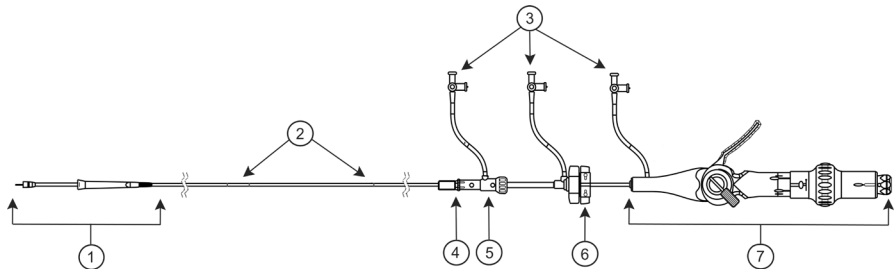

1. Delivery catheter tip (page 26)
2. Guide catheter with marker bands
3. Flush/irrigation ports

5. Valve bypass tool
6. Guide catheter hub lock
7. Delivery catheter handle (page 27)

4. Valve bypass tool lock
-

The delivery catheter provides a means to perform these actions during the implantation procedure:

- Attach and dock a separate LP pre-loaded in the loading tool
- Position the protective sleeve over the LP's fixation helix and lock the sleeve into place
- Advance the LP from an access site in the groin (utilizing minimally invasive techniques) through the femoral vein into the right ventricle
- Hand inject contrast solution through the guide catheter flush port to its distal tip
- Pull back the protective sleeve to expose the flexible section of the delivery catheter
- Map the endocardium with the docked LP to assess appropriateness of implant site
- Position the LP and rotate it to affix the LP's fixation helix to the endocardium
- Undock the LP from the delivery catheter leaving the LP tethered to the delivery catheter to measure thresholds with minimal force transmission from the delivery catheter
- Re-dock to the delivery catheter, unscrew and reposition the LP, if necessary, for acceptable thresholds
- Disconnect the LP from the tethers of the delivery catheter, leaving the LP implanted in the endocardium.

Apart from the docking mechanism, the delivery catheter and its control system (handle) have the same operating principle as a conventional steerable catheter and control system.

Figure 5. Delivery catheter

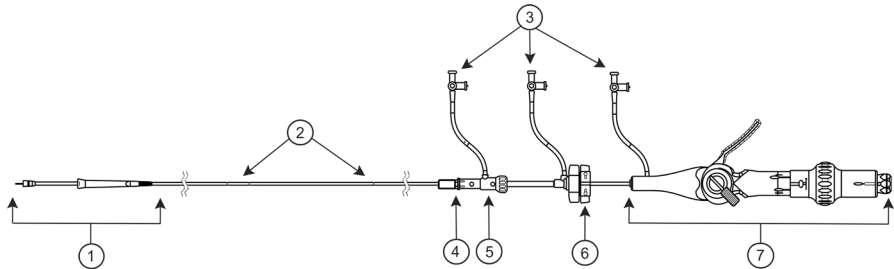

1. Delivery catheter tip (page 26)
2. Guide catheter with marker bands
3. Flush/irrigation ports

4. Valve bypass tool lock
5. Valve bypass tool
6. Guide catheter hub lock
7. Delivery catheter handle (page 27)

4. Valve bypass tool lock

Figure 6. Delivery catheter tip

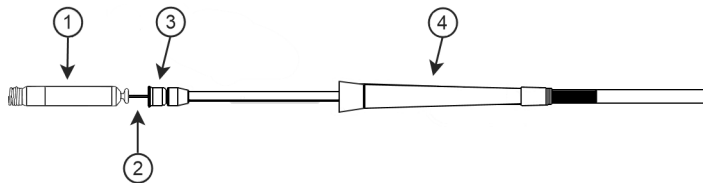

1. LP

2. Tethers

3. Docking cap

4. Protective sleeve

Figure 7. Delivery catheter handle

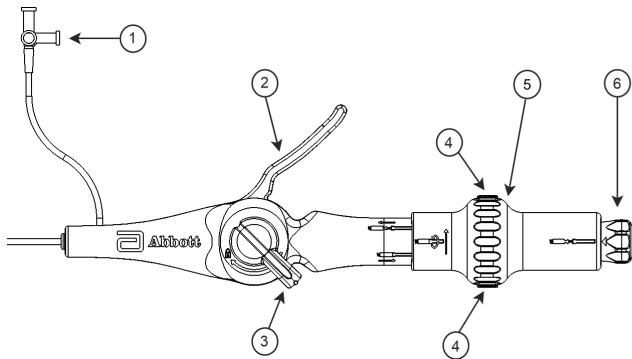

- 1. Flush/irrigation port
- 2. Deflection lever
- 3. Deflection brake

- 4. LP control knob release buttons
- 5. LP control knob
- 6. LP release knob

Compatible Devices

The LP and delivery catheter are intended to be used with this compatible introducer:

Table 2. Compatible device

Name	Model	Description
Aveir™ Introducer	LSN25301 LSN25501	25 Fr ID hydrophilic-coated introducer sheath Refer to the Aveir™ Introducer Instructions for Use.

CAUTION: Do not use the LP and delivery catheter with other introducers; use with other introducers has not been tested and can damage the devices.

The LP is intended to be used with these compatible programmer system components:

Table 3. Compatible devices

Name	Model	Description
Aveir™ Link Module	LSL02	Programmer communication unit Refer to the Aveir™ Link Module Instructions for Use.

Table 3. Compatible devices

Name	Model	Description
Merlin™ PCS	3650	Patient care system Refer to the Merlin™ Patient Care System User's Manual.

CAUTION: Do not use the LP with other programmer systems because this could result in no programming or incorrect programming.

CAUTION: Do not bring any external control devices, such as a Merlin™ PCS or Aveir™ Link Module, into the scanner magnet room (Zone IV). These devices are considered MR Unsafe.

If retrieval of an implanted LP becomes necessary, use this compatible retrieval catheter:

Table 4. Compatible device

Name	Model	Description
Aveir™ Retrieval Catheter	LSCR111	Retrieval catheter Refer to the Aveir™ Retrieval Catheter Instructions for Use.

CAUTION: Retrieval of the LP with other tools has not been tested.

Instructions for Use

This section provides instructions for preparing for the implantation procedure, implanting the LP, repositioning or retrieving the LP, and patient follow-up.

Read all instructions and package labels before use because they contain essential safety information. If instructions or labels appear to be altered or illegible, do not use the devices. Contact Abbott Medical Technical Support (page 74) for return instructions.

The medical procedures described in this section are the recommended best practices for the use of the delivery catheter and implantation of the LP. Actual procedures are at the discretion of the physician.

Physician Training

This product is intended for use by physicians trained and experienced in diagnostic and interventional techniques. Standard techniques for placement of vascular access sheaths should be employed. Individual patient anatomy and physician technique may require procedural variations. Physicians should be familiar with percutaneous retrieval procedures and follow-up evaluation.

Package Inspection

Before opening any sterile package, inspect the sales packaging carefully to ensure they have not been opened, punctured, or in any way compromised. If damage is suspected, contact Abbott Medical Technical Support (page 74) for return instructions.

Do not use the system after the expiration (use by) date printed on the sales package label and sterile package label.

Room and Patient Preparation

Implantation should be performed only under these conditions:

- The staff plans for and can recognize perforation and tamponade that might occur during the implant procedure, including availability of cardiothoracic surgery facilities, an in-laboratory pericardiocentesis tray, immediate access to echocardiogram, and staff training to recognize and respond to the emergency.
- Proper emergency facilities are available for cardioversion, defibrillation and cardio-pulmonary resuscitation.
- Proper equipment is available for high resolution fluoroscopy, including the ability to record and save images, to zoom, and to obtain images in multiple projections. For adequate visualization of the dynamic movement of the devices during the procedure, a minimum frame rate of 15 FPS is recommended.
- Four heparinized saline lines are required at the feet of the patient; two lines are pressurized and the other two are dripped. Have sterile extension tubing available for use with each line.
- Patient is positioned on the table to allow multi-plane fluoroscopic visualization from the femoral vein to the heart.

CAUTION: During the procedure, appropriate anticoagulant therapy should be considered to reduce potential thrombus formation.

- A Merlin™ PCS is connected to an Aveir™ Link Module. This is required for this procedure.
 - Place standard CE-marked ECG skin electrodes on the patient's cleaned and prepped chest prior to draping. Refer to the Aveir™ Link Module Instructions for Use for more information.
 - Turn on the Merlin PCS, press Interrogate on the screen, and ensure the programmer is displaying surface ECG before beginning the implantation procedure. Refer to the Merlin™ Patient Care System User's Manual for programmer instructions for use and the Aveir™ Leadless Pacemaker Help Manual for LP programming information.

Preparing Devices for Implantation

This section provides instructions for preparing the LP and delivery catheter for the implantation procedure.

NOTE: Do not alter the system in any way.

General Instructions for Delivery Catheter Handling

Maintain introducer position. Always maintain introducer position when inserting, manipulating, or withdrawing a device through an introducer.

Use fluoroscopy. Use fluoroscopy to guide the delivery catheter to the desired cardiovascular location and whenever the delivery catheter is being advanced, retrieved or manipulated.

Avoid excessive bending. Keep the catheter handle in line with the catheter shaft because excessive bending of the catheter can affect its performance.

General Instructions for Leadless Pacemaker Handling

Keep loading tool closed. Do not open the loading tool until the LP is attached to the delivery catheter.

Avoid contact with helix. Avoid touching the LP's fixation helix and contact with surgical towels or drapes because deformation of the helix may result.

Do not immerse. Do not immerse the LP tip electrode within the helix in any fluid prior to implantation; immersion of the electrode may cause a small amount of steroid to be prematurely eluted.

Avoid excessive handling. Avoid touching or handling the LP tip electrode, because this could damage its low-polarization coating. Avoid handling the LP with any surgical tools such as hemostats, clamps or forceps.

Use the introducer. Never introduce the LP into the femoral vein without using the introducer.

Ensure helix is covered. Always ensure that the LP fixation helix is covered when advancing the LP through the peripheral vasculature and into the right ventricle.

Vein Selection and Access

1. Select the entry site. The suggested entry site is the femoral vein via a percutaneous venous puncture. Avoid implantation through femoral veins with severe angulation, tortuosity or calcification.
2. Insert and flush the introducer according to the Aveir™ Introducer Instructions for Use.

Remove Devices from the Sterile Packs

To remove the delivery catheter:

1. Remove the pouch containing the delivery catheter from the sales packaging.
2. Inspect the sterile pouch carefully to ensure that the delivery catheter is free from damage and the sterile pouch has not been opened, tampered with, punctured or in any way compromised. Contents are sterile if the sterile pouch is unopened and undamaged.
3. Open the pouch and pass the tray onto the sterile field using sterile technique.
4. Remove the delivery catheter from the tray.
5. Pass the empty tray off the sterile field.

To remove the LP and loading tool:

6. Remove the LP and loading tool tray from the sales packaging.
7. Inspect the sterile tray carefully to ensure it has not been opened, tampered with, punctured, or in any way compromised. Contents are sterile if the sterile trays are unopened and undamaged.

NOTE: The package's outer tray can be opened in nonsterile surroundings. However, when opening the inner tray, complete sterile technique must be observed.

8. Open the outer tray and pass the inner tray onto the sterile field using sterile technique.
9. Remove the loading tool that contains the LP from the inner tray and place onto the sterile field. Keep the loading tool closed.
10. Pass the empty tray off the sterile field.

NOTE: If the LP, while still sterile, becomes displaced from its appropriate position in the loading tool, it can be reloaded back into the loading tool. See Reloading the Leadless Pacemaker into the Loading Tool (If Necessary) (page 54).

Load the LP onto the Delivery Catheter

To load the LP onto the delivery catheter:

1. Ensure the delivery catheter's valve bypass tool is positioned toward the handle.
2. Ensure the delivery catheter is in tether mode and the tethers are aligned.
3. Leaving the loading tool locked, fully insert the catheter tethers and docking cap into the funnel of the loading tool.
4. Leaving the loading tool locked, ensure the catheter tethers have engaged with the LP by performing a slight tug test between the catheter and the tool. If the tethers have successfully connected, they will be engaged with the LP button and retain the delivery catheter/LP connection.

5. If the connection was not successful, reattempt connection by repeating step 3.
6. Once the catheter is attached to the LP, slide the blue latch of the loading tool away from the funnel to the unlock position. After unlocking, press the curved wings together to open the loading tool and expose the LP.
7. Gently remove the LP from the loading tool using the delivery catheter (by pulling up and out with the catheter), taking care to protect the LP's fixation helix.
8. Dock the LP to the catheter by pulling back on the LP control knob on the back end of the delivery catheter handle until you hear an audible click and visually verify that the LP is mated to the delivery catheter. If necessary, undock the LP from the delivery catheter by depressing both the LP control knob unlock buttons and sliding the LP control knob forward. Re-dock the LP and re-inspect the junction to ensure the LP is properly mated.
9. Advance the protective sleeve to cover the LP's fixation helix.
10. Manually deflect the delivery catheter and note the axis of deflection relative to the flush port on the delivery handle.

Flush the Delivery System

Flush the irrigation systems.

NOTE: The delivery catheter and guide catheter irrigation ports are flushed with pressure lines. The introducer and valve bypass irrigation ports are flushed with drip lines. Use 2,000 units of heparin per 1-liter 0.9% saline bag.

1. Flush the delivery catheter. Connect a pressurized line of room temperature heparinized saline to the delivery catheter irrigation port. Flush the delivery catheter completely until all the air is evacuated and saline is flowing freely at the distal tip.
2. Flush the guide catheter. Connect a pressurized line of room temperature heparinized saline to the 3-way stopcock. Flush the guide catheter completely until all the air is evacuated and saline is flowing freely at the end.
3. Flush the valve bypass tool. Connect a drip line of room temperature heparinized saline to the valve bypass irrigation port. Flush the catheter valve bypass tool completely until all the air is evacuated and saline is flowing freely at the end.

Once flushed, set the drip rate to 1 drop per second. Maintain continuous flush during the entire procedure.

Implanting the Leadless Pacemaker

This section provides instructions for implanting the LP into the right ventricle.

Insert the Leadless Pacemaker and Delivery Catheter

To insert the LP and delivery catheter:

1. Orient the delivery catheter so that the Abbott logo is facing upward. This ensures that the catheter will deflect perpendicularly to the fluoro when viewed in right anterior oblique (RAO) 30.
2. Ensure the protective sleeve fully covers the LP's fixation helix and is locked into place with the hub lock.

NOTE: To avoid compromised guide catheter irrigation, do not fully advance the protective sleeve over the LP.

3. Slide the valve bypass tool over the protective sleeve and LP until it completely covers the LP's fixation helix. Ensure all the air is evacuated and saline is flowing freely at the end.
4. Insert the valve bypass tool into the 25 Fr ID introducer sheath all the way to the hub, making sure to align the tabs of the valve bypass tool with the slots of the introducer.
5. After aligning and inserting the valve bypass tool into the introducer, lock the valve bypass tool into the introducer by rotating clockwise approximately one quarter turn.

Figure 8. Insert the valve bypass tool into the introducer

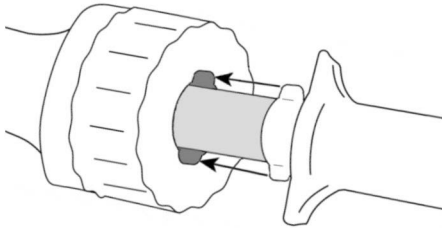

6. Under fluoroscopic guidance, slowly advance the delivery catheter and guide catheter until the LP reaches the junction of the inferior vena cava (IVC) and the right atrium.

NOTE: Use the grey marker on the guide catheter to reference when the LP is inside or outside of the 30 and 50 cm introducers.

NOTE: Advancing the delivery and guide catheter through the introducer can create transient pressures that could lead to air aspiration. During catheter insertion through the introducer, either temporarily increase the flow rate of the heparinized saline irrigation or temporarily switch to a 30cc

syringe of heparinized saline connected to the flush/irrigation port to prevent air aspiration. After the protective sleeve has exited the introducer, resume normal maintenance irrigation of the valve bypass tool.

CAUTION: Do not independently advance the delivery catheter without also advancing the guide catheter as this may advance the LP outside of the protective sleeve, leaving the LP helix exposed and resulting in damage to the LP helix.

CAUTION: When the LP is in the heart, the delivery catheter should only be manipulated by a single operator.

Position the Guide Catheter and Leadless Pacemaker

To position the guide catheter and LP:

WARNING: To reduce risk of perforation, consider a lower septal site for placement of the LP, especially if there is reason to believe the patient has an unusually thin wall at the apex of the right ventricle (for example: use of oral steroids, right ventricular infarction, history of Arrhythmogenic Right Ventricular Dysplasia (ARVD)).

NOTE: Confirm septal orientation by viewing the system in left anterior oblique (LAO) 30.

1. Ensure that the protective sleeve radiopaque marker is positioned in front of the LP's fixation helix, fully covering the LP so that the helix is behind the distal radiopaque marker of the protective sleeve.
2. While slowly advancing the delivery catheter with LP and guide catheter into the right atrium, actuate the deflection lever and rotate the catheter shaft as needed to provide the appropriate orientation toward the right ventricle (referred to as RV in this procedure) to cross the tricuspid valve.
3. Visualize catheter positioning in RAO 30 fluoroscopic view.

WARNING: Do not apply excessive forward force to the delivery catheter, because perforation can occur.

4. Use a combination of gentle forward force, deflection and catheter pullback to help the system enter the RV. Once in the RV, stop advancement of the system.
5. Using a 10-cc syringe, flush contrast through the 3-way stopcock on the guide catheter irrigation port to opacify the RV.
6. Visualize the system in the LAO 30 view to confirm alignment with the tricuspid valve and septal orientation.
7. Continue advancing the system through the tricuspid valve until the tip is approximately 1 to 2 cm from the endocardium by advancing the guide catheter shaft and applying deflection on the delivery catheter.

Figure 9. Protective sleeve covering the LP with hand injection of contrast showing the position in the RV approximately 1 to 2 cm away from the endocardium

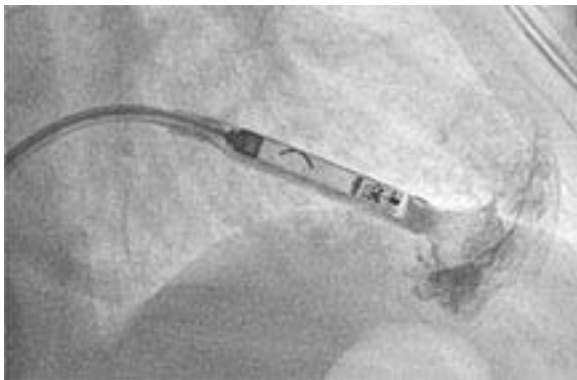

8. Confirm the desired position by opacifying the RV.

CAUTION: Do not advance the LP to the endocardium unless the protective sleeve is retracted because this may result in perforation.

9. Check the position in the RAO 30 and LAO 30 views to confirm the desired location.
10. The catheter can be positioned more septally by slowly rotating the delivery catheter clockwise while visualizing in the LAO 30 view.
11. Unlock then retract the hub of the guide catheter all the way back allowing maximal delivery catheter flexibility and fully exposing the LP (see the following illustrations).

Figure 10. Hub of guide catheter withdrawn back to the handle

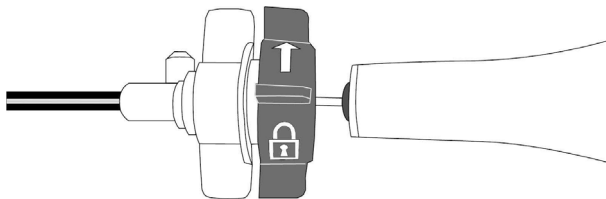
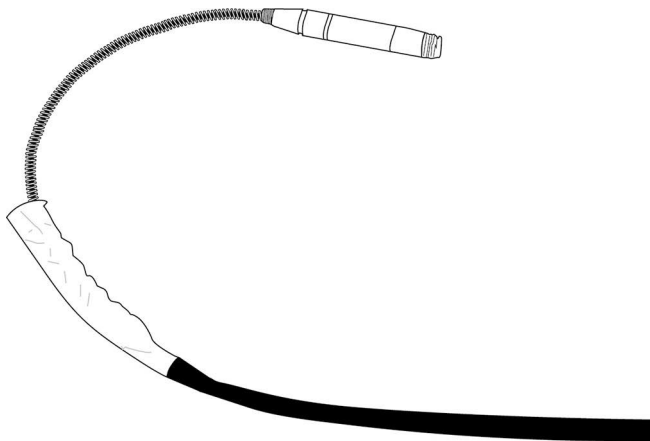

Figure 11. Deflected distal tip of delivery catheter



WARNING: Maintain the LP position by holding the delivery catheter handle against the patient table so that relative movements can be made in a controlled manner. Slowly pull back the guide

catheter protective sleeve, because unintended movement could lead to perforation or entanglement.

WARNING: The protective sleeve should be fully retracted so that the catheter has maximum flexibility before advancing the LP to the desired position in the endocardium.

12. Interrogate the LP using the programmer system and confirm communication with the LP.
13. Before anchoring, carefully inspect the fixation helix while the LP is in the RV to look for any helix deformation or stretching. If helix deformation or stretching is observed, take out the catheter and remove the LP, then replace it with a new LP.
14. With the LP attached to the delivery catheter and the protective sleeve completely retracted, slowly advance the LP to the desired position in the RV with gentle forward pressure. Confirm contact with the endocardium by noting movement of the distal section of the delivery catheter with the cardiac cycle.

WARNING: Do not apply excessive forward force against the endocardium with the LP, because this could result in perforation.

15. The initial target implant site should be the lower septum and confirmed in LAO view.

Confirm Communication with the Leadless Pacemaker

Establish and confirm communication with the LP, then initiate an implantation programming session using the programmer system.

The LP's initial operating mode when first introduced into the bloodstream is VVI mode.

Refer to the Aveir™ Leadless Pacemaker Help Manual for LP programming information.

NOTE: The LP communicates with the Aveir™ Link Module via conducted communication. As with all communication methods, this can be affected by LP orientation and electromagnetic interference. Refer to the Aveir™ Link Module Instructions for Use for more information.

Confirm R-Waves Are Acceptable

Perform electrical mapping to confirm acceptable wave measurements:

1. After confirming movement of the LP with the cardiac cycle, use the programmer to obtain an R-wave measurement.
2. Take at least two measurements to confirm existence of clinically acceptable ECG.
 - If the R-wave measurement is acceptable: proceed to the next step of the implant procedure, Affix the Leadless Pacemaker (page 47).
 - If the R-wave measurement is unacceptable: pull back slightly on the delivery catheter until the LP is not in contact with the endocardium. Slightly deflect or un-deflect the delivery catheter

and slowly advance the delivery catheter until contact can be reconfirmed by visualizing movement of the catheter with the cardiac cycle. Repeat step 1.

WARNING: Careful consideration should be made prior to repositioning the LP. Repeat repositioning may increase the risk of perforation. To avoid unnecessary repositioning after LP fixation, confirm acceptable R-waves by making contact with the endocardium prior to affixing the LP to the endocardium.

Affix the Leadless Pacemaker

To affix the LP:

1. After confirming an acceptable R-wave measurement, unlock the deflection lever and release catheter deflection to improve torque response and catheter flexibility.
2. Visualize the curve of the catheter down to the inferior vena cava (IVC) to confirm the lack of buckling in the catheter; any buckling may indicate that excessive forward force is being applied to the endocardium.
3. Under fluoroscopy with both the LP and protective sleeve visible on the fluoro screen, slowly turn the LP control knob clockwise while visualizing the radiopaque marker on the LP and counting the turns of that radiopaque marker.

NOTE: Turns of the control knob will not necessarily match turns of the LP during implantation. An audible response of the control knob, or click, can be used as an indicator of rotational handle speed. Torque is not necessarily transmitted 1:1 from the control knob to the LP, so always proceed slowly and with caution. Do not exceed $1\frac{1}{2}$ turns of the LP radiopaque marker.

NOTE: Keep the catheter shaft straight because bends in the proximal section near the handle can affect torque transmission to the LP.

CAUTION: Do not rotate the LP while it is still covered by the protective sleeve, as this could result in damage to the LP or protective sleeve.

4. If there is no observed rotation of the radiopaque marker on the LP after one full turn of the LP control knob, do not continue to rotate. Ensure catheter deflection is off (unlocked and released) prior to turning the control knob.

Failure to rotate could result from tortuous catheter position or tissue calcification. Turn the control knob an equal number of counterclockwise rotations. Adjust the catheter and LP position, then attempt to affix the LP again.

5. Continue to turn the control knob slowly until you have visualized a minimum of $1\frac{1}{4}$ turns and a maximum of $1\frac{1}{2}$ turns of the LP radiopaque marker. Do not exceed rotation of the LP radiopaque marker beyond $1\frac{1}{2}$ turns when affixing, because this may lead to perforation.
6. Anchor to the lower septum and proceed to tether mode as soon as possible to minimize the time the LP remains docked.

To establish tether mode, grasp the control knob, push in on the white unlock buttons on either side of the knob, and slowly pull back on the delivery catheter while keeping the control knob fixed. Do not advance the control knob forward on the delivery catheter.

7. It may be necessary to deflect and lock the delivery catheter either to move the docking cap away from the RV wall to reduce the potential for ectopy or to maintain a coaxial orientation between the docking cap of the catheter and the docking button of the LP.

WARNING: Repositioning of the LP after fixation may lead to perforation/perioperative pericardial effusion.

Test Fixation and Assess Pacing and Sensing Thresholds

To test fixation and assess pacing and sensing thresholds:

1. In the tether mode, perform a gentle test to verify LP fixation by gently depressing the deflection lever to deflect the delivery catheter 30 to 45 degrees while visualizing LP movement. Partially apply the deflection brake to dampen the movement of the delivery catheter during the deflection test.

The proximal end of the LP (docking button) should move with the docking cap of the delivery catheter while the LP helix remains fixed.

2. Use the programmer system to assess pacing, R-wave amplitude, and impedance. In addition, commanded EGMs can be collected. Refer to the Aveir™ Leadless Pacemaker Help Manual for LP programming information.

Abbott Medical recommends (at pulse width 0.4 ms):

- Pacing threshold ≤ 1.25 V
- R-wave amplitude ≥ 5 mV

3. Assess for unintentional diaphragmatic contraction by pacing at maximum output.

Allow enough time (up to 20 minutes) for thresholds to stabilize to an acceptable range in tethered mode before considering re-positioning. If values worsen, do not expect them to improve over time.

WARNING: If the LP does not capture at maximum pulse amplitude and pulse width (6.0 V/1.5 ms) or the impedance is >2000 ohms, consider the possibility that perforation has occurred, leave the LP in place, perform an echocardiogram and prepare for possible urgent pericardiocentesis.

4. If satisfied with the pacing and sensing thresholds, proceed to Deploy the Leadless Pacemaker (page 51); otherwise, see Reposition the Leadless Pacemaker (page 53).

NOTE: If acceptable electrical measurements cannot be obtained, carefully pull the delivery catheter with the LP out of the patient and verify that the LP electrode is not obstructed by any blood clots. If blood clots are present on the LP electrode, remove them carefully. Repeat the procedure Insert the Leadless Pacemaker and Delivery Catheter (page 37).

Deploy the Leadless Pacemaker

To deploy the LP:

1. Once integrity of fixation and acceptable pacing, sensing, and impedance values have been confirmed, hold the delivery catheter against the patient table, grasp the white LP release knob on the back of the delivery catheter handle, pull the knob away from the handle, and rotate $\frac{1}{2}$ turn counterclockwise to a full stop.
2. If necessary, to facilitate release of the LP from the delivery catheter after release knob rotation, align the docking cap of the catheter with the docking button of the LP and then slide the LP control knob back and forth multiple times until the LP is freed.

NOTE: While retracting the delivery catheter to release the LP, observe release fluoroscopically. Do not apply excessive tension to the LP as this may cause the LP to become unaffixed from the implant site.

3. Once release of the LP is confirmed, slowly retract the delivery catheter from the LP by releasing the deflection from the delivery catheter and pulling the delivery catheter back into the inferior vena cava (IVC) just distal to the guide catheter while fluoroscopically visualizing the LP.
4. Pull the docking cap back into the protective sleeve and then pull the entire catheter into the valve bypass tool.
5. Unlock the valve bypass tool by turning counterclockwise approximately a quarter turn and then remove it from the introducer.

Reposition the Leadless Pacemaker (If Necessary)

To reposition the LP:

1. Verify the protective sleeve is pulled back as far as possible so that the catheter has maximum flexibility.
2. Gently advance and, if necessary, deflect the delivery catheter so it is coaxial with the docking button of the LP. Slowly pull back on the LP control knob until you hear an audible click and visualize the LP mating with the delivery catheter.
3. Slowly rotate the LP control knob counterclockwise while fluoroscopically observing the LP radiopaque marker to ensure that the LP helix has rotated between two and three turns and is fully disengaged from the endocardium.

CAUTION: Do not pull on the delivery catheter until the LP is fully disengaged from the endocardium. Do not apply excessive forward pressure because perforation can occur.

4. After visualizing between two and three counterclockwise turns of the LP radiopaque marker, gently pull back the delivery catheter approximately 10 mm. Avoid excessive manipulation so that the LP helix remains in the lower septal area and away from any valve structures or chordae.
5. Advance the protective sleeve to fully cover the LP and the helix.
6. Verify the LP helix is fully covered by the protective sleeve.
7. Repeat the procedure, Implanting the Leadless Pacemaker (page 37).

Reloading the Leadless Pacemaker into the Loading Tool (If Necessary)

If, while still sterile, the LP becomes displaced from its appropriate position in the loading tool, it can be reloaded back into the loading tool.

1. Unlock the loading tool by sliding the latch away from the funnel.
2. Press the curved wings to open the loading tool.
3. Place the LP into the loading tool, confirming that the LP is seated with the docking button in its designated position near the funnel.
4. Close the loading tool.
5. Slide the latch toward the funnel to lock the loading tool.

Retrieving the Leadless Pacemaker (If Necessary)

After the LP is released from the delivery catheter, the LP cannot be retrieved with the delivery catheter. To retrieve an implanted LP, use an Aveir™ Retrieval Catheter. Refer to the Aveir™ Retrieval Catheter Instructions for Use.

Leadless Pacemaker Replacement

There are several methods for LP replacement. Refer to the Aveir™ Leadless Pacemaker Help Manual for programming information for the selected replacement method.

- Retrieve an existing active LP implant and then implant a new LP.

WARNING: Implanting a new LP after retrieval of an existing LP in a patient who has become pacemaker dependent is not recommended unless supplemental pacing is provided.

WARNING: Attempted removal of an LP that has been implanted chronically could result in patient injury.

CAUTION: After retrieval, use care to implant the new LP in a different location to avoid compromising the endocardial wall.

NOTE: If a chronically-implanted LP is unable to be removed, it can be permanently disabled and left inside the patient.

- Implant a new LP and permanently disable an existing active LP by following the LP replacement (box change) workflow.

WARNING: When implanting an additional LP as a replacement, position the new LP and fluoroscopically confirm that the new LP is not in physical contact with the existing implant.

CAUTION: Disable the existing LP only after the new LP is enabled and verified to be working correctly.

- Implant a traditional pacemaker or ICD and then permanently disable an existing active LP using the programmer system.

NOTE: If not being replaced, an implanted LP can be permanently disabled through a password-protected programmer screen (accessed from Tools > Maintenance > System). Contact Abbott Medical Technical Support (page 74) for additional information on how to complete this step.

WARNING: When implanting a traditional pacemaker or ICD in the presence of a permanently disabled LP, fluoroscopically confirm that the transvenous leads associated with the new implant do not come in contact with the LP.

Cremation of a Deceased Leadless Pacemaker Patient

It is not necessary to explant an LP from a deceased adult patient prior to cremation, although the LP should be removed if possible. Rupture of the LP during cremation is normal and is not expected to present a significant risk to surrounding life or property.

Please carefully consider the following before proceeding with cremation:

1. Cremation should be limited to adults and be conducted only if the LP is within the intact torso.
2. Cremation in an enclosed crematorium is preferred. If open-air cremation is conducted, bystanders and inflammable materials must be kept back at least 10 meters (33 feet).
3. Following cremation, remove the LP prior to further preparation of ashes.

Burial of a Deceased Leadless Pacemaker Patient

It is not necessary to explant an LP from a deceased adult patient prior to burial, although the LP should be removed and returned to Abbott Medical if possible. The welded titanium enclosure is expected to remain

hermetic following burial, and in the unlikely event of a breach, the volume of potentially offensive substances contained within the LP is too small to present a significant risk to the surrounding environment.

Disposition of an Explanted Leadless Pacemaker

Do not reuse an explanted LP.

1. Clean explanted equipment with +1% sodium hypochlorite, rinse with water, dry.
2. Contact Abbott Medical Technical Support (page 74) for return instructions. All explanted and removed LPs should be returned and analyzed by Abbott Medical, including those that have undergone cremation.

Disposal

After use, this product may be a potential biohazard. Dispose of the loading tool, delivery catheter and packaging following normal hospital procedures and local laws and regulations.

Managing and Following Patients

This section provides instructions for managing and following patients with an implanted Aveir™ Leadless Pacemaker.

Patient Education

Abbott Medical provides a booklet for patients to explain the LP and its operation, and to be used to supplement discussions with the patient, and spouse or other interested persons. To obtain other available patient education materials, contact Abbott Medical.

Patient Identification Card

Complete the patient identification card provided in the outer box with the patient information, device information, implant date, and your name or healthcare facility information and contact phone number.

Figure 12. Patient Identification Card (front)

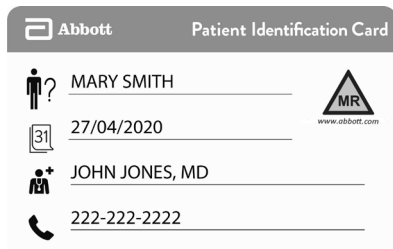

The image shows a patient identification card form with a dark grey header. The header contains the Abbott logo and the text "Abbott Patient Identification Card". The form has four rows of input fields, each with an icon to the left of the text. The first row has a person icon with a question mark, the text "MARY SMITH", and a triangle icon with "MR" inside. The second row has a calendar icon with "31" inside, the text "27/04/2020", and the same triangle icon. The third row has a person icon with a plus sign, the text "JOHN JONES, MD", and the same triangle icon. The fourth row has a telephone icon, the text "222-222-2222", and the same triangle icon. The triangle icon also has the website "www.abbott.com" written below it.

Icon	Text	MR
Person with question mark	MARY SMITH	MR
Calendar with 31	27/04/2020	MR
Person with plus sign	JOHN JONES, MD	MR
Telephone	222-222-2222	MR

Obtain the peel-away label from the sterile package and apply it to the inner section of the card.

If the label is not available, fill out the device information (model number, serial number, and UDI number) and location of the implant in the designated inner section of the card.

Figure 13. Patient Identification Card (inner section)



The form consists of a header icon, a rounded rectangular box for device information, and a location label below it. The header icon is a square containing a person silhouette and three horizontal lines. The rounded box contains three rows of text, each with a label in a grey box on the left and a horizontal line on the right. The first row is labeled 'REF' with the value 'LSP112V'. The second row is labeled 'SN' with the value '123456789'. The third row is labeled 'UDI' with the value '(01)01234567890123(17)040131(21)98765432'. Below the rounded box is a circular icon with a right-pointing arrow, followed by the text 'Right ventricle'.



REF LSP112V

SN 123456789

UDI (01)01234567890123(17)040131(21)98765432

 Right ventricle

Give the completed card to the patient to carry with them. This will serve as a temporary card until Abbott Medical mails a permanent card directly to the patient. To obtain a replacement card if a patient loses or damages their card, contact Abbott Medical Technical Support (page 74).

Patient Follow-Up

Patients should be seen for follow-up per normal standard of care. If the patient experiences a spontaneous return of symptoms, it may be deemed appropriate for the patient to return for follow-up immediately.

A follow-up visit should include (at a minimum):

- Review of the FastPath™ screen
- Review of event markers and histograms
- Assessment of pacing, sensing, impedance and battery voltage.
- Confirmation that the final parameter settings are correct.

Progression or changes over time in the patient's underlying heart or systemic disease may necessitate a re-evaluation of the patient's clinical arrhythmias. Reprogramming of LP parameters may be required. LP settings should be re-evaluated if the patient's antiarrhythmic medication is changed.

Refer to the Aveir™ Leadless Pacemaker Help Manual for LP programming information.

If a programmer system is not available, recommended replacement time (RRT) condition can be assessed using a standard pacemaker donut magnet and the patient's ECG can be observed on a monitor. See Pacing Rates Following Magnet Detection (page 70). At a future follow-up, a programmer system can be used to customize the LP programming, if desired.

NOTE: Patients with an LP cannot be followed by trans-telephone monitoring (TTM).

Specifications and Characteristics

This section describes the Aveir™ Leadless Pacemaker (LP) and Aveir™ Delivery Catheter (delivery catheter) specifications and characteristics.

Physical Specifications

The LP has the following physical specifications:

Figure 14. LP dimensions

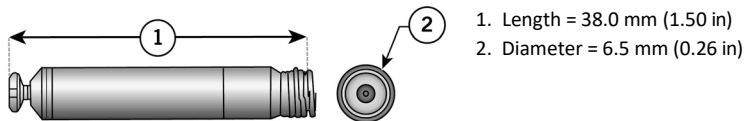

Table 5. LP physical specifications

Specification	Model LSP112V
Length	38.0 mm (1.50 in)
Diameter	6.5 mm (0.26 in)
Volume	1.1 cc

Table 5. LP physical specifications

Specification	Model LSP112V
Mass	2.4 grams
Fixation mechanism	Distal non-retractable helix
Fixation depth	~ 1.63 mm (0.064 in)

The delivery catheter has the following physical specifications:

Table 6. Delivery catheter physical specifications

Specification	Model LSCD111
Effective length	105 cm (41.3 inches)

Compatibility has been demonstrated with a 25 Fr introducer.

Pacemaker X-ray Identification

The LP has an X-ray absorptive marker for noninvasive identification.

Table 7. LP X-ray identification code

Model	Code
LSP112V	NT

Pacemaker Electrodes

The LP tip electrode is a titanium nitride-coated, platinum-iridium disc located at the center of the fixation helix. The tip electrode includes a single dose of dexamethasone sodium phosphate (DSP) intended to reduce inflammation.

The ring electrode is the uncoated part of the titanium pacemaker case.

Table 8. LP electrode physical specifications

Specification	Model LSP112V
Tip electrode geometric surface area	~ 2 mm ²
Ring electrode geometric surface area	> 127 mm ²
Inter-electrode distance	> 24 mm

Non-Programmable Parameters

Polarity: Pacing and sensing configurations in the LP are non-programmable. The LP paces and senses from the distal electrode (tip) to the pacemaker housing (ring), similar to a bipolar lead.

Pulse rate limit (runaway protection): Circuitry in the LP prevents delivery of pacing pulses at rates higher than the runaway protection rate listed below.

Table 9. LP runaway protection

Model	Runaway protection rate
LSP112V	190 bpm (-7 / +20 bpm)

Pulse rate limit is measured at $37^{\circ}\text{C} \pm 2^{\circ}\text{C}$ and $500 \Omega \pm 1\%$ load.

Input Impedance: 50 k Ω to 150 k Ω .

See Patient Follow-Up (page 60) for recommended methods for determining that the implanted pacemaker is functioning properly.

Detection Performance in the Presence of Electromagnetic Interference

The LP complies with the electromagnetic compatibility requirements of ISO 14117 clause 4.5.2 at ventricular sensitivities of 0.5 mV and less sensitive settings.

Test Pulse Sensitivity

Sensitivity was measured using the test pulse shown in the following figure.

Figure 15. Test pulse description

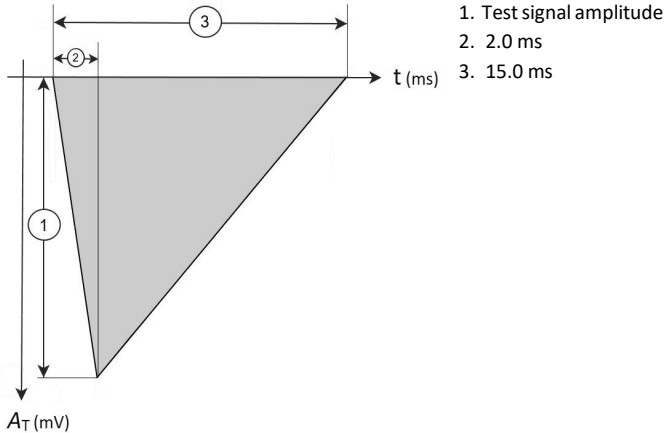

NOTE: The signal may be either positive or negative.

Pacemaker Power Source Information

Many factors affect LP service life, such as programmed parameters, percentage of time paced, load impedance, etc. Projected longevity does not account for such factors as sensor-driven pacing rate changes, effects of rate-limiting algorithms, the patient's medical condition, or effects of a specific pacing prescription. Furthermore, these longevity estimates are based on battery life projections, which are approximations.

WARNING: At recommended replacement time (RRT), the nominal life of the LP is approximately 9.5 months. The LP should be replaced expeditiously.

CAUTION: High output settings or high rates can shorten the time to RRT. High output and high rate settings can reduce the duration from RRT to end of service (EOS) to less than the nominal projected value. When the programmer indicates that the LP has reached RRT, fully evaluate the LP.

Table 10. Pacemaker power source specifications for model LSP112V

Specification	Value
Manufacturer	Greatbatch Medical
Battery type	1 Li-CFx
Model number	3851

Table 10. Pacemaker power source specifications for model LSP112V

Specification	Value
Voltage at BOS	Approximately 3 V
Voltage at RRT	2.71 V
Voltage at EOS	2.2 V
Nominal Capacity	243 mAH
Current consumption at beginning of service (BOS) at these parameters:	0% pacing (inhibited): 0.8 μ A 100% pacing: 2.3 μ A
• Pacing mode: VVIR	
• Basic rate: 50 bpm	
• Pulse amplitude: 2.5 V	
• Pulse duration: 0.4 ms	
• Pacing load: 500 Ω	

Projected Service Life

The longevity estimate tables in this section were calculated under these conditions:

- Pacing mode: VVIR
- Pulse duration: 0.4 ms

Table 11. LSP112V Projected service life (nominal longevity – BOS to RRT)

Pacing Rate	Pace Amplitude	% Pacing	Projected Service Life (in years)		
			Impedance 400 ohm	Impedance 500 ohm	Impedance 600 ohm
50 bpm	1.25 V	100%	18.3	19.6	20.6
		50%	22.6	23.6	24.3
		0%	29.7	29.7	29.7
50 bpm	2.5 V	100%	9.6	10.8	12.0
		50%	14.5	15.9	17.1
		0%	29.7	29.7	29.7

Table 11. LSP112V Projected service life (nominal longevity – BOS to RRT)

Pacing Rate	Pace Amplitude	% Pacing	Projected Service Life (in years)		
			Impedance	Impedance	Impedance
			400 ohm	500 ohm	600 ohm
60 bpm	1.25 V	100%	16.2	17.4	18.3
	2.5 V	100%	8.2	9.4	10.3
	5.0 V	100%	2.5	3.0	3.5

Table 12. LSP112V Prolonged service period (nominal longevity – RRT to EOS)

Pacing Rate	Pace Amplitude	% Pacing	Prolonged Service Period (in months)		
			Impedance	Impedance	Impedance
			400 ohm	500 ohm	600 ohm
50 bpm	1.25 V	100%	13.8	14.9	15.8
	2.5 V	100%	8.9	10.0	11.0
60 bpm	1.25 V	100	12.1	13.2	14.0
	2.5 V	100%	7.7	8.7	9.5

Pacing Rates Following Magnet Detection

When a magnet is detected by the device prior to RRT and magnet response is not set to Off, the LP paces asynchronously (VOO mode) at 100 bpm for 5 cycles and then at a rate as a function of the battery voltage thereafter until the magnet is no longer detected. Magnet rates at various battery voltages are shown in the following table.

Table 13. Pacing rates following magnet detection (prior to RRT)

Battery Voltage	Magnet Rate
$V_{\text{batt}} \geq 3.0 \text{ V}$	100 bpm
$3.0 > V_{\text{batt}} \geq 2.9 \text{ V}$	97 bpm
$2.9 > V_{\text{batt}} \geq 2.8 \text{ V}$	94 bpm
$2.8 > V_{\text{batt}} \geq 2.7 \text{ V}$	91 bpm
$2.7 > V_{\text{batt}} \geq 2.6 \text{ V}$	88 bpm
$2.6 > V_{\text{batt}}$	85 bpm

The effectiveness of magnets varies. If one magnet does not cause magnet response, place a second magnet on top of the first or try a different magnet. Pressing firmly on the magnet to decrease the distance between the magnet and the pulse generator can also help.

Product Materials

The following materials are intended to come into contact with blood or tissue:

Table 14. Materials in contact with blood or tissue

Component	Material
Leadless pacemaker	<ul style="list-style-type: none">▪ 35N LT‡▪ Alumina▪ Dexamethasone sodium phosphate (DSP)▪ MP35N‡▪ Nylon▪ Parylene▪ Polyether Ether Ketone (PEEK)▪ Silicone elastomer▪ Silicone medical adhesive Type A▪ Silicone rubber▪ Titanium Grade 2▪ Titanium nitride-coated platinum/iridium alloy
Delivery catheter	<ul style="list-style-type: none">▪ 303 and 440 stainless steel▪ Barium sulfate▪ Nitinol (nickel titanium)▪ PEBAX‡

Table 14. Materials in contact with blood or tissue

Component	Material
	<ul style="list-style-type: none">▪ Platinum-iridium▪ Polycarbonate▪ Polyether polyurethane▪ Polyethylene terephthalate (PET)▪ Polytetrafluoroethylenes (PTFE)▪ Silicone▪ Urethane UV curable adhesives

The following materials are not intended to come into contact with blood or tissue:

Table 15. Additional product materials

Component	Material
Loading tool	<ul style="list-style-type: none">▪ Acetal polyoxymethylene (POM)▪ Copolyester

Data Security

Abbott Medical takes a broad and deep approach to ensuring the safety, security and privacy of the patient information and data on our devices and systems connecting patients to healthcare providers and clinics. Patients, clinical staff, and hospital IT staff do not need to configure the pulse generator or take any special action (for example, firewall use) to safeguard patient information and device data.

To prevent unauthorized wireless data changes, all telemetry with an LP requires physical patient contact. Safeguards for the device will be provided throughout the stated warranty period or until a replacement product is available.

The cybersecurity bill of materials (CBOM) is available upon request.

Visit the information page at abbott.com/cybersecurity to read more about Abbott's commitment to cybersecurity. Periodically, Abbott may update the website with important bulletins.

Technical Support



Abbott Medical maintains 24-hour phone lines for technical questions and support:





- 1 818 362 6822
- 1 800 722 3774 (toll-free within North America)
- + 46 8 474 4147 (Sweden)
- + 61 2 9936 1200 (Australia)
- medical.abbott/manuals





For additional assistance, call your local Abbott Medical representative.







Symbols

The symbols below and harmonized symbols may be found on the product or product label. For harmonized symbols, refer to the Universal Symbols Glossary at medical.abbott/manuals.

Symbol	Description
 medical.abbott/manuals	Follow instructions for use on this website
Leadless Pacemaker	Leadless Pacemaker
	Right ventricular
	Basic rate
IOM	Initial operating mode

Symbol	Description
	Most comprehensive operating mode
VVI	Ventricular pacing, ventricular sensing, inhibited response
VVIR	Ventricular pacing, ventricular sensing, inhibited response, rate-modulated
	Bipolar Sensing/Bipolar Pacing
	Steroid-eluting
	Sensor: Core temperature
	Leadless pacemaker inside loading tool

Symbol	Description
	Product literature
	Accessories
	Excursion temperature limit. Temperature value(s) is indicated adjacent to the symbol.
Excursions permitted.	
Store at room temperature	
	Storage temperature. Temperature value(s) is indicated below the symbol.
R_x Only	For prescription use only

Symbol	Description
	Patient identification card label
	Location of implant
	Patient identification
	Implant date
	Healthcare center or physician
	Physician telephone
Delivery Catheter	Delivery Catheter

Symbol**Description**



Open pouch from corner.

UDI

Unique device identification number



Abbott Medical
15900 Valley View Court
Sylmar, CA 91342 USA
+1 818 362 6822

www.abbott.com

2021-08
ARTENG00175956 03

600175956





The Leadless II - Phase 2 Study

Summary of Clinical Results and Adverse Events



™ Indicates a trademark of the Abbott group of companies.

‡ Indicates a third-party trademark, which is property of its respective owner.

Pat. <http://www.abbott.com/patents>

© 2022 Abbott. All Rights Reserved.

Summary of Clinical Study

The Leadless II study was conducted under an Investigational Device Exemption (IDE) in two separate phases. Phase 1 evaluated the safety and effectiveness of the Nanostim Leadless Pacemaker (LP) system in a population indicated for a VVI(R) pacemaker. Since the Nanostim LP system was modified prior to market release and renamed the Aveir™ Leadless Pacemaker (LP) system, Phase 2 of this IDE study confirmed the safety and effectiveness of these modifications in the Aveir LP system.

The Leadless II – Phase 2 study met all pre-specified confirmatory safety and effectiveness endpoints. The results demonstrate that the Aveir LP system is safe and effective for single chamber pacing indications.

Study Design

The Leadless II study – Phase 1 enrolled subjects between February 2014 and June 2015 at 56 investigational sites in the U.S., Canada, and Australia. The study required a sample size of 300 subjects for the primary endpoint analysis. The Phase 1 summary includes data from 526 enrolled subjects.

The Leadless II study – Phase 2 enrolled subjects between November 2020 and June 2021 at 43 investigational sites in the U.S., Canada, and Europe. The study required a sample size of 200 subjects for the confirmatory endpoint analysis. The Phase 2 summary includes data from these 200 enrolled subjects.

The Phase 2 study used an independent Data Safety Monitoring Board that was responsible for informing Abbott Medical of any safety or compliance issues and a Clinical Events Committee (CEC) that was responsible for adjudicating adverse events reported during the IDE study.

All subjects enrolled in the Phase 2 study were scheduled to return for follow-up examinations at pre-discharge, 2 weeks, 6 weeks, 3 months, 6 months after implant and every 6 months thereafter until study completion. Subjects who underwent unsuccessful implantation were followed for a period of 30 days prior to withdrawal from the study.

Preoperatively, subjects were evaluated in accordance with the inclusion/exclusion criteria. Postoperatively, information from chest x-rays, electrical testing, rate response, and device interrogation were evaluated. Adverse events and complications were recorded at all visits.

The key timepoints are shown in the flowchart below summarizing safety and effectiveness.

Figure 1. Phase 2 Follow-Up Schedule Flowchart

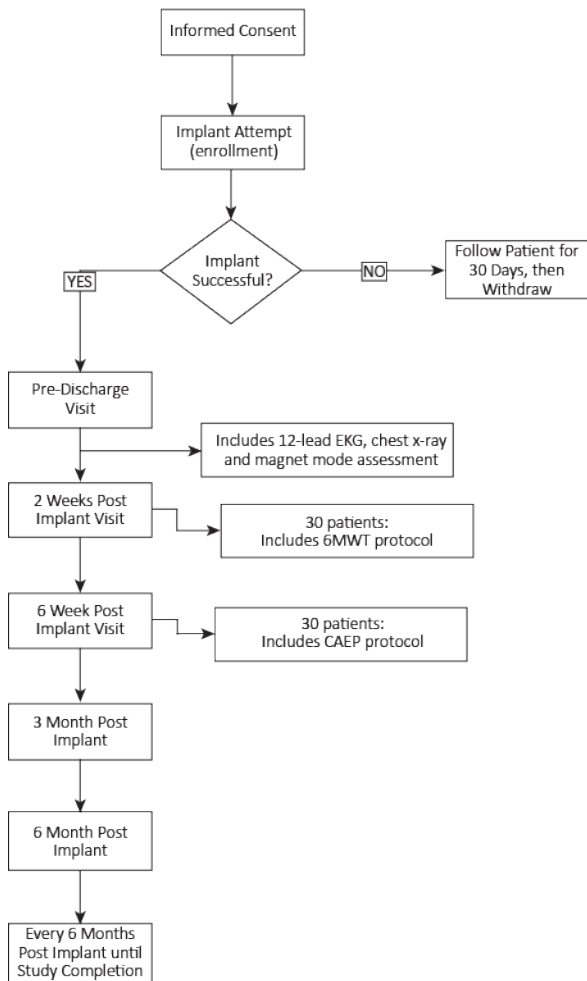

Clinical Inclusion and Exclusion Criteria

Enrollment in the Leadless II – Phase 2 study was limited to patients who met all the following inclusion criteria:

- Subject must have one of the clinical indications before device implant in adherence with Medicare, ACC/AHA/HRS/ESC single chamber pacing guidelines including:
 - Chronic and/or permanent atrial fibrillation with 2 or 3° atrioventricular or bifascicular bundle branch block (BBB block), including slow ventricular rates (with or without medication) associated with atrial fibrillation
 - Normal sinus rhythm with 2 or 3° atrioventricular or BBB block and a low level of physical activity or short expected lifespan (but at least one year)
 - Sinus bradycardia with infrequent pauses or unexplained syncope with electrophysiology study findings
- Subject is ≥18 years of age
- Subject has a life expectancy of at least one year
- Subject is not enrolled in another clinical investigation
- Subject is willing to comply with clinical investigation procedures and agrees to return for all required follow-up visits, tests, and exams
- Subject has been informed of the nature of the study, agrees to its provisions, and has provided a signed written informed consent, approved by the Institutional Review Board/Ethics Committee
- Subject is not pregnant and does not plan to get pregnant during the course of the study

Patients were **not** permitted to enroll in the Leadless II – Phase 2 study if they met any of the following exclusion criteria:

- Subject has known pacemaker syndrome, has retrograde ventriculo-atrial conduction, or suffers a drop in arterial blood pressure with the onset of ventricular pacing
- Subject is allergic or hypersensitive to < 1 mg of dexamethasone phosphate
- Subject has a mechanical tricuspid valve prosthesis
- Subject has a pre-existing endocardial pacing or defibrillation leads
- Subject has current implantation of either conventional or subcutaneous implantable cardioverter defibrillator or cardiac resynchronization therapy device
- Subject has an implanted vena cava filter
- Subject has evidence of thrombosis in one of the veins used for access during the procedure
- Subject had recent cardiovascular or peripheral vascular surgery within 30 days of enrollment
- Subject has an implanted leadless cardiac pacemaker
- Subject is implanted with an electrically active implantable medical device with stimulation capabilities (such as neurological or cardiac stimulators)

Phase 2 Clinical Endpoints

The Phase 2 confirmatory safety and effectiveness endpoints were identical to the Phase 1 primary safety and effectiveness endpoints, except for the timepoint of evaluation. The Phase 1 primary endpoints were evaluated at 6 months post-implant, while the Phase 2 confirmatory endpoints were evaluated at 6 weeks post-implant since it had been previously demonstrated that the overwhelming majority of complications occur within 30 days, most within 14 days.

Confirmatory Safety Endpoint

The confirmatory safety endpoint evaluated a 6-week complication-free rate (CFR) based on CEC adjudication of adverse events. A complication was defined as a device-or-procedure-related serious adverse event (SADE), including those that prevented implantation.

Confirmatory Effectiveness Endpoint

The confirmatory effectiveness endpoint evaluated the 6-week composite success rate based on pacing thresholds and R-wave amplitudes within a therapeutic range.

Table 1. Acceptable Ranges for Sensing and Pacing

Parameter	Acceptable Test Values
Pacing voltage	Pacing threshold ≤ 2.0 V at 0.4 ms
R Sensitivity	R-wave amplitude ≥ 5.0 mV or ≥ value at implant

Confirmatory Secondary Endpoint #1

The confirmatory secondary endpoint #1 evaluated an appropriate and proportional rate response during a Chronotropic Assessment Exercise Protocol (CAEP) exercise protocol.

The analysis of the exercise test data provided an estimate of the slope of the normalized increase in sensor-indicated rate versus normalized CAEP workload for each subject.

Secondary Endpoint #2

The secondary endpoint #2 estimated the 2-year survival rate of subjects implanted with the Nanostim LP using the Kaplan-Meier method of all-cause mortality. The 2-year survival rate was calculated based on subjects implanted with the Nanostim LP since only Phase 1 subjects had 2-year follow-up during the study.

Safety and Effectiveness Results

The following sections summarize the safety and effectiveness results of the Aveir LP system evaluated during Phase 2 of the Leadless II Study. Since Phase 2 is a confirmatory study, the key results from Phase 1 are also included.

Subject Accountability

Phase 2: The analyses of the confirmatory safety and effectiveness endpoints were performed on 200 enrolled subjects who met enrollment criteria, provided signed informed consent, and who had an attempted implant of the Aveir LP. All 200 enrolled subjects either completed a 6-week visit, withdrew or died before the 6-week visit, or crossed their 6-week visit window without completing a 6-week visit (i.e., missed visit).

An Aveir LP was successfully implanted in 196 of the 200 (98.0%) subjects enrolled. The four (4) subjects in whom implant attempts were unsuccessful were withdrawn from the study at 30 days. Of the 196 subjects who underwent a successful implant, 191 subjects completed the 6-week visit. Of the five (5) subjects who did not complete a 6-week visit, one (1) died before the visit and four (4) subjects missed the visit.

Phase 1: The analyses of the primary safety and effectiveness endpoints were performed on 300 enrolled subjects who met enrollment criteria, provided signed informed consent, and who had an attempted implant of the Nanostim LP. All 300 subjects either completed a 6-month visit, withdrew or died before the 6-month visit, or crossed their 6-month visit window without completing a 6-month visit (i.e., missed visit).

A Nanostim LP was successfully implanted in 289 of the 300 (96.3%) subjects enrolled. The eleven (11) subjects in whom implant attempts were unsuccessful were withdrawn from the study at 30 days. Of the 289 subjects who underwent a successful implant, 271 subjects completed the 6-month visit. Of the 18 subjects who did not complete a 6-month visit, 12 died before the visit, four (4) withdrew prior to 6 months, and the remaining two (2) subjects did not complete the visit.

Table 2. Subject Accountability Summary

Subject Disposition	Phase 2 - Aveir	Phase 1 - Nanostim
Subjects Enrolled with an Attempted Implant	200	300
Subjects with a Successful Implant	196 (98.0%)	289 (96.3%)
Subjects Completing the Endpoint Visit	191 (95.5%)	271 (90.3%)
Subject Death Prior to the Endpoint Visit	1 (0.5%)	12 (4.4%)
Subject Withdrew Prior to the Endpoint Visit	0 (0.0%)	4 (1.5%)
Subject Missed the Endpoint Visit	4 (2.1%)	2 (0.7%)

Study Population Demographics and Baseline Characteristics

The demographics and baseline characteristics of the study population are comparable to the overall population who meet the requirements of single-chamber ventricular pacing.

In Phase 2 of this study, the average age of patients was approximately 76 years and 63% were male, which is comparable to other pacemaker studies. The baseline characteristics for this study population was significant for hypertension, hyperlipidemia, diabetes, and most patients (57%) had a pacing indication for chronic atrial fibrillation and atrioventricular block. The demographics and baseline characteristics are similar between both Phase 1 and Phase 2 subjects in this study.

The following tables summarize the demographic and baseline characteristics of subjects enrolled in Phase 1 and Phase 2 of the Leadless II study.

Table 3. Study Demographics

Demographic Variable	Phase 2 - Aveir (N=200)	Phase 1 - Nanostim (N=300)
Age (years)		
Mean ± SD (n) (Min, Max)	75.6 ± 11.3 (200) (27.0, 95.0)	75.7 ± 11.6 (300) (30.3, 96.7)
Gender		
Male	62.5% (125/200)	64.3% (193/300)
Female	37.5% (75/200)	35.7% (107/300)
BMI (kg/m ²)		
Mean ± SD (n) (Min, Max)	28.4 ± 5.9 (200) (16.9, 53.3)	29.2 ± 7.3 (300) (15.8, 60.3)

Race		
American Indian /Alaska Native	0.0% (0/200)	0.3% (1/300)
Asian	1.0% (2/200)	2.3% (7/300)
Black/African American	1.5% (3/200)	7.0% (21/300)
Native Hawaiian/Pacific Islander	0.0% (0/200)	0.0% (0/300)
White or Caucasian	67.0% (134/200)	89.7% (269/300)
Other (Not Specified)	0.5% (1/200)	0.7% (2/300)
Declined or Unable to Disclose Due to Local Regulation*	29.5% (59/200)	0.0% (0/300)
Unknown	0.5% (1/200)	0.0% (0/300)
Ethnicity		
Hispanic or Latino	2.5% (5/200)	4.3% (13/300)
Non-Hispanic or Latino	65.5% (131/200)	95.7% (287/300)
Other (Not Specified)	0% (0/200)	0.0% (0/300)
Declined or Unable to Disclose Due to Local Regulation*	29.5% (59/200)	0.0% (0/300)
Unknown	2.5% (5/200)	0.0% (0/300)

*Note: Race and ethnicity data were not collected at European centers due to local data privacy regulations.

Table 4. Subject Baseline Characteristics

Medical History Variable	Phase 2 - Aveir (N=200)	Phase 1 - Nanostim (N=300)
LV Ejection Fraction (%)		
Mean \pm SD (n) (Min, Max)	58.8 \pm 7.8 (161) (25.0, 76.0)	57.1 \pm 8.2 (273) (25.0, 80.0)
Primary Pacemaker Indication		
Chronic AF with 2nd or 3rd degree AV block	52.5% (105/200)	57.0% (171/300)
Sinus rhythm with 2nd or 3rd degree AV block and a low level of physical activity or short expected lifespan	24.0% (48/200)	9.0% (27/300)
Sinus bradycardia with infrequent pauses or unexplained syncope with EP findings	23.5% (47/200)	34.0% (102/300)
Congestive Heart Failure	16.0% (32/200)	14.3% (43/300)
NYHA Class		
Class I	1.5% (3/200)	3.7% (11/300)
Class II	5.5% (11/200)	6.7% (20/300)
Class III	4.5% (9/200)	1.0% (3/300)
Class IV	0.5% (1/200)	0.0% (0/300)
Not Done	4.0% (8/200)	3.0% (9/300)
Hypertension		
Controlled with Medication(s)	69.0% (138/200)	77.0% (231/300)
Uncontrolled	2.5% (5/200)	7.0% (21/300)
Controlled without Medication(s)	0.0% (0/200)	0.0% (0/300)
Diabetes		
Type I	1.0% (2/200)	0.7% (2/300)
Type II	27.0% (54/200)	26.7% (80/300)
Diabetes Current Status		
Controlled with Diet	4.0% (8/200)	4.7% (14/300)

Controlled with Medication(s)	24.0% (48/200)	22.0% (66/300)
Uncontrolled	0.0% (0/200)	0.7% (2/300)
Hyperlipidemia		
Controlled with Diet	4.0% (8/200)	11.0% (33/300)
Controlled with Medication(s)	50.5% (101/200)	56.3% (169/300)
Uncontrolled	2.0% (4/200)	2.0% (6/300)
Peripheral Vascular Disease	10.0% (20/200)	15.0% (45/300)
Coronary Artery Disease	25.5% (51/200)	40.3% (121/300)
Myocardial Infarction	10.0% (20/200)	14.0% (42/300)
Unstable Angina	6.5% (13/200)	3.3% (10/300)
Prior PTCA/Stents/Atherectomy	12.5% (25/200)	15.7% (47/300)
Prior CABG	9.0% (18/200)	16.0% (48/300)
Prior Ablation		
AV Nodal	0.0% (0/200)	1.7% (5/300)
AFib/Aflutter	12.0% (24/200)	7.0% (21/300)
VT	0.0% (0/200)	0.0% (0/300)
AT	1.5% (3/200)	0.0% (0/300)
Mini Maze, Thoracoscopy/LAA Ligation	0.0% (0/200)	0.3% (1/300)
SVT/AVNRT	0.5% (1/200)	1.3% (4/300)
Tricuspid Valve Disease		
Insufficiency/Prolapse/Regurgitation	25.5% (51/200)	20.0% (60/300)
Repair/Replacement	1.0% (2/200)	1.0% (3/300)
Stenosis	0.0% (0/200)	0.0% (0/300)
Arrhythmia History		
Ventricular (non-sustained)	4.0% (8/200)	5.0% (15/300)
Non-Ventricular/Supraventricular	71.0% (142/200)	77.0% (231/300)
Medications		
Antiarrhythmics (Class I)	3.5% (7/200)	2.3% (7/300)
Antiarrhythmics (Class III)	6.5% (13/200)	7.3% (22/300)
Anticoagulants	61.0% (122/200)	60.0% (180/300)
Antiplatelets	36.0% (72/200)	47.7% (143/300)
ACE Inhibitors	27.0% (54/200)	26.7% (80/300)
Angiotensin Receptor Blockers	26.0% (52/200)	20.7% (62/300)
Beta Blockers	38.0% (76/200)	40.0% (120/300)

Safety and Effectiveness Results

Safety Results

The analysis of safety was based on the enrolled population, excluding subjects that withdrew from the study or died prior to the endpoint visit without a complication. The key safety outcomes for this study are presented in the Safety Endpoint Analysis table. Serious Adverse Device Effects (SADEs) are reported in the Serious Adverse Device Effects table.

In Phase 2, among the enrolled patient population of 200 subjects, the safety endpoint analysis was conducted on 198 evaluable subjects at 6 weeks post-implant. Of the two (2) subjects excluded from the analysis, one (1) died due to a non-cardiac cause without a complication as determined by the CEC, and one (1) withdrew due to an unsuccessful implant without an associated complication.

Eight (8) subjects experienced 9 complications (i.e. SADEs) as adjudicated by the CEC. The Safety Endpoint Analysis table presents the estimated CFR along with the 95% confidence interval. The estimated CFR was 96.0% with a 95% confidence interval (92.2%, 98.2%), the lower bound of which exceeded the performance goal of 86%. Hence, the null hypothesis was rejected at the 2.5% significance level and the confirmatory safety endpoint was met.

Since Phase 2 is a confirmatory study, the table below also shows the primary safety endpoint analysis results from Phase 1, which evaluated the Nanostim LP system through 6 months post-implant. In Phase 1, the primary safety endpoint was met. All complications in the primary analysis cohort for Phase 1 occurred within 30 days of implant; therefore, the 6-month CFR in Phase 1 is comparable to the 6-week CFR in Phase 2.

Table 5. Primary (Phase 1) and Confirmatory (Phase 2) Safety Endpoint Analysis

Analysis Population	Number of Subjects in Analysis	Number of Events	Number of Subjects with Events	% Subjects Meeting Success Criteria	95% Confidence Interval ¹	P-value ² (PG=86%)	Endpoint met (Yes/No)?
Phase 2 Aveir: Enrolled	198	9	8	96.0%	[92.2%, 98.2%]	<0.001	Yes
Phase 1 Nanostim: Enrolled	300	22	20	93.3%	[89.9%, 95.9%]	<0.001	Yes

¹ 95% Confidence Interval using Clopper-Pearson Exact method.

² From one-sided exact test for Binomial proportion. P-value compared with the 0.025 significance level.

The figure below is a Kaplan-Meier analysis of CFR through 6 months by study phase among the enrolled Phase 1 Nanostim cohort and the Phase 2 Aveir confirmatory cohort.

The overall CFRs between the Phase 1 and Phase 2 cohorts are similar. The figure below also shows that an overwhelming majority of complications occurred within the first 30 days and is consistent with what has been demonstrated with other LP devices (FDA’s Executive Summary on leadless pacemaker devices for the Advisory Panel, February 2016).

In addition, the 6-month CFR for the Phase 1 Nanostim cohort (93.3%, with a standard error of 1.4% and 95% confidence interval: 89.8%, 95.6%) and Phase 2 Aveir confirmatory cohort (94.9%, with a standard error of 1.8% and 95% confidence interval: 90.0%, 97.4%) are similar.

Figure 2. Kaplan-Meier Analysis of CFR through 6 Months – Cohort Comparison (Enrolled Population)

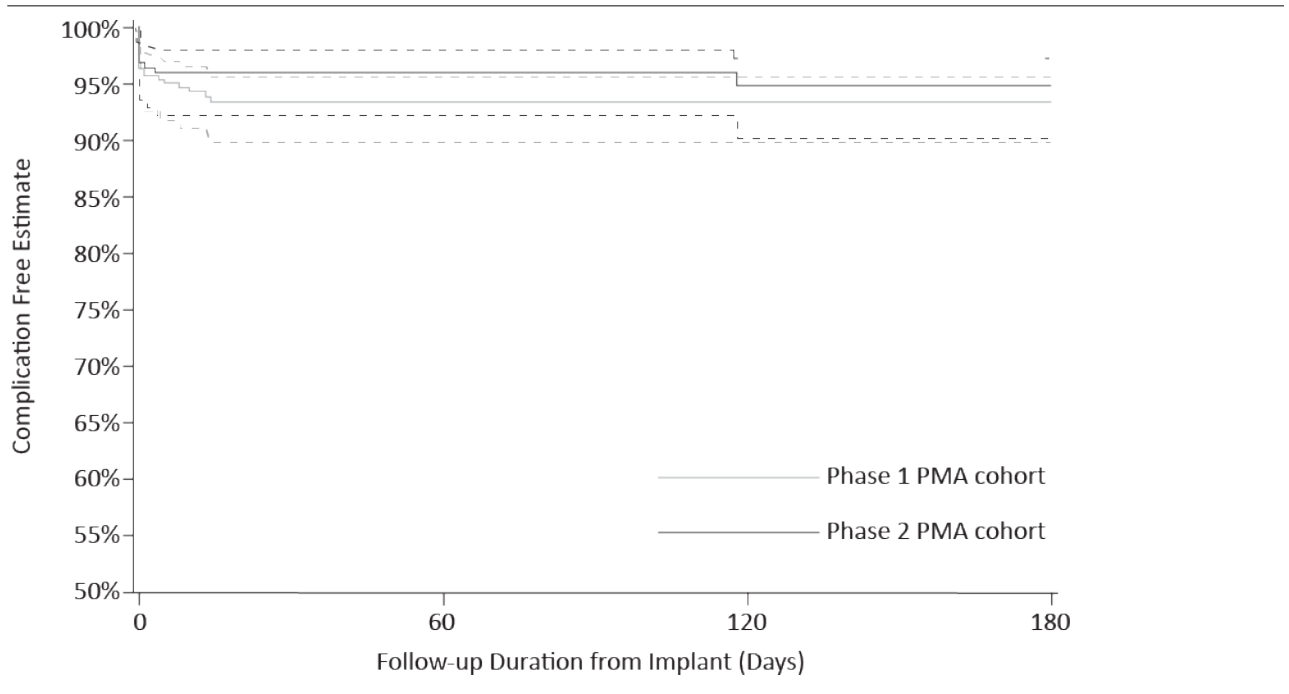

Follow-up Duration from Implant (Days)		0	30	60	120	180
Cohort	Data Category					
Phase 2 Cohort	# At Risk	200	191	166	83	33
	# Events	6	8	8	9	9
	Event Rate (%)	3.0%	4.0%	4.0%	5.1%	5.1%

	CFR (%)	97.0%	96.0%	96.0%	94.9%	94.9%
	Standard Error (%)	1.2%	1.4%	1.4%	1.8%	1.8%
	95% Confidence Interval	(93.4%, 98.6%)	(92.2%, 98.0%)	(92.2%, 98.0%)	(90.0%, 97.4%)	(90.0%, 97.4%)
Phase 1 Cohort	# At Risk	300	278	267	264	262
	# Events	11	20	20	20	20
	Event Rate (%)	3.7%	6.7%	6.7%	6.7%	6.7%
	CFR (%)	96.3%	93.3%	93.3%	93.3%	93.3%
	Standard Error (%)	1.1%	1.1%	1.4%	1.4%	1.4%
	95% Confidence Interval	(93.5%, 98.0%)	(89.8%, 95.6%)	(89.8%, 95.6%)	(89.8%, 95.6%)	(89.8%, 95.6%)

NOTE: For subjects with Aveir that did not experience an event (complication), analysis is censored at their Termination/Death/Data Cutoff Date.

Complications Reported in the Clinical Study

A complication was defined as a device-or-procedure related serious adverse event (SADE), including any adverse event that prevented initial implantation.

The table below summarizes the complications (SADEs) in Phase 1 and Phase 2 of this study. The overall SADE subject event rate (4.0%) for the Phase 2 enrollment population (n=200) through 6 weeks is lower than the SADE subject event rate (6.7%) for Phase 1 among the primary analysis cohort (n=300) through 6 months post-implant. The SADEs in the primary analysis cohort for Phase 1 all occurred within 30 days post-implant, therefore, the Phase 1 SADE rate through 6 months is comparable to the Phase 2 SADE rate through 6 weeks.

The most frequent complications in Phase 2 were three (3) cardiac tamponade events (1.5%) and three (3) premature deployment events (1.5%). The rates of cardiac perforation/tamponade/pericardial effusion in Phase 1 and Phase 2 are similar at 1.3% and 1.5%, respectively. The premature deployment events were not reported as adverse events during Phase 1.

Dislodgement events were completely absent in Phase 2, compared to a rate of 1.7% in Phase 1 which took place within 14 days post-implant. In addition, there was a reduction in all-cause serious access site complication events, with Phase 2 reporting only one (1) serious access site bleeding event (0.5%) compared to Phase 1 reporting four (4) events (1.3%) that included AV fistula, pseudoaneurysm, and bleeding.

Table 6. Serious Adverse Device Effects

Event Description	Phase 2 - Aveir		Phase 1 - Nanostim	
	Number of Events	% of Subjects with Events (n/N)	Number of Events	% of Subjects with Events (n/N)
Cardiac Perforation/Tamponade	3	1.5% (3/200)	4	1.3% (4/300)
Other:				
Premature Deployment with Migration	2	1.0% (2/200)	0	0.0% (0/300)
Premature Deployment without Migration	1	0.5% (1/200)	0	0.0% (0/300)
Vascular Access Site Complication: Bleeding	1	0.5% (1/200)	2	0.7% (2/300)
Embolism	1	0.5% (1/200)	1	0.3% (1/300)
Thrombosis	1	0.5% (1/200)	0	0.0% (0/300)
Device Dislodgement	0	0.0% (0/200)	5	1.7% (5/300)
Threshold Elevation Resulting in Retrieval of LP	0	0.0% (0/200)	4	1.3% (4/300)
Vascular Access Site Complication: AV Fistula	0	0.0% (0/200)	1	0.3% (1/300)
Vascular Access Site Complication: Pseudoaneurysm	0	0.0% (0/200)	1	0.3% (1/300)
Asystole During Implant Procedure	0	0.0% (0/200)	1	0.3% (1/300)
Ventricular Tachycardia During Implant Procedure	0	0.0% (0/200)	1	0.3% (1/300)
Pericarditis	0	0.0% (0/200)	1	0.3% (1/300)
Weakness Secondary to Orthostatic Hypotension	0	0.0% (0/200)	1	0.3% (1/300)
Total	9	4.0% (8*/200)	22	6.7% (20*/300)

Effectiveness Results

The analysis of effectiveness was based on the successfully implanted population. A subject with a successful implant was defined as a subject who left the implant procedure with an implanted and functioning LP device. For subjects with missing 6-week pacing threshold or R-wave amplitude (not due to pacer dependence, complete heart block, or AV node/AV junctional ablation) data, the last observation carried forward was used in the analysis. For subjects that did not have R-wave amplitude measured due to pacer dependence or AV nodal/AVJ ablation, success was determined from pacing threshold only. The key effectiveness outcomes for this study are presented in the following table.

In Phase 2, among the enrolled patient population of 200 subjects, the effectiveness endpoint analysis was conducted on 196 successfully implanted subjects. Of these 196 subjects, 171 had measurable pacing thresholds and sensing amplitudes at the 6-week visit. An additional 17 subjects only had pacing thresholds available. For these subjects, the R-wave was not measurable due to pacing dependence, AV nodal, or AV junctional ablation. Thus, pacing threshold alone determined whether the subject met success criteria. The remaining 8 subjects had their last observations carried forward.

The following table presents the composite success rate along with the 95% confidence interval. In Phase 2, the 6-week composite success rate was 95.9% with a 95% confidence interval (92.1%, 98.2%), the lower bound of which exceeded the performance goal of 85%. Hence, the null hypothesis was rejected at the 2.5% significance level, and the confirmatory effectiveness endpoint was met.

Comparatively, the 6-month composite success evaluated for the primary efficacy endpoint during Phase 1 was 93.4% with a 95% confidence interval of (89.9%, 96.0%). In Phase 1, the primary effectiveness endpoint was met.

Table 7. Primary (Phase 1) and Confirmatory (Phase 2) Effectiveness Endpoint Analysis

Analysis Population	Number of Subjects in Analysis (N)	Number of Subjects Meeting Criteria (n)	Success Rate % (n/N)	95% Confidence Interval ¹	P-value ² (PG=85%)	Endpoint met (Yes/No)?
Phase 2 Aveir: Successful Implant Population	196	188	95.9%	[92.1%, 98.2%]	<0.001	Yes
Phase 1 Nanostim: Successful Implant Populations	289	270	93.4%	[89.9%, 96.0%]	<0.001	Yes

¹ 95% Confidence Interval using Clopper-Pearson Exact method.

² From one-sided exact test for Binomial proportion. P-value compared with the 0.025 significance level.

Summary of Supplemental Clinical Information

Device Electrical Measurements - Phase 2 Cohort

The mean capture threshold was below, and the sensing amplitude above, the acceptable values identified in the study protocol for the effectiveness endpoint and were stable over time. The following figure contains summaries of device electrical measurements from implant, pre-discharge, and scheduled follow-up visits on the 196 subjects with a successful implant from Phase 2 of this study.

Figure 3. Aveir LP Device Electrical Measurements

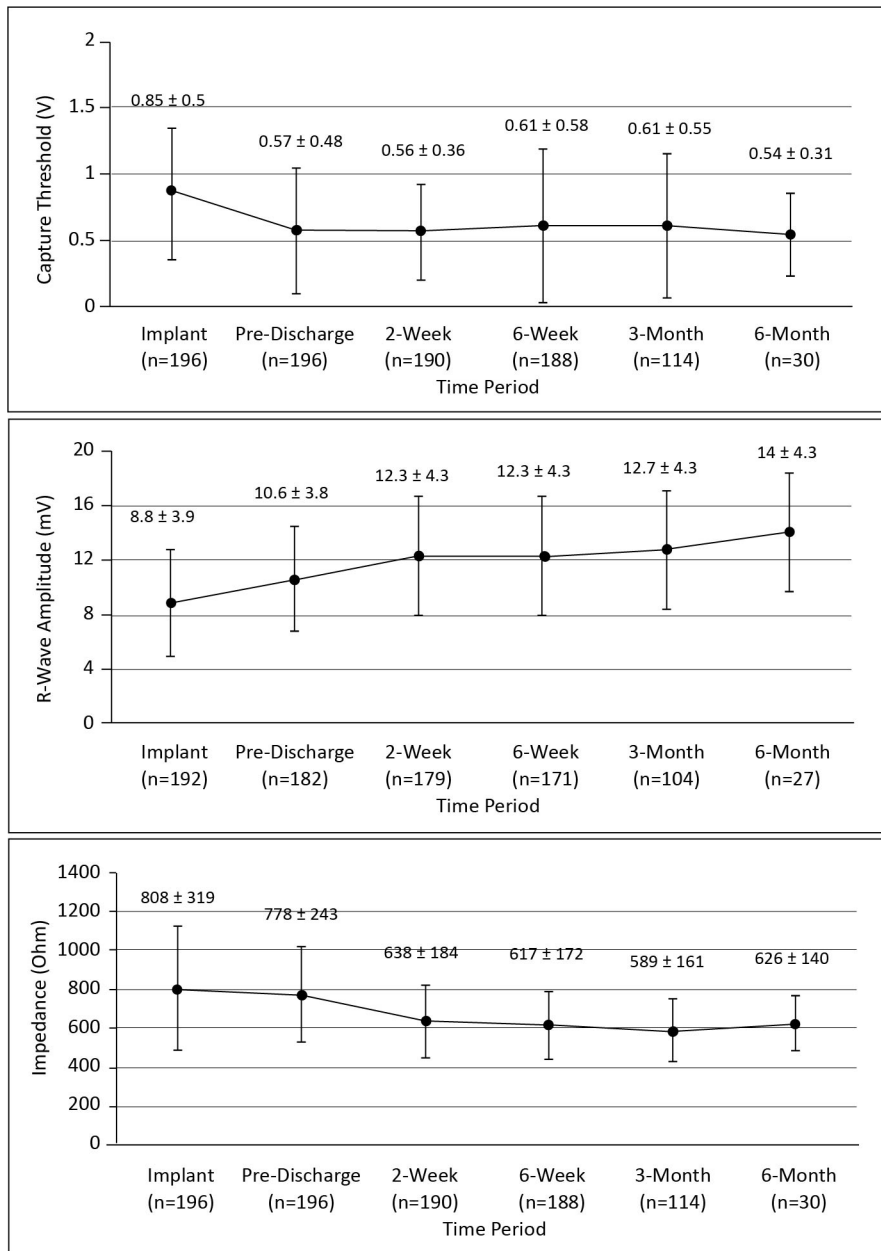

Secondary Endpoint Results

Confirmatory Secondary Endpoint #1 - Rate Response During Exercise

The temperature-based rate response feature in the Aveir LP was assessed to support the confirmatory secondary endpoint #1 by evaluating whether an appropriate and proportional rate response was achieved during graded exercise testing.

A total of 23 subjects underwent a subject-specific sensor parameter optimization and the CAEP assessment. Among the 23 subjects, 18 completed at least stage 3 of the CAEP exercise protocol, thus achieving a workload of at least 3.6 metabolic equivalent of task (METs). One (1) subject who completed stage 3 did not follow the CAEP protocol and was not considered analyzable. Therefore, a total of 17 subjects were considered analyzable for the confirmatory secondary endpoint which exceeded the minimum sample size of eight (8) required.

The following table presents the mean slope of the normalized increase in sensor-indicated rate versus normalized CAEP workload for each subject among the analyzable population. The mean slope of 0.93 ± 0.29 with a 95% confidence interval (0.78, 1.08) fell within the 35% equivalence margin (0.65, 1.35) with statistical significance ($p < 0.001$). Hence, the null hypothesis was rejected and the confirmatory secondary endpoint #1 was met.

Table 8. Confirmatory Secondary Endpoint #1 Analysis - Rate Response

Analysis Population	Slope Mean ± SD (n)	95% Confidence Interval (CI)	Equivalence Bounds	P-value ¹	Endpoint met (Yes/No)?
Phase 2 Aveir: Subject-specific optimized gain	0.93 ± 0.29 (17)	(0.78, 1.08)	0.65 < CI < 1.35	0.001	Yes
Phase 1 Nanostim: Default gain of 3	0.51 ± 0.18 (30)	(0.44, 0.58)	0.65 < CI < 1.35	0.001	No

¹ P-value calculated by two one-sided T-test (TOST)

Phase 1 also evaluated the rate response feature for its secondary endpoint using the same criteria and analysis methods used for the confirmatory secondary endpoint during Phase 2; however, this endpoint was not met in Phase 1 since all subjects during this phase performed the CAEP with a sensor gain programmed to a default setting of 3. This standardized approach was considered a worst-case analysis because the sensor gain settings were generalized and not customized for each subject.

The Phase 2 approach of optimizing the gain settings during the six-minute walk test (6MWT) was intended to reflect clinical use, where physicians would customize the sensor gain settings to each subject.

Secondary Endpoint #2 - 2-year Survival Rate

The secondary endpoint #2 estimates the 2-year survival rate of patients successfully implanted with the Nanostim LP during Phase 1 only (n=917) using the Kaplan-Meier method of all-cause mortality.

The following figure shows the survival probability (event free rate) and 95% confidence intervals at 180-day intervals through 2 years.

Figure 4. Kaplan-Meier Analysis of Survival through 2 Years for Phase-1 (Phase 1 – Nanostim Implanted Subjects)

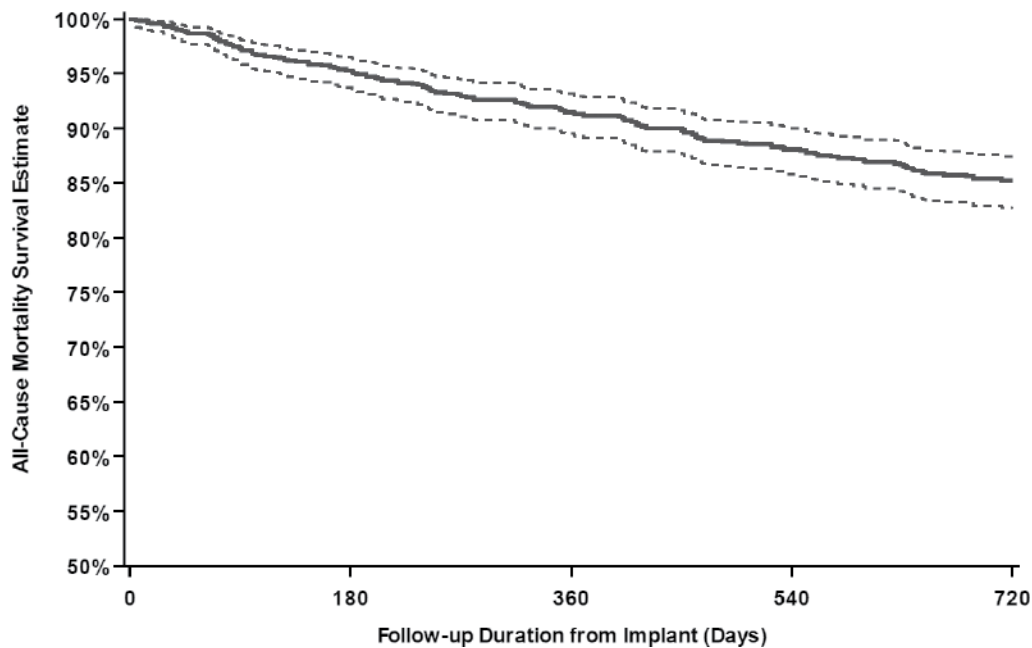

Follow-up Duration from Implant (Days)	0	180	360	540	720
Data Category	0	180	360	540	720
# At Risk	917	863	816	762	703
# Events	0	43	77	107	131
Event Rate (%)	0.0%	4.7%	8.5%	11.9%	14.7%
Survival Rate (%)	100.0%	95.3%	91.5%	88.1%	85.3%
Standard Error (%)	0.0%	0.7%	0.9%	1.1%	1.2%
95% Confidence Interval	(100.0%, 100.0%)	(93.7%, 96.5%)	(89.5%, 93.1%)	(85.8%, 90.0%)	(82.7%, 87.4%)

The following table presents the survival probability estimate, with standard error, and upper and lower 95% confidence intervals at 2 years. Among the 917 successfully implanted subjects in the Leadless II Study – Phase 1, the estimated survival rate was 85.3%, with a standard error of 1.2%. The

95% confidence interval for the estimate is (82.7%, 87.4%), of which the lower bound exceeded the performance goal of 80% (p<0.0001). Hence, secondary endpoint #2 was met.

Table 9. Secondary Endpoint #2 - Kaplan Meier Analysis for 2-year Survival for Phase-1 (Phase 1 – Nanostim Implanted Subjects)

	Estimate (SE) ¹	95% Confidence Interval	P-Value ² (PG=80%)	Endpoint Met
2-year Survival	85.3% (1.2%)	[82.7%, 87.4%]	< 0.0001	Yes

¹ Kaplan-Meier method used to estimate the event rate with Greenwood standard error.

² P-Value is based on Z test and compared with the 0.025 significance level.

Study Conclusions

The clinical study results demonstrate the safety and effectiveness of the Aveir VR Leadless System in a population indicated for a VVI(R) pacemaker. In the clinical study, the confirmatory safety endpoint was met as the 6-week CFR among 200 enrolled subjects was 96.0%, of which the one sided 97.5% lower confidence bound, 92.2%, exceeded the performance goal of 86% with statistical significance (p<0.0001). The confirmatory effectiveness endpoint was met as the 6-week composite success rate among 196 successfully implanted subjects was 95.9%, of which the one-sided 97.5% lower confidence bound, 92.1%, exceeded the performance goal of 85% with statistical significance (p<0.0001).

The rate response assessment in the clinical study demonstrated an appropriate and proportional rate response during graded exercise testing. The mean slope of the normalized increase in sensor- indicated rate versus normalized CAEP workload for each subject among 17 analyzable subjects was 0.93 ± 0.29 with a 95% confidence interval (0.78, 1.08), which fell within the pre-specified success criterion of a 35% equivalence margin (0.65, 1.35), with statistical significance (p<0.001). Finally, the 2-year estimated survival rate for Phase I subjects was 85.3%, of which the one-sided 97.5% lower bound, 82.7%, exceeded the performance goal of 80% with statistical significance (p<0.0001).

The Leadless II Study – Phase 2 met the pre-specified performance goals for both the confirmatory safety (freedom from SADEs) and effectiveness (acceptable pacing and sensing) endpoints. The study also met both secondary endpoints. These results showed that the Aveir LP System is safe and effective for single chamber pacing indications.



Abbott Medical
15900 Valley View Court
Sylmar, CA 91342 USA
+1 818 362 6822

www.abbott.com

2022-03
ARTEN600259140 B

600259140

