



SNUCONE Co., LTD.
% Sanglok Lee
Manager
Wise Company Inc.
#507, #508, 166 Gasan digital 2-ro
Geumcheon-gu, Seoul 08503
KOREA, SOUTH

Re: K210354

Trade/Device Name: SNUCONE Bone Level Implant System
Regulation Number: 21 CFR 872.3640
Regulation Name: Endosseous Dental Implant
Regulatory Class: Class II
Product Code: DZE, NHA
Dated: June 8, 2022
Received: June 10, 2022

Dear Sanglok Lee:

We have reviewed your Section 510(k) premarket notification of intent to market the device referenced above and have determined the device is substantially equivalent (for the indications for use stated in the enclosure) to legally marketed predicate devices marketed in interstate commerce prior to May 28, 1976, the enactment date of the Medical Device Amendments, or to devices that have been reclassified in accordance with the provisions of the Federal Food, Drug, and Cosmetic Act (Act) that do not require approval of a premarket approval application (PMA). You may, therefore, market the device, subject to the general controls provisions of the Act. Although this letter refers to your product as a device, please be aware that some cleared products may instead be combination products. The 510(k) Premarket Notification Database located at <https://www.accessdata.fda.gov/scripts/cdrh/cfdocs/cfpmn/pmn.cfm> identifies combination product submissions. The general controls provisions of the Act include requirements for annual registration, listing of devices, good manufacturing practice, labeling, and prohibitions against misbranding and adulteration. Please note: CDRH does not evaluate information related to contract liability warranties. We remind you, however, that device labeling must be truthful and not misleading.

If your device is classified (see above) into either class II (Special Controls) or class III (PMA), it may be subject to additional controls. Existing major regulations affecting your device can be found in the Code of

Federal Regulations, Title 21, Parts 800 to 898. In addition, FDA may publish further announcements concerning your device in the Federal Register.

Please be advised that FDA's issuance of a substantial equivalence determination does not mean that FDA has made a determination that your device complies with other requirements of the Act or any Federal statutes and regulations administered by other Federal agencies. You must comply with all the Act's requirements, including, but not limited to: registration and listing (21 CFR Part 807); labeling (21 CFR Part 801); medical device reporting (reporting of medical device-related adverse events) (21 CFR 803) for devices or postmarketing safety reporting (21 CFR 4, Subpart B) for combination products (see <https://www.fda.gov/combination-products/guidance-regulatory-information/postmarketing-safety-reporting-combination-products>); good manufacturing practice requirements as set forth in the quality systems (QS) regulation (21 CFR Part 820) for devices or current good manufacturing practices (21 CFR 4, Subpart A) for combination products; and, if applicable, the electronic product radiation control provisions (Sections 531-542 of the Act); 21 CFR 1000-1050.

Also, please note the regulation entitled, "Misbranding by reference to premarket notification" (21 CFR Part 807.97). For questions regarding the reporting of adverse events under the MDR regulation (21 CFR Part 803), please go to <https://www.fda.gov/medical-devices/medical-device-safety/medical-device-reporting-mdr-how-report-medical-device-problems>.

For comprehensive regulatory information about medical devices and radiation-emitting products, including information about labeling regulations, please see Device Advice (<https://www.fda.gov/medical-devices/device-advice-comprehensive-regulatory-assistance>) and CDRH Learn (<https://www.fda.gov/training-and-continuing-education/cdrh-learn>). Additionally, you may contact the Division of Industry and Consumer Education (DICE) to ask a question about a specific regulatory topic. See the DICE website (<https://www.fda.gov/medical-devices/device-advice-comprehensive-regulatory-assistance/contact-us-division-industry-and-consumer-education-dice>) for more information or contact DICE by email (DICE@fda.hhs.gov) or phone (1-800-638-2041 or 301-796-7100).

Sincerely,

for Andrew Steen
Assistant Director
DHT1B: Division of Dental and
ENT Devices
OHT1: Office of Ophthalmic, Anesthesia,
Respiratory, ENT and Dental Devices
Office of Product Evaluation and Quality
Center for Devices and Radiological Health

Enclosure

Indications for Use

510(k) Number (if known)
K210354

Device Name
SNUCONE Bone Level Implant System

Indications for Use (Describe)

SNUCONE Bone Level Implant System is indicated for use in partially or fully edentulous mandibles and maxillae, in support of single or multiple-unit restorations including; cemented retained, screw retained, or overdenture restorations and terminal or intermediate Abutment support for fixed bridge work. SNUCONE Bone Level Implant System is dedicated for two stage surgical procedures and for immediate loading when there is good primary stability and an appropriate occlusal load. Also, implants with diameters larger than 5mm are indicated for molar regions.

Type of Use (Select one or both, as applicable)

Prescription Use (Part 21 CFR 801 Subpart D)

Over-The-Counter Use (21 CFR 801 Subpart C)

CONTINUE ON A SEPARATE PAGE IF NEEDED.

This section applies only to requirements of the Paperwork Reduction Act of 1995.

DO NOT SEND YOUR COMPLETED FORM TO THE PRA STAFF EMAIL ADDRESS BELOW.

The burden time for this collection of information is estimated to average 79 hours per response, including the time to review instructions, search existing data sources, gather and maintain the data needed and complete and review the collection of information. Send comments regarding this burden estimate or any other aspect of this information collection, including suggestions for reducing this burden, to:

Department of Health and Human Services
Food and Drug Administration
Office of Chief Information Officer
Paperwork Reduction Act (PRA) Staff
PRASStaff@fda.hhs.gov

"An agency may not conduct or sponsor, and a person is not required to respond to, a collection of information unless it displays a currently valid OMB number."

510(k) Summary

The assigned 510(k) Number: K210354

01. Date Prepared: July 12, 2022

02. Applicant

Company name: SNUCONE Co., LTD.
Address: 5, Seongseo-ro 75-gil, Dalseo-gu, Daegu, Korea
TEL: 82.53.592.7525
FAX: 82.53.592.7524
Email: snucone@naver.com

03. Submission Correspondent

Sanglok, Lee
Wise COMPANY Inc.
#303, 142, Gasan digital 1-ro, Geumcheon-gu, Seoul, Korea
TEL: +82 70 8812 3619 / +82 2 831 3615
FAX: +82 50 4031 3619
Email: info@wisecompany.org

04. Proposed Device Identification

Trade Name: SNUCONE Bone Level Implant System
Common Name: Endosseous Dental Implant
Classification Name: Implant, Endosseous, Root-Form
Primary Product Code: DZE
Secondary Product Code: NHA
Panel: Dental
Regulation Number: 21 CFR 872.3640
Device Class: Class II

05. Indication for use

SNUCONE Bone Level Implant System is indicated for use in partially or fully edentulous mandibles and maxillae, in support of single or multiple-unit restorations including; cemented retained, screw retained, or overdenture restorations and terminal or intermediate Abutment support for fixed bridge work. SNUCONE Bone Level Implant System is dedicated for two stage surgical procedures and for immediate loading when there is good primary stability and an appropriate occlusal load. Also, implants with diameters larger than 5mm are indicated for molar regions.

06. Predicate and Reference Devices

Primary Predicate
- K181138, IS-III active System manufactured by NEOBIOTECH CO., LTD.



Reference devices
- K141159, KONUS DENTAL IMPLANT SYSTEM by Argon Med Productions & Vertriebs Gesellschaft mbH&Co.KG
- K193234, NUVO IF Implant System by JJGC Indústria e Comércio de Materiais Dentários S.A.
- K203554, AnyOne External Implant System by MegaGen Implant Co., Ltd.

07. Device Description

SNUCONE Implant System Fixture, also known as an endosseous implant, is surgical component that interfaces with the bone of the jaw to support a dental prosthesis such as a crown, bridge, denture. Snucone's abutment and prosthetic components and tools are compatible with the Snucone's fixture only.

1) Fixtures and Cover Screw

There are 1 type of fixture and the dimensions and specification are as following:





Product	AF+B
Appearance	
Platform Diameter	Ø3.5, Ø4.0, Ø4.3, Ø4.8, Ø5.3, Ø5.8, Ø6.3, Ø6.8
Implant Length	Ø3.5: 7,8,9,10,11,12,13,14mm Ø4.0: 7,8,9,10,11,12,13,14mm Ø4.3: 7,8,9,10,11,12,13,14mm Ø4.8: 7,8,9,10,11,12,13,14mm Ø5.3: 7,8,9,10,11,12,13,14mm Ø5.8: 7,8,9,10,11,12,13,14mm Ø6.3: 7,8,9,10,11,12,13,14mm Ø6.8: 7,8,9,10,11,12,13,14mm
Surface Treatment	Acid etching
Implant-to-Abutment connection	Internal Hex
Material	Titanium Gr4 (ASTM F67)
Sterilization	Gamma irradiation
Shelf life	5years
Product	Cover Screw
Appearance	
Diameter	Ø3.3/Ø3.6
Length	5.3/6.6mm
Surface Treatment	Anodizing
Material	Ti 6Al-4V ELI (ASTM F136)
Sterilization	Gamma irradiation
Shelf life	5years

Tolerance of dimension shall be within $\pm 1\%$ range.

2) Abutment and Component

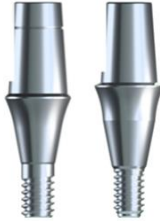
2-1) Abutment

Dimensions and features of abutment are as following:



Abutment	Abiding Healing Abutment	Abiding Solo Abutment	Abiding Couple Abutment	Abiding Couple Angled Abutment
Picture				
Use	This device is used to connect with Fixture to help gum tissue around the implant site heal faster.	This device is a one-piece abutment that is secured to the Fixture without other component.	This device is a two-piece abutment that is secured to the Fixture with an abutment screw.	This device is a two-piece abutment that is secured to the Fixture with an abutment screw.
Profile Diameter	Ø4.4 Ø4.9 Ø5.4 Ø5.9 Ø6.9 Ø7.9 Ø8.9 Ø9.9	Ø4.0 Ø4.5 Ø5.5 Ø6.5	Ø4.0 Ø4.5 Ø5.0 Ø5.5 Ø6.5	Ø4.0 Ø4.5 Ø5.0 Ø5.5 Ø6.5
Gingival Height	1.0~5.5mm	1.0~5.5mm	1.0~7.5mm	1.0~6.0mm
Post Height	2.0/2.5/3.0	4.0/5.5/7.0	5.5/7.0	7.0
Angle(°)	N/A	N/A	N/A	15°, 25°
Anodizing	Pink, Blue	N/A	N/A	Yellow
Prosthetic retention	-	Cement-retained	Cement-retained	Cement-retained
Restoration	-	Single-unit Multi-unit	Single-unit Multi-unit	Single-unit Multi-unit
Material	Ti 6Al-4V ELI (ASTM F136)	Ti 6Al-4V ELI (ASTM F136)	Ti 6Al-4V ELI (ASTM F136)	Ti 6Al-4V ELI (ASTM F136)
Sterilization	End-user sterilized	End-user sterilized	End-user sterilized	End-user sterilized
Shelf life	N/A	N/A	N/A	N/A
Abutment	Abiding Ti-Temporary Abutment	Abiding Screw Abutment		
Picture				
Use	This device is a two-piece abutment that is temporarily fixed to the Fixture with an abutment screw. This device is intended to be used for a maximum timeframe of 6 months.	This device is a one-piece abutment and Abiding Screw Abutment is always to be used with the Ti-Cylinder for single-unit restorations.		
Profile Diameter	Ø4.0 Ø4.5	Ø4.9		
Gingival Height	1.0mm	1.0~4.0mm		
Post Height	10.0mm	-		
Angle(°)	N/A	N/A		
Anodizing	N/A	Yellow		
Prosthetic retention	Screw-retained	Screw-retained		
Restoration	Single-unit Multi-unit	Single-unit Multi-unit		

Material	Ti 6Al-4V ELI (ASTM F136)	Ti 6Al-4V ELI (ASTM F136)		
Sterilization	End-user sterilized	End-user sterilized		
Shelf life	N/A	N/A		

Tolerance of dimension shall be within $\pm 1\%$ range.

2-2) Abutment Screw

Dimensions and features of abutment screw are as following:

Abutment Screw	Abiding Retaining Screw	Abiding Abutment Screw
Picture		
Use	This product is a screw used to connect Abiding screw Abutment to Screw Ti-cylinder.	This product is a screw used to connect both two-piece Abutment to the Fixture
Size	D : $\varnothing 2.0, \varnothing 2.05, \varnothing 2.3$ / L : 4.4~6.0mm	D : $\varnothing 2.2, \varnothing 2.25$ / L : 9.4~10.6mm
Material	Ti 6Al-4V ELI (ASTM F136)	Ti 6Al-4V ELI (ASTM F136)
Sterilization	End-user sterilized	End-user sterilized

Tolerance of dimension shall be within $\pm 1\%$ range.

2-3) Component - Cylinder

Dimensions and features of Ti-Cylinder are as following:

Cylinder	Screw Abutment Ti-Cylinder
Picture	
Use	This product is a two-piece cylinder that is secured to the Abiding Screw Abutment with retaining screw.
Size	D: $\varnothing 4.9$ L: 12.7mm
Minimum Post Height	4mm
Material	Ti 6Al-4V ELI (ASTM F136)
Sterilization	End-user sterilized





Tolerance of dimension shall be within $\pm 1\%$ range.

Fixture is packaged with Cover Screw, Abutment and Cylinder are packaged with single-packing or components, in some cases.

08. Substantial Equivalence Comparison



1) Fixture

	Subject Device	Primary Predicate	Reference device		
Company	SNUCONE Co., LTD.	Neobiotech Co., Ltd	Argon Med Productions&Vertriebs Gesellschaft mbH&Co.KG	JJGC Indústria e Comércio de Materiais Dentários S.A.	MegaGen Implant Co., Ltd.
Device Name	AF+B Fixture for SNUCONE Bone Level Implant System	IS-III active System	K3Pro Konus Dental Implant System	NUVO IF Implant System	AnyOne Esxternal Fixture
510(k) Number	K210354	K181138	K141159	K193234	K203554
Device Classification Name	Implant, Endosseous, Root-Form	Implant, Endosseous, Root-Form	Implant, Endosseous, Root-Form	Implant, Endosseous, Root-Form	Implant, Endosseous, Root-Form
Product Code	DZE	DZE	DZE	DZE	DZE
Regulation Number	872.3640	872.3640	872.3640	872.3640	872.3640
Indications for Use	<p>SNUCONE Bone Level Implant System is indicated for use in partially or fully edentulous mandibles and maxillae, in support of single or multiple-unit restorations including; cemented retained, screw retained, or overdenture restorations and terminal or intermediate Abutment support for fixed bridge work. SNUCONE Bone Level Implant System is dedicated for two stage surgical procedures and for immediate loading when there is good primary stability and an appropriate occlusal load. Also, implants with diameters larger than 5mm are indicated for molar regions.</p>	<p>The IS-III active System is indicated for use in partially or fully edentulous mandibles and maxillae, in support of single or multiple-unit restorations including; cemented retained, screw retained, or overdenture restorations, and terminal or intermediate Abutment support for fixed bridgework. IS-III active System is dedicated for two stage surgical procedures and for immediate loading when there is good primary stability and an appropriate occlusal load. Also, implants with diameters larger than 5mm are indicated for molar regions.</p>	<p>The Konus K3Pro and K3Pro Rapid Implant is designed for use in edentulous sites in the mandible or maxilla for support of a complete denture prosthesis, a terminal or intermediate abutment for fixed bridgework or for partial dentures, or as a single tooth replacement.</p>	<p>The NUVO IF Implant System is intended to be surgically placed in the maxilla or mandible to provide support for prosthetic devices such as artificial teeth in order to restore chewing function. It may be used with single-stage or two-stage procedures, for single or multiple unit restorations, and may be loaded immediately when good primary stability is achieved and with appropriate occlusal loading. Multiple tooth applications may be rigidly splinted.</p> <p>The Titanium Temporary Abutment is indicated to provide temporary support for prosthesis structure for up to 6 months.</p> <p>The Attachment Equator and Attachment Removable Prosthesis abutments are indicated for the attachment of full or partial dentures to NUVO implants.</p>	<p>The AnyOne External Implant System is intended to be surgically placed in the maxillary or mandibular molar areas for the purpose providing prosthetic support for dental restorations (Crown, bridges, and overdentures) in partially or fully edentulous individuals. It is used to restore a patient's chewing function. Smaller implants (less than 6.0mm) are dedicated for immediate loading when good primary stability is achieved and with appropriate occlusal loading. Larger implants are dedicated for the molar region and are indicated for delayed loading.</p>
Material	Titanium Gr4 (ASTM F67)	TI CP4 of ASTM F67	Pure Titanium Grade 4	Commercially Pure Titanium (Grade 4)	CP Ti Grade 4 (ASTM F67-13)

Design					
Connection	Internal Hex	Internal Hex	Internal Hex	Internal Hex	External Hex
Diameters(Ø)	Ø3.5, Ø4.0, Ø4.3, Ø4.8, Ø5.3, Ø5.8, Ø6.3, Ø6.8	3.5/4.0/4.5/5.0/5.5/6.0/7.0	3.0-6.0mm	3.5mm, 3.75mm, 4.3mm, 5.0mm	Ø3.9 x 7.0, 8.0, 9.5, 11.0, 12.5, 14.5mm Ø4.3 x 7.0, 8.0, 9.5, 11.0, 12.5, 14.5mm Ø4.8 x 7.0, 8.0, 9.5, 11.0, 12.5, 14.5mm Ø5.3 x 7.0, 8.0, 9.5, 11.0, 12.5, 14.5mm Ø5.8 x 7.0, 8.0, 9.5, 11.0, 12.5, 14.5mm Ø6.3 x 7.0, 8.0, 9.5, 11.0, 12.5, 14.5mm Ø6.8 x 7.0, 8.0, 9.5, 11.0, 12.5, 14.5mm
Lengths(mm)	Ø3.5: 7,8,9,10,11,12,13,14mm Ø4.0: 7,8,9,10,11,12,13,14mm Ø4.3: 7,8,9,10,11,12,13,14mm Ø4.8: 7,8,9,10,11,12,13,14mm Ø5.3: 7,8,9,10,11,12,13,14mm Ø5.8: 7,8,9,10,11,12,13,14mm Ø6.3: 7,8,9,10,11,12,13,14mm Ø6.8: 7,8,9,10,11,12,13,14mm	7.3/8.5/10.0/11.5/13.0/15.0	7.5-17mm	3.5mm: 7,10,11.5,13,16,18mm 3.75mm: 7,10,11.5,13,16,18mm 4.3mm: 7,10,11.5,13,16,18mm 5.0mm: 7,10,11.5,13,16mm	
Surface Treatment	Acid etching	SLA	Acid etched	Sand blasted and acid etched	Sand-blasted, Large grit, Acid-etched (SLA)
Sterilization	Gamma Sterilization	Gamma Sterilization	Gamma Sterilization	Gamma Irradiation to an SAL of 1×10^{-6}	Gamma sterilization
Principle of Operation	This product is a root-type fixture which is inserted in the alveolar bone. It replaces the functions of the missing teeth as a dental implant fixture.	This product is a root-type fixture which is inserted in the alveolar bone. It replaces the functions of the missing teeth as a dental implant fixture.	Unknown	Unknown	It is a tapered body fixture which is inserted in the alveolar bone. It replaces the functions of the missing teeth as a dental implant fixture,
Similarities	SNUCONE Bone Level Implant System has the same device characteristics with the Primary predicates such as diameters, Length, intended use, material, principle of operation, connection design, design, structure, sterilization method-				
Differences	K193234 was provided as a reference device for combinations of 3.5 diameters and 7mm lengths. K203554 was provided as a reference device for combinations of diameter and lengths except for 3.5 diameters and 7mm lengths. In addition, the surface treatment of the is acid etched method, while the primary predicate is SLA method. To support this inconsistency, K141159 is added as a reference device to support the difference in surface treatment method.				



1-2) Cover Screw

	Subject Device	Primary Predicate
Company	SNUCONE Co., LTD.	Neobiotech Co., Ltd
Device Name	Cover Screw for SNUCONE Bone Level Implant System	IS-III active System
510(k) Number	K210354	K181138

Material	Ti-6Al-4V ELI of ASTM F136	Ti-6Al-4V ELI of ASTM F136
Design		
Diameters(Ø)	Ø3.3 Ø3.6	3.45/3.6
Lengths(mm)	5.3/6.6mm	5.85/6.85/7.45/ 6.4/7.4/8.0
Anodizing	Anodizing	Anodizing/ Non-Anodizing,
Sterilization	Gamma irradiation	Gamma irradiation
Principle of Operation	It is used for protecting inner hole and connecting part with exposed upper part of structure during the healing period after inserting dental implant fixture. When inserting the Abutment, Cover screw is removed.	It is used for protecting inner hole and connecting part with exposed upper part of structure during the healing period after inserting dental implant fixture. When inserting the Abutment, Cover screw is removed.
Similarities	The Subject device and the primary predicate have the same material, anodizing characteristics, sterilization method, and principle of operation, and the diameter and length are similar.	



2) Abutment, Abutment screw and Component

2-1) Abiding Healing Abutment

	Subject Device	Primary Predicate
Company	SNUCONE Co., LTD.	Neobiotech Co., Ltd.
Device Name	Abiding Healing Abutment for SNUCONE Bone Level Implant System	IS-III active System
510(k) Number	K210354	K181138
Material	Ti-6Al-4V ELI of ASTM F136	Ti-6Al-4V ELI of ASTM F136
Design		
Diameters(Ø)	Ø4.4 Ø4.9 Ø5.4 Ø5.9 Ø6.9 Ø7.9 Ø8.9 Ø9.9	4.0/4.5/4.8/5.5/6.0/6.8/8.0/9.0
Gingival Height(mm)	1.0~5.5mm	2.3/2.8/3.3/3.8/4.3/4.8/5.3/5.8/6.3/6.8/7.8
Anodizing	Anodizing	N/A
Sterilization	Non-Sterilization	Gamma irradiation
Principle of	This product is healing Abutment to formation appropriate gingival shape during the	This product is healing Abutment to formation appropriate gingival shape during the









Operation	soft tissue healing period combined with implant. This product should be removed when the superstructure is set up.	soft tissue healing period combined with implant. This product should be removed when the superstructure is set up.
Similarities	The subject device has the same principle of operation, material, design and similar diameter and length as the reference device.	

2-2) Abiding Solo Abutment

	Subject Device	Reference device
Company	SNUCONE Co., LTD.	JJGC Indústria e Comércio de Materiais Dentários S.A.
Device Name	Abiding Solo Abutment for SNUCONE Bone Level Implant System	NUVO IF Implant System
510(k) Number	K210354	K193234
Material	Ti-6Al-4V ELI of ASTM F136	Titanium Alloy (Ti-6Al-4V)
Design		
Diameters(Ø)	Ø4.0 Ø4.5 Ø5.5 Ø6.5	Platform Ø3.5(NP) Ø4.5(SP)
Gingival Height(mm)	1.0~5.5mm	0.5, 1.2, 1.5, 3mm
Surface Treatment	N/A	Machined and anodized (only NP platform)
Principle of Operation	This Product is one-piece cement retained restoration, connected with fixture and cemented crown on the Abutment.	Abutment designed to accept a cement-retained prosthetic.
Similarities	The subject device and reference device have the similar technological characteristic, and are made of same materials. The subject device and reference device have similar physical dimensions, including diameter and lengths. Therefore, the subject device is substantially equivalent to the currently reference devices.	





2-3) Abiding Couple / Abiding Couple Angled Abutment

	Subject Device	Primary Predicate
Company	SNUCONE Co., LTD.	Neobiotech Co., Ltd
Device Name	Abiding Couple, Couple Angled Abutment for SNUCONE Implant System	IS-III active System
510(k) Number	K210354	K181138
Material	Ti-6Al-4V ELI of ASTM F136	Ti-6Al-4V ELI of ASTM F136
Abiding Couple Abutment		



Design					
	Hex	Non-Hex	Hex	Non-Hex	SCRIP
Diameters(Ø)	Ø4.0 Ø4.5 Ø5.5 Ø6.5		4.5/5.2/5.7/6.5		
Gingival Height(mm)	1.0~7.5mm		1,2,3,4,5mm		
Anodizing	Non-Anodizing		Non-Anodizing		
Abiding Couple Angled Abutment					
Design					
	Hex, Non-Hex	Hex, Non-Hex	Hex	Non-Hex	
Diameters(Ø)	Ø4.0 Ø4.5 Ø5.0 Ø5.5 Ø6.5		4.5/5.2/5.7		
Gingival Height(mm)	1.0~6.0mm		2,3,4mm		
Angle (°)	15°, 25°		15/25		
Anodizing	Non-Anodizing, Anodizing		Non-Anodizing		
Principle of Operation	This product is two-piece abutment that is indicated for screw-retained single tooth or cement retained single tooth and bridge restorations.		It is indicated for screw-retained single tooth or cement retained single tooth and bridge restorations.		
Similarities	They are substantially equivalent in material, design, dimension, connection, functions. Subject device is similar in fundamental scientific technology to the primary predicate in that they all have been designed, manufactured and tested in compliance with FDA's Class II special controls guidance document root-form endosseous dental implants and endosseous dental implant abutments.				

2-4) Abiding Ti-Temporary Abutment

	Subject Device	Primary Predicate
Company	SNUCONE Co., LTD.	Neobiotech Co., Ltd
Device Name	Abiding Ti-Temporary Abutment for SNUCONE Implant System	IS-III active System
510(k) Number	K210354	K181138
Material	Ti-6Al-4V ELI of ASTM F136	Ti-6Al-4V ELI of ASTM F136

Design				
	Hex	Non-Hex	Hex	Non-Hex
Diameters(Ø)	Ø4.0 Ø4.5		4.5	
Gingival Height(mm)	1.0mm		6.0/8.0/11.5	
Principle of Operation	It is dental Abutments designed to serve as a temporary dental prosthesis during the healing process until a permanent crown is made.		It is dental Abutments designed to serve as a temporary dental prosthesis during the healing process until a permanent crown is made.	
Maximum timeframe for use	≤ 6 month		Expected to be less than 6 month	
Similarities	The subject device and primary predicate are substantially equivalent material, connection type, design, principle of operation, and maximum timeframe for use.			



2-5) Abiding Screw Abutment

	Subject Device	Reference device
Company	SNUCONE Co., LTD.	JJGC Indústria e Comércio de Materiais Dentários S.A.
Device Name	Abiding Screw Abutment for SNUCONE Implant System	NUVO IF Implant System
510(k) Number	K210354	K193234
Material	Ti-6Al-4V ELI of ASTM F136	Titanium Alloy (Ti-6Al-4V)
Design		
Diameters(Ø)	Ø4.9	Platform Ø3.5&4.8mm (NP), Ø4.8mm (SP)
Gingival Height(mm)	1.0~4.0mm	NP – 0.5/1/2/2.3/3/4/5mm SP – 1/2/2.3/3/4/5mm
Angle (°)	0°	0°, 17°, 30°
Anodizing	Non-Anodizing, Anodizing	Machined and anodized (only NP platform)
Similarities	The subject device and the reference device have same raw materials and designs, and have similar physical sizes such as diameter and height. Therefore, the subject device and reference device are practically the similar.	

2-6) Abutment Screw

	Subject Device		Primary Predicate
Company	SNUCONE Co., LTD.		Neobiotech Co., Ltd
Device Name	Abiding Retaining Screw	Abiding Abutment Screw	IS-III active System
510(k) Number	K210354	K210354	K181138
Material	Ti-6Al-4V ELI of ASTM F136	Ti-6Al-4V ELI of ASTM F136	Ti-6Al-4V ELI of ASTM F136
Design			
Diameters(Ø)	Ø2.0, Ø2.05, Ø2.3	Ø2.2, Ø2.25	2.3
Lengths(mm)	4.4~6.0mm	9.4~10.6mm	8.8/8.3
Surface Treatment	N/A	N/A	N/A
Principle of Operation	This product is a screw for connected with Abutment and fixture.		This product is a screw for connected with Abutment and fixture.
Similarities	The subject device and primary predicate have same material, design, diameter, surface treatment, and principle of operation.		
Differences	Differences in length are due to proprietary subject device dimensions and are supported by bench testing.		

2-7) Component – Cylinder

	Subject Device	Reference device
Company	SNUCONE Co., LTD.	JJGC Indústria e Comércio de Materiais Dentários S.A.
Device Name	Screw Abutment Ti-Cylinder for SNUCONE Implant System	NUVO IF Implant System
510(k) Number	K210354	K193234
Material	Ti-6Al-4V ELI of ASTM F136	Titanium Alloy (Ti-6Al-4V)
Design		
Diameters(Ø)	Ø4.9	Not Available in 510(k) Summary
Lengths(mm)	12.7mm	Not Available in 510(k) Summary

Anodizing	Anodizing	Not Available in 510(k) Summary
Principle of Operation	This product is connected to a Screw Abutment, and before installing the final prosthesis, a temporary prosthesis is made and used in various cases such as over denture and bridges.	Not Available in 510(k) Summary
Similarities	The subject device and the reference device have same raw materials and designs and have similar physical sizes such as diameter. Therefore, the subject device and reference device are practically the similar.	

09. Non-Clinical Test

Bench tests were conducted to verify that the subject device met all design specifications as was Substantially Equivalent (SE) to the predicate device. The test results demonstrated that the subject device complies with the following standards:

The subject device was tested to evaluate its substantial equivalence according to the following standards.

▪ **Mechanical Performance**

- Fatigue testing for Mini and Regular platform implant bodies with 25° Abiding Couple Angled Abutments was conducted according to the “Guidance for industry and FDA staff Class II Special Controls Guidance Document Root-form Endosseous Dental Implants and Endosseous Dental Abutment” and “ISO 14801:2016 Dentistry - Fatigue test for endosseous dental implants” under the worst case scenario.
- SEM/EDS analysis for worst-case implant body was conducted to confirm removal of the surface treatment media according to the “Guidance for industry and FDA staff Class II Special Controls Guidance Document Root-form Endosseous Dental Implants and Endosseous Dental Implant Abutments.”.

▪ **Sterilization, Shelf-life and Packaging for Sterile Product**

- End User Sterilization Validation according to ISO 17665-1:2006, ISO 17665-2:2009, ISO 11737-1:2006, and ISO 11737-2:2009
- Gamma sterilization validation according to ISO 11737-1:2006, and ISO 11737-2:2009
- Accelerating aging test according to ASTM F1980-16, ASTM D882-12, ASTM F1140-13, ASTM F1929-15, and ASTM F2096-11

▪ **MR Environment Condition**

Non-clinical worst-case MRI review was performed to evaluate the metallic SNUCONE Bone Level Implant System devices in the MRI environment using scientific rationale and published literature (e.g., Woods, Terry O., Jana G. Delfino, and Sunder Rajan. "Assessment of Magnetically Induced Displacement Force and Torque on Metal Alloys Used in Medical Devices." Journal of Testing and Evaluation 49.2 (2019): 783-795), based on the entire system including all variations (all compatible implant bodies, dental abutments, and fixation screws) and material composition. Rationale addressed parameters per the FDA guidance “Testing and Labeling Medical Devices for Safety in the Magnetic Resonance (MR) Environment,” including magnetically induced displacement force and torque.

▪ **Bacterial Endotoxin**

- ANSI/AAMI ST72:2019 Bacterial endotoxins – Test methods, routine monitoring, and alternatives to batch testing

▪ **Biocompatibility**

Subject device has been evaluated for biocompatibility according to ISO 10993

The results of the above tests have met the criteria of the standards and demonstrated the substantial equivalence with the predicate device

10. Conclusion

SNUCONE Bone Level Implant System constitutes a substantially equivalent medical device. This system has the same intended use and fundamental scientific technology as its predicate device. Therefore, SNUCONE Bone Level Implant System and its predicate device are substantially equivalent.