

CardioMEMS™ HF System

CardioMEMS™ Patient Electronics System

Model CM1100

Patient System Guide

Indications

The CardioMEMS™ HF System is indicated for wirelessly measuring and monitoring pulmonary artery pressure and heart rate in NYHA Class II or III heart failure patients who either have been hospitalized for heart failure in the previous year and/or have elevated natriuretic peptides. The hemodynamic data are used by physicians for heart failure management with the goal of controlling pulmonary artery pressures and reducing heart failure hospitalizations.

Contraindications

The CardioMEMS HF System is contraindicated for patients with an inability to take dual antiplatelet or anticoagulants for one month post implant.

CAUTION: Federal (USA) law restricts this device to sale by or on the order of a physician.

Unless otherwise noted, ™ indicates that the name is a trademark of, or licensed to, St. Jude Medical or one of its subsidiaries.

ST. JUDE MEDICAL and the nine-squares symbol are trademarks and service marks of St. Jude Medical, LLC and its related companies.

Pat. <http://patents.sjm.com>

© 2022 St. Jude Medical, LLC. All Rights Reserved.

Contents

| | |
|---|----|
| Introduction. | 1 |
| When is the CardioMEMS HF System used? | 1 |
| What is the purpose of the CardioMEMS HF System? | 1 |
| How your Heart Works. | 2 |
| Heart Failure. | 2 |
| Causes of Heart Failure. | 2 |
| Symptoms of Heart Failure. | 3 |
| Managing Your Heart Failure. | 3 |
| Precautions. | 4 |
| Warnings. | 5 |
| Clinical Study Information. | 6 |
| Introduction | 6 |
| GUIDE-HF Trial - Randomized Arm. | 6 |
| Pivotal Data from the CHAMPION Trial. | 6 |
| Potential Risks within 30 days of the Implant Procedure. | 7 |
| Potential Risks within 6 months of the Implant Procedure | 7 |
| Potential Risks within 1½ years of the Implant Procedure. | 7 |
| Long-term Data from the CardioMEMS US Post-Approval Study. | 8 |
| Sensor Implantation. | 8 |
| Before the Implant Procedure. | 8 |
| Implant Procedure. | 9 |
| After the Implant Procedure. | 10 |
| Taking a Home Reading | 10 |
| Important Safety Information. | 11 |
| Patient Electronics System. | 11 |
| Setting Up the Patient Electronics. | 11 |
| Connectivity Method | 12 |
| Steps for Taking a Reading. | 14 |
| Troubleshooting the Patient Electronics System. | 17 |
| Orientation Ball. | 19 |
| Additional Features. | 20 |
| Software Update. | 21 |
| Living with your CardioMEMS™ HF System. | 21 |
| When to Call Your Doctor. | 21 |
| Care of the Patient Electronics System. | 21 |
| Replacing your Patient Electronics System | 22 |
| Setting Up a Replacement System. | 22 |
| Repacking. | 24 |
| Electromagnetic Interference and Electromagnetic Compatibility. | 26 |
| FCC Statement. | 28 |
| System Specifications. | 29 |
| Electrical Characteristics. | 29 |
| Mechanical Characteristics. | 29 |
| Environmental Information. | 29 |
| Classification. | 29 |
| Testing. | 29 |
| System Testing. | 29 |
| Safety Testing. | 29 |
| EMI/EMC Testing. | 29 |
| Wireless Testing. | 30 |
| Software. | 30 |
| Symbols. | 30 |
| WEEE Compliance Statement. | 31 |
| Replacement and Limited Warranty Summary. | 31 |
| Technical Support. | 31 |

Introduction

You have been diagnosed with heart failure (HF). Heart failure results from damage to the heart that makes it difficult for the heart to pump enough blood to your body. Heart failure is a progressive disease that often gets worse over time. The most common causes of heart failure are high blood pressure and coronary artery disease, in which blood vessels that supply blood to the heart are narrowed or blocked. Approximately 5 million people in the United States suffer from heart failure. It is one of the most common reasons for hospitalizations in people over 70 years of age.

When is the CardioMEMS HF System used?

Your doctor has determined that you might benefit from the information obtained by the CardioMEMS™ HF System because you have heart failure and are at an increased risk of hospitalization.

What is the purpose of the CardioMEMS HF System?

The CardioMEMS HF System uses an implanted sensor to monitor the pressure in your pulmonary artery (PA). Your doctor can use pulmonary artery pressures to make informed decisions about your heart failure treatment, including whether to change critical medications. You will take a sensor reading each day from home using the Patient Electronics System, which sends the information to your doctor. After analyzing the information, your doctor may contact you to make medication changes to help treat your heart failure.

This guide will tell you how the system operates. It will discuss what to expect during and after the implant of the device. This guide will explain how to set-up the Patient Electronics System in your home and how to take a daily reading. It will talk about some of the changes that may occur in your life and answer many of the more common questions. If you have questions about what you read in this guide, discuss them with your doctor or nurse. They are your best resources for information.

The CardioMEMS™ HF System includes the following components:

Figure 1. Pulmonary Artery (PA) Sensor (Sensor)



Figure 2. Patient Electronics System

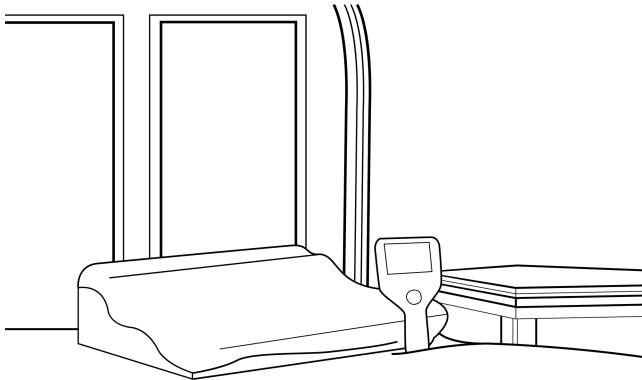

Patient Electronics System

The Patient Electronics System (System) consists of the electronics unit and receiving antenna (embedded in the pillow) and the Controller. Together, the components of the System read your PA pressure measurements from your sensor wirelessly and then transmit the information to your physician.

The antenna is paddle-shaped and is pre-assembled inside the pillow to make it easier and more comfortable for you to take readings.

Figure 3. The Controller

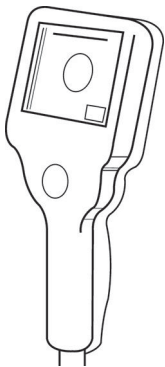
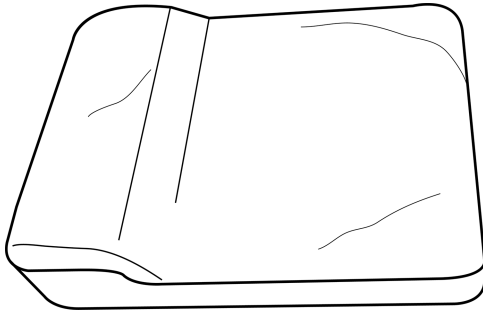

Figure 4. The Pillow



How your Heart Works

Your heart is a muscle that pumps blood throughout your body. It has four chambers. The upper chambers are called atria (left and right) and the lower chambers are called ventricles (left and right). The right side of the heart receives "used" blood coming back from the body and pumps the blood to the lungs, where it picks up oxygen. Blood then returns to the left side of the heart, which in turn pumps the blood to the rest of the body.

Figure 5. Normal Heart

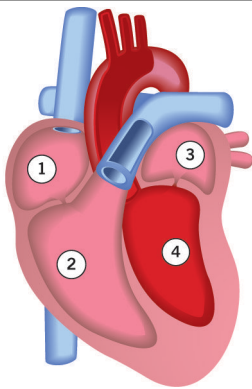

1. Right atrium
2. Right ventricle
3. Left atrium
4. Left ventricle

Heart Failure

Heart failure is a serious illness. It means that your heart cannot squeeze hard enough to move enough blood out to your body, or that your heart muscle is too thick and does not relax enough between beats to allow it to fill with blood. Heart failure can make you feel tired or weak and can also cause swelling and fluid buildup in your legs, feet, stomach, and even your lungs. Fluid buildup in your lungs is often referred to as "congestion", which is why heart failure is sometimes called "congestive heart failure".

Causes of Heart Failure

Anything that weakens the heart muscle so it does not pump blood normally can cause heart failure. Some of the common causes of heart failure include:

- **Coronary Artery Disease.** Blocked arteries can trigger heart attacks that cause heart muscle cells to die. The muscle is weakened and pumps less efficiently.
- **Untreated High Blood Pressure.** High blood pressure forces the heart to pump harder to move blood through the body. That can cause the heart to weaken over time.
- **Faulty Heart Valves.** Heart valves that do not work properly (either because they are leaky or because they do not open wide enough) can cause the heart muscle to weaken.
- **Cardiomyopathy (Heart Muscle Disease).** The heart muscle becomes enlarged or weakened for unknown reasons.

Over time, the heart muscle weakens and the heart becomes enlarged, as shown below. The ventricles are unable to contract with the same strength as before. As a result, the flow of blood and oxygen to the body is poor.

Figure 6. A normal heart

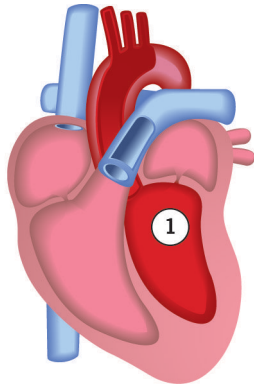

1. Left ventricle

Figure 7. An enlarged heart

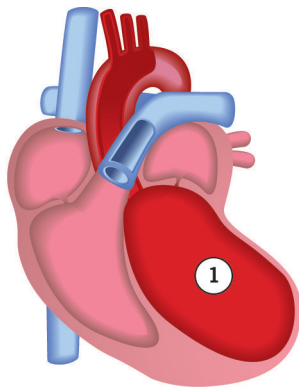

1. Left ventricle

Symptoms of Heart Failure

It is important to tend to your symptoms as soon as they begin. Like many people, you may fail to notice symptoms in their early stages, or you may shrug them off. Ignoring symptoms is risky. Symptoms such as trouble breathing or swollen ankles can mean that your heart failure is getting worse. Worsening symptoms can quickly lead to urgent problems that require a hospital stay. Some of the most common symptoms that patients with heart failure experience include:

- **Fatigue, loss of energy**

You may find that you get very tired from very little effort, like walking up the stairs or doing your daily chores.

- **Shortness of breath**

Shortness of breath is often described as "not getting enough air." You may become more short of breath with exertion. You may awaken abruptly at night with a sensation of shortness of breath or feel the need to sit up to sleep. You may also experience a frequent, dry cough that is often made worse when you lie down in bed.

- **Weight gain**

Weight gain over several days in a row is a common sign that there is fluid buildup in the body. You may experience a weight gain of 3 pounds or more before you notice any swelling or shortness of breath.

- **Swelling**

You may notice swelling of your feet, legs or abdomen. This is usually worse later in the day and in the lowest part of your body. Swelling occurs because the extra fluid seeps into the tissues from the small blood vessels. You may notice that your shoes, socks or pants are fitting more tightly at the end of the day.

- **Loss of Appetite or Bloating Sensation**

Many people with heart failure notice retention of fluid in the abdomen. When this happens, you may experience a distended or bloated sensation. You may also experience loss of appetite or even an upset stomach. Medicines may not be absorbed as well and therefore will not work as effectively.

- **Decreased Urination during the Day, Increased Urination at Night**

The heart works harder during the day than at night, when you are at rest. This leads to less urine production during the day. When you are sleeping, the work of the heart is lessened, which allows the kidneys to make more urine.

The pressure in the vessels around your heart changes before you feel any of these symptoms. Such changes can be detected by the CardioMEMS HF System sensor. Your doctor may change some of your medications based on the information obtained from the sensor. It is important to follow all directions your physician gives you, even if you are not feeling bad.

Managing Your Heart Failure

Good management of your heart failure will lessen the impact of the symptoms on your daily life. Your doctor will determine and discuss the best treatment options with you. Making changes in your food selections and daily activities, taking pressure readings, and taking the medications that your doctor prescribes can make a major difference in how you feel.

Medications

Medicines are important in the treatment of heart failure. Many research studies have shown that heart failure medicines can help stabilize your heart function and can help you:

- Live longer
- Have fewer symptoms
- Increase activity level
- Have more energy
- Have less swelling
- Breathe more easily
- Stay out of the hospital

The major classes of medications used in the treatment of heart failure are:

- **Angiotensin-Converting Enzyme Inhibitors (ACE Inhibitors).** ACE inhibitors are very beneficial for people with heart failure. Research studies have shown that ACE Inhibitors help people live longer and decrease hospitalizations. They block the effects of harmful stress hormones (substances produced by your body that make heart failure worse). They help to relax blood vessels and lower blood pressure, which make it easier for the heart to pump blood out to the body.
- **Angiotensin-Receptor Blockers (ARB).** ARBs are similar to the ACE Inhibitors and are most commonly used when patients cannot take ACE inhibitors because of the side effects. Research studies have shown that ARB's also help people live longer
- **Beta Blockers.** Beta-blockers reduce the damaging effects of the hormone adrenalin on the heart and help you live longer. They also lower blood pressure and heart rate.
- **Diuretics ("water pill").** Diuretics help your body get rid of extra fluid. Less fluid in your lungs makes breathing easier. Less fluid also means less swelling in other parts of your body. Having less fluid in your body will help you feel more comfortable.
- **Aldosterone Antagonist.** Aldosterone antagonists block the effects of a stress hormone called aldosterone, which can make heart failure worse. Research has shown that aldosterone antagonists help people live longer.
- **Vasodilator and Nitrate Combination.** Vasodilators relax the arteries, which reduces the heart's workload. Nitrates reduce the amount of oxygen the heart needs and improves blood flow to the heart. Research has shown that these medicines also help people live longer.

Daily Pulmonary Artery Pressure Reading

The pressures in the vessels around your heart change before you notice any weight gain or swelling. Taking daily pressure readings with the Patient Electronics System allows your doctor to treat you before these symptoms occur and to manage your heart failure more effectively.

Daily Weights

Your doctor may have instructed you to weigh yourself every morning using the same scale. Weighing yourself every day will help you notice any extra fluid buildup. If you ignore the weight gain, the fluid will find its way to your lungs, abdomen, legs, and feet. By the time you see swelling in your ankles, you may have already retained an extra five to seven pounds of fluid.

Low Sodium Diet

Table salt is composed of sodium and chlorine. It is important to decrease the amount of sodium you eat because heart failure causes your body to hold on to extra sodium. The sodium causes extra fluid to build up. That leads to symptoms such as swelling of the ankles, feet or abdomen, shortness of breath, or weight gain.

By reducing the amount of sodium in your diet, you will retain less fluid and reduce many of the symptoms of heart failure. You cannot eliminate sodium entirely because it is present in most foods, but any reduction in the amount of sodium you eat will have big benefits for you. It may take some time to adjust to a low-sodium diet, but it is worth the effort. A low-sodium diet can help you feel better and allow your heart failure medicines to work more efficiently.

Fluid Control

Many people with heart failure take diuretics to remove excess fluid. However, the action of these medications can be overwhelmed if you drink too much fluid. Patients with more advanced cases of heart failure are often advised to limit their total daily fluid intake to two quarts a day. The guidelines for sodium and fluid intake may vary depending on the severity of your heart failure and should be discussed with your physician.

Alcohol

Alcohol has a direct effect on the heart by decreasing the strength of the contraction. With a muscle that is already weak, as in heart failure, this is not a good idea. You should limit alcohol to one drink or less per day or avoid alcohol completely.

Tobacco Cessation

Tobacco products (not just cigarettes) contain nicotine. Nicotine causes blood vessels to become narrower. This raises the blood pressure and pulse rate, making more work for your weakened heart. You should avoid exposure to all tobacco products, including secondhand smoke.

Activity and Exercise

Your heart is a muscle. It needs exercise, just like all the other muscles in your body. Activity can help you feel better, may decrease your symptoms, and may improve your heart's function. Ask your doctor or nurse about an exercise or walking program to help build your tolerance for activity.

Precautions

Failure to follow these precautions may result in system malfunction, damage to the system, or delay in information getting to your doctor.

- Do not place the electronics unit near an open window. Exposing the unit to rain, water, moisture or direct sunlight may severely damage it.
- Do not apply excessive pressure to the display screen. Excessive pressure may damage the display.
- Do not apply excessive or damaging force to any part of the electronics unit.
- Do not expose the electronics to excessive vibration, impact, or rough handling.
- Allow the cover to air dry after washing it (hand wash or machine gentle cycle.) Do not place the cover in a clothes dryer.

- To avoid potential damage caused by lightning, unplug the electronics unit during electrical storms.
- Allow the electronics unit to shut-down automatically. Failure to do so may corrupt the files.
- The electronics unit should not be used adjacent to or stacked with other equipment. If it is necessary to operate it adjacent to or stacked with other equipment, verify that the electronics unit is operating normally in the configuration in which it will be used.
- Exposure to excess lint, dust, or corrosive materials may result in a malfunction.
- If your electronics unit uses a telephone line communication, be aware that other equipment may interrupt the communication. Contact Technical Support, if you have questions about such equipment.
- Your Patient Electronics System communicates securely through the internet to transmit your reading. Portions of this internet pathway may become unavailable for periods of time for a variety of reasons including but not limited to: internet connectivity outage, hardware failure, power outage, or general infrastructure failures. Readings that are unable to transmit are stored and will transmit when internet connectivity is available.
- Contact your physician if you are unable to send or use readings for three or more days.
- The accuracy of the system may be affected by various factors. If your physician suspects that the sensor pressure readings may not be accurate, the use of the pressure information may be temporarily suspended. Recalibration of the sensor may be necessary to continue use of the system. Recalibration of the sensor may require the performance of a right heart catheterization procedure.
- The touchscreen display on the handheld unit can be sensitive to electrostatic discharge (ESD) at high levels. To reduce the potential for ESD discharge to the touchscreen, remove and hold the plastic handle of the handheld prior to contact with the touchscreen. If the touchscreen becomes damaged due to ESD, the screen will be discolored or may be unresponsive. Contact Technical Support for replacement of the Controller.
Please note that high levels of ESD are more likely in situations where the relative humidity is very low, such as inside a heated building during the winter in areas where it is cold outside. In order to reduce the potential for high levels of ESD, there are common situations which create static electricity that can be avoided prior to use, for example, putting on and removing clothes, dragging your feet across a carpet or rug, vacuuming, or removing clothes from a dryer.
- Once the reading has been successfully performed, always return the Controller to the cradle which is located on the rear of the electronics unit.
- The system is not intended to be used in a severe electromagnetic radiation environment or an industrial environment.
- The system should not be used in conjunction or in association with Magnetic Resonance Imaging (MRI), computerized axial tomography (CT), diathermy, Radio Frequency Identification (RFID), and electromagnetic security systems such as metal detectors.

Warnings

Failure to follow these warnings may result in damage to the system, system malfunction, delay in information getting to your doctor, inaccurate readings, or injury.

- Only authorized personnel should use the Patient Electronics System.
- Do not remove the cover or attempt to service the electronics unit. Service should be performed by an authorized technician.
- If any of the following occurs, immediately unplug the electronics unit and call Technical Support:
 - Any cords are noticeably frayed or damaged.
 - Liquid has been spilled onto the electronics unit, or it has been exposed to rain.
 - The electronics unit has been dropped or damaged.
 - If you lose the power cord, you must replace it with an identical power cord. Contact Technical Support.
- Medical Electrical Equipment requires special precautions regarding electromagnetic compatibility (EMC) and needs to be installed and put into service according to the EMC information provided. If interference is noted, remove or stop using the interfering equipment.
- Portable and mobile RF communications equipment can affect medical electrical equipment and may cause a malfunction of the system.
- Use only cables and accessories provided. The use of other attachable parts other than the parts provided may result in inaccurate readings, damage to the electronics, or injury to the user.
- The use of accessories and cables other than those specified, with the exception of cables sold by the manufacturer of the Patient Electronics System as replacement parts for internal components, may result in increased emissions or decreased immunity.
- Other equipment may interfere with the electronics unit operation, even if the other equipment complies with CISPR emission requirements. See the Electromagnetic Interference and Electromagnetic Compatibility section for guidance.
- Two Patient Electronics Systems may interfere with each other. Only operate one electronics unit at a time in the same general vicinity.
- If two electronic units are proximate to each other and are used at the same time, pressure measurements may be affected due to interference between the two systems. In such isolated cases, it is recommended that operation of each electronics unit occur at separate times.
- While in use, ensure that the power supply is easily accessible since unplugging the electronics unit from the outlets is the only means of completely isolating from mains.
- Do not attempt to connect the electronics unit to any network or data coupling equipment in your home other than specified in the instructions for use.
- If redness of the skin develops or a change in skin sensitivity occurs, discontinue use of this product immediately and contact your physician.
- Keep the Patient Electronics System away from pets and children. Ingestion of any part may cause injury.
- Care should be taken to keep all cables away from the neck and face to prevent airway blockage.
- Do not attempt to connect the electronics unit or handheld unit to any other electronic equipment.
- Your Patient Electronics System has been calibrated to work with your sensor. Use of different electronics unit may result in inaccurate information.
- Do not change the computer configuration without authorization. Changes to the configuration may result in inaccurate information.
- Use only manufacturer supplied Wi-Fi adapters.

Clinical Study Information

Introduction

Heart failure is a life-threatening condition with debilitating symptoms and is a burden to patients and their care-givers. Over 60 million people are estimated to be living with heart failure world-wide. It has been shown that pulmonary artery (PA) pressures begin to increase earlier than signs and symptoms (for example, weight gain or shortness of breath) of worsening heart failure and can provide a physiologic basis for heart failure patient management.

The CardioMEMS HF System provides a proven method for measuring PA pressure using a wireless pressure sensor implanted into the pulmonary artery. The CardioMEMS HF System provides clinicians with a patient's PA pressure while the patient is at home, without the need for a procedure or office visit. This information allows the physician to manage the patient's heart failure proactively with the goal of controlling PA pressures and reducing heart failure hospitalizations.

GUIDE-HF Trial - Randomized Arm

Purpose

The goal of the GUIDE-HF trial (Hemodynamic-GUIDED Management of Heart Failure) was to determine whether an expanded patient population would benefit from using PA pressure-guided heart failure management: the CardioMEMS™ HF System.

Study Design

The GUIDE-HF trial (Randomized Arm) was conducted at 118 study sites (114 U.S. sites and 4 sites in Canada) and enrolled 1022 patients with NYHA Class II, III, or IV heart failure and either a prior heart failure hospitalization within 12 months or elevated natriuretic peptides (hormones that increase when the heart is not pumping properly). A total of 1000 Patients were randomized (assigned by chance) to one of two groups: the Treatment Group (standard of care plus using the CardioMEMS HF System) or the Control Group (standard of care only). All patients were implanted with the CardioMEMS PA Sensor and took daily readings from home, but clinicians only had access to pulmonary artery pressure information for patients in the Treatment Group.

Results

The study was evaluated for success based on the total of heart failure hospitalizations, urgent heart failure visits (emergency department or hospital outpatient visits for intravenous diuretic therapy), and all-cause mortality at 12 months. The study would be considered successful by demonstrating that the hemodynamic-guided heart failure treatment is superior to the control therapy for heart failure outcomes.

Overall, the Treatment group had 12% fewer primary endpoint events than the Control group, but the difference between groups was not significant. The difference between groups was primarily due to the Treatment group having 17% fewer heart failure hospitalizations compared to the Control group. However, the timing of the study overlapped with the COVID-19 pandemic. To account for the impact of the COVID-19 pandemic, the primary endpoint of the GUIDE-HF trial was also evaluated using follow-up data collected prior to the U.S. national emergency declaration date (March 13, 2020). Prior to COVID-19, the Treatment group had 19% fewer primary endpoint events than the Control group, driven by a 27% reduction in risk for heart failure hospitalizations.

The GUIDE-HF trial primary endpoint was also evaluated in subgroups of patients. For NYHA Class, the clinical data demonstrated a treatment effect in NYHA Class II and III heart failure patients, with benefits remaining unclear in NYHA Class IV patients. Prior to COVID-19, NYHA Class II/III patients in the Treatment Group experienced a 24% reduction in primary endpoint events compared with the Control Group. A treatment effect was also observed regardless of whether patients qualified for the study due to a heart failure hospitalization in the prior 12 months or as a result of elevated natriuretic peptides. A greater benefit was observed in women compared to men and in African American subjects compared to Caucasian patients. The subgroup analyses according to other factors (ejection fraction, age, sex, race, ethnicity, ischemic cardiomyopathy, and prior cardiac device implant) showed consistent benefit of the CardioMEMS HF System for patients regardless of these factors.

Of the 1022 patients enrolled in the study, 99.2% were free from a device or system-related complication. Potential Risks observed in the GUIDE-HF trial were consistent with those in the CHAMPION clinical trial.

In summary, despite the limitations of the COVID-19 pandemic occurring during the follow-up of the study, the results of the GUIDE-HF Randomized Arm support the continued safety and effectiveness of the CardioMEMS HF System within an expanded population, as shown by reduced heart failure hospitalizations. The treatment benefit observed in NYHA Class II subjects and those with elevated natriuretic peptides but without a recent hospitalization for heart failure suggest that intervention in NYHA Class II heart failure, even before a heart failure hospitalization occurs, can provide benefit.

Pivotal Data from the CHAMPION Trial

Purpose

The goal of the CHAMPION trial (CardioMEMS Heart Sensor Allows Monitoring of Pressures to Improve Outcomes in NYHA Functional Class III Heart Failure Patients) was to determine if physicians could reduce heart failure hospitalizations by managing patient pulmonary artery pressures using the CardioMEMS HF System.

Study Design

The CHAMPION trial was conducted at 64 study sites in the U.S. and enrolled 550 patients with New York Heart Association (NYHA) Class III heart failure who had been hospitalized for heart failure in the previous year. All patients were implanted with a sensor and then randomized (assigned by chance) to either the Treatment group (heart failure management on the basis of pulmonary artery pressure and standard of care) or the Control group (heart failure management on the basis of standard of care).

Results

CHAMPION met its two primary safety endpoints with 1.4% of patients experiencing a device-related complication and no patients experiencing a sensor failure.

The CHAMPION trial was not designed to assess the benefit of this treatment strategy by gender. Since most of the patients who participated in the trial were men, it was not possible to determine the effect of the device in women.

The CHAMPION trial met its primary efficacy endpoint of reduction in the rate of heart failure hospitalizations with Treatment group patients having 28% fewer heart failure hospitalizations compared to Control group patients at 6 months. Men and women in the Treatment group had

similar heart failure hospitalization rates. The CHAMPION trial also met its secondary efficacy endpoints with Treatment group patients having lower pulmonary artery pressures, fewer days in the hospital, and better quality of life compared to Control group patients.

Over the entire randomized follow-up in the trial of 1½ years, Treatment group patients had 33% fewer heart failure hospitalizations compared to Control group patients. For every 100 patients treated, 23 heart failure hospitalizations were prevented per year.

After the completion of the randomized portion of the trial, physicians managed all patients (former Treatment and Control groups) on the basis of pulmonary artery pressure and standard of care. When both groups were managed in the same fashion, their heart failure hospitalization rates were similar.

Potential Risks within 30 days of the Implant Procedure

The following table is a summary of the minor and major clinical risks observed within 30 days of the implant procedure.

Table 1. Clinical risks within 30 days

| Risks | Treatment Group | Control Group (Standard Therapy) |
|--|------------------------|---|
| Death | 0 out of 100 patients | 1 out of 100 patients |
| Stroke | 0 out of 100 patients | 0 out of 100 patients |
| Myocardial Infarction (heart attack) or Chest Pain | 2 out of 100 patients | 3 out of 100 patients |
| Bleeding | 3 out of 100 patients | 3 out of 100 patients |
| Hematoma (bruising at catheterization site) | 1 out of 100 patients | 1 out of 100 patients |
| Thrombus (blood clot) | 0 out of 100 patients | 0 out of 100 patients |
| Arrhythmias (abnormal heart rhythm) | 5 out of 100 patients | 3 out of 100 patients |
| Kidney Dysfunction/Failure | 2 out of 100 patients | 2 out of 100 patients |
| Infection | 5 out of 100 patients | 4 out of 100 patients |
| Hypotension (low blood pressure) | 3 out of 100 patients | 2 out of 100 patients |
| Dehydration | 0 out of 100 patients | 0 out of 100 patients |
| Device Embolization (device movement) | 0 out of 100 patients | 0 out of 100 patients |

Potential Risks within 6 months of the Implant Procedure

The following table is a summary of the major clinical risks observed within 6 months of the implant procedure.

Table 2. Clinical risks within 6 months

| Risks | Treatment Group | Control Group (Standard Therapy) |
|---|------------------------|---|
| Death | 5 out of 100 patients | 7 out of 100 patients |
| Stroke | 0 out of 100 patients | 1 out of 100 patients |
| Myocardial Infarction (heart attack) or Chest Pain | 5 out of 100 patients | 6 out of 100 patients |
| Bleeding | 1 out of 100 patients | 1 out of 100 patients |
| Thrombosis (blood clot) | 1 out of 100 patients | 0 out of 100 patients |
| Ventricular Arrhythmia (abnormal rhythm of the lower chambers of the heart) | 2 out of 100 patients | 3 out of 100 patients |
| Kidney Dysfunction/Failure | 5 out of 100 patients | 3 out of 100 patients |
| Pulmonary Infections | 3 out of 100 patients | 4 out of 100 patients |
| Hypotension (low blood pressure) | 3 out of 100 patients | 3 out of 100 patients |
| Dehydration | 1 out of 100 patients | 0 out of 100 patients |
| Device Embolization (device movement) | 0 out of 100 patients | 0 out of 100 patients |

Potential Risks within 1½ years of the Implant Procedure

The following table is a summary of the major clinical risks observed within 1½ years of the implant procedure.

Table 3. Clinical risks within 1½ years

| Risks | Treatment Group | Control Group (Standard Therapy) |
|--------------|------------------------|---|
| Death | 18 out of 100 patients | 22 out of 100 patients |
| Stroke | 2 out of 100 patients | 2 out of 100 patients |

Table 3. Clinical risks within 1½ years

| Risks | Treatment Group | Control Group (Standard Therapy) |
|---|------------------------|----------------------------------|
| Myocardial Infarction (heart attack) or Chest Pain | 14 out of 100 patients | 11 out of 100 patients |
| Bleeding | 2 out of 100 patients | 3 out of 100 patients |
| Thrombosis (blood clot) | 2 out of 100 patients | 0 out of 100 patients |
| Ventricular Arrhythmia (abnormal rhythm of the lower chambers of the heart) | 7 out of 100 patients | 8 out of 100 patients |
| Kidney Dysfunction/Failure | 10 out of 100 patients | 6 out of 100 patients |
| Pulmonary Infections | 5 out of 100 patients | 9 out of 100 patients |
| Hypotension (low blood pressure) | 5 out of 100 patients | 5 out of 100 patients |
| Dehydration | 2 out of 100 patients | 1 out of 100 patients |
| Device Embolization (device movement) | 0 out of 100 patients | 0 out of 100 patients |

Long-term Data from the CardioMEMS US Post-Approval Study

Purpose

The purpose of the CardioMEMS US Post-Approval Study (PAS) was to show that the CardioMEMS™ HF System could be used safely and effectively to reduce heart failure hospitalizations in patients with NYHA Class III heart failure who experienced a heart failure hospitalization in the previous year.

Study Design

A total of 1200 subjects were enrolled at 104 study sites in the United States. All patients enrolled in the PAS were implanted with a CardioMEMS sensor and had their heart failure managed using pulmonary pressures in addition to standard of care. Patients were followed for two years after sensor implant.

Results

The PAS met both of its pre-specified safety endpoints with 0.4% of patients (5 out of 1214 patients who had an attempted implant) experiencing a device-related complication and one patient (out of 1200 patients with implanted sensors) experiencing a sensor failure (0.1% of study population).

The PAS also met its pre-specified primary effectiveness endpoint of reducing the rate of heart failure hospitalizations and showed that patients had 57% fewer heart failure hospitalizations at 1 year compared to the year prior to sensor implant.

As noted in the previous section, the CHAMPION trial was not designed to assess the benefit of using the CardioMEMS sensor by gender. Because of this, the PAS had a requirement to enroll at least 35% women and a pre-specified analysis of heart failure hospitalizations for both women and men. The goal to enroll at least 35% women was met and approximately 38% of patients enrolled in the PAS were women. Analysis of heart failure hospitalizations showed that women have a similar response to the use of CardioMEMS as men.

In summary, the CardioMEMS US PAS has demonstrated that the CardioMEMS HF System is safe (99.6% freedom from device-related complications and 99.9% freedom from sensor failure at 2 years) and effective (57% reduction in heart failure hospitalizations at one year), thus demonstrating the long-term safety and efficacy of the CardioMEMS HF system.

Sensor Implantation

Before the Implant Procedure

The CardioMEMS™ HF System technology provides physicians with reliable, accurate trends of pulmonary artery pressure measurements. This technology proved to be extremely valuable in the management of care for heart failure patients.

The CardioMEMS HF System provides a method to measure pulmonary artery pressure by using a wireless sensor implanted into the pulmonary artery (a vessel close to your heart). Once inserted, the System can provide this valuable information to your doctor as often as desired. This can be performed in the physician's office, clinic, or hospital. You will also be able to take pulmonary artery pressure measurements yourself at home. These home pressure measurements are then sent to a secure website. Your doctor can access the secure website to view your measurements allowing him/her to make earlier interventions (usually changes in medications) to manage your heart failure remotely.

Prior to the implant procedure, your doctor will discuss with you the benefits and risk associated with receiving the CardioMEMS HF System. You will be given detailed instructions about the implant procedure and any questions you may have will be answered.

As with any medical procedure, there are risks associated with the implantation of a sensor, although complications do not happen very often. You should talk with your doctor about these risks before undergoing the medical procedure. Some of these risks include but are not limited to:

- Air embolism
- Allergic reaction due to device component materials or procedure-related
- Infection
 - Upper respiratory infection
 - Bronchitis
 - Pneumonia
 - Acute Bronchitis
 - Groin abscess

- Methicillin-resistant staphylococcal aureus infection
- Pulmonary Infiltration
- Sepsis
- Arrhythmias
 - Ventricular tachycardia
 - Atrial fibrillation
 - Ventricular arrhythmia
 - Ventricular fibrillation
 - Atrial fibrillation with rapid ventricular response
 - Atrial flutter
 - Cardiac dysrhythmias
 - Tachycardia
 - Wide complex tachycardia
 - Atrial dysrhythmia
- Bleeding
 - Epistaxis/Nose bleeds
 - GI bleed
 - Bleeding - Other
 - Blood in stool
 - Catheter site bleeding
 - Catheter site ecchymosis
 - Hematuria
- Hemoptysis
- Hematoma (Bruising)
 - Hematoma
 - Catheter site hematoma
 - Vessel puncture site hematoma
- Nausea
- Cerebrovascular accident
 - Stroke/Transient ischemic attack
- Delayed wound healing
- Thrombus
 - Arterial thrombosis (limbs)
 - Blood clot
- Cardiovascular injury
 - Valve damage
 - Pseudoaneurysm formation
 - AV fistula
 - Pulmonary artery injury
- Myocardial infarction (Heart attack)
- Death
- Embolism
 - Pulmonary infarct
 - Pulmonary embolism
 - Device embolization
- Thermal burn
- Cardiac perforation
- Pneumothorax, thoracic duct injury, or hemothorax

Be sure to talk with your doctor so that you thoroughly understand all of the risks and benefits associated with the implantation of this system.

Implant Procedure

PA Sensor

The PA Sensor is permanently placed in the pulmonary artery (the blood vessel that moves blood from your heart to your lungs) during a right heart catheterization procedure.

The PA Sensor is about the size of small paper clip and has a thin, curved wire at each end. This sensor does not require any batteries or wires. It sends its pressure measurements to the Patient Electronics System.

Figure 8. PA Sensor



Implant Procedure

The steps of the implant procedure are:

1. You may receive a mild sedative before and/or during the procedure, but you will be awake so you can follow instructions.
2. A nurse will clean an area on your neck or groin and a local anesthetic (numbing) medicine will be injected at that site.
3. An electrocardiogram (EKG) will constantly monitor your heart rate and rhythm.
4. The doctor will make a small incision.
5. He or she will thread a device called a pulmonary artery catheter into your femoral or internal jugular vein. Using a fluoroscope (a type of x-ray), he or she will thread the PA catheter through your body to your heart and into your pulmonary artery.
6. Once the catheter is in the pulmonary artery, a small amount of contrast material (dye) is injected and pictures are taken to make sure the catheter is in the right position and to make sure the branch of the pulmonary artery is the appropriate size. This procedure is called angiography.
7. Next, the pulmonary artery catheter is removed and a delivery catheter with the PA Sensor attached is carefully threaded to your pulmonary artery over a guide wire (a very small wire used to guide catheters). The PA Sensor is then positioned in the pulmonary artery and released from the delivery catheter.
8. The delivery catheter will be removed and the pulmonary artery catheter positioned next to the Sensor. Once the PA Sensor is confirmed by x-ray to be in the correct position, it will stay inside the pulmonary artery permanently.
9. The doctor will hold a monitor (called an antenna) to your back, chest or side to obtain the Sensor's signal. Pulmonary artery pressure readings will be recorded from both the Sensor and the pulmonary artery catheter.
10. The pulmonary artery catheter is removed and the Sensor will remain in your pulmonary artery (see figure below).

Typically, the procedure may last up to one hour. If the doctor cannot safely pass the catheter into the pulmonary artery or if the pulmonary artery is not the appropriate size, you will not be able to receive the sensor.

Figure 9. Location of the Sensor Implant

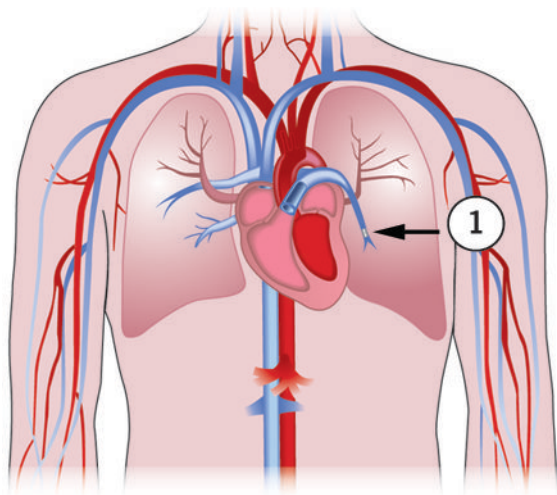

1. Implant location in Pulmonary Artery

After the Implant Procedure

After the procedure is completed, you may be asked to lie flat on your back for a few hours to prevent any bleeding from the catheter insertion site. You may feel some discomfort at the site as you recover. You should be able to return to normal activities soon after the procedure.

Your PA Sensor is permanently implanted. You will not feel it, and it will not interfere with your daily activities. The sensor will not interfere with other devices you may have such as a pacemaker, defibrillator, etc.

As you recover from your implant procedure, it is important that you follow your doctor's instructions, including:

- Report any redness, swelling, or drainage from the insertion site
- Walk, exercise, and bathe according to your doctor's instructions
- Contact your doctor if you develop a fever that does not go away in two or three days
- Ask your doctor any questions you may have about your device, heart failure, or medication

Before you go home, you will receive training about how to set-up and take readings with your Patient Electronics System. For your convenience, the steps for taking a reading are also provided in an easy to use Quick Start Guide.

Your doctor or nurse will complete a temporary Patient Implant Identification Card before you go home from the hospital. A permanent card will be mailed to you within a few weeks. This card provides information about the sensor to health care professionals so that the sensor can be identified correctly if you need a chest x-ray, CT scan, MRI or other testing. It contains your name, your doctor's name, and the serial numbers of your device. Always carry your Patient Implant Identification Card with you. It will alert medical and security personnel that you have an implanted device.

Taking a Home Reading

You will take readings using the Patient Electronics System (electronics) as instructed by your physician. To experience the most benefit from the CardioMEMS HF System, it is important that you take readings daily or as instructed by your physician. Taking readings should become part of your daily routine. It should only take about 2-3 minutes. If you are having trouble taking a reading, contact Technical Support at 844-MY-CMEMS (844-692-6367).

Important Safety Information

The electronics are not affected by interference produced by most common household electrical equipment. Electromagnetic interference from theft detection systems, airport security systems, etc., could make it difficult to take sensor measurements. However, it is highly unlikely that you would be taking measurements when you are close to these devices.

Electric Blankets, waterbeds, or metal in the vicinity of the antenna could cause interference. If so, move the electric blanket or metal out of the room. If you have a waterbed, take the measurement in another room.

Patient Electronics System

The Patient Electronics System reads the pressure measurement from your sensor wirelessly. The handheld unit has a touchscreen which can be used to set up the unit and change settings. You can connect the electronics to either a regular landline telephone, cellular adapter, or a Wi-Fi™¹ adapter.

The Patient Electronics System consists of the electronics unit and receiving antenna (encased within the pillow), and a handheld unit.

Figure 10. The Handheld Unit

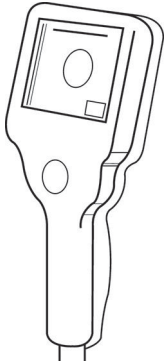
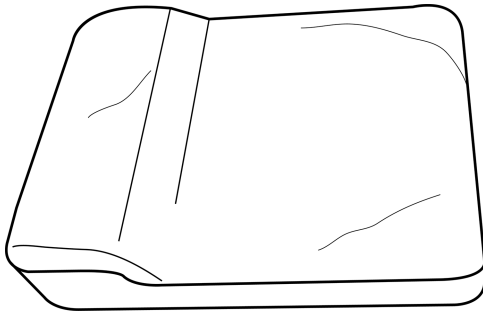

Figure 11. The Pillow



Setting Up the Patient Electronics

1. Remove the Patient Electronics System from the travel case.
2. Place the unit where you will lie down to take your reading.
3. Remove the power adapter and power cable from the storage pocket in the travel case.

Figure 12. Power adapter and power adapter cable

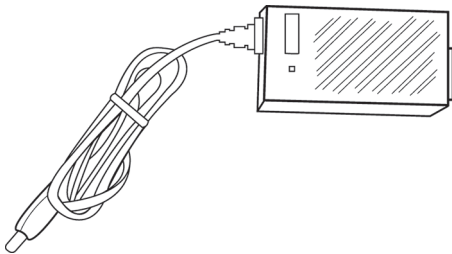

¹ Wi-Fi is a trademark of the Wi-Fi Alliance.

Figure 13. Power cable

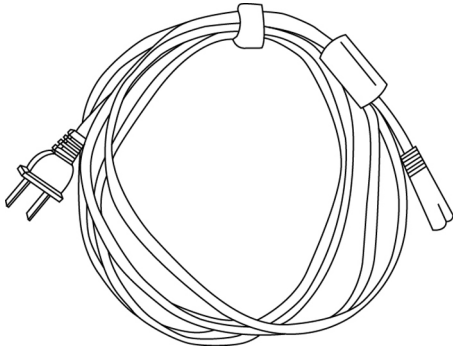

4. Insert the power cable into the power adapter.
5. Plug the power adapter cable into the power connector plug so they are connected all the way. Press the connected plugs securely into the molded groove on the back of the electronics unit.

Figure 14. Plug connections

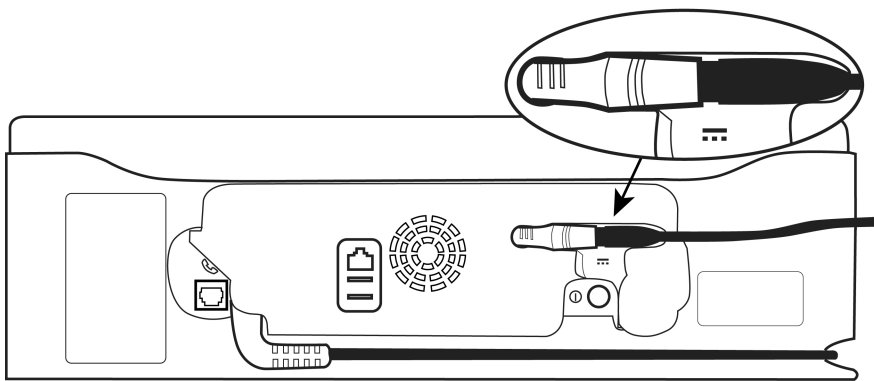

6. Plug the power cable into the wall electrical outlet.

Figure 15. Wall connection

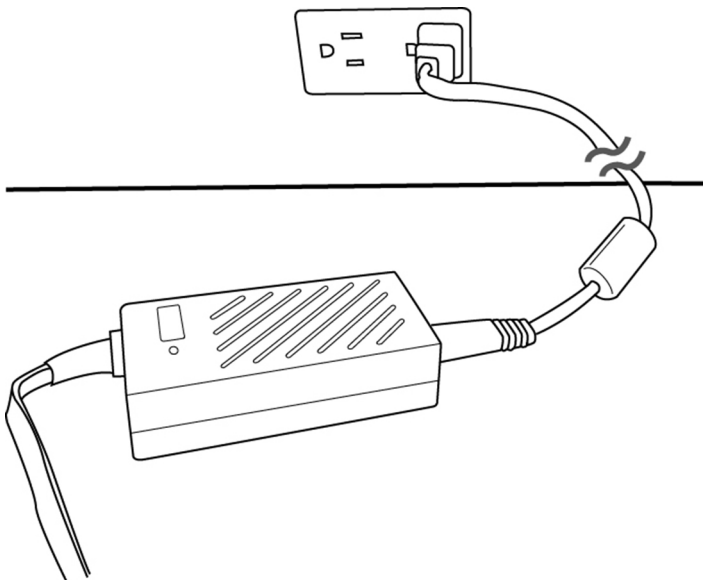

7. If you use a landline telephone to send your readings, connect the telephone cord. To complete the setup of your system, refer to the following section.

Connectivity Method

The Patient Electronics Systems are equipped with pre-installed USB cellular adapters. You can use the USB cellular adapter free of charge. If you do not have coverage in your area, you can use a telephone line or a Wi-Fi adapter as described below. To order a Wi-Fi adapter, contact Technical Support.

With a Telephone Line

To connect your system to a landline telephone:

1. Insert one end of the telephone cord into the back of the electronics unit.
A telephone cord is provided in the system package.
2. Insert the other end into a telephone jack in the wall.
You can use the phone splitter if the telephone jack already has a phone line connected to it.

Figure 16. Telephone cord connection

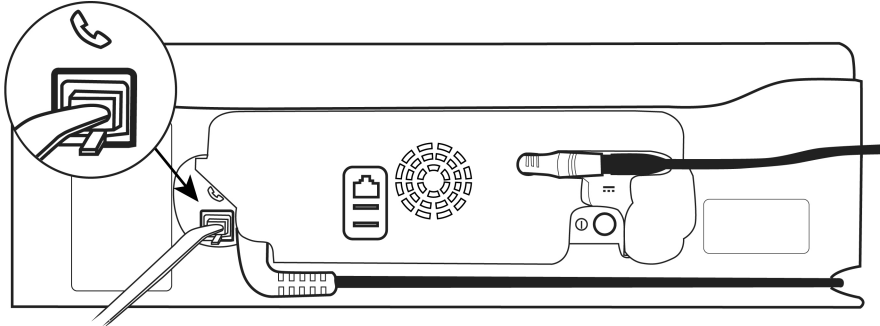

3. Use a screwdriver ² to unscrew the access door that is under the pillow.
4. Open the access door.
A USB cable is located in the compartment. Make sure that you do not unplug this cable. Do not untwist this cable as it may affect electromagnetic emissions.

Figure 17. Access door

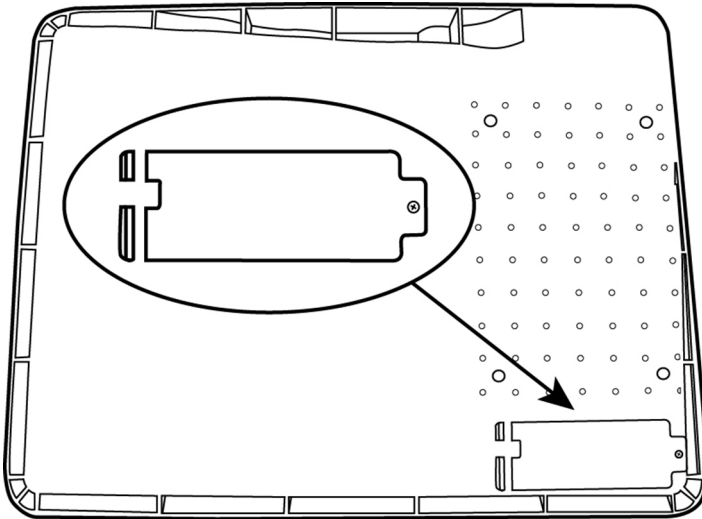

5. Disconnect the USB cellular adapter from the USB cable.

Figure 18. USB cellular adapter



² A recommended screwdriver is a P1 Phillips head screwdriver.

Figure 19. USB cellular adapter and cable connection

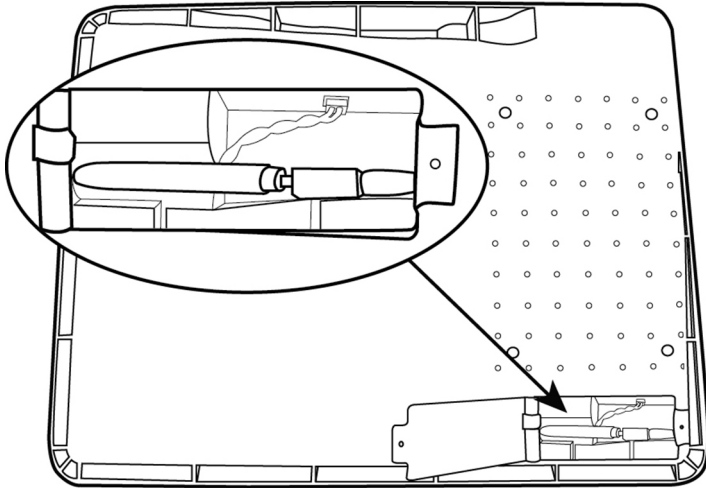

6. Close the access door and replace the screw.

NOTE: If your system is connected to Wi-Fi, and you want to connect to a landline telephone, remove the Wi-Fi adapter from the USB port.

With a Wi-Fi Adapter

To set up a Wi-Fi adapter:

1. While the electronics unit is powered off, insert the Wi-Fi™ adapter into either USB port on the rear of the unit.

Figure 20. Wi-Fi adapter



Figure 21. Wi-Fi adapter inserted into USB port

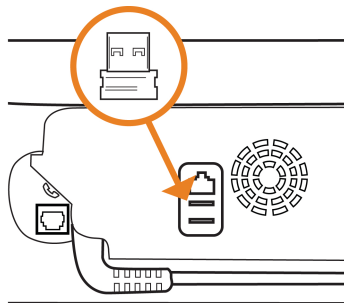

2. Press the power button on the back of the electronics unit to turn it on. A blue LED lights up. Once the electronics unit is powered on, the system prompts you to select a network and enter the password using the handheld unit touchscreen.

NOTE: If your system has a cellular adapter and Wi-Fi adapter plugged in, the system attempts to connect to Wi-Fi first.

Steps for Taking a Reading

1. Press the power button on the back of the electronics unit to turn it on.
A blue LED will light up.

Figure 22. Power button

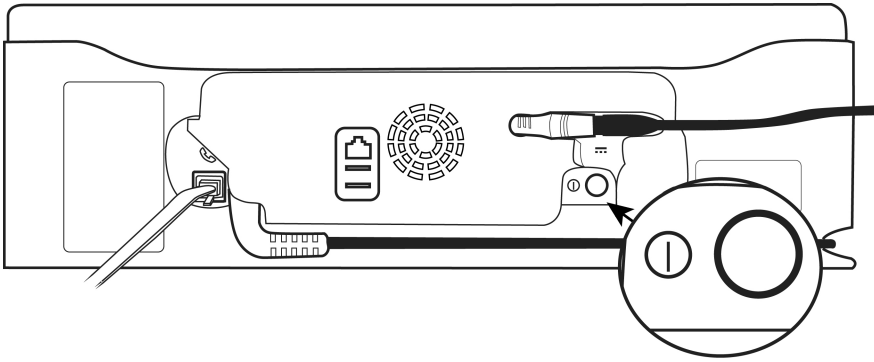

2. Remove the handheld unit from the storage area on the right side of the pillow.
Make sure that the cord of the handheld unit is attached to the back of the electronics unit.

Figure 23. Handheld unit in storage area

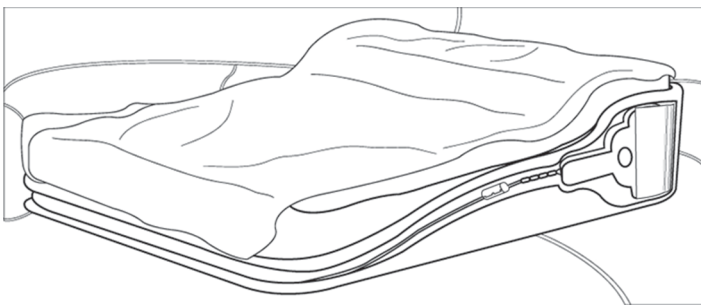
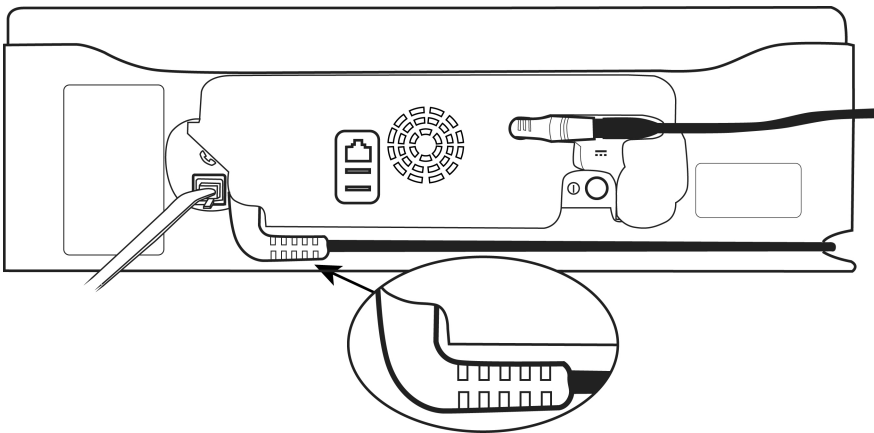

Figure 24. Cord of the handheld unit



3. After the electronics unit powers up, a screen with both a Start Button and an Options Button appears (figure below).
Once you see this screen, you know that the system is ready to use.

Figure 25. Initial Startup Screen



4. Carefully lie down in a comfortable position on the pillow while being aware of your surroundings.
The thickest part of the pillow is under your head during the reading.

Figure 26. Position on pillow

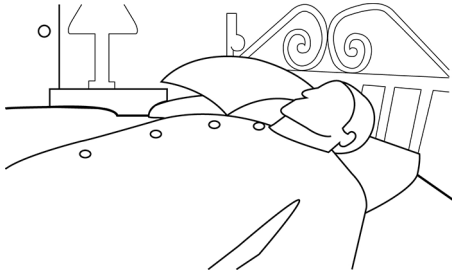

5. Once in position, press the green round button below the touchscreen on the handheld unit.

Figure 27. Remote button

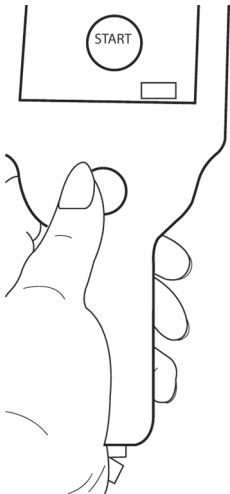

6. Lie still on the pillow. The system will guide you with voice prompts. The screen below appears while the system searches for a signal.
If your body position is good you will hear, "Good position on pillow. Stay still". If you hear, "Shift slightly on pillow", check your surroundings and carefully change your body position. Small movements work best.
If you have difficulty hearing the voice prompts, follow the instructions on the screen or have someone assist you in taking your reading. If you have difficulty seeing the instructions on the screen, follow the voice prompts or have someone assist you in taking your reading.
If you have difficulty obtaining a good position on the pillow, refer to the Troubleshooting the Patient Electronics System section or contact Technical Support.

WARNING: Avoid placing the handheld unit directly over the pillow during a reading.

Figure 28. Acquiring signal

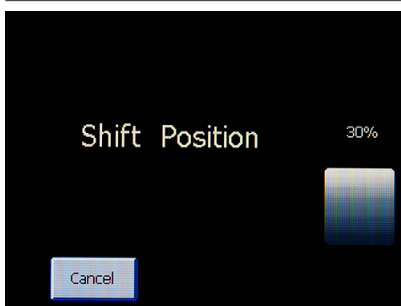

7. After the "Measuring" message appears, remain still for about 18 seconds while the music plays. When the reading is finished, you will hear "Reading completed, you may get up". Your information is automatically sent to your doctor.

Figure 29. Reading in Progress

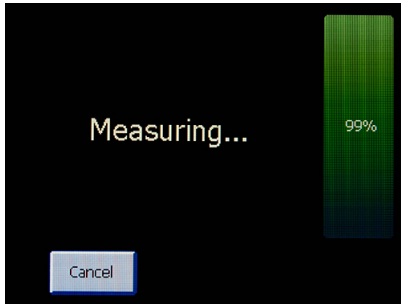

8. Once transmission is complete, the electronics unit turns off automatically.

The preferred method for taking a reading is to use the green button below the screen on the handheld unit as described above. An alternative method is to use the green Start indicator on the touchscreen.

If you cannot complete a reading after following the above steps, refer to the Troubleshooting the Patient Electronics System section or contact Technical Support.

Troubleshooting the Patient Electronics System

Table 4. Troubleshooting

| Problem | Symptom | Solution |
|---|---|---|
| Cannot get a signal |  | <p>Check for any noticeable damage to the unit. Make sure there is no metal near the pillow. Make sure there is no electric blanket near the pillow. Carefully reposition yourself on the pillow. Call Technical Support.</p> |
| Reading completes but cannot send data to your doctor |  | <p>Check the USB cellular adapter, phone line, or Wi-Fi adapter.</p> |

Table 4. Troubleshooting

| Problem | Symptom | Solution |
|---|---|--|
| Touchscreen does not respond | Buttons are not activated by repeated presses | <p>Make sure the phone line is working or you are getting adequate signal strength on your wireless connection.</p> <p>Make sure the phone line is not busy. Make sure your Wi-Fi network name and password are correct.</p> <p>Make sure the electronic unit is dialing the phone line with the correct pre-fix, if necessary.</p> <p>Call Technical Support.</p> |
| Takes a long time to get a reading | Takes a long time (> 30 seconds) to get a good signal System loses signal during reading and must re-start | <p>Carefully reposition yourself on the pillow until the Signal Strength bar shows a higher signal strength and turns green.</p> <p>Make sure there are no electronics or metal in the vicinity of the measurement that may cause interference.</p> <p>Use the orientation ball to find the correct position.</p> <p>Call Technical Support.</p> |
| Reading completes but is rejected by system | Error message says to repeat reading and reposition pillow away from any cords or metal objects | <p>Remove any cords or metallic objects near the pillow or the pillow cable.</p> <p>Make sure there is no metal near the pillow.</p> <p>Make sure there is no electric blanket near the pillow.</p> |
| Numeric error message | Error message with a number appears on the screen | Note the error. |

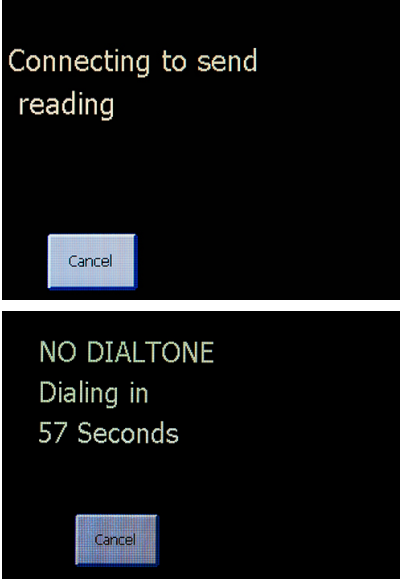
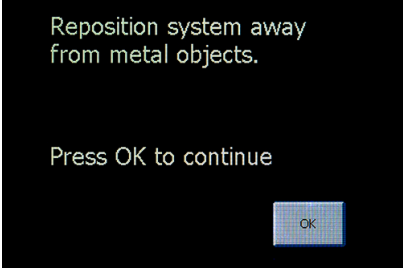
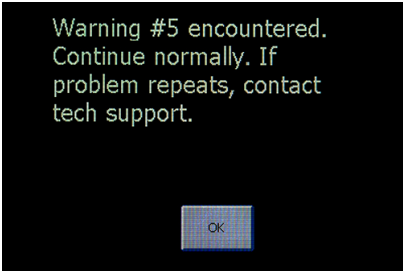

Table 4. Troubleshooting

| Problem | Symptom | Solution |
|--------------------------------|--|---|
| | | Select the OK button to acknowledge the error, wait for the error to transmit, and let the electronics unit shut down. Call Technical Support. |
| | Error #0 | There is a problem with the connections in the system such that important information cannot be sent. |
| | Error #1 | The electronics system recorded an obviously incorrect value for the atmospheric pressure. |
| | Error #2 | The two atmospheric pressure sensors in the electronics system do not agree. |
| | Error #3 | Important data needed to make a measurement was not available. |
| | Error #4 | The internal settings values needed to make a measurement were missing or damaged. |
| | Error #5 | The atmospheric pressure sensor indicated an error in recording pressure or temperature. |
| | Error #6 | An important part of the software was not able to run. |
| |  | |
| Time of Day Clock is incorrect | Warning #5 message appears on the screen | Note the warning. Turn off the electronics unit from the Options menu. Restart the electronics unit. If the warning appears a second time, the time back-up battery may be dead. Continue to take readings until you are able to replace the battery. To replace the battery: <ol style="list-style-type: none"> 1. Use a screwdriver to remove the access door marked with a battery symbol on the back panel of the electronics. 2. Turn off and unplug the unit. 3. Remove the screws on the access door. Once the door is removed, note the "+" and "-" symbols which show the direction of the battery. 4. Replace the battery (type BR2032) and reinstall the access door. Call Technical Support if this does not resolve the issue. |

Orientation Ball

You may have used an Orientation Ball (shown below) during your initial training to help you find the best position for reading your sensor. After training, if you have difficulties remembering that position, use the ball to mark the right spot.

Figure 30. Orientation ball



To find the best position and place the ball on the pillow:

1. Check your surroundings and carefully take several readings in various positions. Watch the signal strength bar and follow the voice instructions.
2. Find the position in which the signal strength is highest.
3. Peel the paper on the flat side of the ball from the adhesive.
4. Remove the pillow cover from the pillow.
5. Place the ball in a location on the pillow that will help you return to this body position.
6. Place the pillow cover back over the pillow when you are done.

For all future readings, position yourself so you can feel the ball at the same location on your body.

Figure 31. Orientation ball on the pillow

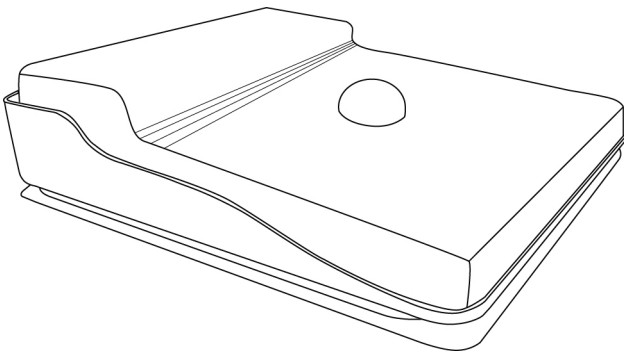

Additional Features

The first screen on your electronics unit has an Options button. This button opens a menu with additional features that allow you to customize your system. These features are described in the table below.

To navigate between screens, select the Options button. To return to the Start screen, press the green button below the touchscreen on the handheld unit.

Figure 32. Options button

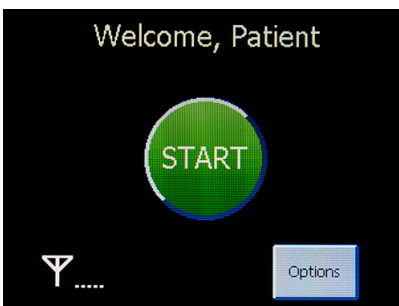

Table 5. Additional Features

| Screen | Description |
|-----------------------|--|
| Volume | Select the Volume Up button (+) to increase and the Volume Down button (-) to decrease. Adjust the volume so that you can clearly hear the signals and the voice commands. |
| Power Off | Select the Off button to turn off the device. The unit automatically shuts down after you take a reading. |
| Telephone Dial Prefix | Use this screen to set the dial prefix when traveling with your unit. For units with a landline telephone connection. |

Table 5. Additional Features

| Screen | Description |
|---------------------|---|
| Send Readings | Select the Send button to send a previously recorded reading. Readings are automatically sent after you take a reading. |
| Remote Access | Select the Enable button to grant a technician access to your unit. |
| Save Logs | Select the Save button to save the system logs to a USB flash drive. Use this feature when you are unable to connect to the system. |
| Diagnostic Test | Select the Run button to perform a diagnostic test. |
| System Info | System Information |
| Patient Info | Patient Information |
| Wi-Fi Configuration | Select the Get Status button to view the Wi-Fi connection status. Select the Configure button to set up the Wi-Fi connection. For units with a Wi-Fi adapter installed. |
| Select Language | Select the Next button to navigate between languages. Select the Select button to make your selection. This screen appears when you start the unit if a language has not been already selected. |
| Calibrate Screen | Select the Calibrate button to reset the calibration settings of the touchscreen. |
| Advanced Options | Clinician options |

Software Update

The system automatically checks for a software update after transferring data. The update occurs automatically and takes approximately 20 minutes depending on the network connection. The system shuts down once the update is complete.

Living with your CardioMEMS HF System

It is important to follow your doctor's instructions as well as the following recommendations:

- To experience the most benefit from the CardioMEMS™ HF System, it is important that you take readings daily or as instructed by your physician.
- Attend your scheduled doctor's office visits. Your doctor will arrange a follow-up plan with you to check your device and overall health on a regular basis.
- You should take your CardioMEMS HF System with you when you travel.
- Your doctor may also use the CardioMEMS HF system when you are seen in the office, the hospital or the emergency room and use that information with the PA pressure information you have transmitted from home to determine the best way to manage your heart failure, so it is very important that you take readings as instructed.
- Carry your identification card with you at all times
- Tell your family doctor, dentist, and emergency personnel that you have an implanted device.

Your sensor will not alert airport security when you pass through the security checkpoint.

You can travel with your Patient Electronics System. Pack the electronics in its carrying case and bring it on the plane as a carry-on or check it as luggage. A letter stating that your Patient Electronics System is a medical device and should be allowed as cabin baggage is available at cardiovascular.abbott.com.

The radiofrequency that powers your sensor only works with the Patient Electronics System; it will not "pick up" anything else.

When to Call Your Doctor

Your doctor will provide instructions for when you should contact him or her. In general, phone your doctor if you:

- Have worsening shortness of breath or chest pain
- Develop a fever that does not go away in two or three days
- Have questions about your device, heart failure, or medications
- Notice anything unusual or unexpected, such as new symptoms that you have not had before

Care of the Patient Electronics System

Pillow Cover

The pillow cover is a cotton and polyester blend. Machine wash the cover on the delicate cycle, when necessary. You can also hand wash it. Make sure that you use mild cleaning agents only.

If the plastic pillow becomes soiled, you may wipe the plastic pillow with a damp cloth and mild detergent. This may be done as frequently as needed. Do not machine wash or immerse the plastic pillow in water or any cleaning solution.

Electronics Unit and Handheld Unit

Turn off and unplug the unit before cleaning it.

Wipe the electronics unit and cables with a slightly damp cloth using soap, a mild detergent, or water. You should not use cleaning agents that contain acid or harsh chemicals such as bleach or ammonia. Dry all parts before plugging the unit back in.

To clean the touchscreen on the handheld unit, use either water or a commercially available cleaning solution designed for a display or touchscreens.

Stand away from the electronics unit and spray the cleaning solution onto a clean, lint-free cloth until it is slightly damp. Without applying excessive pressure, clean the screen.

Do not submerge the electronics unit in any liquid. Do not spray it or allow fluid to enter it. Should this occur, do not use the electronics unit and contact Technical Support for assistance.

Do not untwist the USB cable inside the unit as it may affect electromagnetic emissions.

Replacing your Patient Electronics System

There may be a time when your Patient Electronics System will need to be exchanged or replaced. Should this occur, Technical Support will assist with the replacement of your system with minimal interruption. During the exchange period, notify your doctor and follow his/her instructions.

Setting Up a Replacement System

Most Patient Electronics Systems will have cellular connections. The steps to set up a Wi-Fi connection are the same as those stated below except that you are prompted to select your network name and enter your Wi-Fi password before continuing with the setup.

Follow these steps if a cellular connection is available:

1. When the system starts, it will prompt for the language and country.
2. To select the language, press the Next button until the desired language appears and then press the Select button.
3. To select the country, press the Next button until the desired country appears and then press the Select button.
4. The system will prompt for the 6 digit sensor serial number that can be found on the patient identification card.
5. Select the Enter button and then type in the serial number using the keyboard.
6. The Patient Electronics System will then download the necessary information and then prompt you to confirm the information.
7. When the system is successfully setup the system will display your name above the Start button.

The following screens illustrate the sequence:

Figure 33. The Select Language screen

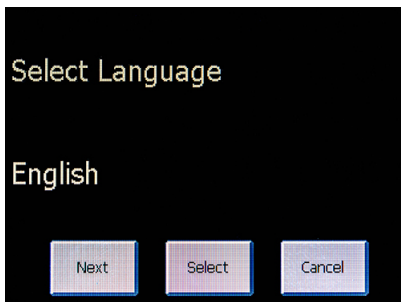

Figure 34. The Select Country screen

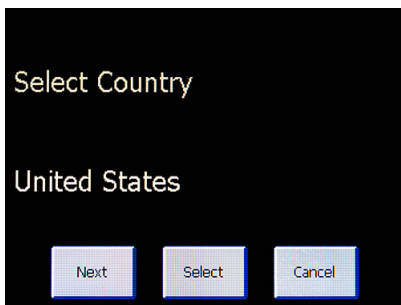

Figure 35. The Patient Electronics System will prompt to enter sensor serial number. This 6-digit number can be found on the Patient Identification Card you received after your implant procedure.

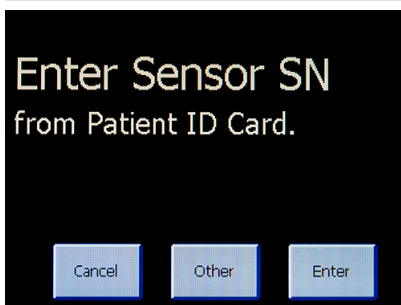

Figure 36. Confirm name and sensor information.

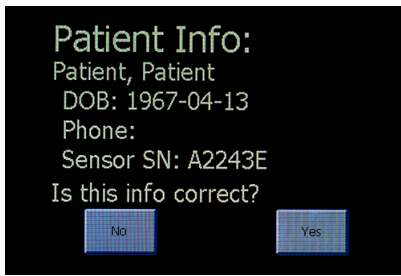
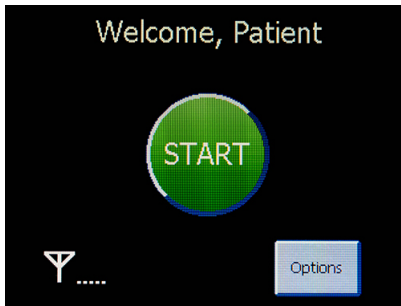

Figure 37. Your name will be displayed on the Start screen every time the system is started.



For Patient Electronics Systems using a landline connection, follow these steps:

1. When the system starts, it will prompt for the language and country.
2. To select the language, press the Next button until the desired language appears and then press the Select button.
3. To select the country, press the Next button until the desired country appears and then press the Select button.
For landline connections, it is important that you select the correct country.
If your country is not shown, select the Other option.
4. The system will prompt you to plug in the telephone line and click OK.
5. The next screen will prompt for the 6 digit sensor serial number that can be found on your patient identification card.
6. Select the Enter button and then type in the serial number using the keyboard.
7. The Patient Electronics System will then download the necessary information and prompt you to confirm the information.
8. When the system is successfully setup the system will display your name above the Start button.

The following screens illustrate the sequence:

Figure 38. The Select Language screen

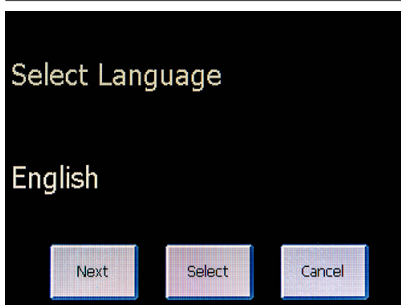

Figure 39. The Select Country screen

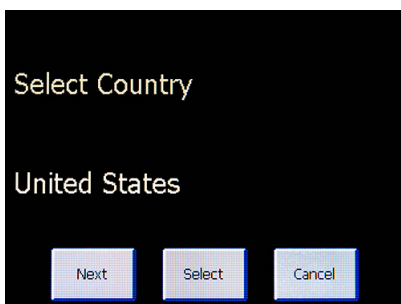

Figure 40. The Patient Electronics System will prompt to plug in telephone line.

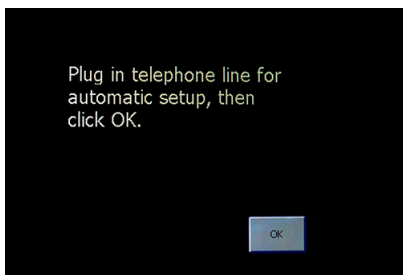

Figure 41. The Patient Electronics System will prompt to enter sensor serial number. This 6-digit number can be found on the Patient Identification Card you received after your implant procedure.

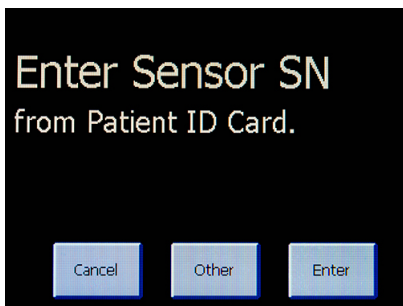

Figure 42. Confirm name and sensor information.

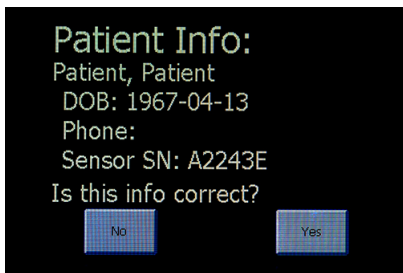
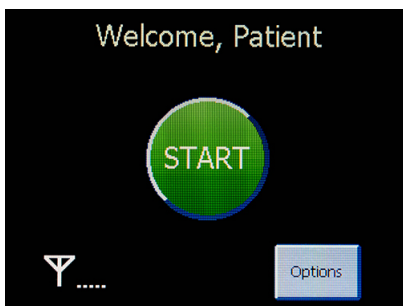

Figure 43. Your name will be displayed on the Start screen every time the system is started.



Repacking

1. Unplug the power cable from the wall.
2. Remove the connected power plugs from the molded groove in the back of the unit and unplug the power adapter cable plug from the power connector plug. Press the power connector plug securely into the molded groove for storage.

Figure 44. Power adapter cable connection

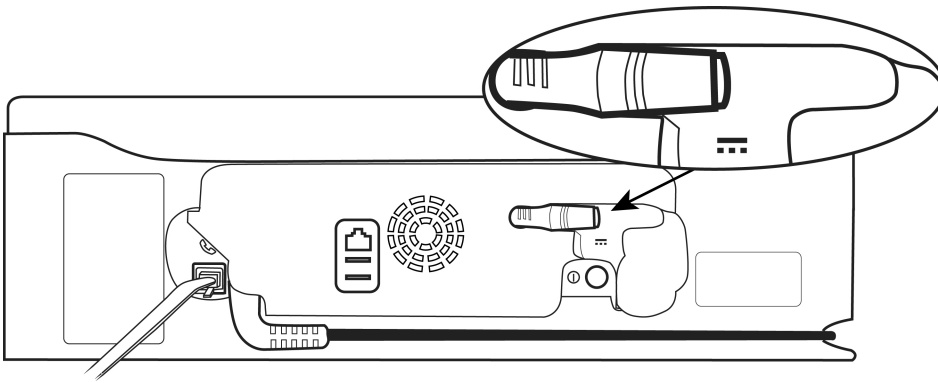

3. Place the cord of the handheld unit through the groove at the bottom of the pillow.

Figure 45. Handheld cord in groove

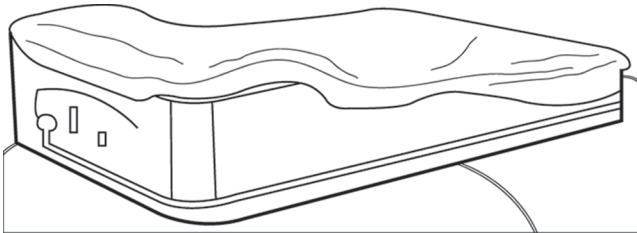

4. Place the handheld unit into the storage space on the right side of the pillow. Make sure that the screen faces out.

Figure 46. Handheld unit in storage area

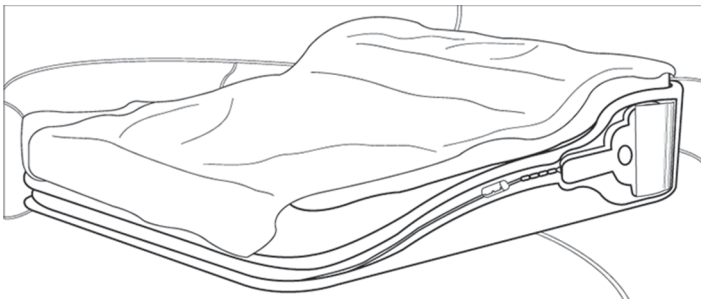

5. If you use a landline connection, unplug the telephone cord from the back of the electronics unit and from the wall.

Figure 47. Telephone cord connection

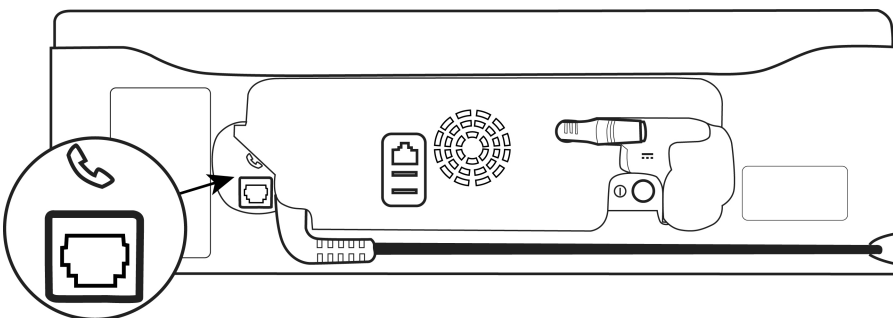

6. Gently lift the electronics unit and place it securely into the carrying case.

Figure 48. Carrying case

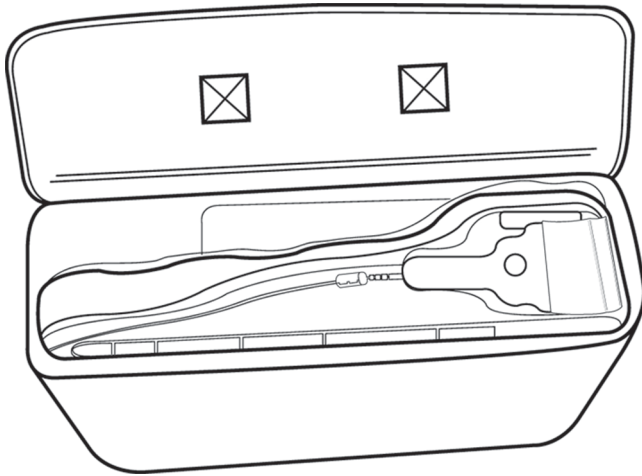

7. Place the power cable and telephone cord into the storage slot.
8. Place your instructions in the carrying case.

Figure 49. Cable storage area

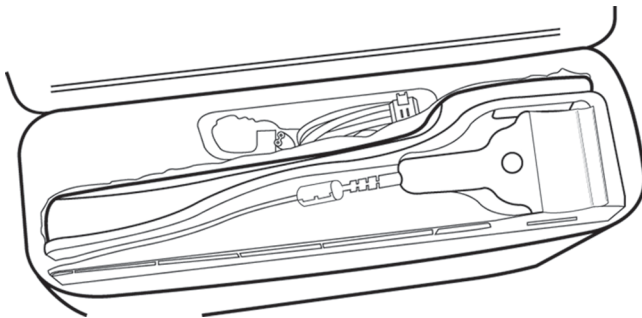

9. Close and zip the carrying case.

Electromagnetic Interference and Electromagnetic Compatibility

This section provides a brief overview of Electromagnetic Interference and Electromagnetic Compatibility guidance associated with the use of the CM1100.

Table 6. Electromagnetic Emissions

Guidance and manufacturer's declaration – electromagnetic emissions

The electronics unit is intended for use in the electromagnetic environment specified below.

The customer or the user of the electronics unit should assure that it is used in such an environment.

| Emissions test | Compliance | Electromagnetic environment - guidance |
|--|---|--|
| RF emissions CISPR 11 Intentional CISPR 11 Unintentional CISPR 22 | Class A, Group 2 Class B, Group 2 Class B | The electronics unit must emit electromagnetic energy in order to perform its intended function. Nearby electronic equipment may be affected. The electronics unit is suitable for use in all establishments, including domestic establishments and those directly connected to the public low-voltage power supply network that supplies buildings used for domestic purposes. |
| Harmonic emissions IEC 61000-3-2 | Class A | Do not untwist the USB cable inside the unit as it may affect electromagnetic emissions. |
| Voltage fluctuations/ Flicker emissions IEC 61000-3-3 | Complies | |

Table 7. Electromagnetic Immunity

Guidance and manufacturer's declaration – electromagnetic immunity

The electronics unit is intended for use in the electromagnetic environment specified below. The customer or the user of the electronics unit should assure that it is used in such an environment.

| Immunity Test | IEC 60601 Test level | Compliance level | Electromagnetic environment - guidance |
|--|-----------------------------|-----------------------------|---|
| Electrostatic discharge (ESD) IEC 61000-4-2 | ±8 kV contact ±15 kV air | ±8 kV contact ±15 kV air | Floors should be wood, concrete or ceramic tile. If floors are covered with synthetic material, |

Table 7. Electromagnetic Immunity

Guidance and manufacturer’s declaration – electromagnetic immunity

The electronics unit is intended for use in the electromagnetic environment specified below. The customer or the user of the electronics unit should assure that it is used in such an environment.

| Immunity Test | IEC 60601 Test level | Compliance level | Electromagnetic environment - guidance |
|--|--|--|---|
| Electrical fast transient/burst IEC 61000-4-4 | ±2 kV for power supply lines ±1 kV for input/output lines | ±2 kV for power supply lines ±1 kV for input/output lines | the relative humidity should be at least 30%. Mains power quality should be that of a typical commercial or hospital environment |
| Surge IEC 61000-4-5 | ±1 kV line(s) to line(s) ±2 kV line(s) to earth | ±1 kV line(s) to line(s) ±2 kV line(s) to earth | Mains power quality should be that of a typical commercial or hospital environment |
| Voltage dips, short interruptions and voltage variations on power supply input lines IEC 61000-4-11 | < 5% U_T ³ (>95% dip in U_T) for 0.5 cycle | < 5% U_T (>95% dip in U_T) for 0.5 cycle | Mains power should be that of a typical commercial or hospital environment. If the user of the electronics unit requires continued operation during power mains interruptions, it is recommended that the electronics unit be powered from an uninterruptible power supply or a battery. |
| | 40% U_T (60% dip in U_T) for 5 cycles | 40% U_T (60% dip in U_T) for 5 cycles | |
| | 70% U_T (30% dip in U_T) for 25 cycles | 70% U_T (30% dip in U_T) for 25 cycles | |
| | < 5% U_T (>95% dip in U_T) for 5 sec | < 5% U_T (>95% dip in U_T) for 5 sec | |
| Power frequency (50/60 Hz) Magnetic field IEC 61000-4-8 | 30 A/m | 30 A/m | Power frequency magnetic fields should be at levels characteristic of a typical location in a typical commercial or hospital environment. |
| Conducted RF IEC 61000-4-6 | 3 Vrms 150 kHz to 80 MHz ISM Bands | 3 Vrms 6 Vrms | Portable and mobile RF communication equipment should be no closer to any part of the electronics unit, including cables, than the recommended separation distance calculated from the equation applicable to the frequency of the transmitter. Recommended separation distance $d = 1.2 \sqrt{P}$ $d = 1.2 \sqrt{P}$ 80 MHz to 800 MHz $d = 2.3 \sqrt{P}$ 800 MHz to 2.7 GHz where P is the maximum output power rating of the transmitter in watts (W) according to the transmitter manufacturer and d is the recommended separation distance in meters (m). Field strengths from fixed RF transmitters, as determined by an electromagnetic site survey, should be less than the compliance level in each frequency range ⁴ . Interference may occur in the vicinity of equipment marked with the following symbol: |
| Radiated RF IEC 61000-4-3 | 10 V/m 80 MHz to 2.7 GHz | 10 V/m | |



a: Field strengths from fixed transmitters, such as base stations for radio (cellular/cordless) telephones and land mobile radios, amateur radio, AM and FM radio broadcast and TV broadcast cannot be predicted theoretically with accuracy. To assess the electromagnetic environment due to fixed RF transmitters, an electromagnetic site survey should be considered. If the measured field strength in the location in which the electronics unit is used exceeds the applicable RF compliance level above, the electronics unit should be observed to verify normal operation. If abnormal performance is observed, additional measures may be necessary, such as reorienting or relocating the electronics unit.

³ U_T is the a.c. mains voltage level prior to application of the test level.

⁴ Over the frequency range 150 kHz to 80 MHz, field strengths should be less than 3 V/m.

Table 8. Recommended separation distances between portable and mobile RF communications equipment and the electronics unit

The electronics unit is intended for use in an electromagnetic environment in which radiated RF disturbances are controlled. The customer or the user of the electronics unit can help prevent electromagnetic interference by maintaining a minimum distance between portable and mobile RF communications equipment (transmitters) and the electronics unit as recommended below, according to the maximum output power of the communications equipment.

| Rated Maximum output power of transmitter (W) | Separation distance according to frequency of transmitter ⁵ | | |
|---|--|--|----------------------------------|
| | 150 kHz to 80 MHz d = 1.2 √P | 80 MHz to 800 MHz ⁶ d = 1.2 √P | 800 MHz to 2,7 GHz d = 2.3 √P |
| 0.01 | 0.12 m | 0.12 m | 0.23 m |
| 0.1 | 0.38 m | 0.38 m | 0.73 m |
| 1 | 1.20 m | 1.20 m | 2.30 m |
| 10 | 3.79 m | 3.79 m | 7.27 m |
| 100 | 12.00 m | 12.00 m | 23.00 m |

For transmitters rated at a maximum output not listed above, the recommended separation distance (d) in meters can be estimated using the equation applicable to the frequency of the transmitter, where P is the maximum output power rating of the transmitter in watts (W) according to the transmitter manufacturer.

For two electronics units operating simultaneously and in proximity test results indicate that the separation distance should be greater than 4 meters (13 feet and 2 inches).

FCC Statement

This device complies with Part 18 of the FCC rules.

The PA Sensor is approved for wireless transmission under FCC ID number R3PCS-A-000051. The sensor complies with Part 15 of the FCC Rules. Operation is subject to the following two conditions: 1) this device may not cause harmful interference and 2) this device must accept any interference received, including interference that may cause undesired operation.

This equipment complies with Part 68 of the FCC rules and the requirements adopted by the ACTA. On the exterior of this equipment is a label that contains, among other information, a product identifier in the format:

RN: US: SJMMM00B13

If requested, this number must be provided to the telephone company.

Table 9. Product Identifier

| Identifier | Description |
|---------------------------------|-----------------|
| FCC Registration Number (modem) | US: SJMMM00B13 |
| USOC Jack Type | RJ11 (US) |
| Ringer Equivalence Number (REN) | 00B (no ringer) |

A FCC compliant telephone cord and modular plug is provided with this equipment. This equipment is designed to be connected to the telephone network or premises wiring using a compatible modular jack that is Part 68 compliant.

The REN is used to determine the quantity of devices that may be connected to the telephone line. Excessive RENs on the telephone line may result in the devices not ringing in response to an incoming call. Typically, the sum of RENs should not exceed five (5.0). To be certain of the number of devices that may be connected to a line (as determined by the total RENs) contact the local telephone company.

If the CM1100 modem causes harm to the telephone network, the telephone company will notify you in advance that temporary discontinuance of service may be required. But if advance notice isn't practical, the telephone company will notify the customer as soon as possible. Also, you will be advised of your right to file a complaint with the FCC if you believe it is necessary.

The telephone company may make changes in its facilities, equipment, operations or procedures that could affect the operation of the equipment. If this happens the telephone company will provide advance notice in order for you to make necessary modifications to maintain uninterrupted service.

If you have trouble with the CM1100 modem, for repair or warranty information, contact Technical Service.

If the equipment is causing harm to the telephone network, the telephone company may request that you disconnect the equipment until the problem is resolved.

Connection to party line service is subject to state tariffs. (Contact the state public utility commission, public service commission or corporation commission for information.)

CAUTION: Per FCC Rules, changes or modifications to the CM1100 modem not approved by St. Jude Medical could void your right to operate the CM1100 modem.

If your home has specially wired alarm equipment connected to the telephone line, ensure the installation of the CM1100 modem does not disable your alarm equipment. If you have questions about what will disable alarm equipment, consult your telephone company or a qualified installer.

⁵ These guidelines may not apply in all situations. Electromagnetic propagation is affected by absorption and reflection from structures, objects, and people.

⁶ At 80 MHz and 800 MHz, the separation distance for the higher frequency range applies.

System Specifications

Electrical Characteristics

Power

- Power Supply: Medical Grade Class II. Input: 100-240 V, 50-60 Hz, output: 12 VDC, 4.2 A.
- Manufacturer part number: CC-002403.
- Only use power cord (CC-002367) supplied by the manufacturer.

Radiofrequency (RF) Characteristics

- Transmitted Electrical Power: < 1mW e.r.p.
- Operating Frequency: 30-37.5 MHz. Under normal operating conditions the measurement bandwidth is approximately 1 MHz within the operating frequency range.

Mechanical Characteristics

Electronics Unit

- Weight: approximately 10 pounds
- Dimensions: Height: 5 inches Width: 16.25 inches Length: 21.4 inches
- Product Life: 5 years
- Accessible I/O: 2 USB, VGA
- I/O accessible through wireless access panel: USB reserved for GSM, USB
- Handheld unit: Reference manufacturer's part number CS-001261

Display

- Touch Screen: Resistive
- Brightness: 250 cd/m²
- Resolution: 320 x 240, color

Environmental Information

- Operation: 5°C to 40°C (41°F to 104°F), 15% to 93% humidity (non-condensing), 700-1060 hPa (System), 800-1150 hPa (implanted sensor)
- Transportation: -25°C to 70°C (-13°F to 158°F), and up to 93% humidity (non-condensing)
- Storage: -25°C to 70°C (-13°F to 158°F), and up to 93% humidity (non-condensing)
- Time necessary to cool from 70°C to 40°C (at 20°C ambient) before use: 60 minutes
- Time necessary to warm from -25°C to 5°C (at 20°C ambient) before use: 60 minutes

Classification

- Class II equipment
- Type BF insulation
- Ordinary Equipment IP21
- Continuous Use

Testing

System Testing

- System Accuracy (under typical environmental conditions): ± 2 mmHg at baseline and $\pm 3\%$ of difference between measured pressure and baseline
- System Accuracy: ± 4 mmHg over the range of environmental conditions
- The CM1100 was issued an ETL/cETL Listing Mark

Safety Testing

- IEC 60601-1
- ANSI ES 60601-1
- CENELEC EN 60601-1
- CAN/CSA-C22.2 No. 60601-1

EMI/EMC Testing

- CENELEC EN 60601-1-2
- ETSI EN 301 489-1

Wireless Testing















- FCC part 18 (Electronics System)
- FCC part 15 (Sensor)
- ETSI EN 301 489-3
- ETSI EN 302 510
- CISPR 11
- CISPR 22











Software

This device contains open source software. Source code is available upon request.

Symbols

The following symbols may be found on the product or product label:

| Symbol | Description |
|---|------------------------------------|
|  | Reorder number |
|  | Non-ionizing radiation |
|  | Consult instructions for use |
|  | Temperature limitations |
|  | Humidity limitation |
|  | Keep dry |
|  | Type BF Patient Applied Part |
|  | Manufacturer |
|  | Date of Manufacture |
|  | Direct current |
| IP21 | IEC 60529 Ingress Protection Level |
|  | Cellular |
|  | Wi-Fi |
|  BR2032 | Battery type |
|  | Telephone adapter |
|  | Momentary pushbutton |

| Symbol | Description |
|---|---|
|  | Federal Communication Commission Number (FCC ID: #) |
|  | Class II equipment |
|  | The device contains a battery and the label is affixed to this device in accordance with European Council Directives 2002/96/EC and 2006/66/EC. These directives call for separate collection and disposal of electrical and electronic equipment and batteries. Sorting such waste and removing it from other forms of waste lessens the contribution of potentially toxic substances into municipal disposal systems and into the larger ecosystem. Return the device to St. Jude Medical at the end of its operating life. |
| Made in USA. | Made in USA |
|  | Prescription use only |
|  | Conforms to AAMI Std ES60601-1 IEC Std 60601-1-11 Certified to CAN/CSA std C22.2 No. 60601-1 |
|  | Serial number |
|  | Quantity, package contents |
|  | Australian Communications and Media Authority (ACMA) and New Zealand Radio Spectrum Management (RSM) Regulatory Compliance Mark (RCM) |
|  | Manufacturing facility |
|  | Electrostatic discharge sensitive component |

WEEE Compliance Statement

The 2002/96/EC Directive on Waste Electrical and Electronic Equipment (the WEEE Directive) states that new equipment placed on the market within the European Union must comply with the WEEE directive which aims to ensure that products can be easily broken down or recycled at the end of the life cycle. We are committed to complying with the EC WEEE directive. Products put on the market are required to be marked with the crossed through recycling bin symbol and something that identifies that it was put on the market on or after this date.

Replacement and Limited Warranty Summary

This Limited Warranty is available for a period of five (5) years following delivery to the original purchaser if the CardioMEMS™ Patient Electronics System (“System”) fails to function within expected operating specifications due to defects in materials or workmanship.

This warranty does not cover damage due to external causes, including but not limited to accident, electrical power problems, servicing not authorized by St. Jude Medical, usage not in accordance with product instructions, due to abuse, or misuse.

During the five-year warranty period, St. Jude Medical will repair or replace a malfunctioning System. To qualify for such repair or replacement, St. Jude Medical must be notified within 30 days of the malfunction and, if so directed by St. Jude Medical, the purchaser or user must return the System for repair or replacement. For instructions on how to return the System, contact St. Jude Medical at 844 MY CMEMS (844-692-6367).

If warranty service is required, contact St. Jude Medical. If St. Jude Medical repairs or replaces the System, the warranty term will be for the remainder of the original term or 60 days, whichever is longer. This summary does not add to, vary or amend any of the terms of the Limited Warranty contained in the Limited Warranty Card supplied in the product packaging.

Refer to the Limited Warranty card.

Technical Support

Monday through Friday (8 a.m. to 8 p.m. Eastern Standard Time)

- 1 844 692 6367 (1 844 MY CMEMS) (toll-free within North America)
- 1 818 493 4258

Monday through Friday (8 a.m. to 5 p.m. Central European Time)

- 46 8 474 4756 (Sweden) (Support in English and Swedish. For additional assistance, contact your clinic.)



St. Jude Medical
 387 Technology Circle NW
 Atlanta, GA 30313 USA
 +1 866 240 3335



St. Jude Medical
 One St. Jude Medical Drive
 St. Paul, MN 55117-9913 USA

sjm.com

2022-03
 ARTEN600134937 B



6 0 0 1 3 4 9 3 7



St. Jude Medical
 387 Technology Circle NW, Suite 500
 Atlanta, Georgia 30313 USA



ST. JUDE MEDICAL™