

RELAY[®] PRO

THORACIC STENT-GRAFT SYSTEM

Bare Stent and Non-Bare Stent Configuration
INSTRUCTIONS FOR USE
(IFU)

 **TERUMO**
Aortic

Table of Contents

1. RELAY[®]PRO THORACIC STENT-GRAFT SYSTEM DEVICE DESCRIPTION	6
1.1. STENT-GRAFT.....	6
1.2. DELIVERY SYSTEM	7
2. INDICATIONS FOR USE	9
3. CONTRAINDICATIONS OF USE FOR THE RELAYPRO SYSTEM.....	9
4. WARNINGS AND PRECAUTIONS.....	9
4.1. GENERAL.....	9
4.2. PATIENT SELECTION.....	9
4.3. PRIOR TO IMPLANT PROCEDURE.....	11
4.4. DURING THE IMPLANT PROCEDURE.....	11
4.5. TREATMENT AND FOLLOW UP	13
4.6. MAGNETIC RESONANCE IMAGING (MRI) SAFETY INFORMATION	14
5. ADVERSE EVENTS	14
5.1. POTENTIAL ADVERSE EVENTS	14
5.2. ADVERSE EVENT REPORTING	15
6. SUMMARY OF ANEURYSM CLINICAL STUDY.....	15
6.1. INTRODUCTION	15
6.2. ENDPOINTS.....	16
6.2.1. <i>Primary Endpoints.....</i>	<i>16</i>
6.2.2. <i>Sample Size</i>	<i>17</i>
6.2.3. <i>Secondary Endpoints</i>	<i>17</i>
6.3. SUBJECTS	18
6.4. PRO-A STUDY RESULTS.....	19
6.4.1. <i>Subject Accountability and Follow-Up.....</i>	<i>19</i>
6.4.2. <i>Subject Demographics.....</i>	<i>20</i>
6.4.3. <i>Baseline Medical History.....</i>	<i>21</i>
6.4.4. <i>Baseline Aneurysm Characteristics</i>	<i>22</i>
6.4.5. <i>RelayPro Stent-Grafts Implanted</i>	<i>25</i>
6.4.6. <i>Acute Procedural Information</i>	<i>27</i>
6.4.7. <i>Safety Results.....</i>	<i>28</i>
6.4.8. <i>Device-Related Adverse Events</i>	<i>34</i>
6.4.9. <i>Procedure-Related Adverse Events.....</i>	<i>34</i>
6.4.10. <i>Effectiveness Results.....</i>	<i>35</i>
6.4.11. <i>Technical Success</i>	<i>39</i>
6.4.12. <i>Device Assessment at Index Procedure</i>	<i>39</i>
6.4.13. <i>Aneurysm Rupture.....</i>	<i>41</i>
6.4.14. <i>Migration</i>	<i>41</i>
6.4.15. <i>Endoleaks.....</i>	<i>41</i>
6.4.16. <i>Aneurysm Size Change</i>	<i>42</i>
6.4.17. <i>Stent-Graft Integrity.....</i>	<i>43</i>
6.4.18. <i>Stent-Graft Patency-Related Events</i>	<i>43</i>
6.4.19. <i>Conversion to Open Surgery</i>	<i>43</i>
6.4.20. <i>Secondary Interventions.....</i>	<i>43</i>

Table of Contents

6.4.21. Thromboembolic Events	44
6.4.22. Vascular access complications at the index procedure	44
6.5. SUB-GROUP ANALYSES	44
6.6. ADDITIONAL FOLLOW-UP DATA	45
7. SUMMARY OF TRAUMATIC AORTIC INJURY CLINICAL STUDY.....	46
7.1. INTRODUCTION	46
7.2. ENDPOINTS.....	46
7.2.1. Primary Endpoint	46
7.2.2. Sample Size	46
7.2.3. Secondary Endpoints	46
7.3. SUBJECTS	47
7.4. PRO-T STUDY RESULTS	48
7.4.1. Subject Accountability and Follow-up	48
7.4.2. Subject Demographics.....	50
7.4.3. Baseline Medical History.....	50
7.4.4. Baseline Vessel Measurements.....	51
7.4.5. RelayPro Stent-Grafts Implanted	54
7.4.6. Acute Procedural Information	55
7.4.7. Safety Results.....	56
7.4.8. Effectiveness Results.....	59
7.5. SUB-GROUP ANALYSIS	64
7.6. ADDITIONAL FOLLOW-UP DATA	64
8. SUMMARY OF DISSECTION CLINICAL STUDY	65
8.1. INTRODUCTION	65
8.2. ENDPOINTS.....	65
8.2.1. Primary Endpoint	65
8.2.2. Sample Size	65
8.2.3. Secondary Endpoints	65
8.3. SUBJECTS	66
8.4. PRO-D STUDY RESULTS.....	68
8.4.1. Subject Accountability and Follow-up	68
8.4.2. Subject Demographics.....	69
8.4.3. Baseline Medical History.....	69
8.4.4. Baseline Vessel Measurements.....	70
8.4.5. RelayPro Devices Implanted	73
8.4.6. Procedural Data	74
8.4.7. Safety Results.....	75
8.4.8. Effectiveness Results.....	82
8.5. SUB-GROUP ANALYSIS	93
8.6. ADDITIONAL FOLLOW-UP DATA	94
9. PATIENT SELECTION AND TREATMENT	94
9.1. PATIENT SELECTION.....	94
9.2. RELAYPRO STENT-GRAFT SIZING.....	95
10. PATIENT COUNSELING INFORMATION.....	99

Table of Contents

11. HOW PRODUCT IS SUPPLIED:	99
11.1. PACKAGE CONTENTS.....	99
11.2. STERILIZATION, STORAGE AND HANDLING	99
12. CLINICAL USE INFORMATION.....	99
12.1. PHYSICIAN TRAINING REQUIREMENTS.....	99
12.2. CASE PRE-PLANNING AND INDIVIDUALIZATION OF TREATMENT	100
12.3. DEVICE INSPECTION PRIOR TO USE.....	100
12.4. DEVICES, SUPPLIES AND EQUIPMENT REQUIRED.....	100
12.5. SUPPORTIVE/SUPPLEMENTARY EQUIPMENT	101
12.6. MAGNETIC RESONANCE (MR) IMAGING SAFETY INFORMATION	101
13. DIRECTIONS FOR USE	101
13.1. PATIENT AND DEVICE PREPARATION: (STEPS 1 THROUGH 10).....	101
13.2. INTRODUCTION/ADVANCEMENT OF THE OUTER SHEATH (STEPS 11 THROUGH 12).....	103
13.3. ADVANCEMENT OF THE INNER SHEATH (STEPS 13 THROUGH 18).....	103
13.4. STENT-GRAFT DEPLOYMENT (STEPS 19 THROUGH 23).....	105
13.5. SYSTEM REMOVAL (STEPS 24 THROUGH 30).....	106
14. BAIL OUT TECHNIQUE	107
15. FOLLOW-UP PROCEDURE	108
15.1. GENERAL.....	108
15.2. X-RAY	108
15.3. CT WITH CONTRAST	108
15.4. NON-CONTRAST CT	109
15.5. TRANSESOPHAGEAL ECHOCARDIOGRAPHY.....	109
15.6. MRI OR MRA.....	109
15.7. SUPPLEMENTAL IMAGING	109
16. ADDITIONAL SURVEILLANCE AND TREATMENT.....	109
17. DEVICE TRACKING INFORMATION	109
18. DISCLAIMER OF WARRANTY.....	110
19. PATENTS	110
20. DEFINITIONS	110

List of Figures

Figure 1: RelayPro Thoracic Stent-Graft (Bare and NBS Configurations).....	6
Figure 2. RelayPro Delivery System.....	8
Figure 3. Kaplan-Meier Freedom from Major Adverse Event	30
Figure 4. Kaplan-Meier Freedom from All-Cause Mortality.....	32
Figure 5. Kaplan-Meier Freedom from Standard Aneurysm-Related Mortality (Pro-A Lesion-Related Mortality): Pivotal Study.....	33
Figure 6: Pro-D Kaplan-Meier Freedom from All-Cause Mortality.....	77
Figure 7: Pro-D Kaplan-Meier Freedom from Dissection-Related Mortality	78
Figure 8: Pro-D Kaplan-Meier Freedom from Major Adverse Events (MAEs)	79

Figure 9. Inner Radius of Curvature.....	95
Figure 10. Marker Band Placement in Overlap Configuration.....	98
Figure 11. Guidewire lumen flush port.....	103
Figure 12. Actuating the device using mechanical advantage.....	104
Figure 13. Disengagement button.....	104
Figure 14. Device rotation while holding nose cap.....	105
Figure 15. Turn controller to Position 2.....	105
Figure 16. Clasp release.....	106
Figure 17. Turn controller to Position 4.....	106
Figure 18. Retraction of stainless steel rod.....	106
Figure 19. Turn controller to Position 2.....	107
Figure 20. Identification of Slot in Delivery System.....	108

List of Tables

Table 1. RelayPro Stent-Graft Materials.....	7
Table 2. Potential Adverse Events.....	14
Table 3. Summary of Compliance and Core Lab Imaging Follow-Up.....	19
Table 4. Summary of Subject Demographics.....	20
Table 5. Summary of Subject Comorbidities.....	21
Table 6. Core Laboratory – Reported Baseline CT Measurements.....	22
Table 7. Number of RelayPro Devices Implanted During the Initial Procedure.....	25
Table 8. Diameters of RelayPro Devices Implanted During the Initial Procedure.....	26
Table 9. Details of the Initial Procedure.....	27
Table 10. 30-Day Major Adverse Events: Pivotal Study.....	28
Table 11. Summary of MAEs Reported at Follow-Up.....	30
Table 12. Summary of CEC Adjudicated Device-Related Adverse Events.....	34
Table 13. Summary of CEC Adjudicated Procedure-Related Adverse Events.....	34
Table 14. Successful Aneurysm Treatment at 12 Months.....	36
Table 15. Individual Components of the Composite Primary Effectiveness Endpoint at 12 Months.....	37
Table 16. Secondary effectiveness endpoints.....	38
Table 17. Summary of Device Assessment by the Investigator.....	40
Table 18. Summary of Core Laboratory-Reported Endoleaks.....	41
Table 19. Summary of Core Laboratory Assessed Changes in Aneurysm Sac Diameter: Pivotal Study.....	43
Table 20. Summary of Reasons for Secondary Intervention.....	43
Table 21. Summary of Compliance and Core Lab Imaging Follow-Up (Pro-T).....	48
Table 22: Pro-T Subject Demographics.....	50
Table 23: Pro-T Subject Comorbidities.....	50
Table 24: Baseline Lesion Characteristics (Pro-T).....	52
Table 25: Pro-T Devices Implanted (Initial Procedure).....	54
Table 26: Diameter of RelayPro Devices Implanted (Pro-T).....	54
Table 27: Procedural Details (Pro-T).....	55
Table 28: Primary Endpoint Analysis (Pro-T).....	56

Table 29: Mortality (Pro-T)	57
Table 30: Summary of MAEs (CEC adjudicated) (Pro-T)	57
Table 31: Summary of CEC Adjudicated Device-Related Adverse Events (Pro-T)	58
Table 32: Summary of CEC Adjudicated Procedure-Related Adverse Events (Pro-T)	59
Table 33: Summary of Secondary Effectiveness Endpoints (Pro-T)	59
Table 34: Summary of Technical Success (Pro-T)	60
Table 35: Reasons for Secondary Intervention (Pro-T)	61
Table 36: Summary of Core Laboratory Reported Endoleaks (Pro-T)	62
Table 37: Device Performance (Core Laboratory Reported) (Pro-T)	64
Table 38: Summary of Pro-D Compliance & Core Laboratory Imaging Follow-up	68
Table 39: Pro-D Subject Demographics	69
Table 40: Pro-D Subject Comorbidities	69
Table 41: Core Laboratory-Reported Baseline CT Measurements (Pro-D)	70
Table 42: Pro-D Devices Implanted (Initial Procedure)	73
Table 43: Diameter of RelayPro Devices Implanted (Pro-D)	73
Table 44: Pro-D Procedural Details	74
Table 45: Pro-D Primary Endpoint Analysis	75
Table 46: Pro-D Primary Endpoint Supplemental Analysis	76
Table 47: Pro-D Mortality	76
Table 48: Pro-D Summary of MAEs (CEC adjudicated)	80
Table 49: Pro-D Summary of CEC Adjudicated Device-Related Adverse Events	81
Table 50: Pro-D Summary of CEC Adjudicated Procedure-Related Adverse Events	82
Table 51: Pro-D Summary of Endpoints	83
Table 52: Pro-D Summary of Technical Success and Procedure-Related Information (Site Reported)	85
Table 53: Pro-D Treatment Success at 30-Days	86
Table 54: Dissection Treatment Success by Timepoint	87
Table 55: Pro-D Core Laboratory Assessed Stent-Graft Migration	88
Table 56: Pro-D Changes in Aortic Diameter (Core Laboratory)	89
Table 57: Pro-D Device or Lesion-Related Secondary Endpoint Events by Follow-up Visit	90
Table 58: Pro-D Reasons for CEC Adjudicated Secondary Intervention	92
Table 59. TARGET LANDING ZONE – <i>BARE STENT CONFIGURATION</i>	96
Table 60. TARGET LANDING ZONE – <i>NON-BARE STENT CONFIGURATION</i>	96
Table 61. STRAIGHT STENT-GRAFTS - <i>BARE STENT CONFIGURATION</i>	96
Table 62. 4 MM TAPERED STENT-GRAFTS* - <i>BARE STENT CONFIGURATION</i>	97
Table 63. STRAIGHT STENT-GRAFTS - <i>NON-BARE STENT CONFIGURATION</i>	97
Table 64. 4 MM TAPERED STENT-GRAFTS* - <i>NON-BARE STENT CONFIGURATION</i>	98
Table 65. Product Designation	99

1. RELAY®PRO THORACIC STENT-GRAFT SYSTEM DEVICE DESCRIPTION

The **Relay®Pro THORACIC STENT-GRAFT SYSTEM (RelayPro)** is an endovascular device intended to treat isolated lesions of the descending thoracic aorta. The stent-graft is preloaded into its own delivery system that is advanced under fluoroscopy to the location of the aneurysm. The stent-graft is deployed at the intended location and creates a flow path for blood, excluding the lesion from blood pressure and flow.

The **RelayPro Stent-Graft** is available in two proximal configurations: the **proximal bare stent** and **non-bare stent (NBS)**. A description of both proximal configurations is provided below.

1.1. STENT-GRAFT

The **RelayPro Stent-Graft** is constructed of a series of sinusoidal self-expanding Nitinol stents sewn to a tubular woven polyester fabric. These stents are spaced along the entire length of the graft fabric to provide radial support and allow for the self-expansion of the stent-graft. A spiraled (“S” shaped) Nitinol strut, called the **Spiral Support Strut**, is sewn to the proximal section of the graft fabric to provide longitudinal support. The stents and the **Spiral Support Strut** are sewn to the graft fabric with surgical suture. Radiopaque markers are placed on the stent-graft to aid visualization and accurate placement (**Figure 1**). These radiopaque markers are made of platinum iridium alloy and indicate the fabric proximal and distal edges as well as the position of the **Spiral Support Strut**.

The **bare stent configuration** includes a proximal bare stent that is mainly uncovered. The proximal bare stent is intended to facilitate the alignment of the proximal end of the stent-graft within the aortic lumen. The height of the bare stent varies depending on the graft diameter to optimize the alignment of the stent-graft. The distal end of the stent-graft consists of a stent fully covered with the graft fabric.

The **non-bare stent configuration (NBS)** is similar in design to the bare stent configuration with a few exceptions. Rather than a proximal bare stent, the NBS most proximal stent, called the **crown stent**, is fully covered with the graft fabric. The crown stent is designed to provide circumferential support to the proximal edge of the graft fabric. The midsection and distal end of the NBS stent-graft is the same as the bare stent configuration. If the lesion requires use of an extension, **only** a RelayPro NBS configuration may be used.

The **RelayPro Stent-Grafts** are available in diameters ranging from 22–46 mm and covered lengths from 90–259 mm. The implants are also available in straight and tapered size offerings. Refer to **Table 61**, **Table 62**, **Table 63** and **Table 64** for stent-graft diameters.

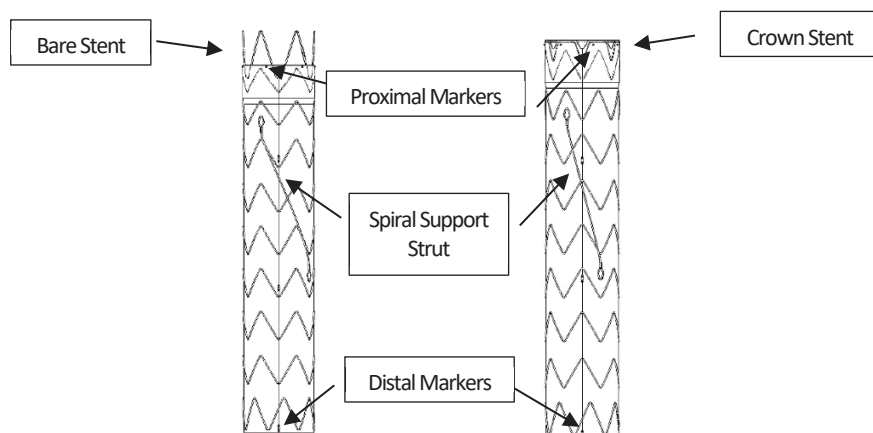

Figure 1: RelayPro Thoracic Stent-Graft (Bare and NBS Configurations)

The **RelayPro Stent-Graft** does not contain any natural rubber latex; however, during the manufacturing process, it may have incidental contact with latex. **Table 1** provides a summary of the materials of the **RelayPro Stent-Grafts**.

Table 1. RelayPro Stent-Graft Materials	
Implant Component	Material
Stent	Nitinol
Spiral Support Strut	Nitinol
Graft	Woven Polyester
Sutures	Braided Polyester
Radiopaque Markers	Platinum (90%) – Iridium (10%)

1.2. DELIVERY SYSTEM

The delivery system consists of a series of coaxially-arranged sheaths and catheters attached to a handle body assembly. The delivery system introducer (outer) sheath diameter ranges from 19Fr to 22Fr (**bare stent configuration**) or 23Fr (**NBS configuration**) depending on the stent-graft diameter. The outer sheath and the delivery system tip have a hydrophilic coating. Also, the tip of the outer sheath and the delivery system tip are radiopaque for visibility under fluoroscopy. The delivery system has a working length of 90cm and is designed to track over a 0.035" (0.89 mm) guidewire.

The delivery system uses a combination of two sheaths to deliver the stent-graft to the treatment site. The first sheath, also called the outer sheath, is used to track through the access vessel and is advanced to the distal portion of the treatment site. The second sheath, also called the inner sheath, is made of fabric and has a diameter larger than the outer sheath. The stent-graft is loaded in the inner sheath and the inner sheath with the stent-graft are loaded inside the outer sheath. Once the outer sheath is positioned distal to the treatment site the inner fabric sheath with the stent-graft are advanced to the proximal landing zone. The outer sheath remains stationary while the inner sheath is advanced to the proximal landing zone and during the deployment process. The implant is deployed by pulling back on the inner sheath.

The **RelayPro** delivery system (**Figure 2**) offers a mechanical advantage to aid with the advancement and retraction of the inner sheath. The mechanical advantage can be bypassed and re-engaged anytime during use. The delivery system operates by turning the deployment grip when using the mechanical advantage or by pushing or pulling the deployment grip when the mechanical advantage is disengaged.

The delivery systems used for the **RelayPro bare stent** and **NBS configurations** are functionally and operationally equivalent. There are minor differences to accommodate the NBS configuration which do not change the mode of operation. The two Nitinol wires, called support wires, control the expansion of the inferior portion of the stent-graft. The support wires are attached to the delivery system catheter at one end. The other end of the support wires are atraumatic teardrop-shaped and are tethered to the inferior portion of the graft with loops of suture. The support wires control the expansion of the proximal end of the stent-graft to ensure proper apposition against the anatomical inner curvature and are for NBS graft diameters 32mm to 46mm only. In addition, the design of Item 2 in **Figure 2** (apex holder) differs slightly between the configurations.

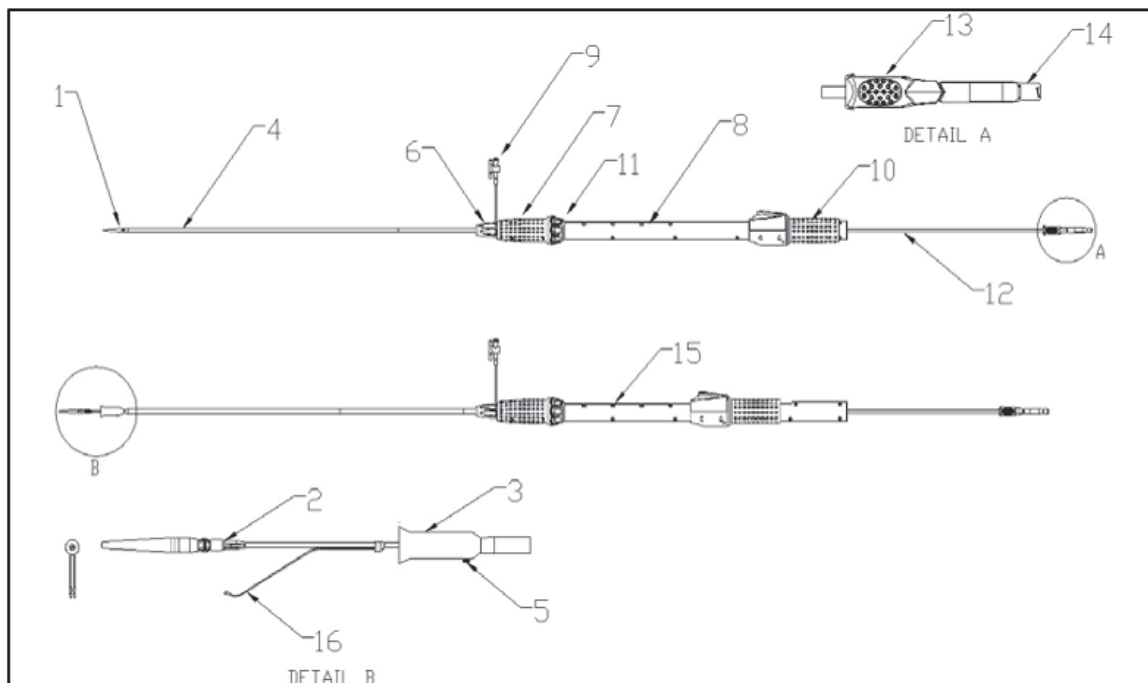

- | | |
|------------------------|--|
| 1. Delivery System Tip | 9. Flush Port |
| 2. Apex Holder | 10. Deployment Grip |
| 3. Inner Sheath | 11. Controller |
| 4. Outer Sheath | 12. Stainless Steel Rod |
| 5. Radiopaque Marker | 13. Apex Holder Knob |
| 6. Front Nose Cap | 14. Guidewire Luer |
| 7. Gray Grip | 15. Arrow Marker |
| 8. Handle Body | 16. Support Wire (Non-Bare Stent only) |

Figure 2. RelayPro Delivery System

2. INDICATIONS FOR USE

The **RelayPro THORACIC STENT-GRAFT SYSTEM** is indicated for the endovascular repair of all lesions of the descending thoracic aorta in patients having appropriate anatomy, including:

- Iliac or femoral access vessel morphology that is compatible with vascular access techniques, devices, and/or accessories;
- Non-aneurysmal aortic diameter in the range of:
 - 20–42 mm for fusiform aneurysms and saccular aneurysms/penetrating atherosclerotic ulcers and dissections
 - 19–42 mm for traumatic aortic injuries;
- Proximal landing zone (non-aneurysmal proximal aortic neck lengths for fusiform aneurysms and saccular aneurysms/penetrating atherosclerotic ulcers or non-dissected length of aorta proximal to the primary entry tear for dissections and length of aorta proximal to the tear for traumatic aortic injuries) of:
 - 15 mm for the 22–28 mm device diameters (**Bare Stent Configuration**)
 - 20 mm for the 30–38 mm device diameters (**Bare Stent Configuration**)
 - 25 mm for the 40–46 mm device diameters (**Bare Stent Configuration**)
 - 25 mm for the 22–38 mm device diameters (**Non-Bare Stent Configuration**)
 - 30 mm for the 40–46 mm device diameters (**Non-Bare Stent Configuration**)
- Non-aneurysmal distal aortic neck lengths for fusiform aneurysms and saccular aneurysms/penetrating atherosclerotic ulcers of:
 - 25 mm for the 24–38 mm device diameters
 - 30 mm for the 40–46 mm device diameters
- Non-aneurysmal distal landing zone of 20 mm for traumatic aortic injuries (22 mm–46 mm device diameters) and dissections (24 mm–46 mm device diameters)

The RelayPro Thoracic Stent-Graft System (NBS configuration) is indicated for the endovascular distal extension of the Thoraflex Hybrid device.

3. CONTRAINDICATIONS OF USE FOR THE RELAYPRO SYSTEM

The **RelayPro THORACIC STENT-GRAFT SYSTEM** is contraindicated for the following:

- Patients with a known allergy or intolerance to device materials (Nitinol, polyester, platinum-iridium); also listed in **Table 1 (Section 1.1)**
- Patients with a condition that threatens to infect the graft

4. WARNINGS AND PRECAUTIONS

Caution: Read all instructions carefully. Failure to properly follow the instructions, warnings, and precautions may lead to serious consequences or injury to the patient.

4.1. GENERAL

- The use of **RelayPro** requires that physicians be specially trained in endovascular thoracic aortic repair techniques, including experience with high resolution fluoroscopy and radiation safety. Terumo Aortic will provide training specific to the **RelayPro** system. Specific physician training requirements are provided in **Section 12.1**.
- A team trained in vascular surgery should be available while the implant procedure is in progress in case conversion to open surgery is required.

4.2. PATIENT SELECTION

- In the pivotal study for the endovascular repair of traumatic aortic injuries, stent-graft thrombosis and embolism has been reported in patients treated for traumatic aortic injuries. Please see **Section 7.4.8.7** for additional information

on these cases.

- Inappropriate patient selection may result in poor device performance or device performance not otherwise in accordance with the specifications.
- Key anatomic criteria that may affect successful exclusion of the aneurysm includes a proximal landing zone with an inner radius of curvature less than 15mm and insufficient proximal and distal landing zones (**Section 9.2**). The treatment site should be within the working length of the delivery system (90cm).
- Proximal and distal landing zones need to be considered. They are specified in Table 59 and **Table 60**.
- There is an increased risk of graft lumen thrombosis associated with excessive oversizing when repairing traumatic aortic injuries. Refer to device selection criteria defined in **Section 9.2**.
- **RelayPro** should not be used in patients unable, or who will not be compliant with, the requirement to undergo preoperative and postoperative imaging required as part of endovascular repair.
- **RelayPro** is not recommended in patients exceeding weight or size limits necessary to meet imaging requirements.
- Care should be taken when treating morbidly obese patients as device visualization may be compromised.
- Excessive arterial tortuosity and/or disease may result in not being able to reach the treatment site or result in the stent-graft kinking.
- Arterial tortuosity and/or excessive arterial disease may preclude delivery system entrance or passage and result in not being able to reach the treatment site.
- Significant or circumferential calcification or mural thrombus in the landing zones may adversely impact sealing.
- Iliac conduits may be used to ensure the safe insertion of the delivery system into the patient's access vessels, if determined necessary by the treating physician.
- Endovascular treatment of lesions in the descending thoracic aorta requires lifelong, regular follow-up to assess patient's health as well as the performance of the implanted endovascular stent-graft. Patients with specific clinical findings, e.g., endoleaks, enlarging aneurysms, enlarging false lumens, or changes in the structure or position of the endovascular graft should receive enhanced follow-up as described in **Section 15**.
- **RelayPro** is not recommended in patients who cannot tolerate contrast agents necessary for intraoperative and postoperative follow-up imaging.
- Careful consideration should be given to treating patients with pre-existing aortic endoprostheses.
- Practitioner must ensure that the access vessel diameter is compatible with the selected delivery system's outer sheath French size and that the aortic inner diameter that can accommodate the expanded inner sheath outer diameter of approximately 10 mm.

The **RelayPro THORACIC STENT-GRAFT SYSTEM** has not been evaluated in patients who:

- are less than 18 years old
- are pregnant
- have a ruptured aneurysm in the thoracic aorta
- have false aneurysms and diffuse intramural hematomas
- have chronic Type B dissections
- have acute, uncomplicated Type B dissections
- have had a stroke and/or myocardial infarction within 3 months of the planned treatment date
- have coronary artery disease with unstable angina
- have severe congestive heart failure (New York Heart Association functional class IV)
- have anatomic variants which may compromise circulation to the carotid, vertebral or innominate arteries after device placements, and are not amenable to subclavian revascularization
- have a lesion that cannot be crossed by a guide wire
- have an active systemic infection or is suspected of having an active systemic infection (e.g., AIDS/HIV, sepsis)
- are morbidly obese (more than 100% over the ideal body weight or as defined by institutional standards) or have other clinical conditions that severely compromise or impair x-ray visualization of the aorta
- have connective tissue disease (e.g., Marfan's syndrome)
- have a mycotic aneurysm
- have significant or circumferential calcification or mural thrombus in the landing zones

- have significant or circumferential calcification or mural thrombus within the treatment length, which may adversely impact device patency
- have a blood coagulation disorder or bleeding diathesis, the treatment for which cannot be suspended pre- and post-repair
- have a creatinine > 2.5 mg/dL
- have had a prior TAA repair (endovascular or open surgical) in the descending thoracic aorta (this excludes patients that have had prior repair with the Thoraflex Hybrid device)
- would require placement of the RelayPro within a prior endovascular graft or surgical graft placed during a previous procedure, with the exception of the Thoraflex Hybrid device
- have concomitant aneurysm/disease of the abdominal aorta requiring repair
- have had prior abdominal aortic aneurysm repair (endovascular or surgical) that was performed less than 6 months prior to the planned stent implant procedure
- have an untreatable allergy or sensitivity to contrast media, Nitinol/nickel, or polyester

4.3. PRIOR TO IMPLANT PROCEDURE

- Preoperative planning for access and placement should be completed prior to opening device packaging.
- Before use, carefully inspect all packaging for damage or defects. If the product or package has been damaged or the sterility of the contents is compromised, do not use the device. The product is provided double-pouched. If the outer pouch is opened, damaged, or missing, the product should not be used. Always handle devices with care. If necessary, you may work with your Endovascular Consultant to return an unused package and device to Terumo Aortic.
- For single use only. Do not re-sterilize or re-use. The re-use, reprocessing or re-sterilization of any **RelayPro** system may compromise the structural integrity of the device and/or lead to device failures, which in turn may lead to injury, illness or death of the patient. Reuse, reprocessing, or re-sterilization may also create a risk of contamination of the device and/or cause patient infection or cross-infection, including, but not limited to, the transmission of infectious disease(s) from one patient to another. Contamination of the device may lead to injury, illness, or death. Also, each single-use device carries specific labeling instructions relative to storage, use, and handling to minimize exposure to conditions that could compromise the product, the patient, or the user. These conditions cannot be assured once the packaging is opened and discarded.
- Note product “Use By” date and do not use if the date has been exceeded.
- Minimize handling of the device during preparation and insertion to decrease the risk of device contamination or infection.
- Modifications to the device have not been evaluated through benchtop testing or the clinical studies.

4.4. DURING THE IMPLANT PROCEDURE

- Exercise care during handling and delivery to help prevent vessel rupture.
- Anticoagulation and antiplatelet therapies are used at the discretion of the physician. If heparin is contraindicated, an alternative anticoagulant should be considered.
- Excessive use of contrast agents or emboli may result in renal complications.
- Ensure that the delivery system handle body and outer sheath are parallel with the patient’s leg. Excessive angulation where the handle body meets the outer sheath may impair the functionality of the device.
- Stent-graft components cannot be re-sheathed or drawn back into the delivery system without compromising the system, even if the prosthesis component is only partially deployed.
- If the inner sheath is accidentally withdrawn exposing the stent-graft, the device will prematurely deploy and may be incorrectly positioned.

- Failure to position the stent-graft within healthy tissue (non-aneurysmal and without evidence of circumferential thrombus, intramural hematoma, dissection or ulceration) may result in stent-graft leaks or vessel damage, including perforation. Ensure that the **RelayPro** devices are placed in a landing zone consisting of healthy tissue. Healthy tissue is non-aneurysmal and is without evidence of circumferential thrombus, intramural hematoma, dissection, or ulceration. Failure to place the stent-graft in healthy tissue could lead to inadequate exclusion or vessel damage, including perforation. When treating Type B dissections, the proximal extent of the intended proximal landing zone must not be dissected. Landing the proximal end of the device in dissected tissue could increase the risk of damage to the septum and could lead to new septal tears, aortic rupture, retrograde dissection, or other complications. When treating dissections, inadvertent pressurization of the false lumen may result in retrograde dissection.
- Always use fluoroscopy to visually confirm that the stent-graft's distal marker bands can be seen approximately 2 cm outside of the outer sheath. This ensures the inner sheath has completely exited from the outer sheath. Retraction of the inner sheath prior to fully exiting the outer sheath could lead to incomplete deployment of the stent-graft.
- Always use fluoroscopy to verify the stent-graft is completely released from the delivery system. Incomplete retraction of the inner sheath or incomplete retraction of the clasp release mechanism could lead to dislodgement of the prosthesis when the delivery system is removed from the patient.
- Deploying the device in a portion of the aorta with a different diameter than planned when selecting the graft size may potentially result in inadequate sizing and therefore migration, endoleak, aneurysm growth, or increased risk of thrombosis.
- An inadequate seal zone may result in increased risk of leakage into the lesion or migration of the stent-graft.
- Stent-graft migration or incorrect prosthesis deployment may require surgical intervention.
- Care should be taken to not block critical arteries during device deployment, with the exception of planned coverage of critical arteries. Placement of stent-grafts in the aortic arch often requires proximity to the left subclavian or left common carotid arteries. The distal landing area of the stent-graft may be close to the celiac artery. The proximal end of the covered **RelayPro** stent-graft should not be placed beyond the origin of the left common carotid artery.
- If occlusion of the left subclavian artery ostium is required to obtain adequate neck length for fixation and sealing, transposition or bypass of the left subclavian artery may be warranted.
- Care should be taken with respect to occlusion of intercostals/spinal cord arteries.
- Coverage of the left subclavian artery (LSA) and the need for LSA revascularization is at the discretion of the physician, based upon the patient's vascular anatomy, for example, maintenance of perfusion of an anomalous left vertebral artery arising from the aortic arch or a LIMA coronary bypass graft.
- When treating dissections, ensure the distal end of the device is in a straight portion of the aorta in order to reduce risk of septum damage.
- Consider adjunctive procedures to restore blood flow to malperfused branch vessels. Additional procedures during treatment in the Terumo Aortic Dissection clinical study included, but were not limited to stenting and surgical bypass.
- Do not cross significant arterial branches which do not have collateral or protected perfusion to end organs or body structures. Vessel occlusion may occur.
- Exercise particular care in areas that are difficult to navigate, such as areas of stenosis, intravascular thrombus, calcification or tortuosity, or where excessive resistance is experienced, as vessel or catheter damage could occur. Consider performing balloon angioplasty at the site of a narrowed or stenotic vessel, and then attempt to gently reintroduce the catheter delivery system. Also exercise care with device selection and correct placement/positioning of the device in the presence of anatomically challenging situations such as areas of significant stenosis, intravascular thrombus, calcification, tortuosity and/or angulation which can affect successful initial treatment.
- High pressure injections of contrast media made at the edges of the stent-graft immediately after implantation can cause endoleaks.
- If balloon modeling is desired, use a compliant balloon such as the Terumo Aortic Balloon. Balloon inflation should not exceed 1 atm. Inflate the balloon inside the covered portion of the stent-graft. Failure to do so could lead to aortic rupture, atherosclerotic plaque embolization or other complications. Over inflation of a semi or non-compliant balloon can cause graft tears and/or vessel dissection or rupture. Care should be taken when ballooning in patients with a history of aortic dissection. Ballooning might be necessary such as to treat an endoleak. Over inflation of the balloon in dissection patients could lead to aortic damage including retrograde dissection and damage to the septum.

- When expanding the stent-graft, there is an increased risk of vessel injury and/or rupture, and possible patient death, if the compliant balloon's proximal and distal radiopaque markers are not completely within the covered (graft fabric) portion of the prosthesis. Ballooning outside the covered portion could cause aortic rupture, atherosclerotic plaque embolization, or other complications.
- **Bare Stent Configuration:** Do not balloon expand the bare proximal stent of the stent-graft as expansion of the bare proximal stent may cause vessel injury or rupture and the balloon could snag on the bare proximal stent.
- Be careful not to displace the stent-grafts upon introducing and retracting the compliant balloon catheter.
- Balloon modeling is not required; however, if it is deemed necessary, excessive arterial blood pressure may lead to dislodging the stent-graft from its intended location.
- Always recheck position of stent-graft following ballooning.
- Care should be taken when inflating the compliant balloon, especially with calcified, tortuous, stenotic, or otherwise diseased vessels.
- Inflate the compliant balloon slowly. It is recommended that a backup compliant balloon be available.
- Do not use power/pressure injections through the delivery systems.
- Placement of stent-graft in the thoracic aorta often requires proximity to the great vessels perfusing the brain, increasing the possibility of thrombus or embolization proximally. Care should be taken to ensure air has been purged from the system.
- Do not bend or kink the delivery system as it may cause damage to not only the delivery system but also the **RelayPro** stent-graft.
- Stop advancing the guidewire or delivery system if resistance is encountered. Assess the source of the resistance before proceeding to avoid vessel or catheter damage.
- Wire fractures are more likely to occur in conditions with an excessively oversized stent-graft, flexion, kinking, or bending during cardiac or respiratory cycles. Fractures of the Spiral Support Strut are more likely to occur if the strut is deployed along the inner radius of curvature. Wire fractures may have clinical consequences including endoleak, migration, or tissue damage.
- Endoleaks detected at the conclusion of the procedure and not corrected should be carefully monitored after implantation.
- Do not attempt to reposition the **RelayPro** stent-graft once it has opposed the vessel wall. Inadvertent partial deployment or migration of the **RelayPro** stent-graft may require surgical removal.
- Inaccurate placement and/or incomplete sealing of the **RelayPro** stent-graft within the vessel may result in increased risk of endoleak, migration, or inadvertent occlusion of the left subclavian, left common carotid, and/or celiac arteries. Surgical intervention may be required.

4.5. TREATMENT AND FOLLOW UP

- The long-term performance of **RelayPro** has not yet been established.
- Any endoleak left untreated during the implantation procedure must be carefully monitored after implantation.
- All patients should undergo periodic imaging (at least annually) to evaluate the stent-graft, aneurysm size, and occlusion of vessels in the treatment area. Significant aortic dilation/aneurysm enlargement (>5 mm), the appearance of a new endoleak, evidence of perigraft flow, thrombosis, or stent-graft migration should prompt further investigation and may indicate the need for additional intervention.
- Patients experiencing reduced blood flow through the stent-graft or due to endoleaks may be required to undergo secondary interventions or surgical procedures.
- Additional treatment including endovascular treatment or surgical procedure should be strongly considered in the following cases:
 - Aortic dilation/aneurysm growth > 5 mm, with or without endoleak,
 - persistent Type I/III endoleak, with or without aneurysm growth,
 - persistent Type II endoleak with aneurysm growth/aortic dilation, and/or
 - stent-graft migration.
- Additional endovascular repair or open surgical aneurysm repair should be considered for patients with an increase

in TAA size of more than 5mm or evidence of sub-optimal fixation, proximal endoleak, distal endoleak, junction endoleak, or unknown origin of peri-graft flow, dissection extension or persistent false lumen perfusion. An increase in aortic size, persistent endoleak, or continued false lumen perfusion may lead to aortic rupture.

- When advancing the guidewires, catheters, and the **RelayPro** delivery system into the aorta, do not disturb the thrombus mass within the aneurysm. Doing so may dislodge emboli, which can cause embolization. If embolization should occur, use conventional treatment methods.
- Following thoracic endovascular aortic repair (TEVAR), spinal cord ischemia (SCI) may result in a rare complication of paraplegia or paraparesis. Cerebrospinal fluid (CSF) drainage is advised if spinal cord ischemia is suspected.
- More frequent imaging assessments should be considered for patients with risk factors for hypercoagulability. In the pivotal study, stent-graft thrombosis was reported by the Core Laboratory in a patient with hypercoagulability risk factors. Please see **Section 7.4.8.7** for additional information.

4.6. MAGNETIC RESONANCE IMAGING (MRI) SAFETY INFORMATION

Nonclinical testing has demonstrated that **RelayPro** is MR Conditional. It can be scanned safely in both 1.5T and 3.0T MR systems only, with the parameters specified in **Section 12.6**. Additional MRI safety information is also provided in **Section 12.6**.

5. ADVERSE EVENTS

5.1. POTENTIAL ADVERSE EVENTS

Adverse events that may occur in conjunction with endovascular procedures include, but are not limited to, those listed in the following section. For the specific adverse events that occurred in the clinical study, please see **Sections 6, 7 and 8**.

Table 2. Potential Adverse Events	
Access Failure	Infection / Sepsis
Allergic Reaction (to contrast, antiplatelet therapy, stent-graft materials)	Intercostal pain
Amputation	Intramural Hematoma
Anesthetic reactions/complications (e.g., aspiration)	Ischemia (spinal cord, perfusion pathways)
Aneurysm Sac Enlargement	Limb ischemia
Aneurysm / Lesion Rupture	Lymphocele
Angina	Neuropathy
Aortic vessel damage (perforation, dissection, bleeding, rupture)	Pain
Arteriovenous fistula / aorto-esophageal fistula	Paralysis/Paresthesia/Paraparesis/Paraplegia/Spinal Cord Shock
Blindness	Perforation
Blood Loss	Peripheral Nerve injury
Bowel complications (e.g., adynamic ileus, transient ischemia, infarction, obstruction, necrosis)	Persistent false lumen flow
Cardiac events (e.g., arrhythmia, tachyarrhythmia, cardiac tamponade, congestive heart failure, myocardial infarction, hypotension, hypertension, tachycardia, bradycardia)	Post Implantation Syndrome
Catheter Breakage	Post-procedural bleeding
Cerebral vascular accident (stroke)	Pseudoaneurysm
Change in mental status	Pulmonary complications
Claudication (e.g., buttock, lower limb)	Pulmonary embolism

Table 2. Potential Adverse Events	
Coagulopathy	Radiation overexposure or reaction
Compartment Syndrome	Reaction to anesthesia
Contrast toxicity / anaphylaxis	Reaction/pain at catheter insertion site
Conversion to Open Repair	Renal failure or complications
Death	Reoperation
Delivery system failure	Seizure
Deployment failure (partial or inaccurate deployment)	Seroma
Device Dehiscence	Shock
Device Insertion or Removal Difficulty	Stenosis of native vessel
Dissection extension	Stent fracture / break
Dysphagia	Stent-Graft failure (e.g., improper component placement, poor conformability of the graft to the vessel wall, graft material wear or tear, suture break, dilation, erosion, graft twisting or kinking, stent-graft thrombosis/occlusion, puncture, perigraft flow)
Edema	Stent-Graft Infection
Embolism (micro and macro) with transient or permanent ischemia or infarction	Stent-Graft Migration
Endoleak	Tissue Necrosis
Fever and localized inflammation	Transient Ischemic Attack
Fistulas	Unintentional Dissection Septum Rupture
Gastrointestinal complications	Vascular Spasm
Genitourinary complications (e.g., ischemia, erosion, femoral-femoral artery thrombosis, fistula, incontinence, hematuria, infection)	Vascular Trauma (perforation / dissection)
Hematoma (surgical)	Vessel Damage
Hemorrhage	Vessel Dissection
Hepatic failure	Vessel Occlusion/Thrombosis
Impotence	Wound complications (dehiscence, infection, hematoma, seroma, cellulitis)
Incision site complications	

5.2. ADVERSE EVENT REPORTING

Any adverse event or clinical incident involving the **RelayPro THORACIC STENT-GRAFT SYSTEM** in the United States should be immediately reported to Terumo Aortic using the email address qualityus@terumo-aortic.com.

6. SUMMARY OF ANEURYSM CLINICAL STUDY

6.1. INTRODUCTION

The primary objectives of the Pivotal Study were to evaluate the safety and effectiveness of the **RelayPro THORACIC STENT-GRAFT SYSTEM** in subjects with fusiform aneurysms and saccular aneurysms/penetrating atherosclerotic ulcers in the descending thoracic aorta (referred to as the Pro-A study). The study was a multi-center, prospective, single-arm, non-randomized, and non-blinded investigation. One hundred and ten (110) subjects were treated between May 10, 2017 and June 24, 2019 at 36 investigational sites

(25 in the United States and 11 in Japan). Subjects are being followed at 1 month, 6 months, 12-months, and annually thereafter for 5-years.

6.2. ENDPOINTS

6.2.1. Primary Endpoints

The primary safety endpoint is the composite major adverse event (MAE) rate, defined when any of the following occur within 30-days:

- Death
- Myocardial infarction
- Stroke, excluding transient ischemic attack (TIA)
- Renal failure
- Respiratory failure
- Paralysis, excluding paraparesis
- Bowel ischemia
- Procedural blood loss >1,000 cc

The primary safety endpoint was compared to a performance goal of 20%. The performance goal was based on the Pivotal Study results from the RelayPlus Pivotal Study (P110038).

The hypothesis tested for the primary safety endpoint at a one-sided alpha level of 0.05 was:

Null hypothesis (H_0): $p \geq 0.20$

Alternative Hypothesis (H_A): $p < 0.20$

where p is the proportion of RelayPro subjects with at least one major adverse event through 30-days post implant procedure and 20% was the performance goal for the endpoint.

The primary safety objective would be met if the upper limit of the 95% one-sided exact confidence interval of the 30-day primary safety endpoint rate is below 20%.

The primary effectiveness endpoint is successful aneurysm treatment 12 months post-implant, defined as a composite of the following:

- Technical success through 24 hours post-procedure, defined as:
 - Successful delivery of the device through the vasculature
 - Successful deployment of the device at the intended location
 - Absence of Type I or III endoleak
 - Patent stent-graft without significant stenosis (>50%)
- Stent-graft patency through 12 months;
- Absence of aneurysm rupture through 12 months;
- Absence of Type I or III endoleak at 12 months;
- Absence of stent fractures in the attachment zone through 12 months;
- Absence of open or endovascular secondary interventions related to the device or treated pathology through 12-months;
- Absence of aneurysm expansion (>5 mm diameter increase) through 12 months, compared to the first post-procedural computed tomographic (CT) imaging study;
- Absence of stent-graft migration (> 10 mm) through 12 months, compared to the first post-procedural CT.

The primary effectiveness endpoint will be compared to a performance goal of 80%. The performance goal was based on the Pivotal Study results from the RelayPlus Pivotal Study (P110038).

The hypotheses that will be tested for the primary effectiveness endpoint at a one-sided level of 0.05 is:

Null hypothesis (H_0): $p \leq 0.80$

Alternative Hypothesis (H_A): $p > 0.80$

where p is the proportion of RelayPro subjects with successful aneurysm treatment at 12-months post-procedure and 80% is the performance goal.

The primary effectiveness objective would be met if the lower limit of the 95% one-sided exact confidence interval of the 12-month primary effectiveness endpoint rate is above 80%.

6.2.2. Sample Size

The sample size for **RelayPro THORACIC STENT-GRAFT SYSTEM** Pivotal Study was driven by the primary effectiveness endpoint.

Primary Effectiveness Endpoint

Based on the same RelayPlus historical data, the estimated rate for the primary effectiveness endpoint is 92.1%. Using the Exact Binomial Test and assuming a power of 96%, a one-sided alpha of 0.05, and a performance goal of 80%, the sample size needed is 88 subjects. Assuming 20% attrition, the sample size needed is 110 subjects.

With the assumed attrition rate, a final sample size of 110 subjects satisfied the power requirements for both the primary safety and effectiveness endpoints.

6.2.3. Secondary Endpoints

Secondary endpoints include the following:

- Intervention-Free Technical Success defined as:
 - Successful delivery of the device through the vasculature (i.e., ability to deliver the implant to the intended location without the need for unanticipated corrective intervention related to delivery);
 - Successful and accurate deployment of the device defined as:
 - deployment of the endovascular stent-graft in the planned location;
 - patency of the endovascular stent-graft, absence of device deformations (e.g., kinks, stent eversion, maldeployment, misaligned deployment) requiring unplanned placement of an additional device within the endovascular stent-graft, and;
 - Successful withdrawal (i.e., successful withdrawal of the delivery system, without the need for unanticipated corrective intervention related to withdrawal)
- All-cause mortality and lesion-related mortality through 1-month, 6-months, 12-months and annual through 5 years;
- Loss of stent-graft patency through 1-month, 6-months, 12-months and annual through 5 years;
- Decreased stent-graft lumen diameter through 1-month, 6-months, 12-months and annual through 5 years);
- Aneurysm rupture through 1-month, 6-months, 12-months and annual through 5 years;
- All endoleaks, evaluated individually, at 1 month, 6-months, 12 months and annual through 5 years;
- Stent fractures through 1-month, 6-months, 12-months and annual through 5 years;
- Incidence of open or endovascular secondary interventions related to the device or treated pathology to treat a condition involving the study device and/or the aneurysm treated with the study device through 1-month, 6-months, 12-months and annual through 5 years;
- Aneurysm expansion (> 5 mm diameter increase) at 6-months, 12-months and annual through 5 years compared to the first post-procedural CT;
- Stent migration (> 10 mm) at 6-months, 12-months and annual through 5 years compared to the first post-procedural CT;
- Thromboembolic events attributed to the stent-graft through 1-month, 6-months, 12-months and annual through 5 years;
- Individual outcomes of the composite safety endpoints through 6-months, 12-months and annual through 5 years;
- All adverse events through 6-months and 12-months
- Device-related adverse events through 5 years;
- Vascular access complications at the index procedure;

- Clinical utility measures, including duration of procedure, transfusions required, length of hospital stay, and time in ICU.

6.3. SUBJECTS

Subjects enrolled in the Pivotal Study met the following criteria:

- Age ≥ 18 years.
- Subject has any of the following conditions in his/her descending thoracic aorta:
 - Aneurysm ≥ 5.0 cm in diameter;
 - Aneurysm ≥ 4.0 cm in diameter with an increase of ≥ 0.5 cm within the last 6 months or ≥ 1.0 cm over the last 12 months;
 - Aneurysm with maximum diameter exceeding two times the diameter of the non-aneurysmal, adjacent aorta;
 - Saccular aneurysm;
 - PAU within the DTA with a depth of 10 mm or more.
- Proximal and distal aortic neck with diameter between 20 mm and 42 mm.
- Proximal landing zone distal to the left common carotid and a distal landing zone proximal to the origin of the celiac artery; the lengths of which are dependent on the diameter and type of the device.
- Proximal and distal landing zones containing a straight segment (non-tapered, non-reverse-tapered, defined by $<10\%$ diameter change) with lengths equal to or greater than the required landing length for the intended device.
- Adequate iliac or femoral artery access for introduction of the RelayPro Delivery System. Alternative methods to gain proper access may be utilized (e.g., iliac conduit).
- Subject willing to comply with the follow-up evaluation schedule.
- Subject (or Legally Authorized Representative, LAR) agrees to sign an Informed Consent Form prior to treatment.

Subjects were excluded if they had any of the follow anatomic or physiologic characteristics:

- Acute or chronic aortic dissection within the ascending aorta, arch or descending thoracic aorta.
- Diffuse intramural hematoma (current or previous).
- Traumatic aortic injury or transection.
- Aortic false aneurysm.
- Ruptured aneurysm.
- Significant stenosis ($>50\%$), calcification, thrombus, or tortuosity of intended fixation sites that would compromise fixation or seal of the device.
- Anatomic variants which may compromise circulation to the carotid, vertebral, or innominate arteries after device placement, and are not amenable to subclavian revascularization.
- Prior endovascular or surgical repair in the descending thoracic aorta.
- The device could not be placed within any prior endovascular or surgical graft.
- Concomitant aneurysm/disease of the ascending aorta, aortic arch, or abdominal aorta requiring repair.
- Prior abdominal aortic aneurysm repair (endovascular or surgical) that was performed less than 6 months prior to the planned stent implant procedure.
- Major surgical or medical procedure within 45 days prior to the planned procedure, or major surgical or medical procedure within 45 days post implantation. This excluded any planned procedures for the prospective stent-graft placement.
- Untreatable allergy or sensitivity to contrast media or device components.
- Known or suspected connective tissue disorder.
- Blood coagulation disorder or bleeding diathesis for which the treatment cannot be suspended for one week pre- and/or post-repair.
- Coronary artery disease with unstable angina.
- Severe congestive heart failure (New York Heart Association functional class IV).
- Stroke and/or MI within 3 months of the planned treatment date.
- Pulmonary disease requiring the routine (daily or nightly) need for oxygen therapy outside the hospital setting.
- Acute renal failure or renal insufficiency with a creatinine ≥ 2.5 mg/dL, unless stable on dialysis.

- Active systemic infection and/or mycotic aneurysms.
- Morbid obesity or other condition that may compromise or prevent the necessary imaging requirements.
- Less than two-year life expectancy.
- Current or planned participation in an investigational drug or device study that has not completed primary endpoint evaluation.
- Currently pregnant or planning to become pregnant during the course of the study.
- Medical, social, or psychological issues that Investigator believes may interfere with treatment or follow-up.

All subjects enrolled in the Pivotal Study met the selection criteria based on site-reported imaging measurements.

6.4. PRO-A STUDY RESULTS

6.4.1. Subject Accountability and Follow-Up

Of 110 subjects enrolled in the PMA study, all 110 subjects were implanted with the RelayPro Stent-Graft System and seen through discharge. All but one subject (109/110, 99.1%) completed the 30-day visit (minimum of 96.4% with imaging adequate to assess endovascular graft parameters). Ninety-six subjects (of 108 eligible subjects) completed the 6-month visit with at least 83.3% of imaging adequate to assess endovascular grafts parameters.

At 12-months, 93 of the 105 eligible subjects (88.6%, 93/105) returned for the follow-up visit with at least 81% of imaging adequate to assess aneurysm diameter, endoleak, migration and fracture. At 2-years, 48 of the 91 eligible subjects returned for the follow-up visit with 38 subjects (41.8%, 38/91) still within the follow-up window. At 3-years, 4 subjects of the 19 eligible subjects have completed the follow-up visit. Compliance and imaging follow-up are provided in **Table 3** below.

Analysis Window	Subject Follow-Up				Imaging Performed ^d		Imaging Adequate to Assess the Parameter ^f				Events Occurring Within Window [‡]				
	Eligible ^a	Follow-up done ^c	Pending*	Still in Window	CT Scan	X-Ray	Diameter	Endoleak	Migration	Fracture	Death	Lost to follow-up	Early Withdrawal	Other ^b	Not yet due
Procedure	110	NA	NA	NA	NA	NA	NA	NA	NA	NA	0	NA	NA	NA	0
30 Days	110	99.1% (109)	0.9% (1)	0	99.1% (109)	97.3% (107)	98.2% (108)	96.4% (106)	99.1% (109)	97.3% (107)	2	0	0	0	0
6 Months	108	88.9% (96 ^e)	11.1% (12)	0	89.8% (97)	85.2% (92)	89.8% (97)	83.3% (90)	89.8% (97)	89.8% (97)	2	1	0	0	0
12 Months	105	88.6% (93)	12.4% (13)	0	87.6% (92)	88.6% (93)	87.6% (92)	81.0% (85)	87.6% (92)	88.6% (93)	1	2	5	3	3
2 Years	91	52.7% (48)	47.3% (43)	41.8% (38)	50.5% (46)	46.2% (42)	50.5% (46)	45.1% (41)	50.5% (46)	50.5% (46)	3	1	3	0	65
3 Years	19	21.1% (4)	78.9% (15)	78.9% (15)	21.1% (4)	21.1% (4)	21.1% (4)	21.1% (4)	21.1% (4)	21.1% (4)	0	0	0	0	17

Analysis Window	Subject Follow-Up				Imaging Performed ^d		Imaging Adequate to Assess the Parameter†				Events Occurring Within Window‡			
	Eligible ^a	Follow-up done ^c	Pending*	Still in Window	CT Scan	X-Ray	Diameter	Endoleak	Migration	Fracture	Death	Lost to follow-up	Early Withdrawal	Other ^b

NA – Not Applicable

^a Eligible subjects are all subjects who are enrolled by snapshot date and either have a follow-up visit form or are past due for their follow-up (beyond upper limit of window on study and did not exit the study before the upper limit of the window).

^b Subjects choose to not consent to the study follow up extension.

^c Subjects with follow-up data according to the investigational site.

^d Subjects with CT scan data as determined by the Core Lab.

*Subjects who did not have a visit within the window or subjects who did not have a visit but have not yet reached the end of the analysis window. The number of subjects eligible for the visit is used as the denominator when calculating the percentage of visits performed.

† Sac Diameter and Migration assessments use 1 month as baseline. Eligible subjects require valid value at 1 month and at the specified time point.

‡ These columns reflect subjects who had visits within the specified window but were not eligible at the start of the next window due to death, surgical conversion or early withdrawal.

§ One subject had no site follow-up data but has CT data available; therefore, there are 96 subjects with follow-up completed, and 97 subjects with CT imaging available.

6.4.2. Subject Demographics

The demographics of the study population are typical for a thoracic endovascular graft study performed in the US and are presented in **Table 4**. In the study, 62.7% of subjects were males (69/110) with 54.5% of the cohort being 75+ (60/110). Additionally, 39.1% (43/110) of the pivotal cohort was Asian and 49.1% (54/110) were white.

Regarding the Japan and US cohorts of the RelayPro Pivotal Study, the Japan cohort was older (mean 78.5 vs. 72.6) and consisted of a higher percentage of male subjects (78.6%, 33/42 vs. 52.9%, 36/68) as compared to the US cohort. The US cohort was predominantly white (79.4%, 54/68).

Characteristic	Statistics	US Cohort (N=68)	Japan Cohort (N=42)	Pivotal (N=110)
Sex				
Female	% (n)	47.1% (32)	21.4% (9)	37.3% (41)
Male	% (n)	52.9% (36)	78.6% (33)	62.7% (69)
Age (years) at Treatment	Mean ± SD	72.6 ± 8.5	78.5 ± 6.6	74.9 ± 8.3
	Median (IQR)	73 (67 - 78.5)	81 (73 - 83)	76 (70 - 81)
	Min - Max	45 - 92	65 - 94	45 - 94
Age Group				
18-64	% (n)	14.7% (10)	0	9.1% (10)
65-74	% (n)	41.2% (28)	28.6% (12)	36.4% (40)
75+	% (n)	44.1% (30)	71.4% (30)	54.5% (60)
Ethnic Group				
Hispanic/Latino	% (n)	4.4% (3)	0	2.7% (3)
Not Hispanic/Latino	% (n)	85.3% (58)	100.0% (42)	90.9% (100)

Characteristic	Statistics	US Cohort (N=68)	Japan Cohort (N=42)	Pivotal (N=110)
Not Reported	% (n)	10.3% (7)	0	6.4% (7)
Race				
Asian	% (n)	1.5% (1)	100.0% (42)	39.1% (43)
Black	% (n)	19.1% (13)	0	11.8% (13)
White	% (n)	79.4% (54)	0	49.1% (54)

Site reported data.

6.4.3. Baseline Medical History

Baseline subject comorbidities are presented in the **Table 5**. The most common comorbidities observed include hypertension and/or treatment for hypertension (86.4%, 95/110), hypercholesterolemia (64.5%, 71/110), history of smoking (81.8%, 90/110), history of peripheral vascular disease (18.2%, 20/110), documented COPD (29.1%, 32/110), history of neurologic disease (20%, 22/110), diabetes mellitus (19.1%, 21/110), and renal insufficiency (19.1%, 21/110).

Regarding the US and Japan cohorts of the RelayPro Pivotal Study, a larger proportion of subjects in the US cohort had history of peripheral vascular disease (26.5% vs. 4.8%), documented myocardial infarction (16.2% vs. 9.5%), documented COPD (33.8% vs. 21.4%), hypercholesterolemia (69.1% vs. 57.1%), and history of GI complications (35.3% vs. 21.4%). A larger proportion of subjects in the Japan cohort had diabetes mellitus (26.2% vs. 14.7%) and renal insufficiency (21.4% vs. 17.6%).

Comorbidity	US Cohort (N=68)	Japan Cohort (N=42)	Pivotal (N=110)
History of Peripheral Vascular Disease	26.5% (18)	4.8% (2)	18.2% (20)
Coronary Artery Disease			
Stable Angina	7.4% (5)	9.5% (4)	8.2% (9)
Unstable Angina	1.5% (1)	0	0.9% (1)
Myocardial Infarction	16.2% (11)	9.5% (4)	13.6% (15)
Arrhythmias	13.2% (9)	0	8.2% (9)
Congestive Heart Failure	5.9% (4)	2.4% (1)	4.5% (5)
Other	25.0% (17)	2.4% (1)	16.4% (18)
Chronic Obstructive Pulmonary Disease	33.8% (23)	21.4% (9)	29.1% (32)
Routine (daily/nightly) home oxygen use	0	11.1% (1/9)	3.1% (1/32)
History of Neurologic Disease	20.6% (14)	19.0% (8)	20.0% (22)
Diabetes Mellitus	14.7% (10)	26.2% (11)	19.1% (21)
Hypertension (HTN) and/or Treatment of HTN	88.2% (60)	83.3% (35)	86.4% (95)
Hypercholesterolemia	69.1% (47)	57.1% (24)	64.5% (71)
History of Smoking	83.8% (57)	78.6% (33)	81.8% (90)
Former Smoker	56.1% (32/57)	97.0% (32/33)	71.1% (64/90)
Current Smoker	43.9% (25/57)	3.0% (1/33)	28.9% (26/90)
Renal Insufficiency	17.6% (12)	21.4% (9)	19.1% (21)
Current Antiplatelet/ Anticoagulant Medication	66.2% (45)	40.5% (17)	56.4% (62)
History of Limb Ischemia	7.4% (5)	7.1% (3)	7.3% (8)
History of Vascular Intervention	23.5% (16)	28.6% (12)	25.5% (28)
History of Gastrointestinal Complications	35.3% (24)	21.4% (9)	30.0% (33)
Cholecystitis	4.4% (3)	0	2.7% (3)

Comorbidity	US Cohort (N=68)	Japan Cohort (N=42)	Pivotal (N=110)
Ischemic Colitis	1.5% (1)	0	0.9% (1)
GI Bleed	2.9% (2)	2.4% (1)	2.7% (3)
Small Bowel Ischemia	0	0	0
History of Impotence (males only)	16.7% (6/36)	3.0% (1/33)	10.1% (7/69)

All values expressed as % (n). Site reported data.

6.4.4. Baseline Aneurysm Characteristics

Baseline aneurysm and anatomical measurements, as well as access vessel characteristics of the study population, were reported by both the Core Lab and the site. The clinical sites and Core Lab evaluated 100% (110/110) of the baseline contrast CT scans. Baseline aneurysm characteristics are summarized in **Table 6** below.

All subjects enrolled in this study met the inclusion criteria based on site-reported CT measurements. Subject eligibility was confirmed by the Core Laboratory prior to enrollment. There were minor differences observed between the Core Lab and the site measurements. The majority of the measurements including proximal neck inner length, lesion length, diameter of proximal neck, maximum lesion diameter, diameter of distal neck (proximal) and access vessels (r/l common iliac, r/l external iliac, r/l femoral) showed minor variance in averages that are likely attributed to measurement technique. Distal neck length and total treatment length showed larger variances between site reported and Core Lab measurements. Sites reported distal neck length as 41.0 ± 21.9 mm compared to 78.7 ± 50.1 mm from the Core Laboratory and total treatment length of 197.1 ± 75.3 mm versus 284.8 ± 64.5 mm. This difference may be attributed to measurement technique and/or site concern for minimized coverage to avoid ischemia.

There were no substantial differences between the US cohort and the Japan cohort related to the baseline aneurysm and anatomical measurements. There were minor differences with proximal neck length and aneurysm length between the two cohorts. The Japan cohort had a longer length from LCC to proximal end of proximal neck (37.0 ± 42.0 mm vs. 19.4 ± 17.3 mm) and proximal neck length - centerline (75.0 ± 36.8 mm vs. 64.9 ± 36.3 mm) and inner curve (56.3 ± 30.6 mm vs. 47.8 ± 31.4 mm). Aneurysm length was longer for the US cohort (104.4 ± 59.0 vs. 85.0 ± 40.3 mm). All other measurements were comparable.

Of the 110 subjects enrolled in the study with aneurysms, 76 were fusiform aneurysms (45 US and 31 Japanese subjects) and 34 were saccular aneurysms or PAUs, site reported assessment.

Characteristic	Statistics	US Cohort (N=68)	Japan Cohort (N=42)	Pivotal (N=110)
Slice Thickness	Mean \pm SD	1.5 \pm 0.7	1.7 \pm 0.8	1.6 \pm 0.8
	Median (IQR)	1.3 (1.0 - 2.0)	1.5 (1.0 - 2.0)	1.3 (1.0 - 2.0)
	Min - Max	0.5 - 3.0	0.5 - 3.0	0.5 - 3.0
Aortic Diameter at LCC (mm)	Mean \pm SD	31.8 \pm 4.1	34.9 \pm 4.7	33.0 \pm 4.6
	Median (IQR)	31.5 (29.4 - 33.9)	34.4 (32.0 - 37.1)	32.5 (30.2 - 35.1)
	Min - Max	24.1 - 46.9	27.5 - 49.9	24.1 - 49.9
Aortic Diameter at LSA (mm)	Mean \pm SD	30.5 \pm 3.7	33.6 \pm 4.8	31.7 \pm 4.4
	Median (IQR)	30.4 (27.4 - 32.6)	33.6 (30.3 - 36.3)	31.3 (28.7 - 34.6)
	Min - Max	20.6 - 39.8	25.5 - 47.2	20.6 - 47.2
Aortic Diameter at Distal End of Proximal Neck (mm)	Mean \pm SD	33.8 \pm 4.6	35.3 \pm 5.0	34.4 \pm 4.8

Table 6. Core Laboratory – Reported Baseline CT Measurements				
Characteristic	Statistics	US Cohort (N=68)	Japan Cohort (N=42)	Pivotal (N=110)
	Median (IQR)	34.4 (29.9 - 36.8)	36.5 (31.7 - 39.0)	34.7 (30.9 - 37.7)
	Min - Max	23.2 - 44.3	24.7 - 43.8	23.2 - 44.3
Aortic Diameter at Proximal End of Distal Neck (mm)	Mean ± SD	32.2 ± 4.5	31.9 ± 4.4	32.1 ± 4.4
	Median (IQR)	32.2 (28.5 - 34.9)	31.0 (28.2 - 34.8)	31.9 (28.3 - 34.8)
	Min - Max	22.4 - 42.1	25.1 - 44.3	22.4 - 44.3
Length from LCC to Proximal End of Proximal Neck (mm)	Mean ± SD	19.4 ± 17.3	37.0 ± 42.0	26.1 ± 30.3
	Median (IQR)	19.3 (0.0 - 28.4)	17.9 (14.4 - 50.2)	18.4 (11.0 - 32.0)
	Min - Max	0.0 - 82.8	0.0 - 156.0	0.0 - 156.0
Proximal Neck Length – Centerline (mm)	Mean ± SD	64.9 ± 36.3	75.0 ± 36.8	68.8 ± 36.7
Centerline distance from the proximal edge of the landing zone to the proximal edge of the aneurysm/lesion	Median (IQR)	54.4 (35.7 - 83.0)	70.3 (42.3 - 106.0)	57.8 (38.6 - 94.0)
	Min - Max	22.6 - 186.0	25.8 - 150.0	22.6 - 186.0
Proximal Neck Length – Inner Curve (mm)	Mean ± SD	47.8 ± 31.4	56.3 ± 30.6	51.0 ± 31.2
Inner curve distance from the proximal edge of the landing zone to the proximal edge of the aneurysm/lesion	Median (IQR)	37.9 (23.3 - 62.4)	46.7 (29.3 - 81.0)	40.9 (25.3 - 74.0)
	Min - Max	13.9 - 158.0	20.0 - 125.0	13.9 - 158.0
Distal Neck Length – Centerline (mm)	Mean ± SD	77.4 ± 47.2	80.7 ± 54.9	78.7 ± 50.1
Centerline distance from the distal edge of the aneurysm/lesion to the proximal edge of the celiac trunk	Median (IQR)	63.0 (40.2 - 95.4)	60.3 (36.3 - 108.0)	63.0 (38.3 - 100.0)
	Min - Max	25.1 - 219.0	25.8 - 204.0	25.1 - 219.0
Distal Neck Length – Inner Curve (mm)	Mean ± SD	71.7 ± 45.3	74.7 ± 51.3	72.8 ± 47.5
Inner curve distance from the distal edge of the aneurysm/lesion to the proximal edge of the celiac trunk	Median (IQR)	57.2 (37.0 - 92.0)	56.8 (34.0 - 107.0)	57.2 (35.4 - 93.3)
	Min - Max	20.0 - 219.0	21.4 - 194.0	20.0 - 219.0
Aneurysm Length (mm)	Mean ± SD	104.4 ± 59.0	85.0 ± 40.3	97.0 ± 53.3
	Median (IQR)	92.0 (54.7 - 142.5)	84.0 (53.1 - 107.0)	89.4 (53.6 - 127.0)
	Min - Max	19.6 - 236.0	18.8 - 172.0	18.8 - 236.0
Right Iliac Tortuosity Index	Mean ± SD	1.3 ± 0.2	1.4 ± 0.2	1.4 ± 0.2
	Median (IQR)	1.3 (1.2 - 1.5)	1.3 (1.2 - 1.5)	1.3 (1.2 - 1.5)
	Min - Max	1.1 - 1.8	1.1 - 2.2	1.1 - 2.2
Left Iliac Tortuosity Index	Mean ± SD	1.3 ± 0.2	1.4 ± 0.2	1.3 ± 0.2
	Median (IQR)	1.3 (1.2 - 1.4)	1.3 (1.2 - 1.5)	1.3 (1.2 - 1.5)
	Min - Max	1.1 - 1.8	1.1 - 2.0	1.1 - 2.0
Proximal Neck Thrombus Max Thickness (mm)	Mean ± SD	0.9 ± 1.6	1.0 ± 2.0	0.9 ± 1.8
	Median (IQR)	0.0 (0.0 - 0.9)	0.0 (0.0 - 0.0)	0.0 (0.0 - 0.0)
	Min - Max	0.0 - 5.4	0.0 - 8.3	0.0 - 8.3
Proximal Neck Thrombus Degrees >2mm in Thickness (mm)	Mean ± SD	20.1 ± 47.4	19.2 ± 41.7	19.7 ± 45.1
	Median (IQR)	0.0 (0.0 - 0.0)	0.0 (0.0 - 0.0)	0.0 (0.0 - 0.0)
	Min - Max	0.0 - 200.0	0.0 - 151.0	0.0 - 200.0
Proximal Neck Calcium Max Thickness (mm)	Mean ± SD	1.2 ± 1.3	2.1 ± 1.7	1.5 ± 1.5

Table 6. Core Laboratory – Reported Baseline CT Measurements

Characteristic	Statistics	US Cohort (N=68)	Japan Cohort (N=42)	Pivotal (N=110)
	Median (IQR)	0.0 (0.0 - 2.2)	2.3 (0.0 - 2.9)	1.8 (0.0 - 2.6)
	Min - Max	0.0 - 4.5	0.0 - 6.0	0.0 - 6.0
Proximal Neck Calcium Degrees	Mean ± SD	24.2 ± 38.3	34.6 ± 38.6	28.2 ± 38.6
	Median (IQR)	0.0 (0.0 - 35.0)	25.0 (0.0 - 45.0)	13.5 (0.0 - 41.0)
	Min - Max	0.0 - 169.0	0.0 - 152.0	0.0 - 169.0
Distal Neck Thrombus Max Thickness (mm)	Mean ± SD	1.5 ± 2.8	1.3 ± 2.1	1.5 ± 2.5
	Median (IQR)	0.0 (0.0 - 2.9)	0.0 (0.0 - 2.9)	0.0 (0.0 - 2.9)
	Min - Max	0.0 - 15.5	0.0 - 7.2	0.0 - 15.5
Distal Neck Thrombus Degrees >2mm in Thickness (mm)	Mean ± SD	27.8 ± 48.5	28.6 ± 51.4	28.1 ± 49.4
	Median (IQR)	0.0 (0.0 - 54.0)	0.0 (0.0 - 50.0)	0.0 (0.0 - 51.0)
	Min - Max	0.0 - 211.0	0.0 - 200.0	0.0 - 211.0
Distal Neck Calcium Max Thickness (mm)	Mean ± SD	0.9 ± 1.2	1.4 ± 1.3	1.1 ± 1.3
	Median (IQR)	0.0 (0.0 - 1.9)	1.6 (0.0 - 2.5)	0.0 (0.0 - 2.0)
	Min - Max	0.0 - 4.1	0.0 - 4.5	0.0 - 4.5
Distal Neck Calcium Degrees	Mean ± SD	14.4 ± 29.5	16.0 ± 23.7	15.0 ± 27.3
	Median (IQR)	0.0 (0.0 - 15.5)	11.0 (0.0 - 23.0)	0.0 (0.0 - 19.7)
	Min - Max	0.0 - 173.0	0.0 - 122.0	0.0 - 173.0
Max TAA Diameter (mm)	Mean ± SD	54.6 ± 10.6	58.6 ± 8.0	56.1 ± 9.9
	Median (IQR)	55.2 (48.2 - 61.6)	57.7 (55.6 - 61.0)	56.9 (50.7 - 61.1)
	Min - Max	33.0 - 80.8	34.7 - 81.3	33.0 - 81.3
PAU: Depth (mm)	Mean ± SD (N)	11.0 ± 1.3 (9)	19.7 ± NA (1)	11.8 ± 3.0 (10)
	Median (IQR)	10.2 (10.0 - 11.8)	19.7 (19.7 - 19.7)	10.4 (10.0 - 13.0)
	Min - Max	10.0 - 13.2	19.7 - 19.7	10.0 - 19.7
PAU: Diameter (mm)	Mean ± SD (N)	27.6 ± 7.7 (9)	27.8 ± NA (1)	27.6 ± 7.2 (10)
	Median (IQR)	26.0 (24.0 - 35.6)	27.8 (27.8 - 27.8)	26.9 (24.0 - 35.6)
	Min - Max	14.5 - 36.3	27.8 - 27.8	14.5 - 36.3
Total Treatment Length - Outer Curve (mm)	Mean ± SD (N)	289.6 ± 59.5 (67)	277.1 ± 71.7 (42)	284.8 ± 64.5 (109)
Outer curve distance from the proximal end of the proximal neck to the distal end of the distal neck.	Median (IQR)	293.0 (262.0 - 327.0)	293.5 (242.0 - 320.0)	293.0 (258.0 - 326.0)
	Min - Max	40.6 - 408.0	60.5 - 378.0	40.6 - 408.0
Tortuosity Index	Mean ± SD (N)	1.5 ± 0.2 (64)	1.6 ± 0.2 (42)	1.5 ± 0.2 (106)
	Median (IQR)	1.5 (1.4 - 1.6)	1.6 (1.5 - 1.6)	1.5 (1.4 - 1.6)
	Min - Max	1.2 - 2.0	1.2 - 2.4	1.2 - 2.4
Minimum Right Common Iliac Diameter (mm)	Mean ± SD (N)	9.5 ± 2.5 (66)	9.3 ± 2.7 (42)	9.4 ± 2.5 (108)
	Median (IQR)	9.5 (7.7 - 11.1)	9.0 (7.9 - 10.5)	9.3 (7.8 - 11.0)
	Min - Max	4.6 - 15.9	4.1 - 18.3	4.1 - 18.3
Minimum Right External Iliac Diameter (mm)	Mean ± SD (N)	6.9 ± 1.8 (66)	7.4 ± 1.3 (42)	7.1 ± 1.6 (108)
	Median (IQR)	6.9 (5.5 - 8.2)	7.4 (6.6 - 8.3)	7.2 (5.9 - 8.2)
	Min - Max	3.7 - 11.3	4.5 - 10.9	3.7 - 11.3
Minimum Right Common Femoral Diameter (mm)	Mean ± SD (N)	7.5 ± 1.8 (66)	8.3 ± 1.3 (42)	7.8 ± 1.7 (108)

Characteristic	Statistics	US Cohort (N=68)	Japan Cohort (N=42)	Pivotal (N=110)
	Median (IQR)	7.3 (6.2 - 9.0)	8.2 (7.2 - 9.2)	7.6 (6.8 - 9.1)
	Min - Max	4.1 - 12.3	6.0 - 11.3	4.1 - 12.3
Minimum Left Common Iliac Diameter (mm)	Mean ± SD (N)	9.4 ± 2.8 (67)	9.2 ± 2.6 (42)	9.3 ± 2.7 (109)
	Median (IQR)	9.2 (7.0 - 10.8)	8.9 (7.7 - 10.2)	9.2 (7.4 - 10.8)
	Min - Max	3.4 - 18.6	4.7 - 17.5	3.4 - 18.6
Minimum Left External Iliac Diameter (mm)	Mean ± SD (N)	6.7 ± 1.8 (67)	7.4 ± 1.2 (42)	7.0 ± 1.7 (109)
	Median (IQR)	6.8 (5.5 - 8.1)	7.3 (6.6 - 8.0)	6.9 (5.9 - 8.0)
	Min - Max	2.6 - 10.5	5.2 - 10.6	2.6 - 10.6
Minimum Left Common Femoral Diameter (mm)	Mean ± SD (N)	7.5 ± 1.7 (66)	8.0 ± 1.3 (42)	7.7 ± 1.6 (108)
	Median (IQR)	7.4 (6.2 - 8.6)	7.8 (7.2 - 8.7)	7.7 (6.5 - 8.7)
	Min - Max	3.8 - 11.6	5.3 - 11.7	3.8 - 11.7
Arch Type				
Type I	% (n)	8.8% (6)	14.3% (6)	10.9% (12)
Type II	% (n)	42.6% (29)	19.0% (8)	33.6% (37)
Type III	% (n)	48.5% (33)	66.7% (28)	55.5% (61)
Arch Type (Normal/Bovine)				
Bovine	% (n)	25.0% (17)	0	15.5% (17)
Normal	% (n)	75.0% (51)	100.0% (42)	84.5% (93)
Indication				
Aneurysm	% (n)	86.8% (59)	97.6% (41)	90.9% (100)
PAU	% (n)	13.2% (9)	2.4% (1)	9.1% (10)

Core Laboratory reported data.

6.4.5. RelayPro Stent-Grafts Implanted

A total of 168 device components were implanted in the Pivotal Study. The number of devices implanted in the initial procedure are shown in **Table 7** as well as numbers of straight and tapered configurations. One RelayPro device was implanted in 51.8% (57/110) of the cohort (43 NBS and 14 Proximal Bare Stent), and two RelayPro devices were implanted in 43.6% (48/110) of the cohort (33 NBS only, 5 Proximal Bare Stent only and 10 received both). Three RelayPro devices were implanted in 5 subjects (4.5%, 5/110) of the cohort (1 NBS only and 4 received both).

Number of Devices Implanted	US Cohort (N=68)	Japan Cohort (N=42)	Pivotal (N=110)
Overall			
1	57.4% (39)	42.9% (18)	51.8% (57)
2	36.8% (25)	54.8% (23)	43.6% (48)
3	5.9% (4)	2.4% (1)	4.5% (5)
Bare Stent Devices			
1	11.8% (8)	14.3% (6)	12.7% (14)
2	13.2% (9)	14.3% (6)	13.6% (15)
3	5.9% (4)	0	3.6% (4)
Straight	16.2% (11)	11.9% (5)	14.5% (16)

Table 7. Number of RelayPro Devices Implanted During the Initial Procedure

Number of Devices Implanted	US Cohort (N=68)	Japan Cohort (N=42)	Pivotal (N=110)
Tapered	14.7% (10)	16.7% (7)	15.5% (17)
Reverse Tapered**	0	0	0
NBS Devices			
1	45.6% (31)	28.6% (12)	39.1% (43)
2	30.9% (21)	52.4% (22)	39.1% (43)
3	5.9% (4)	2.4% (1)	4.5% (5)
Straight	54.4% (37)	45.2% (19)	50.9% (56)
Tapered	26.5% (18)	38.1% (16)	30.9% (34)
Reverse Tapered**	1.5% (1)	0	0.9% (1)

*Denominator includes all subjects who received the test device. Site reported data.
 **The proximal diameter is smaller than the distal diameter.

The diameters of the devices implanted in the Pivotal Study are shown in **Table 8**. As the distal end of the NBS and bare stent configurations are identical, Distal section of the table represents the distal diameter of all devices implanted. The most commonly implanted NBS devices were the 34 mm (19.1%, 21/110), 36 mm (21.8%, 24/110), 38 mm (28.2%, 31/110), and 40 mm (13.6%, 15/110) proximal diameters. The most commonly implanted proximal bare stent configurations were the 36 mm (7.3%, 8/110), 38 mm (10.9%, 12/110), and 40 mm (6.4%, 7/110) proximal diameters.

Table 8. Diameters of RelayPro Devices Implanted During the Initial Procedure

Diameters (mm)	US Cohort (N=68)	Japan Cohort (N=42)	Pivotal (N=110)
Proximal (NBS)			
26	0	4.8% (2)	1.8% (2)
28	1.5% (1)	0	0.9% (1)
30	4.4% (3)	11.9% (5)	7.3% (8)
32	11.8% (8)	7.1% (3)	10.0% (11)
34	19.1% (13)	19.0% (8)	19.1% (21)
36	22.1% (15)	21.4% (9)	21.8% (24)
38	30.9% (21)	21.4% (9)	27.3% (30)
40	11.8% (8)	16.7% (7)	13.6% (15)
42	5.9% (4)	16.7% (7)	10.0% (11)
44	1.5% (1)	9.5% (4)	4.5% (5)
46	4.4% (3)	0	2.7% (3)
Proximal (bare stent)			
26	0	0	0
28	0	0	0
30	5.9% (4)	4.8% (2)	5.5% (6)
32	4.4% (3)	2.4% (1)	3.6% (4)
34	5.9% (4)	4.8% (2)	5.5% (6)
36	8.8% (6)	4.8% (2)	7.3% (8)
38	13.2% (9)	7.1% (3)	10.9% (12)
40	5.9% (4)	7.1% (3)	6.4% (7)
42	2.9% (2)	2.4% (1)	2.7% (3)
44	1.5% (1)	2.4% (1)	1.8% (2)
46	2.9% (2)	0	1.8% (2)
Distal			

Diameters (mm)	US Cohort (N=68)	Japan Cohort (N=42)	Pivotal (N=110)
26	1.5% (1)	4.8% (2)	2.7% (3)
28	5.9% (4)	2.4% (1)	4.5% (5)
30	5.9% (4)	19.0% (8)	10.9% (12)
32	17.6% (12)	14.3% (6)	16.4% (18)
34	36.8% (25)	31.0% (13)	34.5% (38)
36	25.0% (17)	26.2% (11)	25.5% (28)
38	23.5% (16)	11.9% (5)	19.1% (21)
40	11.8% (8)	19.0% (8)	14.5% (16)
42	5.9% (4)	16.7% (7)	10.0% (11)
44	1.5% (1)	2.4% (1)	1.8% (2)
46	2.9% (2)	0	1.8% (2)

*Denominator includes all subjects who received the test device. Site reported data.

6.4.6. Acute Procedural Information

Detailed information and observations regarding the index procedure were documented by the physician on case report forms. **Table 9** summarizes the information from the index procedure, including clinical utility endpoints. The majority of subjects had general anesthesia (93.6%, 103/110). Right femoral access (73.6%, 81/110) was the predominant access location. Mean duration of the procedure was 113.6 ± 79.6 min and the mean implantation duration was 20 ± 16 min.

Vascular access method was different between the US and Japan cohorts, with the Japan cohort using 100% surgical cutdown (42/42) compared to 73.5% of subjects (50/68) in the US cohort having the percutaneous access. In the US cohort, the duration of ICU time (61.4±57.9 hours vs. 21.6±19.4 hours) was lengthier compared to the Japanese cohort, while the duration of hospital stay was lengthier in the Japanese cohort (9.9±6.8 days vs. 4.8±3.8 days).

Characteristic	Statistics	US Cohort (N=68)	Japan Cohort (N=42)	Pivotal (N=110)
Type of Anesthesia				
General	% (n)	98.5% (67)	85.7% (36)	93.6% (103)
Local	% (n)	1.5% (1)	14.3% (6)	6.4% (7)
Vascular Access				
Left Femoral	% (n)	25.0% (17)	26.2% (11)	25.5% (28)
Right Femoral	% (n)	73.5% (50)	73.8% (31)	73.6% (81)
Right Iliac	% (n)	1.5% (1)	0	0.9% (1)
Vascular Access Method				
Conduit	% (n)	2.9% (2)	0	1.8% (2)
Percutaneous	% (n)	73.5% (50)	0	45.5% (50)
Surgical Cut Down	% (n)	23.5% (16)	100.0% (42)	52.7% (58)
Procedure time (min)	Mean ± SD	117.2 ± 96.6	107.9 ± 39.3	113.6 ± 79.6
	Median (IQR)	87.5 (53 - 142.5)	96 (85 - 128)	91 (64 - 131)
	Min - Max	27 - 563	53 - 230	27 - 563
Implantation time (min)	Mean ± SD	20 ± 18	20 ± 12	20 ± 16

Table 9. Details of the Initial Procedure				
Characteristic	Statistics	US Cohort (N=68)	Japan Cohort (N=42)	Pivotal (N=110)
	Median (IQR)	16 (9.5 - 25.5)	17 (12 - 25)	16 (10 - 25)
	Min - Max	2 - 120	5 - 54	2 - 120
Estimated Blood Loss (cc)	Mean ± SD (N)	195 ± 356 (67)	132 ± 334 (42)	170 ± 348 (109)
	Median (IQR)	100 (50 - 200)	31 (10 - 85)	52 (20 - 150)
	Min - Max	5 - 2500	0 - 1516	0 - 2500
Transfusion Required	% (n)	2.9% (2)	2.4% (1)	2.7% (3)
ICU Stay (hours)	Mean ± SD	61.4 ± 57.9	21.6 ± 19.4	46.2 ± 50.8
	Median (IQR)	50 (33 - 71.5)	22 (0 - 24)	36 (22 - 57)
	Min - Max	0 - 360	0 - 73	0 - 360
Hospital Stay (days)	Mean ± SD	4.8 ± 3.8	9.9 ± 6.8	6.7 ± 5.7
	Median (IQR)	3.8 (3 - 6)	8.5 (7 - 10)	5 (3 - 9)
	Min - Max	1 - 22	3 - 36	1 - 36
Site reported data.				

6.4.7. Safety Results

6.4.7.1. Primary Safety Endpoint

The analysis of safety was based on the RelayPro Pivotal Study cohort of 110 subjects available for the 30-day (1 month) evaluation. The key safety outcomes for this study are presented below in **Table 10**.

The primary safety endpoint was the MAE rate through 30 days post procedure compared to a performance goal of 20%. Subjects who experienced at least 1 MAE through 30 days were included in the primary safety analysis even if the subject had not completed a 1-month follow-up visit. The composite MAE rate through 30 days was 6.4% (7/110, upper 95% CI 11.6%, P=0.0002). A total of 7 MAEs were observed in 7 subjects. MAEs reported through 30 days include 2 strokes, 2 cases of procedural blood loss >1,000 cc requiring transfusion, 2 paralysis events (excluding paraparesis), and 1 renal failure event.

Since all 110 subjects were available for the primary safety endpoint, there's no missing data and thus no need for sensitivity analysis.

An assessment of poolability was performed by comparing the primary safety endpoint across sites, both Japanese and U.S. sites individually, as well as pooled Japanese sites as compared to pooled U.S. sites. These analyses were based on Fisher's Exact test of binomial proportions. No significant difference between the groups were found.

Table 10. 30-Day Major Adverse Events: Pivotal Study				
Characteristic	Statistics	US Cohort (N=68)	Japan Cohort (N=42)	Pivotal (N=110)
MAE Rate at 30 Days	% (n)			6.4% (7)
	Upper 95% CI			11.6%
	P-Value*			0.0002
Time to MAE Analysis				
Number with Events	n			7

Table 10. 30-Day Major Adverse Events: Pivotal Study				
Characteristic	Statistics	US Cohort (N=68)	Japan Cohort (N=42)	Pivotal (N=110)
Censored	n			1
At Risk	n			101
Freedom from MAE within 30 days	% (95% CI)			93.6% (87.1%, 96.9%)
MAE individual components				
Death	% (n)	0	0	0
Myocardial Infarction	% (n)	0	0	0
Stroke (excluding TIA)	% (n)	1.5% (1)	2.4% (1)	1.8% (2)
Renal Failure	% (n)	1.5% (1)	0	0.9% (1)
Respiratory Failure	% (n)	0	0	0
Paralysis (excluding paraparesis)	% (n)	0	4.8% (2)	1.8% (2)
Bowel Ischemia	% (n)	0	0	0
Procedural blood loss > 1,000 cc requiring transfusion	% (n)	2.9% (2)	0	1.8% (2)
*P-value corresponds to the null hypothesis test that the observed value is greater than the Primary Safety Endpoint Performance Goal of 20%.				
MAE – Major Adverse Events, NA – not applicable.				
All MAEs were adjudicated by the Clinical Events Committee (CEC).				

6.4.7.2. Secondary Safety Endpoints

6.4.7.2.1. Major Adverse Events

A secondary safety endpoint includes the individual components of the Major Adverse Events (MAE) endpoint (**Figure 3**), namely death, myocardial infarction, stroke (excluding transient ischemic attack), renal failure, respiratory failure, paralysis (excluding paraparesis), bowel ischemia, and procedural blood loss > 1000 cc requiring transfusion. All MAEs were adjudicated by the Clinical Events Committee.

MAEs throughout follow-up are depicted in **Figure 3** as a Kaplan-Meier plot and the underlying data. Kaplan-Meier analysis predicts a freedom from MAEs of 93.6% at 1-30 days, 89.0% at 31-180 days, 89% at 181-360 days, 87.4% at 361-540 days, 78.7% at 541-720 days and 74.1% at 721-900 days.

Figure 3. Kaplan-Meier Freedom from Major Adverse Event

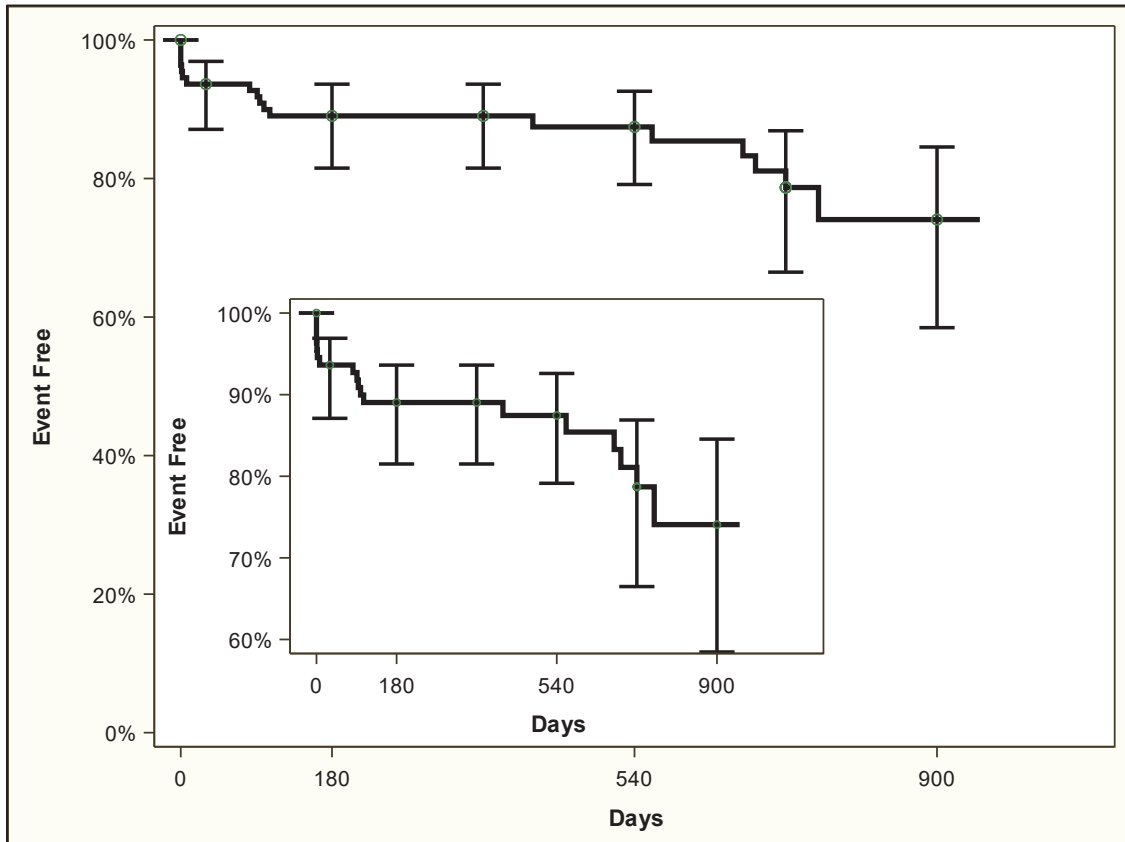

From Day X - Day Y	# Entered	# Censored	# Events	Event-free [%]	Greenwood SE [%]	95% Confidence Interval
0	110	0	4	96.4%	1.8%	90.6%-98.6%
1-30	106	1	3	93.6%	2.3%	87.1%-96.9%
31-180	102	0	5	89.0%	3.0%	81.5%-93.6%
181-360	97	11	0	89.0%	3.0%	81.5%-93.6%
361-540	86	42	1	87.4%	3.3%	79.1%-92.6%
541-720	43	7	4	78.7%	5.1%	66.5%-86.9%
721-900	32	29	1	74.1%	6.6%	58.5%-84.6%
901-1080	2	2	0	-	-	-

The total number of subjects who were eligible for follow-up with MAE(s) was reported as 7.3% (8/110) at 30 days, 3.7% (4/108) at 6 months, 1.9% (2/105) at 12 months, and 5.5% (5/91) at 2-years as summarized in **Table 11**. Six (6) subjects experienced either a stroke (4 - occurring at 1 day, 7 days, 94 days and 419 days post implant) or paraplegia (2) event during the study. The two subjects in the Japan cohort reporting paraplegia (immobility of the lower limbs) had symptom onset on the day of the procedure. Both were managed with spinal drain placement and the paraplegia improved on the same day; both events were adjudicated by the CEC as procedure related, one as also adjudicated as device related.

MAE	30 Days	6 Months	12 Months	2 Year	Total
Number Eligible for Follow-Up	110	108	105	91	-
Subjects with ≥ 1 MAE (Total)	7.3% (8/110)	3.7% (4/108)	1.9% (2/105)	5.5% (5/91)	19

Table 11. Summary of MAEs Reported at Follow-Up					
MAE	30 Days	6 Months	12 Months	2 Year	Total
MAEs (Total)	9	5	2	5	21
Death					
New	2	2	1	3	8
To Date	1.8% (2/110)	3.6% (4/110)	4.6% (5/109)	8.3% (8/96)	-
Myocardial Infarction					
New	0	1	0	0	1
To Date	0	0.9% (1/108)	1.0% (1/105)	1.1% (1/91)	-
Paralysis					
New	2	0	0	0	2
To Date	1.8% (2/110)	1.9% (2/108)	1.9% (2/105)	2.2% (2/92)	-
Stroke					
New	2	1	1	0	4
To Date	1.8% (2/110)	2.8% (3/109)	3.7% (4/107)	4.3% (4/93)	-
Renal Failure					
New	1	1	0	1	3
To Date	0.9% (1/110)	1.9% (2/108)	1.9% (2/105)	3.2% (3/93)	-
Procedural blood loss > 1000 cc requiring transfusion					
New	2	0	0	0	2
To Date	1.8% (2/110)	1.9% (2/108)	1.9% (2/105)	2.2% (2/91)	-
Bowel ischemia					
New	0	0	0	1	1
To Date	0	0	0	1.1% (1/91)	-
CEC data.					

6.4.7.2.2. All Cause and Aneurysm-Related Mortality

There have been 8 reports of death in the Pivotal Study. The Kaplan-Meier analysis estimate for freedom from All-Cause Mortality is shown in **Figure 4**. Kaplan Meier analysis predicts a freedom from All-Cause Mortality to be 100% at 30 days, 97.2% at 31-180 days, 96.3% at 181-360 days, 94.3% at 361-540 days, 92.2% at 541-720 days and 80.3% at 721-900 days and 901-1080 days.

Figure 4. Kaplan-Meier Freedom from All-Cause Mortality

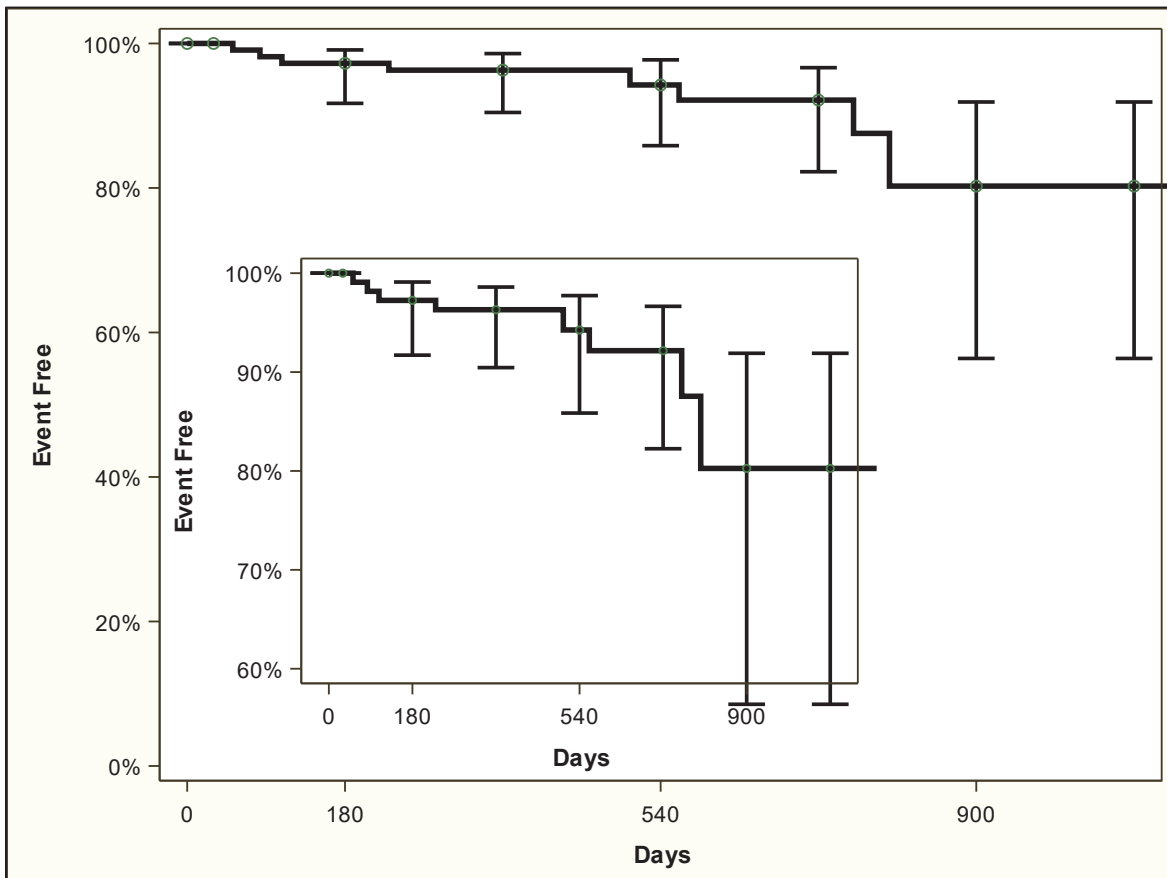

From Day X - Day Y	# Entered	# Censored	# Events	Event-free [%]	Greenwood SE [%]	95% Confidence Interval
0	110	0	0	100.0%	0%	-
1-30	110	1	0	100.0%	0%	-
31-180	109	0	3	97.2%	1.6%	91.7%-99.1%
181-360	106	12	1	96.3%	1.8%	90.4%-98.6%
361-540	93	47	1	94.3%	2.7%	85.9%-97.7%
541-720	45	8	1	92.2%	3.4%	82.2%-96.6%
721-900	36	30	2	80.3%	8.6%	56.4%-91.9%
901-1080	4	3	0	80.3%	8.6%	56.4%-91.9%

The RelayPro Aneurysm Study (Pro-A) Lesion-Related Mortality is defined as subject death as the result of a serious and device- or procedure-related adverse effect. Two subjects expired on day 52 and 83 post implant, respectively and met the criteria for lesion-related mortality. Kaplan-Meier analysis predicts a freedom from Lesion-Related Mortality at 30 days of 100% and 98.2% through 3 years (**Figure 5**).

Pro-A Aneurysm-Related Mortality is defined as either death due to a rupture, death within 30 days or prior to hospital

discharge from primary procedure, or death within 30 days or prior to hospital discharge for a secondary procedure to treat the index pathology. There was no aneurysm-related mortality reported.

Please note that there were two definitions for relatedness to mortality for this Pro-A study and were prospectively defined as presented above. The standard aneurysm-related mortality definition used for other thoracic endovascular graft studies includes a combination of both the Pro-A definitions for Lesion-Related and Aneurysm-Related Mortality. As there were no deaths meeting the Pro-A Aneurysm-Related definition, the Pro-A Lesion-Related deaths represents the standard aneurysm-related mortality definition.

Figure 5. Kaplan-Meier Freedom from Standard Aneurysm-Related Morality (Pro-A Lesion-Related Mortality): Pivotal Study

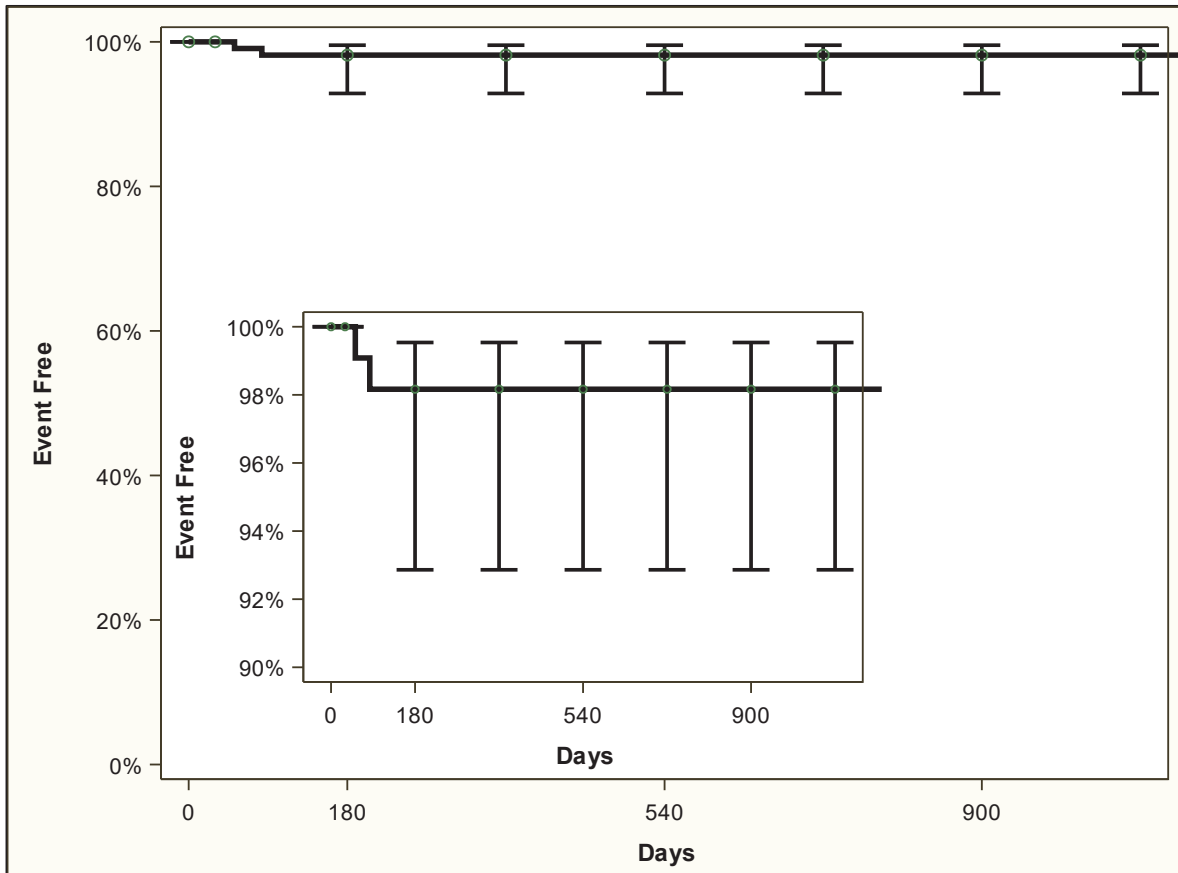

From Day X - Day Y	# Entered	# Censored	# Events	Event-free [%]	Greenwood SE [%]	95% Confidence Interval
0	110	0	0	100.0%	0.0%	-
1-30	110	1	0	100.0%	0.0%	-
31-180	109	1	2	98.2%	1.3%	92.9%-99.5%
181-360	106	13	0	98.2%	1.3%	92.9%-99.5%
361-540	93	48	0	98.2%	1.3%	92.9%-99.5%
541-720	45	9	0	98.2%	1.3%	92.9%-99.5%
721-900	36	32	0	98.2%	1.3%	92.9%-99.5%
901-1080	4	3	0	98.2%	1.3%	92.9%-99.5%

6.4.8. Device-Related Adverse Events

Adverse events adjudicated by the CEC as being device-related are summarized in **Table 12** where 11.8% (13/110) of subjects experienced one or more device-related adverse events with the most frequently reported being stent-graft endoleaks (11/110, 10.0%).

Table 12. Summary of CEC Adjudicated Device-Related Adverse Events			
MedDRA System-Organ Class/Preferred Term Adverse Event	US Cohort (N=68)	Japan Cohort (N=42)	Pivotal (N=110)
Subjects with One or More Device-Related Adverse Events	8 (11.8%)	5 (11.9%)	13 (11.8%)
Gastrointestinal disorders	1 (1.5%)	0	1 (0.9%)
Gastrointestinal hemorrhage	1 (1.5%)	0	1 (0.9%)
General disorders and administration site conditions	6 (8.8%)	4 (9.5%)	10 (9.1%)
Stent-graft endoleak*	7 (10.3%)	4 (9.5%)	11 (10.0%)
Nervous system disorders	0	1 (2.4%)	1 (0.9%)
Paraplegia	0	1 (2.4%)	1 (0.9%)
Product issues	1 (1.5%)	1 (2.4%)	2 (1.8%)
Device dislocation	1 (1.5%)**	1 (2.4%***)	2 (1.8%)

Data is presented as n (%). Includes serious and non-serious adverse events. CEC data.
Percentages are based on the number of subjects in the Safety Evaluable Population. Event verbatim terms are reported by sites.
The events listed in this table are coded using MedDRA version 21.0 and then stratified by System-Organ Class (SOC) and Preferred Term. Subjects may be counted in this table more than once by Preferred Term but are only counted once in the SOC summary line.
*Stent-graft endoleak: 3 Subjects with Type Ib endoleaks; 1 Subject with a Type II endoleak; 2 Subjects with a Type Ia endoleak; 2 Subjects with a site-reported Type Ia endoleak (Core Lab reported Type II); 2 Subjects with site reported Type IIIb endoleak (Core Lab reported Type II); 1 Subject with site-reported Type Ia endoleak (Core Lab reported Type II).
**Site-reported proximal migration at the 6-month visit resulting in a secondary intervention where an additional RelayPro was implanted proximally. Secondary intervention was adequate to address the migration as observed during the 12-month and 2-year visits.
***Site-reported Type Ia endoleak and migration at the 2-year follow-up (Core Lab reported Type Ia endoleak with thoracic aorta lengthening, no migration). The secondary intervention was performed to implant competitive devices to successfully exclude the lesion.

6.4.9. Procedure-Related Adverse Events

Adverse events adjudicated by the CEC as being procedure-related are summarized in **Table 13** where 13.6% (15/110) of subjects experienced one or more procedure-related adverse events. The incidences of paraplegia, cerebral infarction and cerebrovascular accident were 1.8% (2/110), 1.8% (2/110) and 0.9% (1/110), respectively.

Table 13. Summary of CEC Adjudicated Procedure-Related Adverse Events			
MedDRA System-Organ Class/Preferred Term Adverse Event	US Cohort (N=68)	Japan Cohort (N=42)	Pivotal (N=110)
Subjects with One or More Procedure-Related Adverse Events	10 (14.7%)	5 (11.9%)	15 (13.6%)
Blood and lymphatic system disorders	1 (1.5%)	0	1 (0.9%)
Blood loss anemia	1 (1.5%)	0	1 (0.9%)
Cardiac disorders	1 (1.5%)	0	1 (0.9%)
Chest pain	1 (1.5%)	0	1 (0.9%)
General disorders and administration site conditions	2 (2.9%)	1 (2.4%)	3 (2.7%)
Stent-graft endoleak	2 (2.9%)	1 (2.4%)	3 (2.7%)

Table 13. Summary of CEC Adjudicated Procedure-Related Adverse Events			
MedDRA System-Organ Class/Preferred Term Adverse Event	US Cohort (N=68)	Japan Cohort (N=42)	Pivotal (N=110)
Injury, poisoning and procedural complications	1 (1.5%)	1 (2.4%)	2 (1.8%)
Arterial injury	1 (1.5%)	0	1 (0.9%)
Spinal subdural hematoma	0	1 (2.4%)	1 (0.9%)
Investigations	1 (1.5%)	0	1 (0.9%)
Blood creatinine increased	1 (1.5%)	0	1 (0.9%)
Nervous system disorders	2 (2.9%)	4 (9.5%)	6 (5.5%)
Cerebral infarction	0	2 (4.8%)	2 (1.8%)
Cerebrovascular accident	1 (1.5%)	0	1 (0.9%)
Intraventricular hemorrhage	1 (1.5%)	0	1 (0.9%)
Myelomalacia	1 (1.5%)	0	1 (0.9%)
Paraplegia	0	2 (4.8%)	2 (1.8%)
Respiratory, thoracic and mediastinal disorders	2 (2.9%)	0	2 (1.8%)
Acute respiratory failure	1 (1.5%)	0	1 (0.9%)
Pulmonary embolism	1 (1.5%)	0	1 (0.9%)
Vascular disorders	2 (2.9%)	0	2 (1.8%)
Femoral artery dissection	1 (1.5%)	0	1 (0.9%)
Hemorrhage	1 (1.5%)	0	1 (0.9%)
Iliac artery rupture	1 (1.5%)	0	1 (0.9%)

Data is presented as n (%). Includes serious and non-serious adverse events. CEC data. Percentages are based on the number of subjects in the Safety Evaluable Population. Event verbatim terms are reported by sites. The events listed in this table are coded using MedDRA version 21.0 and then stratified by System-Organ Class (SOC) and Preferred Term. Subjects may be counted in this table more than once by Preferred Term but are only counted once in the SOC summary line.

6.4.10. Effectiveness Results

6.4.10.1. Primary Effectiveness

The primary effectiveness endpoint was treatment success through 12-months post implant, defined as a composite of the following:

- Technical success through 24 hours, defined as:
 - Successful delivery of the device through the vasculature;
 - Successful deployment of the device at the intended location;
 - Absence of Type I or III endoleaks;¹
 - Patent stent-graft without significant stenosis (>50%);
- Stent-graft patency
- Absence of aneurysm rupture
- Absence of Type I and III endoleak
- Absence of stent fractures in the attachment zone

¹ *Presumed Type I or III endoleaks observed angiographically at the conclusion of the index procedure shall trigger the performance of a contrast-enhanced computed tomography (CT) or contrast-enhanced magnetic resonance (MR) imaging study prior to discharge. The Primary Effectiveness endpoint will not be triggered without confirmation of the Type I or III endoleak on a pre-discharge contrast CT or contrast MR.

- Absence of open or endovascular secondary interventions related to the device or treated pathology
- Absence of aneurysm expansion (>5 mm diameter increase, compared to the first post-procedural computed tomographic (CT) imaging study)
- Absence of stent-graft migration (>10 mm, compared to the first post-procedural CT imaging study)

The primary effectiveness endpoint of treatment success at 12-months was achieved in 89.2% of the Pivotal Study subjects (74/83, lower 95% CI 81.8%, **Table 14**). The analysis of effectiveness was based on the 83 subjects evaluable for all components of the composite endpoint at the 12-month timepoint. The lower bound of the 95% confidence interval of 81.8% is above the 80% performance goal indicating that the primary effectiveness endpoint was met (P=0.0185).

Table 14. Successful Aneurysm Treatment at 12 Months		
Primary Effectiveness Endpoint	Statistics	Pivotal (N=110)
Successful Aneurysm Treatment at 12 Months	% (n/N)	89.2% (74/83)
	Lower 95% CI	81.8%
	P-Value	0.0185

A total of 9 subjects did not meet the definition of treatment success (7 subjects in the US and 2 in Japan cohorts). Technical success rate (through 24 hours post-procedure) was 100% (107/107). There was successful delivery of the device through the vasculature, successful deployment of the device at the intended location, absence of Type I or III endoleak and patent stent-graft without significant stenosis.

All subjects had stent-graft patency, absence of aneurysm rupture, absence of stent fractures in the attachment zone and absence of stent-graft migration (> 10 mm) reported through 12 months. Absence of Type I or III endoleak through 12 months was reported in 95.3% (82/86) subjects (92.2%, 47/51 in the US and 100.0%, 35/35 in Japan cohorts). Absence of open or endovascular secondary interventions related to the device or treated pathology through 12 months occurred in 94.1% (95/101), and 98.9% (91/92) of subjects had an absence of aneurysm expansion (>5 mm diameter increase) through 12 months, compared to the first post-procedural computed tomographic (CT) imaging study.

Two of the 9 subjects experienced two endpoint events. One of these subjects experienced a Type Ib endoleak at the 1-month follow-up visit, on post-index procedure day 472 a secondary intervention was performed implanting an additional RelayPro stent-graft, successfully excluding the endoleak. The other subject had a Type Ib endoleak identified at the 1-month follow-up visit, a secondary intervention was performed on post-index procedure day 276 implanting an additional RelayPro stent-graft, successfully excluding the endoleak, at the 2-year follow-up visit a Type Ib endoleak was again identified, additional intervention has not occurred to date.

The individual components of the Primary Effectiveness Endpoint is presented in **Table 15**.

A total of 27 subjects were excluded from the primary effectiveness endpoint due to a failure to complete the required assessments to evaluate the 8 components of the primary effectiveness endpoint through 12 months. For the analysis, data for all 8 components had to be present and positive to be declared a success and included in the denominator. If a subject experienced an endpoint failure at any time prior to 12 months, even if complete 12-month data was not present, that subject included as a failure regardless of length of follow-up or complete data availability and included in the denominator. Of the 27 subjects, the reasons for exclusion from the analysis were:

- 16 subjects did not complete the 12-month visit: three subjects were Lost To Follow-Up, five subjects withdrew from the study voluntarily, three subjects missed the visit, one subject exited the study for other reason, one subject exited the study for unknown reason and there were three deaths.

- 11 subjects had incomplete or insufficient 12-month imaging data, resulting in the inability to assess graft patency in eight subjects, and endoleaks in three others

While there is information excluded from the primary effectiveness analysis (as described above), there is at least 81% imaging adequate to assess key endovascular graft parameters through 12-months. This compliance information shows that while there is subject information missing that precludes them from being included in the primary effectiveness analysis, there is adequate data available in the RelayPro pivotal study to evaluate important endovascular graft parameters.

A tipping point analysis was conducted imputing missing data over a range of possible scenarios for the treatment effect; for the primary effectiveness analysis, 27 subjects (83/110) did not have a complete data set collected for the analysis. The sensitivity analysis identified the scenario or 'tipping point' where the treatment effect in subjects with missing data overturned the significant treatment effect obtained in the study population at 6 subjects considered failures; at that point, the success rate was 86.4% (95/110, 95% lower CI 79.8%). In other words, when 6 or more subjects out of the 27 missing data were failures, the study would have failed the primary effectiveness endpoint. Out of the 27 subjects with missing information, 16 subjects had near complete data at 1-year. Of the remaining 11 subjects, 2 subjects have data to suggest they are clinical success; the other 9 subjects have no or limited follow-up information beyond 30-days. The success rate of subjects with no/limited follow-up data would need to be lower (33%) than the calculated success rate (i.e., 86.4%) of the available subject data in order to fail the primary effectiveness endpoint. It should be noted that for effectiveness a sample size of 83 subjects provides greater than 90% power for the primary effectiveness endpoint.

A poolability analysis was completed on the primary effectiveness analysis using a Fisher's exact test of binomial proportions to compare the endpoint across sites, both Japanese and U.S. sites individually as well as pooled Japanese sites as compared to pooled U.S. sites. No significant difference between groups was found.

Table 15. Individual Components of the Composite Primary Effectiveness Endpoint at 12 Months

Endpoint	US Cohort (N=68)	Japan Cohort (N=42)	Pivotal (N=110)
Composite of Technical Success at Procedure	100.0% (66/66)	100.0% (41/41)	100.0% (107/107)
Successful delivery of the device through the vasculature.	100.0% (68/68)	100.0% (42/42)	100.0% (110/110)
Successful deployment of the device at the intended location.	100.0% (68/68)	100.0% (42/42)	100.0% (110/110)
Absence of Type I or III endoleak ^a	100.0% (66/66)	100.0% (41/41)	100.0% (107/107)
Patent stent-graft without significant stenosis	100.0% (68/68)	100.0% (42/42)	100.0% (110/110)
Stent-graft patency through 12 months.*	100.0% (51/51)	100.0% (35/35)	100.0% (86/86)
Absence of aneurysm rupture through 12 months.	100.0% (61/61)	100.0% (40/40)	100.0% (101/101)
Absence of Type I or III endoleak through 12 months.*	92.2% (47/51)	100.0% (35/35)	95.3% (82/86)
Absence of stent fractures in the attachment zone through 12 months.*	100.0% (53/53)	100.0% (40/40)	100.0% (93/93)
Absence of open or endovascular secondary interventions related to the device or treated pathology through 12 months.	93.4% (57/61)	95.0% (38/40)	94.1% (95/101)
Absence of aneurysm expansion (>5 mm diameter increase) through 12 months, compared to the first post-procedural computed tomographic (CT) imaging study.*	98.1% (52/53)	100.0% (39/39)	98.9% (91/92)
Absence of stent-graft migration (> 10 mm) through 12 months, compared to the first post-procedural CT.*	100.0% (53/53)	100.0% (39/39)	100.0% (92/92)

Table 15. Individual Components of the Composite Primary Effectiveness Endpoint at 12 Months

Endpoint	US Cohort (N=68)	Japan Cohort (N=42)	Pivotal (N=110)
*Denominators include subjects that did not meet the endpoint definition or did not fail the endpoint and had evaluable core lab imaging data available through 1 year.			
‡Presumed Type I or III endoleaks observed angiographically at the conclusion of the index procedure shall trigger the performance of a contrast-enhanced CT or contrast-enhanced magnetic resonance (MR) imaging study prior to discharge. The Primary Effectiveness endpoint will not be triggered without confirmation of the Type I or III endoleak on a pre-discharge contrast CT or contrast MR.			

6.4.10.2. Secondary Effectiveness Endpoints

A summary of the secondary effectiveness endpoints is presented in **Table 16**. The data presented are the number of subjects with the event observed during each timepoint.

Intervention Free Technical Success, based on site-reported data was achieved for all enrolled subjects 100%. Although 8 subjects experienced Type II endoleak and 2 subjects experienced Type I endoleak at the end of the procedure, in all cases the treating physician did not perform interventions to treat these events during the procedure. They were monitored at the next follow-up visits and none resulted in reintervention.

For the 30-day follow-up window, 1 Type Ia, 2 Type Ib endoleaks, and 15 Type II endoleaks were Core Laboratory reported. There were 2 lesion-related mortalities. Two secondary interventions related to the device or pathology were performed. There were no instances of rupture or stent fracture. No conversions to open surgery were performed.

For the 6-month follow-up window, two Type Ib endoleaks (both persisting) and 13 Type II endoleaks were reported (11 persisting) by the Core Laboratory. Two subjects had secondary interventions performed to address the device or pathology. There were no instances of lesion-related mortality, rupture, or stent fracture. No conversions to open surgery were performed.

For the 1-year follow-up window, there was 1 new Type Ia endoleak, 1 persisting Type Ib endoleak, and 14 Type II endoleaks (9 persisting) reported by the Core Laboratory. The Core Laboratory reported one new aneurysm enlargement (no persisting). Three secondary interventions related to the device or pathology were performed. There were no instances of lesion-related mortality, rupture, or stent fracture. There were no conversions to open surgery performed.

For the 2-year follow-up window, the Core Laboratory reported 11 Type II endoleaks (6 persisting), 1 Type Ia (new), and 1 Type Ib (new). There were 4 new aneurysm enlargements (none persisting) and 1 secondary intervention related to device/pathology. There were no instances of lesion-related mortality, rupture, stent fracture or conversion to open surgery performed.

For the 3-year follow-up window, there are 4 subjects with data available. The Core Laboratory reported 1 new Type Ia endoleak, 1 Type II endoleak (persisting), and 1 new aneurysm enlargement (not persisting) that was addressed with a secondary intervention. There were no instances of lesion-related mortality, rupture, stent fracture or conversion to open surgery.

Table 16. Secondary effectiveness endpoints

Endpoints	30 Days	6 Months	1 Year	2 Years	Total
Intervention-Free Technical Success	100.0% (110/110)	NA	NA	NA	-
All-cause mortality	1.8% (2/109)	2.0% (2/98)	1.1% (1/92)	7.3% (3/41)	8
Lesion-related mortality (<i>Pro-A</i>)	1.8% (2/109)	0	0	0	2
Rupture	0	0	0	0	0
Migration*	NA	0	0	0	0
All Endoleaks*	17.0% (18/106)	16.7% (15/90)	18.8% (16/85)	31.7% (13/41)	-

Table 16. Secondary effectiveness endpoints					
Endpoints	30 Days	6 Months	1 Year	2 Years	Total
Type Ia	0.9% (1/106)	0	1.2% (1/85)	2.4% (1/41)	3
Type Ib	1.9% (2/106)	2.2% (2/90)	1.2% (1/85)	2.4% (1/41)	2
Type II	14.2% (15/106)	14.4% (13/90)	16.5% (14/85)	26.8% (11/41)	27
Type III	0	0	0	0	0
Type IV	0	0	0	0	0
Aneurysm Enlargement*	NA	0	1.1% (1/92)	8.7% (4/46)	5
Loss of Patency	0	0	0	0	0
Decreased stent-graft lumen diameter	0	0	0	0	0
Fractures*	0	0	0	0	0
Conversion to Open Repair	0	0	0	0	0
Related Secondary Intervention	1.8% (2/109)	2.1% (2/96)	3.3% (3/92)	2.6% (1/39)	8
Thromboembolic event attributed to stent-graft	0	0	0	0	0
Device-Related Adverse Events	11.0% (12/109)	4.2% (4/96)	1.1% (1/92)	15.0% (6/40)	13
Vascular access complications	5.5% (6/110)	NA	NA	NA	6

All values expressed as % (n/N) for endpoints reported within the specified window.
Denominators are specified in **Table 3** (Summary of Compliance and Imaging Follow-Up: Pivotal Study). For imaging endpoints (fractures, migration, endoleak, enlargement), the denominator is the number of subjects with imaging adequate to assess the parameter. For clinical endpoints (patency, conversion to open repair, secondary interventions), the denominator is the number of subjects with visits within the window.
Windows for visits are as follows: 30 days (Day 0-90); 6 months (Day 91-270); 1 year (Day 271-540); 2 years (Day 541-900).
*These data represent Core Laboratory assessed endpoints, including any reports of fracture, migration, endoleak, or aneurysm enlargement within each interval, including observations previously identified at earlier intervals that are considered ongoing or persistent and observations identified during an identified that later resolved within the interval.

6.4.11. Technical Success

Technical success is defined as a successful delivery of the device through the vasculature, successful deployment of the device at the intended location, absence of Type I or III endoleak and a patent stent-graft without significant stenosis through 24 hours post-procedure. Technical success, assessed by site Investigator, was achieved by all subjects in the Pivotal Study.

6.4.12. Device Assessment at Index Procedure

Intervention-Free Technical Success is a composite of multiple enquiries of the implanting investigator subsequent to each RelayPro implant procedure regarding the device usability, functionality and expected response of the user. Intervention Free Technical Success is defined as a composite of the following:

- Successful delivery of the device through the vasculature (deliver the implant to the intended location without the need for unanticipated corrective intervention related to delivery);
- Successful and accurate deployment of the device defined as:
 - deployment of the endovascular stent-graft in the planned location;
 - patency of the endovascular stent-graft, absence of device deformations (e.g. kinks, stent eversion, mal-deployment, misaligned deployment) requiring unplanned placement of an additional device within the endovascular stent-graft, and;
- Successful withdrawal (i.e. successful withdrawal of the delivery system, without the need for unanticipated corrective intervention related to withdrawal)

All subjects had an intervention free technically successful procedure. A summary of Investigator-assessed device performance at

the index procedure are presented in **Table 17**.

Twenty-six (26) of 110 (23.6%) subjects had additional procedures performed during the RelayPro Stent-Graft procedure. Of the 26 subjects who underwent additional procedures, the majority of the subjects (65.4%, 17/26) had an LSA Revascularization prior to the RelayPro index procedure, 34.6% (9/26) had a Balloon Dilation, 11.5% (3/26) Native Vessel PTA, 3.8% (1/26) had a Stent Placement (right iliac artery and right superficial femoral artery), and 23.1% (6/26) had 'Other' procedures.

Of the 110 subjects treated with the RelayPro Stent-Graft System, 98.2% (108/110) had a positive Final Procedure Result; the lesion was excluded without a Type I, III or IV Endoleak; Conversion to Surgery; or Procedure Attempted, but Aborted. Two (2) subjects had the Lesion Excluded with a site detected Type IV Endoleak reported as not resolved during the procedure. The Core Lab did not identify the Type IV Endoleaks. The site-reported Type IV Endoleak in one of these subjects was not visualized on the Intra-Procedure Angiogram or any post implant imaging (1 and 6 month). In the second subject the Core Laboratory classified the site-reported Type IV Endoleak as a Type II Endoleak Intra-Procedure and at 1-month post implant, and not seen on 6 month post implant imaging.

One subject had an overall successful procedure with the Final Procedure Result as Lesion Excluded as reported by the site, with a Core Laboratory identified Type IV Endoleak that resolved prior to the 1-month follow-up imaging.

Device Assessment by Investigator*	US Cohort (N=68)	Japan Cohort (N=42)	Pivotal (N=110)
Deployment at the Intended Location	100.0% (68)	100.0% (42)	100.0% (110)
Deployment Without Kinking or Twisting	100.0% (68)	100.0% (42)	100.0% (110)
Accuracy of Deployment Acceptable	100.0% (68)	100.0% (42)	100.0% (110)
Stent-Graft Patent	100.0% (68)	100.0% (42)	100.0% (110)
Stent-Graft Integrity (no wire fracture)	100.0% (68)	100.0% (42)	100.0% (110)
Procedure Performed Without Any Unplanned Vascular Access Difficulties	91.2% (62)	100.0% (42)	94.5% (104)
Additional procedures required:	30.9% (21)	11.9% (5)	23.6% (26) ^b
Balloon Dilation	28.6% (6/21)	60.0% (3/5)	34.6% (9/26)
Stent Placement	4.8% (1/21)	0% (0/5)	3.8% (1/26) ^a
Native Vessel PTA	9.5% (2/21)	20.0% (1/5)	11.5% (3/26)
Other ^c	28.6% (6/21)	0% (0/5)	23.1% (6/26)
LSA Revascularized	61.9% (13/21)	80.0% (4/5)	65.4% (17/26)
Pre-implant	100.0% (13/13)	100.0% (4/4)	100.0% (17/17)
Proximal end of the covered portion of the device:			
Distal to the Left Subclavian	73.5% (50)	85.7% (36)	78.2% (86)
Proximal to the Left Subclavian	26.5% (18)	14.3% (6)	21.8% (24)
Final Procedure Result			
Lesion Excluded	89.7% (61)	92.9% (39)	90.9% (100)
Type I, III or IV Endoleak**	0	4.8% (2)	1.8% (2)
Type II Endoleak	10.3% (7)	2.4% (1)	7.3% (8)
Site reported data.			
All values expressed as % (n). The denominator is included at the top of the respective column, unless otherwise indicated.			
*The device assessment was performed at the time of the procedure.			
**Only Type IV endoleaks were observed.			
^a Subject had stent placement at right iliac artery and right superficial femoral artery.			
^b Eight (8) subjects had more than one additional procedure required: 3 subjects had Balloon Dilation at Stent-Graft/LSA Revascularized; 2 subjects had Stent Placement/Native Vessel PTA/LSA Revascularized; 2 subjects had LSA Revascularized/Other and 1 subject had Balloon Dilation at Stent-Graft/Native Vessel PTA/Other.			
^c Six (6) subjects had additional procedures performed classified as 'Other'. These included 1 subject with a LCA/LSA bypass, 1 subject with a right femoral artery repair secondary to Perclose failure, 1 subject with a right femoral cutdown with pericardial patch, 1 subject with a serial dilatation, 1 subject with an LSA embolization and 1 subject with a left CFA patch angioplasty.			

6.4.13. Aneurysm Rupture

Aneurysm rupture is defined as rupture of the native aneurysm sac post-implantation of the stent-graft. There have been no reported aneurysm ruptures in this study.

6.4.14. Migration

The protocol defines device migration as a displacement of 10 mm or more relative to the 1-month location, as measured by the Core Laboratory. There have been no Core Laboratory reported instances of migration, proximal or distal, or stent-graft component separation in any subject.

There has been one site-reported proximal migration at the 6-month visit in a US subject, resulting in a secondary intervention where an additional RelayPro (proximal bare stent configuration) was implanted proximally. The secondary intervention was adequate to address the migration (as observed on the 12-month and 2-year visit).

6.4.15. Endoleaks

Table 18. Summary of Core Laboratory-Reported Endoleaks presents the Core Laboratory reported endoleaks observed at each follow-up interval. Six (6) subjects experienced a Type I endoleak during follow-up; 3 endoleaks were Type Ia and 3 Type Ib; all but one Type Ia endoleak were within the US cohort. One Type Ia endoleak was observed at both the 1 month follow-up visit and during an unscheduled follow-up visit (approximately 3 months post index procedure). However, the subject expired from non-aneurysm related pathology before any re-intervention could be performed. The second subject with a Type Ia endoleak had the endoleak observed on 12-month imaging with no aneurysm expansion. On post-index procedure day 538, a secondary intervention was performed to address an aortic ulceration of the arch implanting a TEVAR device in zone zero using the snorkel technique. The aortic ulcer was successfully excluded and subsequent CT imaging has confirmed resolution of the Type Ia endoleak. The third subject with a Type Ia endoleak was observed on 2-year imaging and no aneurysm expansion was observed. On day 791 post-index procedure, the subject had a TEVAR device implanted at the level of the left subclavian artery.

Two subjects experienced a Type Ib endoleak as identified by the Core Laboratory at the 30-day follow-up visit and each underwent a secondary intervention where an additional RelayPro device was implanted to successfully resolve the Type Ib endoleak. Subsequent to the secondary intervention, the Core Laboratory identified a second Type Ib endoleak in one subject at the 2 year follow-up visit. In this same subject, the Core Lab noted secondary procedure after the 6-month follow-up visit and that the Type Ib endoleak resolved. No further intervention has occurred as of the data lock.

Twenty-seven (27) subjects have been identified with a Type II endoleak, 15 were identified by the Core Laboratory on the 30-day follow-up imaging, 13 on the 6-month follow-up imaging (2 new and 11 persistent); 14 on the 12-month follow-up imaging (5 new and 9 persistent); 11 on the 2-year follow-up imaging (5 new and 6 persistent); and 1 persistent on the 3-year follow-up imaging. Two secondary interventions have been performed to address a Type II endoleak: 1) coil embolization procedure of the proximal left subclavian artery at 9 days post-index procedure and 2) extension of TEVAR into the abdominal aorta with parallel grafts into the SMA and renal arteries and coverage of the celiac artery at 1174 days post-index procedure. For both subjects, the 1-month, 6-month and 12-month follow-up visits were completed. The Core Lab also confirmed continuation of the Type II endoleak preceding the interventions.

No Type III endoleaks, Type IV endoleaks, or endoleaks of unknown type were reported.

Table 18. Summary of Core Laboratory-Reported Endoleaks					
Endoleak	30 Days	6 Months	12 Months	2 Years	Total
Adequate Imaging*	106	90	85	41	-
Any Endoleaks (Total)	17.0% (18)	16.7% (15)	18.8% (16)	31.7% (13)	33
Type Ia					
New	1	0	1	1	3
Persistent	NA	0	0	0	-
New and Persistent	0.9% (1)	0	1.2% (1)	2.4% (1)	-

Table 18. Summary of Core Laboratory-Reported Endoleaks					
Endoleak	30 Days	6 Months	12 Months	2 Years	Total
Type Ib					
New	2	0	0	1	2
Persistent	NA	2	1	0	-
New and Persistent	1.9% (2)	2.2% (2)	1.2% (1)	2.4% (1)	-
Type II					
New	15	2	5	5	27
Persistent	NA	11	9	6	-
New and Persistent	14.2% (15)	14.4% (13)	16.5% (14)	26.8% (11)	-
Type IIIa					
New	0	0	0	0	0
Persistent	NA	0	0	0	-
New and Persistent	0	0	0	0	-
Type IIIb					
New	0	0	0	0	0
Persistent	NA	0	0	0	-
New and Persistent	0	0	0	0	-
Type IV					
New	0	0	0	0	0
Persistent	NA	0	0	0	-
New and Persistent	0	0	0	0	-
Unknown Type					
New	0	0	0	0	0
Persistent	NA	0	0	0	-
New and Persistent	0	0	0	0	-

*Adequate imaging was determined by the Core Laboratory. In general, images with contrast and non-contrast series were regarded as adequate for interpretation of endoleaks.

6.4.16. Aneurysm Size Change

An increase in aneurysm sac size was defined as a change of 5 mm or more in diameter from the 1-month diameter measurement or the first post implant imaging. These assessments are based on Core Lab measurements. As summarized in **Table 19**, in the Pivotal Study, 97 subjects have images at the 6-month follow-up which have been adequate to assess aneurysm diameter, 92 at the 12-month follow-up, and 46 at the 2-year follow-up and 4 at the 3-year follow-up. Six subjects have been reported to have aneurysm enlargement, 1 newly identified on the 1 year follow-up imaging, 4 newly identified on the 2-year follow-up imaging, and 1 newly identified at 3-year follow-up imaging.

Three US subjects have been reported to have aneurysm enlargement, 1 newly identified on the 1 year follow-up imaging, 1 newly identified on the 2-year follow-up imaging, and 1 newly identified at 3 year follow-up imaging. Two of the three subjects with enlargement had baseline lesions that were fusiform aneurysms, and the third had been treated for a saccular aneurysm at the index procedure. Of these three subjects, 1 enlargement was due to a Type II endoleak, 1 was attributed to worsening of proximal aortic disease requiring a full arch repair, and the third subject (with saccular aneurysm) experienced an enlargement due to unknown cause.

Three Japan subjects have been reported to have aneurysm enlargement, all three newly identified on the 2-year follow-up imaging. Of these three subjects with enlargement, two had baseline lesions that were fusiform aneurysms and the third had been treated for a saccular aneurysm at the index procedure. Two enlargements were due to a Type II endoleak identified by the Core Lab while the site reported Type Ia endoleak and one was attributed to a site reported Type Ia endoleak.

The incidence of subjects with decrease in aneurysm sac diameter was 16.7% (16/96), 33.7% (31/92), 34.8% (16/46) and 0.0% (0/4) at 6 months, 12 months, 2 years, and 3 years, respectively, when compared to the first post implant imaging.

Changes in Aneurysm Size	6 Months	12 months	2 Years	Total
Imaging Adequate to Assess Diameter Change (N)	97	92	46	-
Increase > 5mm				
New	0	1.1% (1)	8.7% (4)	5
Persistent	0	0	0	-
Total	0	1.1% (1)	8.7% (4)	-
Decrease	16.7% (16)	33.7% (31)	34.8% (16)	-
No Change	83.3% (80)	65.2% (60)	56.5% (26)	-
Core Laboratory data. All values expressed as % (n), where n = Subjects with evaluable images at 30 days (based on first procedure measurement made within 30 day follow up analytical window) and at time point (e.g. 6 or 12 months) and N = Subjects evaluable at time point.				

6.4.17. Stent-Graft Integrity

Stent fracture was defined as fracture or breakage of any portion of the stent. Fractures are assessed by the Core Laboratory with x-ray and CT imaging, or may be reported by the site. For the Pivotal Study cohort, 107 subjects had adequate imaging to assess for fracture at 30-days, 97 subjects at 6-months, 93 subjects at 1 year, 46 subjects at 2-years, and 4 subject at 3-years. No fractures (site reported or Core Laboratory reported) have been reported in any subject at any follow-up visit.

6.4.18. Stent-Graft Patency-Related Events

Loss of patency is defined within the study protocol as the unintentional obstruction of 100% of the stent-graft lumen. There have been no Core Laboratory or site-reported stent-graft occlusions reported in any subject at any timepoint.

6.4.19. Conversion to Open Surgery

There were no open surgical conversions in the study.

6.4.20. Secondary Interventions

A summary of the reasons for secondary interventions are shown in **Table 20**. There have been a total of 11 secondary interventions performed in 9 subjects through 3 years. In summary, 3 interventions were performed to address site reported Type Ia endoleaks (Core Laboratory reported Type II), 2 to address site and Core Laboratory identified Type Ib endoleaks, 1 to address a site and Core Laboratory reported Type II endoleak, 1 to address site-reported migration, 1 to address a site and Core Laboratory reported Type I endoleak with site reported migration (Core Laboratory reported thoracic aorta lengthening, no migration) and 3 interventions within the same subject to address arch disease, Type Ib endoleak and a Type II endoleak.

	30 Days	6 Months	1 Year	2 Years	Total
Subjects at Risk (N)	109	96	92	38	-
Interventions (n)	2	2	3	1	8
Any Secondary Intervention	1.8% (2)	2.1% (2)	3.3% (3)	2.6% (1)	8*
Type Ia Endoleak	0.9% (1)	1.0% (1)	1.1% (1)	2.6% (1)	-

Table 20. Summary of Reasons for Secondary Intervention					
	30 Days	6 Months	1 Year	2 Years	Total
Extension	1	1	1	1	-
Type Ib Endoleak	0	0	2.2% (2)	0	-
Extension	0	0	2	0	-
Type II Endoleak	0.9% (1)	0	0	0	-
Coil Embolization	1	0	0	0	-
Migration	0	1.0% (1)	0	2.6% (1)	-
Extension	0	1	0	0	-

Where % (n), % is the percentage of subjects with an event, n is number of subjects with an event and N is the number of subjects with visits in the specified window.
 Windows for visits are as follows: 30 days (Day 0-90); 6 months (Day 91-270); 1 year (Day 271-540); 2 years (Day 541-900)
 *The totals were included for number of interventions and subjects with an intervention. Because there could be multiple reasons for an intervention, the totals were not included for the remaining rows.

6.4.21. Thromboembolic Events

All intra-vascular implants have the potential for triggering the coagulation cascade, and therefore pose the risk for serving as a nidus for thrombus formation. A multitude of mechanical and physiologic factors contribute to this risk: while high velocity and high volume of blood flow and the large vessel diameter decrease the risk of thrombus formation within aortic endografts as compared to more peripheral stent-grafts, thromboembolic events are a known potential complication of TEVAR. Three subjects with possible thromboembolic events were identified to have occurred within 30 days of RelayPro implant.

The Medical Monitor and Clinical Events Committee (CEC) assessed all three events to be procedure-related but not device-related. There was no evidence of the possible thromboembolic event being related to the delivery system in any of these cases. In the case of the earliest event, only one device was used (therefore, only one delivery system), and the procedure was not considered prolonged, with no additional procedures.

6.4.22. Vascular access complications at the index procedure

Vascular access complications are injuries to vessels as a result of the endovascular procedure, including dissections, perforations, iliac thromboses, common femoral artery injuries not related to pre-existing disease, false or true aneurysms. Six of the 110 subjects (5.5%) experienced vascular access complications at the index procedure as reported by the sites. These vascular access complications included 1 subject with LSA/LCA by-pass performed resulted in a neck hematoma that was addressed with re-exploration and evacuation, 1 subject with a right femoral artery dissection secondary to Perclose failure that was repaired, 1 subject with a right femoral artery laceration secondary to Perclose failure that was addressed by right femoral cutdown and pericardial patch, 1 subject with right femoral and left common femoral artery injury that was addressed with serial dilatation, 1 subject with a left CFA patch angioplasty, and 1 subject with a right iliac artery rupture and 1 dissection of the right SFA.

6.5. SUB-GROUP ANALYSES

The following preoperative characteristics were evaluated for potential association with outcomes: gender, race, baseline lesion type (i.e., fusiform, non-fusiform aneurysm), and geography of enrollment (i.e., US, Japan). There were no statistically significant differences in the primary endpoints for any subgroup analyses.

In the pivotal study, 68 US subjects and 42 Japanese subjects were enrolled. The demographics, comorbidities, and baseline lesion characteristics, as well as outcomes reported in each cohort are presented in detail in each of the respective sections above. Regarding primary safety and effectiveness outcomes, the following were reported:

- A total of 6.4% (7/110) subjects experienced an MAE through 30 days; 5.9% (4/68) in the US and 7.1% (3/42) in

Japan. A total of 7 MAEs were observed in these 7 subjects. The MAEs reported include: 2 strokes, 1 renal failure, 2 paralysis, and 2 procedural blood loss > 1,000 cc requiring transfusion. The two paralysis events and one stroke event occurred in 3 subjects within the Japan cohort. All other events occurred in the US cohort.

- The primary effectiveness endpoint of treatment success at 12-months was achieved in 89.2% of the Pivotal Study subjects (74/83, lower 95% CI 81.8%) and varied slightly between geography (85.7%, 42/49 in US cohort, 94.1%, 32/34 in Japanese cohort).

6.6. ADDITIONAL FOLLOW-UP DATA

Between 7 December 2020 and 10 March 2021, 17 subjects have returned for follow-up visits; 13 subjects have completed the 2-year follow-up, 3 subjects have completed 3-year follow-up and 1 subject has completed 4-year follow-up. Since 7 December 2020, there have been no deaths, no secondary interventions, no open surgical conversion, no aneurysm rupture as well as no Core Lab reports of endoleak, migration, fracture, occlusion or aneurysm expansion.

7. SUMMARY OF TRAUMATIC AORTIC INJURY CLINICAL STUDY

7.1. INTRODUCTION

The primary objective of the pivotal study was to evaluate the safety and effectiveness of the **RelayPro THORACIC STENT-GRAFT SYSTEM** in subjects with traumatic aortic injury in the descending thoracic aorta (referred to as the Pro-T study). The study was a multi-center, prospective, single-arm, non-randomized, and non-blinded investigation. Fifty (50) US subjects were treated between November 3, 2017 and June 13, 2021 at 16 US investigational sites. Subjects are being followed at 1 month, 6 months, 12-months, and annually thereafter for 5-years.

7.2. ENDPOINTS

7.2.1. Primary Endpoint

The primary endpoint is all-cause mortality at 30-days post-procedure.

This is not a hypothesis-driven study. The primary analysis was performed on all enrolled subjects and is summarized with a two-sided 95% CI and compared to an expected rate of 8%.

7.2.2. Sample Size

The sample size for **RelayPro THORACIC STENT-GRAFT SYSTEM** Pivotal Study is 50 subjects.

The sample size of 50 subjects is based upon the desire to obtain a specific level of precision around the estimated 30-day all-cause mortality rate, where precision is defined as the half-width of a 95% confidence interval. Based on an expected incidence rate of 8% for all-cause mortality, the exact two-sided 95% confidence interval for a sample of 50 subjects spans from 2.2% to 19.2%. Based on the calculated bounds of 2.2% to 19.2%, the width is 17%; so the precision (confidence interval half-width) is 8.5%. The sample size is also consistent with the pivotal study of other endovascular grafts intended to support the blunt traumatic aortic injury indication.

7.2.3. Secondary Endpoints

At the index procedure:

- Successful device delivery, deployment including withdrawal of the delivery system
- Vascular access complications

Through 1 month, 6 months, 12 months, and annually through 5 years

- Aortic-related death
- Major adverse events (stroke and paralysis)
- Aortic rupture
- Secondary interventions (open or endovascular) to treat malperfusion, rupture, aneurysm formation, or aortic expansion
- Endoleaks (evaluated individually)
- Loss of stent-graft patency
- Stent fractures in the attachment zone
- Compression
- Erosion
- Extrusion
- Endograft infection

At 6-months, 12 months, and annually through 5 years, compared to the first post-procedural CT;

- Aortic dilation (> 5 mm)
- Stent migration (>10 mm)

Through 6-months, 12 months, and annually through 5 years;

- All adverse events
- All-cause mortality

7.3. SUBJECTS

Subjects enrolled in the Pivotal Study met the following criteria:

- Age ≥18 years.
- Have a traumatic injury of the descending thoracic aorta (confirmed by CTA or MRA) that occurred no more than 30 days prior to the planned stent implant procedure.
- Proximal and distal landing zones with diameter between 19 mm and 42 mm.
- Anatomy meeting all of the following anatomical criteria:
 - Proximal landing zone distal to the left common carotid and a distal landing zone proximal to the origin of the celiac artery; the length of the landing zones will depend on the intended stent graft diameter.
 - The length of the proximal landing zone depends on the intended stent graft diameter and should be:
 - 15 mm for 22–28 mm grafts with bare stent (20 mm for RelayPro NBS).
 - 20 mm for 30–46 mm grafts with bare stent (25 mm for RelayPro NBS).
 - The distal landing zone should be 20 mm for all RelayPro grafts.
 - Coverage of the left subclavian artery is permitted with mandatory revascularization if patent left internal mammary artery (LIMA) bypass or left upper extremity (LUE) AV graft or anomalous vertebral artery off the aorta.
- Proximal and distal landing zones containing a straight segment (non-tapered, non- reverse-tapered, defined by <10% diameter change) with lengths equal to or greater than the required attachment length for the intended device.
- Adequate iliac or femoral artery access for introduction of the RelayPro delivery system. Alternative methods to gain proper access may be utilized (e.g., iliac conduit).
- Patient willing to comply with the follow-up evaluation schedule.
- Patient (or Legally Authorized Representative, LAR) agrees to sign an Informed Consent Form prior to treatment

Subjects were excluded if they had any of the follow anatomic or physiologic characteristics:

- Significant stenosis, calcification, thrombus, or tortuosity of intended fixation sites that would compromise fixation or seal of the device.
- Planned coverage of left carotid or celiac arteries; or anatomic variants that may compromise circulation to the carotid, vertebral, or innominate arteries after device placement, and are not amenable to subclavian revascularization.
- Prior endovascular or surgical repair in the DTA. The device may not be placed within any prior endovascular or surgical graft.
- Concomitant aneurysm/disease of the ascending aorta, aortic arch, or abdominal, aorta requiring repair.
- Prior abdominal aortic aneurysm repair (endovascular or surgical) that was performed less than 6 months prior to the planned stent implant procedure.
- Untreatable allergy or sensitivity to contrast media or device components.
- Known or suspected connective tissue disorder.
- Blood coagulation disorder or bleeding diathesis for which the treatment cannot be suspended for one week pre-and/or post-repair.
- Coronary artery disease with unstable angina.
- Severe congestive heart failure (New York Heart Association functional class IV).
- Stroke and/or MI within 3 months of the planned treatment date.
- Pulmonary disease requiring the routine (daily or nightly) need for oxygen therapy outside the hospital setting.

- Acute renal failure (not associated with the aortic traumatic injury) or chronic renal insufficiency, and not receiving dialysis.
- Hemodynamically unstable.
- Active systemic infection and/or mycotic aneurysm.
- Morbid obesity or other condition that may compromise or prevent the necessary imaging requirements.
- Injury Severity Score of 75.
- Less than two-year life expectancy.
- Current or planned participation in an investigational drug or device study that has not completed primary endpoint evaluation.
- Currently pregnant or planning to become pregnant during the course of the study.
- Medical, social, or psychological issues that Investigator believes may interfere with treatment or follow-up.

All subjects enrolled in the Pivotal Study met the selection criteria based on site-reported imaging measurements.

7.4. PRO-T STUDY RESULTS

7.4.1. Subject Accountability and Follow-up

At the time of database freeze, of 50 subjects enrolled in the Pro-T study, all 50 subjects were implanted with the RelayPro Stent-Graft System and 49 were seen through discharge (one early mortality). Forty-eight (of 49) eligible subjects (98%) had a 30-day visit with at least 98% of subjects with adequate imaging to address endovascular parameters. Thirty-nine (of 49) eligible subjects (79.6%) had a 6-month visit with at least 69.4% of subjects with imaging adequate to address endovascular parameters. At the 12-month visit, 40 of 49 eligible subjects (81.6%) had a visit performed with 73.5% with adequate imaging to assess endovascular parameters.

At 2-years, 29 of 47 eligible subjects (61.7%) had visit performed with 9 subjects (19.1%) still in window. At 3-years, 11 of 32 eligible subjects have completed the follow-up visit with 16 subjects (50%) still in window. At 4-years, 2 of 13 eligible subjects have completed the follow-up visit with 11 subjects (84.6%) still in window. Three subjects are now eligible for the 5-year visit; however, these visits have not yet been performed as of the data freeze. Compliance and imaging follow-up are provided in **Table 21** below.

Analysis Window	Subject Follow-Up				Imaging		Imaging Adequate †				Events Within Window‡				
	Eligible for Visit**	Visit Performed	No Visit*	Still in Window	CT Scan	X-Ray	Diameter	Endoleak	Migration	Fracture	Death	Lost to follow-up	Early Withdrawal	Not Yet Due	Subjects with ≥1 Element
Procedure	50	NA	NA	NA	NA	NA	NA	NA	NA	NA	1	0	0	0	1
30 Days	49	98% (48/49)	2% (1/49)	0	98% (48/49)	95.9% (47/49)	98% (48/49)	98% (48/49)	98% (48/49)	98% (48/49)	0	0	0	0	0
6 Months	49	79.6% (39/49)	20.4% (10/49)	0	73.5% (36/49)	65.3% (32/49)	71.4% (35/49)	69.4% (34/49)	73.5% (36/49)	73.5% (36/49)	0	0	0	0	0
12 Months	49	81.6% (40/49)	18.4% (9/49)	0	75.5% (37/49)	69.4% (34/49)	75.5% (37/49)	73.5% (36/49)	75.5% (37/49)	75.5% (37/49)	0	2	0	0	2
2 Years	47	61.7% (29/47)	38.3% (18/47)	19.1% (9/47)	55.3% (26/47)	51.1% (24/47)	55.3% (26/47)	55.3% (26/47)	55.3% (26/47)	57.4% (27/47)#	0	0	1	14	15

Table 21. Summary of Compliance and Core Lab Imaging Follow-Up (Pro-T)

Analysis Window	Subject Follow-Up				Imaging		Imaging Adequate †				Events Within Window‡				
	Eligible for Visit**	Visit Performed	No Visit*	Still in Window	CT Scan	X-Ray	Diameter	Endoleak	Migration	Fracture	Death	Lost to follow-up	Early Withdrawal	Not Yet Due	Subjects with ≥1 Element
3 Years	32	34.4% (11/32)	62.6% (21/32)	50.0% (16/32)	31.3% (10/32)	31.3% (10/32)	31.3% (10/32)	31.3% (10/32)	31.3% (10/32)	31.3% (10/32)	0	2	0	17	19
4 Years	13	15.4% (2/13)	84.6% (11/13)	76.9% (10/13)	15.4% (2/13)	15.4% (2/13)	15.4% (2/13)	15.4% (2/13)	15.4% (2/13)	15.4% (2/13)	0	0	0	10	10

Note: Subjects may have a visit completed and/or imaging completed; they are independent fields.
 NA, Not Applicable
 * Subjects who did not have a visit within the window or subjects who did not have a visit but have not yet reached the end of the analysis window.
 ** This value is used for the denominator for calculating the percentage of visits performed and the imaging adequate to assess each endovascular graft parameter.
 † Aortic Diameter and Migration assessments use 1 month as baseline. Eligible subjects require valid value at 1 month and at the specified time point.
 ‡ These columns reflect subjects who had visits within the specified window but were not eligible at the start of the next window due to death, surgical conversion or early withdrawal.
 # The number of subjects with imaging adequate to assess fracture is higher than the number of CT Scans or x-rays performed because one subject had an X-ray available but no CT Scan. This imaging was determined by the Core Laboratory to be adequate to assess fracture.

7.4.2. Subject Demographics

As is typical in a BTAI population, subjects were mostly male (74.0%, 37/50) and young (mean age of 42.4 ± 17.2 years); most subjects were white (66%, 33/50) and non-Hispanic (86.0%, 43/50).

Table 22: Pro-T Subject Demographics		Pro-T N=50
Characteristic		
Male		37 (74.0%)
Female		13 (26.0%)
Age (years)	Mean (±SD)	42.4 (±17.2)
	Median (IQR)	39 (30)
	Min - Max	19 – 76
Age Group (years)	18—64	43 (86.0%)
	65—74	6 (12.0%)
	≥75	1 (2.0%)
Ethnic Group		
Not Hispanic/Latino		43 (86.0%)
Hispanic/Latino		4 (8.0%)
Unknown		2 (4.0%)
Not Reported		1 (2.0%)
Race		
White		33 (66.0%)
Black		14 (28.0%)
Unknown		2 (4.0%)
Other		1 (2.0%)

Data are n (%) unless specified otherwise. IQR, interquartile range; SD, standard deviation.
Site reported data.

7.4.3. Baseline Medical History

Due to the relatively young age of the majority of the subjects, few have significant medical history but comorbidities include hypertension (26.0%, 13/50) and a history of smoking (36.0%, 18/50).

Table 23: Pro-T Subject Comorbidities		Pro-T N=50
Comorbidity or Medical History		
History of Smoking		18 (36.0%)
Current smoker		11 (22.0%)
Hypertension (treated or untreated)		13 (26.0%)
Coronary artery disease		7 (14.0%)
Myocardial infarction		4 (8.0%)
Arrhythmias		3 (6.0%)
Congestive heart failure		2 (4.0%)
Angina (stable or unstable)		0

Table 23: Pro-T Subject Comorbidities	
Comorbidity or Medical History	Pro-T N=50
Gastrointestinal complications	6 (12.0%)
Gastroesophageal reflux disease (GERD)	4 (8.0%)
Adynamic ileus	1 (2.0%)
Other	1 (2.0%)
Current antiplatelet/anticoagulant medication	6 (12.0%)
Hypercholesterolemia	5 (10.0%)
Diabetes mellitus	4 (8.0%)
Renal insufficiency	1 (2.0%)
Impotence (males only, n=37)	1 (2.7%)
Peripheral vascular disease	0
Limb ischemia	0
Vascular intervention	0
All values expressed as n (%). Site reported data.	

7.4.4. Baseline Vessel Measurements

The baseline lesion characteristics for the subjects enrolled in the study are presented in **Table 24**. The mechanism of injury in the majority of subjects was an automobile accident (66.0%, 33/50) with the location of aortic injury being the aortic isthmus (82.0%, 41/50) and extent of aortic injury of Grade 3 (76.0%, 38/50) as reported by the site.

Seventy-six percent of subjects (76%, 38/50) presented with a Grade 3 injury and 12% (6/50) with Grade 4 [and only 12% (6/50) with Grade 1 or 2] as reported by the site, whereas Core Laboratory reported 60% (30/50) Grade 3 and 14% (7/50) Grade 4 [and 26% (13/50) Grade 1 or 2]. The Injury Severity Score (ISS) is an anatomical scoring system that provides an overall score for subjects with multiple injuries with values from 0 to 75; a score of 1 represents a minor injury and a score of 75 represents a fatal injury. Mean (\pm SD) ISS was 30.2 (\pm 16.3); median (IQR) was 29 (\pm 23).

The mean treatment length was 44 (\pm 39.6) mm. Baseline anatomical measurements, as well as access vessel characteristics of the study population, were reported by both the Core Laboratory and the site.

As to be expected in this younger population with relatively few comorbidities, the aortic anatomy was complex only in terms of small access. The minimum access vessel diameters were similar in both assessments: a mean 8.3 (\pm 1.3) mm according to the sites and broken down per artery by the Core Laboratory: 7.9 (\pm 1.6) mm and 7.8 (\pm 1.7) mm respectively for the left and right femoral arteries; 9.4 (\pm 1.8) mm and 9.6 (\pm 1.9) mm respectively for the left and right common iliac arteries; 7.6 (\pm 1.7) mm and 7.5 (\pm 1.8) mm respectively for the left and right external iliac arteries. Otherwise, the mean index of iliac tortuosity was 1.1 (\pm 0.1) or absent according to the index ($T < 1.05$, absent; $1.05 < T < 1.15$, mild; $1.15 < T < 1.2$, moderate; $T > 1.2$, severe). Most subjects had no calcification with a minority (12–18%) having mild or moderate in the respective vessels and none with severe.

Table 24: Baseline Lesion Characteristics (Pro-T)

Characteristic	Site reported	Core Laboratory reported
Mechanism of injury		
Automobile accident	33 (66.0%)	
Motorcycle accident	7 (14.0%)	
Fall	5 (10.0%)	
Other traumatic mechanism	4 (8.0%)	
Pedestrian injury from a motor vehicle	1 (2.0%)	
Location of the aortic injury*		
Aortic isthmus (distal to LSA)	41 (82.0%)	
Distal DTA	9 (18.0%)	
Extent of aortic injury		
Grade 1	2 (4.0%)	4 (8.0%)
Grade 2	4 (8.0%)	9 (18.0%)
Grade 3	38 (76.0%)	30 (60.0%)
Grade 4	6 (12.0%)	7 (14.0%)
Injury severity score (ISS)		
Mean (\pm SD)	30.3 (\pm 16.3)	
Median (Min, Max)	29 (2, 66)	
Common origin BCT/LCCA (Bovine Arch)		13 (26.0%)
Intimal tear		
Associated with aortic false aneurysm	28 (56.0%)	
Associated with intramural hematoma	12 (24.0%)	
Alone	6 (12.0%)	
Associated with free rupture	3 (6.0%)	
Length measurements		
From LCCA to intimal tear (mm)		
Mean (\pm SD)		41.0 (\pm 39.3)
Median (Min, Max)		31.8 (3.1, 218.0)
Proximal aortic neck (mm)		
Mean (\pm SD)	26.8 (\pm 26.6)	
Median (Min, Max)	22.3 (13.0, 208.0)	
Distal aortic neck (mm)		
Mean (\pm SD)	41.1 (\pm 25.9)	
Median (Min, Max)	39.5 (0, 150.0)	
Treatment total (mm)		
Mean (\pm SD)	44.0 (\pm 39.6)	(n=48) 83.2 (\pm 28.0)
Median (Min, Max)	26.0 (10.0, 200.0)	73.0 (62.8, 209.0)
Diameter measurements		
Aorta at LCCA (mm)		
Mean (\pm SD)		26.5 (\pm 3.6)
Median (Min, Max)		26.9 (19.1, 33.4)
Aorta at LSA (mm)		
Mean (\pm SD)		25.0 (\pm 3.9)
Median (Min, Max)		24.7 (18.1, 35.0)
Maximum thoracic aorta (mm)		
Mean (\pm SD)		30.0 (\pm 5.9)
Median (Min, Max)		28.6 (20.3, 54.3)
Superior proximal neck (mm)		
Mean (\pm SD)	24.7 (\pm 3.6)	

Table 24: Baseline Lesion Characteristics (Pro-T)		
Characteristic	Site reported	Core Laboratory reported
Inferior proximal neck (mm)	Median (Min, Max)	24.45 (17.4, 33)
	Mean (\pm SD)	24.0 (\pm 3.5)
	Median (Min, Max)	23.7 (18.1, 33.0)
Superior distal neck (mm)	Mean (\pm SD)	22.8 (\pm 4.1)
	Median (Min, Max)	22.0 (17.0, 35.0)
	Mean (\pm SD)	22.3 (\pm 4.0)
Inferior distal neck (mm)	Median (Min, Max)	21.7 (14.3, 34.0)
	Mean (\pm SD)	
	Median (Min, Max)	
Access vessel diameters		
Minimum access vessel (mm)	Mean (\pm SD)	8.3 (\pm 1.3)
	Median (Min, Max)	8.0 (5.7, 11.0)
	Mean (\pm SD)	
Left femoral artery (mm)	Median (Min, Max)	
	Mean (\pm SD)	7.9 (\pm 1.6)
	Median (Min, Max)	7.9 (5.1, 11.1)
Right femoral artery (mm)	Mean (\pm SD)	7.8 (\pm 1.7)
	Median (Min, Max)	7.9 (4.1, 10.7)
	Mean (\pm SD)	
Left common iliac artery (mm)	Median (Min, Max)	
	Mean (\pm SD)	9.4 (\pm 1.8)
	Median (Min, Max)	9.5 (5.9, 12.8)
Right common iliac artery (mm)	Mean (\pm SD)	9.6 (\pm 1.9)
	Median (Min, Max)	9.7 (5.8, 13.5)
	Mean (\pm SD)	
Left external iliac artery (mm)	Median (Min, Max)	
	Mean (\pm SD)	7.6 (\pm 1.7)
	Median (Min, Max)	7.8 (4.0, 11.1)
Right external iliac artery (mm)	Mean (\pm SD)	7.5 (\pm 1.8)
	Median (Min, Max)	7.5 (2.5, 11.5)
	Mean (\pm SD)	
Iliac tortuosity index		
		(n=47)
	Mean (\pm SD)	1.1 (\pm 0.1)
	Median (Min, Max)	1.04 (1, 1.33)
Worst calcification		
	Femoral mild or moderate	8 (16.0%)
	Femoral severe	0
	Common iliac mild or moderate	9 (18.0%)
	Common iliac severe	0
	External iliac mild or moderate	6 (12.0%)
	External iliac severe	0

Data are n (%) or mean (\pm SD) and median (min, max). N=50 unless indicated otherwise. Shaded fields were not assessed. Site reported & Core Laboratory reported data.
 * Nine subjects (18.0%) were reported as 'Other location' but the description indicated distal to LSA/proximal DTA/Z3 and mid-DTA and so have been counted within the options 'Aortic isthmus' and 'Distal DTA'.
 DTA, descending thoracic aorta; ISS, injury severity score; LCCA, left common carotid artery; LSA, left subclavian artery.

7.4.5. RelayPro Stent-Grafts Implanted

A total of 56 devices were implanted during the index procedure (no other RelayPro devices were implanted subsequently; one subject received a RelayPlus extension (POD 207) (refer to **Table 25**). A single RelayPro device was implanted in 90.0% (45/50) and five subjects (10%) had more than one; two RelayPro devices implanted in 8.0% (4/50) of subjects, and one subject (2.0%) received three. All but one device was straight; one subject received a tapered RelayPro (28×150×24).

One subject received three RelayPro NBS devices to cover 200 mm of the aorta in reverse order: a 28-mm diameter device was first placed 40 mm above the celiac, a 30-mm diameter in the mid-DTA and tapering to 32 mm just distal to the LSA. The subject has completed three-year follow-up and had no complications related to coverage (no SCI; performed with prophylactic CSF drainage), device integrity or patency.

Of the 4 subjects that had two devices implanted, 3 subjects each had 2 RelayPro NBS devices, and 1 subject had a RelayPro NBS and RelayPro Proximal Bare Stent. One subject received two devices, for example, because only 100-mm devices were available. Proximal landing zone was beyond LCCA (with prior LSA transposition) and 100 mm was insufficient to create distal seal.

Table 25: Pro-T Devices Implanted (Initial Procedure)				
		Pro-T N=50	NBS	Bare stent
Devices Implanted	1	90.0% (45/50)	85.7% (30/35)	93.8% (15/16)
	2	8.0% (4/50)	11.4% (4/35)*	6.3% (1/16)*
	3	2.0% (1/50)	2.9% (1/35)	-
	Straight	98.0% (49/50)	100.0% (35/35)	93.8% (15/16)
	Tapered	2.0% (1/50)	0	6.3% (1/16)*
	Reverse tapered	0	0	0

Denominator includes subjects who received the test device. Site reported data.

* One subject had one NBS and one bare stent device and so it is counted in both columns.

NBS, non-bare stent.

Device diameters were relatively evenly distributed in the range 22—32 mm proximally (**Table 26**). The distal end of the RelayPro proximal bare stent configuration and non-bare stent (NBS) configuration are identical. Therefore, **Table 26** presents the distal diameter of all implanted RelayPro configurations (both RelayPro Proximal Bare Stent and NBS). Distal device diameters were also relatively evenly distributed in the range of 22—32 mm.

Table 26: Diameter of RelayPro Devices Implanted (Pro-T)			
Diameter (mm)		NBS	Proximal Bare Stent
Proximal	22	16.0% (8/50)	6.0% (3/50)
	24	14.0% (7/50)	4.0% (2/50)
	26	14.0% (7/50)	0
	28	14.0% (7/50)	10.0% (5/50)
	30	10.0% (5/50)	4.0% (2/50)
	32	8.0% (4/50)	4.0% (2/50)
	34	2.0% (1/50)	0
	36	2.0% (1/50)	4.0% (2/50)
	38	0	0
	40	0	0
	42	0	0
	44	0	0

Table 26: Diameter of RelayPro Devices Implanted (Pro-T)		
	46	0
		0
Distal	22	20.0% (10/50)
	24	20.0% (10/50)
	26	14.0% (7/50)
	28	22.0% (11/50)
	30	14.0% (7/50)
	32	12.0% (6/50)
	34	2.0% (1/50)
	36	6.0% (3/50)
	38	0
	40	0
	42	0
	44	0
	46	0
*Denominator includes all subjects who received the test device. Site reported data. NBS, non-bare stent.		

7.4.6. Acute Procedural Information

Table 27 summarizes information from the index procedure, including clinical utility endpoints. All subjects had general anesthesia (100%, 50/50). Even with relatively small access vessels, most procedures (80%, 40/50) were performed percutaneously with right femoral access (74.0%, 37/50) being most typical. Median duration of the procedure was 63 (IQR, 30) min and the median implantation duration (time from delivery system insertion to withdrawal) was 9 (IQR, 9) min (90% of subjects had a single device implanted, **Table 25**). The proximal landing zone of the RelayPro device was distal to the LSA in 58% (29/50) of cases and proximal to the LSA in 42% (21/50). Overall, blood loss was low and six subjects (12%) required transfusion. Median intensive care stay was 70 (IQR, 132.5) min and hospital stay was 10 (IQR, 13) days.

One subject had significantly longer intensive care stays and hospitalization (818 h and 181 days). He was a 35-year-old with a complicated clinical course after polytrauma that included chronic hypoxemic respiratory failure/tracheostomy collar, anoxic brain injury, bilateral DVTs, recurrent sepsis/septic shock, hypertension, and pneumonia. Nine subjects (18%) required 24 hours or less in intensive care and two did not require intensive care.

Table 27: Procedural Details (Pro-T)		
Characteristic		Pro-T N=50
General anesthesia		50 (100.0%)
Percutaneous access		40 (80.0%)
Surgical cut down		10 (20.0%)
Vascular access		
Left femoral		13 (26.0%)
Right femoral		37 (74.0%)
Proximal landing zone		
Distal to the LSA		29 (58.0%)
Proximal to the LSA		21 (42.0%)
Duration of procedure (min)	Mean (±SD)	73.5 (±39.6)

Table 27: Procedural Details (Pro-T)		
Characteristic		Pro-T N=50
	Median (IQR)	63 (30)
	Min - Max	23 – 240
Duration of implantation (min)	Mean (±SD)	10.9 (±6.2)
	Median (IQR)	9 (9)
	Min - Max	3 - 30
Estimated blood loss (cc)	Mean (±SD)	48.3 (±51.5)
	Median (IQR)	27.5 (30)
	Min - Max	0 – 300
Transfusion required		6 (12.0%)
Intensive care (hours)	Mean (±SD)	124.6 (±148.0)
	Median (IQR)	70 (132.5)
	Min - Max	0 – 818
Hospitalization (days)	Mean (±SD)	16.8 (±25.8)
	Median (IQR)	10 (13)
	Min - Max	1 - 181
Date are n (%) unless specified otherwise. Site reported data. IQR, interquartile range; LSA, left subclavian artery; SD, standard deviation.		

7.4.7. Safety Results

7.4.7.1. Primary Endpoint

The primary endpoint (all-cause mortality at 30-days post procedure) was analyzed with all subjects having completed 30-day follow-up; the result of 2.0% (exact two-sided 95% CI, 0.1%, 10.6%) was below the expected incidence (8%) (Table 28).

Table 28: Primary Endpoint Analysis (Pro-T)		
Characteristic	Statistics	Pro-T N=50
All-cause mortality at 30 Days	% (n/N)	2.0% (1/50)
	Exact two-sided 95% CI	0.1%, 10.6%
CI, confidence interval		

A per-protocol analysis was not performed as there are no subjects that would be removed from the intent-to-treat analysis to do a per-protocol analysis.

There was one subject with all-cause mortality at 30-days. This was a 61-year-old female that who presented with a grade 4 aortic injury of the distal DTA. She underwent immediate aortic injury repair with a RelayPro NBS (24 mm proximal diameter × 100 mm length × 24 mm distal diameter). The proximal end of the covered portion of the device was placed in the appropriate position distal to the LSA, without kinking or twisting and covering the primary tear. Post-completion angiogram showed retrograde flow into the LSA. The subject was transferred to critical care and kept on life-support until withdrawal of support and comfort care on POD 11. The subject was pronounced dead on POD 12. The CEC adjudicated the death as procedure-related cardiopulmonary arrest but not device-related.

7.4.7.2. Secondary Safety Endpoints

7.4.7.2.1. All-Cause and Aortic-Related Mortality

Aortic-related mortality is death due to a rupture, death within 30 days or prior to hospital discharge from the primary procedure, or death within 30 days or prior to hospital discharge for a secondary procedure designed to treat the original lesion. One subject expired on POD 12 and met the definition for aortic-related mortality. As it happened within 30 days of the index procedure, it is considered aortic-related; it was adjudicated by the CEC as not device-related but procedure-related. There has been no other mortality (**Table 29**).

There has only been one death in the study to date. Therefore, both aortic-related and all-cause mortality are the same for the study.

	30 Days	6 Months	12 Months	2 Years	3 Years	4 Years	Total
<i>Number Eligible</i>	50	49	49	47	32	14	50
All-Cause Mortality	2.0% (1/50)	0	0	0	0	0	2.0% (1/50)
Aortic-Related Mortality	2.0% (1/50)	0	0	0	0	0	2.0% (1/50)

Site reported data. Relatedness to the device and/or procedure was adjudicated by the CEC.

Kaplan Meier analysis estimated a freedom from All-Cause Mortality and Aortic-Related Mortality, respectively, to be 98% at 30 days through to four years (95% CI, 86.6—99.7%). Kaplan-Meier analysis estimated a freedom from aortic-related mortality of 98% at each interval from 30 days to four years (95% CI, 86.6—99.7%).

7.4.7.3. Major Adverse Events

Major Adverse Events for the Pro-T study included one case each of all-cause mortality and paralysis. At 30 days, one subject expired (described in the preceding section), and at 6 months, one subject reported new onset paralysis. There has been no incidence of stroke reported to date. The CEC adjudicated the paralysis as related to the device and not related to the procedure. The Kaplan-Meier analysis estimate of freedom from MAEs of 98.0% from 1-180 days and 95.6% from 181-1260 days.

Table 30 presents all MAEs adjudicated by the CEC.

	30 Days	6 Months	12 Months	2 Years	3 Years	4 Years	Total
	n=49	n=49	n=49	n=47	n=32	N=14	-
Subjects with ≥1 MAE (Total)	2% (1/49)	2% (1/49)	0	0	0	0	2
MAEs (Total)	1	1	0	0	0	0	2
Death (all-cause)	1	0	0	0	0	0	1
Paralysis	0	1	0	0	0	0	1
Stroke	0	0	0	0	0	0	0

Table 30: Summary of MAEs (CEC adjudicated) (Pro-T)							
	30 Days	6 Months	12 Months	2 Years	3 Years	4 Years	Total
Data are % (n/N), where n is the number of subjects with that event, N is the number of eligible subjects.							
MAEs are CEC adjudicated.							
Paralysis was defined as loss of power or voluntary movement in a muscle through injury to or disease of its nerve supply. Stroke was defined as a sudden, non-convulsive loss of neurological function due to an ischemic or hemorrhagic intracranial vascular event.							

7.4.7.4. Endograft Infection

Endograft infections are site reported and then CEC adjudicated. There was no endograft infection reported in any subject at any follow-up timepoints.

7.4.7.5. Device-Related Adverse Events

Adverse events adjudicated by the CEC as being device-related are summarized in **Table 31**. This table includes both AEs and SAEs and is sorted by MedDRA SOC and PT: 6.0% (3/50) of subjects experienced one or more device-related adverse events. One subject was reported with artery dissection and a Type II endoleak that required secondary intervention. One subject was reported thrombosis and paraplegia, and a separate subject reported with a Type I endoleak. Core Laboratory reported endoleaks are discussed in detail in a subsequent section.

Table 31: Summary of CEC Adjudicated Device-Related Adverse Events (Pro-T)	
MedDRA System Organ Class Preferred Term Adverse Event	Pro-T N=50
Subjects with at least one Device-Related Adverse Event	3 (6.0%)
General disorders and administration site conditions	3 (6.0%)
Stent-graft endoleak	2 (4.0%)
Vascular stent thrombosis	1 (2.0%)
Nervous system disorders	1 (2.0%)
Paraplegia	1 (2.0%)
Vascular disorders	1 (2.0%)
Artery dissection	1 (2.0%)

CEC data. Data is presented as n (%), where n is the number of subjects reported with the event and % is percentage of subjects with the event. Includes serious and non-serious adverse events. Percentages are based on the number of subjects in enrolled in the study. Event verbatim terms are reported by sites. The events listed in this table are coded using MedDRA version 22.0 and then stratified by System-Organ Class (SOC) and Preferred Term. Subjects may be counted in this table more than once by Preferred Term but are only counted once in the SOC summary line.

7.4.7.6. Procedure-Related Adverse Events

Adverse events adjudicated by the CEC as being procedure-related are summarized in **Table 32**. This table includes both AEs and SAEs and is sorted by MedDRA SOC and PT. Four subjects (8.0%) were reported with 4 procedure-related adverse events. One subject was reported with a Type II endoleak that required secondary intervention. One subject was reported with a Type I endoleak. Both endoleaks were adjudicated by the CEC as device-related and presented above; the other events included peripheral artery thrombosis and cardiorespiratory arrest that resulted in death.

MedDRA System-Organ Class Preferred Term Adverse Event	Pro-T N=50
Subjects with at least one Procedure-Related Adverse Event	4 (8.0%)
General disorders and administration site conditions	2 (4.0%)
Stent-graft endoleak	2 (4.0%)
Cardiac disorders	1 (2.0%)
Cardio-respiratory arrest	1 (2.0%)
Vascular disorders	1 (2.0%)
Peripheral artery thrombosis	1 (2.0%)

CEC data. Data is presented as n (%), where n is the number of subjects reported with the event and % is the percentage of subjects with the event. Includes serious and non-serious adverse events. Percentages are based on the number of subjects in enrolled in the study. Event verbatim terms are reported by sites. The events listed in this table are coded using MedDRA version 22.0 and then stratified by System-Organ Class (SOC) and Preferred Term. Subjects may be counted in this table more than once by Preferred Term but are only counted once in the SOC summary line.

7.4.8. Effectiveness Results

7.4.8.1. Secondary Effectiveness Endpoints

A summary of the secondary effectiveness endpoints are presented in **Table 33** and briefly described below. Details regarding each of these observations and events (along with other captured information) are presented in the subsequent sections.

For the 30-day follow-up window, there were three secondary interventions in three subjects to address Type Ia endoleak (n=1), Type II endoleak (n=1), and uncategorized (n=1, same day as the index procedure to address popliteal thrombus in distal left leg).

For the 6-month follow-up window, there was one loss of patency and one secondary intervention to address thrombosis in the same subject. For the 12-month follow-up window, there were no reported observations or events, as well as no secondary interventions related to the device or procedure (site and/or CEC adjudicated). For the 2-year follow-up window, there was one secondary intervention to address narrowing distal to the stent graft. For the 3-year follow-up window, there was one secondary intervention to address a remaining dissection intimal flap and no other reported events or observations.

As of the data freeze, there were no aortic ruptures, aortic dilation, migration, compression (kinking), twisting, extrusion/erosion, fracture, suture breaks, Type Ib endoleaks, or Type III endoleaks at any timepoint. There were also no conversions to open surgery reported at any timepoint.

	30 Days	6 Months	12 Months	2 Years	3 Years	4 Years	Total
Aortic rupture	0	0	0	0	0	0	0
Aortic dilation	NA	0	0	0	0	0	0
Secondary intervention	6.1% (3/49)	2% (1/49)	0	2.1% (1/47)	3.1% (1/32)	0	6
Type Ia endoleak	2.1% (1/48)	0	0	0	0	0	1
Type Ib endoleak	0	0	0	0	0	0	0
Type III endoleak	0	0	0	0	0	0	0
Loss of patency	0	2.8% (1/36)	0	0	0	0	1

Table 33: Summary of Secondary Effectiveness Endpoints (Pro-T)							
	30 Days	6 Months	12 Months	2 Years	3 Years	4 Years	Total
Compression (kinking)	0	0	0	0	0	0	0
Twisting	0	0	0	0	0	0	0
Extrusion/erosion	0	0	0	0	0	0	0
Stent fracture	0	0	0	0	0	0	0
Suture break	0	0	0	0	0	0	0
Migration	NA	0	0	0	0	0	0

MAE, major adverse event; NA, not applicable.

All values expressed as % (n/N) for endpoints reported within the specified window. Denominators are specified in **Table 21** (Summary of Compliance and Imaging Follow-Up). For imaging endpoints (fractures, migration, endoleak, dilation), the denominator is the number of subjects with imaging adequate to assess the parameter. For clinical endpoints (e.g., secondary interventions), the denominator is the number of subjects with visits within the window. Windows for visits are as follows: 30 days (Day 0-90); 6 months (Day 91-270); 1 year (Day 271-540); 2 years (Day 541-900); 3 years (Day 901-1260); 4 years (Day 1261-1620).

7.4.8.2. *Technical Success & Access Complications*

Technical success at the time of the index procedure (defined as successful delivery and deployment of the device, including withdrawal of the delivery system) was 98%. One subject had an early Type Ia endoleak that the site associated with retroflex (nonparallel to the aortic wall) upon deployment (captured as kinking in **Table 34**). This was corrected in a secondary intervention on POD 3, specifically ballooning and a RelayPro proximal extension.

There was one (2.0%) vascular access complication unrelated to the device: the procedure was being performed percutaneously (with a Perclose access device) when the subject's sutures broke at the Perclose device's access point and surgical cut-down was then required. The procedure was nevertheless a technical success.

Four subjects (8%) required additional procedures. One subject is described above regarding the Type Ia endoleak. One subject had coil embolization to address a Type II endoleak. One subject required additional ballooning to improve aortic wall apposition after a Bentson guidewire interacted with the stent-graft. Another had popliteal thrombus that required embolectomy catheters and returned a large amount of thrombus (platelet not fresh) which likely embolized from the aortic injury.

Table 34: Summary of Technical Success (Pro-T)	
	Pro-T N=50
Evaluation of RelayPro System (index procedure)	
Deployment without kinking or twisting	49 (98.0%)
Accuracy of deployment acceptable	50 (100.0%)
Stent-graft deployed	50 (100.0%)
Stent-graft patent	50 (100.0%)
Stent-graft integrity (no wire fracture)	50 (100.0%)
Procedure performed without unplanned vascular access difficulties or complications	49 (98.0%)
Additional treatment required	4 (8.0%)

Table 34: Summary of Technical Success (Pro-T)	
	Pro-T N=50
Primary tear covered	50 (100.0%)
Absence of retrograde extension of the dissection	
	N/A 9 (18.0%)
	Yes 40 (81.6%)*
Site reported data. N/A: When there was no retrograde extension of the dissection prior to treatment and none after treatment, this was indicated as not applicable.	
*Please note that these fields reflect data collected after the data freeze for the report. Total is 49 because of missing data.	

7.4.8.3. Aortic rupture

There have been no reported aortic or graft ruptures to date.

7.4.8.4. Aortic Dilation (>5 mm)

Aortic dilation is defined as an increase of 5 mm or more in diameter from the first postprocedural imaging. These assessments are based on Core Laboratory measurements. Thirty-five (35) subjects had imaging adequate to assess aortic diameter at 6-months, 37 at 12-months, 26 at 2-years, 10 at 3-years, and 2 at 4-years. No subject had aortic dilation >5 mm at any timepoint. One subject (1/37) had a decrease in aortic diameter at 12 months.

7.4.8.5. Secondary Interventions

All secondary interventions were site reported and/or CEC adjudicated as a secondary intervention. The reasons noted for secondary intervention are based on site reported information. As of the data freeze, 6 secondary interventions were reported in 5 subjects to address Type Ia endoleak (1 subject), Type II endoleak (1 subject), stent graft patency (1 subject), stenosis (narrowing distal to the RelayPro device) (1 subject), and uncategorized (1 subject). One subject underwent two interventions; the subject noted with the Type II endoleak intervention (embolization) received an additional RelayPro device to address the remaining dissection intimal flap at 3-years.

There were no reinterventions related to Type Ib endoleaks, migration, aortic dilation or rupture. There was no conversion to open surgery at any timepoint.

Table 35: Reasons for Secondary Intervention (Pro-T)							
	30 Days	6 Months	12 Months	2 Years	3 Years	4 Years	Total
<i>N at risk</i>	49	49	49	47	32	13	-
<i>n secondary interventions</i>	3	1	0	1	1	0	6
Subjects with any secondary intervention	6.1% (3/49)	2.0% (1/49)	0	2.1% (1/47)	3.1% (1/32)	0	5
Type Ia endoleak	2.0% (1/49)	0	0	0	0	0	1
Extension	1	0	0	0	0	0	1
Type II endoleak	2.0% (1/49)	0	0	0	0	0	1
Embolization	1	0	0	0	0	0	1
Other*	0	2.0% (1/49)	0	2.1% (1/47)	3.1% (1/32)	0	3
Extension	0	1	0	1	1	0	3
Uncategorized**	2.0% (1/49)	0	0	0	0	0	1
Embolectomy	1	0	0	0	0	0	1
Data presented as % (n/N), where N is the number of subjects at risk.							
Windows for visits are as follows: 30 days (Day 0-90); 6 months (Day 91-270); 1 year (Day 271-540); 2 years (Day 541-900); 3 years (Day 901-1260);							

Table 35: Reasons for Secondary Intervention (Pro-T)							
	30 Days	6 Months	12 Months	2 Years	3 Years	4 Years	Total
4 years (Day 1261-1620).							
*Other includes thrombus (6-months), stenosis post stent-graft (2 years), intimal flap (3 years) reported by site.							
<ul style="list-style-type: none"> One subject had thrombosis addressed successfully by relining with a RelayPlus device. One subject had stenosis post-implant of patient with coarctation physiology treated successfully (POD645) via distal extension of the RelayPro using a competitor 22x100mm device. One subject had an Intimal flap successfully treated (POD955) with additional RelayPro (24x99 NBS). 							
**Uncategorized includes events reported by CEC without further categorization available:							
<ul style="list-style-type: none"> One subject had popliteal thrombus in the distal left leg (30 days). Upon completion of index procedure, popliteal thrombus noted and embolectomy catheters were passed and thrombus removed successfully. 							
Interventions Completed by Reason for the Intervention:							
<ul style="list-style-type: none"> One subject had a Type Ia endoleak treated successfully (POD3) with a third RelayPro bare stent deployed distal to the LCCA and ballooning of the proximal end. One subject had Type II endoleak treated successfully (POD9) with coil embolization in the proximal subclavian 							

7.4.8.6. All Endoleaks

Core Laboratory Reported

Table 36 shows the six subjects that the Core Laboratory reported with endoleak: one Type Ia, four Type II, and one undetermined. There was one undetermined intraoperative endoleak that persisted to 30-days. No Type Ib or Type III endoleaks have been reported by the Core Laboratory.

The one Type Ia endoleak was observed at 30-day follow-up and did not persist at any follow-up visits. Of the three Type II endoleaks reported at 30 days, one had resolved by six months, one resolved by one year (after coiling the LSA), and one is pending next follow-up. There was one new Type II endoleak at six months that was persistent at one year (last follow-up that is currently available). There was one intraoperative Type II endoleak reported that had resolved by 30 days and is listed below but does not figure in the follow-up table. No Type II endoleak was associated with aortic dilation.

One subject had an undetermined intraoperative endoleak that persisted at 30 days but resolved spontaneously by six months without a secondary intervention. No aortic dilation was observed at follow-up assessments.

Site Reported

Please note that site reported endoleaks were reported as adverse events and adjudicated by the CEC for relatedness to the device and/or procedure. There were two subjects with a site reported endoleak: One Type II endoleak and one Type I endoleak. Please review **Section 7.4.7.5** for additional information.

Table 36: Summary of Core Laboratory Reported Endoleaks (Pro-T)							
Endoleak	30 Days	6 Months	12 Months	2 Years	3 Years	4 Years	Total
<i>Adequate Imaging</i>	48	34	36	26	10	2	-
Any endoleak	10.4% (5/48)	5.9% (2/34)	2.8% (1/36)	3.8% (1/26)	10% (1/10)	0	10
Type Ia							
New	1	0	0	0	0	0	1
Persistent	NA	0	0	0	0	0	-
New & Persistent	2.1% (1/48)	0	0	0	0	0	-
Type Ib	0	0	0	0	0	0	0
Type II							

Table 36: Summary of Core Laboratory Reported Endoleaks (Pro-T)							
Endoleak	30 Days	6 Months	12 Months	2 Years	3 Years	4 Years	Total
New	3	1	0	0	0	0	4
Persistent	NA	1	1	0	0	0	
New & Persistent	6.3% (3/48)	5.9% (2/34)	2.8% (1/36)	0	0	0	-
Type IIIa	0	0	0	0	0	0	0
Type IIIb	0	0	0	0	0	0	0
Type IV	0	0	0	0	0	0	0
Unknown Type	1	0	0	0	0	0	1
New & Persistent	2.1% (1/48)	0	0	0	0	0	-

NA, not applicable.
Adequate imaging was determined by the Core Laboratory. In general, images with contrast and non contrast series were regarded as adequate for interpretation of endoleaks.

7.4.8.7. Additional Secondary Endpoints (Integrity, Patency, Migration, Compression, Erosion, Extrusion)

No suture breaks or fractures (site reported or Core Laboratory reported) or device migration have been reported in any subject at any follow-up visit. There were no Core Laboratory observations of kinking, twisting, extrusion or erosion, fistula formation, misalignment or bird-beak in any subject at any timepoint as of the data freeze.

There was one Core Laboratory reported occurrence of loss of patency at 6 months which was stent-graft stenosis >50% (thrombosis). A review of this case for potential contributing causes of the observation included device design, thrombus characteristics, procedural considerations, medications, as well as anatomical and subject characteristics. No device-specific factors were identified that may have contributed to this observation. The subject had some factors (obesity, DVT, enoxaparin treatment, COVID-19, hormonal contraception, pneumonia) that could influence coagulability; however, it was not possible to definitively identify the root cause of the thrombus in this subject.

In one subject, the site reported thrombus around the distal stent (32-months post procedure) and renal infarct noted as likely embolic from the aortic thrombus around the distal stent. The Core Laboratory did not identify stenosis (> 50%) or occlusion; the imaging did not show any renal infarcts (22-months post procedure). The 32-month imaging had not yet been reviewed by the Core Laboratory as of the date freeze. Subject began anticoagulation starting with intravenous heparin and was discharged on apixaban four days after hospitalization with the instruction not to continue her hormonal contraceptive. The site-reported thrombus and acute kidney injury was reported as resolved.

A site-reported event at two years, specifically narrowing not inside but distal to the stent-graft (treated originally with a single RelayPro NBS 22x100x22) was related to aortic coarctation and was not identified by the Core Laboratory. The CEC adjudicated this site-reported event as not related to the device and not related to the procedure. This observation was addressed with a distal extension with post-operative resolution of the intramural hematoma and all symptoms.

There was a kink later clarified by the site investigator to be retroflex (with associated Type Ia endoleak) and resolved with ballooning POD 3; this kink was not reported by the Core Laboratory. The CEC adjudicated as related to both the device and procedure.

Table 37: Device Performance (Core Laboratory Reported) (Pro-T)							
Parameter	1 Month	6 Months	1 Year	2 Years	3 Years	4 Years	Total
<i>Subjects with Adequate Imaging</i>	48	36	37	27	10	2	-
Fractures	0	0	0	0	0	0	0
<i>Subjects with Adequate Imaging</i>	47	36	37	26	10	2	-
Loss of patency	0	1 (2.8%)	0	0	0	0	1
<i>Subjects with Adequate Imaging</i>	48	36	37	26	10	2	-
Migration (> 10 mm)	NA	0	0	0	0	0	0
<i>Subjects with Adequate Imaging</i>	48	36	37	26	10	2	-
Extrusion / erosion	0	0	0	0	0	0	0
Fistula formation							
Aortobronchial	0	0	0	0	0	0	0
Tracheal	0	0	0	0	0	0	0
Aortoenteric	0	0	0	0	0	0	0
Device kink (compression)	0	0	0	0	0	0	0
Misalignment / bird-beak	0	0	0	0	0	0	0
Stent-graft stenosis (>50%)	0	1 (2.9%)	0	0	0	0	1
New	-	1	-	-	-	-	1
Persistent	-	0	-	-	-	-	-
Suture break	0	0	0	0	0	0	0
Device twist	0	0	0	0	0	0	0

One subject had stent graft occlusion (stenosis >50%) at 6 months.
NA, not applicable.
Results are presented on a per subject basis; a single subject may be reported with more than one of the same event/observations (e.g., fracture).
Regarding performance-related events and observations, the following definitions are applied by the Core Laboratory:

- Patency: Contrast flow throughout entire length of the device(s).
- Stenosis: Stenosis (>50% narrowing) throughout length of stent-graft.
- Kink: Bending deformation of the stent graft resulting in an unintentional obstruction (>50%) of blood flow through the vascular lumen and not caused by anatomy of the vessel wall.
- Twisting: Torsional deformation of the stent graft resulting in an unintentional obstruction (>50%) of blood flow through the vascular lumen and not caused by anatomy of the vessel wall.
- Misalignment/Bird-beak: Misalignment of stent (centerline of device doesn't follow centerline of lumen) or bird-beak (incomplete apposition of stent a proximal end of device) that restricts blood flow greater than 50%.
- Loss of device integrity (stent fracture in the attachment zone) is any fracture or breakage of any portion of the RelayPro stent in the attachment zone, including metallic fracture.
- Device migration is longitudinal movement of all or part of a stent or attachment system for a distance >10 mm relative to anatomical landmarks that were determined at the first post-procedural imaging study, as measured by the Core Laboratory.

7.5. SUB-GROUP ANALYSIS

There were 13 women (26%) and 37 men (64%) treated as part of the study. There was one failure of the primary endpoint (one early mortality) and that was in a woman. It is not possible to interpret the differences as a result of the single event and the exact two-sided 95% confidence interval is wide (-6.8%, 22.2%).

7.6. ADDITIONAL FOLLOW-UP DATA

Between 23 September 2022 and 08 November 2022, there has been one 3-year follow-up visit completed. There have been no Core Laboratory reports of endoleak, migration, loss of device integrity, kinking, twisting, extrusion/erosion,

misalignment, loss of patency, new retrograde dissection, or aortic expansion along the endovascular graft during this timeframe. During this timeframe, there have been no open surgical conversions, aortic ruptures or secondary interventions reported.

8. SUMMARY OF DISSECTION CLINICAL STUDY

8.1. INTRODUCTION

The primary objective of the Pivotal Study was to evaluate the safety and effectiveness of the **RelayPro THORACIC STENT-GRAFT SYSTEM** in subjects with acute, complicated Type B aortic dissections (referred to as the Pro-D study). The study was a multi-center, prospective, single-arm, non-randomized, and non-blinded investigation. Fifty-six (56) subjects were treated between September 7, 2017 and September 3, 2021 at 22 US investigational sites. Subjects are being followed at 1-month, 6 months, 12-months, and annually thereafter for 5-years.

8.2. ENDPOINTS

8.2.1. Primary Endpoint

The primary endpoint is all-cause mortality at 30-days post-procedure.

The primary endpoint was compared to a performance goal of 25%. The performance goal is consistent with other endovascular graft pivotal studies for acute, complicated Type B dissections.

The hypothesis tested for the primary endpoint was:

Null hypothesis (H_0): $p \geq 0.25$

Alternative Hypothesis (H_A): $p < 0.25$

where p is the proportion of RelayPro subjects with all-cause mortality and 25% was the performance goal for the endpoint.

The primary objective would be met if the upper limit of the 95% one-side confidence interval of the primary endpoint is below 25%.

8.2.2. Sample Size

Sample size is based on an expected event rate for the primary endpoint of 14.45% and performance goal rate of 25%.

A maximum of 40 investigative sites and up to 80 subjects were planned for participation in the Pivotal Study. Interim analyses were planned to be completed when 50, 65, and 80 subjects reached the 30 days of post-procedure follow-up. With respect to stopping for success according to the interim analysis plan, a p-value of 0.01317 or less would be required to cross the boundary based on data from the first 50 subjects. Early stopping based on a sample size of 50 subjects provides at least 80% power to detect one or more rare adverse events that occur at a population rate of 3.2% or greater.

8.2.3. Secondary Endpoints

Secondary endpoints include the following:

- Technical Success at the time of the index procedure, defined as: Successful delivery and deployment of the device, including withdrawal of the delivery system;
- Treatment success through 1 month, defined as individual components and as a composite:
 - Absence of major adverse events (MAEs), defined as:
 - Stroke (disabling);
 - Renal failure (excludes pre-existing);
 - Paraplegia;

- Paraparesis;
 - Absence of perfusion into the false lumen through the primary intimal tear;
 - Absence of retrograde extension of the dissection;
- Dissection treatment success through 1 month, 6 months, 12 months, and annually through 5 years, defined as individual endpoints and as a composite:
 - Absence of expansion (> 5mm) in the aorta that has an endograft, compared to the first post-procedural computed tomographic (CT) imaging study;
 - Absence of aortic rupture;
 - Absence of dissection-related mortality;
 - Absence of MAEs including new ischemia due to branch vessel compromise;
 - Absence of false lumen perfusion by location:
 - Proximal;
 - Distal;
 - Branch
 - Absence of new aortobronchial/tracheal or aortoenteric fistula formation;
 - Absence of unintentional rupture of the dissection septum;
- Device imaging assessments through 1 month, 6 months, 12 months, and annually through 5 years, defined as:
 - Endoleaks;
 - Stent graft kinking or twisting;
 - Loss of stent-graft patency;
 - Misalignment;
 - Loss of integrity;
 - RelayPro stent fracture in the attachment zone;
 - Stent migration (> 10mm), compared to the first post-procedural CT;
- Aortic expansion (> 5mm) at 6 months, 12 months, and annually through 5 years, compared to the first post-procedural CT;
- Incidence of open or endovascular dissection related secondary interventions to treat malperfusion, rupture, aneurysm formation, or aortic expansion through 1 month, 6 months, 12 months, and annually through 5 years.

8.3. SUBJECTS

Subjects enrolled in the Dissection Study met the following criteria:

- Age ≥18 years.
- Have an acute (symptom onset to diagnosis within 2 weeks), complicated Type B aortic dissection (entire dissection is distal to the left subclavian artery), including those with multiple entry tears, with clinical or imaging evidence of at least one of the following:
 - Malperfusion of the viscera, kidneys, spinal cord, or lower extremities;
 - Aortic rupture.
- Proximal and distal landing zones with diameter between 19 mm and 42 mm.
- All of the following anatomical criteria:
 - Proximal landing zone distal to the left common carotid and a distal attachment zone proximal to the origin of the celiac artery.
 - Dissection is permitted in the distal attachment zone but is not permitted in the proximal attachment zone.
 - The length of the proximal landing zone depends on the intended stent-graft diameter, and landing zone should be:
 - 15 mm for 22 – 28 mm RelayPro grafts with bare stent (20 mm for RelayPro grafts with non-bare stent).
 - 20 mm for 30 – 46 mm RelayPro grafts with bare stent (25 mm for RelayPro grafts with non-bare stent).
 - Proximal to non-dissected segment (healthy zone)
 - The distal attachment zone should be 20 mm for all RelayPro grafts.

- Coverage of the left subclavian artery is permitted with mandatory revascularization if patent left internal mammary artery (LIMA) bypass or left upper extremity (LUE) AV graft or anomalous vertebral artery off the aorta. Revascularization must be performed prior to device placement, and may occur during implant procedure, provided it is before coverage of the LSA by the endograft.
- Proximal landing zone containing a straight segment (non-tapered, non-reverse-tapered, defined by <10% diameter change) with lengths equal to or greater than the required attachment length for the intended device.
- Vascular dimensions (e.g., aortic diameters, length from left subclavian to celiac artery) must be in the range that can be treated with the RelayPro Thoracic Stent-Grafts (able to deliver device to the location of treatment as described in the IFU).
- Adequate iliac or femoral artery access for introduction of the RelayPro Delivery System. Alternative methods to gain proper access may be utilized (e.g., iliac conduit).
- Subjects willing to comply with the follow-up evaluation schedule.
- Subjects (or Legally Authorized Representative, LAR) agrees to sign an Informed Consent Form prior to treatment.

Subjects were excluded if they had any of the following anatomic or physiologic characteristics:

- Diagnosis of traumatic injury or transection of the descending thoracic aorta.
- Significant stenosis, calcification, thrombus, or tortuosity of intended fixation sites that would compromise fixation or seal of the device.
- Planned coverage of left carotid or celiac arteries; or anatomic variants that may compromise circulation to the carotid, vertebral, or innominate arteries after device placement, and are not amenable to subclavian revascularization.
- Prior endovascular or surgical repair in the descending thoracic aorta. The device may not be placed within any prior endovascular or surgical graft.
- Concomitant aneurysm/disease of the ascending aorta, aortic arch, or abdominal aorta, requiring repair. Dissection extension into the abdominal aorta is acceptable.
- Prior abdominal aortic aneurysm repair (endovascular or surgical) that was performed less than 6 months prior to the planned stent implant procedure.
- Major surgical or medical procedure within 30 days prior to the planned procedure or is scheduled for a major surgical or medical procedure within 30 days post implantation. This excludes any planned procedures for the prospective stent-graft placement.
- Untreatable allergy or sensitivity to contrast media or device components, including metal stents.
- Known or suspected connective tissue disorder.
- Blood coagulation disorder or bleeding diathesis for which the treatment cannot be suspended for one week pre- and/or post-repair.
- Coronary artery disease with unstable angina.
- Severe congestive heart failure (New York Heart Association functional class IV).
- Stroke and/or MI within 3 months of the planned treatment date.
- Pulmonary disease requiring the routine (daily or nightly) need for oxygen therapy outside the hospital setting.
- Acute renal failure (not associated with malperfusion due to aortic dissection) or chronic renal insufficiency, and not receiving dialysis.
- Hemodynamically unstable.
- Active systemic infection and/or mycotic aneurysm.
- Bowel necrosis.
- Morbid obesity or other condition that may compromise or prevent the necessary imaging requirements.
- ASA risk classification = V (Moribund patient not expected to live 24 hours with or without operation).
- Less than two-year life expectancy.
- Current or planned participation in an investigational drug or device study that has not completed primary endpoint evaluation.
- Currently pregnant or planning to become pregnant during the course of the study.
- Medical, social, or psychological issues that Investigator believes may interfere with treatment or follow-up.

8.4. PRO-D STUDY RESULTS

8.4.1. Subject Accountability and Follow-up

At the time of database freeze, of the 56 subjects enrolled in the Pro-D study, all 56 subjects were implanted with the RelayPro Stent-Graft System and 56 were seen through discharge. Fifty-three (of 56) eligible subjects (94.6%) had a 30-day visit with at least 85.7% of subjects with adequate imaging to address endovascular graft parameters. Thirty-seven (of 51) subjects had a 6-month visit with at least 58.8% with imaging adequate to address endovascular graft parameters. At the 12-month visit, 34 of 48 eligible subjects had a visit performed with at least 62.5% with imaging adequate to address endovascular graft parameters.

At 2-years, 20 of the 36 eligible subjects (55.6%) had a visit performed with 27.8% (10 subjects) still in window. At 3-years, 9 of the 18 eligible subjects have completed the follow-up visit with 33.3% (6 subjects) still in window. Eight subjects are eligible for the 4-year visit with 2 subjects with imaging information. Two subjects are eligible for the 5-year visit; however, they have not yet returned for the visit.

Compliance and imaging follow-up are provided in **Table 38** below.

Visit	Subject Follow-Up#				Imaging		Imaging Adequate †				Events Within Window‡				
	Eligible for Visit	Visit Performed	No Visit*	Still in Window	CT Scan	X-Ray	Diameter	Endoleak	Migration	Fracture	Death	Lost to follow-up	Early Withdrawal	Not Yet Due	Subjects with ≥1 Element
Index	56	NA	NA	NA	NA	NA	NA	NA	NA	NA	0	0	0	0	0
30D	56	94.6% (53/56)	5.4% (3/56)	0	91.1% (51/56)	87.5% (49/56)	89.3% (50/56)	85.7% (48/56)	91.1% (51/56)	92.9% (52/56) ^{††}	5	0	0	0	5
6M	51	72.5% (37/51)	27.5% (14/51)	0	66.7% (34/51)	62.7% (32/51)	66.7% (34/51)	58.8% (30/51)	64.7% (33/51)	66.7% (34/51)	1	2	0	0	3
12M	48	70.8% (34/48)	29.2% (14/48)	14.6% (7/48)	66.7% (32/48)	56.3% (27/48)	66.7% (32/48)	62.5% (30/48)	64.6% (31/48)	64.6% (31/48)	1	1	0	10	12
2Y	36	55.6% (20/36)	44.4% (16/36)	27.8% (10/36)	52.8% (19/36)	50.0% (18/36)	52.8% (19/36)	47.2% (17/36)	50.0% (18/36)	50.0% (18/36)	2	2	0	12	18
3Y	18	50.0% (9/18)	50.0% (9/18)	33.3% (6/18)	38.9% (7/18)	38.9% (7/18)	38.9% (7/18)	33.3% (6/18)	38.9% (7/18)	38.9% (7/18)	0	0	0	10	10
4Y	8	25.0% (2/8)	75.0% (6/8)	75.0% (6/8)	25.0% (2/8)	25.0% (2/8)	25.0% (2/8)	25.0% (2/8)	25.0% (2/8)	12.5% (1/8)	0	0	0	6	6
5Y	2	0	100.0% (2/2)	100.0% (2/2)	0	0	0	0	0	0	0	0	0	2	2

NA – Not Applicable; LTFU, lost to follow-up;
The number of subjects eligible for each visit are used for the denominator for the percentages of visits performed, imaging performed, as well as imaging adequate to assess the respective endovascular graft parameters.
Site reported data. No Visit reflects subjects who did not have a visit and/or imaging performed within the window. Still in Window reflects subjects who have not yet reached the end of the analysis window and have not yet had a visit or imaging performed.
† Aortic Diameter and Migration assessments use 1 month as baseline. Eligible subjects require valid value at 1 month and at the specified time point.
‡ These columns reflect subjects who had visits within the specified window but were not eligible at the start of the next window due to death, loss to follow-up, conversion to open surgery, or early withdrawal. Please note that 2 subjects had a conversion to open surgery and are counted in the Other column.
* One subject was indicated as having voluntarily withdrawn, but the date of withdrawal was not recorded. This subject was not counted as a withdrawal in this table as the subject has subsequently re-consented for participation.
†† There was one subject who had an x-ray but not a CT scan and three subjects who had CTs but not an x-ray. Since fractures can be assessed from either imaging modality, the 51 CT scans plus the one x-ray without a CT scan gives a total of 52/56 subjects with imaging adequate to assess fracture.

8.4.2. Subject Demographics

The pivotal study population is 73.2% male (41/56), 53.6% black (30/56) and predominately younger; two thirds were under 65 with a mean age of 59.5±11.4 years.

Table 39: Pro-D Subject Demographics		
	Statistics	Pro-D (N=56)
Sex		
Male	% (n/N)	73.2% (41/56)
Female	% (n/N)	26.8% (15/56)
Age (years) at Treatment		
	Mean ± SD (N)	59.5 ±11.42 (56)
	Median (IQR)	59.5 (51-68)
	Min - Max	36 - 82
Age Group		
18-64 years	% (n/N)	66.1% (37/56)
65-74 years	% (n/N)	25.0% (14/56)
75+ years	% (n/N)	8.9% (5/56)
Ethnic Group		
Not Hispanic/Latino	% (n/N)	89.3% (50/56)
Hispanic/Latino	% (n/N)	1.8% (1/56)
Not Reported	% (n/N)	8.9% (5/56)
Race		
Black	% (n/N)	53.6% (30/56)
White	% (n/N)	42.9% (24/56)
Asian	% (n/N)	1.8% (1/56)
Unknown	% (n/N)	1.8% (1/56)
Site reported data.		

8.4.3. Baseline Medical History

The most common comorbidities among subjects include hypertension (89.3%, 50/56), history of smoking (82.1%, 46/56), hypercholesterolemia (37.5%, 21/56), documented coronary artery disease (21.4%, 12/56), gastrointestinal complications (19.6%, 11/56), diabetes mellitus (17.9%, 10/56), and renal insufficiency and previous vascular intervention (each reported in 12.5%, 7/56).

Table 40: Pro-D Subject Comorbidities	
	Pro-D (N=56)
Hypertension (treated or untreated)	89.3% (50/56)
History of Smoking	82.1% (46/56)
Current Smoker	47.8% (22/46)
Hypercholesterolemia	37.5% (21/56)
Current Antiplatelet/Anticoagulant Medication	37.5% (21/56)
Documented Coronary Artery Disease	21.4% (12/56)
Stable Angina	3.6% (2/56)
Unstable Angina	1.8% (1/56)
Myocardial Infarction	3.6% (2/56)
Arrhythmias	1.8% (1/56)
Congestive Heart Failure	5.4% (3/56)
Other	12.5% (7/56)
History of Gastrointestinal Complications	19.6% (11/56)
Cholecystitis	0
Ischemic Colitis	0
GI Bleed	0

Table 40: Pro-D Subject Comorbidities	
	Pro-D (N=56)
Small Bowel Ischemia	0
GERD	12.5% (7/56)
Other GI condition	7.1% (4/56)
Diabetes Mellitus	17.9% (10/56)
Renal Insufficiency	12.5% (7/56)
History of Vascular Intervention	12.5% (7/56)
History of Limb Ischemia	8.9% (5/56)
History of Peripheral Vascular Disease	7.1% (4/56)
History of Impotence (males only)	2.4% (1/41)
All values expressed as % (n/N). Site reported data.	
GERD, gastroesophageal reflux disease; GI, gastrointestinal	

8.4.4. Baseline Vessel Measurements

The baseline lesion characteristics for the subjects enrolled in the study are presented in **Table 41**. All 56 subjects had Type B aortic dissection complicated by either malperfusion or rupture. Based on site's baseline assessment of the type of dissection, 51.8% (29/56) subjects presented with malperfusion of the kidneys, 33.9% (19/56) subjects with malperfusion of the viscera, 35.7% (20/56) with malperfusion of the lower extremities, 1.8% (1/56) with malperfusion of the spinal cord, and 10.7% (6/56) with rupture. Sixteen subjects (28.6%) had more than one type of malperfusion.

The Core Laboratory reported proximal extent of the dissection in Zone 3 in 78.6% (44/56) of subjects, extending distally to the iliac arteries (one or both) in 67.3% (35/52), the abdominal aorta (25.0%, 14/52) or limited to the thoracic aorta (5.4%, 3/52). Mean maximum thoracic aortic diameter is 42.2±6.9 mm (median 40.4 mm, range 27–62.7 mm) and mean aortic diameter at the proximal end of the dissection is 33.8±3.4 mm (median 33.5 mm, range 25–42.1 mm).

Table 41: Core Laboratory-Reported Baseline CT Measurements (Pro-D)	
	Pro-D (N=56)
Aortic Diameter at Left Common Carotid (mm)	
n	55
Mean (SD)	33.1 (3.3)
Median (min, max)	32.9 (25.1, 41)
Aortic Diameter at Left Subclavian (mm)	
n	56
Mean (SD)	33.5 (4.2)
Median (min, max)	32.65 (24.3, 45.2)
Aortic Diameter at Proximal End of Dissection (mm)	
n	56
Mean (SD)	33.8 (3.4)
Median (min, max)	33.45 (25, 42.1)
Maximum Thoracic Aortic Diameter (mm)	
n	56
Mean (SD)	42.2 (6.9)
Median (min, max)	40.4 (27, 62.7)
Maximum Thoracic Aortic Diameter - True Lumen (mm)	
n	56
Mean (SD)	18.6 (7.8)
Median (min, max)	17.8 (3.4, 46.7)
Maximum Thoracic Aortic Diameter - False Lumen (mm)	
n	56
Mean (SD)	17.7 (8.9)

Table 41: Core Laboratory-Reported Baseline CT Measurements (Pro-D)	
	Pro-D (N=56)
Median (min, max)	15.9 (0, 45)
Length from Left Common Carotid to Primary Intimal Tear (mm)	
n	54
Mean (SD)	55.7 (48.4)
Median (min, max)	42.2 (5.7, 222)
Length from Left Subclavian to Primary Intimal Tear (mm)	
n	54
Mean (SD)	39.6 (47.5)
Median (min, max)	24.7 (-8.37, 198.9)
Total Treatment Length (mm)	
n	50
Mean (SD)	207.3 (49.5)
Median (min, max)	214.5 (108, 281)
Dissection Length (mm)	
n	51
Mean (SD)	442.1 (104.9)
Median (min, max)	439 (217, 654)
Proximal End of Dissection	
n	56
Zone 1	1 (1.8%)
Zone 2	7 (12.5%)
Zone 3	44 (78.6%)
Zone 4 or further distal	4 (7.1%)
Distal End of Dissection	
n	52
Thoracic aorta	3 (5.4%)
Abdominal aorta	14 (25.0%)
Right and left iliacs	14 (25.0%)
Left iliac	11 (19.6%)
Right iliac	10 (17.9%)
Left Common Femoral Minimum Diameter (mm)	
n	49
Mean (SD)	8.8 (1.7)
Median (min, max)	8.7 (3.6, 11.2)
Left Common Iliac Minimum Diameter (mm)	
n	51
Mean (SD)	9.6 (3.9)
Median (min, max)	9.7 (0, 21)
Left External Iliac Minimum Diameter (mm)	
n	49
Mean (SD)	8 (2.2)
Median (min, max)	8.54 (2.49, 11.4)
Right Common Femoral Minimum Diameter (mm)	
n	49
Mean (SD)	8.7 (2.4)
Median (min, max)	8.92 (0, 13)
Right Common Iliac Minimum Diameter (mm)	
n	50

Table 41: Core Laboratory-Reported Baseline CT Measurements (Pro-D)	
	Pro-D (N=56)
Mean (SD)	9.5 (3.7)
Median (min, max)	10.2 (0, 15.3)
Right External Iliac Minimum Diameter (mm)	
n	50
Mean (SD)	8.3 (2.4)
Median (min, max)	8.7 (0, 13.6)
Left Iliac Tortuosity	
n	51
Mean (SD)	1.3 (0.1)
Median (min, max)	1.28 (1.07, 1.66)
Right Iliac Tortuosity	
n	50
Mean (SD)	1.3 (0.2)
Median (min, max)	1.3 (1.06, 2.32)
Right Common Iliac Calcification	
n	53
None	14 (25.0%)
Mild	33 (58.9%)
Moderate	3 (5.4%)
Severe	3 (5.4%)
Right External Iliac Calcification	
n	51
None	39 (69.6%)
Mild	10 (17.9%)
Moderate	1 (1.8%)
Severe	1 (1.8%)
Right Common Femoral Calcification	
n	50
None	28 (50.0%)
Mild	20 (35.7%)
Moderate	1 (1.8%)
Severe	1 (1.8%)
Left Common Iliac Calcification	
n	53
None	17 (30.4%)
Mild	30 (53.6%)
Moderate	4 (7.1%)
Severe	2 (3.6%)
Left External Iliac Calcification	
n	51
None	39 (69.6%)
Mild	11 (19.6%)
Moderate	0
Severe	1 (1.8%)
Left Common Femoral Calcification	
n	50
None	32 (57.1%)
Mild	16 (28.6%)

Table 41: Core Laboratory-Reported Baseline CT Measurements (Pro-D)	
	Pro-D (N=56)
Moderate	2 (3.6%)
Severe	0
Core Laboratory reported data.	

8.4.5. RelayPro Devices Implanted

A total of 98 RelayPro devices were implanted in the study: 39.3% (22/56) of subjects were treated with a single device; 46.4% (26/56) with two; and 14.3% (8/56) with three.

The RelayPro device can be provided in a straight, tapered, and reversed tapered configurations. A device offered in the straight configuration has the same diameter at the proximal and distal ends. A tapered device has a larger proximal diameter than distal diameter, whereas the reverse tapered device has a larger distal diameter than proximal diameter. The use of tapered device shapes (which are part of the standard catalog) in almost a quarter (21.4%, 12/56) of subjects is an indicator of both the dissection pathology and total treatment lengths (mean 207.3±49.5 mm, median 214.5 [Range: 108, 281] mm) which favor a device that can better adapt to the native aortic diameters that typically vary.

Several subjects had their treatment extend proximal to the LSA (14.3%, 8/56 with proximal extent of the dissection <23; 33/56, 58.9% covering the LSA). The RelayPro NBS was used most often out of all RelayPro devices implanted (65.3%, 64/98).

Additionally, many subjects who were treated with more than one device received a combination of NBS and bare stent configurations. Refer to **Table 42**.

Table 42: Pro-D Devices Implanted (Initial Procedure)				
		N=56	NBS*	Bare Stent*
Devices Implanted	1	39.3% (22/56)	34.0% (18/53)	32.1% (17/53)
	2	46.4% (26/56)	37.7% (20/53)	7.5% (4/53)
	3	14.3% (8/56)	3.8% (2/53)	3.8% (2/53)
<i>Total devices implanted*</i>		98	64	31
	Straight	91.1% (51/56)	69.8% (37/53)	35.8% (19/53)
	Tapered	21.4% (12/56)	11.3% (6/53)	13.2% (7/53)
Site reported data. Denominator includes all subjects who received the test device. A subject may have received a single NBS and a single bare stent configuration so it is counted as having two devices implanted in total. Therefore, percentages may total more than 100%. In addition, three subjects do not have proximal stent configuration specified. Subjects with multiple devices implanted may be counted more than once if more than one device shape was used and therefore percentages may sum greater than 100%.				
Many subjects in the study who were treated with more than one device received a combination of NBS and bare stent configurations.				
*Please note that the device configuration (i.e., NBS or proximal bare stent) for three subjects is not known. Therefore, these subjects are not included in the denominators for the NBS or bare stent columns.				
NBS, non-bare stent.				

The most implanted NBS devices were the 34-mm (22.6%, 12/53), 36-mm (32.1%, 17/53), and 38-mm (17.0%, 9/53) proximal diameters. Regarding the proximal bare stent configuration, the most implanted proximal diameters were the 32-mm (13.2%, 7/53) and 36-mm (18.9%, 10/53) (**Table 43**). The distal end of the RelayPro proximal bare stent configuration and NBS configuration are identical: the most common distal diameters were 34-mm and 36-mm (each 35.8%, 19/53) and 32 mm (30.2%, 16/53).

Table 43: Diameter of RelayPro Devices Implanted (Pro-D)			
Diameter (mm)		NBS	Proximal Bare Stent
Proximal	24	0	0
	26	1.9% (1/53)	0

Table 43: Diameter of RelayPro Devices Implanted (Pro-D)		
Diameter (mm)	NBS	Proximal Bare Stent
28	7.5% (4/53)	5.7% (3/53)
30	1.9% (1/53)	0
32	15.1% (8/53)	13.2% (7/53)
34	22.6% (12/53)	7.5% (4/53)
36	32.1% (17/53)	18.9% (10/53)
38	17.0% (9/53)	7.5% (4/53)
40	3.8% (2/53)	1.9% (1/53)
42	1.9% (1/53)	1.9% (1/53)
44	0	0
46	0	0
Distal		
24	0	
26	1.9% (1/53)	
28	11.3% (6/53)	
30	7.5% (4/53)	
32	30.2% (16/53)	
34	35.8% (19/53)	
36	35.8% (19/53)	
38	15.1% (8/53)	
40	5.7% (3/53)	
42	1.9% (1/53)	
44	0	
46	0	

NBS, non-bare stent.
**Please note that three subjects did not have the device configuration listed (i.e., NBS or proximal bare stent. Each subject only received one RelayPro device (straight configuration). These subjects are not included in the denominators.*

8.4.6. Procedural Data

Table 44 summarizes information from the index procedure, including clinical utility endpoints. The majority of procedures were percutaneous (85.5%, 47/55). CSF drainage was used in 33.9% (19/56). Median (IQR) total procedure duration was 100 (80-192) min, and the median implantation duration (endovascular part only) was 17 (10-26) min. Postoperatively, subjects spent a median 81 (50-142) hours in intensive care. Median overall hospitalization was 7 (5-12) days.

Table 44: Pro-D Procedural Details		
	Statistics	Pro-D Subjects (N=56)
Type of Anesthesia		
General Anesthesia	% (n/N)	100.0% (56/56)
Vascular Access		
Left Femoral	% (n/N)	36.4% (20/55)
Right Femoral	% (n/N)	63.6% (35/55)
Vascular Access Method		
Percutaneous	% (n/N)	85.5% (47/55)
Surgical Cut Down	% (n/N)	14.5% (8/55)
CSF Drainage	% (n/N)	33.9% (19/56)
Duration of Procedure (min)	Mean ± SD (N)	138.4±81.44 (56)
	Median (IQR)	100 (80-192)
	Min - Max	49-429

Table 44: Pro-D Procedural Details		
	Statistics	Pro-D Subjects (N=56)
Duration of Implantation (min)	Mean ± SD (N)	23.9±29.78 (54)
	Median (IQR)	17 (10-26)
	Min - Max	1-180
Estimated Blood Loss (cc)	Mean ± SD (N)	167.2±264.1 (53)
	Median (IQR)	100 (50-150)
	Min - Max	10-1500
Transfusion required	% (n/N)	11.1% (6/54)
Duration of ICU Stay (hours)	Mean ± SD (N)	122.5±201.7 (56)
	Median (IQR)	81 (50-142)
	Min - Max	7-1536
Duration of Hospital Stay (days)	Mean ± SD (N)	8.8±4.74 (56)
	Median (IQR)	7 (5-12)
	Min - Max	2-24
Site reported data. CSF, cerebrospinal fluid; ICU, intensive care unit.		

8.4.7. Safety Results

8.4.7.1. Primary Endpoint

The primary endpoint is the rate of all-cause mortality at 30-days post procedure and was compared to a performance goal of 25%, which is consistent with other endovascular graft pivotal studies for acute, complicated Type B dissections. The study could stop for success according to the interim analysis plan and based on a sample size of 50 subjects (which provides at least 80% power to detect one or more rare adverse events that occur at a population rate of 3.2% or greater) and with a p-value ≤0.01317 to cross the boundary.

The primary endpoint (all-cause mortality at 30-days post procedure) was analyzed with the first 50 subjects having completed 30-day follow-up; the result of 2.0% (upper bound of the one-sided 95% CI is 9.1%) was below the 25% performance goal, meaning that the primary endpoint was met (**Table 45**). Further, the calculated p-value met the interim analysis criteria for early stopping for success as the calculated p-value is less than 0.01317.

Table 45: Pro-D Primary Endpoint Analysis		
Characteristic	Statistics	Pro-D N=50
All-cause mortality at 30 days	% (n/N)	2.0% (1/50)
	Upper 95% CI	-, 9.1%
	p-value*	<.0001
*P-value corresponds to the null hypothesis test that the observed value is less than the Primary Endpoint. Performance Goal of 25% based on exact upper one-sided 95% CI. CI, confidence interval.		

A per-protocol analysis was not performed as there are no subjects that would be removed from the intent-to-treat analysis to do a per-protocol analysis.

There was one subject with all-cause mortality at 30-days. This was a 56-year-old male that presented with a complicated Type B aortic dissection, including malperfusion of the kidneys (site reported), extending 65.4 cm in length. The procedure was performed

without complications. The subject was discharged POD 7. He was found dead POD 8. No autopsy was performed and the cause of death is unknown.

8.4.7.2. Supplemental Analysis of Primary Endpoint with full enrollment, N=56

Per study protocol, enrollment continued while 30 day follow-up was being obtained on the initial 50 subjects. Six additional subjects were treated. A supplemental analysis was performed evaluating the primary endpoint using the full study cohort (all 56 subjects). The result of 1.8% (upper bound of the one-sided 95% CI is 8.2%) was below the 25% performance goal, also meeting the performance goal (**Table 46**). For this supplemental analysis, per-protocol analysis was not performed as there are no subjects that would be removed from the intent-to-treat analysis to do a per-protocol analysis.

Table 46: Pro-D Primary Endpoint Supplemental Analysis		
Characteristic	Statistics	Pro-D N=56
All-cause mortality at 30 days	% (n/N)	1.8% (1/56)
	Upper 95% CI	–, 8.2%
	p-value*	<.0001
*P-value corresponds to the null hypothesis test that the observed value is less than the Primary Endpoint. Performance Goal of 25% based on exact upper one-sided 95% CI. CI, confidence interval.		

8.4.7.3. Secondary Safety Endpoints

8.4.7.3.1. Mortality (All-Cause & Dissection-Related)

Dissection related mortality is death due to a rupture, death within 30 days or of a reintervention to treat the dissection, or death from a complication from the dissection. Dissection related mortality was adjudicated by the CEC. One subject expired POD 8 and met the definition for dissection-related mortality as adjudicated by the CEC as it occurred within 30 days of the index procedure.

There have been nine all-cause mortalities (16.1%, 9/56) (**Table 47**). There was a single death within 30 days of implant (1.8% dissection-related mortality) and five deaths in total during the total 30-day follow-up window which extends to 90 days (8.9%, 5/56). Subsequently, there was one death in the six-month window (1.9%, 1/52), one in the 12-month window (2.1%, 1/48), two in the 2-year window (5.6%, 2/46), and none thus far in the 3-year or 4-year window.

Table 47: Pro-D Mortality						
	30 Days	6 Months	12 Months	2 Years	3 Years	Total
Number Eligible	56	52	48	36	18	56
All-Cause Mortality						
	8.9% (5/56)	1.9% (1/52)	2.1% (1/48)	5.6% (2/36)	0	16.1% (9/56)
Dissection-Related Mortality						
	1.8% (1/56)	0	0	0	0	1.8% (1/56)
All deaths are CEC adjudicated for relatedness to the device and/or procedure. Dissection related mortality was also adjudicated by the CEC.						

Kaplan Meier analysis estimated a freedom from All-Cause Mortality to be 98.1% at 30 days, 87.5% at six months, 85.0% at 12 months, 80.8% at two years, and 75.4% at three years (**Figure 6**). Kaplan-Meier analysis estimated a freedom from dissection-related mortality of 98.1% at each interval from 30 days to three years

(Figure 7).

Figure 6: Pro-D Kaplan-Meier Freedom from All-Cause Mortality

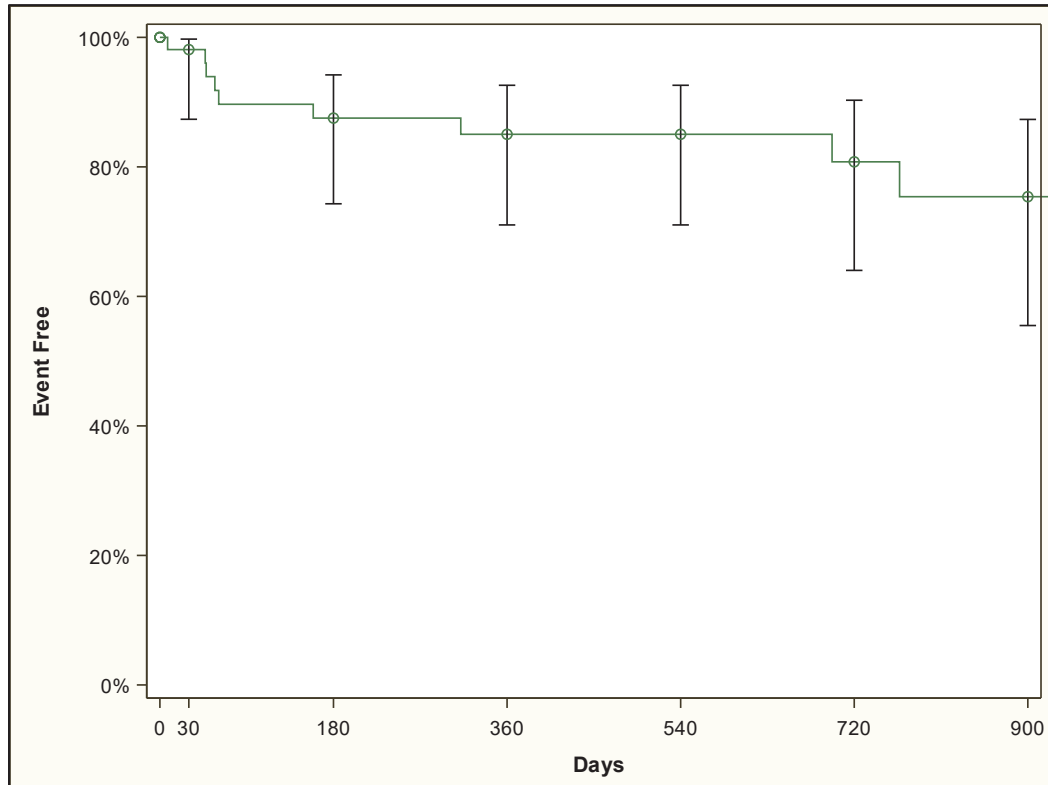

POD	# Entered	# Censored	# Events	Event-free (%)	Greenwood SE (%)	95% CI
0	56	2	0	100.0%	0.0%	-
1-30	54	4	1	98.1%	1.9%	87.4-99.7%
31-180	49	3	5	87.5%	4.8%	74.3-94.2%
181-360	41	8	1	85.0%	5.2%	71.0-92.6%
361-540	32	8	0	85.0%	5.2%	71.0-92.6%
541-720	24	6	1	80.8%	6.5%	64.0-90.3%
721-900	17	10	1	75.4%	8.0%	55.5-87.3%

CI, confidence interval; POD, postoperative day; SE, standard error.

Figure 7: Pro-D Kaplan-Meier Freedom from Dissection-Related Mortality

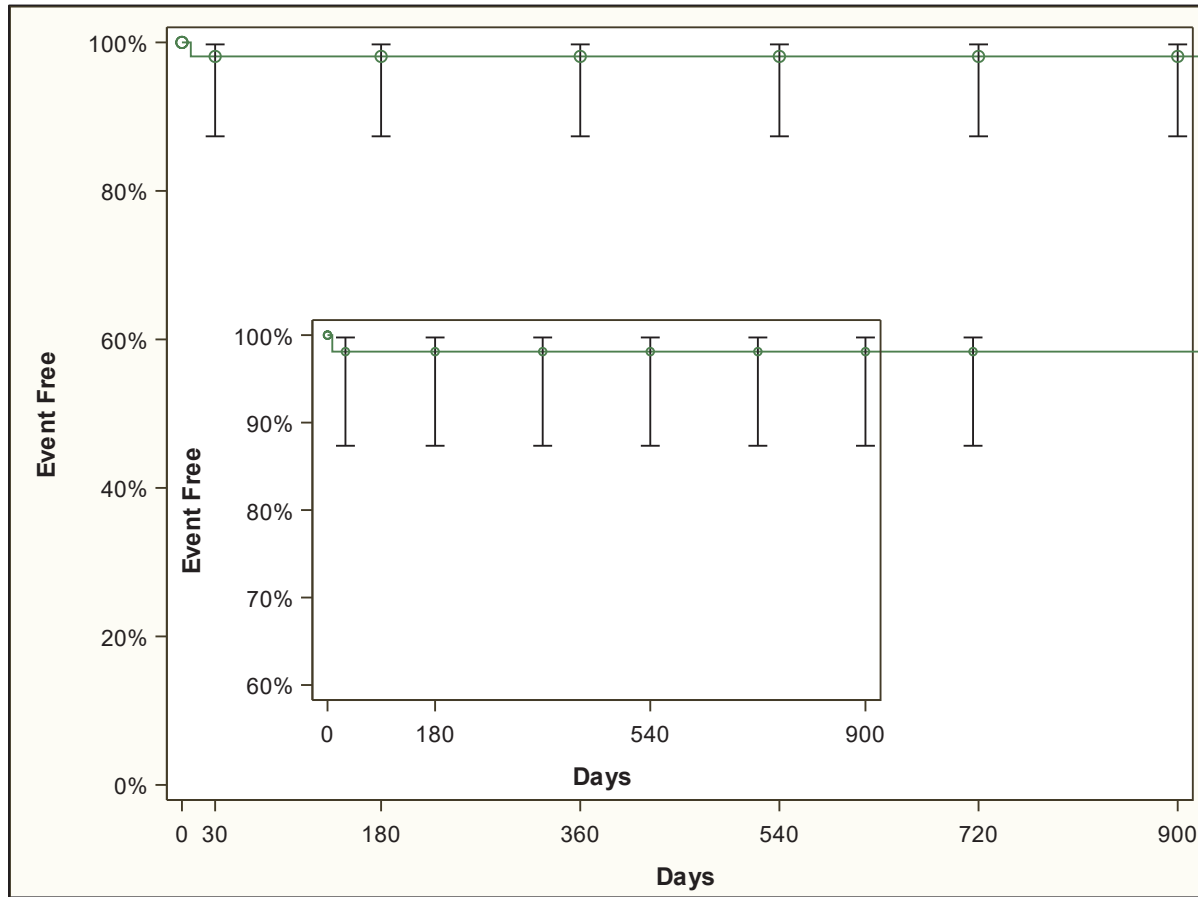

POD	# Entered	# Censored	# Events	Event-free (%)	Greenwood SE (%)	95% CI
0	56	2	0	100.0%	0.0%	-
1-30	54	4	1	98.1%	1.9%	87.4-99.7%
31-180	49	7	0	98.1%	1.9%	87.4-99.7%
181-360	42	10	0	98.1%	1.9%	87.4-99.7%
361-540	32	8	0	98.1%	1.9%	87.4-99.7%
541-720	24	7	0	98.1%	1.9%	87.4-99.7%
721-900	17	11	0	98.1%	1.9%	87.4-99.7%

CI, confidence interval; POD, postoperative day; SE, standard error.

8.4.7.4. Aortic rupture

There have been no Core Laboratory reported aortic or graft ruptures to date. There was one subject with a CEC-adjudicated thoracic aortic rupture in the context of subsequent open surgical thoracoabdominal repair. It is not clear whether the rupture is in the same area that the RelayPro devices were located. Additionally, this observation was not Core Laboratory reported nor was it listed in the clinical notes or imaging studies for this subject.

8.4.7.5. Major Adverse Events

Major adverse events (MAEs) were CEC adjudicated. Seven MAEs were reported in six subjects (10.7%), all within 30-days, including the following: paraplegia (n=3), paraparesis (n=2), disabling stroke (n=1), and renal

failure (n=1). One subject had two events (renal failure and paraplegia).

Kaplan-Meier analysis estimated a freedom from MAEs of 89.1% at each interval from 30 days to three years (Figure 8).

Figure 8: Pro-D Kaplan-Meier Freedom from Major Adverse Events (MAEs)

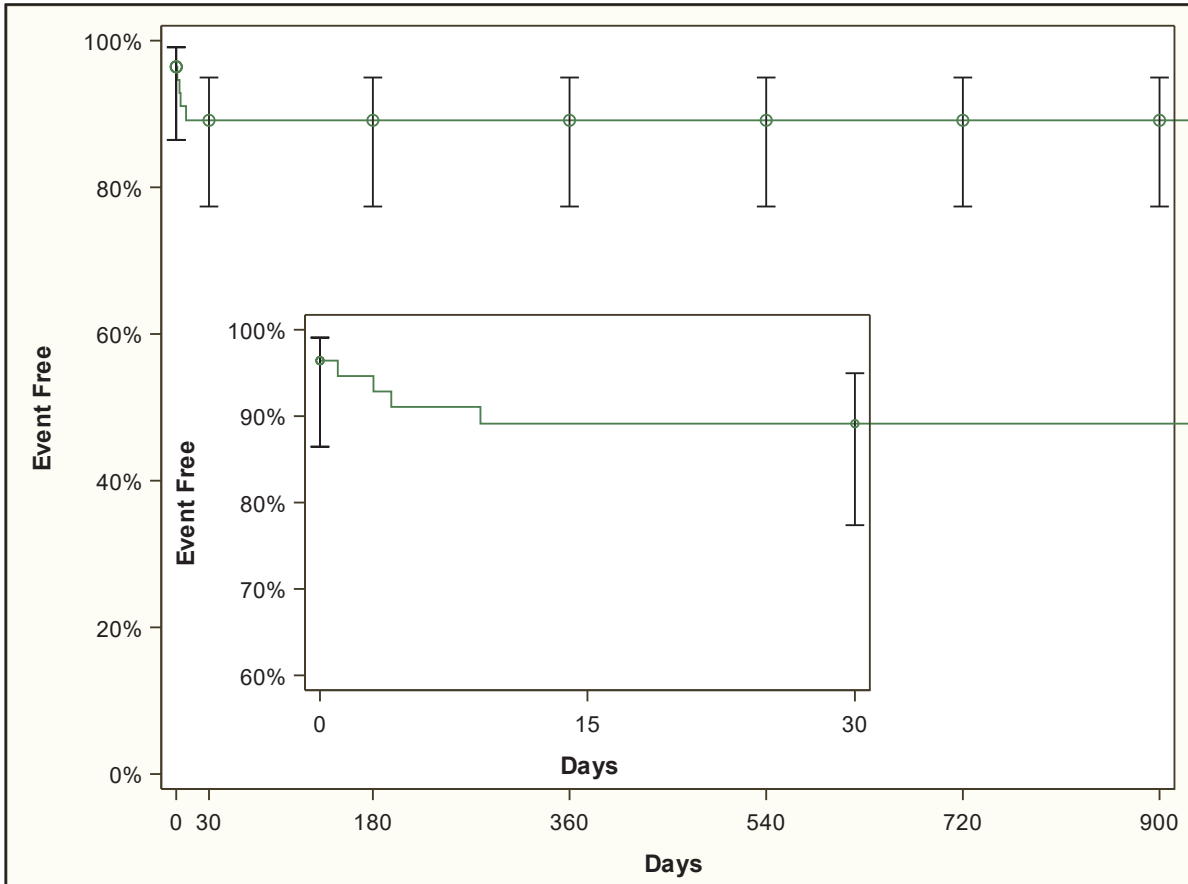

POD	# Entered	# Censored	# Events	Event-free (%)	Greenwood SE (%)	95% CI
0	56	0	2	96.4%	2.5%	86.5-99.1%
1-30	54	7	4	89.1%	4.2%	77.4-95.0%
31-180	43	5	0	89.1%	4.2%	77.4-95.0%
181-360	38	10	0	89.1%	4.2%	77.4-95.0%
361-540	28	6	0	89.1%	4.2%	77.4-95.0%
541-720	22	6	0	89.1%	4.2%	77.4-95.0%
721-900	16	11	0	89.1%	4.2%	77.4-95.0%

CI, confidence interval; POD, postoperative day; SE, standard error.

Table 48 presents all MAEs adjudicated by the CEC; once an event is reported it continues to be reported in the “to date” row.

Table 48: Pro-D Summary of MAEs (CEC adjudicated)						
MAE	30 Days	6 Months	12 Months	2 Years	3 Years	Total
Number Eligible	56	52	48	36	18	-
Subjects with ≥1 MAE	10.7% (6/56)	0	0	0	0	6
MAEs (Total)	7	0	0	0	0	7
Stroke (disabling)						
New	1	0	0	0	0	-
To Date	1.8% (1/56)	1.9% (1/53)	2.0% (1/49)	2.7% (1/37)	5.3% (1/19)	1
Renal Failure						
New	1	0	0	0	0	-
To Date	1.8% (1/56)	1.9% (1/52)	2.1% (1/48)	2.8% (1/36)	5.3% (1/19)	1
Paraplegia						
New	3	0	0	0	0	-
To Date	5.4% (3/56)	5.7% (3/53)	6.1% (3/49)	8.1% (3/37)	15.0% (3/20)	3
Paraparesis						
New	2	0	0	0	0	-
To Date	3.6% (2/56)	3.8% (2/52)	4.2% (2/48)	5.4% (2/37)	10.0% (2/20)	2

Note that once an event is reported it continues to show up in the “to date” row in the table.
 All MAEs were adjudicated by the CEC using these definitions of the individual MAE components:

- Stroke (disabling): A sudden, non-convulsive loss of neurological function due to an ischemic or hemorrhagic intracranial vascular event defined as focal neurological deficits that impair the subject’s day-to-day life as assessed by the CEC members, lasting for 365 days or longer.
- Renal failure: Rise in creatinine >50% above pre-procedure level, resulting in a creatinine level above high normal that does not resolve, and requires prolonged renal replacement therapy
- Paraplegia: Paralysis of both lower extremities and, generally, lower trunk
- Paraparesis: Partial paralysis of lower limbs

CEC, clinical events committee; MAE, major adverse event.

8.4.7.6. Device-Related Adverse Events

Adverse events adjudicated by the CEC as being device-related are summarized in **Table 49**. This table includes both AEs and SAEs and is sorted by MedDRA SOC and PT: 28.6% (16/56) of subjects experienced one or more device-related adverse events with the most frequently reported being stent-graft endoleaks (12 subjects; 21.4%) which were coded to the SOC of General Disorders and Administration Site Conditions.

For the 12 subjects that have been site-reported as endoleaks, the Core Laboratory noted false lumen perfusion in 11 subjects, namely Type R (7 subjects), Type II (2 subjects), Type II & Type R (2 subjects), and Type Ia & Type R (1 subject). The Case Report Forms (CRFs) for the study did not have a field for reporting false lumen perfusion, resulting in the sites reporting this observation as an endoleak. Please reference **Section 8.4.8.12** for a discussion of any interventions completed in these subjects.

The following definitions were utilized for the above Core Laboratory assessment of false lumen perfusion for the 12 subjects with a site-reported endoleak:

- Type Ia entry flow is a perigraft leak at the proximal edge of the stent-graft that allows continued antegrade flow into the false lumen through the primary entry tear.
- Type Ib entry flow is a distal perigraft leak caused by a tear in the intimal membrane adjacent to the distal edge of the endograft (distal stent graft-induced new entry [SINE]).
- Type II entry flow is continued retrograde false lumen perfusion through an arch branch (e.g., left subclavian artery) or intercostal or bronchial artery.

- Type R entry flow is antegrade flow from the true lumen to the false lumen through septal, visceral, or distal fenestrations.

Table 49: Pro-D Summary of CEC Adjudicated Device-Related Adverse Events	
MedDRA System-Organ Class Preferred Term Adverse Event	Pro-D Subjects (N=56)
Subjects with at least one Device-Related Adverse Event	16 (28.6%)
General disorders and administration site conditions	11 (19.6%)
Complication associated with device	1 (1.8%)
Stent-graft endoleak	12 (21.4%)
Musculoskeletal and connective tissue disorders	1 (1.8%)
Muscular weakness	1 (1.8%)
Nervous system disorders	3 (5.4%)
Paralysis	1 (1.8%)
Paraplegia	1 (1.8%)
Spinal cord ischaemia	1 (1.8%)
Product issues	1 (1.8%)
Device dislocation*	1 (1.8%)
Surgical and medical procedures	1 (1.8%)
Surgery	1 (1.8%)
Vascular disorders	5 (8.9%)
Aortic aneurysm [†]	3 (5.4%)
Aortic dilatation [§]	1 (1.8%)
Aortic dissection	1 (1.8%)

Data are presented as n (%). Percentages are based on the number of subjects in the Safety Evaluable Population. Event verbatim terms are reported by sites. The events listed in this table are coded using MedDRA version 22.0 and then stratified by System-Organ Class (SOC) and Preferred Term. Subjects may be counted in this table more than once by Preferred Term but are only counted once in the SOC summary line. Device Relatedness adjudicated by the CEC.

* One subject had a site reported device dislocation (site reported migration). At the one-year follow-up, the site reported misalignment, migration, and expansion with no endoleak. The Core Laboratory reported Type Ia endoleak and migration due to “dilatation at the proximal end of the device”. A secondary intervention (conversion to open surgery) was completed POD 529.

† Three subjects were reported with device-related aortic aneurysm. One subject had a CEC-adjudicated aortic rupture in the context of subsequent open surgical thoracoabdominal repair. A second subject had an aortic arch aneurysm that was mentioned in the source documentation; however, only in the context of a site reported Type II endoleak and not otherwise detailed. A third subject had aortic lengthening, increased size and opacification of the false lumen that appears to have arisen from a previously coiled LSA, suggestive of a Type II endoleak. This subject was also noted to have aneurysm dilatation of the thoracoabdominal aorta at the diaphragmatic hiatus.

§ Expansion of 5 mm noted by the site at six months. The Core Laboratory reported an increase <5 mm. No intervention was performed. The subject completed four-year follow-up and maximum thoracic aortic diameter has decreased at each follow-up since the original observation.

|| Subject was noted on POD 40 to have a tear that appears to have begun at the most proximal aspect of the endovascular graft and involved the aortic arch, as well as the ascending aorta. Core Laboratory analysis confirmed a retrograde dissection. She underwent emergency surgery, where a branched open surgical graft was placed to replace the aortic arch and the ascending aorta. Subject was discharged on POD 44.

8.4.7.7. Procedure-Related Adverse Events

Adverse events adjudicated by the CEC as being procedure-related are summarized in **Table 50**. This table includes both AEs and SAEs and is sorted by MedDRA SOC and PT. Eighteen subjects (32.1%, 18/56) experienced one or more procedure-related adverse events. The most commonly occurring events were within the MedDRA System-Organ Class of nervous system disorders (16.1%, 9/56):

Table 50: Pro-D Summary of CEC Adjudicated Procedure-Related Adverse Events	
MedDRA System-Organ Class Preferred Term Adverse Event	Pro-D Subjects (N=56)
Subjects with at least one Procedure-Related Adverse Event	18 (32.1%)
General disorders and administration site conditions	5 (8.9%)
Death	1 (1.8%)
Stent-graft endoleak	4 (7.1%)
Investigations	1 (1.8%)
Pulse absent	1 (1.8%)
Musculoskeletal and connective tissue disorders	2 (3.6%)
Compartment syndrome	1 (1.8%)
Muscular weakness	1 (1.8%)
Nervous system disorders	9 (16.1%)
Cerebellar infarction	1 (1.8%)
Dysarthria	1 (1.8%)
Embolic stroke	1 (1.8%)
Haemorrhagic transformation stroke	1 (1.8%)
Hemiparesis	1 (1.8%)
Ischaemic stroke	1 (1.8%)
Paralysis	1 (1.8%)
Paraplegia	1 (1.8%)
Spinal cord ischaemia	2 (3.6%)
Psychiatric disorders	1 (1.8%)
Delirium	1 (1.8%)
Mental status changes	1 (1.8%)
Renal and urinary disorders	1 (1.8%)
Acute kidney injury	1 (1.8%)
Surgical and medical procedures	1 (1.8%)
Arterial repair	1 (1.8%)
Vascular disorders	2 (3.6%)
Aortic dissection	1 (1.8%)
Poor peripheral circulation	1 (1.8%)
Data are presented as n (%).	
Percentages are based on the number of subjects in the Safety Evaluable Population.	
Event verbatim terms are reported by sites. The events listed in this table are coded using MedDRA version 22.0 and then stratified by System-Organ Class (SOC) and Preferred Term. Subjects may be counted in this table more than once by Preferred Term but are only counted once in the SOC summary line.	
Procedure Relatedness adjudicated by the CEC.	

8.4.8. Effectiveness Results

8.4.8.1. Secondary Effectiveness Endpoints

Technical success at the time of the index procedure was 100%.

For the 30-day window, there were 5 all-cause mortalities, including 1 dissection-related mortality. There were no instances of endoleak, rupture, losses of device integrity, or losses of patency. Treatment success was 85.7% (48/56) and dissection treatment success was 84.0% (42/50). At 30-days (Day 0 – 90), six subjects had 7 secondary interventions completed that were related to the device or pathology (CEC adjudicated). No conversions to open surgery were performed.

At 6 months, For the 6-month window, there was 1 all-cause mortality, one Type Ia endoleak (Core Laboratory reported), one migration (Core Laboratory reported), and one Core Laboratory reported aortic expansion. There were no instances of lesion-related mortality, rupture, losses of device integrity, or losses of patency. Dissection treatment success was 97.0% (32/33). For the 6-month window (Day 91-270), two subjects had 3 interventions performed to address the device or pathology (CEC adjudicated). No conversions to open surgery were performed.

For the 12-month window, there was 1 all-cause mortality, 1 persisting Type Ia endoleak, one persisting migration reported by the Core Laboratory, and 2 Core Laboratory reported aortic expansions (one new and one persisting). There were no instances of dissection-related mortality, rupture, losses of patency, or losses of device integrity. Dissection treatment success was 93.5% (29/31). For the 12-month window (Day 271-540), four subjects had 4 secondary interventions completed that were related to the device or pathology (CEC adjudicated). There was 1 conversion to open surgery performed.

For the 2-year window, there were 2 all-cause mortalities, 2 new Core Laboratory reported aortic expansions, 2 new Core Laboratory reported migrations, and one CEC adjudicated rupture (rupture was not Core Laboratory reported) reported. There were no instances of dissection-related mortality, losses of patency, or losses of device integrity. Dissection treatment success was 88.9% (16/18). For the 2-year window (Day 541-900), 1 subject had 1 secondary intervention completed that were related to device/pathology (CEC adjudicated), specifically one conversion to open surgery (in the subject with the CEC adjudicated aortic rupture).

For the 3-year follow-up visit, there are 9 subjects with a visit performed (7 subjects with CT scan and X-rays completed). Dissection treatment success was 100% (7/7). For the 3-year window, there were no instances of all-cause mortality, dissection-related mortality, rupture, endoleak, losses of device integrity, losses of patency, migration, aortic expansion, secondary intervention or conversion to open surgery.

For the 4-year follow-up visit, there were 2 subjects with data available for the visit, including CT scan and X-rays completed. For the 4-year window, there were no all-cause mortality, effectiveness-related observations, or secondary interventions reported.

Table 51: Pro-D Summary of Endpoints

	30 Days	6 Months	12 Months	2 Years	3 Years	Total
Treatment Success¹	85.7% (48/56)	NA	NA	NA	NA	-
Dissection Treatment Success²	84.0% (42/50)	97.0% (32/33)	93.5% (29/31)	88.9% (16/18)	100.0% (7/7)	-
All-Cause Mortality	8.9% (5/56)	1.9% (1/52)	2.1% (1/48)	5.6% (2/36)	00	9
Dissection-Related Mortality	1.8% (1/56)	0	0	0	0	1
Aortic Rupture³	0	0	0	0	0	0
Type Ia Endoleaks	0	3.3% (1/30)	3.3% (1/30)	0	0	1
Type Ib Endoleaks	0	0	0	0	0	0
Type III Endoleaks	0	0	0	0	0	0
Loss of Patency	0	0	0	0	0	0
Kinking	0	0	0	0	0	0
Twisting	0	0	0	0	0	0
Misalignment/Birdbeaking	0	0	0	0	0	0
Loss of Integrity	0	0	0	0	0	0
Stent fracture	0	0	0	0	0	0
Migration (>10 mm)	NA	3.0% (1/33)	3.2% (1/31)	11.1% (2/18)	0	3
Aortic Expansion (>5 mm)	NA	2.9% (1/34)	6.3% (2/32)	10.5% (2/19)	0	4
Secondary Intervention⁴	10.7% (6/56)	3.8% (2/52)	8.3% (4/48)	2.8% (1/36)	0	13

1. Treatment success defined as individual components and as a composite:

a. Absence of major adverse events (stroke, renal failure, paraplegia, paraparesis)

Table 51: Pro-D Summary of Endpoints						
	30 Days	6 Months	12 Months	2 Years	3 Years	Total
b. Absence of perfusion into the false lumen through the primary intimal tear; c. Absence of retrograde extension of the dissection; 2. Dissection treatment success defined as individual endpoints and as a composite: a. Absence of expansion (>5 mm) in the aorta that has an endograft b. Absence of aortic rupture; c. Absence of dissection-related mortality; d. Absence of MAEs including new ischemia due to branch vessel compromise; e. Absence of false lumen perfusion separated by location f. Absence of new aortobronchial/tracheal or aortoenteric fistula formation; g. Absence of unintentional rupture of the dissection septum; 3. Core Laboratory reported rupture 4. Secondary interventions (CEC adjudicated) related to the device or treated pathology.						

8.4.8.2. *Technical Success*

Technical Success at the time of the index procedure, is defined as: Successful delivery and deployment of the device, including withdrawal of the delivery system. The table below presents site-reported technical success. Technical success is 100% (56/56) with all primary entry tears covered (56/56, 100%). The stent-graft was reported as accurately deployed and patent, with integrity maintained for all subjects. Further, there were no procedures completed related to the inability to withdraw the delivery system.

Although considered a technical success and reported as accurately deployed by the site investigator, one subject had a deployment of the RelayPro device (proximal bare stent configuration) with a twist/kink. During advancement of the inner sheath from the outer sheath, the deployment was noted as stiff and had significant resistance during pullback. The investigator paused the deployment, resulting in the graft falling back approximately 8-10 mm distal of intended landing site (proximal to the LSA as this patient’s dissection extended to Z2). The site reported a proximal landing zone of only 13.5 mm, which is possibly why the LSA was covered. There was no subject injury or sequelae as a result of this at time of index procedure nor was there any issues observed on the following day.

Although described as “additional treatment beyond standard of care” (26/56, 46.4%), these procedures were mostly supra-aortic trunk (SAT) revascularizations (33/56, 58.9% of TEVARs were <Z3), which is generally considered standard of care. Also, several subjects had LSA coil embolization standardly after SAT revascularization, this was reported as an additional procedure in one subject to correct a Type II endoleak.

Nine subjects had additional stents placed during the index procedure (9/56, 16.1%). All additional stents were bare metal stents. Seven subjects had stents placed in the visceral or iliac arteries; two subjects had stents placed in the aorta. Of the 2 subjects with additional stents placed in the aorta, one subject had a competitive bare metal stent overlapping with the distal end of the RelayPro and a second subject had a bare metal stent placed distal to the RelayPro (not overlapping with the RelayPro).

During follow-up, three subjects within 30 days; one at two years had a retrograde dissection. Two subjects had their observations confirmed by the Core Laboratory.

One subject was reported with vascular access difficulties/complications: this was due to Perclose failure.

There was no conversion to open repair during the index procedure. A data entry error indicated one subject as a conversion to open repair (noted in the below table). The site confirmed by email (18 Jul 2022) that there had been previous open repair (prior to study participation) and no conversion to open repair as part of this study.

Table 52: Pro-D Summary of Technical Success and Procedure-Related Information (Site Reported)	
Device Assessment*	Pro-D Subjects (N=56)
Technical Success at Index Procedure	56 (100.0%)
Evaluation of RelayPro System	
Stent-Graft Deployed	56 (100.0%)
Deployment Without Stent-Graft Kinking or Twisting [#]	55 (98.2%)
Accuracy of Relay System Deployment Acceptable [#]	56 (100.0%)
Stent-Graft Patent	56 (100.0%)
Stent-Graft Integrity Maintained (no wire fracture)	56 (100.0%)
Performed Without Unplanned Vascular Access Difficulties or Complications	55 (98.2%)
Additional Treatment Required Beyond Standard of Care	
LSA Revascularized	15 (26.8%)
Stent Placement [§]	9 (16.1%)
Other †	7 (12.5%)
Corrected Endoleak ††	1 (1.8%)
Balloon Dilation	1 (1.8%)
Vascular Access	
Right Femoral	35 (62.5%)
Left Femoral	20 (35.7%)
Placement of the Proximal End of the Covered Portion of the Device	
Proximal to the LSA	33 (58.9%)
Distal to the LSA	22 (39.3%)
Final Procedure Result	
Primary Tear Covered	56 (100.0%)
Absence of retrograde extension of the dissection	48 (85.7%)
Conversion to Open Repair ‡	1 (1.8%)
Other Outcomes §	3 (5.4%)
<p>Site reported data. All values expressed as n (%).</p> <p>*The device assessment was performed at the time of the procedure. (Site reported data.)</p> <p>† “Other Additional Treatment” comprises: LSA coiling; angioplasty balloon mid-external iliac artery; excised dissection of left SFA; right femoral artery repair secondary to Perclose failure.</p> <p>†† Type II endoleak</p> <p>‡ A data entry error indicated a conversion to open repair.</p> <p>§ “Other outcomes” comprise LLE fasciotomy, restoration of blood flow to right lower extremity (a subject who had pre-existing lower extremity malperfusion), and misalignment at celiac that did not result in any correction, however.</p> <p>LSA, left subclavian artery.</p> <p># See paragraph preceding the table regarding a case that was noted by the site to have accurate deployment; however, the site noted that the device was deployed distally to the intended site.</p> <p>§ Nine subjects had additional stents placed during the index procedure (9/56, 16.1%). All additional stents were bare metal stents. Seven subjects had stents placed in the visceral or iliac arteries; two subjects had stents placed in the aorta.</p>	

8.4.8.3. Treatment Success at 30 days

Treatment success at 30 days was achieved in 85.7% of subjects (48/56) (Table 53). A total of 10 events/observations were reported in eight subjects: paraplegia (n=3), paraparesis (n=2), disabling stroke (n=1), renal failure (n=1); apart from the seven MAEs, two subjects were reported with false lumen perfusion through the primary intimal tear, and one with retrograde extent of the dissection. Two subjects had two events/observations each: one subject (renal failure and paraplegia); second subject (paraparesis, false lumen perfusion through the primary intimal tear).

Table 53: Pro-D Treatment Success at 30-Days	
	Pro-D Subjects (N=56)
Treatment Success at 30 days	85.7% (48/56)
Freedom from MAEs at 30 days	89.3% (50/56)
Stroke (disabling)	1.8% (1/56)
Paraplegia	5.4% (3/56)
Paraparesis	3.6% (2/56)
Renal Failure (excluding pre-existing)	1.8% (1/56)
Absence of false lumen perfusion through the primary intimal tear	95.7% (45/47)
Absence of retrograde extension of the dissection	97.9% (46/47)
CEC and Core Laboratory reported data. Core Laboratory reported data (e.g., false lumen perfusion through the primary intimal tear) is based on subjects with adequate imaging for that parameter.	

8.4.8.4. Dissection Treatment Success by Timepoint

Dissection treatment success was achieved in 84.0% (42/50) of subjects at 30 days, 97.0% (32/33) at six months, 93.5% (29/31) at one year, 88.9% (16/18) at two years, and 100% (7/7) at three years. The specific components of dissection treatment success are discussed in more detail in the corresponding event/observation sections.

There was one subject with a CEC-adjudicated aortic rupture. However, this rupture was not Core Laboratory reported and so is not presented in the definition of dissection treatment success.

Table 54: Dissection Treatment Success by Timepoint					
	30 Days	6 Months	12 Months	2 Years	3 Years
Dissection treatment success					
	84.0% (42/50)	97.0% (32/33)	93.5% (29/31)	88.9% (16/18)	100.0% (7/7)
Absence of aortic expansion (>5 mm)					
	NA	97.1% (33/34)	93.8% (30/32)	89.5% (17/19)	100.0% (7/7)
Absence of aortic rupture*					
	100.0% (50/50)	100.0% (34/34)	100.0% (32/32)	100.0% (19/19)	100.0% (7/7)
Absence of dissection-related mortality					
	98.2% (55/56)	100.0% (52/52)	100.0% (48/48)	100.0% (36/36)	100.0% (19/19)
Absence of MAE					
	89.3% (50/56)	100.0% (52/52)	100.0% (48/48)	100.0% (36/36)	100.0% (19/19)
Absence of ischemia due to vessel branch compromise					
	100.0% (56/56)	100.0% (52/52)	100.0% (48/48)	100.0% (36/36)	100.0% (19/19)
Absence of false lumen perfusion from primary intimal tear					
	95.7% (45/47)	100.0% (30/30)	100.0% (30/30)	100.0% (17/17)	100.0% (6/6)
Absence of new aortic fistula formation					
	100.0% (48/48)	100.0% (32/32)	100.0% (31/31)	100.0% (18/18)	100.0% (7/7)
Absence of unintentional rupture of dissection septum					
	100.0% (49/49)	100.0% (34/34)	100.0% (31/31)	100.0% (19/19)	100.0% (7/7)
<p>Core Laboratory and CEC reported data. Core Laboratory reported data (e.g., false lumen perfusion through the primary intimal tear) is based on subjects with adequate imaging for that parameter.</p> <p>Treatment success is a composite endpoint: the first row presents the component percentage with the individual components listed in the subsequent rows.</p> <p>Denominators vary by row and timepoint based on the number of subjects eligible or those with imaging adequate to assess that parameter.</p> <p>MAE, major adverse event; NA, not applicable.</p> <p>* There have been no Core Laboratory reported thoracic aortic or graft ruptures to date. There was one subject with a CEC-adjudicated thoracic aortic rupture in the context of subsequent open surgical thoracoabdominal repair. This observation was not Core Laboratory reported nor was it listed in the clinical notes or imaging studies. No additional information is currently available beyond it was in the thoracic aorta.</p>					

8.4.8.5. *Migration*

The protocol defines device migration as the longitudinal movement of all or part of a stent or attachment system for a distance >10 mm relative to anatomical landmarks that were determined at the first post-procedural imaging study, as measured by the Core Laboratory. In the pivotal study, 34 subjects at six months, 32 at one year, 19 at two years, 7 at three years, and 2 at four years had imaging adequate to assess migration. There have been three subjects with migrations reported, specifically in one subject at six and 12 months and two subjects at two years. Each of the subjects with Core Laboratory migration also had aortic lengthening reported by the Core Laboratory.

A brief overview of these cases are described below:

- One subject had proximal migration (distal direction) and aortic lengthening of the treated segment identified by the Core Laboratory on the 2-year imaging. At all timepoints, the length of aorta covered by the implants, including the amount of device overlap was maintained. Additionally, review of the imaging shows that there is aortic elongation between the LSA and Celiac Artery. The observed migration is likely due to aortic lengthening. No perfusion through the primary entry tear was observed at any follow-up timepoint. The subject has not had any intervention to address this

observation.

- One subject had Core Laboratory reported Type Ia endoleak, aortic lengthening of the treated segment, and distal migration of the proximal end of the stent-graft on the 6-month and 12-month imaging; no aortic expansion was noted at either timepoint by the Core Laboratory. Review of the imaging shows that there was aortic remodeling proximally, as well as aortic elongation and dilatation, and the device adapted to the change in the aorta. The length of aorta covered by the implant did not change over the 6-months and no distal movement (of the distal end of the device) was noted by the Core Laboratory. After presenting with radiating chest pain and hypertension, subject was hospitalized to address the observations. The Type Ia endoleak was treated unsuccessfully with a proximal extension, and the subject ultimately underwent ascending and total arch replacement with a frozen elephant trunk with reimplantation of the innominate artery and LCCA using a surgical graft (POD 529).
- At 19-months post operatively, the Core Laboratory reported the following: the proximal end of the device migrated distally on the 2-year imaging, aortic lengthening in the treated segment, an increase in aortic diameter, and also confirmed the new dissection proximal to the LSA. This subject had a CEC adjudicated aortic rupture; however, this observation was not Core Laboratory reported nor was it listed in the clinical notes or imaging studies. Review of the imaging suggests that disease progression (development of new dissection and focal aneurysm) and also aortic elongation contributed to the migration observation reported. Additionally, the length of aorta covered by the implant did not change over time. Subject underwent a Type II TAAA open surgical repair with a surgical graft.

Table 55: Pro-D Core Laboratory Assessed Stent-Graft Migration						
	1 Month	6 Months	12 Months	2 Years	3 Years	Total
Adequate Imaging	51	33	31	18	7	-
Migration (>10 mm)	Baseline*	3.0% (1/33)	3.2% (1/31)	11.1% (2/18)	0	3

Core Laboratory reported data. Migration reported in three subjects: one at 6,12 months; two at 24 months.
 * First post-procedure measurement (within the 30-day follow-up analytical window) is used for baseline measurement.

8.4.8.6. All Endoleaks

There is adequate imaging to assess endoleaks in 48 subjects at 30 days, 30 at 6 and 12 months, 17 at 2 years, 6 at 3 years, and 2 at 4 years. There was one Core Laboratory reported Type Ia endoleak observed at the 6-month visit that persisted to the 12-month visit. This subject also had Core Laboratory reported migration and expansion. A secondary intervention was completed on POD 529 to address the observations.

No Type Ib, Type II, Type III, Type IV, or endoleaks of unknown types have been reported by the Core Laboratory at any timepoint.

In this study, the sites reported endoleaks as adverse events. Additionally, the case report forms (CRFs) for the study did not have a field for reporting false lumen perfusion; therefore, this was also reported as an endoleak. In summary, the following endoleaks were site-reported: 4 subjects with a Type Ib endoleak, 3 subjects with a Type Ia endoleak, 2 subjects with a Type II endoleak, and 3 subjects with multiple endoleaks (one with Type Ia and Ib endoleak, one with Type I and III endoleak, and one with Type II, Ib, and III endoleak). For the 12 subjects that have been site-reported as endoleaks, the Core Laboratory noted false lumen perfusion in 11 subjects. Reinterventions were performed to address some of the site reported endoleaks. Please refer to **Section 8.4.7.6** and **Section 8.4.8.12** for additional information.

8.4.8.7. Component Separation

Component separation is defined as complete separation of any stent-graft components and is assessed by the Core Laboratory. There have been no component separations noted by the Core Laboratory in any subject at any timepoint to date.

8.4.8.8. Aortic Expansion

The protocol defines aortic expansion as a change >5 mm in total aortic diameter from the first post procedural imaging. These assessments are based on Core Laboratory measurements. Four subjects were noted by the Core Laboratory to have aortic expansion through available follow-up. Aortic expansion was noted in 1 subject at 6-months (2.9%, 1/34), 1 new & 1 persisting expansion at 12-months (6.3%, 2/32), 2 new aortic expansions at 2-years (10.5%, 2/19), and no aortic expansions reported at the 3-year and 4-year follow-up visits.

Table 56: Pro-D Changes in Aortic Diameter (Core Laboratory)					
	6 Months	12 Months	2 Years	3 Years	Total
Adequate Imaging	34	32	19	7	-
Increase >5 mm					
New	2.9% (1/34)	3.1% (1/32)	10.5% (2/19)	0	4
Persistent	0	3.1% (1/32)	0	0	-
Total	2.9% (1/34)	6.3% (2/32)	10.5% (2/19)	0	-
Decrease	20.6% (7/34)	18.8% (6/32)	31.6% (6/19)	14.3% (1/7)	-
No Change	76.5% (26/34)	75.0% (24/32)	57.9% (11/19)	85.7% (6/7)	-
Core Laboratory reported data. All values expressed as % (n/N). Aortic expansion noted in 1 subject at 6-months that persisted to 12-months; 1 subject at 12-months, and 2 subjects at 2 years Baseline based on first post-procedure measurement made within the 30-day follow-up analytical window.					

8.4.8.9. Patency

All devices have been reported as patent at all timepoints by the Core Laboratory. There have been no observations of stenosis, kinking, twisting, misalignment or bird beak in any subject at any timepoint as of the data cut. As described above in **Section 8.4.8.2**, one subject had a deployment of the RelayPro device with a twist/kink. There was no subject injury or sequelae as a result of this at time of index procedure nor were there any issues observed on the following day.

8.4.8.10. Device Integrity

The secondary endpoints for this study include both loss of device integrity, as well as stent fracture in the attachment zone. The clinical protocol defines stent fracture as “fracture or breakage of any portion of the RelayPro stent in the attachment zone, including metallic fracture.” These secondary endpoints are assessed by the Core Laboratory with x-ray and CT imaging or may be reported by the site.

No suture breaks or fractures (site reported or Core Laboratory reported) have been reported in any subject at any follow-up visit.

8.4.8.11. Device- or Lesion-Related Events/Observations

Device or lesion-related events and observations include retrograde dissection beyond the LSA, false lumen perfusion, rupture of the dissection septum, fistula formation (aortobronchial, aortoenteric, tracheal), stent graft stenosis, device kink, device twist, suture break visualized, misalignment/bird beak, as well as extrusion/erosion. These events and observations were reported by the Core Laboratory. Please note that false lumen status was not captured in the clinical study.

False lumen perfusion through the primary intimal tear was reported by the Core Laboratory in two subjects at

30-days (2/51, 3.9%). Additional information on these cases is noted below:

- For one subject, no secondary intervention was required to address the false lumen perfusion, and no false lumen perfusion was found at subsequent visits. The subject did have two interventions noted in **Section 8.4.8.12**, specifically to address right lower extremity malperfusion and 1 intervention due to spinal cord ischemia in the 30-day window.
- In the case of the second subject, it appears that the site interpreted this as a Type Ia endoleak; no secondary interventions were completed for false lumen perfusion, and the subject was lost to follow-up.

All other false lumen perfusion (except for one subject reported at the LSA/Type II false lumen perfusion and also a Type R false lumen perfusion) was reported below the level of the celiac and, therefore, beyond the treatment zone.

There were two new retrograde dissections reported by the Core Laboratory, one at 30 days (and therefore counted as treatment failure, **Table 52**) and one at two years.

At the time of the data freeze, there were no Core Laboratory reported ruptures; however, there was one patient with a CEC-adjudicated aortic rupture.

There were no ruptures of the dissection septum, fistula formation (aortobronchial, aortoenteric, tracheal), stent-graft stenosis, device kink (compression), device twist, suture breaks visualized, misalignment/bird beak, or extrusion/erosion through available 4-year data. Please note that only 2 subjects had 4-year data available at the time of data freeze.

Table 57: Pro-D Device or Lesion-Related Secondary Endpoint Events by Follow-up Visit

	1 Month	6 Months	1 Year	2 Years	3 Years	Total
Number with Adequate Imaging	51	34	32	19	7	-
Retrograde Dissection (beyond LSA)	1 (2.1%)	0	0	1 (5.6%)	0	2
New	1	-	-	1	-	-
Persistent	0	-	-	0	-	-
False Lumen Perfusion	44 (91.7%)	27 (87.1%)	25 (83.3%)	15 (83.3%)	6 (100.0%)	-
New	44	3	3	2	2	-
Persistent	0	24	22	13	4	-
Source of False Lumen Perfusion						
Primary Intimal Tear ^a	2 (4.3%)	0	0	0	0	2
Celiac Artery	13 (72.2%)	5 (55.6%)	5 (50.0%)	1 (25.0%)	1 (100.0%)	-
Endoleak	0	0	0	0	0	-
Innominate	0	0	0	0	0	-
Left Common Carotid	0	0	0	0	0	-
Left Iliac	25 (83.3%)	14 (77.8%)	8 (61.5%)	5 (55.6%)	2 (66.7%)	-
Left Renal	19 (76.0%)	9 (64.3%)	6 (46.2%)	5 (62.5%)	2 (100.0%)	-
Left Subclavian Artery	0	0	1 (16.7%)	0	0	-
Lumbar Arteries	41 (91.1%)	24 (85.7%)	24 (80.0%)	14 (82.4%)	4 (100.0%)	-
Right Iliac	24 (82.8%)	16 (80.0%)	14 (73.7%)	8 (72.7%)	2 (66.7%)	-
Right Renal	11 (64.7%)	7 (63.6%)	5 (45.5%)	4 (50.0%)	0	-
Superior Mesenteric Artery	11 (64.7%)	1 (16.7%)	3 (37.5%)	1 (25.0%)	0	-
Undetermined	2 (28.6%)	3 (42.9%)	1 (14.3%)	0	3 (100.0%)	-
Rupture of Dissection Septum	0	0	0	0	0	0
Aortic Rupture	0	0	0	0	0	0
Fistula Formation	0	0	0	0	0	0

Table 57: Pro-D Device or Lesion-Related Secondary Endpoint Events by Follow-up Visit						
	1 Month	6 Months	1 Year	2 Years	3 Years	Total
Aortobronchial						
Tracheal	0	0	0	0	0	0
Aortoenteric	0	0	0	0	0	0
Stent-Graft Stenosis (>50%)	0	0	0	0	0	0
Device Kink (Compression)	0	0	0	0	0	0
Device Twist	0	0	0	0	0	0
Suture Break Visualized	0	0	0	0	0	0
Misalignment / Bird beak	0	0	0	0	0	0
Extrusion / Erosion	0	0	0	0	0	0
Subjects with No Device or Lesion-Related Events ^a Ongoing in Window	46 (90.2%)	30 (88.2%)	29 (90.6%)	16 (84.2%)	7 (100.0%)	-

Core-Laboratory reported data. All n (%)
^a Any Core-Laboratory observed false lumen perfusion is reported. However, only false lumen perfusion from the primary intimal tear is considered a secondary endpoint event.
 LSA, left subclavian artery.

8.4.8.12. Secondary Interventions

For this pivotal study, secondary interventions, including conversions to open surgery could be site reported and/or CEC adjudicated. Regarding CEC adjudication, if a site reported event meets the adjudication trigger for secondary intervention, these events are sent to the CEC for adjudication. The CEC then decides if this event was indeed a secondary intervention or if it meets some other trigger. If an event led to a surgery or procedure related to the device or treated pathology, these events are then adjudicated by the CEC as secondary interventions.

A summary of the reasons for secondary interventions (CEC adjudicated secondary interventions), including conversions to open surgery is provided in **Table 58**. Please note that the following windows are used for the presentation of the secondary interventions through follow-up: 30 days (Day 0 – 90), 6-months (Day 91-270), 1-year (Day 271-540), 2-years (Day 541 – 900), and 3-years (Day 901-1260).

As of the data freeze for this report, 56 subjects were eligible for 30-day follow-up, 52 subjects for 6-months, 48 subjects for 1-year, 36 subjects for 2-years, 18 subjects for 3-years, and 2 subjects for the 4-year follow-up. Fifteen (15) secondary interventions (CEC adjudicated) were performed in 13 subjects through available follow-up. Two of these interventions were open surgical conversions: one at one-year (POD 528); a second at two-years (POD 585). No secondary interventions were reported for the 2 subjects at 4-years.

The reasons for intervention are based on site information and include the following: Type Ia endoleak (3), persistent Type I endoleak (distal aspect of stent) with retrograde filling of false lumen (1), Type II endoleak (2), aortic expansion (1), site reported Type III endoleak (1), site reported thoracoabdominal aneurysm rupture (1), spinal cord ischemia (1), lower extremity malperfusion (1), Type A dissection (2), stenosis of stent (1), and thrombosis of renal artery (1). Please note that one subject had multiple reasons for the same intervention: one intervention completed to address site reported Type III endoleak and persistent site reported Type I endoleak at the distal most aspect of the stent with retrograde filling of the false lumen.

As noted in **Section 8.4.7.6**, the Core Laboratory reviewed the imaging of subjects with a site-reported endoleak to confirm whether the endoleak was instead false lumen perfusion as the CRFs did not have a field for reporting false lumen perfusion. This review is briefly summarized below:

- Two of the subjects who had a secondary intervention to address a site reported Type Ia endoleak had a Core Laboratory reported Type R false lumen perfusion.
- One subject who had a secondary intervention to address a site reported Type II endoleak did not have false lumen

perfusion noted by the Core Laboratory after the Type II endoleak intervention.

- The second subject who had a secondary intervention to address a site reported Type II endoleak had a Core Laboratory Type II and R false lumen perfusion.
- The one subject who had multiple reasons for intervention (site reported Type I and III endoleak with retrograde filling of false lumen) had Type II false lumen perfusion reported by the Core Laboratory.

Two subjects each had two interventions, specifically the following: 1) one had 2 secondary interventions at 30-days for spinal cord ischemia and malperfusion, and 2) one had 2 secondary interventions at 6-months for stenosis of stent and thrombosis of renal artery, as per the site.

Table 58: Pro-D Reasons for CEC Adjudicated Secondary Intervention

	30 Days (Day 0-90)	6 Months (Day 91-270)	1 Year (Day 271-540)	2 Years (Day 541-900)	3 Years (Day 901-1260)	Total
Subjects at Risk (N)	56	52	48	36	18	-
Interventions (n)	7	3	4	1	0	15
Subjects with Any Secondary Intervention	10.7% (6/56)	3.8% (2/52)	8.3% (4/48)	2.8% (1/36)	0	13
Type Ia Endoleak	1.8% (1/56)	0	4.2% (2/48)	0	0	-
Extension	1	-	2	-	-	-
Type II Endoleak	1.8% (1/56)	1.9% (1/52)	0	0	0	-
Embolization	1	1	-	-	-	-
Type III Endoleak	0	0	2.1% (1/48)	0	0	-
Extension	-	-	1	-	-	-
Other	0	1.9% (1/52)	4.2% (2/48)	0	0	-
Thrombectomy & EVAR cuff/ballooning	-	1	-	-	-	-
Extension	-	-	1	-	-	-
Embolization & Physician-Modified TEVAR extension	-	-	1	-	-	-
Uncategorized*	7.1% (4/56)	0	0	2.8% (1/36)	0	-
Clot removal & LSA-LCCA bypass	1	-	-	-	-	-
Total Arch Repair (Open)	1	-	-	-	-	-
Right Common & Superficial Femoral Artery suture angioplasty	1	-	-	-	-	-
Proximal extension, debranching and ascending repair	1	-	-	-	-	-
Extent II TAAA Open Surgical Repair	-	-	-	1	-	-

CEC data. Totals were included for the number of interventions and also the subjects with any intervention. The total was not included for the reasons for a secondary intervention as a subject may have more than one reason for a given intervention. Additionally, the specific rows with interventions may not add up to the total number of interventions completed as a subject may have more than one reason for a given intervention.

Please note that the following windows are used for the presentation of the secondary interventions through follow-up: 30 days (Day 0–90), 6-months (Day 91-270), 1-year (Day 271-540), 2-years (Day 541 – 900), and 3-years (Day 901-1260).

Table 58: Pro-D Reasons for CEC Adjudicated Secondary Intervention

	30 Days (Day 0-90)	6 Months (Day 91-270)	1 Year (Day 271-540)	2 Years (Day 541-900)	3 Years (Day 901-1260)	Total
Data presented as % (n/N) in a specified window, where n is the number of subjects with the characteristic and N is the number of subjects at risk.						
*Uncategorized:						
<ul style="list-style-type: none"> One subject: 1 intervention due to right lower extremity malperfusion treated successfully by clot removal and 1 intervention due to spinal cord ischemia treated successfully with LSA-LCCA bypass, 30-days, One subject: Site reported Type A aortic dissection treated successfully with total arch repair, 30-days, One subject: Site reported postoperative intermittent loss of right pedal pulses treated successfully with right common and superficial femoral artery suture angioplasty of the dissection flap, 30-days, One subject: Site reported Type A aortic dissection treated successfully with proximal extension, debranching and ascending repair, 30-days, and One subject: Site reported ruptured thoracoabdominal aortic aneurysm successfully treated by Extent II TAAA open surgical repair, 2-years. The Core Laboratory also reported the following in this subject: the proximal end of the device migrated distally on the 2-year imaging, aortic lengthening in the treated segment, an increase in aortic diameter, and also confirmed the new dissection proximal to the LSA. 						
<i>Other:</i>						
<ul style="list-style-type: none"> One subject: 1 intervention due to site reported acute thrombosis of left renal artery successfully treated with thrombectomy and mid-abdominal aortic stenosis of dissection stent treated successfully with EVAR cuff and ballooning (6 months), One subject: Persistent Type Ib endoleak with retrograde filling of the false lumen treated successfully with distal extension (1 year), and One subject: Aortic expansion treated successfully with embolization with physician-modified TEVAR extension (1 year). 						
<i>Type Ia Endoleak:</i>						
<ul style="list-style-type: none"> One subject: Type Ia endoleaks treated successfully with: proximal extension (30 days), One subject: Subject was also noted to have Core Laboratory reported migration and aortic lengthening. After presenting with radiating chest pain and hypertension, subject was hospitalized to address the observations. The Type Ia endoleak was treated unsuccessfully with a proximal extension, and the subject ultimately underwent ascending and total arch replacement with a frozen elephant trunk with reimplantation of the innominate artery and LCCA using a surgical graft (1 year), and One subject: Proximal extension with LSA-LCCA bypass (1 year). 						
<i>Type II Endoleak:</i>						
<ul style="list-style-type: none"> One subject: Type II endoleaks treated successfully with LSA embolization (30 days), One subject: Type II endoleaks treated successfully with LSA embolization (6 months). 						
<i>Type III Endoleak:</i> One subject with site reported Type III endoleak repaired successfully with distal extension (1 year). This is the same subject noted above with persistent site reported Type Ib endoleak with retrograde filling of the false lumen reasons for the intervention at 1-year.						

8.5. SUB-GROUP ANALYSIS

In the RelayPro Dissection study, 41 subjects (73.2%, 41/56) were male and 15 (26.8%, 15/56) were female. Mean age at treatment was similar between groups (female, 60.5 ± 12.28 years; males: 59.1 ± 11.23 years). Both groups were mostly black (female, 60%; male, 51.2%).

Regarding comorbidities, the most common reported in the female group include the following: hypertension and/or treatment of hypertension (73.3%, 11/15), coronary artery disease (33.3%, 5/15), hypercholesterolemia (26.7%, 4/15) and diabetes mellitus (26.7%, 4/15). Most (86.7%, 13/15) had a history of smoking and half (46.2%, 6/13) are current smokers. Five (33.3%) were also reported as being currently on antiplatelet/anticoagulant medications.

Comorbidities in the male group were comparable but with greater prevalence of hypertension (95.1%, 39/41), hypercholesterolemia (41.5%, 17/41), and renal insufficiency (17.1%, 7/41) and less CAD (17.1%, 7/41) and diabetes mellitus (14.6%, 6/41). Most also had a history of smoking (80.5%, 33/41) with half current smokers (48.5%, 16/33). Sixteen (39.0%, 16/41) were currently on antiplatelet/anticoagulant medications. The female subgroup had a lower history of vascular intervention than the male subgroup (-8.0%, 95%CI -24.6%, 8.7%).

Regarding all-cause mortality, there was no significant difference between males (2.4%, 1/41) and females (0%, 0/15) for the primary endpoint analysis by sex.

Treatment success at 30-days was also similar: 86.7% (13/15) in female subjects and 85.4% (35/41) in male. All MAEs were in the male subgroup.

8.6. ADDITIONAL FOLLOW-UP DATA

Between the 03 Jun 2022 data freeze of this report and 01 Nov 2022, there have been fourteen follow-up visits collected: one six-month, four one-year, one two-year, four three-year, two four-year follow-up and two five-year follow-up. There was one subject reported by the Core Laboratory to have on-going thoracic aortic and abdominal aortic enlargement during this timeframe. The enlargement is likely due to a site reported Type I endoleak (Core Laboratory reported Type R false lumen perfusion) at the 1-year visit. This was reported for an unscheduled visit and is, ongoing since the first evaluable visit. . During this timeframe, there have been no reported secondary interventions, open surgical conversions or aortic ruptures.

9. PATIENT SELECTION AND TREATMENT

9.1. PATIENT SELECTION

Physicians should evaluate each patient to determine if the **RelayPro THORACIC STENT-GRAFT SYSTEM** would be appropriate to treat their lesion according to the criteria as specified in the Indications For Use, including:

- Iliac or femoral access vessel morphology that is compatible with vascular access techniques, devices, and/or accessories;
- Non-aneurysmal aortic diameter in the range of:
 - 20 – 42 mm for fusiform aneurysms and saccular aneurysms/penetrating atherosclerotic ulcers and dissections
 - 19 – 42 mm for traumatic aortic injuries;
- Proximal landing zone (non-aneurysmal proximal aortic neck lengths for fusiform aneurysms and saccular aneurysms/penetrating atherosclerotic ulcers or non-dissected length of aorta proximal to the primary entry tear for dissections and length of aorta proximal to the tear for traumatic aortic injuries) of:
 - 15 mm for the 22 – 28 mm device diameters (**Bare Stent Configuration**)
 - 20 mm for the 30 – 38 mm device diameters (**Bare Stent Configuration**)
 - 25 mm for the 40 – 46 mm device diameters (**Bare Stent Configuration**)

 - 25 mm for the 22 – 38 mm device diameters (**Non-Bare Stent Configuration**)
 - 30 mm for the 40 – 46 mm device diameters (**Non-Bare Stent Configuration**)
- Non-aneurysmal distal aortic neck lengths for fusiform aneurysms and saccular aneurysms/penetrating atherosclerotic ulcers of:
 - 25 mm for the 24 – 38 mm device diameters
 - 30 mm for the 40 – 46 mm device diameters
- Non-aneurysmal distal landing zone of 20 mm for traumatic aortic injuries (22 mm – 46 mm device diameters) and for dissections (24 mm – 46 mm device diameters)

Inappropriate patient selection may result in poor device performance or device performance not otherwise in accordance with the specifications. Additional anatomic considerations for patient selection include the following:

- Key anatomic criteria that may affect successful exclusion of the aneurysm includes a proximal landing zone with an inner radius of curvature less than 15mm (Figure 9) and insufficient proximal and distal landing zones (**Section 9.2**). The treatment site should be within the working length of the delivery system (90cm).

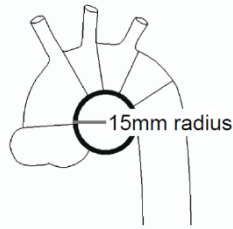

Figure 9. Inner Radius of Curvature

- Wire fractures are more likely to occur in conditions with an excessively oversized stent-graft, flexion, kinking, or bending during cardiac or respiratory cycles. Fractures of the Spiral Support Strut are more likely to occur if the strut is deployed along the inner radius of curvature. Wire fractures may have clinical consequences including endoleak, migration, or tissue damage.
- Practitioner must ensure that the access vessel diameter is compatible with the selected delivery system's outer sheath French size and that the aortic inner diameter that can accommodate the expanded inner sheath outer diameter of approximately 10 mm.

Additional considerations for patient selection when considering TEVAR may include the following:

- Age and life expectancy
- Comorbidities such as cardiac, pulmonary, renal insufficiency, morbid obesity
- Patient's suitability for endovascular repair
- Patient's suitability for open surgical repair
- Ability to tolerate general, regional, or local anesthesia. Patients presenting with ruptured aneurysm and/or traumatic aortic injuries (transection) may be at higher risk for complications associated with general anesthesia.
- The device should not be used in patients unwilling or unable to comply with the recommended post procedure follow-up imaging.

9.2. RELAYPRO STENT-GRAFT SIZING

For patient specific device selection, the following criteria shall be followed:

- Refer to the recommended device sizing for the proximal and distal aortic landing zone lengths recommended for stent-graft diameters in **Table 59** for the **Bare Stent Configuration** and **Table 60** for the **Non-Bare Stent Configuration**. Seal zones outside these recommendations could result in migration, endoleak, or other complications. The recommended sizing is the same for all lesions mentioned in this IFU.
- Select the appropriate device size based on artery outer diameter measurement taken from CT images. Diameters of the proximal and distal landing zones are needed. **Table 61** and **Table 62** address the selection of the appropriate stent-graft diameter based on vessel size for the Straight and Tapered stent-grafts, respectively for the **Bare Stent Configuration**. **Table 63** and **Table 64** address the selection of the appropriate stent-graft diameter based on vessel size for the Straight and Tapered stent-grafts, respectively for the **Non-Bare Stent Configuration**. For Tapered devices, the delivery system sheath size is driven by the largest diameter of the stent-graft.

Note:	<p>The Straight and Tapered Configurations consist of:</p> <ul style="list-style-type: none"> • Straight: Consistent diameter through the implant length • Standard Taper: Diameter of device decreases proximal to distal (typical 4mm transition; availability from 2mm and up to 18mm transition) • Reverse Taper: Diameter of device increases proximal to distal (availability from 2mm and up to 18mm transition)
--------------	--

- Sizing should be based on relatively recent imaging (within 6 months) and reconfirmation at the index procedure.
- For blunt traumatic aortic injury patients, careful consideration of sizing is important in the trauma setting as aortic diameter is prone to contraction during hypovolemic shock (and may further change with aging).

- All aortic diameter measurements should be adventitia to adventitia. In the treatment of traumatic injuries, any significant periaortic hematoma in the region of the LSA should not be counted in the diameter measurement (to avoid risk of oversizing). The final treatment decision is at the discretion of the physician and patient.
- Deploying the device in a portion of the aorta with a different diameter than planned when selecting the graft size may potentially result in inadequate sizing and therefore migration, endoleak, aneurysm growth, or increased risk of thrombosis.
- Length of the stent-grafts should take into account tortuosity of vessels and minimum overlap requirements.
- As part of prudent preoperative case planning, an inventory of device lengths and diameters necessary to complete the procedure should be available to the physician.
- Practitioner must ensure that the access vessel diameter is compatible with the selected delivery system’s outer sheath French size.

Table 59. TARGET LANDING ZONE – BARE STENT CONFIGURATION

Stent-Graft Diameter	Proximal Length	Stent-Graft Diameter	Distal Length (Aneurysm)	Distal Length (Dissection and Transection)
22 – 28 mm	15 mm	22 – 38 mm	25 mm	20 mm
30 – 38 mm	20 mm	40 – 46 mm	30 mm	20 mm
40 – 46 mm	25 mm			

Table 60. TARGET LANDING ZONE – NON-BARE STENT CONFIGURATION

Stent-Graft Diameter	Proximal Length	Stent-Graft Diameter	Distal Length (Aneurysm)	Distal Length (Dissection and Transection)
22 – 38 mm	25 mm	22 – 38 mm	25 mm	20 mm
40 – 46 mm	30 mm	40 – 46 mm	30 mm	20 mm

Table 61. STRAIGHT STENT-GRAFTS - BARE STENT CONFIGURATION

Stent- Graft Size (mm)	Thoracic Proximal Vessel Size (mm)	Graft Covered Length* (mm)				Graft Total Length (mm)				Delivery System French Size (O.D.)			
		100 mm	150 mm	200 mm	250 mm	100 mm	150 mm	200 mm	250 mm	100 mm	150 mm	200 mm	250 mm
22	19	90	150	190	250	103	163	203	263	19	19	19	19
24	20-21	90	150	190	250	104	164	204	264	19	19	19	19
26	22-23	95	155	195	250	109	169	209	264	19	19	19	19
28	24-25	95	155	195	250	110	170	210	265	19	19	19	19
30	26-27	95	155	200	250	111	171	216	266	19	19	19	19
32	28-29	95	155	200	250	112	172	217	267	20	20	20	20
34	30-31	100	145	200	250	117	162	217	267	20	20	20	20
36	32-33	100	145	190	250	118	163	208	268	20	20	20	20
38	34	100	145	190	250	119	164	209	269	21	21	21	21
40	35-36	105	145	195	250	125	165	215	270	21	21	21	21
42	37-38	105	150	195	250	125	170	215	270	22	22	22	22
44	39-40	105	155	200	250	126	176	221	271	22	22	22	22

Stent- Graft Size (mm)	Thoracic Proximal Vessel Size (mm)	Graft Covered Length* (mm)				Graft Total Length (mm)				Delivery System French Size (O.D.)			
		100 mm	150 mm	200 mm	250 mm	100 mm	150 mm	200 mm	250 mm	100 mm	150 mm	200 mm	250 mm
46	41-42	105	155	200	250	126	176	221	271	22	22	22	22

*Graft covered lengths are available from 100–250 mm. Please note that interim lengths are available within that range in 10–20 mm increments.

Tapered Stent-Graft Size (mm)	Thoracic Vessel Size (mm)		Graft Covered Length** (mm)			Graft Total Length (mm)			Delivery System French Size (O.D.)		
	Proximal	Distal	150 mm	200 mm	250 mm	150 mm	200 mm	250 mm	150 mm	200 mm	250 mm
28x24	24-25	20-21	155	195	250	170	210	265	19	19	19
30x26	26-27	22-23	155	200	250	171	216	266	19	19	19
32x28	28-29	24-25	155	200	250	172	217	267	20	20	20
34x30	30-31	26-27	145	200	250	162	217	267	20	20	20
36x32	32-33	28-29	145	190	250	163	208	268	20	20	20
38x34	34	30-31	145	190	250	164	209	269	21	21	21
40x36	35-36	32-33	145	195	250	165	215	270	21	21	21
42x38	37-38	34	150	195	250	170	215	270	22	22	22
44x40	39-40	35-36	155	200	250	176	221	271	22	22	22
46x42	41-42	37-38	155	200	250	176	221	271	22	22	22

*The degree of tapering can range from 2-18 mm.

** Graft covered lengths are available from 100–250 mm. Please note that interim lengths are available within that range in 10–20 mm increments.

Stent- Graft Size (mm)	Thoracic Proximal Vessel Size (mm)	Graft Covered Length* (mm)				Delivery System French Size (O.D.)			
		100 mm	150 mm	200 mm	250 mm	100 mm	150 mm	200 mm	250 mm
22	19	99	159	199	259	19	19	19	19
24	20-21	99	159	199	259	19	19	19	19
26	22-23	104	164	204	259	19	19	19	19
28	24-25	104	164	204	259	20	20	20	20
30	26-27	104	164	209	259	20	20	20	20
32	28-29	104	164	209	259	21	21	21	21
34	30-31	109	154	209	259	21	21	21	21
36	32-33	109	154	199	259	22	22	22	22
38	34	109	154	199	259	22	22	22	22
40	35-36	114	154	204	259	22	22	22	22
42	37-38	114	159	204	259	23	23	23	23
44	39-40	114	164	209	259	23	23	23	23
46	41-42	114	164	209	259	23	23	23	23

*Graft covered lengths are available from 100–250 mm. Please note that interim lengths are available within that range in 10–20 mm increments.

Table 64. 4 MM TAPERED STENT-GRAFTS* - NON-BARE STENT CONFIGURATION								
Tapered Stent-Graft Size (mm)	Thoracic Vessel Size (mm)		Graft Covered Length** (mm)			Delivery System French Size (O.D.)		
	Proximal	Distal	150 mm	200 mm	250 mm	150 mm	200 mm	250 mm
28x24	24-25	20-21	164	204	259	20	20	20
30x26	26-27	22-23	164	209	259	20	20	20
32x28	28-29	24-25	164	209	259	21	21	21
34x30	30-31	26-27	154	209	259	21	21	21
36x32	32-33	28-29	154	199	259	22	22	22
38x34	34	30-31	154	199	259	22	22	22
40x36	35-36	32-33	154	204	259	22	22	22
42x38	37-38	34	159	204	259	23	23	23
44x40	39-40	35-36	164	209	259	23	23	23
46x42	41-42	37-38	164	209	259	23	23	23

*The degree of tapering can range from 2-18 mm.

** Graft covered lengths are available from 100–250 mm. Please note that interim lengths are available within that range in 10–20 mm increments.

The minimum recommended amount of overlap between devices is three overlapping covered stents (approximately 50 mm). Less than this amount of overlap may result in endoleak (with or without component separation). For modular junctions, a 2 mm oversizing is recommended. Sizing outside these guidelines could result in endoleak, migration, stent-graft separation, infolding, or device damage.

- Notes:**
- Given the indications for use and the device configurations, if the lesion requires use of an extension, **only** a RelayPro Non-Bare Stent (NBS) configuration may be used.
 - When extending a Thoraflex Hybrid device, please go to eifu.terumo-aortic.com for sizing recommendations for the RelayPro NBS configuration in the Thoraflex Hybrid US IFU. Do NOT use this RelayPro IFU for sizing recommendations when extending a Thoraflex Hybrid device.

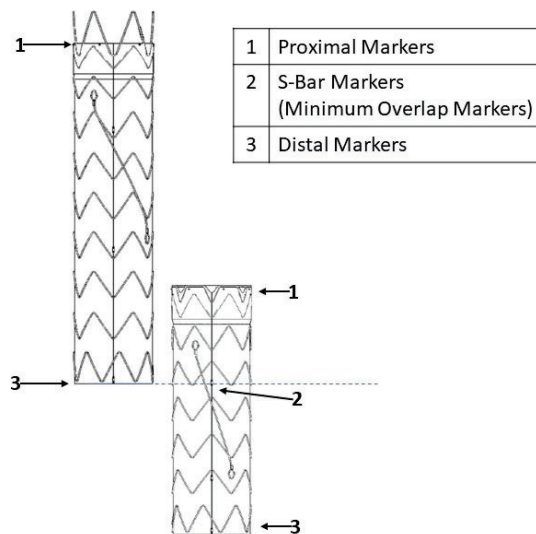

Figure 10. Marker Band Placement in Overlap Configuration

10. PATIENT COUNSELING INFORMATION

The benefits and risks of the endovascular procedure using **RelayPro** should be discussed with patients, including the following:

- Patient age and life expectancy
- Risks and benefits related to open surgical repair
- Risks and benefits related to endovascular repair
- Risks and benefits related to **RelayPro** as compared to other marketed endovascular devices
- Risks related to non-interventional treatment or medical management
- Risks of aneurysm rupture compared to endovascular repair
- Possibility that subsequent endovascular or open surgical repair of the aneurysm may be required.
- The long-term safety and effectiveness of **RelayPro** has not been established.
- Long-term, regular follow-up by a vascular specialist with periodic imaging is needed to assess patient health status and stent-graft performance.
- Patients with specific clinical findings (e.g., endoleaks, enlarging aneurysms) should be monitored closely.
- Symptoms of aneurysm rupture

11. HOW PRODUCT IS SUPPLIED:

11.1. PACKAGE CONTENTS

- Each Stent-Graft is pre-loaded in its individual delivery system and packaged using a double pouch system with peel-open end seals.
- Each package contains a label describing the device details such as catalog number, diameter, length, delivery system size, etc.

11.2. STERILIZATION, STORAGE AND HANDLING

- The package contents of **RelayPro** have been sterilized by gamma irradiation. **RelayPro** is provided sterile for single use only. Do not re-sterilize any components of the system.
- Use prior to the “Use By” date specified on the package.
- Store the packaged **RelayPro** in a cool, dry place to avoid exposure to extreme temperatures and humidity.

The product is supplied with the following model designation identified on the label as shown in **Table 65**.

Table 65. Product Designation						
Internal Code	Identifier	Proximal Diameter (mm)	Covered Length* (mm)	Distal Diameter (mm)	Device Designation	French Size**
28	M4: Bare Stent Configuration N4: Non-Bare Stent Configuration	XX	XXX	XX	U: Standard Catalog Product for US	(XX Fr)

*Family lengths may be used. Final lengths to be listed on product labeling (Tolerance of ±10 mm).
**Identified on label but not part of model designation.

12. CLINICAL USE INFORMATION

12.1. PHYSICIAN TRAINING REQUIREMENTS

All physicians should be trained in the use of **RelayPro** before using it.

Caution: **RelayPro** should only be used by physicians and teams trained in vascular interventional techniques and in the use of this device.

A team trained in vascular surgery should be available while the implant procedure is in progress in case conversion to open surgery is required. In addition, the following are the knowledge and skill requirements for physicians using **RelayPro**:

- Knowledge of radiographic, fluoroscopic and angiographic image interpretation
- Knowledge of natural history and associated comorbidities of TAA, fusiform and saccular aneurysms, PAU, dissections or traumatic aortic injuries
- A multi-disciplinary team that has combined procedural experience with:
 - Appropriate use of radiographic contrast material
 - Appropriate use of anticoagulants
 - General arterial cut down, arteriotomy, and repair or percutaneous access and closure techniques
 - Nonselective and selective guidewire and catheter techniques
 - Embolization
 - Angioplasty
 - Endovascular stent placement / Snare techniques
 - Techniques to minimize radiation exposure
 - Device selection and sizing
 - Expertise in necessary patient follow-up modalities.

12.2. CASE PRE-PLANNING AND INDIVIDUALIZATION OF TREATMENT

Practitioners using the **RelayPro THORACIC STENT-GRAFT SYSTEM** should have a thorough understanding of endovascular procedures and techniques. In particular, the **RelayPro THORACIC STENT-GRAFT SYSTEM** should only be used by physicians and teams with experience and training in vascular interventional techniques, including, but not limited to, training on the use of the **RelayPro THORACIC STENT-GRAFT SYSTEM**, as described in the preceding section. Selecting the proper graft with the appropriate length and diameter is paramount to the successful exclusion of the aneurysm/lesion or treatment of the traumatic aortic injury and to minimize endoleaks and migration. Measure all parameters needed for proper sizing of the stent-graft carefully. Terumo Aortic recommends evaluation of all imaging studies available, i.e., angiograms, CT scans, MRI scans, MRA scans and plain radiographs. Each imaging modality offers additional information to the sizing process. Clinical experience indicates that non-contrast and contrast computed tomographic angiography (CTA) with 3-D reconstruction is the strongly recommended imaging modality to accurately assess patient anatomy prior to treatment with the RelayPro. If CTA with 3-D reconstruction is not available, the patient should be referred to a facility with these capabilities.

The physical characteristics of the vessel should be evaluated in addition to its size. Factors such as stenosis, atherosclerotic disease, ectasia and tortuosity may affect Stent-Graft selection and placement strategy. The final Stent-Graft selection will be the responsibility of the physician.

For blunt traumatic aortic injury patients, careful consideration of sizing is important in the trauma setting as aortic diameter is prone to contraction during hypovolemic shock (and may further change with aging).

12.3. DEVICE INSPECTION PRIOR TO USE

- Inspect the system packaging pouches for tears, punctures, breaks, or opening that would compromise the system sterility.

Warning: Do not use the system if the pouch has any punctures, tears or opening as this may have affected system sterility.

12.4. DEVICES, SUPPLIES AND EQUIPMENT REQUIRED

- **RelayPro** implants of appropriate sizes, including redundant components

- Fluoroscopic DSA equipment (ceiling/pedestal mounted or portable image intensifier on a freely angled C-arm). It is desirable if the image intensifier has a complete range of motion.
- Minimum 260cm Guidewire/0.035" [0.89mm] (Super Stiff)
- Arterial puncture needles 18G or 19G
- Assorted vascular introducers and angiographic catheters
- Contrast media
- Syringes
- Heparinized saline solution
- Sterile gauze pads
- Surgical suite in the event that emergency open conversion surgery is necessary

12.5. SUPPORTIVE/SUPPLEMENTARY EQUIPMENT

- Inflation device with pressure gauge
- Guidewire torque devices
- Vascular Balloon-Catheters of the appropriate size
- Gooseneck snare (10-15mm diameter)
- Assortment of vascular stents

12.6. MAGNETIC RESONANCE (MR) IMAGING SAFETY INFORMATION

MRI SAFETY INFORMATION



MR Conditional

A person with the RelayPro Thoracic Stent-Graft may be safely scanned under the following conditions. Failure to follow these conditions may result in injury.

Device Name	RelayPro Thoracic Stent-Graft
Static Magnetic Field Strength (B₀)	1.5T or 3.0T
Maximum Spatial Field Gradient	30 T/m (3,000 gauss/cm)
RF Excitation	Circularly Polarized (CP)
RF Transmit Coil Type	Whole-body transmit coil
Operating Mode	Normal Operating Mode
Maximum Whole-Body SAR	2 W/kg (Normal Operating Mode)
Maximum Head SAR	3.2 W/kg (Normal Operating Mode)
Scan Duration	2 W/kg whole-body average SAR for 60 minutes of continuous RF (a sequence or back to back series/scan without breaks)
MR Image Artifact	The presence of the RelayPro Thoracic Stent-Graft may produce an image artifact at 5mm. Some manipulation of scan parameters may be needed to compensate for the artifact.

13. DIRECTIONS FOR USE

13.1. PATIENT AND DEVICE PREPARATION: (STEPS 1 THROUGH 10)

Warnings:

- Exercise care during handling and delivery to help prevent vessel rupture.
- Excessive use of contrast agents, emboli or a misplaced stent-graft may result in renal complications.
- When advancing the guidewires, catheters, and the **RelayPro** delivery system into the aorta, do not disturb the thrombus mass within the aneurysm. Doing so may dislodge emboli, which can cause embolization. If embolization should occur, use conventional treatment methods.

Cautions:

- Failure to use a 0.035" (0.89 mm) stiff guidewire may result in vessel trauma and compromise deliverability and/or performance of the delivery system.
- Stop advancing the guidewire or delivery system if resistance is encountered. Assess the source of the resistance before proceeding to avoid vessel or catheter damage.
- Do not use power/pressure injections through the delivery systems.

Notes:

- Anticoagulation and antiplatelet therapies are used at the discretion of the physician. Similarly, arterial blood pressure adjustment and spinal cord protection measures are also at the discretion of the physician.
- Position the patient on the surgical table where standard aseptic preparation of the surgical site is conducted.
- Drape the patient with sterile surgical drapes leaving exposed the bilateral groin access sites.

1. Verify devices are correct for the patient.
2. Open the end of the product box and remove the system in its packaging pouches from the box.
3. Take the delivery systems out from the sterile packaging and bring them to the surgical table. Examine the delivery systems for structural integrity. DO NOT USE the system if defects are noted. It is recommended that the delivery system is analyzed under fluoroscopy to ensure that the physician understands the orientation of the prosthesis and configuration of the marker bands.

Note: Do not bend or kink the delivery system as it may cause damage to not only the delivery system but also the **RelayPro** stent-graft.

4. Perform a vascular access at the common femoral artery that will be used to track the device. Place a .035" [0.89mm], 260 or 300cm long, super stiff guidewire up to the aortic arch. The second femoral artery can be accessed for angiographic catheter placement.

Notes:

- Angiography is performed at the discretion of the physician.
- If using a closure device, ensure compatibility with the profile of the Terumo Aortic device.

5. Ensure that the controller is in the "1" position, if it is not change it to the "1" position to prevent premature deployment of the stent-graft.
6. Verify that the delivery system tip is properly seated in the outer sheath and that the tip side hole is not covered. If not, correct by rotating the deployment grip until the delivery system tip is properly seated.
7. Flush the guidewire flush port with minimum of 5 cc of heparinized saline. Flush the delivery system with minimum of 20 cc of heparinized saline through the flush port to purge air from the inside of the sheath and the coaxially situated sheaths. Ensure that saline can be seen exiting from the tip area. Visually inspect the system for remaining air and repeat if necessary. It may be necessary to elevate the distal end of the system to different positions to bring air to the highest point for purging.

Warning: Placement of stent-graft in the thoracic aorta often requires proximity to the great vessels perfusing the brain, increasing the possibility of thrombus or embolization proximally. Care should be taken to ensure air has been purged from the system.

- Verify that the apex holder knob [ITEM 13] is securely engaged in the V-shaped notch of the guidewire luer [ITEM 14] (see **Figure 2**).

Cautions:

- DO NOT USE the system if the apex holder knob is not engaged in the V-shaped notch provided by the guidewire luer.
- Do not attempt to re-engage the apex holder knob with the guidewire luer.

- Flush the delivery system with heparinized saline through the gray guidewire luer.

Note: Attention should be paid to not rotate the apex holder knob during this step.



Figure 11. Guidewire lumen flush port

- Activate the hydrophilic coating by wetting the tip and outer sheath with sterile saline.

13.2. INTRODUCTION/ADVANCEMENT OF THE OUTER SHEATH (STEPS 11 THROUGH 12)

- Advance the outer sheath into the artery over the guidewire.

Note: The guidewire should always remain in the delivery system while inside the patient.

- Under fluoroscopic control, advance the outer sheath until the delivery system tip is just below the intended distal landing zone. If the descending aorta presents tight tortuosity, the tip should be advanced past the tight curvature(s) to facilitate navigation of the inner sheath.

Caution: Do not advance the outer sheath into the thoracic arch.

Note: If the outer sheath cannot be advanced beyond the region of tight curvatures, the delivery system should be removed from the patient and an alternate procedure be considered.

13.3. ADVANCEMENT OF THE INNER SHEATH (STEPS 13 THROUGH 18)

Cautions:

- Once the inner sheath is advanced, the user will be committed to implant the graft.
- The controller must be in the "1" position.

Note: The handle body can be rotated to position the top of the device facing the user. The handle body should not be rotated more than half a turn.

- While holding the gray grip so that the main body remains stationary, rotate the deployment grip clockwise to advance the inner sheath. Ensure that while the deployment grip is being turned, it is being pushed toward the gray stationary grip.

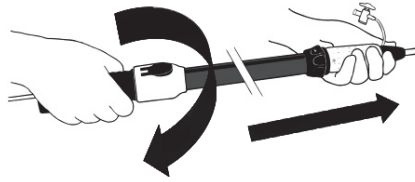

Figure 12. Actuating the device using mechanical advantage

If preferred, the mechanical advantage can be bypassed by pressing on the “disengagement button” while advancing the deployment grip.

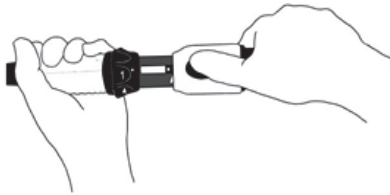

Figure 13. Disengagement button

14. Advance the inner sheath until the stent-graft proximal markers reach the proximal landing zone. Upon reaching the intended proximal landing zone, visually confirm that the stent-graft’s distal marker bands can be seen approximately 2 cm outside of the outer sheath. If the stent-graft’s distal marker bands do not appear to have exited the outer sheath, while in Position 1, press the disengagement button and hold the deployment grip stationary while pulling back on the gray stationary grip until the stent-graft’s distal marker bands have exited the outer sheath by approximately 2 cm. Verify that the white arrow marker has been covered by the deployment grip assembly.

Caution: Do NOT advance the delivery system tip or guidewire across the aortic valve.

15. As the inner sheath is advanced out of the outer sheath, note the alignment of the Spiral Support Strut by locating the Spiral Support Strut markers under fluoroscopy.
16. If the device is to be implanted in a curved section of the aorta, verify that the D-shaped marker on the inner sheath and the Spiral Support Strut marker(s) face the greatest curvature.

If radial adjustment is needed, retract the deployment grip (disengage mechanical advantage by pressing on disengagement button) to bring the stent-graft to a straight portion of the vessel. When retracting the deployment grip, ensure that the distal end of the stent-graft is not pulled into the outer sheath (the white arrow marker can be used as a reference). If the Spiral Support Strut is not facing the outer curvature of the aorta, it may be necessary to retract the whole device a few centimeters to bring the stent-graft to a straight position. After the stent-graft is in the straight position, while holding the front nose cap, rotate the whole handle body to manually align the Spiral Support Strut markers toward the greatest curvature of the aorta. The D-shaped marker can be used to aid in this placement. If the round portion of the D-shaped marker is facing the greater curvature, the handle body should be turned clockwise. If the round portion is facing the lesser curvature, the turn should be counterclockwise. One to three handle revolutions may be required before the stent-graft begins rotating. Once alignment is confirmed, re-advance the stent-graft into the desired position.



Figure 14. Device rotation while holding nose cap

17. Perform an angiogram of the area of interest to confirm proper position of the device in preparation for deployment.

Cautions:	<ul style="list-style-type: none"> • Once the proximal position of the stent-graft has been identified, do not move the patient or imaging equipment, as it may compromise accuracy of prosthesis placement. • When aligning the position of prosthesis, be sure the fluoroscope is angled perpendicularly to the center line of the proximal landing zone to avoid parallax or other source of visualization error that could impact proper positioning. • Ensure the inner sheath and stent-graft have fully exited the outer sheath before deployment.
------------------	--

18. Finalize the longitudinal placement of the stent-graft in relation to the proximal landing zone by adjusting the deployment grip as necessary. Confirm the position of the proximal and distal marker bands as well as the Spiral Support Strut markers.

13.4. STENT-GRAFT DEPLOYMENT (STEPS 19 THROUGH 23)

19. With the stent-graft in the desired deployment position, turn the controller to the “2” position.



Figure 15. Turn controller to Position 2

20. While holding the gray grip fixed, rotate the deployment grip counterclockwise to pull down the inner sheath until the first covered stent begins to expand.

Notes:	<ul style="list-style-type: none"> • The inner sheath has the D-Shaped radiopaque marker located between the stent-graft proximal marker and the most proximal Spiral Support Strut marker. This marker can be used to visualize the inner sheath's movement under fluoroscopy. • NBS Configuration: The D-shaped marker should not be retracted past the proximal Spiral Support Strut marker to allow linear re-adjustments. If the D-marker is moved beyond the proximal Spiral Support Strut marker, the proximal end of the graft is expanded too much to allow repositioning.
---------------	--

21. Make any final linear position adjustments (proximally or distally), if necessary.

Warnings:	<ul style="list-style-type: none"> • Do not attempt to reposition the RelayPro stent-graft once it has opposed the vessel wall. Inadvertent partial deployment or migration of the RelayPro stent-graft may require surgical removal. • Inaccurate placement and/or incomplete sealing of the RelayPro stent-graft within the vessel may result in increased risk of endoleak, migration, or inadvertent occlusion of the left subclavian, left common carotid, and/or celiac arteries. Surgical intervention may be required.
------------------	---

22. Deploy the stent-graft by holding the gray stationary grip fixed and, while pressing the disengagement button down, retract the deployment grip with one continuous motion without stopping until the stent-graft is fully deployed and the inner sheath completely retracted.

Cautions:

- Failure to promptly deploy the stent-graft will cause blood pressure to increase and may result in distal migration of the device during deployment.
- Attachment of the proximal end of the stent-graft is maintained by the apex holder. As such, the handle body should not be moved until the apex holder is released.

23. Under fluoroscopic control, release the stent-graft from the apex holder by rotating the black apex holder knob and sliding it toward the gray guidewire luer. The stent-graft is now fully released.

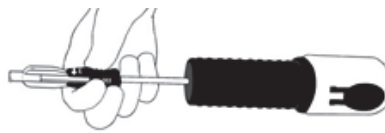

Figure 16. Clasp release

13.5. SYSTEM REMOVAL (STEPS 24 THROUGH 30)

24. Place the controller in the “4” position.

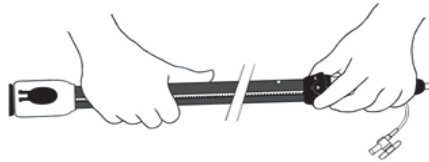

Figure 17. Turn controller to Position 4

25. Under fluoroscopic control, retract the stainless steel rod allowing the tip to rejoin the outer sheath. Monitor the travel of the delivery system tip through the deployed stent-graft so that stent-graft’s position is not affected. If the tip does not rejoin easily, the delivery system may be repositioned into a straighter portion of the anatomy to facilitate reseating. If necessary, apply slightly greater force until the tip rejoins with the outer sheath.



Figure 18. Retraction of stainless steel rod

Notes:

- Anatomy and graft position may change during the withdrawal of the delivery system and/or guidewire; therefore, constant monitoring of the graft position is important. Use angiography as necessary.
- Ensure there is no gap between the tip and outer sheath prior to withdrawing the system from the patient.

26. With the tip resealed, place the controller in the “2” position and withdraw the entire system from the patient.



Figure 19. Turn controller to Position 2

- Warnings:**
- Balloon modeling is not required but if it is deemed necessary, it is recommended that balloon modeling be done with a compliant balloon. Balloon inflation should not exceed 1 atm.
 - Over inflation of semi or non-compliant balloon can cause graft tears and/or vessel dissection or rupture.
 - When expanding the prostheses, there is an increased risk of vessel injury and/or rupture, and possible patient death, if the compliant balloon’s proximal and distal radiopaque markers are not completely within the covered (graft fabric) portion of the prosthesis. **For the Bare Stent Configuration**, ballooning outside the covered portion could cause aortic rupture, atherosclerotic plaque embolization, or other complications.
 - **Bare Stent Configuration:** Do not expand the bare proximal stent as expansion of the bare proximal stent may cause vessel injury or rupture and the balloon could snag onto the bare proximal stent.

- Cautions:**
- Be careful not to displace the prostheses upon introducing and retracting the compliant balloon catheter.
 - Always recheck position of stent-graft following ballooning.
 - Care should be taken when inflating the compliant balloon, especially with calcified, tortuous, stenotic, or otherwise diseased vessels.
 - Inflate the compliant balloon slowly. It is recommended that a backup compliant balloon be available.

27. Perform a final angiogram to assess for endoleaks, migration and aneurysm/lesion exclusion.
28. If a Type I endoleak is detected, consider balloon modeling to correct the endoleak. A proximal extension device may also be considered to treat Type I endoleaks. Endoleaks detected at the conclusion of the procedure and not corrected should be carefully monitored after implantation.
29. Straighten the angiographic pigtail catheter and remove all catheters and sheaths from the access sites and perform standard surgical closure of the arteriotomy sites.
30. Assess blood flow to the distal extremities.

14. BAIL OUT TECHNIQUE

In the unlikely event the mechanical advantage does not function as intended, the following technique may be used:

- The mechanical advantage can be bypassed by pressing the “disengagement button” and the delivery system can be operated by manually pushing or pulling the deployment grip as needed.

In the unlikely event the stent-graft cannot be deployed because the stainless steel rod fails to remain stationary in relation to the handle body during the deployment phase (controller to the “2” position), the following technique may be used:

- The stainless steel rod and the handle body can be manually held together to complete the deployment of the stent-graft.

In the unlikely event of an inability to release the proximal bare stent the following bail out technique may be used:

- There is a slot open near the clasp release grip identified by the hash marks below in Figure 20. Inside this slot there is a green tube that can be accessed by a pair of forceps. This green tube is directly attached to the clasp release mechanism and can be pulled directly in the event that the full retraction of the clasp release mechanism does not fully release the stent.

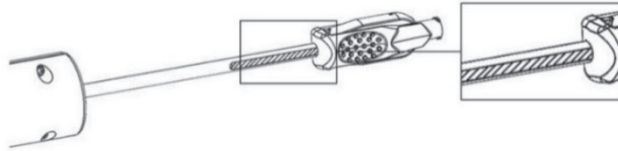

Figure 20. Identification of Slot in Delivery System

15. FOLLOW-UP PROCEDURE

15.1. GENERAL

All patients should be advised that endovascular treatment requires yearly lifelong imaging and regular follow-up to assess their health and the performance of their endovascular graft. Patients with specific clinical findings (such as, Type I or III endoleaks, enlarging aneurysms, enlarging false lumens, or changes in the structure or position of the endovascular graft) should receive additional follow-up. Patients should be counseled on the importance of adhering to the follow-up schedule, both during the first year and at yearly intervals thereafter. Patients should be informed that regular and consistent follow-up is a critical part of ensuring the ongoing safety and effectiveness of endovascular treatment of thoracic aortic lesions. This includes aneurysms, saccular aneurysms and penetrating atherosclerotic ulcers, dissections and traumatic aortic injuries. Physicians should evaluate patients on an individual basis and prescribe follow-up relative to the needs and circumstances of each individual patient.

Current recommended imaging of stent-graft patients includes single or multislice CT scans with and without contrast medium. Alternative imaging modalities such as magnetic resonance imaging should be used in patients with impaired renal function or intolerance to contrast media that cannot be adequately premedicated. Imaging should be decided based upon the physician's clinical assessment of the patient pre- and post-implantation of the stent-graft. After endovascular graft placement, patients should be regularly monitored for perigraft flow, aneurysm enlargement or changes in the structure or position of the endovascular graft. At a minimum, baseline post-procedure imaging within 30 days following implant along with annual imaging is recommended, including:

- Thoracic radiographs to examine device integrity (stent fracture, separation between the prostheses, if applicable), and
- Contrast and non-contrast CT to examine aneurysm changes, perigraft flow, patency, tortuosity and progressive disease. If renal complications or other factors preclude the use of contrast media, alternative imaging modalities should be considered (see proceeding sections).

15.2. X-RAY

Thoracic X-rays should be used to assess the presence of stent fracture and component separation. Posterior/anterior (PA) and lateral images are recommended for visualization of the stent-graft. Ensure the entire device is captured on images for device assessment.

15.3. CT WITH CONTRAST

Contrast-enhanced CT should be used to assess stent-graft fixation, deformation, apposition to the vessel wall at proximal and distal fixation sites, stent-graft migration, stent-graft patency, TAA size, and endoleak (including source and type if present). A pre-contrast scan of 3 mm thick slices is suggested to determine if there are calcifications or areas where metal artifacts may be misinterpreted as endoleak. Arterial and venous phase CT scans with ≤ 3 mm slice thickness with coverage from the sino-tubular junction to the origin of the superior mesenteric artery beyond the end of the prosthesis are recommended.

It is recommended that the source data set be archived in case specialized evaluation is needed later (volume measurements, 3-dimensional reconstruction, or computer-aided measurement software). If the aneurysm is not regressing by more than 5 mm within the first year, volume measurements may be obtained as a more sensitive indicator of TAA size using 3-dimensional software.

15.4. NON-CONTRAST CT

For patients with impaired renal function or those who are allergic to contrast medium and cannot be adequately premedicated, a CT without contrast may be considered to assess stent-graft fixation, deformation, apposition to the vessel wall at proximal and distal fixation sites, stent-graft migration and size of the TAA diameter and volume measurements.

15.5. TRANSESOPHAGEAL ECHOCARDIOGRAPHY

For patients with impaired renal function or those who are allergic to contrast medium, a color-transesophageal echo may be considered to assess size of TAA diameter, endoleaks, and stent-graft occlusion and stenosis.

15.6. MRI OR MRA

Patients with impaired renal function may also be considered for magnetic resonance imaging or angiography (MRI, MRA) in facilities that have expertise in this area. Artifact may occur related to the stent, and care should be used to ensure adequate imaging of the outer aneurysm wall to assess TAA size. Volume measurement may be helpful if the aneurysm is not clearly regressing in size. If there are concerns regarding imaging of calcified areas, fixation sites, or the outer wall of the aneurysm sac, adjunctive CT without contrast may be needed.

15.7. SUPPLEMENTAL IMAGING

Note: Additional radiological imaging may be necessary to further evaluate the stent-graft in-situ based on findings revealed by one of the surveillance programs. The following recommendations may be considered.

- If there is evidence of poor or irregular position of the stent-graft, severe angulation, kinking or migration of the stent-graft on thoracic X-rays, a CT should be performed to assess aneurysm size and the presence or absence of an endoleak.
- If a new endoleak or increase in TAA size is observed by CT, adjunctive studies such as 3-D reconstruction or angiographic assessment of the stent-graft and native vasculature may be helpful in further evaluating any changes of the stent-graft or aneurysm.
- CT without contrast, MRI or MRA may be considered in select patients who cannot tolerate contrast media or who have renal function impairment. For centers with appropriate expertise, gadolinium or CO₂ angiography may be considered in patients with renal function impairment requiring angiographic assessment.

16. ADDITIONAL SURVEILLANCE AND TREATMENT

Additional endovascular repair or open surgical aneurysm repair should be considered for patients with an increase in TAA size of more than 5mm or evidence of sub-optimal fixation, proximal endoleak, distal endoleak, junction endoleak, or unknown origin of peri-graft flow, dissection extension or persistent false lumen perfusion. An increase in aortic size, persistent endoleak, or continued false lumen perfusion may lead to aortic rupture.

Consideration for reintervention or conversion to open repair should include the attending physician's assessment of an individual patient's comorbidities, life expectancy, and the patient's personal choices. Patients should be counseled that subsequent reintervention may become necessary following an endovascular graft procedure.

17. DEVICE TRACKING INFORMATION

The **RelayPro THORACIC STENT-GRAFT SYSTEM** is packaged with the following:

- **Implant Information Form.** This form must be completed by the hospital staff and sent to Bolton Medical for the purposes of tracking all patients who receive the RelayPro Thoracic Stent-Graft (as required by U.S. Federal Regulation).
- **Device Identification Card.** This card must be completed by the hospital staff and provided to the patient. Patients should be instructed by their physician to keep this card with them at all times. Patients should refer to the card when visiting

other healthcare practitioners, and especially when visiting MR imaging facilities since the card provides specific information on the safe imaging of the **RelayPro** stent-graft via MR.

18. DISCLAIMER OF WARRANTY











ALTHOUGH THE **RELAYPRO THORACIC STENT-GRAFT SYSTEM** HAS BEEN MANUFACTURED UNDER CAREFULLY CONTROLLED CONDITIONS, BOLTON MEDICAL, INC., AND ANY ASSOCIATED AFFILIATES, HAVE NO CONTROL OVER THE CONDITIONS UNDER WHICH THIS PRODUCT IS USED. BOLTON MEDICAL, INC., THEREFORE, DISCLAIMS ALL WARRANTIES, BOTH EXPRESSED AND IMPLIED, WITH RESPECT TO THE PRODUCT, INCLUDING, BUT NOT LIMITED TO, ANY IMPLIED WARRANTY OF MERCHANTABILITY OR FITNESS FOR A PARTICULAR PURPOSE. BOLTON MEDICAL, INC. SHALL NOT BE LIABLE TO ANY PERSON OR ENTITY FOR ANY MEDICAL EXPENSE OR ANY DIRECT, INCIDENTAL, OR CONSEQUENTIAL DAMAGES CAUSED BY ANY USE, DEFECT, FAILURE OR MALFUNCTION OF THE PRODUCT WHETHER A CLAIM FOR SUCH DAMAGES IS BASED ON WARRANTY, CONTRACT, TORT, OR OTHERWISE. NO PERSON HAS ANY AUTHORITY TO BIND BOLTON MEDICAL, TO ANY REPRESENTATION OR WARRANTY WITH RESPECT TO THE PRODUCT. BOLTON MEDICAL, INC. (d/b/a Terumo Aortic) IS THE LEGAL MANUFACTURER OF THE **RELAYPRO THORACIC STENT-GRAFT SYSTEM**.

THE EXCLUSION AND LIMITATIONS SET OUT ABOVE ARE NOT INTENDED TO, AND SHOULD NOT BE CONSTRUED SO AS TO, CONTRAVENE MANDATORY PROVISIONS OR APPLICABLE LAW. IF ANY PART OR TERM OF THIS DISCLAIMER OF WARRANTY IS HELD TO BE ILLEGAL, UNENFORCEABLE, OR IN CONFLICT WITH APPLICABLE LAW BY A COURT OF COMPETENT JURISDICTION, THE VALIDITY OF THE REMAINING PORTIONS OF THIS DISCLAIMER OF WARRANTY SHALL NOT BE AFFECTED, AND ALL RIGHTS AND OBLIGATIONS SHALL BE CONSTRUED AND ENFORCED AS IF THIS DISCLAIMER OF WARRANTY DID NOT CONTAIN THE PARTICULAR PART OR TERM HELD TO BE INVALID.



19. PATENTS

<http://www.boltonmedical.com/patents.html>

20. DEFINITIONS

	Manufacturer
	Date of Manufacture
	Use By
	Model/Catalogue Number
	Lot Number
	MR Conditional
	Sterilized by Irradiation
	Do not Re-Sterilize
	Do not Re-use
	Caution
	Consult Instructions for Use or Consult Electronic Instructions for use

20. DEFINITIONS

	Keep Dry
	Temperature Limit
	Do not use if package is damaged
R_x Only	Caution: Federal (USA) law restricts this device to sale by or on the order of a physician.
NBS	Non-Bare Stent Configuration



MANUFACTURER:

BOLTON MEDICAL, INC
799 INTERNATIONAL PARKWAY
SUNRISE, FLORIDA 33325 USA
TELEPHONE: 1 855-726-5866
terumoortic.com

2844-8324 REVISION D

PATIENT INFORMATION BROCHURE

Your Guide to understanding Thoracic Aortic Lesions

RELAY[®]PRO
THORACIC STENT-GRAFT SYSTEM



Table of Contents

Introduction	5
What are thoracic aortic lesions?	6
Thoracic Aortic Aneurysms (TAA)	
Aortic Dissection	
Blunt Traumatic Aortic Injury (BTAI)	
What are current treatment options?	10
Open surgical repair	
Endovascular repair	
What should I expect before, during, and after the procedure?	14
What are the potential risks associated with endovascular repair?	17
Questions to ask your Doctor	19
Glossary	20
Where can I get more information?	22



Introduction

The aorta is the largest and main blood vessel that carries blood from the heart to the rest of the body.

The section of the aorta that is in your chest is called the thoracic aorta. Your thoracic aorta includes the ascending aorta (section of the aorta that is next to your heart), aortic arch (top section of the aorta that connects the ascending aorta and descending aorta), and the descending thoracic aorta (section that is in your chest).

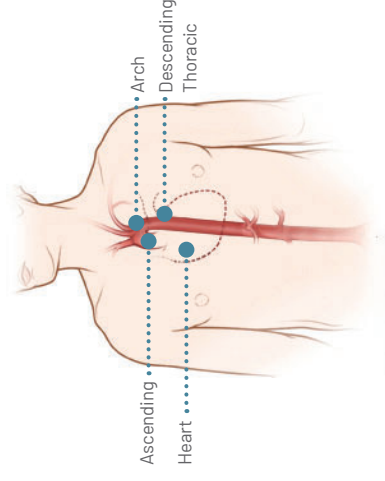

There are many different diseases or injuries (lesions) that can affect the aorta. The more common categories are Thoracic Aortic Aneurysm (TAA), dissection, and Blunt Traumatic Aortic Injury (BTAI).

This brochure describes diseases and injuries of the thoracic aorta and a relatively new device that can be used to treat them, namely an endovascular graft (also known as a stent-graft).

This brochure can be used as a reference, but only your doctor can decide what type of treatment is right for you. Please consult your doctor prior to making any decisions regarding your aortic treatment.

It may be helpful to write down your questions and concerns to discuss later with your doctor and healthcare team. You can use the note page near the end of this brochure.

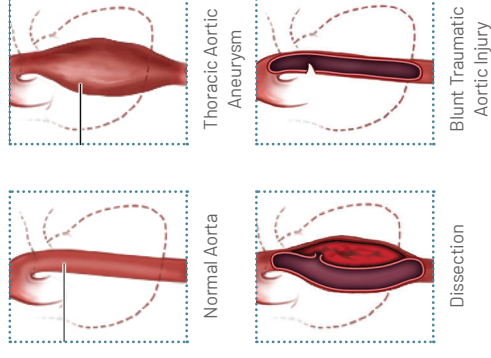

Helpful hints

Some words and terms in this guide might be unfamiliar. You can find their definitions in the glossary.

What is a thoracic aortic aneurysm?

A thoracic aortic aneurysm (TAA) is a weakened and bulging area in the wall of the thoracic aorta (section of the aorta in the chest). TAAs can grow in size over time further weakening the wall of the aorta and may potentially burst or rupture (causing bleeding inside of the body). As the aorta supplies the body with most of the oxygenated blood from the heart, a ruptured TAA can cause life-threatening bleeding.

Most people with a TAA do not experience any outward symptoms¹. For those who do, the most common are:

- ▶ Pain in the jaw, neck, chest and/or back
- ▶ Coughing, hoarseness and/or difficulty breathing

If you experience any of these symptoms, tell your doctor immediately. Your doctor may have you get imaging done to check what may be causing the symptoms.

What is an aortic dissection?

An aortic dissection is a small tear in the inner layer of the aortic wall that allows blood to flow between the layers. An acute aortic dissection has a sudden onset of symptoms similar to a heart attack; for example, symptoms may include chest or back pain, weak pulse, shortness of breath and/or loss of consciousness.

However, the tear may be small or progress slowly so that the dissection becomes chronic. Blood flow between the layers of the aortic wall can cause the same type of ballooning of the aortic wall seen in aneurysms.

Where the tear occurs in the aorta (how close to the heart), how big it is and how far it travels will usually determine whether or not you have symptoms and how urgent treatment is. When deciding when and how to treat the dissection, your doctor will also consider whether there is a risk of rupture or malperfusion (tear in the aorta may decrease or block blood flow to one or more organ(s)).

1. EMedicineHealth Online 2020.

What causes a TAA or an aortic dissection? ¹

Weakening of the aorta over time may be caused by many factors, including vascular disease and genetic conditions. For both aneurysms and dissections, the main risk factors include the following:

- ▶ High blood pressure (hypertension)
- ▶ Smoking
- ▶ Family history of aortic disease (inherited diseases that cause weakening of the blood vessels (Marfan Syndrome, for example))
- ▶ Hardening of the arteries (atherosclerosis)
- ▶ High cholesterol (hypercholesterolemia)

Also, your risk of having a TAA is greater if you are a man over 55 years of age. You may also get a dissection if you already have an aortic aneurysm.

1. Brown SR, Still SA, Eudailey KW, et al. Acute traumatic injury of the aorta: presentation, diagnosis, and treatment. *Ann Transl Med* 2021; 9: 1193.

What is a Blunt Traumatic Aortic Injury (BTAI)?

A Blunt Traumatic Aortic Injury (BTAI) is a tear in the wall of the aorta. The tear may be a complete tear (a tear that goes through the whole wall of the aorta). This causes internal bleeding and is fatal in most cases. The tear may not be a complete tear of the wall of the aorta. The aorta is weakened at the location of the smaller or partial tear and may potentially be ballooned (similar to what is described in the aneurysm section). If the tear is not treated, the aorta could rupture resulting in life-threatening bleeding in the body.

Most often, Blunt Traumatic Aortic Injury occurs because of blunt force trauma and massive deceleration (extremely fast stopping) that causes significant injury to the chest. For example, this may happen due to an car or motorcycle crash or a fall from a very high height.

What are the current treatments for Aortic Lesions?

Medical Management

The size and extent of your aortic lesion will impact which treatment option that your doctor recommends for you. If the disease or injury to your aorta is small, your doctor may recommend regular follow-up visits to monitor your lesion (check whether it grows in size or extent). Your doctor may also recommend medical or lifestyle changes to lower the stress on the aortic wall such as blood pressure medication and/or stop smoking.

Repair

If your lesion is quickly growing in size or is of a certain size, there is a higher risk of rupture. This risk of rupture will continue to increase as the lesion size and extent increase.

If your doctor recommends that treatment is needed for your lesion, there are two options that are available:

- ▶ Open surgical repair
- ▶ Endovascular repair

Both repair options have possible risks (complications) and benefits. You should discuss the best option for you with your doctor. Each of these options are discussed in more detail in the pages that follow.



What is open surgical repair?

During open surgical repair, your doctor will make a cut in your side so that the aneurysm can be replaced with a fabric tube (graft) that is sewn in place in your aorta above and below your aneurysm. Blood will then flow through the graft. This surgery reduces the likelihood of vessel rupture.

Open surgical repair is performed under general anesthesia and typically takes 4 to 6 hours to complete. After surgery, you may stay in hospital for 7 to 10 days.¹ If your TAA is complicated or if you have other conditions such as heart, lung or kidney disease, you may require 2 to 3 months for a complete recovery.

Do I need open surgery?

Not all aneurysms require treatment. The risk of rupture and, therefore, the need for repair depends on the size of the aneurysm. If the aneurysm is large (more than 5.0cm in diameter), your doctor may prefer to treat the condition with open surgery rather than taking a less invasive approach. This protects the aorta from rupture. Your doctor may prefer to “wait and see” by taking images at 6 to 12 month intervals if your aneurysm is small. These images will allow the doctor to observe whether the aneurysm grows with time to a size that might be more dangerous. Average enlargement is about 0.5cm per year, so surgery may be required at a later stage. Your doctor will explain the various options and recommend the preferred treatment for you.

The open surgical operation

You will initially be taken to a reception area, then to the anesthetic room where you will be given anesthetic, and then into the operating room.

While asleep, you may have a small tube placed in your back (epidural) to help with pain relief following surgery. Also, tubes will be inserted into your bladder to drain urine, into your stomach (via your nose) to prevent nausea and into a vein in your neck for blood pressure measurements and administration of fluid following surgery. You will have a cut either down or across your abdomen. Occasionally, it is necessary to make a smaller cut on one or both sides of your groin.

Is open surgery successful?

If aneurysms are repaired before they rupture, there is a high overall chance of successful repair and a return to normal life expectancy. However, you should discuss the risks of open surgery in your particular case with your doctor.

Complications with open surgery

Chest infections can occur following this type of surgery, particularly in smokers, and may require treatment with antibiotics and physiotherapy. Slight discomfort and twinges of pain in your wound are normal for several weeks following surgery. Wounds sometimes become infected and these can usually be successfully treated with antibiotics. Also, the groin wound can fill with a fluid called lymph that may leak between the stitches but this usually decreases with time. As with any major operation, there is a small risk of medical complication such as a heart attack. The doctors and nurses will try to prevent such complications and deal with them rapidly should they occur. Occasionally, the bowel is slow to start working again, but fluids will be provided in a drip until your bowels return to normal. Sexual activity may be affected due to nerves in your abdomen being cut during the operation.

What is endovascular repair?

Endovascular repair is a minimally-invasive way to treat aortic lesions.

Endovascular repair uses a stent-graft. A stent-graft is a fabric tube supported by a metal frame which is placed in the diseased aorta (section of your aorta where the lesion is located). The stent-graft allows blood to flow normally through your aorta and is designed to protect the diseased aorta from blood pressure and flow.

During an endovascular procedure, a stent-graft, which is compressed inside a narrow plastic tube called a delivery system, is inserted through a small cut in your groin and tracked through your blood vessels. During the procedure, your doctor will use live x-ray pictures viewed on a video screen to guide the stent-graft to the section of your aorta where the lesion is located. The stent-graft will open inside your aorta and become the new channel for blood flow. The stent-graft is designed to reduce the pressure on the aortic wall and to prevent further growth of your lesion and prevent rupture of your aorta.

Following endovascular repair, you may stay for 2 or 3 days in hospital. Because many patients that get a BTAI are a result of a car crash or high fall, patients may have other non-aortic injuries that need attention and your hospital stay may be extended to address those other injuries. You should speak to your doctor to understand if endovascular repair is the right treatment for you. Endovascular repair requires yearly lifelong imaging and regular follow-up.

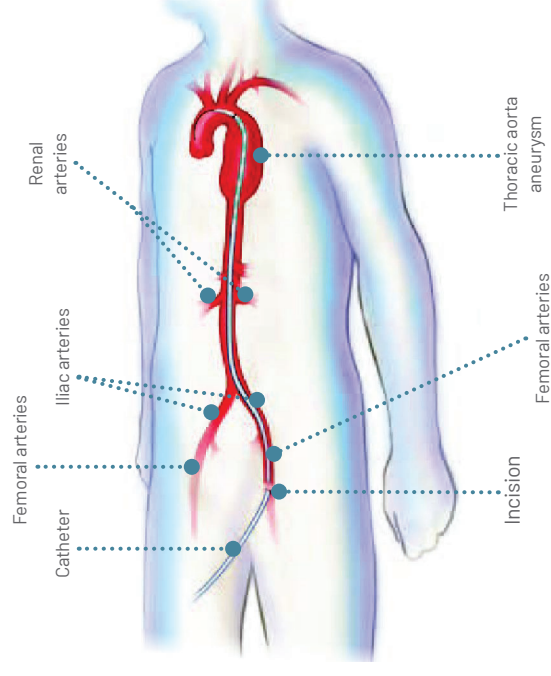

The above picture shows a thoracic aortic aneurysm (TAA). A similar approach would be taken for other lesions, such as dissections and BTAI.

The Terumo Aortic Difference

Endovascular repair with the Relay®Pro Thoracic Stent-Graft System

The Relay®Pro Stent-Graft is a woven polyester graft (fabric tube) that is supported by a series of stents (metallic rings) which are made from a strong, thin metal called Nitinol. The stent-graft is placed inside the thoracic aorta using a delivery system (thin tubes that contain and deliver the compressed stent-graft).

The Relay®Pro Stent-Graft is available in two configurations: a bare metal stent and covered stent (NBS). Once you and your doctor agree that endovascular repair with the Relay®Pro Stent-Graft is right for you, your doctor will determine the exact size and configuration of the device to use.

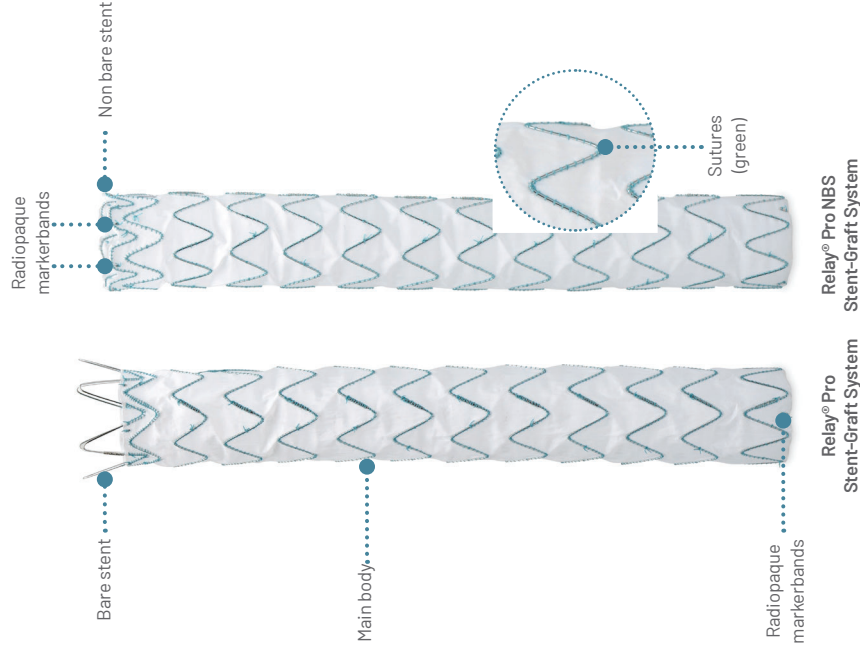

Clinical Data Summary

The Relay[®]Pro Thoracic Stent-Graft System was evaluated in over 200 patients in three clinical studies to better understand the safety and benefits of the procedure with the Relay[®]Pro device. The primary study had 115 patients thoracic aortic aneurysms (TAAs) treated in the United States (US) and Japan. Two additional clinical studies were completed in the US treating patients with aortic dissections (56 patients) and blunt traumatic aortic injuries (50 patients).

These studies included patients between the ages of 19 and 91 years old. The health and medical history of these patients may or may not be similar to yours. Discuss with your doctor how your situation may be different or similar. In the thoracic aortic aneurysm study, 100% remained free from device technical failure and 87.4% were free from major safety events followed out through 1-year. The results from the aortic dissection and blunt traumatic aortic injuries studies also confirmed the safety and effectiveness of the Relay[®]Pro Thoracic Stent-Graft System. No new safety risks were identified in these studies with the use of the Relay[®]Pro Thoracic Stent-Graft System.

All three clinical studies support the safety and effectiveness of the Relay[®]Pro Thoracic Stent-Graft System in the endovascular repair of lesions (diseases or injuries) in the descending thoracic aorta (portion of the aorta in your chest), including thoracic aortic aneurysms, dissections, and blunt traumatic aortic injuries.

Many problems experienced after repair of a diseased or injured aorta do not have symptoms and you will have to schedule regular follow-up visits with your doctor to check on your progress and requires yearly lifelong imaging.

A brief overview of the outcomes of the studies through 1-year are presented below:

Aneurysm & Penetrating Atherosclerotic Ulcers (PAU) Study (110 patients treated)	Dissection Study (56 patients treated)	Blunt Traumatic Aortic Injuries Study (50 patients treated)
98.2% Freedom from Aneurysm-Related Death	98.1% Freedom from Dissection Related Death	98% Freedom from Aortic-Related Mortality
87.4% Freedom from Major Safety Events <i>(death, heart attack, stroke, kidney failure, respiratory failure, paralysis not including paraparesis, bowel ischemia, high procedural blood loss)</i>	89.1% Freedom from Major Safety Events <i>(disabling stroke, kidney failure (not pre-existing), paraplegia, paraparesis)</i>	95.8% Freedom from Major Safety Events <i>(death and paralysis)</i>
6 subjects had additional procedures related to the treated disease or for reasons related to the stent-graft	12 subjects had additional procedures related to the treated disease or for reasons related to the stent-graft	4 subjects had additional procedures related to the treated disease or for reasons related to the stent-graft
No subjects had to have their device replaced	3 subjects had open surgery to treat their dissection	No subjects had to have their device replaced
1 subject had an increase in size of their aneurysm after the treatment	2 subjects had an increase in size of their aorta after the treatment	No subjects had an increase in size of their aorta after the treatment
No subjects in the study have had a rupture/burst of the aneurysm	No subjects in the study have had a rupture/burst of the lesion	No subjects in the study have had a rupture/burst of the lesion
No subjects in the study experienced breaks in their device	No subjects in the study experienced breaks in their device	No subjects in the study experienced breaks in their device
		One subject had their device narrow and also had paraplegia.

Before undergoing endovascular repair

If endovascular repair is recommended, your doctor may ask you to have some further tests before the procedure, such as CT or MR scans. These tests will allow the doctor to review your aorta and determine the proper size of stent-graft that is needed; the stent-graft will be sized to fit your aorta.

The procedure

Typically, endovascular repair takes 2 to 3 hours to complete. You will be asleep during the procedure and will not feel any pain. An overview of the procedure is briefly discussed below; please discuss any questions that you have on the procedure with your doctor.

1. A small cut is made on one side of your groin.
2. A delivery system is inserted into the opening and guided through your femoral artery to reach the part of your aorta that needs to be treated. Throughout the procedure, the doctor will view live x-ray pictures of your aorta to make sure the stent-graft is properly placed. This requires the use of dyes (see warning section on page 18 regarding the use of dyes).

3. Once the delivery system reaches the correct location, the stent-graft is deployed (expanded to its full size). When your stent-graft is released, it seals the aorta above and below the section where your disease/lesion is located from blood flow.

Note: The size and number of stent-grafts used will depend on your lesion and your doctor's assessment.

4. The delivery system is removed from the body.
5. Once the delivery system is removed, the doctor will recheck that your stent-graft is working properly.
6. The opening in the groin is closed and the procedure is complete.

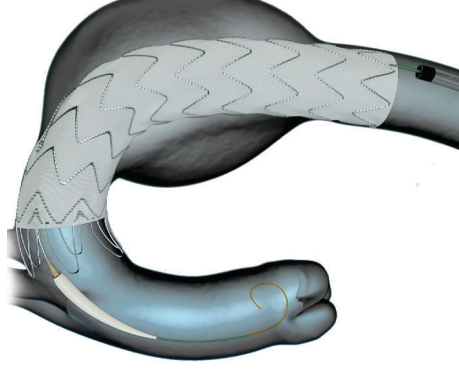

The stent-graft inside the TAA

In this picture, the stent-graft is shown after it is positioned in your aorta and before delivery system is removed from your body. Please note that a thoracic aortic aneurysm (TAA) is shown in the picture. The device will be similarly positioned for the other aortic lesions.

What should I expect after the procedure?

Immediately after treatment

Immediately after recovery from the stent-graft procedure you may be required to lie flat for 4 to 6 hours. This allows for the healing to begin in your groin. Some patients experience mild discomfort such as swelling of the groin area or fever, but this usually resolves in a few days.

Other side effects may include:

- ▶ Numbness or weakness of the legs
- ▶ Nausea
- ▶ Vomiting
- ▶ Leg pain or throbbing
- ▶ Lack of appetite
- ▶ Endoleak (blood flow into the lesion after placement of a stent-graft)
- ▶ Absence of bowel movement for 1 to 3 days



When to call your doctor

Call your doctor immediately or visit the nearest emergency room if you experience any of the following symptoms:

- ▶ Pain, numbness, or weakness in the legs, back, chest or abdomen
- ▶ Fainting
- ▶ Rapid heartbeat or sudden weakness
- ▶ Discoloration or coldness in the leg
- ▶ Pain or swelling at the access site incision
- ▶ Dizziness

If you do not seek medical attention for these symptoms, they could seriously harm you or cause death.

Follow-up

Your doctor will discuss your follow-up plan which will include check-ups at 1 month, 6 months, 12 months and annually thereafter for the rest of your life. Endovascular repair requires that you continue to see your doctor regularly for the rest of your life to make sure that your device is working properly. This is important as some problems do not show symptoms and you may not feel them.

During your follow-up examinations, you may routinely receive:

- ▶ X-rays
- ▶ Blood tests
- ▶ CT scans
- ▶ Ultrasound or MR system scans
- ▶ Physical examinations

Maintaining regularly scheduled follow-up examinations is necessary for your doctor to find out if your stent-graft is working properly and to monitor any changes in your condition over time.

If you do not attend follow-up examinations, your doctor will not know if:

- ▶ blood is leaking into your lesion (endoleak)
- ▶ the stent-graft has moved (migrated)
- ▶ the stent-graft has other issues

During examination, your doctor may also request evaluations to see if additional treatment may be required.

Implant card

Before leaving the hospital, you will be given a patient implant card. Along with your personal information, the following is included:

- ▶ Your implant(s) model and ID number
- ▶ Date of implant
- ▶ Hospital name
- ▶ Manufacturer's name and contact information
- ▶ Doctor's name
- ▶ MR system safety conditions
- ▶ Nurse's name

Keep this card with you at all times. Please share this information with your health care providers and make them aware you have been treated with a Relay® Pro Thoracic Stent-Graft.

It is also important to show this implant card to your doctor before you undergo imaging in an MRI machine.

Your implant card contains safety information that your doctor needs in order to make sure that you are safely imaged.



Possible risks of endovascular repair

As with any endovascular repair, repair with a thoracic stent-graft comes with potential risks. Please discuss all risks with your doctor. Major risks associated with thoracic endovascular stent-grafts include, but are not limited to:

- ▶ Endoleak – when blood continues to flow into the lesion
- ▶ Migration – movement of the stent-graft from its original position
- ▶ Device-related issues such as breaking of the sutures or metal portion of the stent-graft, fabric defects/tears or component separation
- ▶ Continued growth of the lesion
- ▶ Aortic rupture
- ▶ Additional endovascular or surgical procedures
- ▶ Heart attack
- ▶ Stroke
- ▶ Stent-Graft Thrombus
- ▶ Paraplegia
- ▶ Kidney failure
- ▶ Access site incision compl
- ▶ Conversion to open surgic.
- ▶ Death

Together with your doctor, you will decide on the best option for treating your thoracic aortic lesion.



Who should not have endovascular repair (Contraindications)?

The Relay®Pro Thoracic Stent-Graft System is contraindicated for the following:

- ▶ Patients with a known allergy or intolerance to device materials as listed

Implant Component	Material
Stent	Nitinol (including nickel)
Graft	Woven polyester
Sutures	Braided polyester
Radiopaque Markers	Platinum (90%) – Iridium (10%)

- ▶ Patients with a condition that threatens to infect the graft

These are general contraindications and only your doctor can say if endovascular repair is the right treatment for you.

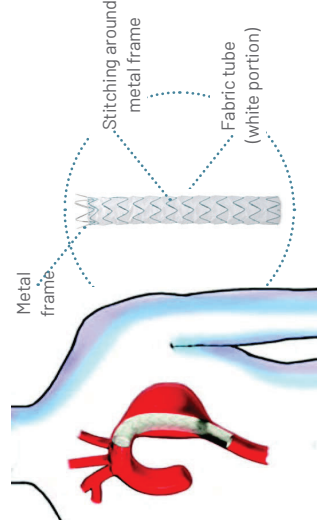

Important warnings and precautions

The following are general warnings and precautions. Please discuss with your doctor all warnings and precautions related to endovascular repair.

Data is not available on patients who have or are:

- ▶ connective tissue disease
- ▶ blood clotting diseases
- ▶ pregnant
- ▶ morbidly obese
- ▶ torn, ruptured, or bleeding aorta
- ▶ systemic infection
- ▶ less than 18 years old

Your doctor will help you decide whether it is appropriate for you to get a stent-graft if any of the following situations apply to you:

- ▶ Cannot complete regular follow-up visits and imaging examinations
- ▶ Cannot tolerate injectable dyes needed for imaging examinations
- ▶ Have bleeding disorders
- ▶ Cannot use blood thinners

Questions to ask your Doctor

- ▶ What are all of my treatment options?
- ▶ What are the advantages and disadvantages of endovascular repair compared to open surgical repair?
- ▶ What are the risks of rupture with a stent-graft?
- ▶ Will I have any side effects from the procedure?
- ▶ After the procedure, how often will I need to see my doctor?
- ▶ What follow-up tests will be needed?
- ▶ Why is it important to continue to see my doctor after I get an endovascular procedure even if I have no symptoms?
- ▶ What if the lesion continues to grow after endovascular treatment?
- ▶ Will I have to limit my activities after the treatment? If so, for how long?
- ▶ How long can the stent-graft remain inside my body?
- ▶ How many endovascular repair procedures has my doctor performed?
- ▶ Is the Relay[®]Pro Thoracic Stent-Graft an appropriate treatment for me?



Your questions

A large, empty rectangular box with a dashed blue border, intended for the user to write their questions.

Glossary

Anatomy

The structure of parts of the human body.

Aneurysm/Thoracic Aortic Aneurysm (TAA)

A widening or ballooning (thinning and enlarging) of a portion of the thoracic aorta caused by a weakness in the wall of the blood vessel.

Aorta

The main artery that carries blood away from the heart distributing it to the rest of the body.

Artery

A blood vessel that carries blood away from the heart.

Blunt Traumatic Aortic Injury (BTAI)

A tear in the thoracic aorta (the portion of the aorta that is within the chest and close to the heart) that is often due to severe injury to the chest.

Bowel Ischemia

Conditions that occur when blood flow to your intestines decreases.

Contraindication

A specific situation where the device may not be used because it may be harmful to the person.

Computed Tomography Scan (CT/CAT Scan)

An imaging technique that creates very precise, thin, cross-sectional views of the human body.

For patients under consideration for aortic lesion treatment, this scan will focus on the chest, abdomen and aorta. This technique often utilizes contrast (dye) and always requires limited radiation exposure.

Endoleak

The presence of a persistent flow of blood into the lesion after a stent-graft is placed.

Endovascular

Inside or within a blood vessel.

Endovascular Repair

A less invasive option for the repair of a thoracic aortic lesion as compared to open surgical repair.

It involves the use of an endovascular graft (also called a stent-graft) that excludes (seals off) the lesion, thereby creating a new path for blood to flow.

The technique uses real time X-rays allowing the doctor to see the location of the device and lesion to ensure proper device placement.

The doctor will also use a variety of other temporarily placed devices (such as guidewires) to perform the treatment. Please ask your doctor if you have questions on these other devices that will help to place the stent-graft.

Exclude the Lesion

The stent-graft is designed to exclude the lesion, meaning that when it is placed within the aorta it provides an alternate blood flow path.

Femoral Artery

The main artery within each leg between the area of the hip and knee that brings blood to the lower part of your body (limbs)

Doctors perform many endovascular procedures, including treatment of thoracic aortic aneurysms, using the femoral artery as the primary access site (location where the stent-graft enters the blood vessels).

Iliac Artery

The main artery on each side of the body that takes blood from the abdominal aorta to the femoral artery. In addition to bringing blood to the lower extremities, the iliac artery also provides blood to the pelvic regions of the body.

Imaging

The use of X-rays, CT scans, MRI scans or other techniques to get pictures inside of the body.

Lesion

Different types of diseased or injured areas of a blood vessel, such as aneurysms, dissections, and blunt traumatic injuries.

Magnetic Resonance Imaging (MRI)

A diagnostic technique that uses magnetic fields and radio waves to visualize structures inside the body.

Minimally-invasive

Involves one or more small incisions to perform a procedure versus one large incision.

Open Surgical Repair

A procedure in which a doctor makes a large cut in the chest or stomach to remove an aneurysm and then replace it with a fabric graft.

Paralysis

The loss of the ability to move some or all of your body.

Paraparesis

When you are partially unable to move your legs and can also refer to weakness in your hips and legs.

Paraplegia

The loss of the ability to move the legs and lower body.

Penetrating Ulcers

A rare condition that most commonly develops in the aorta when plaque starts to penetrate the aortic wall, putting it at risk for rupture.

Plaque

A fatty material deposit on the inner lining of an arterial wall that may or may not be calcified.

Rupture

A tear in the wall of a blood vessel that allows blood to leave the vessel and flow into areas of the chest around the heart, lungs, or abdomen. This could be a potential life-threatening event.

Stent-graft/thoracic stent-graft

A fabric tube supported by a metal framework that a doctor uses to treat a lesion in the thoracic aorta. A stent-graft is also known as an endovascular graft.

Thoracic Aorta

The section of the aorta located in the chest.

Where can I get more information?

Useful sites

www.webmd.com/heart-disease/heart-disease-aortic-aneurysm

The WebMD Medical Team works closely with a team of over 100 doctors and health experts nationwide across a broad range of specialty areas to ensure WebMD's content is up to date, accurate, and helps you live a healthier life.

www.medlineplus.gov

The National Library of Medicine (NLM), on the campus of the National Institutes of Health in Bethesda, Maryland, is the world's largest medical library. The library collects materials in all areas of biomedicine and health care, as well as works on biomedical aspects of technology, the humanities, and the physical, life, and social sciences.

www.vascular.org/patients

The Society for Vascular Surgery® (SVS) is a not-for-profit professional medical society, seeking to advance excellence and innovation in vascular health through education, advocacy, research and public awareness. SVS is the national advocate for more than 5,800 specialty-trained vascular surgeons and other professionals dedicated to the prevention and cure of vascular disease.

www.aortictrauma.org

The Aortic Trauma Foundation (ATF) is a non-profit professional medical society, composed primarily of vascular surgeons, cardiothoracic surgeons, trauma surgeons and radiology physicians, dedicated to providing educational resources to aid in the early detection, treatment, and survival after Traumatic Aortic Injuries.

Product Information

Terumo Aortic

www.terumoaoortic.com

Terumo Aortic is a global medical device company dedicated to developing solutions for aortic and peripheral vascular disease.

Food and Drug Administration

www.fda.gov

A US government agency intended to promote and protect the public health by helping safe and effective products reach the market in a timely way, and monitoring products for continued safety after they are in use.

US Department of Health and Human Services

www.hhs.gov

HHS helps families and individuals stay safe and informed about food, drugs, medical devices, and more. Information is available about medical device safety for consumers, healthcare providers and regulated industry, including device recalls.



MRI System Safety Information



A person with the Relay[®]Pro Thoracic Stent-Graft may be safely scanned under the following conditions. Failure to follow these conditions may result in injury.

Device Name	Relay [®] Pro Thoracic Stent-Graft
Static Magnetic Field Strength (B0)	1.5T or 3.0T
Maximum Spatial Field Gradient	30 T/m (3,000 gauss/cm)
RF Excitation	Circularly Polarized (CP)
RF Transmit Coil Type	Whole-body transmit coil
Operating Mode	Normal Operating Mode
Maximum Whole-Body SAR	2 W/kg (Normal Operating Mode)
Maximum Head SAR	3.2 W/kg (Normal Operating Mode)
Scan Duration	2 W/kg whole-body average SAR for 60 minutes of continuous RF (a sequence or back to back series/scan without breaks)
MR Image Artifact	The presence of the Relay [®] Pro Thoracic Stent-Graft may produce an image artifact at 5mm. Some manipulation of scan parameters may be needed to compensate for the artifact.

Your notes





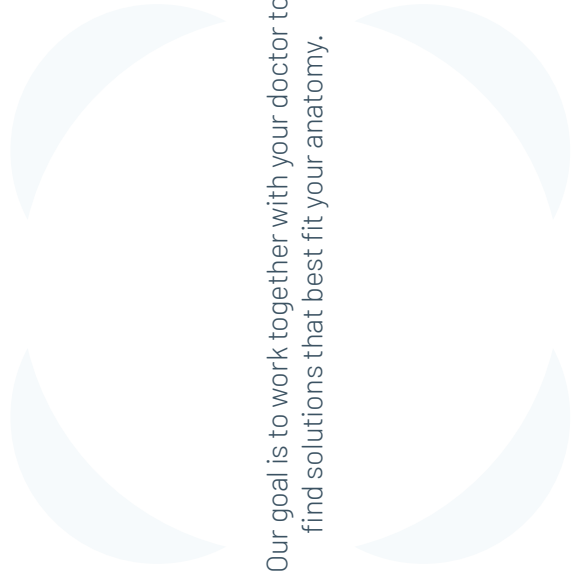

Our goal is to work together with your doctor to
find solutions that best fit your anatomy.

Your medical practitioner will be able to answer any specific questions you may have on your condition.
This information was produced as a service to medicine by Terumo Aortic.

terumoaortic.com

Discover solutions for every segment of the aorta

Visit our website for more information on use, indications, contraindications, warnings/precautions and availability within your market.

Product availability subject to local regulatory approval. Caution: Federal Law (US) restricts this device to sale by or on the order of a physician.

Manufactured by: Bolton Medical Inc, 799 International Parkway, Sunrise, Florida 33325, USA

XXXXX • P1M-XXXXX

