



**Federal Aviation  
Administration**

DOT/FAA/AM-17/10  
Office of Aerospace Medicine  
Washington, DC 20591

# **Descriptive Characteristics of Atrial Fibrillation in Civil Aviation 1993-2005**

Stephen J. H. Véronneau  
Paul Rogers

Civil Aerospace Medical Institute  
Federal Aviation Administration  
Oklahoma City, OK 73125

April 2017

Final Report

## **NOTICE**

This document is disseminated under the sponsorship of the U.S. Department of Transportation in the interest of information exchange. The United States Government assumes no liability for the contents thereof.

---

This publication and all Office of Aerospace Medicine technical reports are available in full-text from the Civil Aerospace Medical Institute's publications website:  
<http://www.faa.gov/go/oamtechreports>

**Technical Report Documentation Page**

1. Report No. DOT/FAA/AM-17/10		2. Government Accession No.		3. Recipient's Catalog No.	
4. Title and Subtitle Descriptive Characteristics of Atrial Fibrillation in Civil Aviation 1993-2005				5. Report Date April 2017	
				6. Performing Organization Code	
7. Author(s) Véronneau SJH, Rogers P				8. Performing Organization Report No.	
9. Performing Organization Name and Address FAA Civil Aerospace Medical Institute P.O. Box 25082 Oklahoma City, OK 73125				10. Work Unit No. (TRAIS)	
				11. Contract or Grant No.	
12. Sponsoring Agency name and Address Office of Aerospace Medicine Federal Aviation Administration 800 Independence Ave., S.W. Washington, DC 20591				13. Type of Report and Period Covered	
				14. Sponsoring Agency Code	
15. Supplemental Notes					
16. Abstract <b>Introduction.</b> This study was undertaken to examine the aviation safety and aeromedical aspects of certifying pilots with the medical condition of atrial fibrillation (AFIB). Results of this study are of use to aerospace medical practitioners, clinicians, flight safety analysts, and aeromedical certification specialists. Atrial fibrillation is the most common heart rhythm disorder among pilots, some estimates of atrial fibrillation prevalence in the general US population suggest it may become as common as one in four individuals in the near future. A threefold increase in AFIB among pilots has been seen over the study period. <b>Methods.</b> For a 13-year period from 1993-2005 the electronic medical records of pilots with AFIB and all other pilots were compared for a variety of factors including: age, gender, experience, self-reported flight hours flown, pilot certifications, and medical class issued. Algorithms were constructed to allow the determination of the number of months for a pilot's active status, effective medical class, and accurate ages. Select hardcopy records were reviewed to document the clinical status of AFIB mishap pilots. <b>Results.</b> Atrial fibrillation pilots as a group are older. They are as safe, and perhaps safer than pilots in general. Their percentage of mishaps that were human factor related was less (67.4 versus 81.3%) than all other pilots grouped together. AFIB pilots have 0.36% of the NTSB events during this period; they did not have any in-flight incapacitations. The only NTSB events due to AFIB as a cause or factor were among 3 events where the pilots were not properly certified and thus did not hold valid medical certificates. In one fatal case, an AME and the event pilot colluded to deceive FAA medical certification authorities. In the study period very few pilots participated by keeping an active medical for the entire interval, indicating there is a great deal of churn among airmen medical certificate applications. <b>Conclusion.</b> The methodologies developed in this study will be used to examine many other conditions of aeromedical interest and other mishap factors of interest to mishap investigators, as well as certification and regulation authorities. A long period of observation, documentation of large number of pilots and careful attention to data quality issues were necessary to allow comparison of a group of 6,721 AFIB pilots, which comprised only 0.44% of the total 1,526,889 pilot population during 1993-2005.					
17. Key Words Aeromedical Certification, Atrial Fibrillation, Aviation Safety, Epidemiology, Aviation Medicine, Scientific Information System, Data Mining, Decision Support System, Data Warehouse, Database			18. Distribution Statement Document is available to the public through the Internet: <a href="http://www.faa.gov/go/oamtechreports/">http://www.faa.gov/go/oamtechreports/</a>		
19. Security Classif. (of this report) Unclassified		20. Security Classif. (of this page) Unclassified		21. No. of Pages 25	22. Price

# Contents

## DESCRIPTIVE CHARACTERISTICS OF ATRIAL FIBRILLATION IN CIVIL AVIATION 1993-2005

1.0 INTRODUCTION .....	1
1.1 Medical Certification Aspects .....	1
1.2 Airmen/Pilot Certificate .....	3
1.2.1 <i>Flying Operation</i> .....	3
1.2.2 <i>Medical Certificate</i> .....	3
1.2.3 <i>Atrial Fibrillation</i> .....	4
2.0 METHODS.....	6
2.1. Sources of Data for SIS .....	6
2.1.1 <i>Document Imaging Workflow System</i> .....	6
2.1.2 <i>Aviation Accident and Medical Database–Decision Support System     (AAMD–DSS) Warehouse</i> .....	6
2.1.3 <i>NTSB Downloadable Dataset</i> .....	7
2.2 Study Variables .....	7
2.2.1 <i>Active</i> .....	7
2.2.2 <i>AFIB</i> .....	8
2.2.3 <i>Months Contributed</i> .....	9
2.2.4 <i>NTSB Mishap</i> .....	9
2.2.5 <i>FAA Accident Incident Database System Mishap</i> .....	9
2.2.6 <i>Data Limitations-Mishap Characterization Review</i> .....	9
3.0 RESULTS .....	10
3.1. Warehouse Dataset .....	10
3.2 Counts of Airmen .....	11
3.3 Prevalence and Incidence .....	12
3.4 Age Distributions .....	13
3.5 Months Contributed for AFIB and non-AFIB Airmen.....	15
3.6 Mishaps .....	16
3.7 Characterization of Mishaps.....	16
3.8 NTSB Events with Human Factors Causes for Non-AFIB Airmen .....	18
3.9 NTSB Case Reviews and Incapacitations .....	19
3.10 AIDS Dataset Human Factors Numbers.....	20
3.11 Difference In NTSB Mishap Event Proportions (Non-AFIB – AFIB).....	20
3.12 Mishap Rates .....	21
3.13 Summary .....	21
4.0 DISCUSSION .....	21
5.0 REFERENCES .....	23

---

# DESCRIPTIVE CHARACTERISTICS OF ATRIAL FIBRILLATION IN CIVIL AVIATION 1993-2005

*There are in fact two things, science and opinion; the former begets knowledge, the latter ignorance.*

–Hippocrates

## 1.0 INTRODUCTION

This study was undertaken to examine the aviation safety and aeromedical aspects of certifying pilots with the medical condition of atrial fibrillation (AFIB). Results of this study are of use to aerospace medical practitioners, clinicians, flight safety analysts, and aeromedical certification specialists.

A methodology was developed to examine the electronic medical records of aviators used by the Federal Aviation Administration (FAA) Office of Aerospace Medicine. Using a research warehouse of medical certification records, mishap investigation outcome records, airmen registry records, as well as highly specialized datasets maintained by the Civil Aerospace Medical Institute (CAMI), Aerospace Medicine Research Division, we studied the patterns of applications, issuances, and active airmen count and looked at overall mishap trends with respect to a subgroup of certified airmen with AFIB.

For a 13-year inclusive period from 1993-2005, the medical certificate status of a pilot was determined as well as the number of months a pilot held a valid medical certificate. The medical class issued, gender, age, AFIB status, and flight hours reported on the medical certificate application form were noted as well.

The current study focused on AFIB prevalence in the U.S. civil pilot population using FAA and National Transportation Safety Board (NTSB) databases to make this review possible. The main objective was to determine if the group of AFIB airmen were at greater risk of an aviation accident than airmen without this condition. For the purposes of this research, an aviation accident was an event recorded in the NTSB's accident database or the FAA's Accident Incident Database System (AIDS).

### 1.1 Medical Certification Aspects

A pilot must have an airmen certificate with the rating appropriate to the aircraft and flight conditions to be undertaken and must also have a valid medical certificate. Airmen certificates do not have an expiration date unless they are revoked or surrendered. Medical certificates have a duration limitation and must be periodically renewed. An FAA-designated aviation medical examiner (AME) conducts the physical for medical certificate applicants. There are over 5,000 AME physicians within the USA and few located internationally. Aviation Medical Examiners are authorized to receive applications, perform physical examinations, and issue airman medical certificates. They may also defer an application for further review or deny an applicant; however, an AME denial is not a formal denial under the regulations.

Under Title 14 of the Code of Federal Regulations (14 CFR) Part 1, the Federal Aviation Administration (FAA) defines a medical certificate as "acceptable evidence of physical fitness on a form prescribed by the Administrator." The primary goal of the airman medical certification program is to protect not only those who would exercise the privileges of a pilot certificate but also air travelers and the general public. A person who meets FAA airmen medical standards, based on a medical examination and an evaluation of medical history, is entitled to a medical certificate without restriction or limitation other than the prescribed limitation as to its duration. Any person exercising the privileges of the following

certificates must hold a valid medical certificate: airline transport pilot certificate, commercial pilot certificate, private pilot certificate, recreational pilot certificate, flight instructor certificate (when acting as pilot in command if serving as a required pilot flight crewmember), flight engineer certificate, flight navigator certificate, or student pilot certificate. There are no minimum or maximum ages for obtaining a medical certificate. Any applicant who is able to pass the exam may be issued a medical certificate. However, since 16 years is the minimum age for a student pilot certificate, people under 16 are unlikely to have practical use for an airman medical certificate.

Certain medical conditions are disqualifying, but in many cases when the condition is adequately controlled, the FAA will issue a medical certificate contingent on periodic reports through a special issuance (SI) process.

The following conditions are disqualifying medical conditions:

- 1) Diabetes mellitus requiring hypoglycemic medications
- 2) Angina pectoris
- 3) Coronary heart disease that has been treated or, if untreated, that has been symptomatic or clinically significant
- 4) Myocardial infarction
- 5) Cardiac valve replacement
- 6) Permanent cardiac pacemaker
- 7) Heart replacement
- 8) Psychosis
- 9) Bipolar disease
- 10) Personality disorder that is severe enough to have repeatedly manifested itself by overt acts
- 11) Substance dependence
- 12) Substance abuse
- 13) Epilepsy
- 14) Disturbance of consciousness without satisfactory explanation of cause
- 15) Transient loss of control of nervous system function(s) without satisfactory explanation of cause

Other conditions not specifically listed in the regulations are also disqualifying. For further information refer to the Guide for Aviation Medical Examiners.<sup>5</sup>

Medical certificates have varying classes:

- A first-class airman medical certificate is required to exercise the privileges of an airline transport pilot certificate.
- A second-class airman medical certificate is required for commercial, non-airline duties (e.g., for crop dusters, corporate pilots). Those exercising the privileges of a flight engineer certificate, a flight navigator certificate, or acting as air traffic control tower operator must hold a second-class airman medical certificate.
- A third-class airman medical certificate is required to exercise the privileges of a private pilot certificate, recreational pilot certificate, a flight instructor certificate, or a student pilot certificate.

Many people are not familiar with the complicated rules governing the various certificates that pilots must possess before conducting flying operations.

## **1.2 Airmen/Pilot Certificate**

Airmen are required to have a valid pilot certificate, which documents their aeronautical skills by indicating which types of aircraft they may pilot as pilot in command (PIC). These certificates are issued to pilots who have passed a written and flight exam to demonstrate proficiency to the FAA. Such certificates have an indefinite duration unless revoked or modified by the FAA. There are five broad pilot certificate levels: Air Line Transport, Commercial, Private, Recreational, Student, and Sport. There are also notations for the various aircraft type, make, and model that affect which aircraft a pilot may fly as PIC. There are other airmen certificates such as those for parachute riggers and tower controllers that are not pilot certificates but still have a requirement for a valid medical certificate. Pilots with higher level airmen certificates also enjoy the privileges of the lower certificates. An Airline Transport Pilot may also fly as a Commercial or General Aviation pilot.

### ***1.2.1 Flying Operation***

The type of flying being conducted can generally be categorized as Scheduled Airline, Non-Scheduled Airline, Commuter, Air Taxi On-Demand, and General Aviation. Each type of flying operation requires the pilot to have a commensurate Pilot Certificate, Pilot Rating, and Medical Certificate. Generally, an Airline Flight Operation requires an Airline Transport Pilot Certificate, the appropriate rating for the type of aircraft being used, and a first-class Medical Certificate for the Captain. The First Officer will require at least a second-class Medical Certificate, a Commercial Pilot Rating, and a Type Rating, if necessary, for the type of aircraft being flown. General aviation pilots must have, at a minimum, a Private pilot airmen certificate, a third-class medical certificate, and the pilot ratings sufficient for the aircraft type they are flying as PIC.

Flight Instructors are not required to have a current medical certificate if the pilot they are instructing can act as PIC of the type of aircraft used in the instruction.

### ***1.1.3 Medical Certificate***

Airmen are also required to have a current medical certificate of the category sufficient for the type of flying operation they are undertaking. Medical certificates have three broad categories: first-, second-, and third-class. One additional category is for an SI certificate, which can be any of the three classes and is characterized by special follow up and monitoring procedures in addition to a time limitation placed upon the special medical certificate. There are many smaller notations that affect the validity and duration of a medical certificate. Pilots may hold medical certificates higher than the level needed for their flying activities. Whereas the type of flying that a particular pilot engages in is not recorded in the medical certificate application, it is often requested for SI pilot medical applications.

In addition to the variable duration of a medical certificate, pilots can choose to have another exam to apply for new certificate at any time. They may also apply for a different level of certificate at any time and for any reason. Pilots may apply for a medical certificate class which is higher than the minimum required for the type of flying they perform. SI medical certificates often have a limitation of a stipulated date of expiration in the authorization letter sent to the airmen and the AME.

### ***1.2.3 Atrial Fibrillation***

AFIB was chosen due to its frequency, importance, and its status as an SI condition. In the Aerospace Medical Certification Division (AMCD) pathology system, it has a unique code of 464 that is not shared with other medical conditions. As a medical condition, once established, it almost always remains a lifelong condition in that reoccurrences remain a potential concern. While some will successfully be cardioverted and others will have adequate rate control, the underlying condition remains. In recent years, some cures may be possible with surgery or ablative techniques.

AFIB is now one of the conditions that is part of the AME Assisted Special Issuance (AASI) process of the Office of Aerospace Medicine. The AASI helps to expedite the processing of certain medical conditions previously handled by Regional Flight Surgeons (RFS) or AMCD. Following the granting of an Authorization for SI of a Medical Certificate by RFS or AMCD, the AASI process allows the Examiner to reissue an airman medical certificate. As of September 7<sup>th</sup>, 2004, this authority applies to all medical classes, provided the applicant meets the specific certification decision-making criteria and is otherwise qualified.

Regarding the AFIB condition, the FAA staff physicians provide the initial certification decision and grant the Authorization in accordance with part 67 (14 CFR § 67.401).<sup>3</sup> The Authorization letter is accompanied by the information treating physician(s) must provide for the reissuance determination. If this is a first time issuance for the above disease/condition and the airman has all of the requisite medical information necessary for a determination, deferral must be made and all documentation must be submitted to the AMCD or RFS.

Examiners may reissue an airman medical certificate if the applicant provides the following:

- An Authorization granted by the FAA
- A summary of the applicant's medical condition since the last FAA medical examination, including a statement regarding any further episodes of atrial fibrillation
- The name and dosage of medication(s) used for treatment and/or prevention with comment regarding side effects
- A report of a current 24-hour Holter Monitor performed within last 90 days

The Examiner should defer to the AMCD or Region in the following cases:

- There is a recurrent episode of atrial fibrillation
- The applicant develops chronic atrial fibrillation
- The applicant is placed on anticoagulation therapy

#### ***1.2.3.1 Atrial fibrillation aspects.***

Fibrillation of the two atria leads to incomplete emptying with stagnant blood flow, thus leading to blood clots lodging in the atria. If a piece of a blood clot in the left atria leaves the heart and becomes lodged in a cerebral artery, an embolic event such as a transient ischemic attack (TIA), reversible ischemic neurological deficit (RIND), stroke-in-evolution, or a completed stroke can result. About 15 percent of strokes occur in people with AFIB.

AFIB in the US general population is predicted to become as common as one in four as the number of people older than 65 rapidly increases. According to the American Heart Foundation, AFIB is a disorder found in about 2.2 million Americans. The likelihood of developing AFIB increases with age. AFIB is



present in about 1% of the general population under the age of 60 years, 2% of the population in their 60s, 5% in their 70s, and 10% of persons in their 80s.<sup>1</sup>

#### *1.2.3.2 Pathophysiology*

Multiple re-entrant waveforms within the atria bombard the atrioventricular (AV) node, which becomes relatively refractive to conduction due to the frequency of upstream electrical activity. AFIB occurs in three distinct clinical circumstances:

- As a primary arrhythmia in the absence of identifiable structural heart disease
- As a secondary arrhythmia in the absence of structural heart disease, but in the presence of a systemic abnormality that predisposes the individual to the arrhythmia
- As a secondary arrhythmia associated with cardiac disease that affects the atria

#### *1.2.3.3 Mortality/Morbidity*

Much of the morbidity and the mortality resulting from AFIB is due to stroke. The risk of stroke is not due solely to AFIB; it increases substantially in the presence of other cardiovascular disease. The attributable risk of stroke from AFIB is estimated to be 1.5% for those aged 50-59 years, and it approaches 30% for those aged 80-89 years.<sup>9</sup>

AFIB complicates acute myocardial infarction (AMI) in 5-10% of cases. The causes of AFIB in AMI are thought to be due to any number of factors, such as atrial infarction, atrial ischemic injury, atrial distension, or, perhaps, pericarditis. According to Rathore et al., patients who developed new-onset AFIB during the course of myocardial infarction (MI) were at higher risk than patients who presented with chronic AFIB.<sup>8</sup> Patients with AMI and AFIB tend to be older, less healthy, and have poorer outcomes during hospitalization and after discharge than individuals without AFIB. AFIB is independently associated with an increased mortality rate.

#### *1.2.3.4 Age and Gender*

The absolute number of men and women with AFIB is just about equal.<sup>6</sup> The incidence in persons aged 55-64 years is 3 out of 1000 new cases per year. The incidence in persons older than 85 years is 35 out of a 1000 new cases a year.<sup>4</sup>

#### *1.2.3.5 Treatment*

In treating AFIB, the attainment and maintenance of sinus rhythm has been the main therapeutic goal. This treatment goal is not achieved in many patients, as AFIB reoccurs, and there are side effects of rhythm control drugs to take into account. In recent years, randomized clinical trials have shown no difference between rate control and rhythm control with respect to some measures of morbidity and mortality, although there may have been a non-significant trend toward increased survival in patients with the rate-control group. There has not, at this time, been an aeromedical determination as to whether this therapeutic equivalence remains relevant for pilots and other aircrew members. Aviation and space medical certification decisions can be difficult to make and are almost always subject to change over time. As the medical knowledge of the natural history of disease processes becomes more detailed and the understanding of the effect of therapies on disease course improves, the cognitive effects upon aircrew of disease and treatment become better characterized.

According to a recent review by the Treatment Guidelines from The Medical Letter, treatment approaches to AFIB include anticoagulation, ventricular rate control, and drug therapy to maintain sinus rhythm.<sup>2</sup> In minimally symptomatic elderly patients, aggressive attempts to maintain sinus rhythm have not decreased mortality or prevented thrombotic complications.

In highly symptomatic patients, maintenance of sinus rhythm with drugs probably remains the approach of first choice. Sotalol and amiodarone are often preferred; amiodarone appears to be superior to sotalol for this indication. Recurrences of AFIB have also been decreased by drugs not usually classified as primary antiarrhythmics, including ACE inhibitors, angiotensin receptor blockers, and statins. Radiofrequency (RF) catheter ablation can also be effective for AFIB but carries higher risks than RF procedures for other arrhythmias; serious complications include stroke, cardiac tamponade, and injury to the esophagus. Twelve RF ablation is more successful (and safer) in isolated atrial flutter than in AFIB, although in other respects this arrhythmia is managed like AFIB.

This section highlights the difficulty of making aerospace medical certification/fitness-to-fly decisions. Evidence based medical decisions arising from adequate studies of the condition are needed to help guide such fitness-to-fly decisions, especially in the challenging environment of aviation and space. This study aimed to provide some objective measures of atrial fibrillation among pilots and provide information to aeromedical certification authorities.

## **2.0 METHODS**

A dataset to study AFIB was developed utilizing a Scientific Information System (SIS), which allowed the study of all active airmen over time. The SIS, a longitudinal dataset consisting only of active airmen, was constructed from 1993-2005 in accordance with Peterman et al.<sup>7</sup> There were 19.3 million rows and 74 columns in the SIS dataset, which included all people who were issued a medical certificate.

Later in the analysis, data from the airmen registry was linked to the records in the SIS. We also excluded foreign pilots who held FAA medical certifications. What follows is a categorization of our main datasets, their inherent advantages and disadvantages, side effects of the tracking algorithms, and data quality issues that are associated with each set of data.

### **2.1. Sources of Data for SIS**

#### ***2.1.1 Document Imaging Workflow System***

In 1999, the Document Imaging Workflow System (DIWS) became operational at the Civil Aerospace Medical Institute (CAMI). Within it are the electronic medical records of 3 million pilots and 12 million medical certification physical exams. AMEs perform the required examinations governed by 14 CFR Part 67 using the medical certificate application Form 8500-8 and transmit the results by Internet to the DIWS at CAMI. Some test results and examinations are mailed to CAMI for processing into the DIWS using scanners. Some 2,000 medical certification applications are received each day.

#### ***2.1.2 Aviation Accident and Medical Database–Decision Support System (AAMD–DSS) Warehouse***

The Aviation Accident and Medical Database –Decision Support System (AAMD–DSS) warehouse was established at CAMI to consolidate various sources of aviation safety and aeromedical certification data to enhance research. Included in the warehouse are clones of the National Transportation Safety Board (NTSB) aviation database, the FAA Accident and Incident Data System (AIDS), the Airmen

registry, and several specialized aviation safety databases developed at CAMI in the Aerospace Medical Research Division.

In parsing all the available electronic records of applications for medical certification exams, the first record for any given pilot that contained the AMCD Pathology code for AFIB (fibrillation, auricular in the AMCD coding handbook) of 464 was identified. Since there was no way in the electronic record to ensure that the pilot did not in fact have AFIB prior to the first record with the path code assignment, there is room for error in this count. Every record subsequent to the first record with the 464 path code for AFIB was assumed to be AFIB and assigned to the AFIB group since the condition is almost exclusively a lifelong condition.

Only pilots issued with a first-, second-, or third-class medical certificate were included. This final dataset after processing with the active algorithms included 19,325,114 records (1,533,610 distinct applicants) including 32,967 exams that involved AFIB applicants (distinct 6,721 applicants).

In order to model the mishap occurrences using the study variables of interest, the data was filtered for outliers and impossible values such as negative age or flight times. Age was restricted to values greater than 15 years and less than 115 years; the lower values were based upon inspection and selected due to the fact that one cannot solo an aircraft until attaining at least age 16. Prior to age 16, one cannot be the pilot-in-command (PIC) of the flight; there must be a certified flight instructor or another certified pilot on board to conduct the flight. Pilots reported their occupation and ratings on their medical applications. However, we used only airmen rating information from the Airmen Registry dataset, which was merged and matched to the SIS dataset. Additionally, only certificate type of pilot records and certificate levels (ratings) of Airline Transport Pilot, Commercial Pilot, Private Pilot, Recreational Pilot, or Student Pilot were used.

### ***2.1.3 NTSB Downloadable Dataset***

NTSB aviation mishap investigations can take up to 18 months to proceed from a preliminary, to a factual, and then a final report, each of which is published on the NTSB website. The NTSB report describes the factors involved with each accident and issues a final report with the probable cause of the accident.

## **2.2 Study Variables**

### ***2.2.1 Active***

For each airman in the CAMI AAMD-DSS, in each calendar year of the study including 1993- 2005, the airmen's status with respect to holding a valid medical certificate was determined. The term *Active* implied that an airman held a valid medical certificate during all or part of that year. It is not a measure of how many flight hours of exposure an airman has in any given year but does differentiate pilots who participate to varying degrees in maintaining a valid medical certificate from year to year. In a given year, the date of the most recent medical exam and the class issued for that exam was used to document active status. This entailed examining the medical records for each pilot prior to the year being examined in order to account for cases where the most recent exam for determining active status was in the one to three years prior to the year being examined. In other words, pilots issued in a calendar year were added to pilots from prior years that also had valid medical certificates enabling them to be counted as active pilots in that calendar year. This is similar to the concept of prevalence and incidence. Pilots applying in a given calendar year, who received a valid medical certificate, are obviously active that year, and counting

new certificates issued in that year is similar to an incidence rate. Pilots whose medical was still valid in that year, arising from an exam in a prior year, also contribute to the count of active airmen, similar to prevalence.

Pilots issued a medical certificate in any given year are clearly active pilots. However, pilots who held valid medical certificates from prior years that have not expired, been suspended, revoked, or have not been renewed in the year being tabulated must be included in the annual total of active pilots. The complexities of medical certificate validity period are due to the varying lengths of duration of medical certificates, which depend upon the class of certificate being requested, the age of the applicant, and the fact that the regulations (14 CFR Part 67) governing these validity periods changed in 1996. Time-limited medical certificates may have lesser durations of validity compared to the standard periods for first-, second-, and third-class certificates and are a part of the special issuance process in the Office of Aerospace Medicine.

Using class of medical issued, a two-digit code from Code Schedule A in the AMCD Handbook, *Class* was filtered to class 1 (11-19), class 2 (22-29), and class 3 (31-39) certificates that corresponded to first-, second- and third-class medical certificates, respectively. This method of tabulating pilots with valid medical certificates excluded those who were in a pending or denied status for that year.

Determining the time span of validity of active status for each pilot required calculating the date that a properly issued medical certificate would expire, assuming for the calculation that the applicant does not return for another exam within the time interval. In each calendar year, each pilot's exam records were retrieved to find the most recent (or last) exam record for that calendar year. From the most recent exam record, an expiration date was calculated. Once calculated, the expiration date was stored in association with the exam record that generated this period of validity. This also allowed the calculation of a *Months Contributed* variable for each pilot in each year. The *Months Contributed* field contains the value for the months that a certified applicant held a valid medical certificate for that year (sec. 2.2.3). If, in a subsequent year, a pilot undertook another medical certificate application exam and was issued another certificate, then the latest expiration date is calculated and associated with the latest exam. The prior year was retrieved to enable an accurate, objective determination of how many months in each calendar year the airmen held a valid certificate. For instance, if an airman's medical certificate application exam occurred in June of 2003, then the exam expiration date information from 2002 was required to determine if, for the months January through May of 2003, the pilot held a valid medical certificate or not. In this manner, both continuous and periodic participation of pilots in the system was documented. Thus, the algorithm found and processed records and determined active status for all possible combinations of airmen behaviors.

### **2.2.2 AFIB**

Airmen diagnosed with AFIB were identified by the 464 pathology code in the AAMD-DSS. If airmen did not have the 464 pathology code they were considered non-AFIB airmen. In this study we looked for the first occurrence of the AFIB path code in the pilot's medical record in the period 1990-2003, so prior to having AFIB, a pilot may have participated/contributed to the non-AFIB dataset. After the onset of AFIB, the pilot would only be grouped as AFIB.

### ***2.2.3 Months Contributed***

Being an active pilot in a given year implies that an airman held a valid medical certificate during all or part of that year. For each active pilot in each calendar year, the number of months of contribution as an active pilot was calculated. This is a new measure of exposure that can be objectively calculated from the electronic medical records and is free of the reporting errors that are inherent in the self-reported Total Flight Time hours and Last 6 Month's hours reported on the 8500-8 Medical Certificate Application form. It forms one of the denominators of contribution/exposure that are used in the determination of the mishap rate.

### ***2.2.4 NTSB Mishap***

The warehouse dataset containing active airmen was matched to the NTSB warehouse component to determine which airmen had an NTSB event. There were a total of 26,756 accidents in the NTSB dataset for the study period (1993-2005).

### ***2.2.5 FAA Accident Incident Database System Mishap***

Incident data was retrieved from the FAA's AIDS database system. For both outcome databases, the mishap date must be after the first assignment of the AFIB pathology code (all mishaps were also examined later to ensure that a miscoding of AFIB did not prevent the study from finding a relevant mishap in an AFIB pilot). There were a total of 852 incidents during the study timeframe.

### ***2.2.6 Data Limitations-Mishap Characterization Review***

A detailed review of the 92 mishaps matched from the NTSB involving 88 active, appropriately certificated AFIB pilots was undertaken to supplement the information provided by the warehouse electronic medical and mishap records. The match up between active airmen (including AFIB) and the NTSB component of the warehouse was done to be as inclusive as possible, matching the pilot medical records to the NTSB warehouse component that includes identifying information about individual pilots. This initial match yielded a table where all commercial mishaps that involved multi-crew aircraft were included if one or more crewmembers had AFIB, and in the case of other single or multiple pilot mishaps, any pilot on board had AFIB before the mishap occurrence. It was felt that with such a small number of cases involving AFIB pilots, the cases could be reviewed manually. After the manual review we also compared the AFIB cases to the NTSB sequence of event (SOE) coding to compare the manual and automated determination of human factors mishaps. The number of NTSB events involving AFIB pilots that were due to pilot factors was 68, involving 64 airmen.

The non-AFIB pilot related mishap records could only be inspected using the electronic accident and medical records. A manual review of 27,608 records was not feasible in the manner that we reviewed the 92 AFIB cases to find the 62 cases used in this study.

#### ***2.2.6.1 Mishap Calculations***

Several different denominators were examined to allow comparison of this study's results with other studies. *Total Pilot Population*, *Months Contributed*, *Person-Years*, and *Flight Time Hours* were the denominators employed.

Using the counts of pilots, the proportion of pilots having a mishap were calculated for AFIB and non-AFIB pilots. These proportions were not estimates but rather population parameters, as the entire population was used in their computation.

Similar parameters were calculated using *Months Contributed*, *Person-Years*, *Total Flight Time*, and *Last Six Months* as denominators. *Total Flight Time* and *Last Six Month* hour values required some additional consideration or processing to account for these fields being counted more than once in the aggregate counts due to the method for determining active status. The values in some fields collected in the Form 8500-8 were not updated until the next exam application, which may be as long as three years. For the mishap proportions, a univariate summary method was applied to present all the univariate summaries in one graph for ease of comparison of possible trends.

### 3.0 RESULTS

#### 3.1. Warehouse Dataset

For the period used to generate the active status of applicants, from January 1990 to December 2005, there were 1,533,610 distinct applicants of which 6,721 had AFIB. A count of active airmen by year revealed a substantial drop in the early and mid 1990s, which did not seem correct compared to historical numbers of active pilots (Figure 1). Since an active airman can only be determined from the class issued, it was found that the apparent drop in active airmen and certificates issued for that time period were due to a large number of electronic exam records missing the class issued. Since a legacy record set was available with the missing field, it would appear there was a problem with the loading the historical records into the DSS.

It was possible to rectify the anomaly in the 1990s that we found with our data explorations in the SIS. Some 1.2 million records were restored which, due to the matching process, also resulted in 4,234 additional airmen and 4,245 mishap records being matched to the active airmen data source. Figure 1 shows the results of the successful use of legacy data in restoring the data. This process was described in detail by Peterman et al.<sup>7</sup>

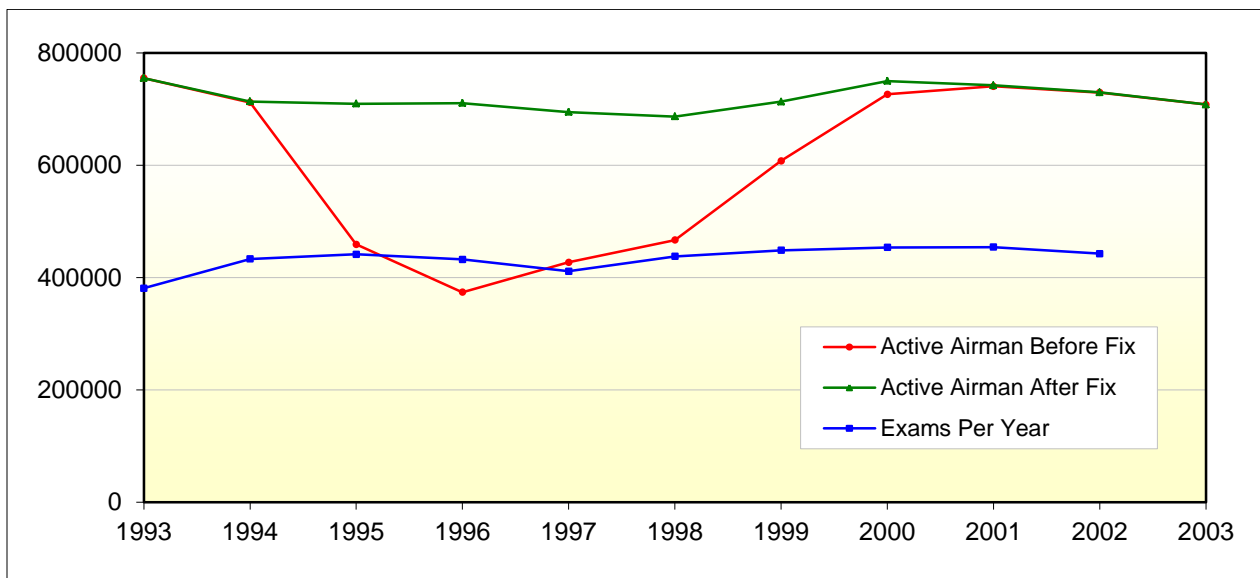

Figure 1. Counts of active airmen after fixing data anomaly.

### 3.2 Counts of Airmen

The counts in Figure 2 give a 25-year overview of the number of exams issued, the issuance of certificates, and the count of active airmen. There are arrow pointers to highlight areas of record anomalies that should receive quality assurance attempts to correct the inaccuracies.

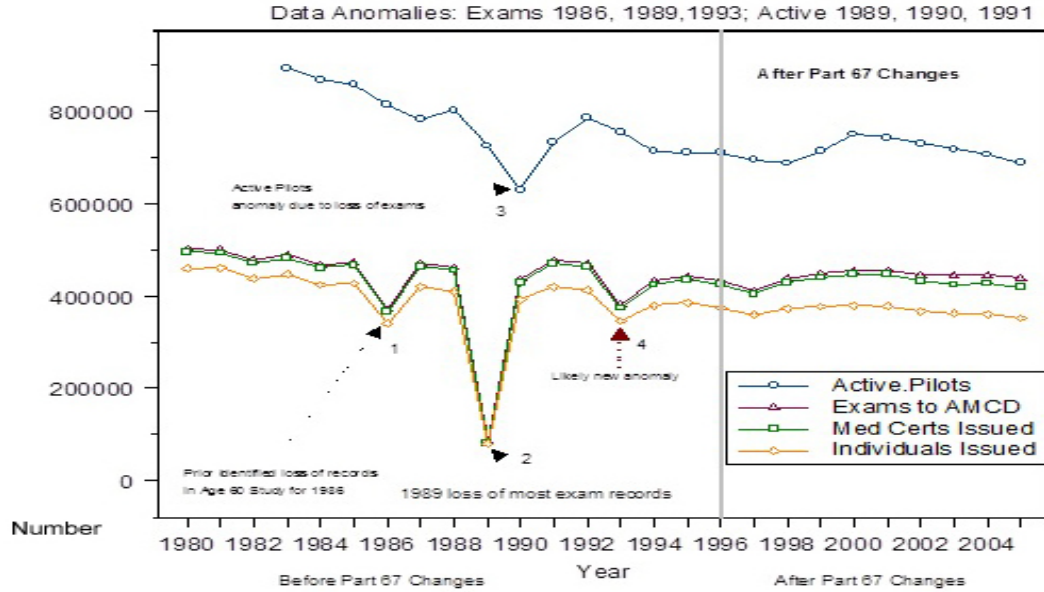

Figure 2. The counts of active pilots, exams, medical certificates, and distinct persons issued.

The counts for the 13-year period covered in this study are highlighted in Figure 3 to illustrate changes caused by the regulatory changes to Part 67 enacted in 1996.

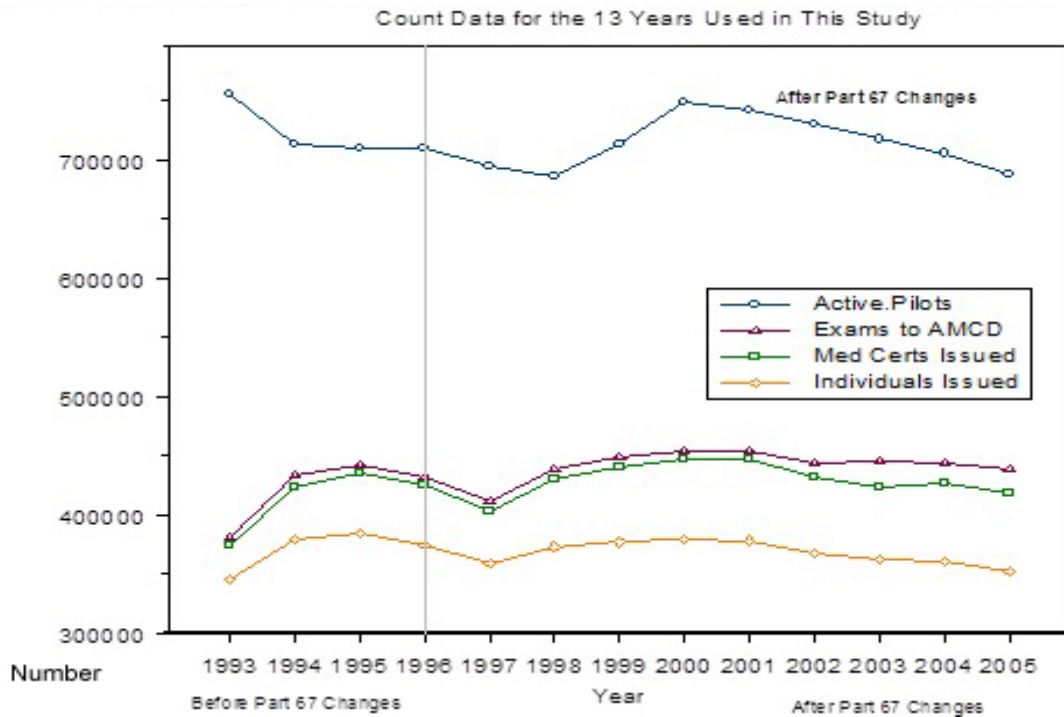

Figure 3. Counts of active, exams, medical certificates and distinct persons issued.

It is important to determine whether a pilot's mishap(s) occurred before developing AFIB. Not all pilots had AFIB at the start of the study. In 1993, there were 5,351 pilots who developed AFIB at various points during the 13-year study period. This represented 79.6% (5,351/6,721) of the AFIB pilots in this study. Thus, some individuals contributed time in both the AFIB and non-AFIB group. No pilot was in both groups for the same set years. In this manner, we accounted for all pilots by including the *Months Contributed* for each individual while a member of each group. We felt they should be counted in each group that they participated in, although their effect on the larger non-AFIB group was quite small. More important was the need to preserve mishaps that might have occurred in this crossover group so as to not confuse a mishap occurrence in a pilot who would eventually sustain a mishap but did not do so while having the diagnosis of AFIB. Ninety-nine percent of all airmen never experienced an AIDS or NTSB event, highlighting the rareness of mishaps as an outcome.

### **3.3 Prevalence and Incidence**

Prevalence is the total number of active airmen with AFIB in any given year. Incidence is the number of medical certificates issued in that calendar year for pilots with AFIB. The time limited nature of the certificates issued under special issuance consideration shows up in the graph of incidence and prevalence, in which the incidence count curve is relatively close to the prevalence or total AFIB certificate count (Figure 4) Unlike other uses of prevalence and incidence, where illnesses that have incidence rates close to prevalence rates indicating illnesses with high mortality rates, this study found that the incidence of AFIB certificates issued was close to the overall prevalence of AFIB indicating a high attrition rate.

The total airmen count was 1,533,610 with 6,721 AFIB pilots and 1,526,889 non-AFIB pilots. There were 5,351 in the non-AFIB group who transitioned to the AFIB group at some point in the study due to their development of AFIB after 1993. The prevalence of AFIB airmen (airmen holding valid certificates issued with the internal processing pathology code of 464) increased from 1,370 in 1993 to 3,774 in 2005.

As a percentage of the entire pilot population, AFIB is less common among active certified pilots than the general population. Out of 1,533,610 total active pilots, 3,774 were AFIB, which was 0.44% of active pilots in 2005 (Figure 4). Our calculation of the overall prevalence of 0.44% compares with 1% in the general population for age ranges 60-68.



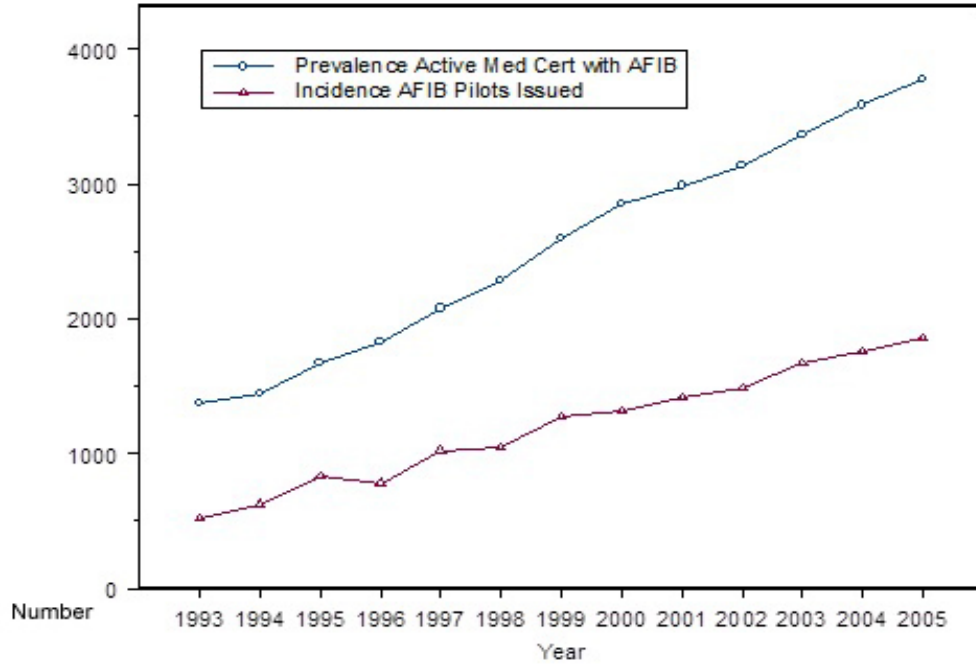

Figure 4. Annual prevalence and incidence of AFIB Pilots.

### 3.4 Age Distributions

The average age of AFIB pilots is compared to those without this condition in Figures 5, 6, and 7.

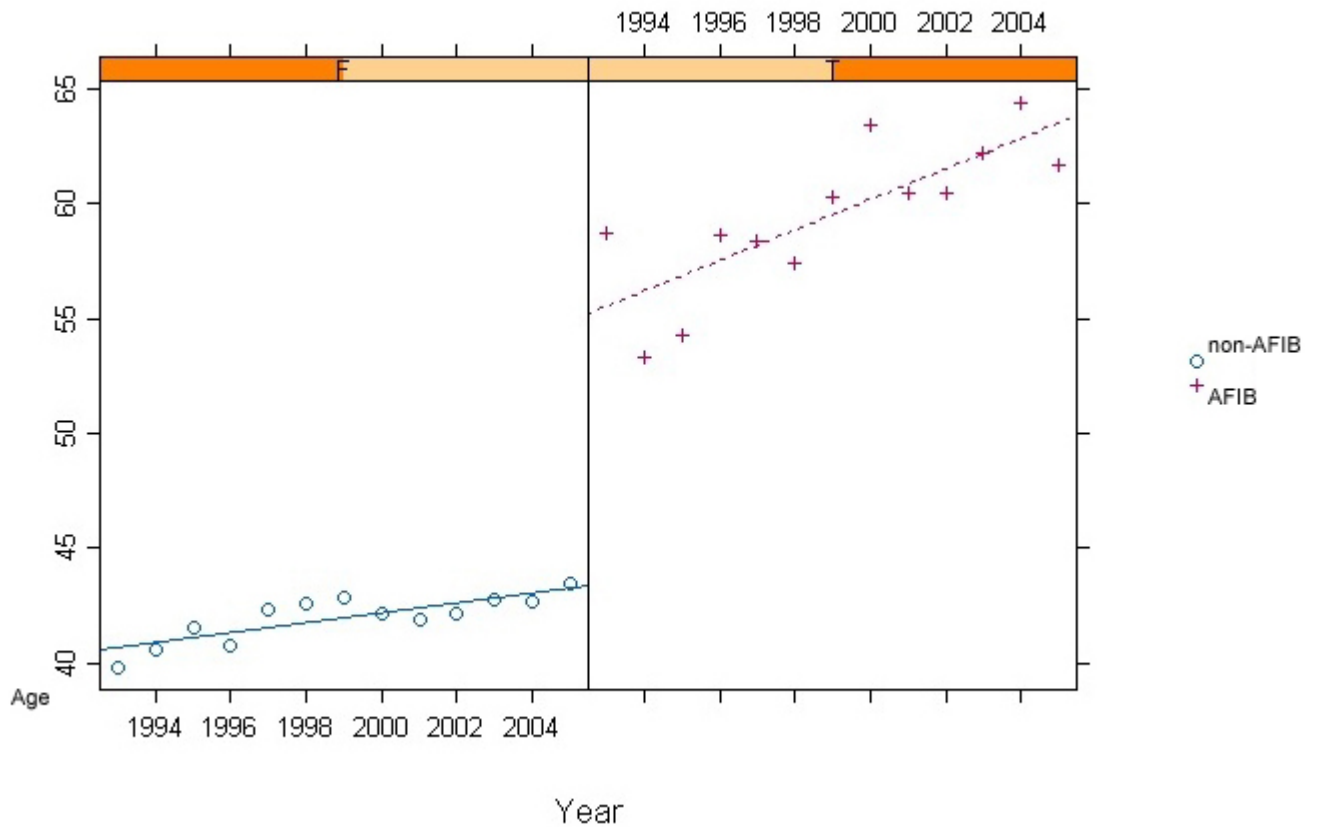

Figure 5. Age distribution – all pilots. Blue and red represents pilots without and with AFIB, respectively.

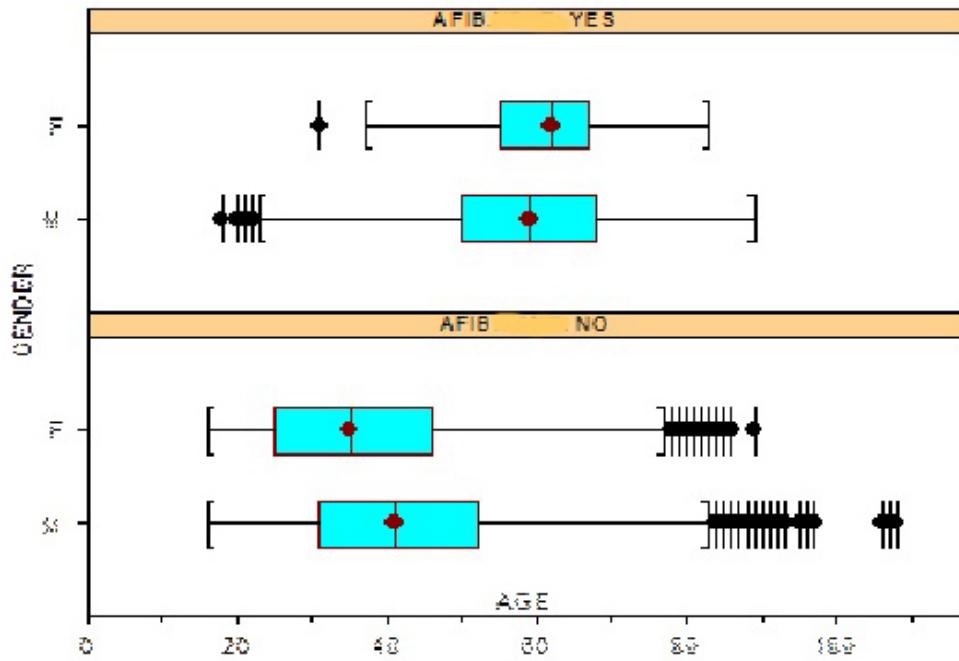

Figure 6. Age of all pilots with and without AFIB 1993-2005 by gender.

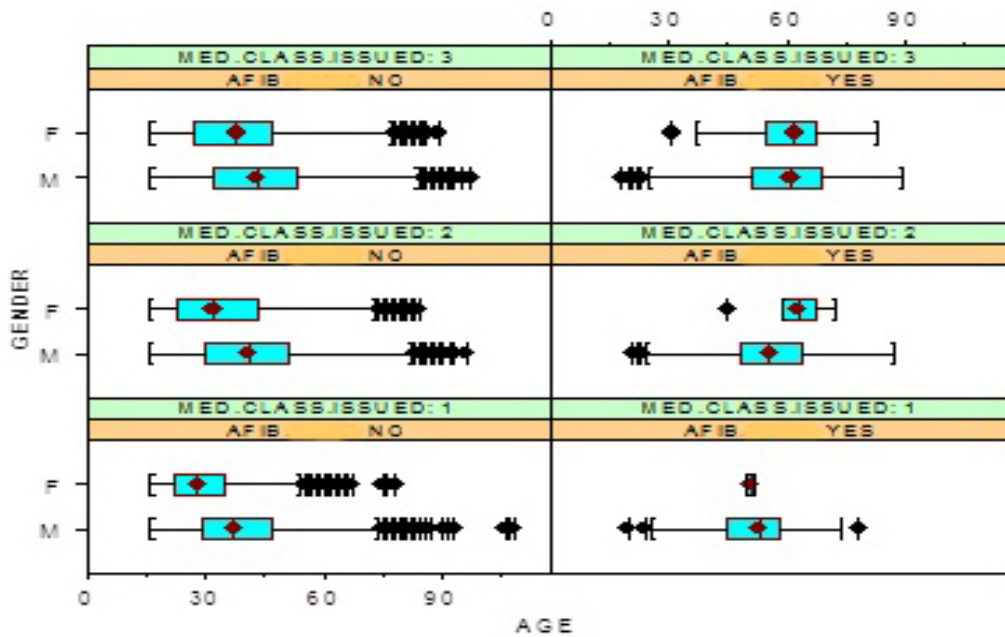

Figure 7. Age by AFIB status, medical class and gender – 1993-2005.

### 3.5 Months Contributed for AFIB and non-AFIB Airmen

The total time contributed in each calendar year was captured in a variable called *Months Contributed* for each airman. The total value for *Months Contributed* accumulated by the 6,721 AFIB certified airmen during 1993-2005 was 351,469 months. The total contribution (*Months Contributed*) by the 1,526,889 non-AFIB certified airmen during 1993-2005 was 96,979,689 months. On average, each airman contributed 47.11 months in the 13-year study. The maximum potential contribution for any individual was 156 months (12 x 13). The minimum observed was 1 month. The data were not normally distributed, thus the median is a better method of comparing the groups.

Comparing the box plots of the individual totals for *Months Contributed* for AFIB and non-AFIB pilots, it is apparent that there is a difference between the groups with respect to the proportion of pilots that contributed for the full period of time of the study (Figure 8). After about 90 months, the proportion of AFIB pilots diminishes. While the median and the first quartile duration of participation is about the same between the groups, the second to third (50-75%) quartile range and the fourth (100%) quartile is smaller for AFIB pilots. There are more outliers in the 90-132 month range for AFIB pilots. The median *Months Contributed* for both groups was around 39 months.

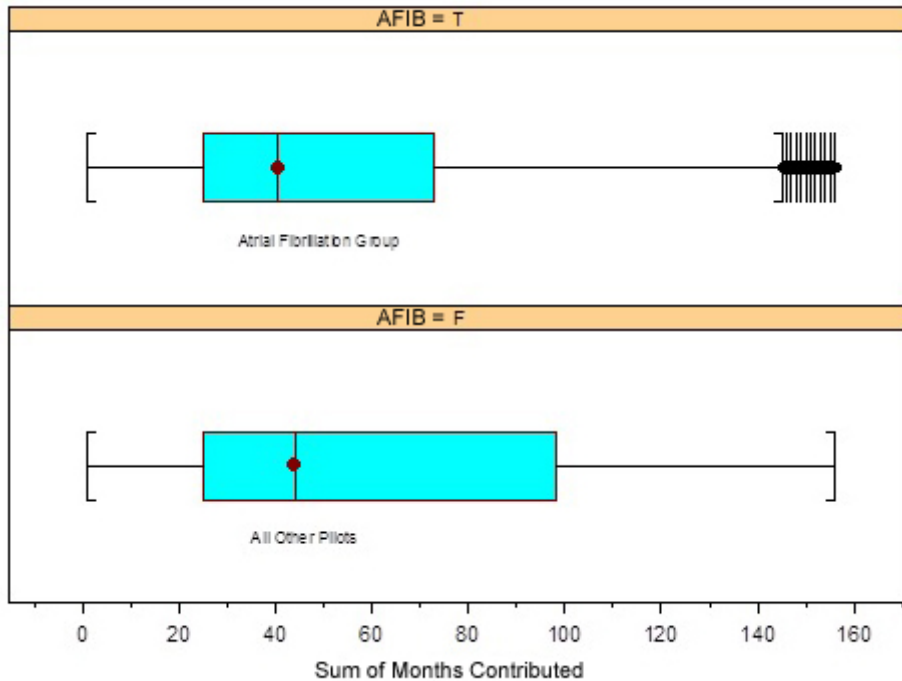

Figure 8. Accumulated *Months Contributed* for AFIB and non-AFIB airmen.

### 3.6 Mishaps

While this study was primarily concerned with those pilots who held a valid medical certificate (active airmen), we also examined NTSB cases that matched to our airmen records in the AAMD-DSS, regardless of active status. Considering the matched group of active airmen, there were few mishaps with 98.9% of all pilots having no mishap in both the NTSB and FAA AIDS datasets. The percentage of all airmen with a mishap (accident or incident) was 1.6% (24,698/1,533,610). There was one pilot who sustained more than one mishap flying agricultural operations (14 CFR 137). This individual was involved in two accidents within several days of each other. All the other multiple mishap pilots are in the non-AFIB group. See Table 1 for the number of mishap frequencies.

Table 1. Numbers of pilots and mishaps.

Number of Mishaps	Count of Pilots
1	22,493
2	964
3	77
4	9
5	2
Total	23,545

#### 3.6.1 Total NTSB Events Available from SIS

There were a total of 24,698 events, with 22,428 accidents and 693 incidents tabulated in the SIS dataset. These numbers represented the maximum number of outcomes available for analysis for the 1993-2005 study period.

During the years of 1993-2005, there were 32,762 distinct AFIB pilots. The total active exams associated with an NTSB event was 24,461 while the total active exams associated with an FAA AIDS event was 42,784.

### 3.7 Characterization of Mishaps

The match up between active airmen (including AFIB) and the NTSB component of the warehouse was done to be as inclusive as possible, matching the pilot medical records to the NTSB warehouse component that included identifying information about individual pilots. This initial match yielded a table where all commercial mishaps that involved multi-crew aircraft were included if one or more crewmembers had AFIB, and in the case of other single or multiple pilot mishaps, any pilot on board had AFIB before the mishap occurrence. It was felt that with such a small number of cases involving AFIB pilots the cases could be reviewed manually.

There were 99 individual airmen that had a total of 107 mishaps before they developed AFIB; none of the mishaps were due to medical impairment or incapacity. Of these 99, only 88 airmen matched to our active airmen dataset due to the medical certification status of some of these airmen. There were two pilots who had two accidents, one before AFIB diagnosis and one afterward.

There were three NTSB events that were matched to active AFIB airmen, however, the accident happened before the AFIB condition but in the same year that they developed AFIB. That left a total of 88 accidents, but one airman had two accidents in the same year, leaving a grand total of 92.

A detailed review of the 92 mishaps matched from the NTSB involving active, appropriately certificated AFIB pilots was undertaken to supplement the information provided by the warehouse electronic medical and mishap records. This original set of 92 mishaps included 30 mishaps where the event was not attributed to pilot action. This resulted in 67.4% of accidents with a human factors (HF) component for AFIB airmen. This review of the narratives and NTSB coding for each case did not reveal any mishap that was due to the underlying medical condition. In fact, there were no medical impairment or medical incapacitation events among properly certified AFIB pilots in the NTSB investigations. The NTSB coding for event type denoted these cases as 60 accidents and 2 incidents.

In the dataset of 62 mishaps, there was one agriculture pilot who had two mishaps within days of each other, leaving 61 distinct pilots in this group. There were 56 cases in General Aviation (14 CFR Part 91), 4 agricultural operations (14 CFR Part 137) involving 3 distinct pilots, 2 commercial (14 CFR Part 135) mishaps, and 1 scheduled air carrier (14 CFR Part 121) operation. Several of the commercial mishaps listed only the co-pilot of the flight, since only the co-pilot had a history of AFIB. The NTSB often did not attribute the sequence of events (SOE, cause or factor) to a specific crewmember; rather, it stated that the aircrew as a unit was involved, in part or wholly, as a cause or factor in the mishap. Usually, there were ground personnel and others involved. Two co-pilots (one Part 121, and one Part 135) and one flight instructor (Part 91) with AFIB were in this series. Only the flight instructor was involved in a pilot-related mishap (DEN03LA043) where the student pilot failed to maintain aircraft control and the NTSB stated there was inadequate supervision by the flight instructor.

*3.7.1 NTSB Events with Human Factors (HF) causes after AFIB Diagnosis*

Of the 62 total events, 60 were recorded by the NTSB as accidents while two were recorded as incidents. This set of cases represented 67.4% of the original 92 cases and were the percentage of cases that were pilot-related, otherwise designated as human factors. Of the 62 total accidents in which human error could not be ruled out by the NTSB, 21% (13/62) were fatal. That is, 79% of accidents did not involve any fatalities. Further breakdown of those accidents showed there were 34 fatalities with 185 injured, eight seriously injured, and twelve suffering minor injuries. The fatalities were almost exclusively in general aviation operations (Part 91), with one fatality in agriculture operations (Part 137). The eight serious and twelve minor injuries were only from Part 91 operation mishaps. Of the uninjured total, 58 were from a Part 121 operation where a miscommunication problem was the probable cause of the mishap shared equally among the flight deck crew, flight service station personnel, and the snow plow driver. In this incident, the aircraft nearly struck a snow plow operation on the active runway (ANC01LA070). Eleven were uninjured in Part 135 operation mishaps, three were uninjured in Part 137 operation mishaps, and 64 in Part 91 operation mishaps (Table 2).

Table 2. AFIB accidents by FAR

AFIB Accidents					
FAR	Fatal	Serious	Minor	None	Total
121	0	0	0	58	58
135	0	0	0	11	11
137	1	0	0	3	4
91	33	8	12	64	117
SUM	34	8	12	136	190

One of the Part 91 cases with six fatalities was actively investigated for possible pilot incapacitation, but no evidence was found to support such a conclusion (NTSB Case FTW97FA067). See Figure 9 for the frequencies by year for AFIB airmen accidents and trends.

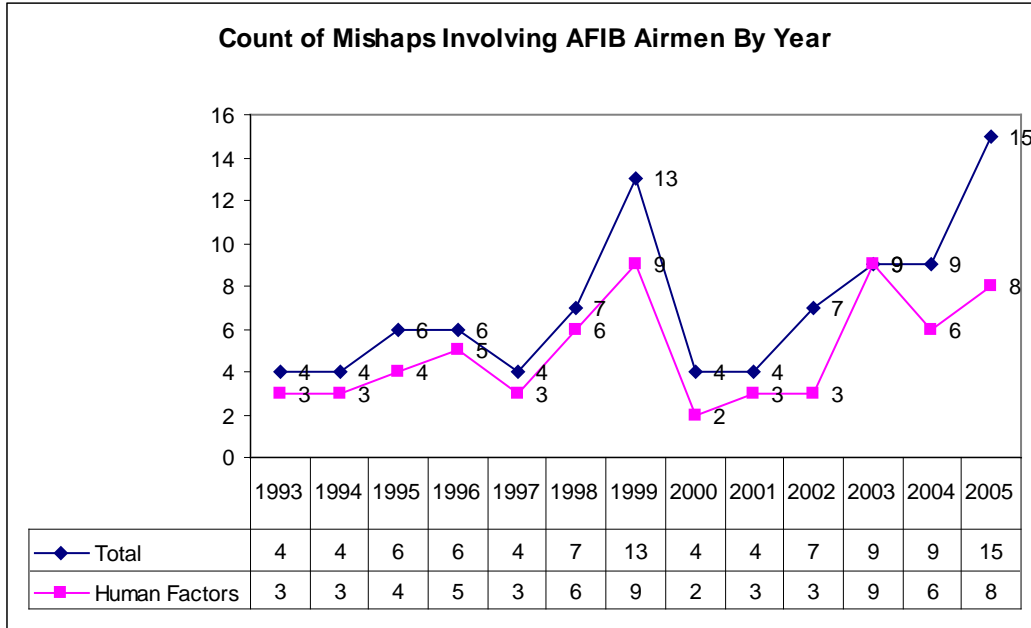

Figure 9. Count of Mishaps involving AFIB airmen by Year.

Figure 9 shows one spike in 1999, however, after 1999, there was a return to the previous levels until 2003 where an annual increase each year is observed.

In the course of the mishap review, we found one case of a properly certified airmen who lost consciousness during an instructional flight. His daughter, the student pilot, could not prevent the impact. The pilot’s AFIB was discovered at the hospital and listed on the discharge summary. The pilot was not known to have AFIB prior to the accident. He did not subsequently apply for another medical certificate (SEA98LA082).

### 3.8 NTSB Events with Human Factors Causes for Non-AFIB Airmen

The non-AFIB pilot related mishaps were inspected using the electronic accident and medical records. The total number of NTSB events matched with non-AFIB active airmen was 22,180 records.

There were a total of 18,035 out of a total of 22,180 accidents by non-AFIB pilots that had HF components.

A manual review of the non-AFIB mishap records to determine the percentage of pilot human factor mishaps was not feasible. We relied on the results of data mining efforts of the NTSB database for this part of the study.

The percentage of HF related accidents was higher than the AFIB pilot group, which had 67.4% HF related mishaps (Table 3).

Table 3. CFR Part, fatalities and injuries for non-AFIB pilots.

<b>FAR</b>	<b>FATAL</b>	<b>SERIOUS</b>	<b>MINOR</b>	<b>UNINJURED</b>
91	13,681	4,521	6,569	22,849
103	6	0.00	0.00	2
121	121	193	630	29,876
125	0	0	2	13
129	0	8	6	1,173
133	27	19	48	44
135	1,289	367	619	2,340
137	196	112	192	537
ARMF*	0	2	1	0
PUBU†	104	52	46	197

\*Armed forces aircraft

†Public use aircraft

These cases illustrated the utility of having an Aeromedical review of the pilot conditions to help manage the risk of pilot in-flight incapacitation. None of the properly certified AFIB pilots had a mishap due to their underlying medical condition, and in fact, none had an incapacitation or impairment of any kind. The causes for their mishaps were essentially no different from other pilots. As will be discussed further in the study, the mishap rate for AFIB pilots is lower than all other non-AFIB pilots.

### 3.9 NTSB Case Reviews and Incapacitations

There were two cases of a hidden medical history of AFIB that led directly to an accident. A review of the NTSB accident reports, without regard to active medical certification status, revealed two cases of pilot incapacitation due to AFIB. One case was fatal (CHI02FA172) and the other a non-fatal accident (FTW00LA222). These two incapacitations occurred among pilots with undisclosed cardiac conditions. In these instances, the pilots had not given AMCD full disclosure of their condition. In the 2002 fatal case, incapacitation of the pilot was the probable cause, while false information provided by the pilot and AME on the medical application was a contributing factor. It was subsequently revealed that the pilot had a history of myocardial infarction, ventricular aneurysm, severe coronary artery disease (CAD), repeat angioplasty, congestive heart failure, coronary artery bypass grafting (CABG), atrial fibrillation, diabetes, and hypertension. The pilot had a medical certificate that expired January 31, 1999, and the accident occurred February 20, 1999. His most recent exam was from February 1999 and was under review at the time of the accident. His antiarrhythmic medications and diabetes were unreported.

The non-fatal case occurred in a pilot who had atrial fibrillation with occasions of rapid ventricular response. She did not report several episodes of AFIB, transient loss of vision due to emboli, or the use of anticoagulants. The pilot was non-compliant with the use of anticoagulants and remained so even after the accident. While in the hospital, she had intermittent AFIB with rapid ventricular response according to emergency room records.

CAMI tracks in-flight pilot incapacitations, particularly those of commercial pilots, and maintains a record of such occurrences. A review of the CAMI Pilot Incapacitation database for the time period of this study resulted in two incapacitation cases due to AFIB. In one an incident, an AFIB airline pilot had

medical impairment, and the first officer had to take control after landing while taxiing. Originally, an NTSB preliminary report (MIA96SA181) described the incident, however, the NTSB subsequently removed it. The incident did not lead to any injuries or damage to aircraft or facilities. The Captain had stopped a medication used to control his intermittent AFIB and sustained a transient ischemic event (TIA, RIND), which rendered him impaired during the taxi phase post landing.

In the second case, it was discovered that a first officer with prior known AFIB, on related medications and certified by the FAA AMCD, sustained an in-flight incapacitation due to this condition during a Part 121 operation while diverting as a result of fumes or smell in the cabin in 2005. After appropriate medical follow up, including two catheter ablation attempts, the pilot received his first class medical in 2006. This incident is also not in the NTSB or FAA AIDS datasets.

### **3.10 AIDS Dataset Human Factors Numbers**

There were 101 AFIB pilots that matched to FAA AIDS dataset for mishaps. These incidents were categorized as follows: 39 general aviation accidents, 47 general aviation incidents, three air carrier accidents, and 12 air carrier incidents.

We identified two AFIB HF related mishaps. Both were medical incapacitations not related to their underlying medical conditions. One pilot sustained an in-flight bleeding ulcer that necessitated an emergency diversion, and he was transported to the hospital. The other had a brief syncopal episode, likely of vasovagal origin. He became queasy discussing back surgery with another pilot, and while taking his pulse at his neck, pressured both carotid arteries, resulting in a brief loss of consciousness. This flight returned to the departure airport where paramedics met the pilot.

### **3.11 Difference In NTSB Mishap Event Proportions (Non-AFIB – AFIB)**

The difference in proportions of AFIB and non-AFIB pilots who had an NTSB event were plotted by year. The difference in proportions was calculated as non-AFIB–AFIB: thus, positive differences indicate that the AFIB proportion of pilots is less than all other pilots. For non-AFIB and AFIB pilots, the overall percentage of pilot related events was 81.5% and 67.4 %, respectively. The proportion of NTSB events that were due to pilot related actions were less for the AFIB group as compared to the non-AFIB pilot group (Figure 10). Accidents were rare, so the mishap proportions were small, ranging from 1 in a thousand to 5 in a thousand.



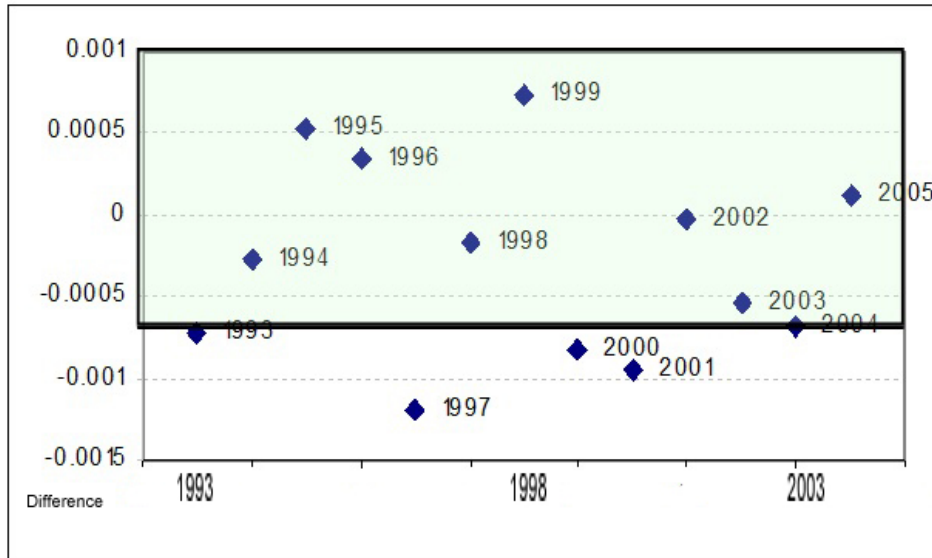

Figure 10. Differences in NTSB event proportions between *non-AFIB* and *AFIB* pilots.

### 3.12 Mishap Rates

The 62 HF NTSB AFIB accidents came from a total number of 6,721 AFIB pilots. This produced a mishap rate of 9.2 per 1000 pilots over the 13-year period of the study.

The 18,035 HF non-AFIB pilot-mishaps from the NTSB matched dataset came from a total number of 1,526,889 other pilots. The non-AFIB pilots had an NTSB based mishap rate of 11.8 per 1000 pilots over the 13-year period.

### 3.13 Summary

In summary, for the 13-year timeframe only 0.37% of all accidents involved a pilot with AFIB. In the group of aviators with AFIB, 62, or 67.4%, were attributed to HF errors. This percentage increased to 81.3% in the non-AFIB group. Of all accidents attributed to an HF error, 0.34% of the pilots had AFIB. Examining all pilots (Accident and non-accident) as a whole in the study period, 0.44% were AFIB pilots.

## 4.0 DISCUSSION

One of the hallmarks of this study was the attempt, wherever possible, to include every relevant data record. This population approach had the advantage of avoiding sampling bias as the entire population was employed. Our approach, in epidemiological terms, is called a historical prospective study. In this type of research, the results of the mishap events and the records from the medical evaluation have already been captured. The investigators follow a group of pilots by studying their electronic records over the time period that they were collected. The investigators are blinded to the outcomes of the study group, and in our methodology there were no problems due to cohort selection, control group selection, or any of the usual retrospective study designs.

No properly certified and active AFIB pilots had an accident due to medical causes, and specifically, none had an event due to AFIB according to the NTSB investigations. Two properly certified pilots sustained incapacitations during commercial operations, but neither case led to injury or aircraft damage and can no longer be found in the NTSB dataset. These two cases were recorded in the CAMI

Incapacitation dataset. In both cases, the pilots were known to have AFIB and were properly certified. In one case, the pilot, a Captain, had stopped his medications without consulting a physician or medical certification authorities and sustained a neurological impairment/incapacitation due to an emboli arising from his AFIB. The first officer handled the event on the taxiway. The second such incident arose from an inflight emergency due to fumes in the cabin; during a diversion to landing, the first officer became incapacitated in descent. The Captain handled the event in flight without consequence. The first officer has regained his medical certificate after ablation treatment of his AFIB condition.

One properly certified 69-year-old pilot had an inflight medical incapacitation due to AFIB. The AFIB was diagnosed after transportation to the hospital. In this case, the certified flight instructor was instructing his daughter as a student. He lost consciousness due to AFIB and was seriously injured in the accident while his daughter sustained only minor injuries. He did not apply for another medical certificate (SEA98LA082).

Two pilots withheld information concerning their AFIB condition; one in conjunction or collusion with the AME. These two accidents affected only these two individuals, resulting in one death and one serious injury (FTW00LA222). The pilot who died was the case where the AME participated in the improper medical certification attempts (CHI02FA172). The pilot with serious injuries surrendered her certificate and did not pursue another medical certificate.

From this study, one could see that with respect to AFIB, the group monitored and certified by the FAA Aerospace Medical Certification authorities does much better than the few pilots who hid or failed to disclose their medical history of AFIB. Only one pilot in the 13-year span of the study sustained an unpredictable in-flight medical incapacitation while properly medically certificated to fly.

The proportions of non-AFIB pilots having pilot-related NTSB events were smaller than that of AFIB pilots. This comparison was made using pilot rates. It is worth mentioning in passing that, as we included all pilots in the study, these population proportions were not estimated but are the population parameters, and thus, no statistical testing was required. The smaller proportions that we observed in the AFIB pilots are what make us confident to say that the AFIB pilots are at least as safe, and in fact, may be slightly safer than the non-AFIB group.

Atrial fibrillation pilots as a group are older and getting older at a rate greater than all other pilots. There is not much difference in terms of *Months Contributed* for the entire study period. The percentage of mishaps that were HF related was less (67.4% versus 81.3%) than all other pilots grouped together. AFIB pilots had 0.36% of the NTSB events, while comprising 0.44% of the pilot population during the 13-year time period. In the study period, very few pilots of any group participated by keeping an active medical for the entire study period, indicating there is a great deal of churn among airmen medical certificate applications.

We believe that better denominators of exposure to flight operations are needed to improve the analyses of these issues, particularly in general aviation. We look forward to the FAA attempts to collect more accurate information about the hours of general aviation operations in the near future and will incorporate such denominator data in the SIS.

## 5.0 REFERENCES

1. Acton QA. Cardiac Arrhythmias: new insights for the healthcare professional 2011 edition. Atlanta (GA): ScholarlyEditions; 2012.
2. Drugs for cardiac arrhythmias. *Treat Guidel Med Lett.* 2007; 5(58): 51-58.
3. e-CFR. Electronic Code of Federal Regulations (e-CFR), Title 14: Aeronautics and Space, Part 67- Medical standards and certification, Subpart E-Certification Procedures: §67.401 Alcohol or drugs. [Accessed on 5 May 2016.] Available from: <http://www.ecfr.gov/cgi-bin/text-idx?rgn=div8&node=14:2.0.1.1.5.5.1.1>
4. Falk RH. Atrial fibrillation. *N Engl J Med*, 2001 344(14): 11.
5. Federal Aviation Administration. Guide for aviation medical examiners. [Accessed on 5 May 2016]. Available from: [http://www.faa.gov/about/office\\_org/headquarters\\_offices/avs/offices/aam/ame/guide/](http://www.faa.gov/about/office_org/headquarters_offices/avs/offices/aam/ame/guide/)
6. Feinberg WM, Blackshear JL, Laupacis, A, Kronmal R, Hart RG. Prevalence, age distribution, and gender of patients with atrial eibrillation. *Arch Intern Med.* 1995; 155(5): 469-473.
7. Peterman CL, Rogers PB, Veronneau SJH, Whinnery JE. Development of an aeromedical scientific information system for aviation safety. Washington, DC: U.S. Department of Transportation, Federal Aviation Administration, Office of Aviation Medicine Report; 2008 Jan. Report No.: DOT/FAA/AM-08/1.
8. Rathore SS, Berger AK, Weinfurt KP, Schulman KA, Oetgen WJ, Gersh BJ, et al. Acute myocardial infarction complicated by atrial fibrillation in the elderly: prevalence and outcomes. *Circulation.* 2000; 101: 969-974.
9. Wolf PA., Abbott RD., Kannel WB. Atrial fibrillation as an independent risk factor for stroke: the Framingham study. *Stroke.* 1991; 22: 983-988.