



Hill's Pet Nutrition, Inc. and Subsidiaries
P.O. Box 148
Topeka, Kansas 66601-0148
(785) 354-8523

January 4, 2011

Division of Animal Feeds (HFV-224)
Office of Surveillance and Compliance
Center for Veterinary Medicine
Food and Drug Administration
7519 Standish Place
Rockville, MD 20855

To Whom It May Concern:

In response to FDA's call for participants in a voluntary pilot program on Substances Generally Recognized as Safe Added to Food for Animals¹, Hill's Pet Nutrition, Inc. (Hill's hereafter) is hereby submitting for consideration a GRAS notice claim that the use of α -lipoic acid in dry foods for adult dogs (*i.e.*, at least 1 year old) at levels up to 150 ppm (150 mg/kg food or 0.0150%) is generally recognized as safe (GRAS) by qualified experts, as shown through scientific procedures. α -Lipoic acid is a cellular antioxidant and cofactor of enzymes involved in the metabolism of carbohydrates and amino acids.

To make the GRAS determination, Hill's: (1) compiled information regarding the nature of the substance, specifications, manufacturing, proposed conditions of use, and technical evidence of safety into a comprehensive dossier (GRAS dossier); and (2) sought the opinion of an "Expert Panel" specifically convened for the purpose of reviewing the information therein to determine whether there is a consensus among qualified experts that the use of α -lipoic acid as described entails a reasonable certainty of no harm and is generally recognized as safe.

Attached please find the following in triplicate: (1) the GRAS Exemption Claim; (2) a brief overview (Executive Summary) of the most critical elements within the GRAS dossier and the outcome of the Expert Panel's deliberations; (3) the complete GRAS dossier; and (4) the signed Expert Panel opinion statement. One copy of each of the cited references is also attached. In addition, all data and information that are the basis for this GRAS

¹ Federal Register/Vol. 75, No. 107/Friday, June 4, 2010/Notices, 31800-31803.



determination are available for FDA's review and copying at reasonable times at Hill's Pet Nutrition, Inc., 400 SW 8th Avenue, Topeka, KS 66603, and will be sent to FDA upon request.

Please note that, in addition to Hill's associates, the following individuals from Cantox U.S. Inc., located at 1011 U.S. Highway 22, Suite 200, Bridgewater, NJ 08827, have been authorized by Hill's to engage in discussions about the present GRAS notice:

Contact

Dr. David Bechtel
Dr. Katherine Vega

Telephone

(b) (4)

E-mail

Signature: *Diane Loiselle* Date: *Jan 5, 2011*

Diane Loiselle
Vice President - Safety, Regulatory & Quality
Hill's Pet Nutrition
400 SW 8th Street
Topeka, KS 66603
(785) 368-5364



GRAS EXEMPTION CLAIM

Hill's Pet Nutrition, Inc. (Hill's hereafter) hereby notifies FDA of its determination that α -lipoic acid is exempt from the definition of "food additive" and thus from the premarket approval requirements outlined in section 201(s) of the Federal Food, Drug, and Cosmetic Act because its use in dry foods for adult dogs (*i.e.*, at least 1 year old) at levels up to 150 ppm (150 mg/kg food or 0.0150%) is generally recognized as safe (GRAS) by qualified experts, as shown through scientific procedures. α -Lipoic acid is a cellular antioxidant and cofactor of enzymes involved in the metabolism of carbohydrates and amino acids.

To make this GRAS determination, Hill's: (1) compiled information regarding the nature of the substance, specifications, manufacturing, proposed conditions of use, and technical evidence of safety into a comprehensive dossier (GRAS dossier); and (2) sought the opinion of an "Expert Panel" specifically convened for the purpose of reviewing the information therein to determine whether there is a consensus among qualified experts that the use of α -lipoic acid as described entails a reasonable certainty of no harm and is generally recognized as safe.

All data and information that are the basis for this GRAS determination are available for FDA's review and copying at reasonable times at Hill's Pet Nutrition, Inc., 400 SW 8th Avenue, Topeka, KS 66603, and will be sent to FDA upon request.

Signature: *Diane Loiselle* Date: *Jan 5, 2011*

Diane Loiselle
Vice President - Safety, Regulatory & Quality
Hill's Pet Nutrition
400 SW 8th Street
Topeka, KS 66603
(785) 368-5364

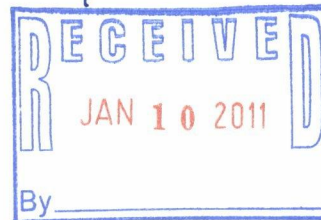

GRAS NOTICE: EXECUTIVE SUMMARY

I. Summary of Data Supporting the Use of α -Lipoic Acid as a Generally Recognized As Safe (GRAS) Ingredient for Canine Foods

A. GRAS Substance Characterization

The α -lipoic acid material Hill's intends to use in canine foods (CAS RN 1077-28-7; *dl*- α -lipoic acid) is a racemic mixture (R- and S-enantiomers) produced in accordance with Good Manufacturing Practice (GMP) standards and within rigid specifications established by Hill's. Figure 1 shows the structure of α -lipoic acid.

Figure 1 Molecular structure of α -lipoic acid

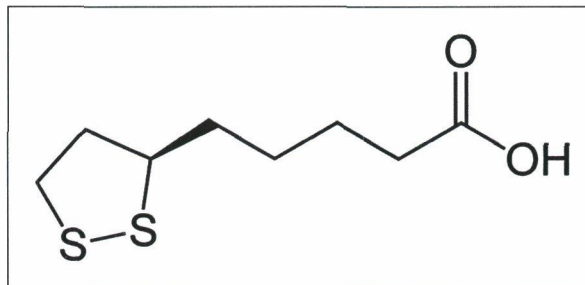

Empirical Formula: $C_8H_{14}O_2S_2$

Molecular Weight: 206.33

Names/Synonyms: *dl*-alpha-lipoic acid; *dl*- α -lipoic acid; lipoic acid; α -LA; ALA; thioctic acid; lipoate; (RS)-1,2-dithiolane-3-pentanoic acid; (RS)-1,2-dithiolane-3-valeric acid; (RS)-thioctic acid

The R-enantiomer of α -lipoic acid is synthesized endogenously by most organisms and is a cofactor that is essential to proper mitochondrial function. When produced commercially, α -lipoic acid generally occurs as a racemic mixture.

B. Proposed Conditions of Use and Estimated Intakes

Reactive oxygen species (ROS) are by-products of cellular respiration with the potential to damage proteins, lipid, and nucleic acids. In order to minimize such damage, aerobic cells have developed multiple antioxidant defenses. However, these defenses have been reported to decline with increasing age in multiple animal species. α -Lipoic acid is a substance synthesized and naturally present in most organisms. It acts as an antioxidant in biological systems, and has been shown to recycle/renew and prolong the lifespan of endogenous mitochondrial antioxidant defenses such as vitamins C and E, and glutathione (GSH).

In the process of eliminating ROS, antioxidants themselves become oxidized and lose their antioxidant function. As Figure 2 illustrates, α -lipoic acid is able to recycle oxidized antioxidants by using reduced coenzymes generated by cytosolic glucose oxidation. This oxidized product is regenerated to its native and functional form *via* the dehydro lipoic acid/lipoic acid redox couple.

In experimental animals, exogenous administration of α -lipoic acid has been shown to help maintain antioxidant defenses^{1,2,3,4,5,6}. In adult dogs, for example, administration of *dl*- α -lipoic acid coextruded in the food at the rates of 150, 1500, 3000, or 4500 ppm (2.5, 26, 53, or 82 mg/kg bw/day, respectively) for 3 months was associated with an increase from baseline in the glutathione (reduced):glutathione (oxidized) (GSH:GSSG) ratio of mononuclear cells, compared to the control. A low GSH:GSSG ratio is considered a marker of oxidative stress.

Figure 2 Schematic overview of the role of α -lipoic acid (LA) in maintaining endogenous antioxidant defenses⁷

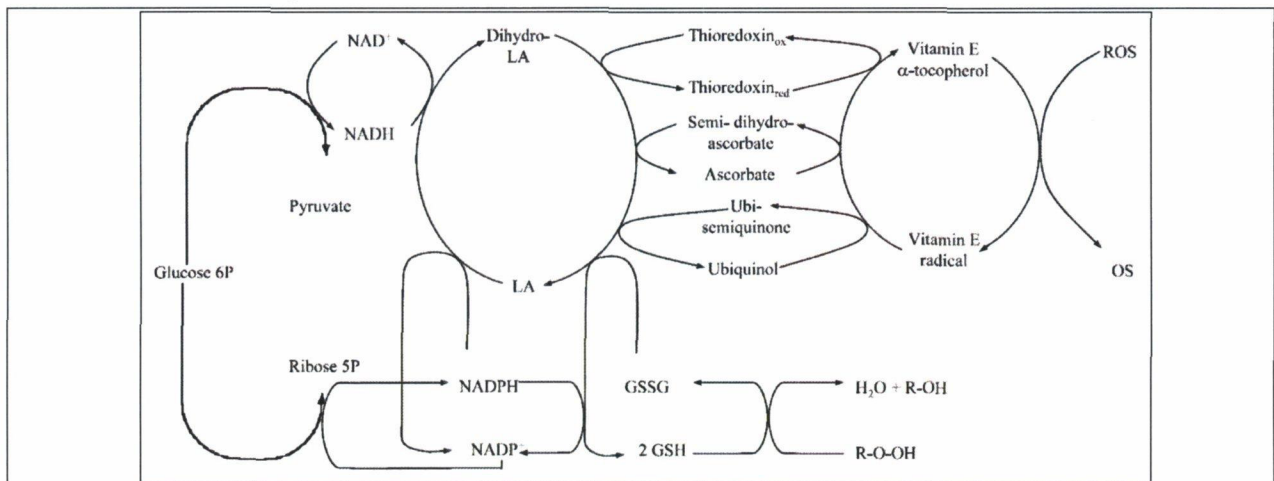

Pivotal role of lipoic acid (LA), which uses reduced coenzymes generated by cytosolic glucose oxidation to recycle oxidized antioxidants. The reaction of an antioxidant (vitamin E, vitamin C, reduced glutathione (GSH)) and a reactive oxygen species (ROS) (or H_2O_2) eliminates ROS (or H_2O_2), but the antioxidant is converted into a product no longer able to function. This oxidized product is regenerated to its native form to function again via the dehydro LA/LA redox couple. OS, oxygen species; GSSG, oxidized glutathione; NAD, nicotinamide adenine dinucleotide (oxidized); NADH, nicotinamide adenine dinucleotide (reduced); NADP, nicotinamide adenine dinucleotide phosphate (oxidized); NADPH, nicotinamide adenine dinucleotide phosphate (reduced).

¹ Arivazhagan *et al.* (2001) Effect of DL- α -lipoic acid on mitochondrial enzymes in aged rats. *Chem Biol Interact* 138:189-198.
² Zicker *et al.* (2002) Safety of long-term feeding of dl- α -lipoic acid and its effect on reduced glutathione:oxidized glutathione ratios in beagles. *Vet Ther* 3(2):167-176.
³ Milgram *et al.* (2004) Long-term treatment with antioxidants and a program of behavioral enrichment reduces age-dependent impairment in discrimination and reversal learning in beagle dogs. *Experimental Gerontology* 39:753-765.
⁴ Milgram *et al.* (2005) Learning ability in aged beagle dogs is preserved by behavioral enrichment and dietary fortification: a two-year longitudinal study. *Neurobiol Aging* 26(1):77-90.
⁵ Milgram *et al.* (2007) Acetyl-L-carnitine and α -lipoic acid supplementation of aged beagle dogs improved learning in two landmark discrimination tests. *FASEB J* 21:3756-3762.
⁶ Liu *et al.* (2002) Memory loss in old rats is associated with brain mitochondrial decay and RNA/DNA oxidation: partial reversal by feeding acetyl-L-carnitine and/or R-alpha-lipoic acid. *Proc Natl Acad Sci USA* 99(4):2356-2361.
⁷ Source: Díaz-Cruz *et al.* (2003) Prophylactic action of lipoic acid on oxidative stress and growth performance in broilers at risk of developing ascites syndrome. *Avian Pathology* 32(6):645-653.

In addition to being an effective antioxidant, α -lipoic acid is a cofactor central to the activity of pyruvate dehydrogenase (PDH) and α -ketoglutarate dehydrogenase (KGDH), mitochondrial enzyme complexes involved in the citric acid cycle (tricarboxylic acid or TCA cycle) for intermediary metabolism of carbohydrates and amino acids. In these enzyme complexes, α -lipoic acid is bound to a specific lysine residue of a target protein and acts as a tether to move intermediates along enzyme active sites. Target proteins include: the E₂ subunit of each PDH and KGDH; the H-protein of the glycine cleavage system; and the branched-chain keto acid dehydrogenase.

The metabolic pathways that require α -lipoic acid are shown schematically in Figures 3, 4, and 5. These pathways generate energy *via* oxidation of carbohydrates and fatty acids, and are highly conserved across species. Genes encoding citric acid cycle components, for example, show a high degree of homology; the nucleotide sequence for the E₂ subunit of PDH in dogs, chimpanzees, and cows is more than 90% similar to that of humans⁸.

⁸ Source: Orthologs for pyruvate dehydrogenase complex component E₂ (dihydrolipoamide S-acetyltransferase or DLAT) gene obtained through *The GeneCards Human Gene Database*, accessed online through <http://www.genecards.org> in September, 2010.

Figure 3 Schematic overview of α -lipoic acid's function (bound to E₂ subunit of PDH and KGDH) in the citric acid cycle⁹

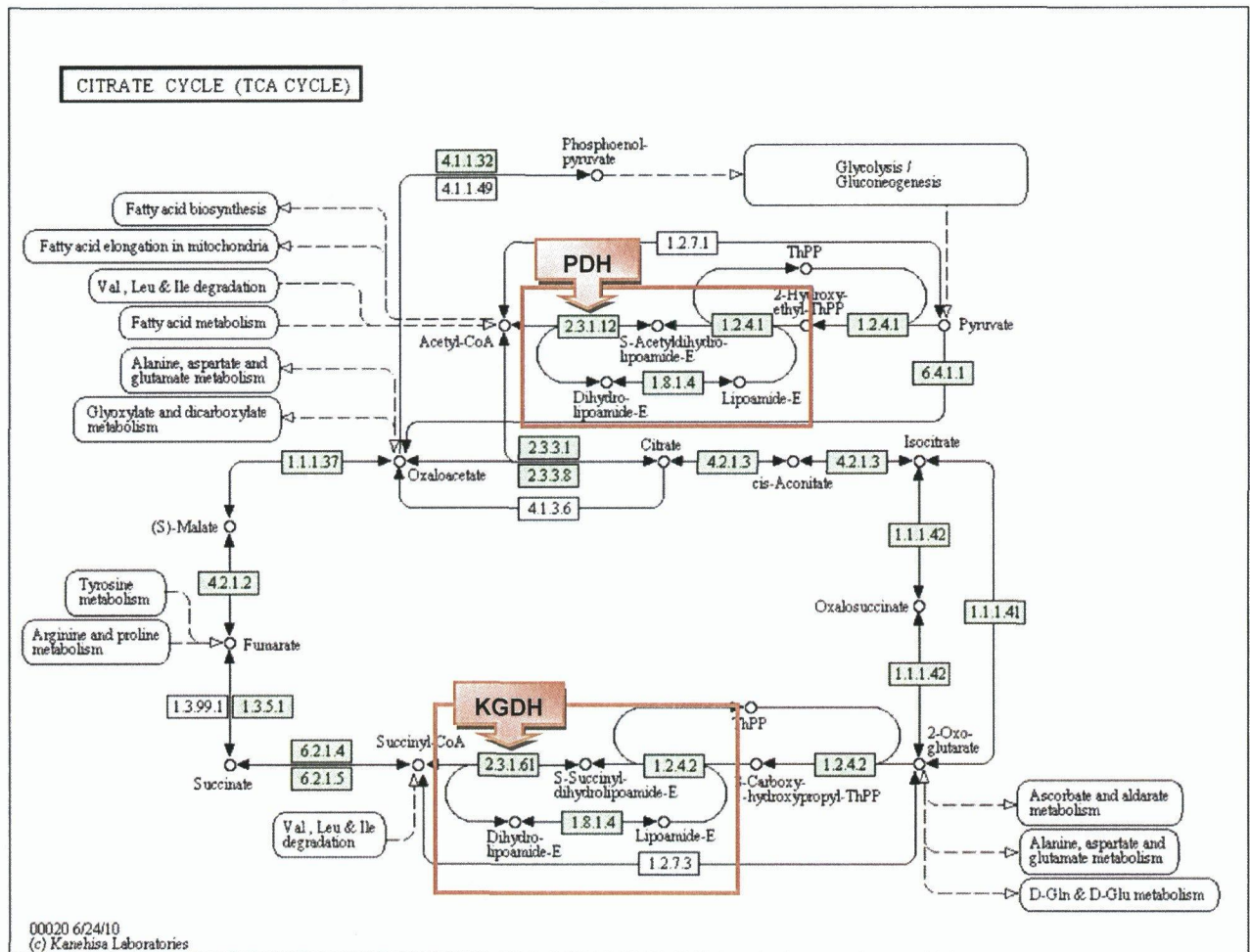

The citrate cycle (TCA cycle, Krebs cycle) is an important aerobic pathway for the final steps of the oxidation of carbohydrates and fatty acids. The cycle starts with acetyl-CoA, the activated form of acetate, derived from glycolysis and pyruvate oxidation for carbohydrates and from beta oxidation of fatty acids. The two-carbon acetyl group in acetyl-CoA is transferred to the four-carbon compound of oxaloacetate to form the six-carbon compound of citrate. In a series of reactions two carbons in citrate are oxidized to CO₂ and the reaction pathway supplies NADH for use in the oxidative phosphorylation and other metabolic processes. The pathway also supplies important precursor metabolites including 2-oxoglutarate. At the end of the cycle the remaining four-carbon part is transformed back to oxaloacetate. According to the genome sequence data, many organisms seem to lack genes for the full cycle, but contain genes for specific segments.

⁹ Source: Kyoto Encyclopedia of Genes and Genomes (KEGG), pathway for *Canis familiaris* (dog) obtained in September-October, 2010 through KEGG PATHWAY Database (<http://www.genome.jp/kegg>).

Figure 4 Schematic overview of α -lipoic acid's function (bound to the H protein of the glycine cleavage system) in the catabolism of glycine, serine, and threonine¹⁰

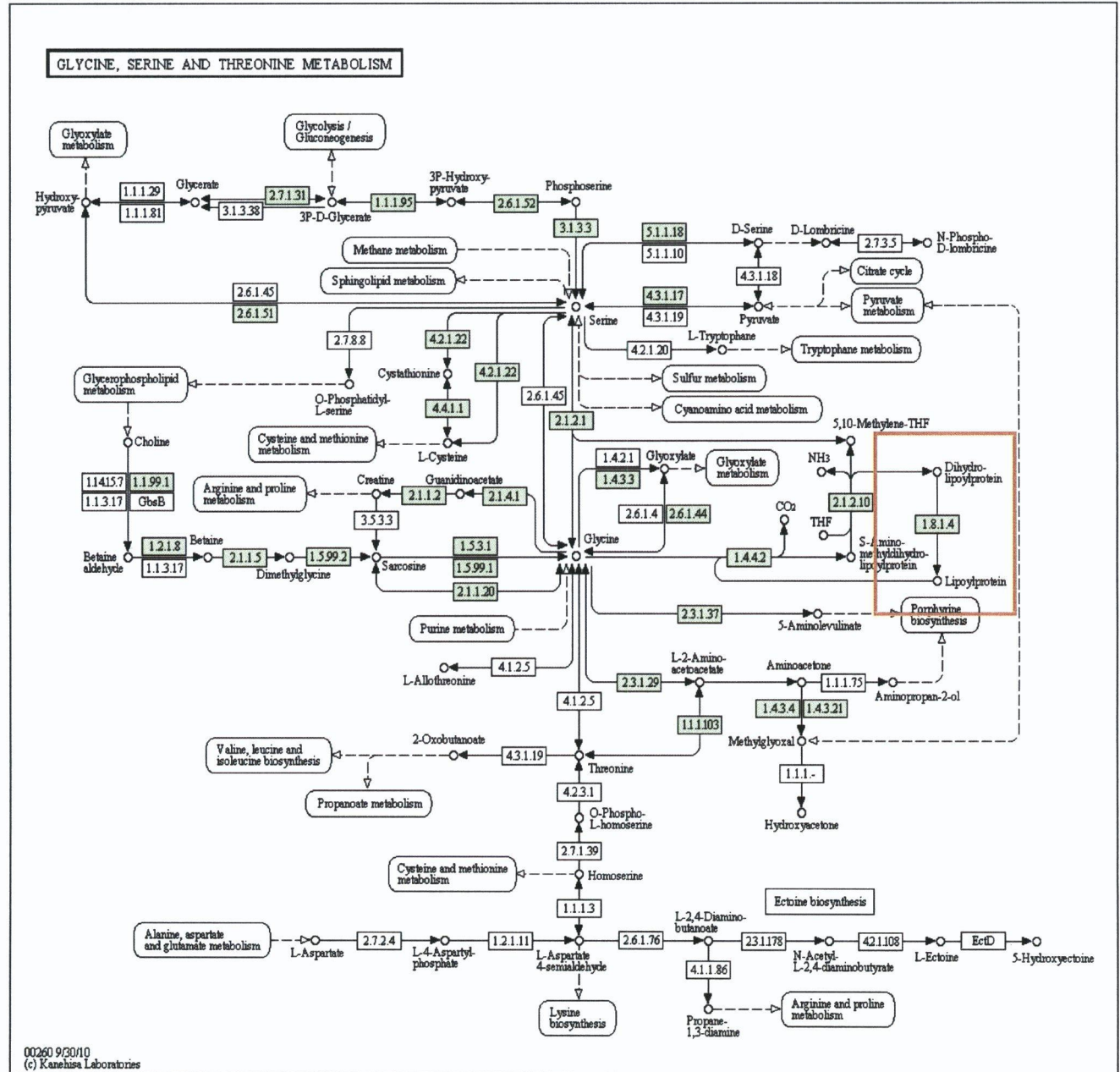

¹⁰ Source: Kyoto Encyclopedia of Genes and Genomes (KEGG), pathway for *Canis familiaris* (dog) obtained in September-October, 2010 through KEGG PATHWAY Database (<http://www.genome.jp/kegg>).

Figure 5 Schematic overview of α -lipoic acid's function (bound to branched-chain keto acid dehydrogenase) in the catabolism of branched-chain amino acids¹¹

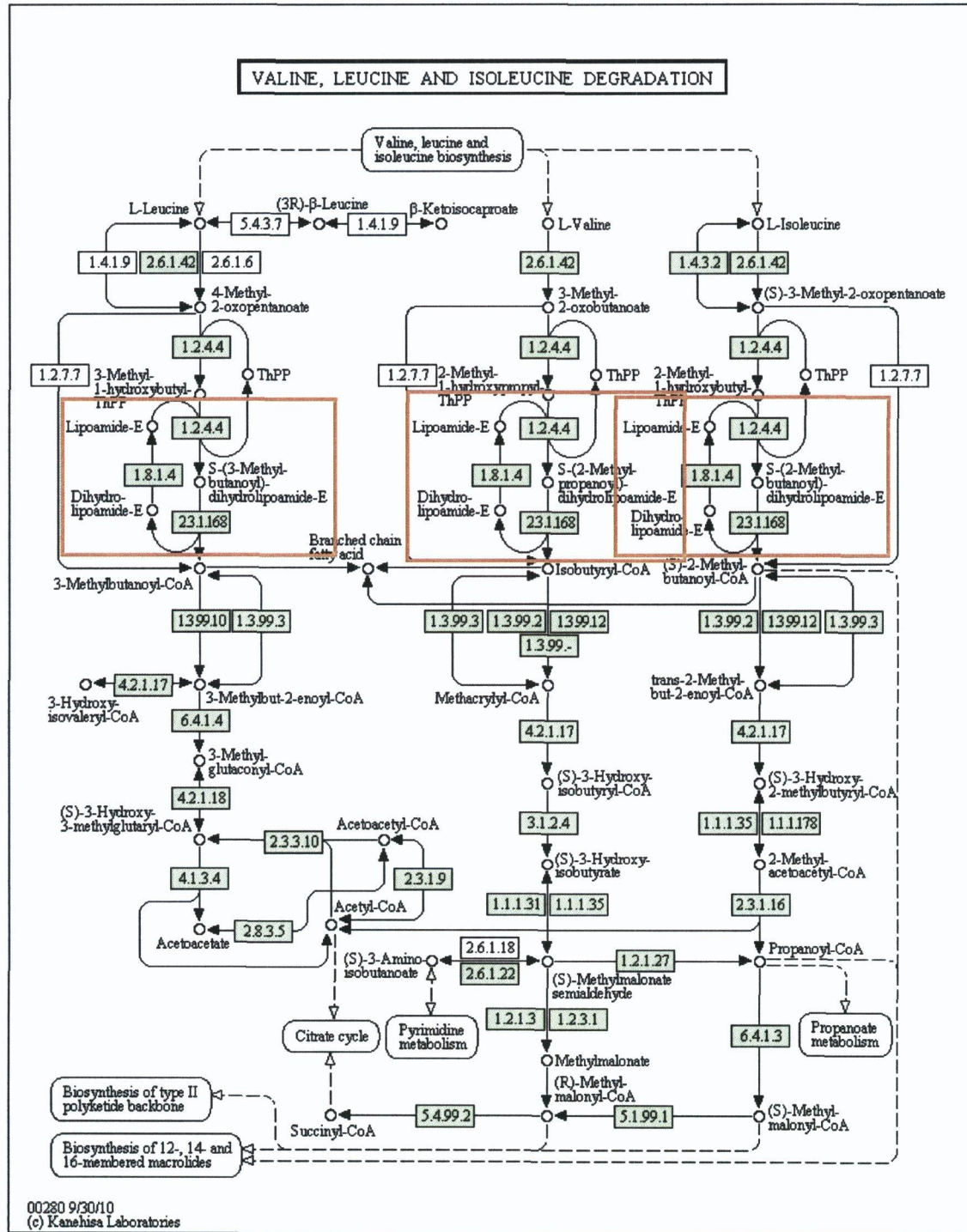

¹¹ Source: Kyoto Encyclopedia of Genes and Genomes (KEGG), pathway for *Canis familiaris* (dog) obtained in September-October, 2010 through KEGG PATHWAY Database (<http://www.genome.jp/kegg>)

In general, most healthy organisms are able to synthesize sufficient amounts of α -lipoic acid to meet the usual requirements and can also obtain small amounts from the diet. However, supplemental amounts may help maintain optimal mitochondrial function, which is known to decline with increasing age, is subject to oxidative stress, and affects not only cellular metabolism and bioenergetics, but also cell differentiation, cell death, and various other processes.

Hill's intends to use α -lipoic acid in dry foods for adult dogs (i.e., at least 1 year old) at levels up to 150 ppm (150 mg/kg food or 0.0150%). As Figure 6 illustrates, exposure estimates indicate that small dogs would have the highest α -lipoic acid intake on a per kg body weight basis. For a dog weighing 2.3 kg that consumes about 0.059 kg food per day, the exposure to α -lipoic acid would be 3.8 mg/kg bw/day. For an average, medium-sized dog weighing 18 kg and consuming 0.281 kg/day of food, α -lipoic acid exposure would be approximately 2.3 mg/kg bw/day, comparable to intakes from a dietary inclusion rate of 150 ppm used in a 1-year dog safety study (2.5 mg α -lipoic acid/kg bw/day). Exposure among large breed dogs would be lower (e.g., 1.8 mg/kg bw/day in a 45.4-kg dog). However, when exposure was considered on the basis of 100 kcal consumed, exposure across breed sizes did not vary greatly.

Figure 6 Critical endpoints and estimated exposures to α -lipoic acid in target and non-target species

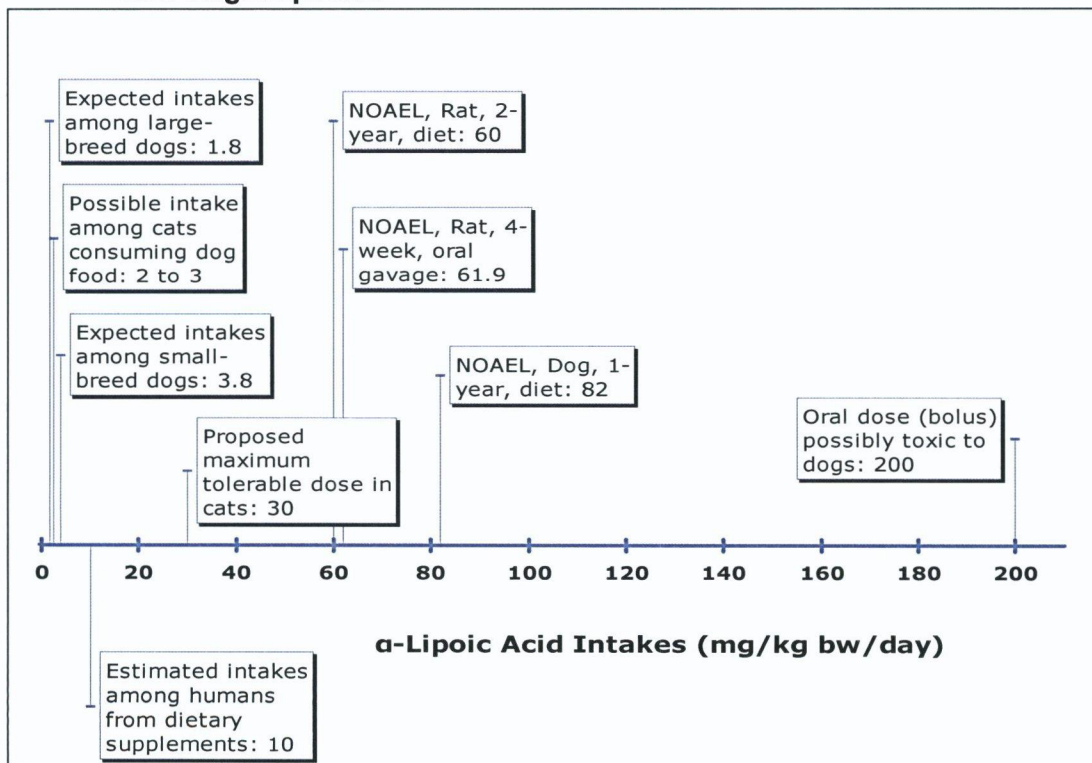

C. Target Species (Dog) Studies

Dietary α -lipoic acid studies (safety and non-safety) conducted in dogs are listed in Table 1.

A 1-year study sponsored by Hill's examined the effects of including α -lipoic acid (*dl*- α -lipoic acid) in the diet of adult dogs at levels of 0 (18 ppm background), 150, 1500, 3000, and 4500 ppm, providing approximately 0.3, 2.5, 26, 53, and 82 mg α -lipoic acid/kg bw/day, respectively. The interim (6-month) findings of this study have been published. Statistically significant differences in some clinical chemistry and hematology parameters, noted at both the 6-month and the 1-year time points, did not appear to be biologically significant. The no-observable-adverse-effect level (NOAEL) was considered to be 82 mg/kg bw/day (4500 ppm dietary inclusion rate).

The absence of adverse effects among dogs receiving test diets containing 120 to 135 ppm α -lipoic acid for periods lasting from 3 months to 2 years (Table 1) further support the assertion that no harm will result from the use of α -lipoic acid as proposed. Although these studies assessed primarily nutritional adequacy and cognitive/behavioral endpoints, they also monitored overall health, body weights, and some clinical chemistry parameters. These studies are therefore considered supportive of α -lipoic acid's safety.

Table 1 Safety and non-safety studies of dietary α -lipoic acid in dogs (target species)

Species	Amount of <i>dl</i> - α -lipoic acid in test diet ¹	Endpoint(s) Studied	Duration	Clinical Measures of Safety	Reference
Adult mixed breed dogs (3/sex/group)	150, 1500, 3000, and 4500 ppm	Safety	6 months to 1 year	Physical exam, body weight, body weight gain, hematology, serum chemistry	6-month interim results in Zicker <i>et al.</i> (2002)
21 Adult beagle dogs	128 ppm	Cognitive	6 months	Physical exam, neurologic, and ocular exams, hematology, serum chemistry, thyroid panel	Milgram <i>et al.</i> (2002)
61 Adult mixed-breed dogs	Unspecified	Cognitive and behavioral	60 days	Body weights	Dodd <i>et al.</i> (2003)
10 Adult beagle dogs	135 ppm	Cognitive	3 months	Physical exam, hematology, serum chemistry	Ikeda-Douglas <i>et al.</i> (2004)
21 Adult beagle dogs	125 ppm	Behavioral	2 years	Physical, neurologic, and ocular exams, hematology, serum chemistry, thyroid panel	Milgram <i>et al.</i> (2004, 2005)
8 Adult dogs	135 ppm	Nutritional adequacy (per AAFCO Feeding Protocol, 2000)	6 months	Body weights, body weight gains, food consumption, hemoglobin, packed cell volume (PCV), albumin, alkaline phosphatase	Hill's Document Number: 100219 FY2000-010R
7 Adult dogs	135 ppm	Nutritional adequacy (per AAFCO Feeding Protocol, 2001)	6 months	Body weights, body weight gains, food consumption, hemoglobin, packed cell volume (PCV), albumin, alkaline phosphatase	Hill's Document Number: 100300 CMDO12374R
7 Adult dogs	120 ppm	Nutritional adequacy (per AAFCO Feeding Protocol, 2001)	7 months	Body weights, body weight gains, food consumption, hemoglobin, packed cell volume (PCV), albumin, alkaline phosphatase	Hill's Document Number: 100300 CMDO12375R

¹Compared to background levels of ~20 ppm α -lipoic acid in the diet.

D. Non-Target Species and Other Studies

Additional published findings from toxicity studies in non-target species, including a chronic (2-year) oral toxicity study in rats, are summarized in Table 2. The results of these studies show that a single oral (gavage) dose of up to 2000 mg/kg bw of α -lipoic acid is not lethal to rats. The NOAEL in rats following oral exposure *via* gavage for 4 weeks or in the diet for up to 2 years was approximately 60 mg/kg bw/day.

Table 2 Overview of toxicological studies of α -lipoic acid in rodents (non-target species)

Species	Test Material and Dosage/Concentration	Endpoint	Duration	Oral LD ₅₀ or NOAEL	Reference
Rat Sprague-Dawley 10/sex/group	<i>dl</i> -thioctic acid, purity unspecified Amount administered not specified	Acute oral toxicity (dosing method unspecified)	Single dose	LD ₅₀ : 1320 mg/kg bw in males; 1130 mg/kg bw in females	Fuke <i>et al.</i> (1972) (translation of Japanese article)
Rat Sprague-Dawley IGS Br Female	α -lipoic acid (racemic), 99.0 % purity Single dose starting with 175 mg/kg bw in 1 rat, followed by 550 mg/kg bw in a second rat, and 2000 mg/kg bw in 3 other rats	Acute oral (gavage) toxicity Up-and-down test method	Single dose with 14-day post-dose observation period	LD ₅₀ : > 2000 mg/kg bw	Cremer <i>et al.</i> (2006a)
Rat Wistar	α -lipoic acid (racemic), 99.0 % purity 68.1, 147, 316, or 681 mg/kg bw/day	Subchronic oral (gavage) toxicity Dose-range-finding	2 weeks	NOAEL: 68.1 mg/kg bw/day	Cremer <i>et al.</i> (2006a)
Rat Wistar 15/sex/group	α -lipoic acid (racemic), 99.0 % purity 31.6, 61.9, or 121 mg/kg bw/day	Subchronic oral (gavage) toxicity	4 weeks	NOAEL: 61.9 mg/kg bw/day	Cremer <i>et al.</i> (2006a)
Rat Sprague-Dawley (Hsd/Win:WU) 40/sex/group ¹	α -lipoic acid (racemic), 99.0 % purity 20, 60, or 180 mg/kg bw/day	Chronic oral (diet) study	2 years	NOAEL: 60 mg/kg bw/day	Cremer <i>et al.</i> (2006b)

LD₅₀: median lethal dose; NOAEL: no-observable-adverse-effect level.

¹The control and high-dose groups each started with 50 rats/sex; 10 rats/sex from each of these groups was sacrificed at 6 months, leaving 40 rats/sex/group to complete the study.

The results of genotoxicity assays (Ames bacterial mutagenicity, *in vitro* mammalian cell gene mutation, and *in vivo* mouse micronucleus) show no evidence of mutagenic or clastogenic potential.

E. Unfavorable Information

Findings that might seem inconsistent with GRAS include published reports by Loftin and Herold (2009) of possible α -lipoic acid toxicity in two dogs following accidental consumption of approximately 200 mg/kg in a short period of time. As Figure 6 illustrates, the exposure to α -lipoic acid among dogs from its use in canine foods as proposed (150 ppm) is expected to be approximately 2 to 4 mg/kg bw/day, about 50-100 times lower than the levels reported to be toxic.

It has been suggested that cats are more susceptible to α -lipoic acid-related toxicity than humans, dogs, or rats. However, any exposure to α -lipoic acid among cats from collateral consumption of the proposed dog food is expected to be episodic and most likely in the 2 to 3 mg/kg bw/day range. This is 10 to 15 times lower than the 30 mg/kg bw considered the maximum tolerable dose (not lethal) in cats, and 4 to 6 times lower than the 13 mg/kg bw considered to be the no-effect level.

III. Expert Panel Review

At the request of Hill's Pet Nutrition, an Expert Panel comprised of individuals qualified by scientific training and experience independently and critically evaluated the available information supporting the generally recognized as safe (GRAS) status of α -lipoic acid when used in dry foods for adult dogs (*i.e.*, at least 1 year old) at levels up to 150 ppm (150 mg/kg food or 0.0150%). α -Lipoic acid is intended to be used as a cellular antioxidant and cofactor of enzymes involved in the metabolism of carbohydrates and amino acids.

At the time of its review, the Expert Panel relied on the criteria established by FDA CFSAN for evaluation of GRAS substances added to human foods, in the expectation that the pending FDA CVM GRAS policy for substances used in animal foods would be similar.

The Panel considered in its deliberations that the R-enantiomer of α -lipoic is synthesized endogenously by most organisms and that it is a cofactor essential to proper mitochondrial function. The Panel also noted that the material Hill's intends to use in canine foods (CAS RN 1077-28-7; *dl*- α -lipoic acid) is an exogenous racemic mixture (R- and S-enantiomers) produced by one or more manufacturers using conventional food industry processes, in accordance with Good Manufacturing Practice (GMP) standards, and, importantly, within rigid specifications established by Hill's. Such racemic mixtures are widely used in (human) dietary supplements providing up to 600 mg α -lipoic acid/person/day (10 mg/kg bw/day in a 60-kg person).

Several studies were presented to the Panel as evidence of the safety of α -lipoic acid, including a 6-month to 1-year dietary safety study in dogs, and several published studies that included a chronic (2-year) oral toxicity study in rats, several dog studies with nutritional, cognitive, or behavioral endpoints, and genotoxicity assays. The Panel noted that there were no treatment-related adverse effects in any of the animal studies and that *dl*- α -lipoic does not appear to possess any genotoxic or carcinogenic potential.

The Panel recognized that exposure to α -lipoic acid among dogs from its use in canine foods as proposed (150 ppm) is expected to be approximately 2 to 4 mg/kg bw/day. This is at about 20 to 40 times lower than the NOAEL from the 1-year dog dietary study (82 mg/kg bw/day), 50 to 100 times lower than the dose reported to be toxic in dogs (200 mg/kg bw), and 15 to 30 times lower than the NOAEL from the 2-year rat dietary study (60 mg/kg bw/day). Exposure to α -lipoic acid among cats from collateral consumption of the proposed dog food would not be expected to exceed 3 mg/kg bw/day, which is 10 to 15 times lower than the maximum tolerable dose and 4 to 6 times lower than the no-effect level in cats.

Having considered all the available information, including the nature of α -lipoic acid as an endogenous substance, its use in human dietary supplements, and the absence of adverse effects in various safety studies, the members of the Expert Panel concluded that there is reasonable certainty that no harm will result from the use of α -lipoic acid as described and that such use may be considered GRAS.

IV. Basis for Concluding that the use of α -Lipoic Acid in Canine Foods is Generally Recognized as Safe (GRAS)

Hill's Pet Nutrition, Inc. has determined that α -lipoic acid is exempt from the definition of "food additive" and thus from the premarket approval requirements outlined in section 201(s) of the Federal Food, Drug, and Cosmetic Act, because its use in dry foods for adult dogs (*i.e.*, at least 1 year old) at levels up to 150 ppm (150 mg/kg food or 0.0150%) is generally recognized as safe (GRAS) by qualified experts, as shown through scientific procedures. α -Lipoic acid is a cellular antioxidant and cofactor of enzymes involved in the metabolism of carbohydrates and amino acids.

To make the GRAS determination, Hill's: (1) compiled information regarding the nature of the substance, specifications, manufacturing, proposed conditions of use, and technical evidence of safety into a comprehensive dossier (GRAS dossier); and (2) sought the opinion of an "Expert Panel" specifically convened for the purpose of reviewing the information therein to determine whether there is a consensus among qualified experts that the use of α -lipoic acid as described entails a reasonable certainty of no harm and is generally recognized as safe.

V. References

AAFCO. 2010. Official Publication. Association of American Feed Control Officials Incorporated, p. 319.

Arivazhagan P, Ramanathan K, Panneerselvam C. 2001. Effect of DL- α -lipoic acid on mitochondrial enzymes in aged rats. *Chem Biol Interact* 138:189-198.

Cremer DR, Rabeler R, Roberts A, Lynch B. 2006a. Safety evaluation of α -lipoic acid (ALA). *Reg Tox Pharm* 46:29-41.

Cremer DR, Rabeler R, Roberts A, Lynch B. 2006b. Long-term safety of α -lipoic acid (ALA) consumption: A 2-year study. *Reg Tox Pharm* 46:193-201.

Díaz-Cruz A, Serret M, Ramírez G, Ávila E, Guinzberg R, Piña E. 2003. Prophylactic action of lipoic acid on oxidative stress and growth performance in broilers at risk of developing ascites syndrome. *Avian Pathology* 32(6):645-653.

Dodd CE, Zicker SC, Jewell DE, Fritsch DA, Lowry SR, Allen TA. 2003. Can a fortified food affect the behavioral manifestations of age-related cognitive in dogs? *Veterinary Medicine (May 2003)*:396-408.

Fuke H, Iwanami K, Watanabe N, Kumada S. 1972. Acute, subacute and chronic toxicity of thioctic acid in rats. *Nippon Yakurigaku Zasshi (Folia Pharmacologica Japan)* 68:265-275. Article translated from Japanese to English.

Ikeda-Douglas CJ, Zicker SC, Estrada J, Jewell DE, Milgram NW. 2004. Prior experience, antioxidants, and mitochondrial cofactors improve cognitive function in aged beagles. *Vet Therap* 5(1):5-16.

Liu J, Head E, Gharib AM, Yuan W, Ingersoll RT, Hagen TM, Cotman CW, Ames BN. 2002. Memory loss in old rats is associated with brain mitochondrial decay and RNA/DNA oxidation: partial reversal by feeding acetyl-L-carnitine and/or R- α -lipoic acid. *Proc Natl Acad Sci USA* 99(4):2356-2361.

Loftin EG and Herold LV. 2009. Therapy and outcome of suspected alpha lipoic acid toxicity in two dogs. *J Vet Emergency Crit Care* 19(5):501-506.

Milgram MW, Araujo JA, Hagen TM, Treadwell BV, Ames BN. 2007. Acetyl-L-carnitine and α -lipoic acid supplementation of aged beagle dogs improved learning in two landmark discrimination tests. *FASEB J* 21:3756-3762

Milgram NW, Head E, Zicker SC, Ikeda-Douglas C, Murphey H, Muggenburg BA, Siwak CT, Dwight Tapp P, Lowry SR, Cotman CW. 2004. Long-term treatment with antioxidants and a program of behavioral enrichment reduces age-dependent impairment in discrimination and reversal learning in beagle dogs. *Experimental Gerontology* 39:753-765.

Milgram NW, Head E, Zicker SC, Ikeda-Douglas CJ, Murphey H, Muggenburg B, Siwak C, Tapp D, Cotman CW. 2005. Learning ability in aged beagle dogs is preserved by behavioral enrichment and dietary fortification: a two-year longitudinal study. *Neurobiol Aging* 26(1):77-90.

Milgram NW, Zicker SC, Head E, Muggenburg BA, Murphey H, Ikeda-Douglas CJ, Cotman CW. 2002. Dietary enrichment counteracts age-associated cognitive dysfunction in canines. *Neurobiology of Aging* 23:737-745.

Zicker S, Hagen TM, Joisher N, Golder C, Joshi D, Phillip Miller E. 2002. Safety of long-term feeding of dl- α -lipoic acid and its effect on reduced glutathione:oxidized glutathione ratios in beagles. *Vet Ther* 3(2):167-176.

Hill's Pet Nutrition, Inc. Internal Reports

Study/Document Number: 100219 FY2000-010R

Product: Science Diet® Canine Senior® NM Prototype dry Formula

Objective: Evaluate the nutritional adequacy of the test food for the maintenance of adult dogs

Protocol: 2000 AAFCO Canine Adult Maintenance Protocol

Formula: 16668

Test Dates: 1/27/00-9/6/00

Study Number: 100300 CMDO12374

Document Number: 100300 CMDO12374R

Product: Project Mikey Prototype (22204) dry canine formula

Objective: Evaluate the nutritional adequacy of the test food for the maintenance of adult dogs

Protocol: 2001 AAFCO Canine Adult Maintenance Protocol

Formula: 22204-1

Test Dates: 2/14/01-8/15/01

Study Number: 100300 CMDO12375

Document Number: 100300 CMDO12375R

Product: Project Mikey Prototype (22205) dry canine formula

Objective: Evaluate the nutritional adequacy of the test food for the maintenance of adult dogs

Protocol: 2001 AAFCO Canine Adult Maintenance Protocol

Formula: 22205-1

Test Dates: 2/14/01-9/12/01

Title: The safety of Supplemental Dietary α -Lipoic Acid in the Target Species, Dogs

Study Number: 11635 (Hills); 449-00-69 (CAVL)

Document Number: 100293-CLIPD-11635R.2
Chemical name: α -Lipoic Acid
Proposed Usage: Antioxidant for dog foods
Amended Final Study Report (signed 02/2005)

Databases

The GeneCards Human Gene Database: Orthologs for pyruvate dehydrogenase complex component E₂ (dihydrolipoamide S-acetyltransferase or DLAT) gene, accessed online through <http://www.genecards.org> in September, 2010.

Kyoto Encyclopedia of Genes and Genomes (KEGG) PATHWAY Database: Pathway for *Canis familiaris* (dog) accessed online through <http://www.genome.jp/kegg> in September-October, 2010.

EXPERT PANEL CONSENSUS STATEMENT REGARDING THE USE OF α -LIPOIC ACID IN CANINE FOODS AS GENERALLY RECOGNIZED AS SAFE (GRAS)

Background

In the United States, a substance added to foods is exempt from the definition of “food additive” and thus from the premarket approval requirements outlined in section 201(s) of the Federal Food, Drug, and Cosmetic Act if its use is generally recognized as safe (GRAS). Originally, GRAS determinations were made by the U.S. FDA, and a GRAS affirmation petition process was established whereby an individual could petition FDA to review the GRAS status of a particular substance. In 1997, the agency issued a proposed rule that, if finalized, would eliminate the GRAS affirmation petition process and replace it with a notification procedure (62 FR 18938; April 17, 1997). This would apply to substances added to human foods, codified at 21 CFR Parts 170, *et al.*, as well as substances added to animal food or feeds, codified at 21 CFR Parts 570, *et al.*

Although the GRAS rule has not been finalized, the notification procedure has become standard practice, but only through FDA CFSAN¹ and only for substances added to human foods. A parallel process through FDA CVM² for substances added to animal food and feeds has not yet been established, but is pending. Accordingly, Hill’s is undertaking preparation of a GRAS notification for the use of α -lipoic acid as a nutritive ingredient in canine foods.

The data supporting safety (*i.e.*, the technical element) were compiled into a dossier that was submitted to the undersigned experts for their opinion regarding the GRAS status of α -lipoic acid when used at levels up to 150 ppm (150 mg/kg food or 0.0150%) in dry foods for adult dogs (*i.e.*, at least 1 year old) as a substance offering nutritive value.

GRAS Substance Characterization

The Expert Panel recognized that α -lipoic acid: (1) is a substance synthesized and naturally present in the mitochondria of most organisms; (2) is an essential component of various mitochondrial enzyme complexes involved in energy production and catabolism; and (3) occurs naturally as the R-enantiomer and as a racemic mixture (R- and S-enantiomers) when produced commercially.

The Panel also considered that the racemic mixture of α -lipoic acid that Hill’s intends to use in canine foods (CAS RN 1077-28-7; *dl*- α -lipoic acid) is produced by one or more qualified manufacturers through conventional GMP food industry processes to meet rigid specifications established by Hill’s, and that the racemic mixture is similar to those widely used in (human)

¹ Center for Food Safety & Applied Nutrition

² Center for Veterinary Medicine

EXPERT PANEL CONSENSUS STATEMENT REGARDING THE USE OF α -LIPOIC ACID IN CANINE FOODS AS GENERALLY RECOGNIZED AS SAFE (GRAS)

dietary supplements and extensively studied; the amounts of *dl*- α -lipoic acid obtained from such dietary supplements ranging from 300 to 600 mg/person/day, taken in divided doses.³

Proposed Uses and Estimated Intakes

It is the Panel's understanding that Hill's intends to use α -lipoic acid in dry foods for adult dogs (*i.e.*, at least 1 year old) at levels up to 150 ppm (150 mg/kg food or 0.0150%), and that α -lipoic acid would be used as a substance offering nutritive value in combination with various other nutrients such as vitamins C and E. The concept of "nutritive value", as presented by Hill's, is considered to refer to substances that, while not "essential nutrients" in the classical sense, possess qualities that offer potential benefits to health such as by complementing endogenous supplies and/or facilitating physiological functions.

According to Hill's exposure estimates, small dogs would have the highest α -lipoic acid intake on a per kg body weight basis. For a dog weighing 2.3 kg that consumes about 0.059 kg food per day, the exposure to α -lipoic acid would be 3.8 mg/kg bw/day. For an average, medium-sized dog weighing 18 kg and consuming 0.281 kg/day of food, α -lipoic acid exposure would be approximately 2.3 mg/kg bw/day, comparable to intakes from a dietary inclusion rate of 150 ppm used in a 1-year dog safety study (2.5 mg α -lipoic acid/kg bw/day). Exposure among large breed dogs would be lower (*e.g.*, 1.8 mg/kg bw/day in a 45.4-kg dog). However, when exposure was considered on the basis of 100 kcal consumed, exposure across breed sizes did not vary greatly.

Safety

The Panel reviewed data showing that α -lipoic acid undergoes extensive first-pass metabolism after ingestion and is excreted primarily in the urine. Tetranorlipoic acid, the product of β -oxidation, and its derivatives appear to be the most predominant metabolites in dog plasma.

In addition, the Panel reviewed the findings of a 1-year study sponsored by Hill's that examined the effects of including α -lipoic acid (*dl*- α -lipoic acid) in the diet of dogs at levels of 0 (18 ppm background), 150, 1500, 3000, and 4500 ppm, providing approximately 0.3, 2.5, 26, 53, and 82 mg α -lipoic acid/kg bw/day, respectively. The Expert Panel noted that the interim (6-month) findings of this study have been published. The Panel agreed that the statistically significant differences noted at both the 6-month and the 1-year time points in some clinical chemistry and hematology parameters did not appear to be biologically significant, and considered the proposed no-observable-adverse-effect level (NOAEL) of 82 mg/kg bw/day (4500 ppm dietary inclusion rate) to be safe.

³ In a person weighing 60 kg, such *dl*- α -lipoic acid intakes would be equivalent to 5 to 10 mg/kg bw/day.

EXPERT PANEL CONSENSUS STATEMENT REGARDING THE USE OF α -LIPOIC ACID IN CANINE FOODS AS GENERALLY RECOGNIZED AS SAFE (GRAS)

In its evaluation, the Panel also considered the published findings of a number of other supporting toxicity studies in non-target species, including a chronic (2-year) oral toxicity study in rats. The results of these studies show that a single oral (gavage) dose of up to 2000 mg/kg bw of α -lipoic acid is not lethal to rats. The NOAEL in rats following oral exposure *via* gavage for 4 weeks or in the diet for up to 2 years was approximately 60 mg/kg bw/day. The Panel found it reassuring that the results of genotoxicity assays show no evidence of mutagenic or clastogenic potential.

Other supportive evidence included several studies assessing primarily nutritional adequacy and cognitive/behavioral endpoints in dogs receiving 135 ppm α -lipoic acid alone and in combination with other substances. The Panel agreed that, while not safety studies *per se*, the absence of adverse effects provides supportive evidence of α -lipoic acid's safety.

Also reviewed by the Panel were findings that might seem inconsistent with GRAS. Specifically, published reports of possible α -lipoic acid toxicity in two dogs following accidental consumption of approximately 200 mg/kg in a short period of time, and reports of greater susceptibility to α -lipoic acid-related toxicity among cats (maximum tolerated dose: 30 mg/kg bw).

The following illustration highlights critical endpoints and estimated exposures in target and non-target animal species.

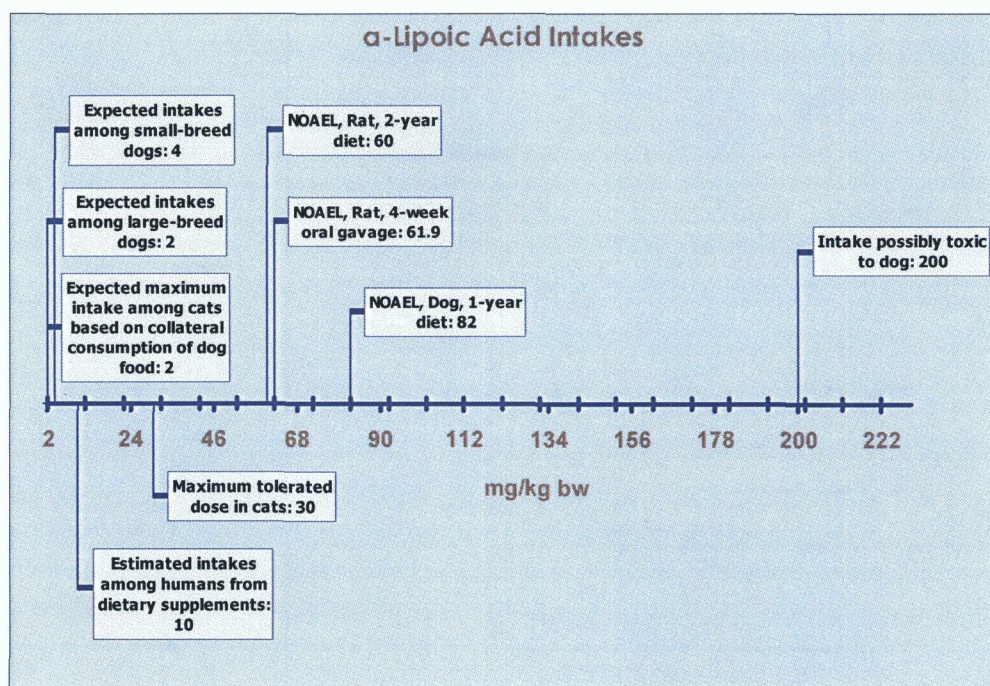

EXPERT PANEL CONSENSUS STATEMENT REGARDING THE USE OF α -LIPOIC ACID IN CANINE FOODS AS GENERALLY RECOGNIZED AS SAFE (GRAS)

Expert Panel Opinion

At the request of Hill's Pet Nutrition, an Expert Panel comprised of the undersigned members, qualified by scientific training and experience, has independently and critically evaluated the available information supporting the generally recognized as safe (GRAS) status of α -lipoic acid when used in dry foods for adult dogs (*i.e.*, at least 1 year old) at levels up to 150 ppm (150 mg/kg food or 0.0150%). α -Lipoic acid would be used as a substance offering nutritive value.

In evaluating the data in the GRAS dossier provided by Hill's, the Panel relied on the criteria established by the U.S. FDA CFSAN for evaluation of substances added to human foods, in the expectation that future GRAS rules will increase consistency and uniformity between substances used in human food and substances used in animal food or feeds.

The Panel considered in its deliberations that the R-enantiomer of α -lipoic is synthesized endogenously by most organisms and that it is a cofactor essential to proper mitochondrial function. The Panel also noted that the material Hill's intends to use in canine foods (CAS RN 1077-28-7; *dl*- α -lipoic acid) is an exogenous racemic mixture (R- and S-enantiomers) produced by one or more manufacturers (not yet identified) using conventional food industry processes, in accordance with Good Manufacturing Practice (GMP) standards, and, importantly, within rigid specifications established by Hill's. Such racemic mixtures are widely used in (human) dietary supplements providing up to 600 mg α -lipoic acid/person/day (10 mg/kg bw/day in a 60-kg person).

Several studies were presented to the Panel as evidence of the safety of α -lipoic acid, including a 1-year dietary safety study in dogs, and several published studies that included the 6-month interim results of the 1-year dog study, a chronic (2-year) oral toxicity study in rats, several dog studies with nutritional, cognitive, or behavioral endpoints, and genotoxicity assays. The Panel noted that there were no treatment-related adverse effects in any of the animal studies and that *dl*- α -lipoic does not appear to possess any genotoxic or carcinogenic potential.

The Panel recognizes that exposure to α -lipoic acid among dogs from its use in canine foods as proposed (150 ppm) is expected to be approximately 2 to 4 mg/kg bw/day. This is at about 20-40 times lower than the NOAEL from the 1-year dog dietary study (82 mg/kg bw/day), 50-100 times lower than the dose reported to be toxic in dogs (200 mg/kg bw), and 15-30 times lower than the NOAEL from the 2-year rat dietary study (60 mg/kg bw/day). Exposure to α -lipoic acid among cats from collateral consumption of the proposed dog food would not be expected to exceed 2

EXPERT PANEL CONSENSUS STATEMENT REGARDING THE USE OF α -LIPOIC ACID IN CANINE FOODS AS GENERALLY RECOGNIZED AS SAFE (GRAS)

mg/kg bw/day, which is 15 times lower than the reported maximum tolerated dose for cats (30 mg/kg bw). These margins were considered by the Panel to be sufficient in ensuring safety even in the event of excessive intake or collateral intake by cats or humans.

Having considered all the available information, including the nature of α -lipoic acid as an endogenous substance, its use in dietary supplements, and the absence of adverse effects in various safety studies, the undersigned members of the Expert Panel conclude that there is reasonable certainty that no harm will result from the use of α -lipoic acid as described and that such use may be considered GRAS. However, the Panel is of the opinion that publication of the terminal findings from the 1-year dog study and of other supportive studies would strengthen this opinion.

<p>Donald H. Hughes, Ph.D. Hughes Consulting Cincinnati, OH</p> <p>Signature: <u><i>Donald H. Hughes Ph.D.</i></u> Date: <u>3/30/10</u></p>	<p>John A. Thomas, Ph.D., D.A.T.S Adjunct Professor Indiana University School of Medicine Indianapolis, IN</p> <p>Signature: <u><i>John A. Thomas</i></u> Date: <u>3/23/10</u></p>
<p>K.C. Hayes, D.V.M., Ph.D. Professor Biology (Nutrition) Brandeis University Waltham, MA</p> <p>Signature: <u><i>KC Hayes</i></u> Date: <u>3/24/10</u></p>	<p>David H. Bechtel, Ph.D., DABT Vice President & Senior Scientific Consultant Cantox U.S. Inc. Bridgewater, NJ</p> <p>Signature: <u><i>David H. Bechtel</i></u> Date: <u>4/5/10</u></p>

**Summary of Data Supporting the Use of
 α -Lipoic Acid as a Generally Recognized
as Safe (GRAS) Ingredient for
Canine Foods**

- Final -

Prepared for: Hill's Pet Nutrition, Inc.
400 SW 8th Avenue
Topeka, Kansas
66603

Prepared by: Cantox U.S. Inc.
1011 U.S. Highway 22, Suite 200
Bridgewater, New Jersey
08807-2950

January 5, 2011

Summary of Data Supporting the Use of α -Lipoic Acid as a Generally Recognized as Safe (GRAS) Ingredient for Canine Foods

Table of Contents

	Page
LIST OF ABBREVIATIONS	8
1.0 INTRODUCTION	11
1.1 Objective	11
1.2 Criteria for Evaluation of Data	11
2.0 DESCRIPTION OF THE SUBSTANCE	13
2.1 Material Characterization	13
2.2 Sources of α -Lipoic Acid	14
2.2.1 Naturally-Occurring α -Lipoic Acid	14
2.2.2 Manufactured α -Lipoic Acid	17
3.0 MANUFACTURING AND QUALITY ASSURANCE	18
3.1 Manufacturing	18
3.2 Specifications	19
3.3 Quality and Stability	20
3.3.1 α -Lipoic Acid	20
3.3.2 α -Lipoic Acid in Canine Dry Food	20
4.0 INTENDED USE OF α -LIPOIC ACID AND PROJECTED EXPOSURE	23
4.1 Intended Use	23
4.2 Estimated Exposure	23
5.0 BIOLOGICAL ACTIVITY OF α -LIPOIC ACID	25
5.1 α -Lipoic Acid as a Cellular Antioxidant	25
5.2 α -Lipoic Acid as an Enzyme Cofactor	30
5.3 α -Lipoic Acid's Other Functions	35
5.3.1 Nutritive Value	35
5.3.2 Maintenance of Mitochondrial Structure and Function	36
6.0 UPTAKE, METABOLISM, AND ELIMINATION OF <i>dl</i> - α -LIPOIC ACID	38
7.0 SAFETY OF α -LIPOIC ACID	43
7.1 Safety Studies in the Target Animal Species (Dog)	43
7.1.1 Published Interim (6-Month) Findings of a Chronic Dietary Study in Dogs	44
7.1.2 Unpublished 1-Year Findings of a Chronic Dietary Study in Dogs	45

7.2	Safety Studies in Other Animal Species	62
7.2.1	Single-Dose Toxicity in Rodents	62
7.2.2	Four-Week Oral Toxicity in SD Rats (Cremer <i>et al.</i> , 2006a)	62
7.2.3	Two-Year Dietary Study in SD Rats (Cremer <i>et al.</i> , 2006b)	65
7.3	Genetic Toxicity	67
7.3.1	Ames Bacterial Mutagenicity Assay (Cremer <i>et al.</i> , 2006a)	68
7.3.2	<i>In vivo</i> Mouse Micronucleus Assay (Cremer <i>et al.</i> , 2006a)	68
7.4	Reproductive Toxicity	72
8.0	SUPPORTING DATA	75
8.1	Studies conducted by (b) (4) <i>dl</i> - α -lipoic acid supplier	75
8.2	Supporting Studies in the Target Animals Species (Dog)	76
9.0	ADDITIONAL CONSIDERATIONS	80
9.1	Reports of Accidental Toxicity in Dogs	80
9.2	Toxicity in Cats	80
9.3	Studies of α -Lipoic Acid Polymer	83
10.0	SUMMARY AND CONCLUSION	84
11.0	REFERENCES	87

Appendices

	Page
APPENDIX 1: Specifications for <i>dl</i> - α -lipoic acid established by Hill's Pet Nutrition	95
APPENDIX 2: Specifications for <i>dl</i> - α -lipoic acid established by (b) (4) the intended supplier of material to be used by Hill's	105
APPENDIX 3: Analytical method developed by Hill's for determination of α -lipoic acid in dry pet food.....	107
APPENDIX 4: Data validating the analytical method developed by Hill's for determination of α -lipoic acid in dry pet food.....	113
APPENDIX 5: Results of HPLC analysis of canine foods containing <i>dl</i> - α -lipoic acid at various levels	117
APPENDIX 6: Mean estimated food and α -lipoic acid intakes among dogs during a 1-year safety study based on: mean food consumption values and measured levels of α -lipoic acid in the study diets.....	120
APPENDIX 7: Tabulated data from 1-year dietary safety study of <i>dl</i> - α -lipoic acid in the target species (dog)	124

List of Tables and Figures

	Page
Table 1-1	Critical elements of a GRAS dossier 12
Table 2-1	Sources of naturally-occurring α -lipoic acid 15
Table 3-1	Critical elements of Hill's specifications for α -lipoic acid used in canine foods... 19
Table 3-2a	Results of stability testing of 3 lots of (b) (4) dl - α -lipoic acid stored at 25 °C/60 % relative humidity 21
Table 3-2b	Results of stability testing of 3 lots of (b) (4) dl - α -lipoic acid stored at 30 °C/65 % relative humidity 22
Table 4-1	Estimates of α -lipoic acid exposure during safety studies..... 24
Table 4-2	Projected α -lipoic acid intakes among dogs based on normal food consumption estimates 25
Table 5-1	Antioxidant markers measured at Day 30 and Day 90 in the blood of dogs receiving each of 4 different foods..... 29
Table 5-2	Enzyme systems that require α -lipoic acid for normal function 30
Table 6-1	Mean radiolabel in urine (0-24 hours) of the mouse, rat, and dog following oral (gavage) administration of [14 C] α -lipoic acid as a single dose..... 38
Table 6-2	Mean radiolabel in plasma following administration of [14 C] α -lipoic acid to rats at 30 mg/kg bw orally (gavage) and dogs at 10 mg/kg bw orally (gavage) and intravenously (i.v.)..... 39
Table 6-3	Methods of administration used to examine the pharmacokinetics of dl - α -lipoic acid in dogs..... 41
Table 6-4	Range of values for pharmacokinetic parameters in dogs receiving dl - α -lipoic acid orally by 3 methods of administration at 3 doses 41
Table 7-1	Estimates of α -lipoic acid exposure among dogs receiving study diets for up to 1 year..... 43
Table 7-2	Mean body weights (kg) of beagle dogs (3/sex/group) receiving dietary α -lipoic acid for 6 months 44
Table 7-3	Mean body weights (kg) of adult dogs (1 to 3 years old) receiving dietary dl - α -lipoic acid for 1 year 46
Table 7-4	Spontaneous deaths among rats receiving α -lipoic acid in the diet for up to 2 years..... 66

Table 6-5 Mean body weights of rats receiving α -lipoic acid in the diet for up to 2 years... 66

Table 7-6 Summary of neoplastic findings in SD rats receiving α -lipoic acid in the diet for up to 2 years 67

Table 7-7 Summary of toxicological assays of α -lipoic acid in rodents 69

Table 7-8 Results of (b) (4) α -lipoic acid reproductive toxicity studies, compared to multiple-dose toxicity study findings 74

Table 8-1 Summary of studies conducted by (b) (4) 75

Table 8-2 Summary of published and unpublished studies of Hill's canine formulas containing α -lipoic acid..... 77

Table 9-1 Estimated α -lipoic acid exposure among cats of various sizes from collateral consumption of the proposed dry dog food[†] 82

Figure 2-1	Molecular structure of α -lipoic acid	13
Figure 2-2	Structure of lipoyllysine	14
Figure 2-3	<i>De novo</i> synthesis of α -lipoic acid in <i>E. coli</i>	16
Figure 2-4	Pathway for converting endogenous free lipoic acid to lipoyllysine (Source: KEGG: Kyoto Encyclopedia of Genes and Genomes).....	17
Figure 3-1	(b) (4) method for α -lipoic acid synthesis	18
Figure 5-1	Schematic overview of the role of α -lipoic acid (LA) in maintaining endogenous antioxidant defenses	28
Figure 5-2	Schematic overview of α -lipoic acid's function (bound to E ₂ subunit of PDH and KGDH) in the citric acid cycle.....	31
Figure 5-3	Schematic overview of α -lipoic acid's function (bound to the H protein of the glycine cleavage system) in the catabolism of glycine, serine, and threonine....	32
Figure 5-4	Schematic overview of α -lipoic acid's function (bound to branched-chain keto acid dehydrogenase) in the catabolism of branched-chain amino acids	33
Figure 5-5	Schematic of lipoyllysine's role in the transport of intermediates (hydrogen or acetyl/acyl group) along PDH and KGDH enzyme active sites	34
Figure 6-1	Overview of the main metabolites of (<i>dl</i> -) α -lipoic acid	40
Figure 7-1	Plotted results of serum biochemistry mean values in adult dogs (1 to 3 years old) receiving <i>dl</i> - α -lipoic acid in the diet for 1 year.....	48
Figure 7-2	Plotted results of hematology mean values in adult dogs (1 to 3 years old) receiving <i>dl</i> - α -lipoic acid in the diet for 1 year.....	57
Figure 10-1	Safety endpoints and estimated exposures to α -lipoic acid among various animal species	85

LIST OF ABBREVIATIONS

>	greater than
<	less than
≥	greater than or equal to
≤	less than or equal to
°C	degree(s) Celsius
µg	microgram
¹ H NMR	proton nuclear magnetic resonance
Å	angstrom
ACP	acyl carrier protein
A:G	albumin-globulin ratio
AL	alpha-lipoic acid/lipoate or α-lipoic acid/lipoate
ALA	alpha-lipoic acid or α-lipoic acid
ALT	alanine transaminase; also known as alanine aminotransferase (ALAT) or serum glutamic pyruvic transaminase (SGPT)
AMP	adenosine monophosphate
AST	aspartate transaminase; also known as serum glutamic oxaloacetic transaminase (SGOT)
ATP	adenosine triphosphate
CAS RN	Chemical Abstracts Service registry number
CFR	Code of Federal Regulations
CFU	colony-forming units
COA	certificate of analysis
CO ₂	carbon dioxide
CV	coefficient of variation
DCM	dilated cardiomyopathy
DHA	docosahexaenoic acid
dL	deciliter
DM	dry matter
DNA	deoxyribonucleic acid
EDTA	ethylenediaminetetraacetic acid
EPA	eicosapentaenoic acid
F	female
FAD	flavin adenine dinucleotide
FADH ₂	reduced form of flavin adenine dinucleotide (FAD)
FDA	United States Food and Drug Administration
FT-IR	Fourier transform spectroscopy
g	gram
GC	gas chromatography

GSH	glutathione
GLP	Good Laboratory Practices
GMP	Good Manufacturing Practices
GPC	gel permeation chromatography
GRAS	generally recognized as safe
GSSG	oxidized glutathione
H ₂ O ₂	hydrogen peroxide
HCl	hydrochloric acid
HPLC	high-performance liquid chromatography
IU	international unit
kcal	kilocalorie
kg	kilogram
KGDH	α-ketoglutarate dehydrogenase
L	liter
lb	pound
LD ₅₀	median lethal dose
LipA	lipoyl synthase
LipB	lipoyl(octanoyl) transferase
LplA	lipoyl ligase
M	male
ME	metabolizable energy
mEq	milliequivalent
mg	milligram
min	minute
mL	milliliter
mm	millimeter
mmol	millimole
Mn SOD	manganese superoxide dismutase
mt DNA	mitochondrial DNA
MTD	maximum tolerated dose
NaCl	sodium chloride
NAD ⁺	nicotinamide adenine dinucleotide
NADH	reduced form of nicotinamide adenine dinucleotide (NAD ⁺)
NOAEL	no-observable-adverse-effect level
NOEL	no-observable-effect level
OECD	Organisation for Economic Co-operation and Development
OH [•]	hydroxyl radical
O ₂ ⁻	superoxide
PCE	polychromatic erythrocyte
PDH	pyruvate dehydrogenase

PE	polyethylene
ppm	parts per million
ROS	reactive oxygen species
RT	room temperature
SAM	S-adenosyl methionine
SD	Sprague-Dawley
SDS	sodium dodecyl sulfate
SGOT	serum glutamic oxaloacetic transaminase; also known as or aspartate transaminase (AST)
SGPT	serum glutamic pyruvic transaminase; also known as alanine transaminase (ALT) or alanine aminotransferase (ALAT)
SOD	superoxide dismutase
STAR	steroidogenic acute regulatory (protein)
TBARS	thiobarbituric acid reactive substances
TLC	thin-layer chromatography
U.S. EPA	United States Environmental Protection Agency

Summary of Data Supporting the Use of α -Lipoic Acid as a Generally Recognized as Safe (GRAS) Ingredient for Canine Foods

1.0 INTRODUCTION

1.1 Objective

Hill's Pet Nutrition, Inc. (Hill's hereafter) sought to establish through scientific procedures that the use α -lipoic acid in dry foods for adult dogs (*i.e.*, at least 1 year old) at levels up to 150 ppm (150 mg/kg food or 0.0150%) qualifies as generally recognized as safe (GRAS). α -Lipoic acid would be used as a cellular antioxidant and cofactor of enzymes involved in the metabolism of carbohydrates and amino acids. In general, most healthy organisms are able to synthesize sufficient amounts of α -lipoic acid to meet the usual requirements and can also obtain small amounts from the diet. However, supplemental amounts may help maintain optimal mitochondrial function, which is known to decline with increasing age, is subject to oxidative stress, and affects not only cellular metabolism and bioenergetics, but also cell differentiation, cell death, and various other processes.

1.2 Criteria for Evaluation of Data

To enable a determination through scientific procedures that the use α -lipoic acid as specified is GRAS, Hill's and Cantox have compiled information regarding the nature of the substance, specifications, manufacturing, proposed conditions of use, and technical evidence of safety into the present comprehensive dossier (GRAS dossier). Hill's also sought the opinion of an "Expert Panel" specifically convened for the purpose of reviewing the information herein to determine whether there is a consensus among qualified experts that the use of α -lipoic acid as described entails a reasonable certainty of no harm and would be generally recognized as safe. The criteria established by FDA CFSAN¹ for evaluation of GRAS substances added to human foods were used as a guideline for the preparation and Expert Panel review of the GRAS dossier, in the expectation that the pending procedure for FDA CVM² review of GRAS substances used in animal foods would be similar. Table 1-1 provides a summary of the critical elements addressed herein.

¹ Center for Food and Applied Nutrition

² Center for Veterinary Medicine

Table 1-1 Critical elements of a GRAS dossier

Description of the substance	Conditions of use	Technical evidence of safety
<ul style="list-style-type: none"> • Common or usual name • Chemical name • Chemical Abstracts Service (CAS) registry number • Empirical formula • Structural formula • Enzyme Commission (EC) number (if applicable) • Physical, chemical, and biological properties • Quantitative composition • Any potential animal or human toxicants • Specifications for food-grade material¹ • Method of manufacture (excluding trade secrets)² 	<ul style="list-style-type: none"> • Foods in which the substance is to be used • Levels of use, including self-limiting levels • Purposes for which the substance is used, including target population • Estimates of probable dietary exposure and the cumulative effect of the substance in the diet 	<p>A comprehensive discussion of, and citations to, generally available data and information used to establish safety, including:</p> <ul style="list-style-type: none"> • Evidence of a substantial history of consumption of the substance by a significant number of consumers • Any other corroborative scientific data or information (e.g., toxicological or clinical studies) that bears on the safety of the substance under its intended conditions of use • Any reports of investigations or other information (e.g., adverse event reports and consumer complaints) that may appear to be inconsistent with a GRAS determination (<i>i.e.</i>, unfavorable information)

¹Specifications and adequate analytical methods should be established for (1) residues of organic solvents or other potentially harmful reagents used during manufacture; (2) arsenic and heavy metals; (3) known impurities.

²It should be noted that, while "detailed information" about the method of manufacture is required, the degree of detail required is not specified.

2.0 DESCRIPTION OF THE SUBSTANCE

2.1 Material Characterization

Common Name: α -Lipoic acid (alpha-lipoic acid)

CA Index Names: *dl*-alpha-Lipoic acid; (*RS*)-1,2-dithiolane-3-pentanoic acid; (*RS*)-1,2-dithiolane-3-valeric acid

Other Names: (*RS*)-thioctic acid; lipoic acid; α -LA; ALA; thioctic acid; lipoate

CAS Registry Number: 1077-28-7 (*dl*-thioctic acid)

Other CAS Numbers: 62-46-4 (thioctic acid); 1200-22-2 (thioctic acid, *d*-form)

Empirical Formula: C₈H₁₄O₂S₂

Molecular Weight: 206.33

Structural Formula:

Figure 2-1 Molecular structure of α -lipoic acid

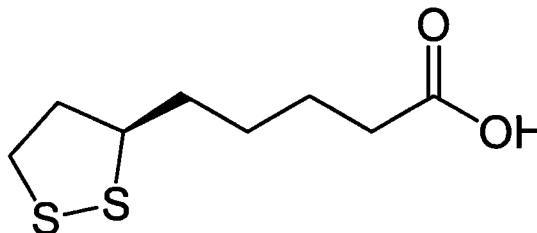

Chemical and Physical Properties:

Appearance: Yellow crystalline powder with a slight odor

Melting Point: 60-62 °C

Solubility: Very slightly soluble in water, very soluble in dimethylformamide, freely soluble in methanol (Source: Eu.Ph.6.0)

α -Lipoic acid is a carboxylic acid consisting of a disulfide or dithiolane ring and a 5-carbon fatty acid side chain. Due to the presence of a chiral center, the α -lipoic acid molecule can exist in two forms, the *R*+ or *d*-form and the *S*- or *l*-form; the *R*-enantiomer is the naturally-occurring form. However, racemic mixtures of *R*- and *S*-enantiomers (*dl*-forms) are the most commonly

used substances in α -lipoic acid studies, human nutritional supplements, *etc.*³ The material Hill's intends to use in canine foods (CAS RN 1077-28-7; *dl*- α -lipoic acid) is a racemic mixture similar to those widely used in (human) dietary supplements and extensively studied; the amounts of *dl*- α -lipoic acid obtained from such dietary supplements range from 300 to 600 mg/person/day, taken in divided doses (PDR for Nutritional Supplements, 2001; Singh and Jialal, 2008). In a person weighing 60 kg, such *dl*- α -lipoic acid intakes would be equivalent to 5 to 10 mg/kg bw/day.

2.2 Sources of α -Lipoic Acid

2.2.1 Naturally-Occurring α -Lipoic Acid

In living cells, α -lipoic acid is present as lipoyllysine. The structure of lipoyllysine, shown in Figure 2-2, consists of a lipoic acid moiety covalently-linked to the ϵ -amino group of a specific lysine residue of a target protein (Reed, 2001; Lehninger, 2005).

Figure 2-2 Structure of lipoyllysine

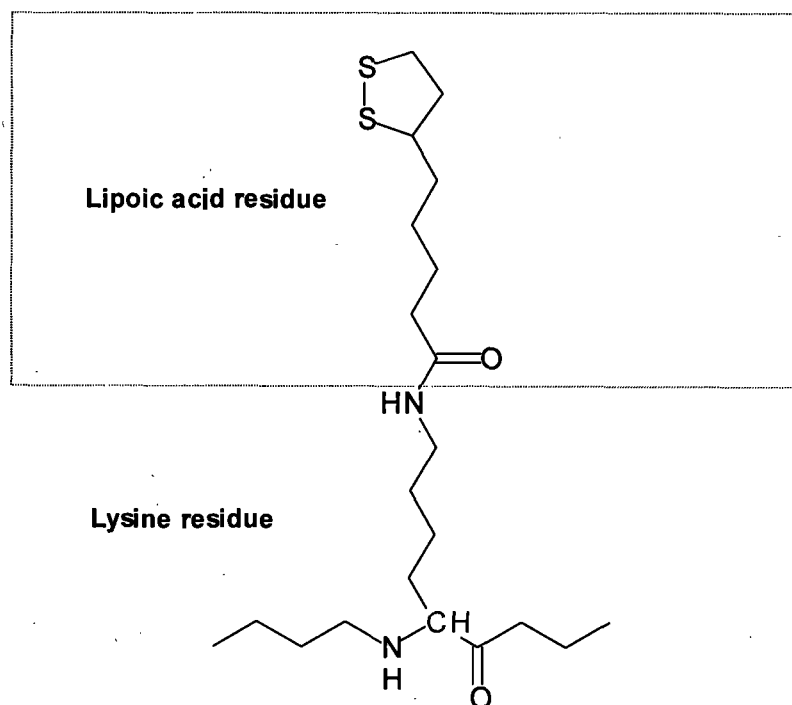

³ A racemic mixture, by definition, shows no optical rotation because both (+) and (-) enantiomers are present in equal amounts (50:50), and the rotation from one enantiomer exactly cancels the rotation from the other enantiomer (McMurry, 1984).

Table 2-1 lists amounts of α-lipoic acid, as lipoyllysine, naturally present in various plants, animal tissues, and some microorganisms. In plants, the highest levels are found in spinach and broccoli; in animal tissues, kidney, heart, and liver have the highest concentrations (Lodge *et al.*, 1997).

Table 2-1 Sources of naturally-occurring α-lipoic acid

Source	Lipoyllysine Content	
	µg/g dry weight	µg/mg protein
Kidney ^a	2.64 ± 1.23	50.57 ± 5.51
Heart ^a	1.51 ± 0.75	41.42 ± 2.76
Liver ^a	0.86 ± 0.33	15.49 ± 0.01
Spleen ^a	0.36 ± 0.08	5.69 ± 1.27
Brain ^a	0.27 ± 0.08	4.85 ± 1.69
Pancreas ^a	0.12 ± 0.05	1.97 ± 0.97
Lung ^a	0.12 ± 0.08	3.20 ± 0.04
Spinach ^b	3.15 ± 1.11	92.51 ± 4.03
Broccoli ^b	0.94 ± 0.25	41.01 ± 1.02
Tomato ^b	0.56 ± 0.23	48.61 ± 1.69
Green pea ^b	0.39 ± 0.07	17.13 ± 1.23
Brussel sprouts ^b	0.39 ± 0.21	18.39 ± 2.42
Rice bran ^b	0.16 ± 0.02	4.44 ± 2.12
Yeast ^c	0.27 ± 0.05	4.49 ± 1.78
<i>E. coli</i> ^c	8.07	68.71 ± 11.24

Values represent mean ± standard deviation for n=4, except rice bran, n=2.

^aBovine acetone powders

^bLyophilized material

^cAcetone powders

Method limit of detection: 0.1 µg/g dry weight

Source: Lodge *et al.* (1997)

Although *de novo* synthesis of α-lipoic acid in eukaryotes has not been as well-characterized as in prokaryotes (*e.g.*, *Escherichia coli*), there is evidence that small amounts of α-lipoic acid are synthesized in the mitochondria of plants and animals (Carreau, 1979; Reed, 2001; Zhang *et al.*, 2003; Witkowski *et al.*, 2007). It is presumed that α-lipoic acid synthesized in mitochondria is used locally, and only minor amounts are likely to enter the circulation (NTP, 2004). The mammalian lipoyllysine biosynthetic pathway is presumed to be similar to that of *E. coli*, illustrated in the following schematic.

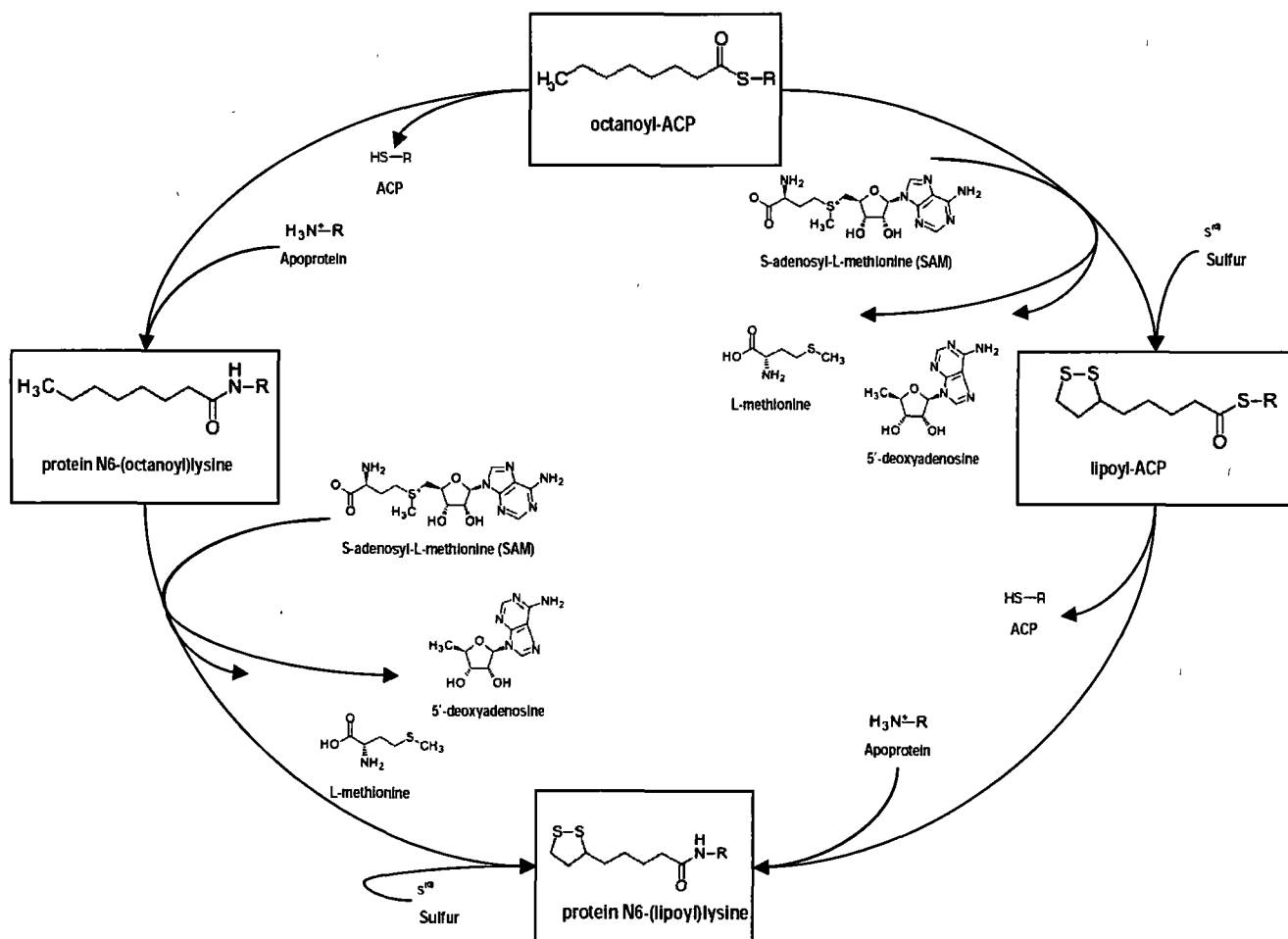
Figure 2-3 *De novo* synthesis of α -lipoic acid in *E. coli*

Source: KEGG: Kyoto Encyclopedia of Genes and Genomes.

This multistep reaction is catalyzed by a fatty (lipoic) acid synthase, which introduces two sulfur atoms at the C-6 and C-8 positions of an octanoyl moiety that is linked to a mitochondrial acyl carrier protein (ACP: malonyl-CoA) (reviewed by Witkowski *et al.*, 2007). Octanoyl-ACP is an intermediate of fatty acid biosynthesis. Fatty acid synthesis has been shown to occur in mitochondria *via* a system that is distinct (type II) from cytosolic (type I) fatty acid synthesis (reviewed by Reed, 2001). The product of this process, *i.e.*, protein N6-(lipoyl)lysine, is incorporated into the appropriate mitochondrial enzyme complex. The following alternate pathway to *de novo* lipoate synthesis from fatty acid precursors has also been described in *E. coli*. This "salvage" pathway involves the conversion of endogenous free lipoic acid into lipoyllysine *via* a lipoyl-AMP intermediate.

Figure 2-4 Pathway for converting endogenous free lipoic acid to lipoyllysine (Source: KEGG: Kyoto Encyclopedia of Genes and Genomes)

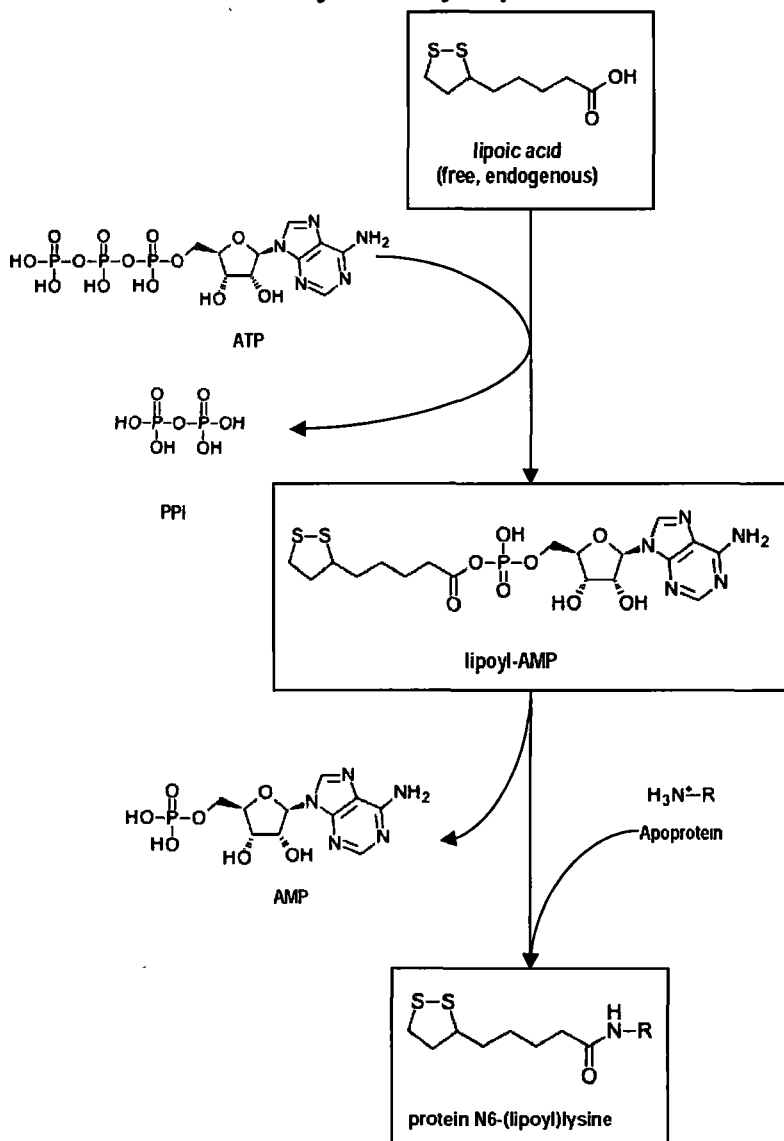

2.2.2 Manufactured α -Lipoic Acid

α -Lipoic acid is synthesized commercially through conventional processes widely used in the food industry (see section 3.0). As previously noted, racemic mixtures of *R*- and *S*-enantiomers (*dl*-forms) of α -lipoic acid are widely used in dietary supplements and have been extensively studied.

The material Hill's intends to use in canine foods (CAS RN 1077-28-7; *dl*- α -lipoic acid) is a racemic mixture produced by one or more qualified manufacturers in accordance with Good Manufacturing Practice (GMP) standards and within the specifications established by Hill's (see section 3.0).

3.0 MANUFACTURING AND QUALITY ASSURANCE

3.1 Manufacturing

(b) (4)



Figure 3-1 (b) (4) method for α -lipoic acid synthesis

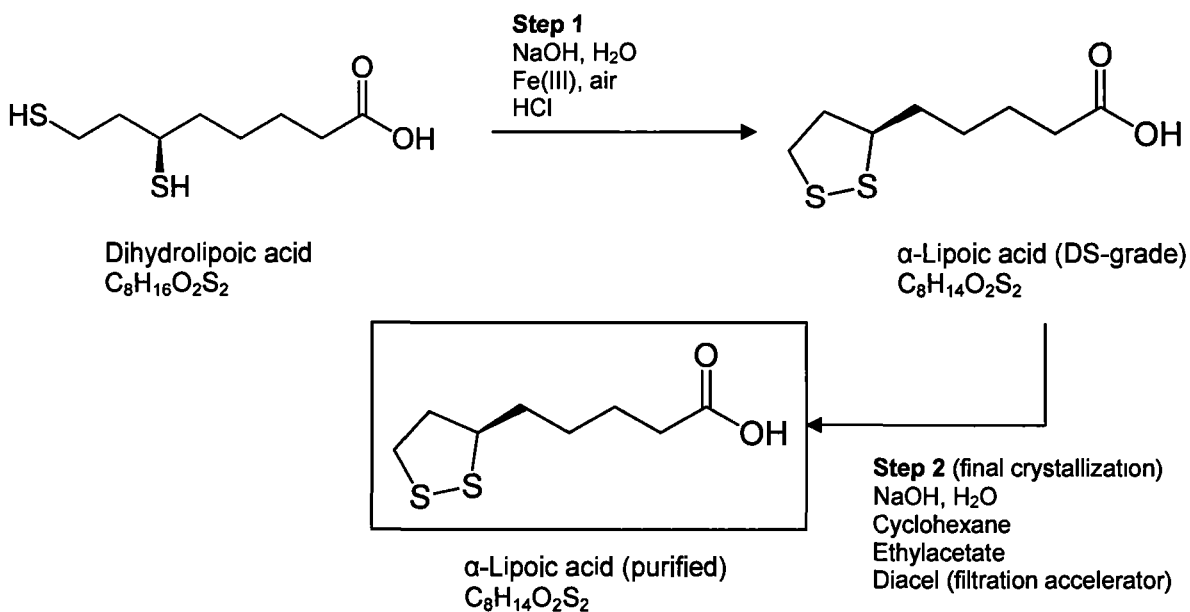

3.2 Specifications

Table 3-1 lists the critical elements of the specifications established by Hill's for the α -lipoic acid material to be used in canine foods. A copy of Hill's Ingredient Specification document is included in Appendix 1; specifications established by (b) (4) the intended supplier of α -lipoic acid to be used by Hill's, appear in Appendix 2. All suppliers will be required to provide certificates of analysis (COA) to demonstrate compliance with Hill's specifications. The methods used for production and purification of α -lipoic acid should be consistent with acceptable food-industry standards, and compliance with current good manufacturing practices (GMP) would be expected.

Table 3-1 Critical elements of Hill's specifications for α -lipoic acid used in canine foods

DEFINITION: Alpha-Lipoic Acid, $C_8H_{14}O_2S_2$, is a yellow crystalline powder. Alpha-Lipoic Acid has an international non-proprietary name (INN) of Thioctic Acid and a chemical name of 1,2-Dithiolane-3-pentanoic acid (*dl*-form). CAS No. 1077-28-7.

AAFCO REFERENCE: n/a

COUNTRY OF ORIGIN: Hill's-approved source locations

CERTIFICATE OF ANALYSIS REQUIRED:

Parameter	Min.	Target	Max.	European Reference Method	US Reference Method
Loss on drying (%)	-	-	≤ 0.2	Ph. Eur. 6.0 2.2.32	USP Monograph, Alpha Lipoic Acid
Residual Solvent, Cyclohexane (ppm)	-	-	≤ 1000	Ph. Eur. 6.0 2.2.28	USP General Chapter, Residual Solvents <467>
Residual Solvent, Ethyl acetate (ppm)	-	-	≤ 1000	Ph. Eur. 6.0 2.2.28	USP General Chapter, Residual Solvents <467>
Residual Solvent, Toluol (ppm)	-	-	≤ 50	Ph. Eur. 6.0 2.2.28	USP General Chapter, Residual Solvents <467>
HPLC – α -Lipoic Acid Assay (%)	97.0	-	102.0	Ph. Eur. 6.0 2.2.29	USP Monograph, Alpha Lipoic Acid

CHARACTERISTICS: TARGET AND RANGE

Parameter	Min.	Target	Max.	European Reference Method	US Reference Method
Melting Point Range (°C)	60.0	61.0	62.0	Ph. Eur. 6.0 2.2.14 or Ph. Eur. 6.0 2.2.15	USP Monograph, Alpha Lipoic Acid
Heavy Metals (ppm)	-	-	≤ 10	Ph. Eur. 2.4 8, Method C	USP Monograph, Alpha Lipoic Acid
β -lipoic acid (%)	-	-	≤ 0.10	Ph. Eur. 6.0 2.2.29	-
6,8-Epitrihiooctanoic acid (%)	-	-	≤ 0.1	Ph. Eur. 6.0 2.2.29	USP Monograph, Alpha Lipoic Acid
Single Unknown Purities (%)	-	-	≤ 0.10 each	Ph. Eur. 6.0 2.2.29	-
Sum of all Impurities (%)	-	-	≤ 0.3	Ph. Eur. 6.0 2 2.29	-
Polymers (%)	-	-	≤ 2	Ph. Eur. 6.0 2.2 2.7	USP Monograph, Alpha Lipoic Acid

PHYSICAL CHARACTERISTICS:

Grade:	n/a
Odor:	chemical, slightly sulfur
Particle Size:	Particle size and particle size distribution measurements are made by using either the Ro-Tap method (ASAE S319.4) or laser diffraction method. Ro-Tap Method: 90% through U.S. #20 sieve. Laser diffraction method: 50% <350 μm , 98% <950 μm .
Color:	Yellow, crystalline powder
Uniformity:	Uniform. Fresh material is devoid of clumps, however, material is susceptible to clumping during transportation.

PACKAGING: 50 kg drum

SHELF LIFE: 1 year if stored in a tightly-closed container in a dry, cool, and well-ventilated area, protected from light. Desired storage temperature ≤ 25 °C.

3.3 Quality and Stability

3.3.1 α -Lipoic Acid

Hill's will ensure that the quality of α -lipoic acid used in the intended dry foods is monitored during manufacturing using validated methods.

(b) (4) Hill's intended supplier, has provided results of stability testing for 3 lots of *dl*- α -lipoic acid stored for up to 9 months at 25 °C/60 % relative humidity and 30 °C/65 % relative humidity. The results of these analyses are summarized in Tables 3-2a and 3-2b, respectively. All parameters were within the established specifications at all time points tested.

3.3.2 α -Lipoic Acid in Canine Dry Food

Hill's has developed a method for measuring α -lipoic acid in extruded canine foods based on the published method of Witt and Rustow (1998). The method (SOP Number Version: LAB-RES-026.1), described fully in Appendix 5 involves reduction of lipoic acid to dihydrolipoic acid and labeling with monobromobimane, followed by separation and detection using HPLC with a fluorescence detector.

This method has been validated by the Hill's Science & Technology Center (Topeka, KS) and shown to be adequate for determination of lipoic acid in pet food products (see Appendix 6). The parameters characterized and the results of HPLC analysis of canine foods containing α -lipoic acid at various levels are provided in Appendix 7.

Table 3-2a Results of stability testing of 3 lots of (b) (4) dl- α -lipoic acid stored at 25 °C/60 % relative humidity

Parameter	Specification	Lot 708231				Lot 708331				Lot 708431			
		Initial test	Months			Initial test	Months			Initial test	Months		
			3	6	9		3	6	9		3	6	9
Description	Yellow, crystalline powder	Complies	Complies	Complies	Complies	Complies	Complies	Complies	Complies	Complies	Complies	Complies	Complies
Characteristics													
Solubility in 1M NaOH													
Clarity	≤ 3.0 FNU	0.6	0.5	0.5	0.6	0.4	0.3	0.4	0.7	0.6	0.6	0.7	0.7
Coloration	Slightly yellowish	Complies	Complies	Complies	Complies	Complies	Complies	Complies	Complies	Complies	Complies	Complies	Complies
Loss on drying	≤ 0.2 %	0.1	0.1	< 0.1	0.1	< 0.1	0.1	< 0.1	< 0.1	0.1	0.1	< 0.1	< 0.1
Purity													
Related substances (HPLC)													
β-Lipoic acid	≤ 0.10 %	< 0.05	< 0.05	< 0.05	< 0.05	< 0.05	< 0.05	< 0.05	0.05	< 0.05	< 0.05	< 0.05	< 0.05
6,8-Thioctic acid amide	≤ 0.10%	< 0.05	< 0.05	< 0.05	< 0.05	< 0.05	< 0.05	< 0.05	< 0.05	< 0.05	< 0.05	< 0.05	< 0.05
6,8-Epitrithio-octanoic acid	≤ 0.05 %	< 0.05	< 0.05	< 0.05	< 0.05	0.05	< 0.05	< 0.05	< 0.05	< 0.05	< 0.05	< 0.05	< 0.05
Unknown single impurities	each ≤ 0.10 %	Complies	Complies	Complies	Complies	Complies	Complies	Complies	Complies	Complies	Complies	Complies	Complies
Sum of all impurities	≤ 0.3 %	0.1	< 0.1	< 0.1	< 0.1	< 0.1	< 0.1	< 0.1	0.1	0.1	< 0.1	< 0.1	0.1
Polymers (GPC) ¹	≤ 1.0 %	0.5	0.1	0.5	0.4	0.5	0.3	0.6	0.5	0.5	0.1	0.2	0.4
Assay (HPLC)	97.0-102.0 %	99.1	100.1	99.0	98.7	99.2	100.2	99.1	98.5	99.1	100.1	99.1	98.2
Microbiological tests													
Yeast/Molds	≤ 10 ² CFU/g	Complies	-	-	-	Complies	-	-	-	Complies	-	-	-
Aerobic bacteria	≤ 10 ² CFU/g	Complies	-	-	-	Complies	-	-	-	Complies	-	-	-
<i>Escherichia coli</i>	absence in 1 g	Complies	-	-	-	Complies	-	-	-				

¹ Analytical method used by (b) (4) for polymer determination changed from gel permeation chromatography (GPC) to thin-layer chromatography (TLC) in December, 2007.

Samples were stored in scaled-down original packaging materials (75- μ m thickness PE bag inside plastic drum).

Table 3-2b Results of stability testing of 3 lots of (b) (4) α -lipoic acid stored at 30 °C/65 % relative humidity

Parameter	Specification	Lot 708231				Lot 708331				Lot 708431			
		Initial test	Months			Initial test	Months			Initial test	Months		
			3	6	9		3	6	9		3	6	9
Description	Yellow, crystalline powder	Complies	Complies	Complies	Complies	Complies	Complies	Complies	Complies	Complies	Complies	Complies	Complies
Characteristics													
Solubility in 1M NaOH													
Clarity	≤ 3.0 FNU	0.6	0.6	0.7	0.7	0.5	0.8	1.1	0.7	0.4	0.6	0.5	0.6
Coloration	Slightly yellowish	Complies	Complies	Complies	Complies	Complies	Complies	Complies	Complies	Complies	Complies	Complies	Complies
Loss on drying	≤ 0.2 %	0.1	0.1	< 0.1	< 0.1	0.1	0.1	< 0.1	< 0.1	0.1	0.1	< 0.1	< 0.1
Purity													
Related substances (HPLC)													
β-Lipoic acid	≤ 0.10 %	< 0.05	< 0.05	< 0.05	< 0.05	< 0.05	< 0.05	< 0.05	< 0.05	< 0.05	< 0.05	< 0.05	< 0.05
6,8-Thiooctic acid amide	≤ 0.10%	< 0.05	< 0.05	< 0.05	< 0.05	< 0.05	< 0.05	< 0.05	< 0.05	< 0.05	< 0.05	< 0.05	< 0.05
6,8-Epithio-octanoic acid	≤ 0.05 %	< 0.05	< 0.05	< 0.05	< 0.05	< 0.05	< 0.05	< 0.05	< 0.05	0.05	< 0.05	< 0.05	< 0.05
Unknown single impurities	each ≤ 0.10 %	Complies	Complies	Complies	Complies	Complies	Complies	Complies	Complies	Complies	Complies	Complies	Complies
Sum of all impurities	≤ 0.3 %	0.1	< 0.1	< 0.1	0.1	0.1	< 0.1	< 0.1	0.1	< 0.1	< 0.1	< 0.1	0.1
Polymers (GPC) ¹	≤ 1.0 %	0.5	0.1	0.2	0.4	0.4	0.2	0.5	0.5	0.4	0.2	0.3	0.4
Assay (HPLC)	97.0-102.0 %	99.1	100.1	99.1	98.2	98.9	99.9	98.8	98.0	99.2	99.9	98.4	97.2
Microbiological tests													
Yeast/Molds	≤ 10 ² CFU/g	Complies	-	-	-	Complies	-	-	-	Complies	-	-	-
Aerobic bacteria	≤ 10 ² CFU/g	Complies	-	-	-	Complies	-	-	-	Complies	-	-	-
<i>Escherichia coli</i>	absence in 1 g	Complies	-	-	-	Complies	-	-	-				

¹ Analytical method used by (b) (4) for polymer determination changed from gel permeation chromatography (GPC) to thin-layer chromatography (TLC) in December, 2007.

4.0 INTENDED USE OF α -LIPOIC ACID AND PROJECTED EXPOSURE

4.1 Intended Use

α -Lipoic acid is a substance synthesized and naturally present in the mitochondria of most organisms (including dogs of the genus *Canis*). Hill's intends to use α -lipoic acid in dry foods for adult dogs (*i.e.*, at least 1 year old) at levels up to 150 ppm (150 mg/kg food or 0.0150%). α -Lipoic acid would be used as a cellular antioxidant and cofactor of enzymes involved in the metabolism of carbohydrates and amino acids. In general, most healthy organisms are able to synthesize sufficient amounts of α -lipoic acid to meet the usual requirements and can also obtain small amounts from the diet. However, supplemental amounts may help maintain optimal mitochondrial function, which is known to decline with increasing age, is subject to oxidative stress, and affects not only cellular metabolism and bioenergetics, but also cell differentiation, cell death, and various other processes.

α -Lipoic acid's multiple roles in biological systems are discussed in section 5.0 of the present document.

4.2 Estimated Exposure

α -Lipoic acid is intended to be used in dry canine foods at levels up to 150 ppm (150 mg/kg food or 0.0150%). As illustrated in Table 4-1, this level of use is the lowest target inclusion rate of 150 ppm (145 ppm as-fed or 157 ppm dry matter) used in a 1-year safety study in dogs, which resulted in an α -lipoic acid intake of approximately 2.5 mg/kg bw/day (see Appendix 8) and, at Day 84, was associated with a statistically significant increase from baseline in the glutathione:oxidized glutathione (GSH:GSSG) ratio of mononuclear cells (Zicker *et al.*, 2002). The safety data might support higher α -lipoic acid intakes (*e.g.*, 26 mg/kg bw/day based on the lack of adverse effects in dogs receiving 1500 ppm in the diet for 1 year). However, 150 ppm α -lipoic acid was selected as an inclusion rate for adult dog dry foods that would provide reasonable certainty that no harm will result, and would be expected to provide some health benefit (*e.g.*, enhancing GSH efficiency).

Table 4-1 Estimates of α-lipoic acid exposure during safety studies

Species	NOAEL	Duration of exposure	Route of exposure	Level of α-lipoic acid exposure		
				ppm (diet)	mg/day	mg/kg bw/day
Dog ¹	82 mg/kg bw/day ^a	up to 1 year	Diet	4500 ^b (1260 µg/kcal)	1197	82
				3000 ^b (840 µg/kcal)	792	53
				1500 ^b (420 µg/kcal)	435	26
				150 ^b (42 µg/kcal)	41	2.5
Rat ² (Wistar)	61.9 mg/kg bw/day	4 weeks	Oral gavage	Not applicable	M: 13 ^c F: 10 ^c	61.9
Rat ³ (SD)	60 mg/kg bw/day	2 years	Diet	M: 872 ^d F: 751 ^d	M: 31 ^d F: 20 ^d	60

NOAEL, no-observable-adverse-effect level; M: male; F: female

^aWeight loss and leukocytosis observed in 1 dog in the 4500 ppm group was not considered related to α-lipoic acid administration.

^bValues as presented are target inclusion levels; actual mean levels were 4138, 2803, 1426, and 145 on an as-fed basis and 4505, 3044, 1548, and 157 on a dry matter basis (see Appendix 8).

^cEstimate based on Wistar rat default body weight (M: 0.217 kg, F: 0.156 kg) values in subchronic study (U.S. EPA 1988).

^dEstimate based on SD rat default body weight (M: 0.523 kg, F: 0.338 kg) and food intake (M: 0.036 kg/day; F: 0.027 kg/day) values in chronic study (U.S. EPA 1988), incorporation rate (mg/kg food or ppm) required to achieve intakes of 60 mg/kg bw/day were estimated from mg/day estimates (e.g., 31.38 mg/day ÷ 0.036 kg food/day = 871.67 mg/kg food or ppm).

¹Zicker *et al.* (2002) published 6-month interim findings; 1-year data unpublished.

²Cremer *et al.* (2006a)

³Cremer *et al.* (2006b)

Table 4-2 provides estimates of the projected α-lipoic acid exposure among adult dogs from small breeds (e.g., Chihuahua) to large breeds (e.g., American bulldog or Labrador Retriever) based on food average consumption values and estimates. The highest exposures resulting from 150 ppm in the diet (42 µg/kcal) would be in dogs from small breeds; for example, 3.8 mg/kg bw/day for a dog weighing 2.3 kg (5 lb) that consumes 0.059 kg (59 g) food per day [(150 x 0.059)/2.3]. An average, medium-sized dog weighing 18 kg and consuming 0.281 kg/day of food would be exposed to approximately 2.3 mg α-lipoic acid/kg bw/day, comparable to intakes from 150 ppm in the 1-year dog study (i.e., 2.5 mg α-lipoic acid/kg bw/day). Exposure among large-breed dogs would be lower (e.g., 1.8 mg/kg bw/day in a 45.4-kg dog). However, it is important to note that exposure to α-lipoic acid is self-limiting across body sizes because the amount of α-lipoic acid/kcal will be constant in the diet (~42 µg/kcal), and all species self-regulate food intake based on the calories needed for maintenance, i.e., the conditions under which this product will be fed.

Table 4-2 Projected α -lipoic acid intakes among dogs based on normal food consumption estimates

Body weight		Food intake	α -Lipoic acid intake
kg	lb	g/day	mg/kg bw/day
2.3	5	59	3.8
4.5	10	99	3.3
9.1	20	167	2.8
18.1	40	281	2.3
27.2	60	381	2.1
36.3	80	473	2.0
45.4	100	559	1.8

Based on inclusion of α -lipoic acid at 150 ppm in canine food (150 mg/kg food or approximately 42 μ g/kcal). α -Lipoic acid intake calculated using the following equation: [food intake (g/day) \div body weight (kg)] \times 0.150. To determine μ g α -lipoic acid/kcal, divide α -lipoic acid intake (in mg/kg/day) by the caloric intake (per kg bw/day) \times 1000. Calculate the α -lipoic acid intake/kg bw as described. Then calculate caloric intake/kg bw from food intake (g)/day divided by bw (kg) \times 3.53 (kcal/g diet).

5.0 BIOLOGICAL ACTIVITY OF α -LIPOIC ACID

As discussed previously, α -lipoic acid is a substance synthesized endogenously by plants, mammals, and some microorganisms. In general, most healthy organisms are able to synthesize sufficient amounts of α -lipoic acid to meet the usual requirements and can also obtain small amounts from the diet. However, supplemental amounts may help maintain optimal mitochondrial function, which is known to decline with increasing age, is subject to oxidative stress, and affects not only cellular metabolism and bioenergetics, but also cell differentiation, cell death, and various other processes.

The following sections discuss in greater detail α -lipoic acid's multiple roles in biological systems.

5.1 α -Lipoic Acid as a Cellular Antioxidant

The available evidence suggests a complex interplay between aging, oxidative stress, and mitochondrial DNA (mtDNA) damage. Oxidative stress is believed to be the result of an imbalance between the production of reactive oxygen species (ROS) and their elimination (*i.e.*, deactivation) by antioxidants. ROS such as hydrogen peroxide (H₂O₂), hydroxyl radical (OH[•]), and superoxide (O₂⁻) are by-products of normal cellular respiration, with the potential to damage proteins, lipids, and nucleic acids. In order to minimize such damage, aerobic cells rely on multiple antioxidants such as α -tocopherol, coenzyme Q10, glutathione (GSH), and enzymes such as manganese superoxide dismutase (MnSOD) and catalase (Harman, 1972; Chance *et al.*, 1979; Sohal and Sohal, 1991; Halliwell, 1993; Gutteridge, 1994; Sohal *et al.*, 1995; Kwong and Sohal, 1998; Papa and Skulachev, 1997; Miquel, 1998; Perez-Campo *et al.*, 1998; Sastre *et al.*, 2000; Lin and Beal, 2006; Singh and Jialal, 2008). However, these defenses have been reported to decline with increasing age in multiple animal species.

The potential benefits of α -lipoic acid supplementation on age-associated cognitive decline (Hagen *et al.*, 1999, 2002; Hager *et al.*, 2001; Liu *et al.*, 2002; Farr *et al.*, 2003; Milgram *et al.*, 2005; Liu, 2008), glucose utilization, insulin sensitivity, and other factors affected by diabetes mellitus have been investigated in humans and other animal species (Reviewed by Singh and Jialal, 2008). However, the present discussion is limited to α -lipoic acid's possible role as a cellular antioxidant.

α -Lipoic acid acts as an antioxidant, and has been shown to recycle/renew and prolong the lifespan of endogenous mitochondrial antioxidant defenses such as vitamins C and E, and glutathione (GSH), which themselves become oxidized and lose their antioxidant function in the process of eliminating ROS (Diaz-Cruz *et al.*, 2003). As the schematic in Figure 5-1 illustrates, α -lipoic acid relies on reduced coenzymes generated by cytosolic glucose oxidation and a dehydro lipoic acid/lipoic acid redox couple to recycle oxidized antioxidants to their native and functional forms. α -Lipoic acid has also been reported to bind to metals that contribute to the production of ROS and to directly scavenge ROS (Singh and Jialal, 2008).

In experimental animals, *dl*- α -lipoic acid has been shown to help maintain antioxidant defenses (Arivazhagan *et al.*, 2001; Liu *et al.*, 2002; Zicker *et al.*, 2002; Milgram *et al.*, 2004, 2005, 2007). For example, administration of 100 mg/kg bw/day of *dl*- α -lipoic acid by intraperitoneal injection to aged Wistar rats (age > 22 months) for up to 14 days restored the levels of hepatic and renal lipid peroxidation, GSH, vitamin C, vitamin E, and various other mitochondrial enzymes to levels that were comparable to those of young (3- to 4-month-old) rats (Arivazhagan *et al.*, 2001).

In adult dogs, administration of *dl*- α -lipoic acid coextruded in the food at the rates of 150, 1500, 3000, or 4500 ppm (2.5, 26, 53, or 82 mg/kg bw/day, respectively) for 3 months was associated with an increase from baseline in the glutathione (reduced):glutathione (oxidized) (GSH:GSSG) ratio of mononuclear cells, compared to the control (Zicker *et al.*, 2002). A low GSH:GSSG ratio is considered a marker of oxidative stress.

Paetau-Robinson *et al.* (2008) examined the effect of an experimental food with lipoic acid and enhanced vitamin E and C levels, and 3 commercially-available foods, on the antioxidant status and DNA integrity of geriatric dogs. Forty beagle dogs (age \geq 10 years) were randomly assigned to receive 1 of the 4 foods for 90 days: experimental food (136 ppm lipoic acid; 127 ppm vitamin C; and 1492 IU/kg vitamin E); or commercial foods A (288 ppm vitamin C, 594 IU/kg vitamin E), B (86 ppm vitamin C, 894 IU/kg vitamin E), or C (21 ppm vitamin C, 421 IU/kg vitamin E). Blood samples were collected at baseline, Day 30, and Day 90 and analyzed for antioxidant status: serum vitamin E; serum glutathione peroxidase (GSH-Px) activity; and plasma malondialdehyde (MDA), the latter a measure of lipid peroxidation and oxidative stress. White blood cells were isolated and subjected to H₂O₂ challenge and the Comet assay to assess susceptibility of DNA to oxidative stress. A summary of the results for the antioxidant status measures is provided in

Table 5-1; data were analyzed only for differences between the experimental group and each of the commercial diets.

The results showed that serum GSH-Px and vitamin E, and plasma MDA levels were comparable among all groups, except for the following:

At Day 90, dogs receiving the experimental food had higher GSH-Px levels than dogs receiving commercial foods A and B; the difference was marginally significant ($p=0.05$) only vs. food B.

At both Day 30 and Day 90, vitamin E levels were higher among dogs receiving the experimental food than in dogs receiving food C; this difference reached statistical significance ($p\leq 0.01$) only at Day 30, however.

At both Day 30 and Day 90, the mean plasma MDA concentration of dogs receiving commercial food B was much lower than that of all other groups; at Day 30, the difference from the experimental food group was statistically significant ($p\leq 0.01$). However, with the exception of food B, at Day 90, MDA levels were lowest in dogs fed the experimental food; the difference was statistically significant ($p\leq 0.01$) only when compared to food C.

DNA damage following oxidative challenge was significantly lower in white blood cells from dogs given the experimental food, indicated by a higher percentage of head DNA, compared to foods A ($p=0.03$) and C ($p=0.04$) at Day 30.

The authors concluded based on these findings that food supplemented with vitamins E and C, and lipoic acid, help maintain the antioxidant status of geriatric dogs, based on objective biomarkers of antioxidant status and oxidative stress.

Figure 5-1 Schematic overview of the role of α -lipoic acid (LA) in maintaining endogenous antioxidant defenses

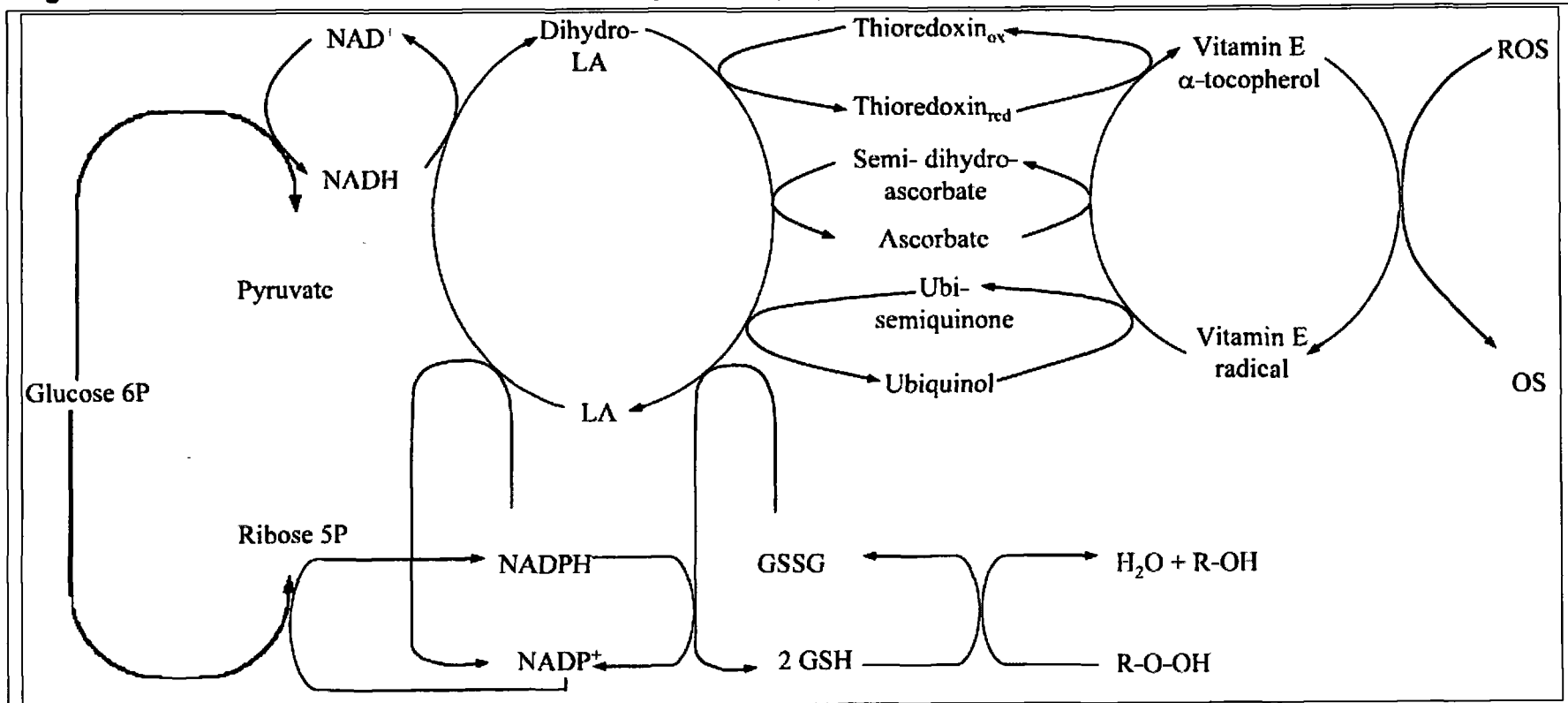

Pivotal role of lipoic acid (LA), which uses reduced coenzymes generated by cytosolic glucose oxidation to recycle oxidized antioxidants. The reaction of an antioxidant (vitamin E, vitamin C, reduced glutathione (GSH)) and a reactive oxygen species (ROS) (or H₂O₂) eliminates ROS (or H₂O₂), but the antioxidant is converted into a product no longer able to function. This oxidized product is regenerated to its native form to function again via the dehydro LA/LA redox couple OS, oxygen species: GSSG, oxidized glutathione; NAD, nicotinamide adenine dinucleotide (oxidized); NADH, nicotinamide adenine dinucleotide (reduced); NADP, nicotinamide adenine dinucleotide phosphate (oxidized); NADPH, nicotinamide adenine dinucleotide phosphate (reduced).

Source: Díaz-Cruz *et al.* (2003)

Table 5-1 Antioxidant markers measured at Day 30 and Day 90 in the blood of dogs receiving each of 4 different foods

Marker	Day 30				Day 90			
	Experimental food	Commercial food A	Commercial food B	Commercial food C	Experimental food	Commercial food A	Commercial food B	Commercial food C
Serum GHS-Px ($\mu\text{g}/10_6$)	5.85	5.68	5.68	5.96	5.09	4.83	4.82*	5.11
Serum vitamin E ($\mu\text{g}/\text{mL}$)	39.4	40.7	39.6	31.4**	40.7	43.1	40.6	33.0
Plasma MDA (μM)	1.12	1.02	0.67**	1.20	1.05	1.22	0.87	1.34**

Experimental food: 136 ppm lipoic acid, 127 ppm vitamin C, and 1492 IU/kg vitamin E

Commercial foods: A (288 ppm vitamin C, 594 IU/kg vitamin E); B (86 ppm vitamin C, 894 IU/kg vitamin E); C (21 ppm vitamin C, 421 IU/kg vitamin E)

* $p=0.05$ (vs. experimental food)

** $p\leq 0.01$ (vs. experimental food)

5.2 α -Lipoic Acid as an Enzyme Cofactor

As discussed previously, in living cells, α -lipoic acid is present as lipoyllysine, covalently-linked to the ϵ -amino group of a specific lysine residue of a target protein. Target proteins include: the E₂ subunit of each pyruvate dehydrogenase (PDH) and ketoglutarate dehydrogenase (KGDH); the H-protein of the glycine cleavage system; and the branched-chain keto acid dehydrogenase (Fujiwara *et al.*, 1994; Reed, 2001). These enzymes and the reactions they mediate are listed in Table 5-2.

Table 5-2 Enzyme systems that require α -lipoic acid for normal function

Enzyme Complex	Reaction
Pyruvate dehydrogenase (PDH)	Conversion of pyruvate to acetyl-coenzyme A (CoA), a citric acid cycle intermediate
α -Ketoglutarate dehydrogenase (KGDH)	Conversion of α -ketoglutarate to succinyl CoA, a citric acid cycle intermediate
Branched-chain keto acid dehydrogenase	Extrahepatic catabolism of the branched-chain amino acids leucine, isoleucine, and valine (primarily in muscle, adipose, kidney, and brain tissues)
Glycine cleavage system (H-protein)	Catabolism of glycine to form 5,10-methylene tetrahydrofolate, a cofactor of nucleic acid synthesis

The metabolic pathways in which α -lipoic acid is involved are shown schematically in Figures 5-2, 5-3, and 5-4. These pathways generate energy *via* oxidation of carbohydrates and fatty acids, and are highly conserved across species. Genes encoding citric acid cycle components, for example, show a high degree of homology; the nucleotide sequence for the E₂ subunit of PDH in dogs, chimpanzees, and cows is more than 90% similar to that of humans⁴.

⁴ Source: Orthologs for pyruvate dehydrogenase complex component E₂ (dihydrolipoamide S-acetyltransferase or DLAT) gene obtained through *The GeneCards Human Gene Database*, accessed online through <http://www.genecards.org> in September, 2010.

Figure 5-2 Schematic overview of α -lipoic acid's function (bound to E₂ subunit of PDH and KGDH) in the citric acid cycle

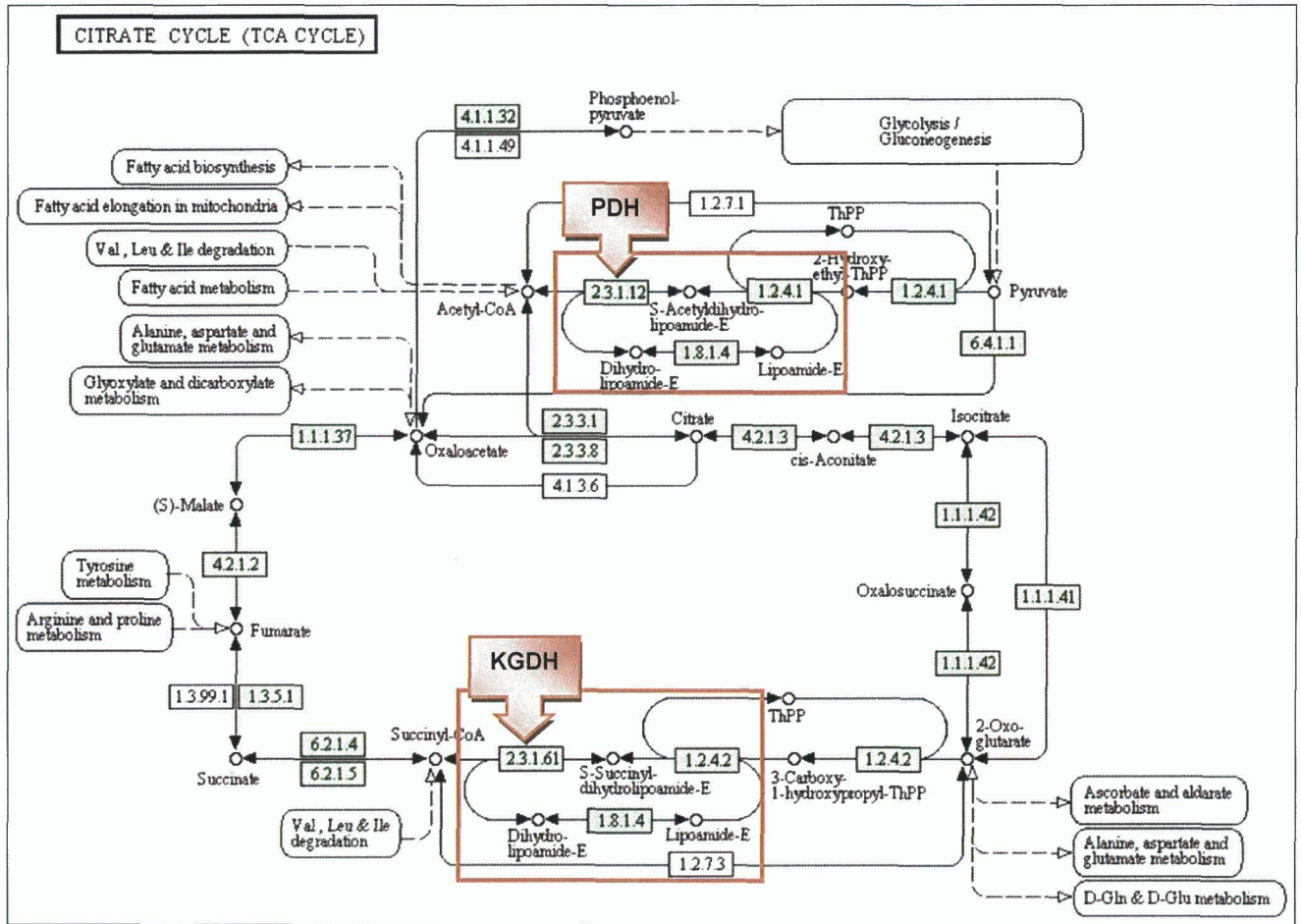

The citrate cycle (TCA cycle, Krebs cycle) is an important aerobic pathway for the final steps of the oxidation of carbohydrates and fatty acids. The cycle starts with acetyl-CoA, the activated form of acetate, derived from glycolysis and pyruvate oxidation for carbohydrates and from beta oxidation of fatty acids. The two-carbon acetyl group in acetyl-CoA is transferred to the four-carbon compound of oxaloacetate to form the six-carbon compound of citrate. In a series of reactions two carbons in citrate are oxidized to CO₂ and the reaction pathway supplies NADH for use in the oxidative phosphorylation and other metabolic processes. The pathway also supplies important precursor metabolites including 2-oxoglutarate. At the end of the cycle the remaining four-carbon part is transformed back to oxaloacetate. According to the genome sequence data, many organisms seem to lack genes for the full cycle, but contain genes for specific segments.

Source: Kyoto Encyclopedia of Genes and Genomes (KEGG) PATHWAY Database: Pathway for *Canis familiaris* (dog) accessed online through <http://www.genome.jp/kegg> in September-October, 2010.

Figure 5-3 Schematic overview of α-lipoic acid's function (bound to the H protein of the glycine cleavage system) in the catabolism of glycine, serine, and threonine

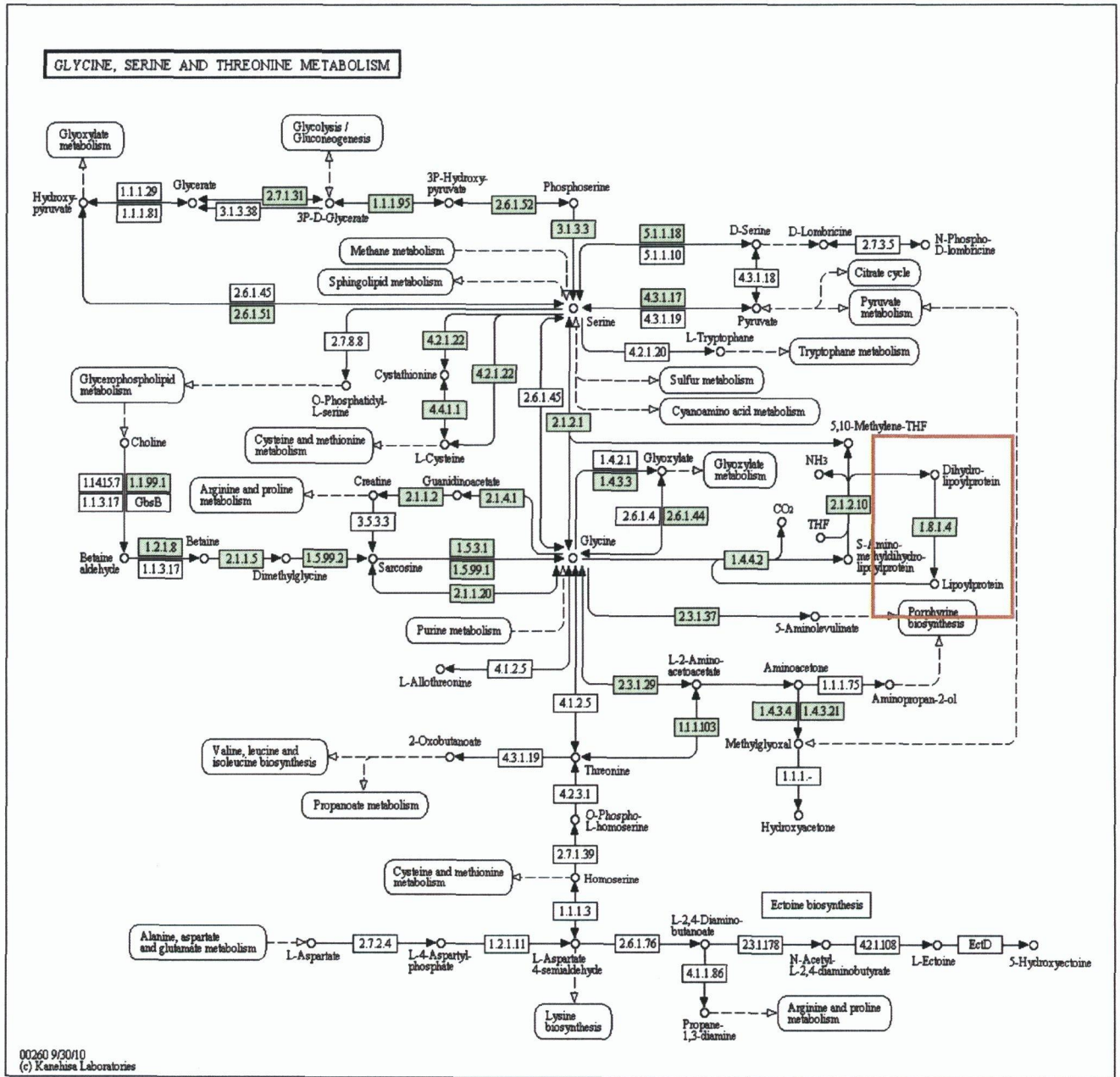

Source: Kyoto Encyclopedia of Genes and Genomes (KEGG) PATHWAY Database: Pathway for *Canis familiaris* (dog) accessed online through <http://www.genome.jp/kegg> in September-October, 2010.

Figure 5-4 Schematic overview of α -lipoic acid's function (bound to branched-chain keto acid dehydrogenase) in the catabolism of branched-chain amino acids

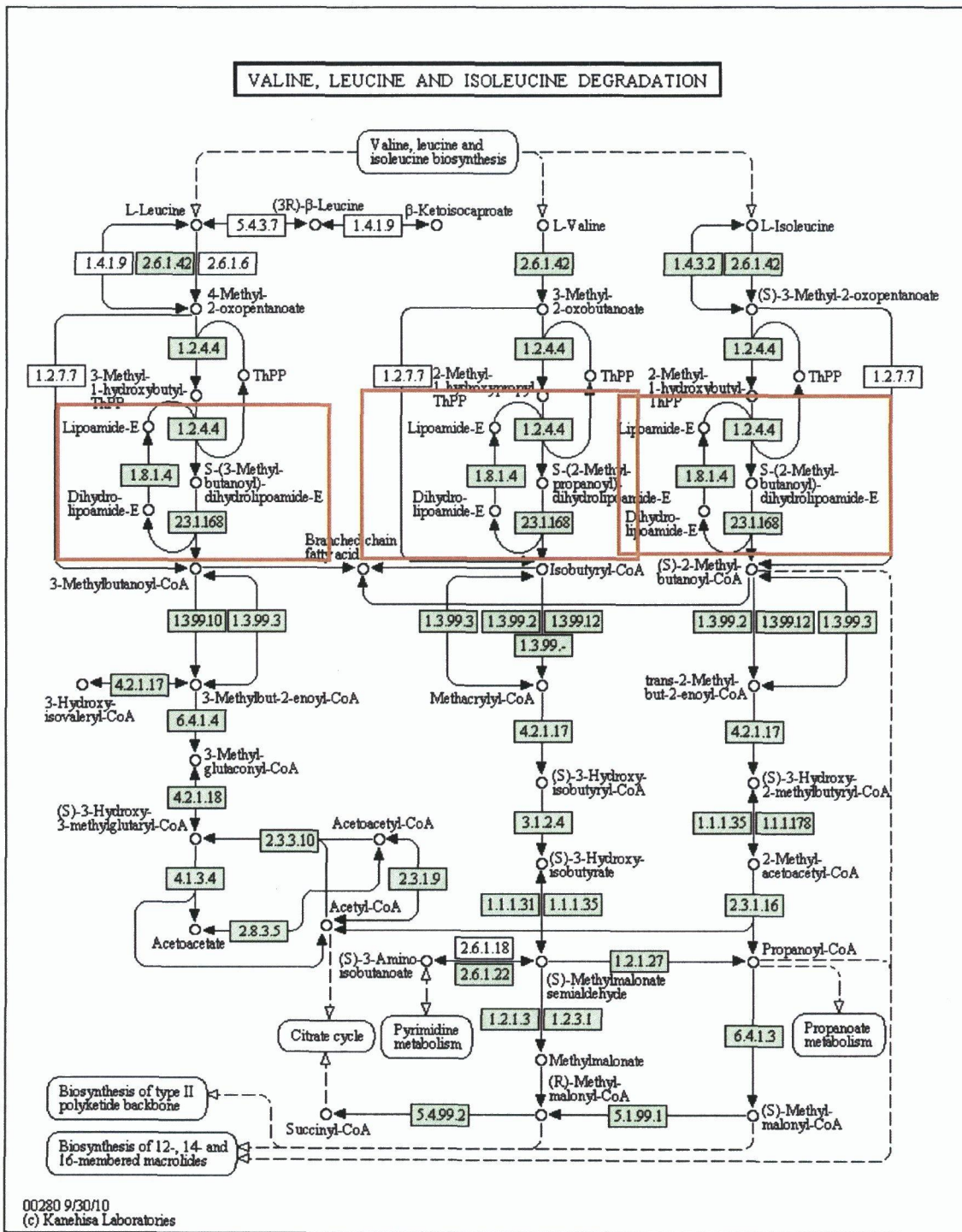

Source: Kyoto Encyclopedia of Genes and Genomes (KEGG) PATHWAY Database: Pathway for *Canis familiaris* (dog) accessed online through <http://www.genome.jp/kegg> in September-October, 2010.

When bound to the E₂ subunit of PDH and KGDH, α-lipoic acid forms a long (~14 Å), flexible arm ("swinging arm") that acts as a tether to move intermediates (hydrogen or acetyl/acyl group) from the active site of one enzyme in the complex to the active site of another (Reed, 2001; Lehninger, 2005). The schematic in Figure 5-5 provides an overview of the sequence.

Figure 5-5 Schematic of lipoyllysine's role in the transport of intermediates (hydrogen or acetyl/acyl group) along PDH and KGDH enzyme active sites

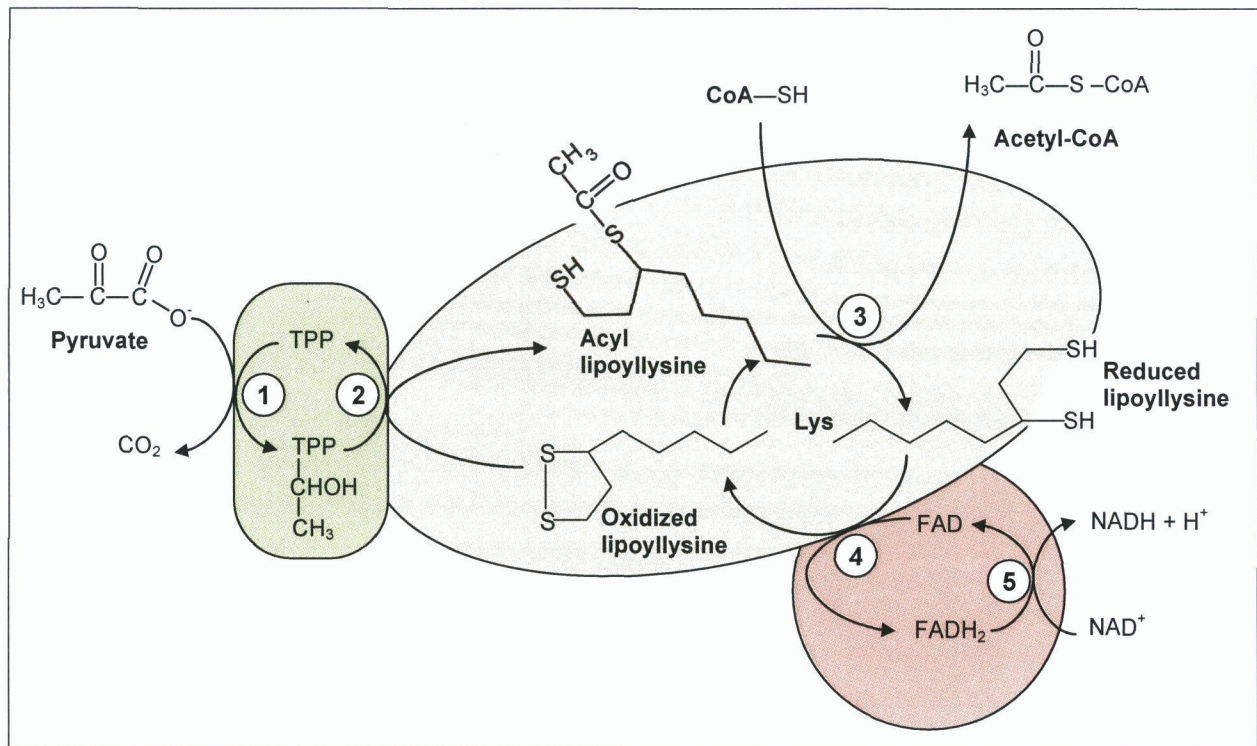

(1) reductive acylation of the pyruvate-derived hydroxyethyl chain; (2) oxidation and attachment of the acyl group to the lipoyl moiety; (3) transfer of the acetyl group to CoA; and (4) reoxidation of the lipoyllysine residue with reduction of FAD to FADH₂ followed by (5) reduction of NAD⁺ to NADH and reentry into the cycle.

Adapted from Lehninger (2005).

5.3 α -Lipoic Acid's Other Functions

5.3.1 Nutritive Value

α -Lipoic acid is defined in some relevant textbooks as a nutrient. A straightforward definition of *nutrient* from the Small Animal Clinical Nutrition textbook is that a nutrient is any food constituent that helps support life (Gross *et al.*, 2010). Dorland's Medical Dictionary defines *nutrient* as a food or other substance that provides energy or building material for the survival and growth of a living organism (Dorland's Illustrated Medical Dictionary, 2003). The AAFCO 2010 Official Publication defines *nutrient* as "a feed constituent in a form and at a level that will help support the life of an animal" (AAFCO, 2010). Indeed, Dr. Bruce Ames characterized α -lipoic acid as a "conditional micronutrient" (Ames, 1998).

α -Lipoic acid can also be considered a substance offering *nutritive value*. In CFR 21 Part 101.14(a)(3), FDA has defined *nutritive value* as a "value in sustaining human existence by such processes as promoting growth, replacing loss of essential nutrients, or providing energy." Initially, in the human food context, only ingredients such as vitamins and minerals were considered by FDA to fit the definition of *nutritive value*. However, given the progression and evolution of science and new perspectives regarding nutrition, the concept and definition of *nutritive value* has also evolved. For instance, FDA has agreed to health claims for phytosterols added to conventional foods (*e.g.*, margarine) and reduced risk of coronary heart disease on the basis of *nutritive value* (65 FR 54686 at 54739). In addition to the definition in §101.14(a)(3), FDA considered a broader definition described in the final rule on health claims for dietary supplements (50 FR 395 at 407), which states that:

"...The agency's broad definition of 'nutritive value' includes assisting in the efficient functioning of classical nutritional processes and of other metabolic processes necessary for the normal maintenance of human existence. Dietary fiber, for example, helps to assure normal intestinal transit time, thereby providing nutritional value by promoting efficient bowel function. Vitamin E provides nutritive value through its antioxidant function of reduction of cell damage."

In this context, the utility of α -lipoic acid in dry dog food would be similar to that of L-carnitine, which, while not recognized as an essential nutrient *per se* since it is synthesized endogenously, is considered to provide nutritive value based on its role as an essential factor in lipid metabolism. Similar to L-carnitine, α -lipoic acid is an essential cofactor of multiple mitochondrial enzyme complexes, and supplemental amounts would be expected to help maintain optimal mitochondrial function.

5.3.2 Maintenance of Mitochondrial Structure and Function

The basic structural unit of all living organisms, the cell, is a dynamic entity that, even as part of a collective (*i.e.*, tissue or organ), remains largely autonomous. In multicellular organisms, careful orchestration of cell proliferation, cell differentiation, and cell death is fundamental to survival. As regulators of cell survival, cell death, and several other critical cellular processes, mitochondria have a pivotal role in maintaining this balance.

The mitochondrion is the center of cellular metabolism and bioenergetics, where respiration (*via* the electron transport chain), the citric acid cycle, fatty acid oxidation, glycolysis, oxidative phosphorylation, and various other reactions essential for survival of the organism occur (Scheffler, 2000; McBride *et al.*, 2006). Mitochondria are also involved in several other cellular functions, including signaling cascades, cellular differentiation, cell death, as well as control of the cell cycle and cell growth (Scheffler, 2000; Lin and Beal, 2006; McBride *et al.*, 2006). Due to this broad range of functions, mitochondrial deficiencies or dysfunction have far-reaching implications, as discussed in subsequent sections.

5.3.2.1 *Aging and Declining Mitochondrial Function*

Mitochondria are thought to play a critical role in aging. Specifically, the decline in mitochondrial function that results from accumulation of damage to critical components with age has been implicated in the aging process and diseases associated with aging, such as cancer and neurodegenerative diseases (*e.g.*, Alzheimer's disease, Parkinson's disease) (Scheffler, 2000; Golden, 2006; Lin and Beal, 2006). Increased oxidative damage and mitochondrial dysfunction have also been linked to cognitive deficits in aging non-human animals (Arivazhagan *et al.*, 2001; Liu *et al.*, 2002; Milgram *et al.*, 2004, 2005, 2007).

Several studies examining the effects of a diet containing α -lipoic acid in combination with other nutrients on the cognitive function and/or behavior of dogs have been published. For example, when combined with other nutrients such as L-carnitine, oral administration of *dl*- α -lipoic acid (120-125 ppm in the diet or 11 mg/kg/day as a capsule) for up to 2 years was reported to maintain cognitive function in aged (8.05 to 12.04 years) beagle dogs (Milgram *et al.*, 2004, 2005, 2007). Similar effects were noted in aged rats exhibiting cognitive deficits in both spatial and temporal memory (Liu *et al.*, 2002). Some of these studies are included in section 8.0 as supportive evidence of the safety of *dl*- α -lipoic acid.

5.3.2.2 *Genetic Mitochondrial Disorders*

There are several disorders in humans and other animals that have been linked to impaired mitochondrial function (*e.g.*, Charcot-Marie Tooth Type 2A disease and optic atrophy in humans; myopathy/cardiomyopathy in dogs), many of which involve tissues with high energy demands such as the brain, and cardiac and skeletal muscle.

5.3.2.2.1 Humans

A number of human disorders have been linked to mutations (deletions, duplications, *etc.*) in genes encoding mitochondrial components. Although nuclear and/or mitochondrial DNA (mtDNA) may be affected, mtDNA mutations occur about 10 times more frequently than nuclear DNA mutations and are more likely to affect coding DNA sequences due to the absence of introns (noncoding regions) (reviewed by Barker and Barasi, 2003). Gene mutations affecting mitochondrial function can have severe consequences. In humans, mutations in the gene encoding Mfn2 result in the disease Charcot-Marie Tooth Type 2A, characterized by a loss of peripheral motor neurons, and mutations in Opa1 are responsible for autosomal dominant optic atrophy, causing progressive blindness (Alexander *et al.*, 2000; Delettre *et al.*, 2000; Scheffler, 2000; Kijima *et al.*, 2005; Lin and Beal, 2006).

5.3.2.2.2 Other Animals

Genetic defects affecting mitochondrial function in domestic animals are not as well-characterized, although several case reports of canine mitochondrial myopathy have been published in the scientific literature (Breitschwerdt *et al.*, 1992; De Vivo, 1993; Vijayasarathy *et al.*, 1994; Olby *et al.*, 1997; Gruber *et al.*, 2002; Paciello *et al.*, 2003; Tauro *et al.*, 2008; Baranowska *et al.*, 2009). The majority of these cases are attributed to alteration of ATP production due to diminished activity of the mitochondrial respiratory chain (Ghadially, 1997; Baranowska *et al.*, 2009).

Clinical signs observed in dogs with mitochondrial defects in skeletal muscle include severe exercise intolerance, abnormal gait, and exercise-induced metabolic acidosis. Dogs with dilated cardiomyopathy (DCM), a myocardial disease characterized by ventricular dilation and reduced cardiac function, have also been found to have altered expression of several mitochondrial proteins involved in energy production, oxidative metabolism, and antioxidant defense (Lopes *et al.*, 2006). Proteins whose expression was reduced (by 2-fold or greater) included malate dehydrogenase and cytochrome P₄₅₀, which are involved in primary energy function; pyruvate dehydrogenase E₁ α -subunit and steroidogenic acute regulatory (STAR) protein, associated with metabolism; and the signaling A-kinase anchor protein. Reduced expression of malate dehydrogenase, an enzyme that produces the reduced form of nicotinamide adenine dinucleotide that is channeled to complex I and used in the electron transport chain, suggests DCM may be associated with compromised electron transfer. Proteins with increased expression included the antioxidant manganese superoxide dismutase (MnSOD), 50S ribosomal L22 protein, involved in DNA and RNA protein synthesis, and 3-hexaprenyl-4, 5-dihydroxybenzoate methyltransferase (COQ₃), associated with protein targeting. The upregulation of MnSOD suggests that reactive oxygen species are increased, which might result in impaired mitochondrial function.

6.0 UPTAKE, METABOLISM, AND ELIMINATION OF *dl*- α -LIPOIC ACID

Schupke *et al.* (2001) analyzed the metabolism of *dl*- α -lipoic acid in mice, rats, and dogs. ¹⁴C-Radiolabeled *dl*- α -lipoic acid was administered to male NMRI mice and male Wistar rats as a single oral (gavage) dose of 30 mg/kg bw; beagle dogs received a single dose of 10 mg/kg bw by gastric lavage and, after a 7-week washout period, intravenously. Samples of plasma, urine, and feces were obtained and analyzed for radioactivity followed by HPLC.

As Table 6-1 shows, administration of *dl*- α -lipoic acid as a single oral dose to mice, rats, and dogs resulted in rapid excretion of radioactivity in the urine; more than half of the dose was excreted during the first 24 hours, suggesting extensive first-pass metabolism. α -Lipoic acid was not detected in the urine of any of the species tested; it was, however, the major fraction in fecal samples, 14, 17, and 11% of the dose administered to mice, rats, and dogs, respectively. The results of plasma radiolabel analyses are summarized in Table 6-2.

Table 6-1 Mean radiolabel in urine (0-24 hours) of the mouse, rat, and dog following oral (gavage) administration of [¹⁴C] α -lipoic acid as a single dose

Species	Oral dose (mg/kg bw)	Number of animals (males)	Total dose excreted (%)	Dose per metabolite fraction identified (%)								Sum of others
				M1	M2	M3	M4	M5	M7	M9	M10	
Mouse	30	15	54.7 ± 12.7	2.9	1.3	1.0	-	4.8	5.2	9.9	1.5	28.1
Rat	30	20	71.8 ± 9.4	2.2	1.0	2.3	5.8	12.2	-	5.8	-	42.5
Dog	10	3	63.5 ± 7.3	9.1	5.2	11.1	-	1.4	-	1.9	-	34.8

Source: Schupke *et al.*, 2001

Analysis of plasma and urine samples showed that *dl*- α -lipoic acid is extensively metabolized. The main metabolites of *dl*- α -lipoic acid are shown in Figure 6-1. Bisnorlipoic acid, derived from 3-keto-lipoic acid (M12), is a major product of β -oxidation of the *dl*- α -lipoic acid side chain. Bisnorlipoic acid is then metabolized to various products through further β -oxidation of the side chain, methylation of the 1,2-dithiolane moiety and subsequent oxidation, with slight differences among animal species in the predominant pathway. Dogs, for example, appear to have a more strongly pronounced ability than mice or rats to undergo sequential β -oxidation to form tetranorlipoic acid (M6) and its breakdown products (M10, M1, M2, and M3). As the data from Table 6-2 illustrate, in dogs, radiolabeled tetranorlipoic acid appeared at levels comparable to lipoic acid within 5 minutes after intravenous administration and was the primary product 10 minutes later. In mice, glycine conjugation of bisnorlipoic acid (M7) competes with β -oxidation.

Table 6-2 Mean radiolabel in plasma following administration of [¹⁴C]α-lipoic acid to rats at 30 mg/kg bw orally (gavage) and dogs at 10 mg/kg bw orally (gavage) and intravenously (i.v.)

Species	Number of animals (males)	Sampling point (hours)	[¹⁴ C] recovery (% of dose) ^a	Relative amounts of % of radioactivity ^b							Sum of others
				M3	M6	M8	M10	M11	M12	Lipoic acid	
Rat, oral	2	1	2.9	-	-	27.0	-	29.7	10.9	-	32.4
		3	1.7	-	-	29.1	-	34.4	6.2	-	30.3
Dog, oral	3	1	4.8	-	13.9	19.3	19.7	-	-	-	47.1
		2	6.9	7.6	3.0	20.5	24.7	-	-	-	44.2
		4	3.9	20.7	-	18.1	13.8	-	-	-	47.4
Dog, i.v.	3	0.08	17.4	-	23.5	-	-	-	-	23.3	53.2
		0.25	12.2	-	44.6	-	-	-	-	-	55.4
		0.50	11.2	-	16.9	10.5	9.0	-	-	-	63.6
		1	10.2	4.3	12.8	12.6	15.4	-	-	-	54.9
		2	7.8	6.7	4.8	20.7	23.1	-	-	-	44.7
		4	4.3	8.0	-	21.9	19.8	-	-	-	50.3

^aIn the case of rats, the percentage of the dose was calculated on the basis of weight percentage of the total body weight using 4.02% for plasma, whereas for dogs the total body plasma was calculated from total blood volume (84.5 mL/kg), along with animal weights and plasma/blood ratios.

^bValues represent relative peak areas expressed as percentage (i.e., 100% equals the sum of all peak areas in the respective radiochromatogram). The ¹⁴C recoveries obtained by SPE ranged between 40 and 70%.

Source: Schupke *et al.*, 2001.

Figure 6-1 Overview of the main metabolites of (dl)-α-lipoic acid

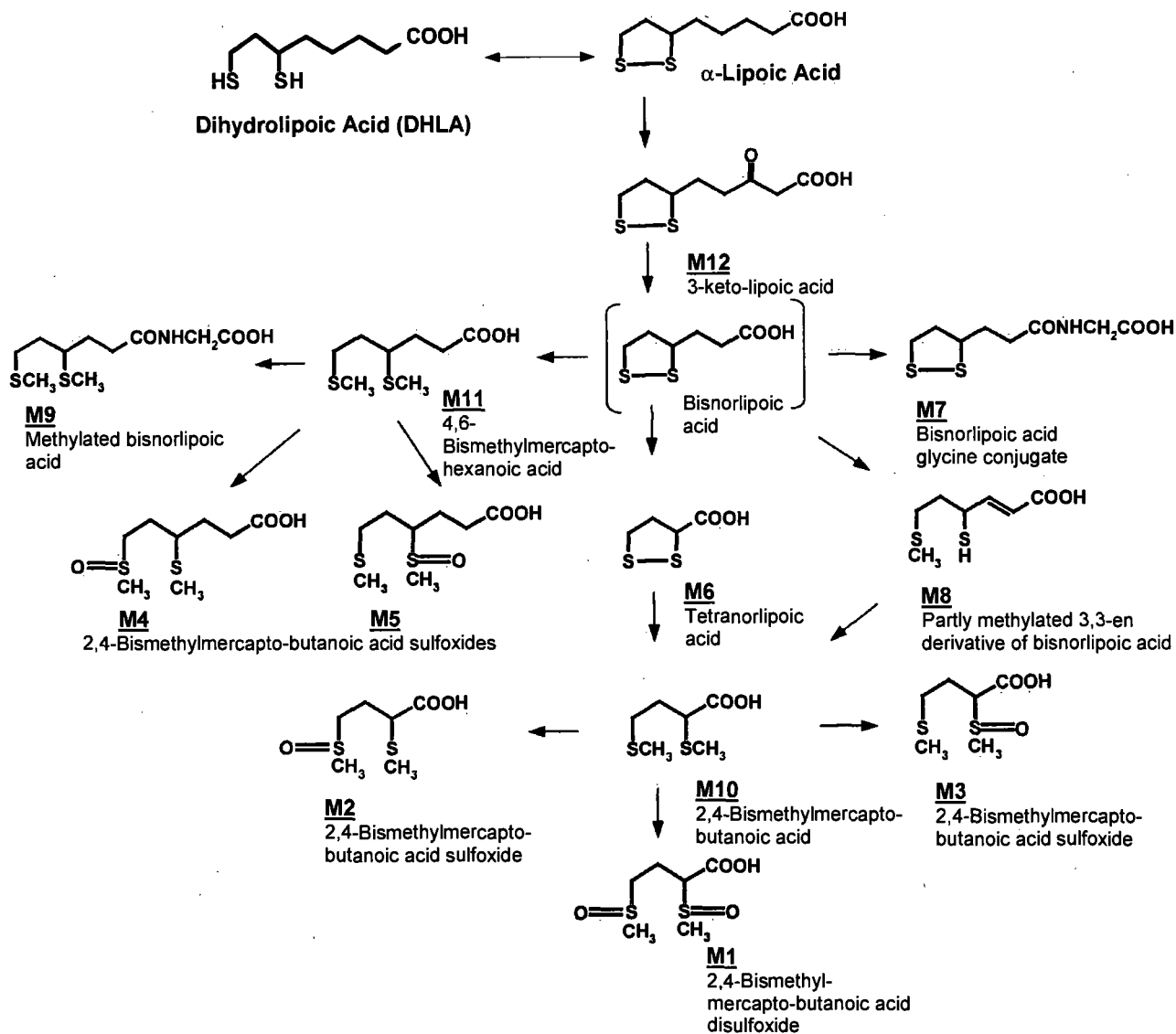

Metabolite	Plasma (oral/i.v.)	Dog		Mouse			Rat			Human		
		Urine (oral)	Feces (oral)	Plasma	Urine	Feces	Plasma	Urine	Feces	Plasma	Urine	Feces
α-Lipoic acid			✓			✓			✓	✓		
M1		✓			✓			✓				
M2		✓			✓			✓			✓	
M3	✓	✓			✓			✓		✓	✓	
M4								✓			✓	
M5		✓			✓			✓			✓	
M6	✓									✓		
M7					✓							
M8	✓							✓		✓	✓	
M9		✓			✓			✓				
M10	✓				✓					✓	✓	
M11								✓		✓	✓	
M12			✓					✓		✓		

Adapted from Schupke *et al.*, 2001

In a more recent study, Zicker *et al.* (2010) examined the pharmacokinetics of *dl*- α -lipoic acid administered orally to dogs as a single dose in capsule form with and without a meal, and as an ingredient of an extruded dog food. The study followed a 3 x 3 factorial Latin square design; Table 6-3 lists all the possible treatments.

Table 6-3 Methods of administration used to examine the pharmacokinetics of *dl*- α -lipoic acid in dogs

<i>dl</i> - α -LIPOIC ACID DOSE (mg/kg bw)	DOSAGE FORM		
	Capsule after fasting	Capsule with food	In extruded food
	2.5	2.5	2.5
	12.5	12.5	12.5
	25	25	25

Twenty-seven healthy adult beagle dogs (ages 3.7 to 13.5 years) were randomly assigned to 1 of 9 groups (3/group). Each group was exposed to the 3 different dosing schemes in the order determined by a randomization scheme, with a washout period of at least 7 days between treatments. Serum samples were obtained immediately prior to dosing (0 min), at 15-minute intervals over the first hour after dosing, and again at 2 hours. Plasma concentrations of *dl*- α -lipoic acid were determined using HPLC. A generalized linear models procedure was used to evaluate the effects of method of delivery and dosage.

The results of the study showed that the pharmacokinetic parameters of *dl*- α -lipoic acid were affected by both dose and method of administration; ranges for each of the parameters are provided in Table 6-4. Absorption was lowest when *dl*- α -lipoic acid was incorporated into the extruded food, compared to the capsule formulation. However, plasma *dl*- α -lipoic acid concentration was proportional to the dose administered, irrespective of the method of administration.

Table 6-4 Range of values for pharmacokinetic parameters in dogs receiving *dl*- α -lipoic acid orally by 3 methods of administration at 3 doses

Parameter	Mean values	<i>dl</i> - α -Lipoic acid dose (mg/kg)	Method
C_{max}	Lowest: 47 ng/mL	2.5	Extruded food
	Highest: 5441 ng/mL	25	Capsule + meal
T_{max}	Lowest: 21.7 min	2.5	Capsule alone
	Highest: 105 min	2.5	Extruded food
AUC_{0-last}	Lowest: 4429 min*ng/mL	2.5	Extruded food
	Highest: 188,569 min*ng/mL	25	Capsule + meal
$T_{1/2}$	Lowest: 19.4 min	2.5	Capsule alone
	Highest: 573 min	25	Extruded food
λ_2	Lowest: 0.002 min ⁻¹	12.5	Extruded food
	Highest: 573 min	2.5	Capsule alone
C_{last}	Lowest: 46 ng/mL	2.5	Capsule + meal & Extruded food
	Highest: 321 ng/mL	25	Capsule alone

Schupke *et al.* (2001) also examined metabolism in humans receiving a single dose of 600 mg *dl*- α -lipoic acid as an oral solution or as tablets (600 mg 3 times daily over 3 days) using LC/MS/MS. Since ^{14}C radiolabel was not administered to humans, a direct comparison to the other animal species examined was not possible. Nevertheless, the human metabolic profile showed greater similarity to lipoic acid metabolism in rodents. There was no equivalent in humans of the tetranorlipoic acid derivatives that predominate in dogs, and 3-keto lipoic acid, an intermediate in the course of β -oxidation of lipoic acid was found in human and rat, but not dog, plasma.

Despite the slight differences in metabolism among animal species, the available data from studies with radiolabeled *dl*- α -lipoic acid indicate that: (1) all metabolites found within 24 hours in the urine of dogs receiving a single oral (gavage) dose of 30 mg/kg bw were also identified in the urine of mice and rats (Table 5-2); and (2) metabolism to tetranorlipoic acid (M6) and its derivatives occurs more rapidly in the dog, but its products were also evident in the urine of mice and rats after 24 hours.

7.0 SAFETY OF α -LIPOIC ACID

7.1 Safety Studies in the Target Animal Species (Dog)

The interim (6-month) findings of a 1-year GLP-compliant study sponsored by Hill's Pet Nutrition that examined the effects of including α -lipoic acid (*dl*- α -lipoic acid) in the diet of adult dogs (1 to 3 years old) of mixed breeds have been published by Zicker *et al.* (2002); 1-year data have not been published but appear subsequently. As Table 7-1 illustrates, α -lipoic acid was incorporated in the diet at levels of 0 (18 ppm background), 150, 1500, 3000, and 4500 ppm (target inclusion rates), providing approximately 0.3, 2.3, 26, 53, and 82 mg/kg bw/day, respectively. Actual measured α -lipoic acid levels measured in the prepared diets were 18, 145, 1426, 2803, and 4138 ppm (or 5, 41, 403, 792, and 1169 μ g/kcal) on an as-fed basis, and 19, 157, 1548, 3044, and 4505 ppm on a dry matter basis (see Appendix 8).

Occasional vomiting was observed in several animals at various times during the study, with no apparent association to α -lipoic acid treatment. Statistically significant differences were noted at both the 6-month and the 1-year time points in some clinical chemistry and hematology parameters of animals receiving the test diets when compared to baseline values and/or to control group values. However, in the absence of consistent trends and because, with a few exceptions, values were within or very near the laboratory reference range for normal dogs, these differences were not considered biologically significant. Based on the absence of any toxicity related to the inclusion of α -lipoic acid in the diet, the no-observable-adverse-effect level (NOAEL) after 1 year was considered to be approximately 82 mg/kg bw/day (4500 ppm target dietary inclusion rate).

Table 7-1 Estimates of α -lipoic acid exposure among dogs receiving study diets for up to 1 year

Species	Level of α -lipoic acid exposure		Duration of exposure	Route of exposure	NOAEL
	ppm ^b	mg/kg bw/day			
Dog (3/sex/group)	0	0.3	up to 1 year	Diet	82 mg/kg bw/day (4500 ppm) ^a
	150	2.5			
	1500	26			
	3000	53			
	4500	82			

NOAEL: no-observable-adverse-effect level.

^a Weight loss and leukocytosis observed in 1 dog in the 4500 ppm group was not considered related to α -lipoic acid administration.

^b Values as presented are target inclusion levels, equivalent to approximately 0, 42, 420, 840, and 1260 μ g/kcal; actual mean levels were 18, 145, 1426, 2803, and 4138 ppm (or 5, 41, 403, 792, and 1169 μ g/kcal) on an as-fed basis; 19, 157, 1548, 3044, and 4505 ppm on a dry matter basis (see Appendix 8).

7.1.1 Published Interim (6-Month) Findings of a Chronic Dietary Study in Dogs

Zicker *et al.* (2002) published the interim (6-month) findings of a 1-year study that examined the effects of including α -lipoic acid (*dl*- α -lipoic acid) in the diet of adult dogs (1 to 3 years old) of mixed breeds; 1-year data have not been published but appear subsequently. The study was conducted at CAVL (Amarillo, TX) in accordance with GLP regulations. The in-life phase of the study began on November 29, 2000 and ended on November 29, 2001. The present section summarizes the results of analysis at the 6-month time point.

After a 2-week conditioning period, healthy dogs (3/sex/group) at least 10 months old received a diet containing 0 (background level of 18 ppm), 150, 1500, 3000, or 4500 ppm (mg/kg food; 5, 42, 420, 840, or 1260 μ g/kcal) α -lipoic acid as the sole source of nutrients for 6 months (18, 145, 1426, 2803, and 4138 ppm on an as-fed basis; 19, 157, 1548, 3044, and 4505 ppm on a dry matter basis). The resulting α -lipoic acid intakes were estimated to be 0.3, 2.5, 26, 53, and 82 mg/kg bw/day, respectively (see Appendix 8). All animals were observed at least once daily for any adverse clinical signs. Physical examinations were conducted by a veterinarian before the study, on Day 0, and monthly thereafter. Analysis of the diets revealed no significant differences in nutrient profiles, aside from α -lipoic acid. Animals were weighed weekly, and food amounts were adjusted accordingly to maintain optimal body weight; dogs losing more than 15% of the initial body weight after adjustment were removed from the study. Blood samples for complete blood cell count and serum biochemistry were obtained at 2 weeks prior to study start and at 0, 28, 56, 84, 112, 140, and 168 days thereafter; lymphocytes were measured at Days 0, 28, and 84.

There were no significant differences among groups in food consumption. As Table 7-2 illustrates, some effects on body weights were noted, especially in the 3000 and 4500 ppm α -lipoic acid groups, but the differences from baseline values were not statistically significant. Body condition scores (5-point scale) were reportedly unaffected by the slight differences in body weights.

Table 7-2 Mean body weights (kg) of beagle dogs (3/sex/group) receiving dietary α -lipoic acid for 6 months

α -Lipoic acid (ppm)	Start	2 Weeks	Month 1	Month 2	Month 3	Month 4	Month 5	Month 6
0 (5 μ g/kcal)	14.9 \pm 2.6	15.0 \pm 2.5	15.1 \pm 2.6	15.7 \pm 3.0	16.0 \pm 3.3	16.2 \pm 3.5	16.6 \pm 3.6	16.8 \pm 4.0
150 (42 μ g/kcal)	15.4 \pm 2.6	15.0 \pm 3.4	15.5 \pm 2.5	15.9 \pm 2.2	16.2 \pm 2.4	16.4 \pm 2.6	16.2 \pm 2.7	17.0 \pm 2.5
1500 (420 μ g/kcal)	15.3 \pm 2.5	15.6 \pm 2.4	15.6 \pm 2.5	16.1 \pm 2.8	16.5 \pm 2.6	16.6 \pm 2.4	17.1 \pm 2.4	17.6 \pm 2.5
3000 (840 μ g/kcal)	14.3 \pm 2.5	14.7 \pm 2.6	14.7 \pm 2.5	14.8 \pm 2.6	14.9 \pm 2.6	14.8 \pm 2.5	15.1 \pm 2.6	15.3 \pm 2.8
4500 (1260 μ g/kcal)	15.1 \pm 2.0	15.3 \pm 2.2	14.9 \pm 2.3	14.4 \pm 2.2	14.0 \pm 2.1	14.3 \pm 1.2	13.7 \pm 1.8	14.6 \pm 1.4

N=3 dogs/sex/group. Body weights expressed as mean \pm standard deviation. α -Lipoic acid levels represent 5, 42, 420, 840, and 1260 μ g/kcal of diet, respectively; actual level in the control diet was reported to be 18 ppm.

One dog receiving 4500 ppm α -lipoic acid was removed from the study due to weight loss and leukocytosis; the body weight eventually stabilized but the leukocytosis had not resolved by the end of the study. No signs of anorexia or other clinical signs were noted in this animal.

Occasional vomiting was observed in several animals at various times during the study, with no apparent association to α -lipoic acid treatment. Some statistically significant differences were noted in hematology and serum biochemistry values. However, none of these differences were considered biologically important because no trends were apparent and the values were in the range of the laboratory's reference values.

7.1.2 Unpublished 1-Year Findings of a Chronic Dietary Study in Dogs

7.1.2.1 Study Design

The study design was as described by Zicker *et al.* (2002) in the published interim (6-month) report (section 6.1.1 of the present report). Briefly, healthy adult dogs (1 to 3 years old) of mixed breeds (3/sex/group) received a diet containing 0 (background level of 18 ppm), 150, 1500, 3000, or 4500 ppm (mg/kg food; 5, 42, 420, 840, or 1260 μ g/kcal) α -lipoic acid as the sole source of nutrients for 1 year. Analysis of the diets revealed no significant differences in nutrient profiles, aside from α -lipoic acid (see Appendix 8). About 1 month into the study, the laboratory staff noted discoloration and the presence of mold in some of the test food samples. Samples were provided to an independent laboratory for mycotoxin analysis. Vomitoxin or deoxynivalenol (≤ 2.7 ppm) was the only mycotoxin detected. Subsequent analyses of other samples were found to have no detectable levels of mycotoxins.

All animals were observed at least once daily for any clinical signs. Physical examinations were conducted by a veterinarian before the study, on Day 0 and monthly thereafter. Body weights and food consumption were measured weekly, and blood samples were obtained at 2 weeks prior to study start, at study initiation, and monthly thereafter. All surviving animals were returned to the laboratory's general dog population upon completion of the study. The present section summarizes the overall results of the study; tabulated data appear in Appendix 9.

7.1.2.2 Mortality, Physical Examinations, and Clinical Signs

Physical examinations did not reveal any evidence of toxicity attributable to the test article. Clinical signs observed included sporadic vomiting in 5 animals in the 150, 1500, and 4500 ppm groups. However, there was no apparent trend, consistency, or evidence of a dose-response. One animal from the 3000 ppm group (male, # 31976) suffered from sore paws with intermittent bleeding and some hair loss over extended periods during the study; however, there was no apparent relationship to α -lipoic acid treatment.

One animal from the control group (# 25898) reportedly passed blood on one occasion. A second animal in this group (# 31977) was treated with daily with Rimadyl® (carprofen) for a painful right stifle joint. After approximately 268 days, animal # 31997 appeared reluctant to move and was found dead the next morning. Necropsy examination showed severe heartworm (*Dirofiliaria immitis*) infection with evidence of cardiovascular failure. Three other animals, 2 from the control group (# 24637 and # 25898) and 1 from the 3000 ppm group (# 31976) tested positive for heartworm. However, all 3 successfully completed the study. In summary, there was no evidence of mortality or clinical signs associated with inclusion of α -lipoic acid in the diet.

7.1.2.3 Food Consumption and Body Weights

There were no apparent trends in food intakes that could be attributed to α -lipoic acid. An average daily intake (mg/kg bw) of α -lipoic acid was calculated based on the mean content (ppm) in the diet, mean food intake, and the mean body weight at the end of the study. Mean starting and terminal body weights are summarized in Table 7-3. Overall, mean terminal body weights were 4.5, 8.2, 4.2, 7.3, and 2.5% higher than at study start in the control, 150, 1500, 3000, and 4500 ppm groups, respectively. Body condition also remained constant throughout the study. One animal receiving 4500 ppm α -lipoic acid was removed from the study due to weight loss and leukocytosis. This animal had lost 1.2 kg of body weight prior to starting the study and continued to lose weight over the first 35 days of the study. Monitoring of this animal for several months after removal from the study revealed some improvement. However, no definitive diagnosis was made.

Table 7-3 Mean body weights (kg) of adult dogs (1 to 3 years old) receiving dietary dl- α -lipoic acid for 1 year

α -lipoic acid (ppm)	Start ^a	End
0 ¹	15.0 \pm 2.6	15.6 \pm 2.5
150	15.4 \pm 2.6	16.6 \pm 2.9
1500	15.3 \pm 2.5	15.9 \pm 2.7
3000	14.4 \pm 2.5	15.6 \pm 3.0
4500	15.1 \pm 2.0	15.4 \pm 1.2

N=3 dogs/sex/group. Body weights expressed as mean \pm standard deviation. α -Lipoic acid levels represent 5, 42, 420, 840, and 1260 μ g/kcal of diet, respectively; actual level in the control diet was reported to be 18 ppm.

7.1.2.4 Clinical Chemistry and Hematology

The plotted results of clinical chemistry and hematology measurements appear in Figures 7-1 and 7-2; more detailed results are provided in Appendix 9.

Some statistically significant differences were noted in clinical chemistry and hematology parameters of animals receiving the test diets when compared to baseline values and/or to control group values. In the absence of consistent trends and because, with a few exceptions, values were within or very near the laboratory reference range for normal dogs, these

differences were not considered biologically significant. For example, mean serum calcium levels for Week 8 were out of the normal range for all treatment groups, including the control. However, since there was no evidence of hypercalcemia and it occurred in all groups, these deviations were attributed to possible laboratory error. All laboratory samples before and after this result were normal.

Mean serum bilirubin levels, globulin:albumin ratio, and red cell distribution width (RDW) were outside the reference range on some occasions, with no evidence of a relationship to the presence of α -lipoic acid in the diet. One dog receiving 4500 ppm (Animal # 31153) had a normal white blood cell count (WBC) value at study initiation but an abnormally high value on Day 35 (28.8 vs. 16.02 thousand/mm³ at the upper end of the normal laboratory range). The cause of this effect was undetermined. This dog also experienced weight loss, as described previously, and was removed from the study on Day 35.

In the absence of any apparent toxicity related to α -lipoic acid, a no-observable-adverse-effect level (NOAEL) of approximately 82 mg/kg bw/day (4500 ppm dietary inclusion rate; 1260 μ g/kcal) was proposed.

Figure 7-1 Plotted results of serum biochemistry mean values in adult dogs (1 to 3 years old) receiving *dl*- α -lipoic acid in the diet for 1 year

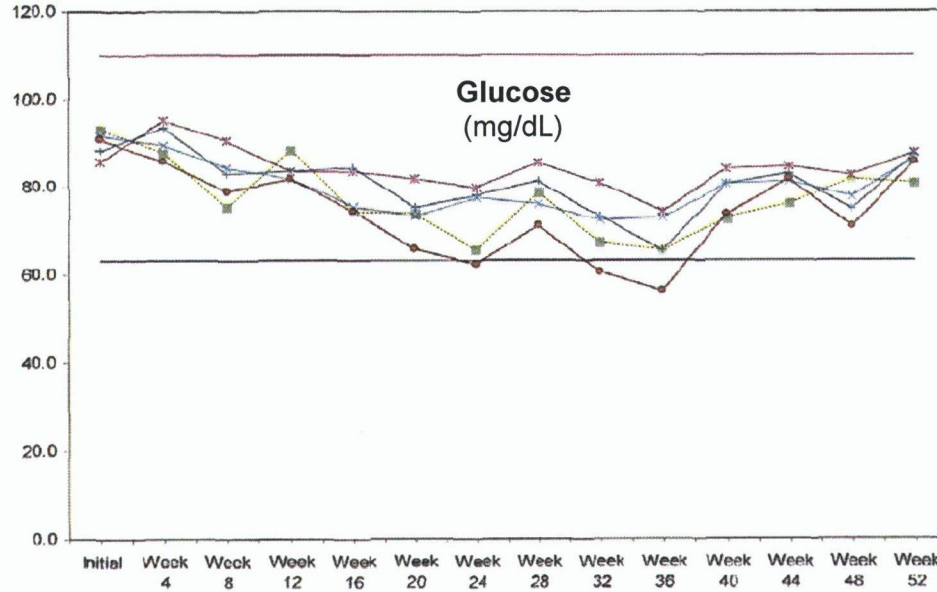

- Lower Normal Limit
- Upper Normal Limit
- Group 1 (Control)
- × Group 2 (145ppm)
- × Group 3 (1426ppm)
- Group 4 (2803ppm)
- Group 5 (4138ppm)

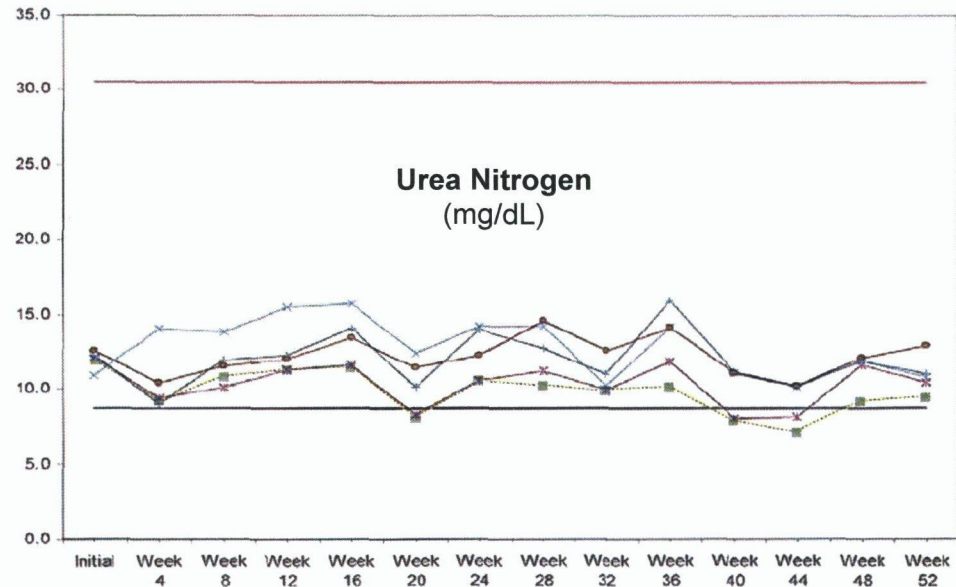

Figure 7-1 Plotted results of serum biochemistry mean values in adult dogs (1 to 3 years old) receiving *dl*- α -lipoic acid in the diet for 1 year (Cont'd)

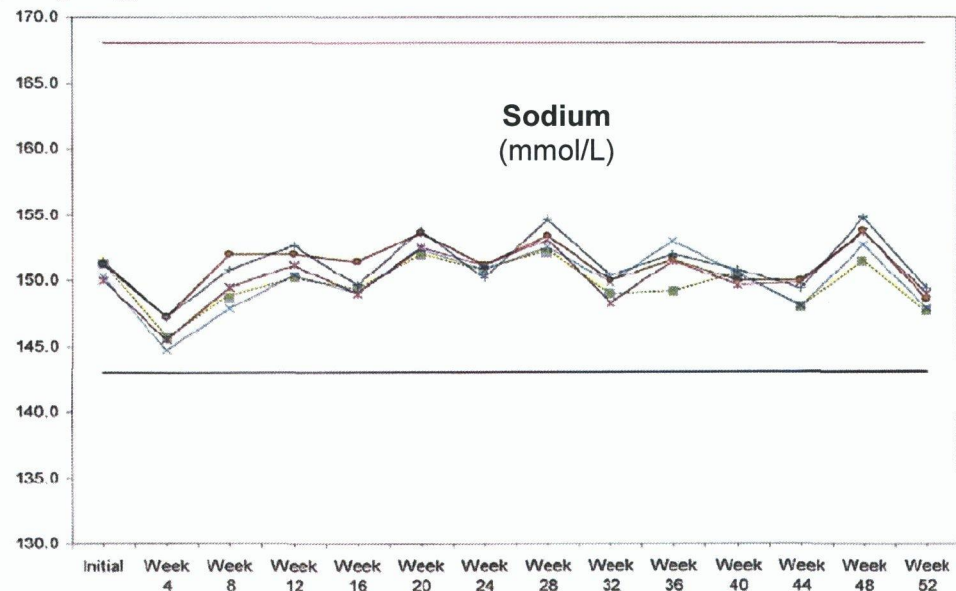
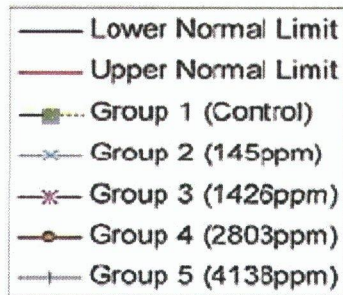
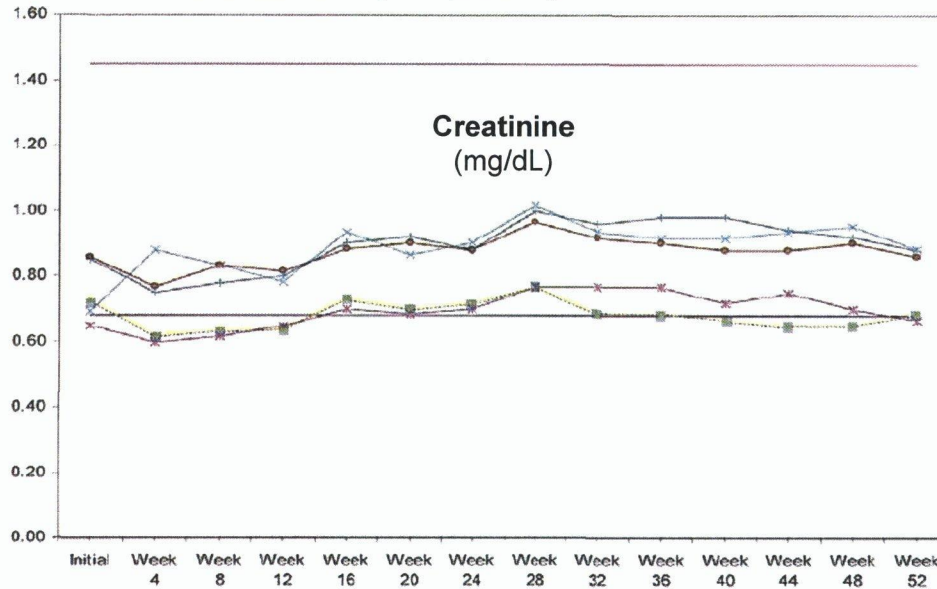
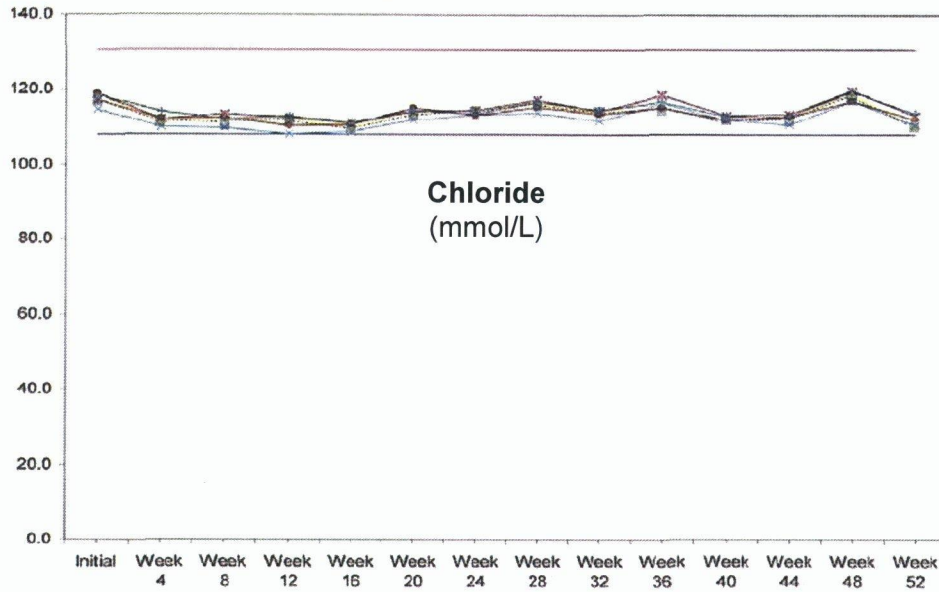

Figure 7-1 Plotted results of serum biochemistry mean values in adult dogs (1 to 3 years old) receiving *dl*- α -lipoic acid in the diet for 1 year (Cont'd)



- Lower Normal Limit
- Upper Normal Limit
- Group 1 (Control)
- × Group 2 (145ppm)
- * Group 3 (1426ppm)
- Group 4 (2803ppm)
- + Group 5 (4138ppm)

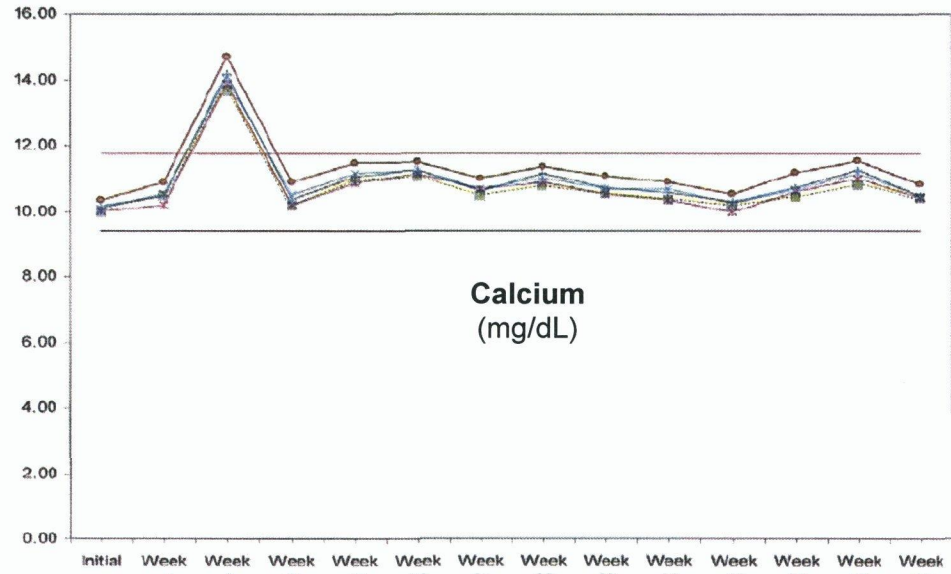
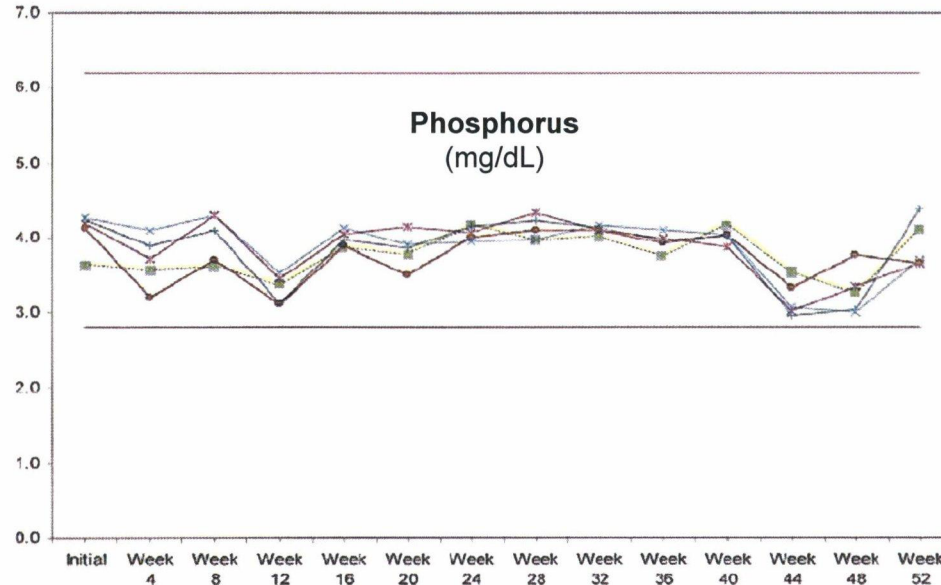

Figure 7-1 Plotted results of serum biochemistry mean values in adult dogs (1 to 3 years old) receiving *d*- α -lipoic acid in the diet for 1 year (Cont'd)



- Lower Normal Limit
- Upper Normal Limit
- Group 1 (Control)
- × Group 2 (145ppm)
- * Group 3 (1426ppm)
- Group 4 (2803ppm)
- + Group 5 (4138ppm)

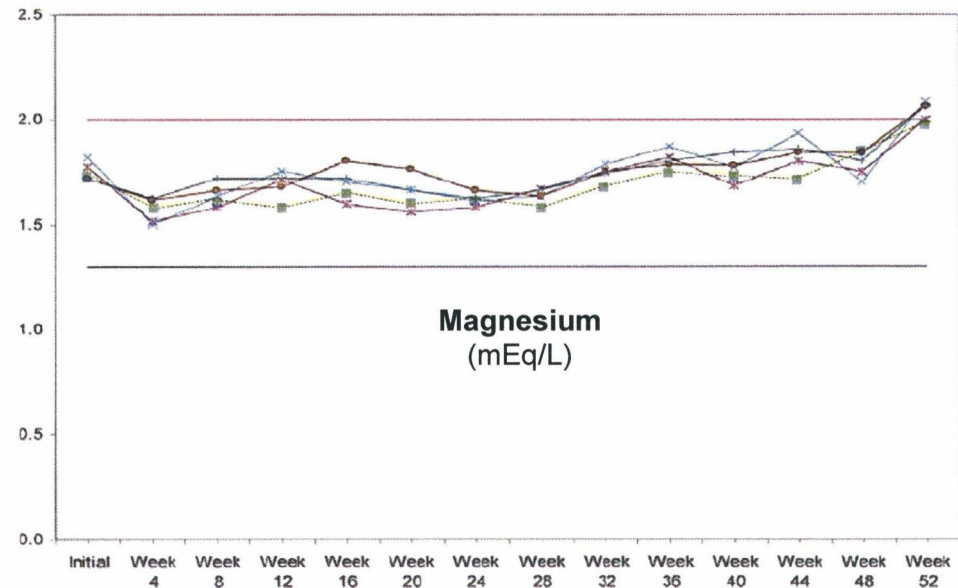
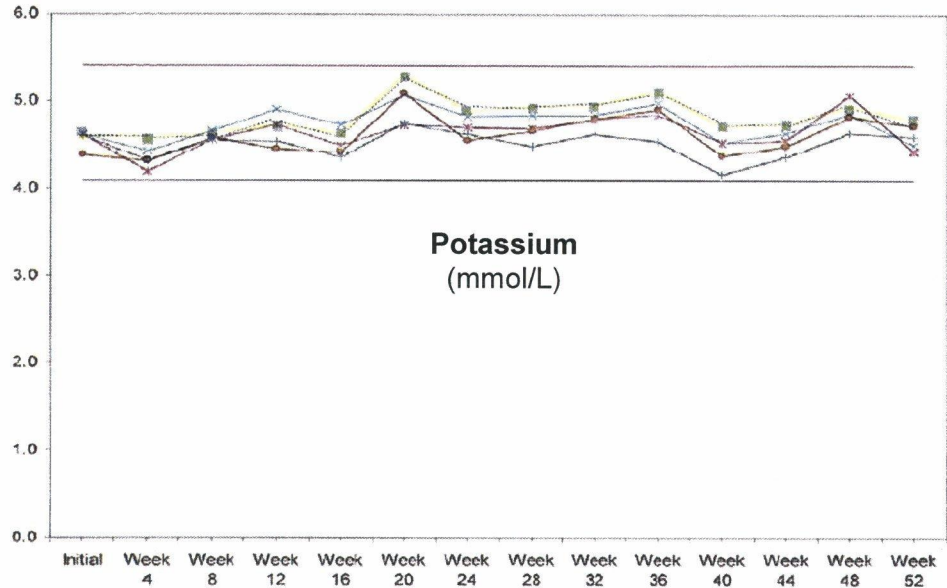

Figure 7-1 Plotted results of serum biochemistry mean values in adult dogs (1 to 3 years old) receiving *dl*- α -lipoic acid in the diet for 1 year (Cont'd)



- Lower Normal Limit
- Upper Normal Limit
- Group 1 (Control)
- × Group 2 (145ppm)
- * Group 3 (1426ppm)
- Group 4 (2803ppm)
- + Group 5 (4138ppm)

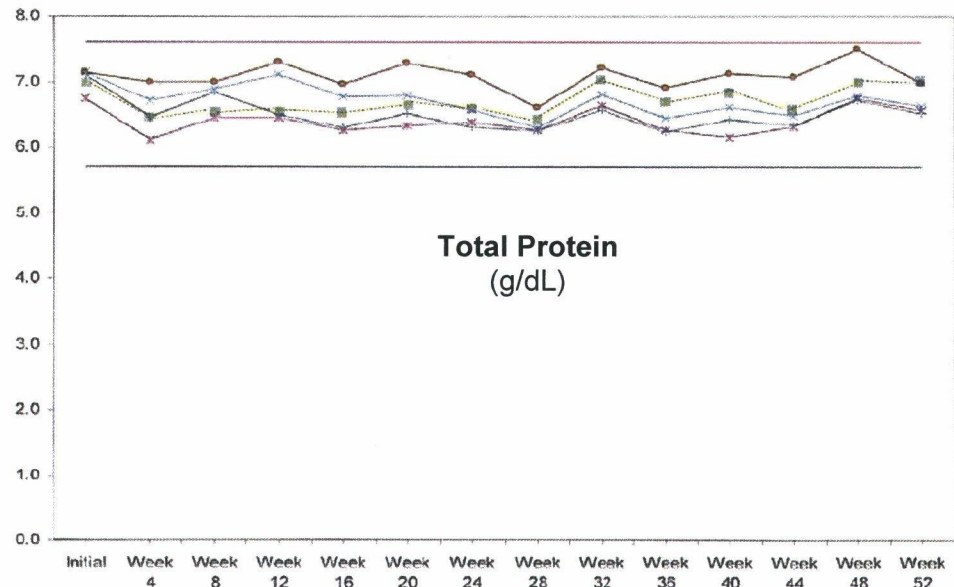
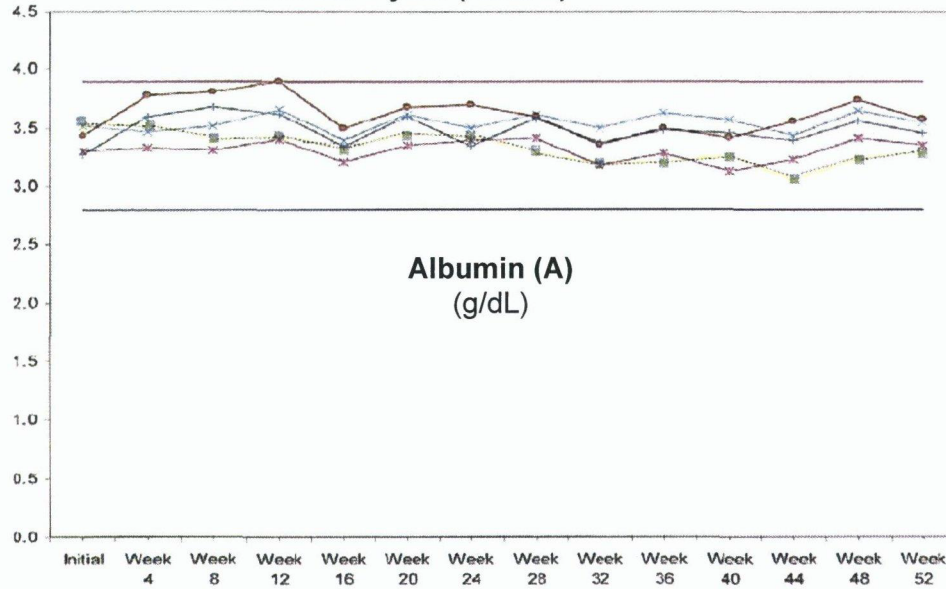

Figure 7-1 Plotted results of serum biochemistry mean values in adult dogs (1 to 3 years old) receiving *dl*- α -lipoic acid in the diet for 1 year (Cont'd)



- Lower Normal Limit
- Upper Normal Limit
- Group 1 (Control)
- Group 2 (145ppm)
- Group 3 (1426ppm)
- Group 4 (2803ppm)
- Group 5 (4138ppm)

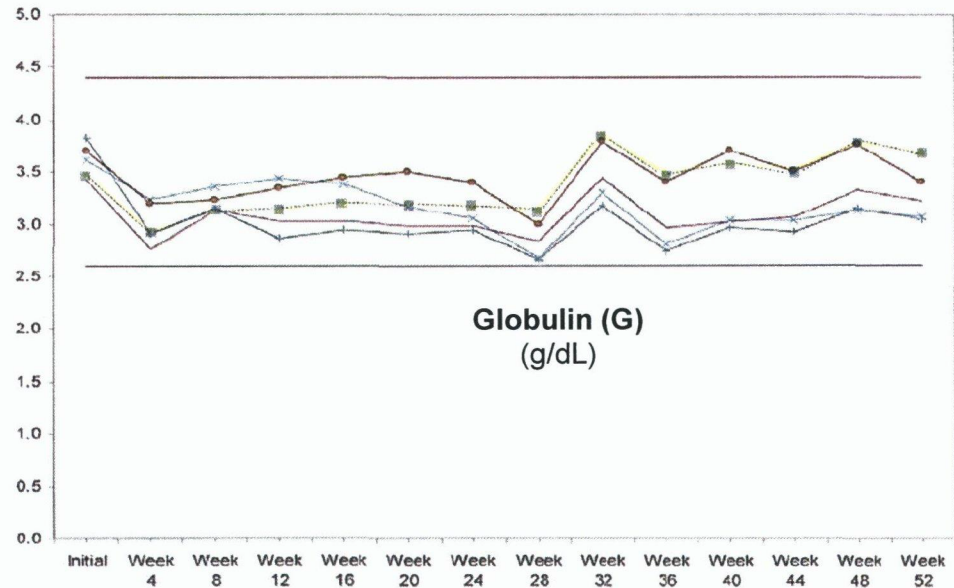
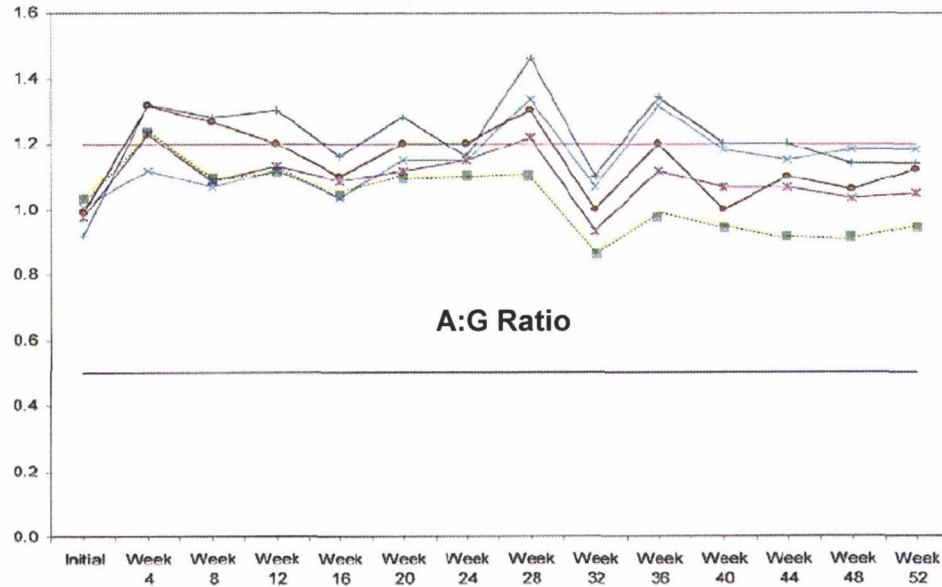

Figure 7-1 Plotted results of serum biochemistry mean values in adult dogs (1 to 3 years old) receiving *d*- α -lipoic acid in the diet for 1 year (Cont'd)



- Lower Normal Limit
- Upper Normal Limit
- Group 1 (Control)
- × Group 2 (145ppm)
- × Group 3 (1426ppm)
- Group 4 (2803ppm)
- Group 5 (4138ppm)

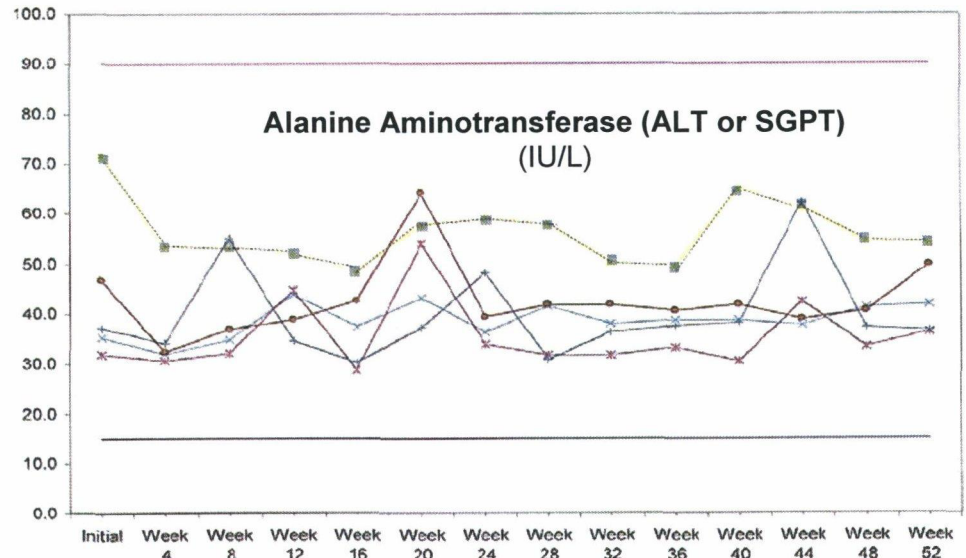
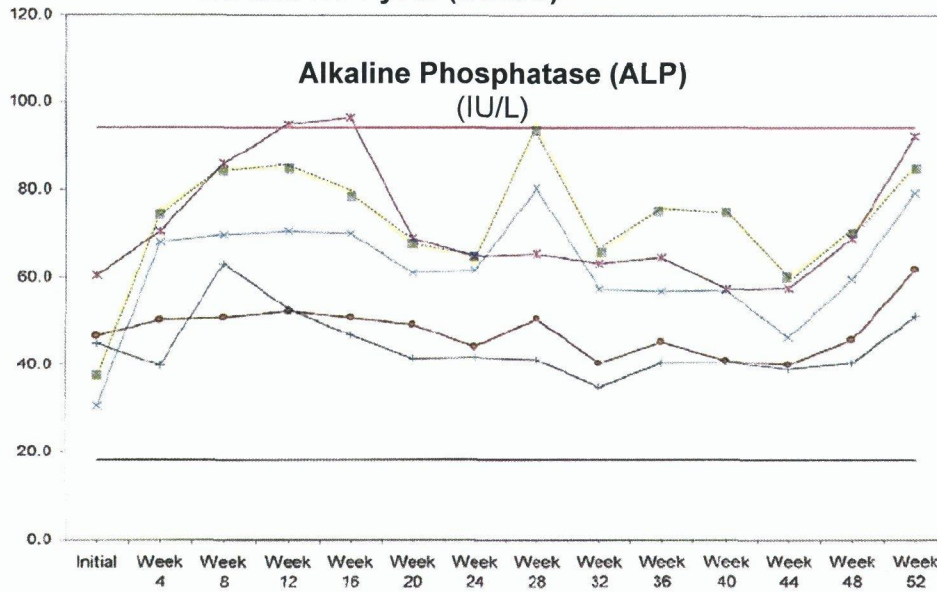

Figure 7-1 Plotted results of serum biochemistry mean values in adult dogs (1 to 3 years old) receiving *dl*- α -lipoic acid in the diet for 1 year (Cont'd)



- Lower Normal Limit
- Upper Normal Limit
- Group 1 (Control)
- × Group 2 (145ppm)
- × Group 3 (1426ppm)
- Group 4 (2803ppm)
- Group 5 (4138ppm)

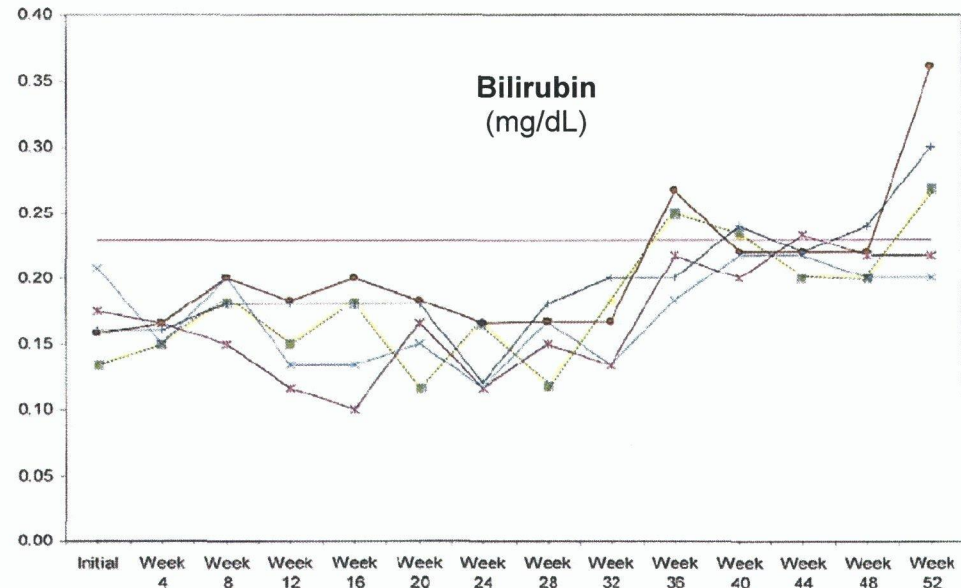
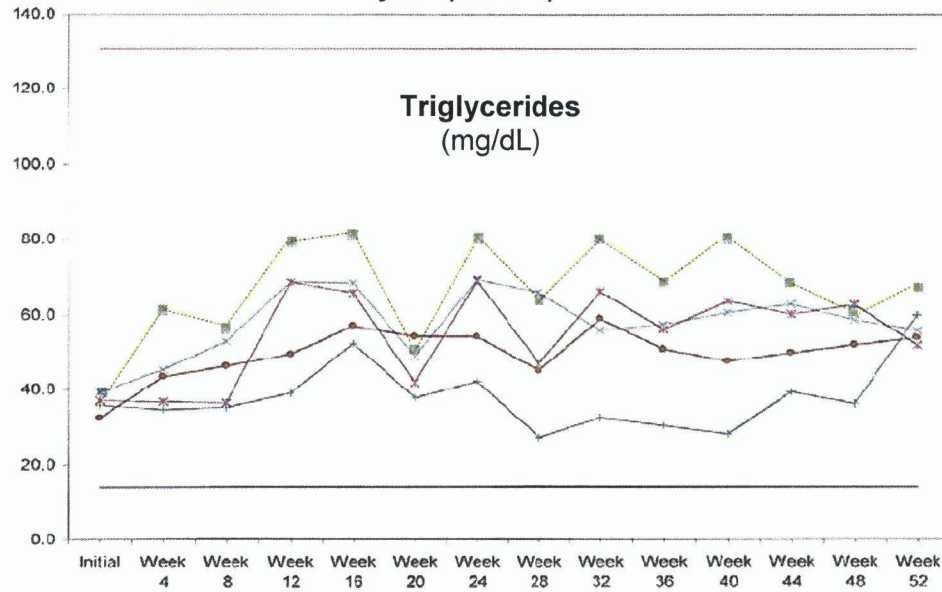

Figure 7-1 Plotted results of serum biochemistry mean values in adult dogs (1 to 3 years old) receiving *dl*- α -lipoic acid in the diet for 1 year (Cont'd)



- Lower Normal Limit
- Upper Normal Limit
- Group 1 (Control)
- × Group 2 (145ppm)
- × Group 3 (1426ppm)
- Group 4 (2803ppm)
- Group 5 (4138ppm)

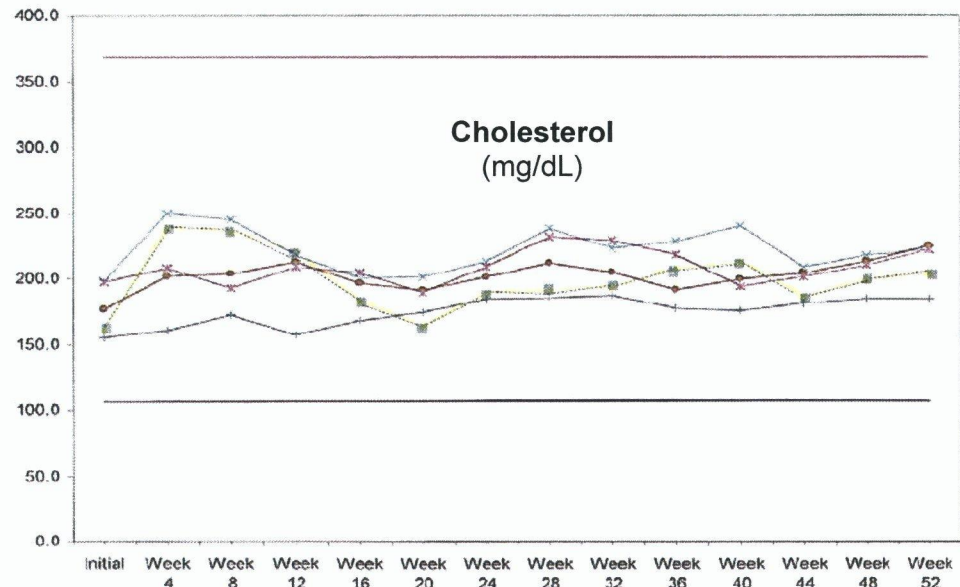
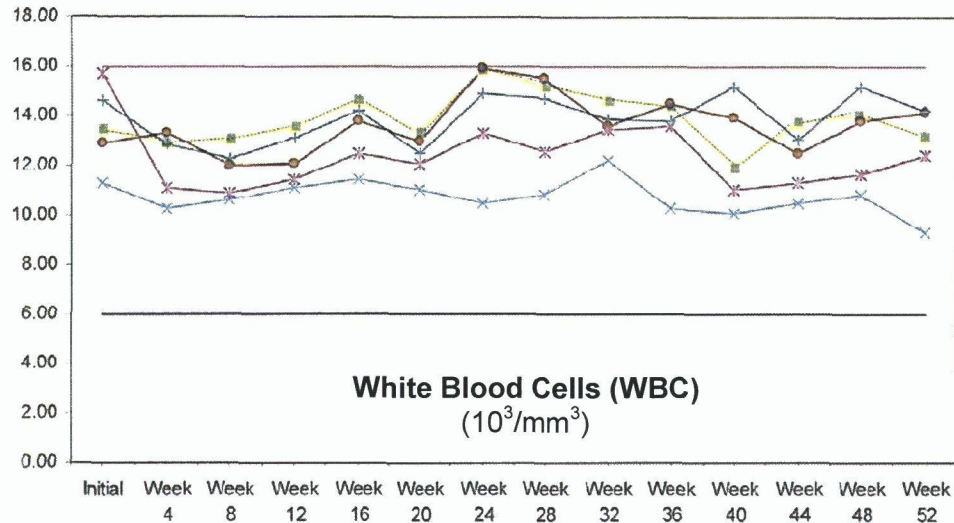

Figure 7-2 Plotted results of hematology mean values in adult dogs (1 to 3 years old) receiving *dl*- α -lipoic acid in the diet for 1 year



- Lower Normal Limit
- Upper Normal Limit
- - - Group 1 (Control)
- x- Group 2 (145ppm)
- *- Group 3 (1426ppm)
- o- Group 4 (2803ppm)
- +- Group 5 (4138ppm)

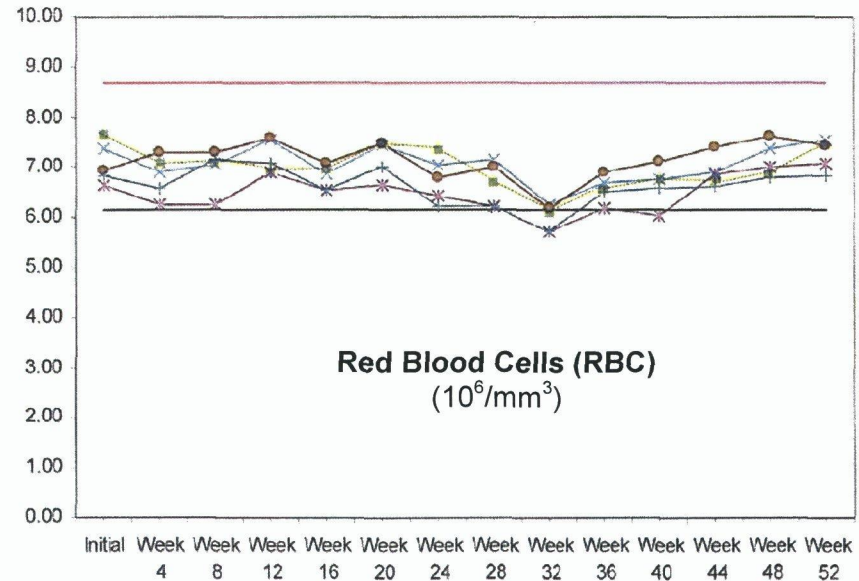
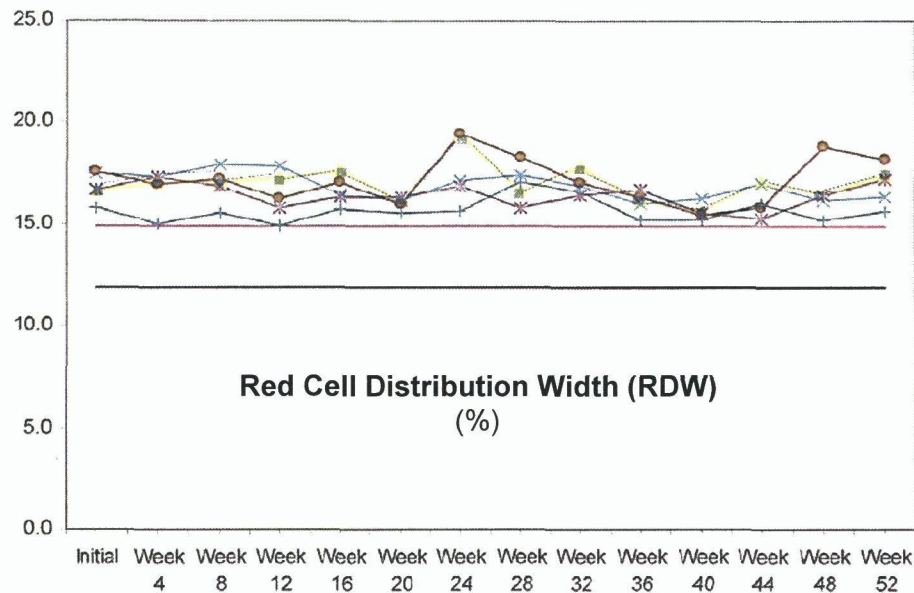

Figure 7-2 Plotted results of hematology mean values in adult dogs (1 to 3 years old) receiving *dl*- α -lipoic acid in the diet for 1 year (Cont'd)



- Lower Normal Limit
- Upper Normal Limit
- Group 1 (Control)
- × Group 2 (145ppm)
- * Group 3 (1426ppm)
- Group 4 (2803ppm)
- Group 5 (4138ppm)

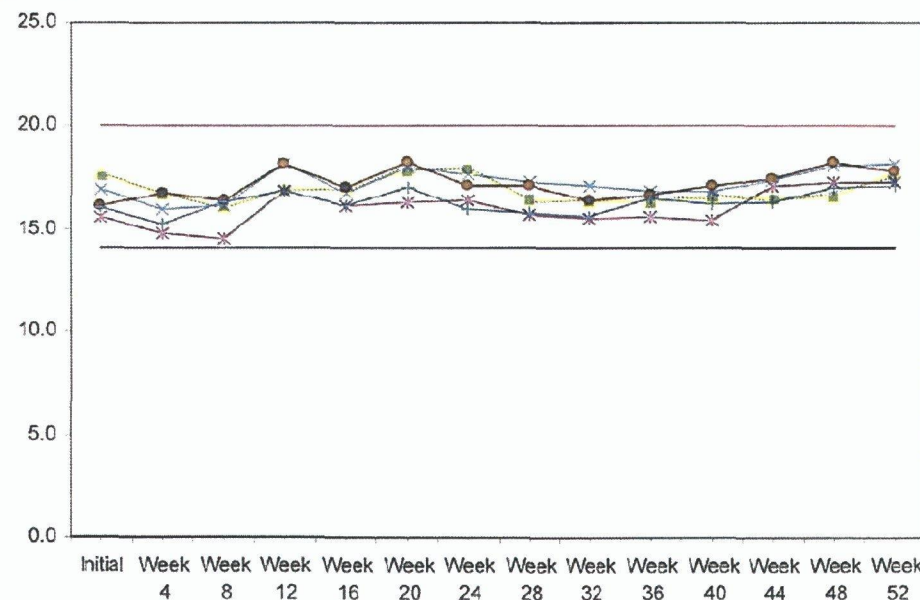
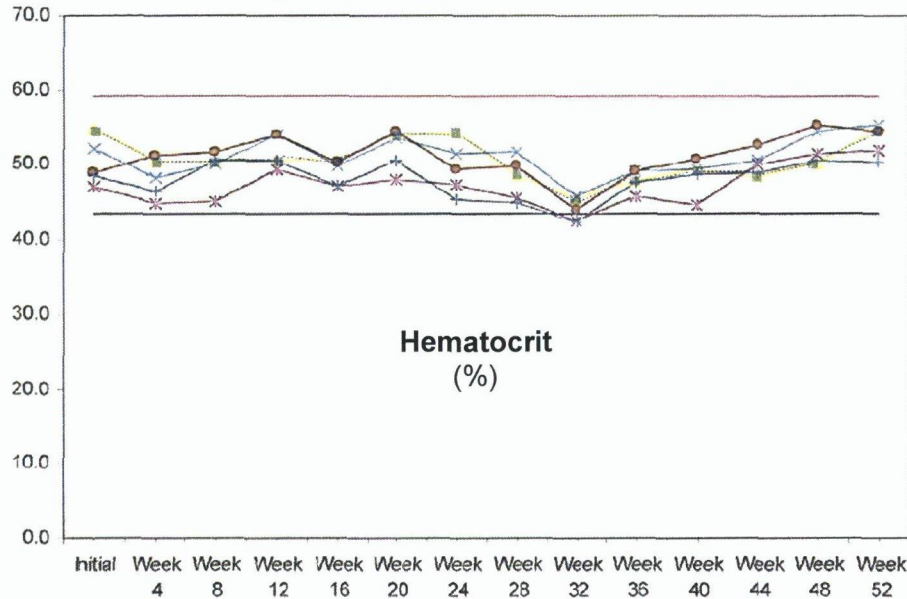

Figure 7-2 Plotted results of hematology mean values in adult dogs (1 to 3 years old) receiving *dl*- α -lipoic acid in the diet for 1 year (Cont'd)



- Lower Normal Limit
- Upper Normal Limit
- Group 1 (Control)
- ×— Group 2 (145ppm)
- *— Group 3 (1426ppm)
- Group 4 (2803ppm)
- +— Group 5 (4138ppm)

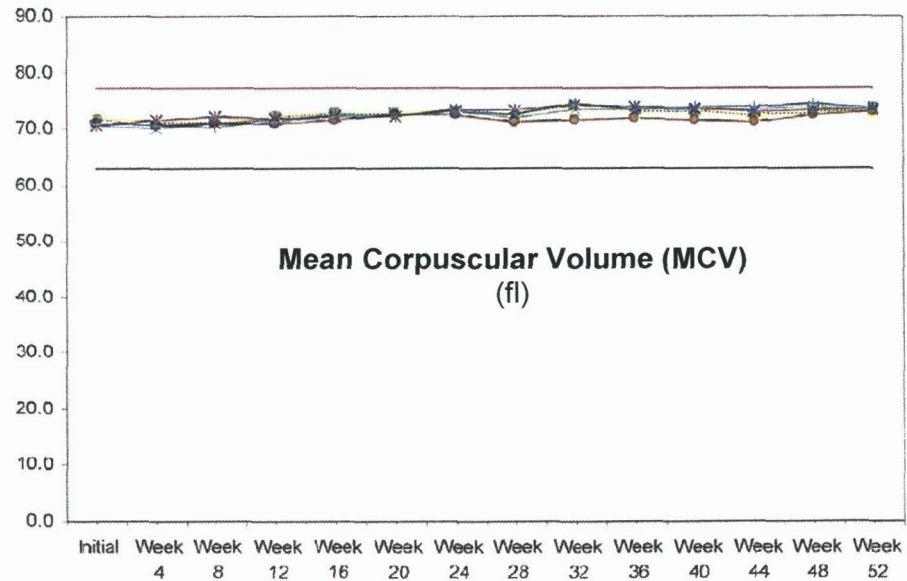
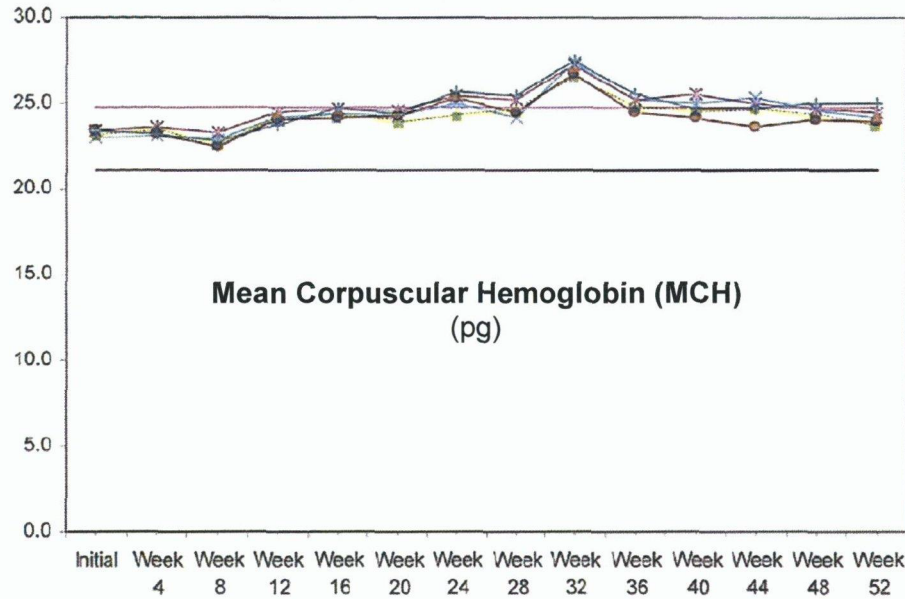

Figure 7-2 Plotted results of hematology mean values in adult dogs (1 to 3 years old) receiving *dl*- α -lipoic acid in the diet for 1 year (Cont'd)



- Lower Normal Limit
- Upper Normal Limit
- Group 1 (Control)
- Group 2 (145ppm)
- Group 3 (1426ppm)
- Group 4 (2803ppm)
- Group 5 (4138ppm)

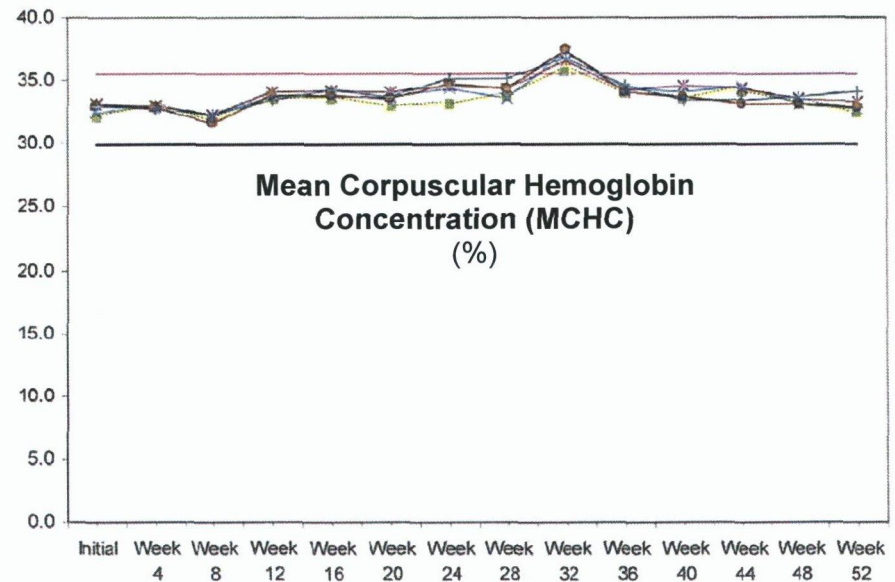
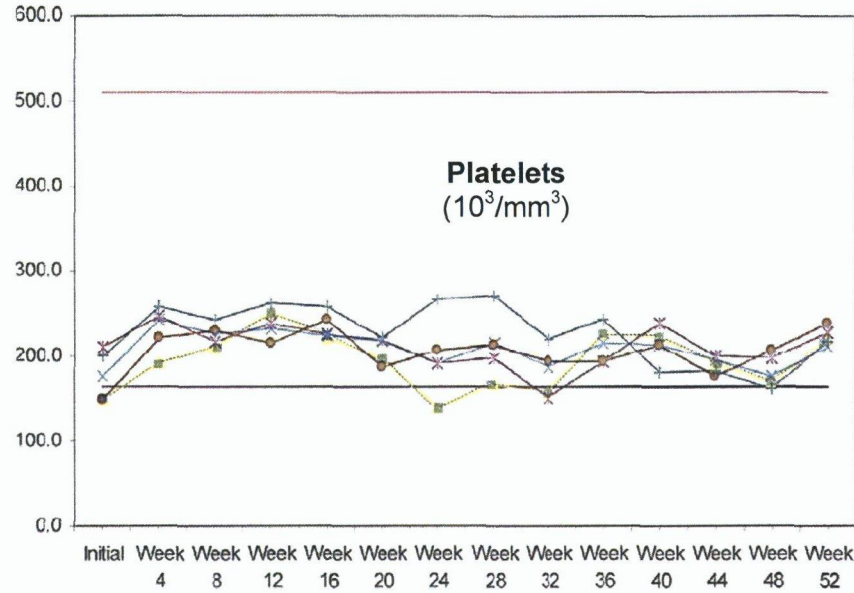
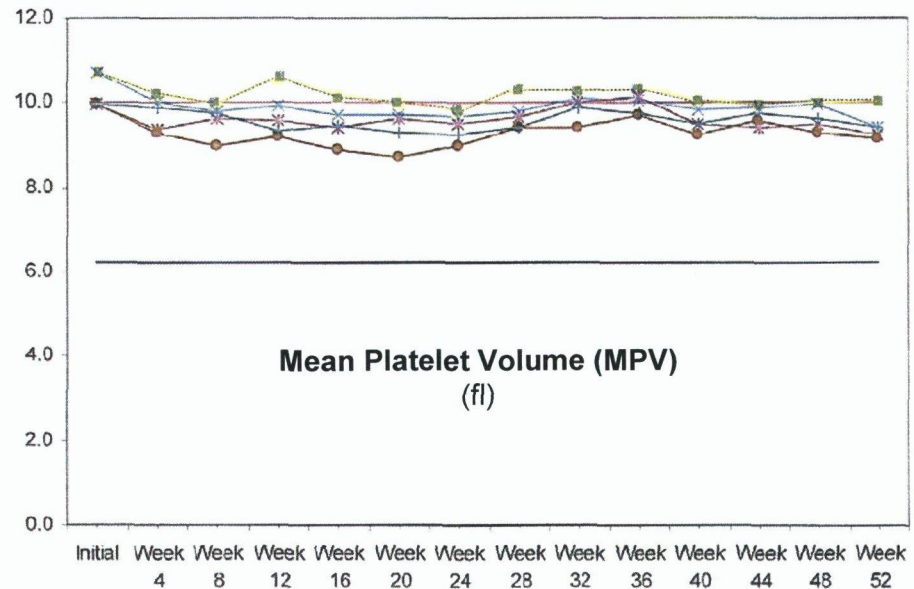

Figure 7-2 Plotted results of hematology mean values in adult dogs (1 to 3 years old) receiving *dl*- α -lipoic acid in the diet for 1 year (Cont'd)



- Lower Normal Limit
- Upper Normal Limit
- Group 1 (Control)
- × Group 2 (145ppm)
- * Group 3 (1426ppm)
- Group 4 (2803ppm)
- + Group 5 (4138ppm)



7.2 Safety Studies in Other Animal Species

A number of studies were found in the published scientific literature that examined the oral toxicity of α -lipoic acid in other animal species. The results of these studies show that single oral (gavage) doses up to 2000 mg/kg bw of *dl*- α -lipoic acid are not lethal to rats (Cremer *et al.*, 2006a). The no-observable-adverse-effect level (NOAEL) in rats following oral exposure *via* gavage for 4 weeks or in the diet for up to 2 years was approximately 60 mg/kg bw/day. These studies are discussed in more detail in subsequent sections and are summarized in Table 7-7.

7.2.1 Single-Dose Toxicity in Rodents

According to Fuke *et al.* (1972), the oral median lethal dose (LD₅₀) of α -lipoic acid in male and female 7-week-old Sprague-Dawley rats was 1320 and 1130 mg/kg, respectively; the maximum non-lethal oral dose was 500 mg/kg for males and 350 mg/kg for females.

Cremer *et al.* (2006a) examined the acute toxicity of α -lipoic acid in 8-week-old female Sprague-Dawley IGS BR rats using the up-and down-procedure described in OECD⁵ Test Guideline 425 (2001). A single dose of 175 mg/kg bw (in 0.1% aqueous solution of sodium carboxymethyl cellulose) was administered to 1 rat, followed by 550 mg/kg bw in a second rat, and ultimately 2000 mg/kg bw in 3 rats. Animals were observed for mortality and other signs of toxicity at regular intervals during the first 8 hours and for 14 days after dosing. Body weights were recorded prior to dosing and on Days 7 and 14. No mortality or signs of toxicity were noted at 175 or 550 mg/kg bw. Animals receiving 2000 mg/kg bw exhibited sedation, apathy, piloerection, hunched posture and/or eye closure between 2 and 6 hours after dosing, but no mortality. No other effects were noted. The oral median lethal dose (LD₅₀) of α -lipoic acid in this study was considered to be higher than the highest dose administered (>2000 mg/kg bw).

7.2.2 Four-Week Oral Toxicity in SD Rats (Cremer *et al.*, 2006a)

7.2.2.1 Study Design

Following a dose-range finding study (68.1, 147, 316, or 681 mg/kg bw/day ALA given to Wistar rats *via* oral gavage for 2 weeks), Cremer *et al.* (2006a) administered ALA *via* oral gavage to Wistar (Hsd/Win:WU) rats (5/sex/group for toxicokinetics and 10/sex/group for all other evaluations) at 0 (1,2 propylene glycol vehicle), 31.6, 61.9, or 121 mg/kg bw/day for 4 weeks. Animals were monitored for mortality twice per day, and food consumption, body weights, reflexes, behavior, and general condition were evaluated weekly. Ophthalmic (control and high-dose groups only), hearing, and dental examinations were conducted prior to dosing and during test week 4. Hematology (erythrocytes, hematocrit, hemoglobin, leukocytes) and clinical chemistry (alanine aminotransferase, albumin, alkaline phosphatase, aspartate

⁵ OECD: Organization for Economic Cooperation and Development
Hill's Pet Nutrition, Inc.
January 5, 2011

aminotransferase, urea, calcium, chloride, creatine kinase, creatinine, γ -glutamyltransferase, glucose, glutamate dehydrogenase, inorganic phosphate, potassium, sodium, total bilirubin, total cholesterol, total protein, and triglycerides) parameters were evaluated during Weeks 1 and 4. At the end of the study, animals underwent a full necropsy. The weights of the adrenals, brain, female genital tract, heart, kidneys, liver, ovaries, pituitary, prostate, spleen, testes, and thymus were recorded. Several tissues from the control and high-dose groups, and the liver, kidneys, lungs, and mammary glands of animals in the low- and mid-dose groups, were preserved and examined microscopically.

7.2.2.2 *Mortality, Clinical Signs, Body Weights, etc.*

No deaths occurred in any group. The low- and mid-dose groups exhibited no test article-related effects. Clinical symptoms such as reddish incrustations of the nose or eyes, eschar formation, wounds, or focal alopecia on different locations were present in animals of both sexes and in all study groups, including controls. These findings were therefore considered incidental. At 121 mg/kg bw/day, ALA produced slight hypokinesia in 1 male for 3 days during Week 4. These symptoms were first observed between 45 and 180 minutes after dosing and lasted for a day. Several females in this group exhibited coordination disturbances (staggered and stilted gait) within 30 to 180 minutes after dosing. One female showed reddish salivation and another had slight clonic convulsions on a single occasion. There was no evidence of treatment-related adverse effects on body weight, feed consumption, reflexes, hearing, dentition status, ophthalmological assessments, or urinalysis.

7.2.2.3 *Clinical Chemistry and Hematology*

Slightly, but significantly, lower red blood cells, hematocrit, and platelets counts were observed in females receiving 61.9 mg/kg bw/day at Week 4, compared to the control group. No effects on hematological parameters were observed in any other group. The lack of a dose-response and the occurrence in one sex would therefore suggest these variations were incidental and not treatment-related.

There were no statistically significant differences in clinical chemistry measures in the 31.6 and 61.9 mg/kg bw/day groups compared to control. Male rats in the 121 mg/kg bw/day group had significantly lower cholesterol that persisted until Week 4. Lower total protein and triglyceride levels, and slightly higher alanine aminotransferase and glutamate dehydrogenase levels were also noted in this group. High-dose females had slightly, but significantly, higher blood urea and cholesterol levels. Other findings, including changes in α 1- and γ -globulin, and glutamate dehydrogenase levels were observed in various groups at various time points, but all were considered to be random variations unrelated to ALA treatment.

7.2.2.4 Organ Weights and Histopathology

No gross pathology findings related to treatment were found. No significant differences in absolute or relative organ weights were observed in males from the 31.6 or 61.9 mg/kg bw/day groups. However, at 121 mg/kg bw/day, males had significantly higher liver (relative) and kidney weights (absolute and relative). A statistically significant, dose-dependent increase in relative liver weights was seen in female rats. Relative kidney weights were also significantly higher among females receiving 31.6 or 61.9 mg/kg bw/day of ALA; absolute kidney weights were significantly higher in 121 mg/kg bw/day females. The effects on liver weights were considered adaptive effects, possibly associated with enzyme induction, and not indicative of hepatic toxicity; the effects on kidney weights were not accompanied by any histopathological changes and were therefore considered of no toxicological significance.

Histopathological examinations revealed some minor treatment-related effects in the liver and mammary gland; most were confined to the high-dose group. High-dose males had a higher incidence of centrilobular hypertrophy than control males (8/10 vs. 5/10); the severity of this lesion was also slightly greater (1.6 vs. 1.0). The cytoplasm of these hepatocytes was deeply eosinophilic and contained basophilic cords presumed to represent proliferated rough endoplasmic reticulum. Other effects observed with greater frequency and/or severity among ALA-treated animals included rarefied periportal hepatocytes (due to lipid vacuoles) often accompanied by cytoplasmic basophilia. These changes may constitute an adaptive rather than toxic response. Centrilobular hypertrophy, for example, is typically associated with induction of phase I metabolic enzymes. The severity of hepatic microgranulomas was marginally to slightly greater among high-dose males and females compared to their control counterparts. However, the incidence of this lesion was unaffected by ALA treatment. In these animals, hepatic microgranulomas tended to be larger and more frequent than in control rats. The microgranulomas consisted largely of macrophages and were frequently associated with hepatocyte single-cell necrosis. There were, however, no differences between high-dose and control animals in the reported incidence of single-cell necrosis.

The mammary gland of high-dose group female rats also had a marginally higher incidence of diffuse hyperplasia. The mammary gland of most male rats of all treatment groups and control group showed diffuse proliferation of glandular tissue, which is a common finding in this rat strain.

The no-observable-adverse-effect level (NOAEL) in this study was considered to be 61.9 mg/kg bw/day of ALA.

7.2.3 Two-Year Dietary Study in SD Rats (Cremer *et al.*, 2006b)

7.2.3.1 Study Design

Cremer *et al.* (2006b) examined the toxicity of α -lipoic acid in rats following administration in the diet for 2 years. Male and female Sprague-Dawley (Hsd/Win:WU) rats 38 to 42 days old (body weight of ~100 g) received diets containing 0, 20, 60, or 180 mg racemic (*dl*) α -lipoic acid per kg bw per day. α -Lipoic acid was added to the diet daily in a solution of 1,2-propylene glycol. The amount of test substance added to the feed was adjusted on a weekly basis to compensate for body weight gains. The control and high-dose groups each consisted of 50 animals/sex/group; the remaining groups had 40 animals/sex/group. Ten rats of each sex in the high-dose and control group were killed after 1 year of treatment and underwent a complete necropsy, leaving a nominal 40 animals/sex in all groups to complete the 2-year dosing period. Mortality, food consumption, general condition and behavior, and response to stimuli were recorded daily. Body weights were measured twice weekly for 6 months and approximately monthly thereafter. Ophthalmologic and dental examinations, and a hearing function test were performed at the 1-year time point and at the end of the study. Animals from both the interim and terminal sacrifice underwent a full necropsy that included organ weights (heart, liver, lungs, spleen, kidney, adrenals, thymus, pituitary gland, gonads, thyroid, brain), bone marrow smears, and histopathology of control and high-dose group organ/tissues (heart, lungs, pleural space, liver, spleen, kidneys, adrenals, thymus, pituitary, gonads, thyroid, brain, eyes, bladder, bone marrow, trachea, aorta, esophagus, pancreas, tongue, prostate, lymph nodes, peripheral nerve, skeletal muscle) as well as any gross lesions. Clinical chemistry parameters (liver function, SGPT, creatinine, glucose, urea, SGOT, alkaline phosphatase, bilirubin, total protein, sodium, potassium, chloride, CO₂, uric acid), hematology (hemoglobin, erythrocytes, leukocytes, differential leukocytes count, hematocrit, thrombocytes, reticulocytes, and prothrombin time), and urinalysis (color, specific gravity, pH, protein, ketone bodies, glucose, hemoglobin, bilirubin, microscopic examination of sediment) were also measured.

7.2.3.2 Mortality, Clinical Signs, Body Weights, etc.

As Table 7-4 illustrates, mortality in the α -lipoic acid treatment groups tended to be lower than controls. No deaths occurred before month 15; deaths were generally preceded by a 1- to 4-week period of apathy or in some cases ataxia, loss of appetite followed by rapid weight loss, and lack of grooming. The cause of death was determined to be pneumonia unrelated to treatment.

Table 7-4 Spontaneous deaths among rats receiving α -lipoic acid in the diet for up to 2 years

Dose (mg/kg bw/day)	N (animals/sex/group)	Males	Females
0	40 ¹	10	9
20	40	10	5
60	40	3	8
180	40 ¹	3	7

Deaths occurred at or after 15 months of treatment.

¹Number of animals was 50 at study start; 40 animals remained following interim sacrifice at 12 months.

No treatment-related effects on behavior or hearing function were noted. No effects on body weight or body weight gain were observed in low- or mid-dose group. Food consumption among high-dose males and females was reduced, as were body weight gains (after at least 8 weeks of treatment) and terminal body weights (~13 % lower than control in males and 22 % lower in females). Mean body weights at study start, 1 year, and study end are summarized in Table 7-5.

Table 7-5 Mean body weights of rats receiving α -lipoic acid in the diet for up to 2 years

Sex	Dose (mg/kg bw/day)	Body weight (g)		
		Study start	12 months	24 months
Male	0	102.3 ± 1.9	506.8 ± 28.8	574.2 ± 47.9
	20	102.5 ± 1.7	511.6 ± 24.1	557.9 ± 63.6
	60	102.4 ± 2.1	506.7 ± 19.5	551.3 ± 56.8
	180	102.4 ± 1.8	469.2 ^a ± 24	500.8 ^a ± 56.3
Female	0	102.1 ± 1.7	306 ± 24.9	361.6 ± 35.9
	20	102.4 ± 1.4	296.7 ± 41.3	347.6 ± 48.5
	60	102.3 ± 2	304.5 ± 21.1	334.8 ± 70.5
	180	101.9 ± 1.6	265.3 ^a ± 17.8	280.2 ^a ± 36

^aStudents t-test, significance <0.05 in comparison to control value

Increasing bilateral opacity of the vitreous body was observed in 1 or 2 animals in the low- and mid-dose groups between 14 and 20 months. However, the low number of animals, the absence of a dose-response, and the known occurrence of such alteration in untreated aging rats of this strain, suggest this effect was unrelated to treatment.

7.2.3.3 Clinical Chemistry, Hematology, and Urinalysis

Clinical chemistry, hematology, and urinalysis parameters after 1 or 2 years of treatment were unaffected by treatment.

7.2.3.4 Organ Weights and Histopathology

After 1 year, there were no significant differences in organ weights (absolute or relative). After 2 years, lower absolute organ weights were observed in mid-dose (adrenal) and high-dose (heart and thymus) males, and in high-dose females (liver and lung) compared to their control counterparts. However, no significant differences were noted in organ weights relative to body weights. As Table 7-6 illustrates, macroscopic and histopathological examinations revealed the

presence of neoplasms in both control and treated animals, with no differences in the overall incidence. The majority of neoplasms were reticuloendothelial cell sarcomas (histiocytic lymphomas), evenly distributed across treatment and control groups.

Table 7-6 Summary of neoplastic findings in SD rats receiving α -lipoic acid in the diet for up to 2 years

Tumor prevalence (% of animals with a tumor)	Treatment group (mg/kg bw/day)							
	Males				Females			
	0	20	60	180	0	20	60	180
Tumor prevalence (% of animals with a tumor)	27.5	25	25	30	30	25	25	30
Adenoma								
Liver			2		1	1	1	2
Skin		1			2		1	
Pituitary gland	2	3	2			1	1	1
Mammary gland					2			
Thyroid gland	1	1						2
Adrenal gland						1		
Thymus	1							
Pancreas								1
Testes		1			-	-	-	-
Fibroma								
Skin					3	2		
Carcinoma								
Mammary gland					1			
Testes	1	1	1	2	-	-	-	-
Sarcoma								
Heart (NOS)				1				
Spindle cell	1							
Skin				1		1		
Parotid gland					2			
Thymus	1							1
Uterus	-	-	-	-	1			
Reticuloendothelial cell (histiocytic lymphoma)	7	7	4	8	10	6	7	9

40/sex/group

The no-observable-adverse-effect level (NOAEL) among SD rats receiving α -lipoic acid in the diet for up to 2 years was considered to be 60 mg/kg bw/day.

7.3 Genetic Toxicity

The potential of α -lipoic acid to induce mutations or chromosomal damage was evaluated by Cremer *et al.* (2006a). The results of these studies, discussed in more detail below, show no evidence of mutagenic or clastogenic potential.

7.3.1 Ames Bacterial Mutagenicity Assay (Cremer *et al.*, 2006a)

Cremer *et al.* (2006a) examined the mutagenic potential of α -lipoic acid (ALA) using the Ames bacterial mutagenicity assay as recommended by OECD guidelines and under GLP standards. The OECD-recommended *Salmonella typhimurium* strains TA100, TA1535, TA1537, TA98, and TA102 were studied, along with TA97, which has been shown to be particularly sensitive to endogenous sulfhydryl compounds such as glutathione and L-cysteine. At levels ranging from 15.8 to 5000 $\mu\text{g}/\text{plate}$, ALA was not mutagenic in TA100, TA1535, TA1537, TA98, or TA102 in the presence or absence of an S9 metabolic fraction. In the absence of the S9 mix, TA97 exhibited no mutagenicity in either the plate incorporation or pre-incubation assay. When the metabolic fraction was present, no mutagenicity was evident in this strain in the pre-incubation assay, but a possible weak effect was observed at 5000 $\mu\text{g}/\text{plate}$ in the plate incorporation assay. However, by the standards of the Ames assay, the difference from the solvent controls (1.4- to 2-fold) was not substantial and ALA would therefore be considered non-mutagenic in TA97.

7.3.2 *In vivo* Mouse Micronucleus Assay (Cremer *et al.*, 2006a)

Cremer *et al.* (2006a) examined the potential of α -lipoic acid (ALA) to induce chromosomal damage in mouse erythrocytes. This test was conducted in compliance with GLP standards. Hsd/Win:NMRI mice received a single oral dose of 1,2-propylene glycol (negative control, N=12 animals/sex), ALA (825 mg/kg bw, N=19 males, 17 females), or cyclophosphamide (31.6 mg/kg bw, N=6 animals/sex). Animals were observed for signs of toxicity during the first 5 to 6.5 hours, followed by regular observation on Days 2 and 3. Full necropsies were conducted on animals that died during the observation period. All other surviving animals were sacrificed via CO₂ inhalation after 24 hours (positive control: all mice; negative control: 6/sex; ALA: at least 5/sex) or 48 hours. The ratio of polychromatic erythrocytes (PCE) to normochromatic erythrocytes (NCE) was determined from bone marrow (femurs) smears for each sex in each group at each time point.

Ten mice (6/19 males, 4/17 females) treated with 825 mg/kg bw of ALA died. Necropsy of these animals revealed no significant abnormalities. On the day of dosing, ALA-treated mice exhibited slight hypokinesia (1/19 males), stilted gait (1/19), clonic convulsions (slight: 6/19 males, 5/17 females; moderate: 9/19 males, 10/17 females; severe: 4/19 males, 2/17 females), tonic convulsions (2/19 males, 1/17 females), piloerection (1/19 males), and sunken sides (13/19 males, 3/17 females). In some cases, these effects lasted until the death of the animal. No abnormal clinical signs were observed in negative or positive control animals. The deaths were attributed to greater susceptibility among mice to the acute toxic effects of α -lipoic acid.

Microscopic examination of the bone marrow smears revealed a significant increase in the number of PCEs in animals receiving the positive control, as expected, but no significant differences between the ALA-treated and negative control groups, suggesting ALA does not induce chromosomal damage.

Table 7-7 Summary of toxicological assays of α -lipoic acid in rodents

Endpoint	Test System	Test Material	Dosage or Concentration	Result	OECD/ GLP Compliance	Reference
Acute oral (gavage) toxicity	Rat Sprague-Dawley IGS Br Female Up-and-down test method	α -lipoic acid (racemic), 99.0 % purity	Single dose starting with 175 mg/kg bw in 1 rat, followed by 550 mg/kg bw in a second rat, and 2000 mg/kg bw in 3 other rats; 14-day observation period.	LD ₅₀ : > 2000 mg/kg bw <u>175 and 550 mg/kg bw</u> No mortality or signs of toxicity. <u>2000 mg/kg bw</u> No mortality but sedation, apathy, piloerection, hunched posture, and/or eye closure noted within 2-6 hr post-dose.	OECD Test Guideline 425 GLP-compliant	Cremer <i>et al.</i> (2006a)
Acute oral toxicity	Rat Sprague-Dawley 10/sex/group	<i>dl</i> -thioctic acid	Single dose. Amount administered not specified. Procedure used for oral administration (<i>e.g.</i> , gavage) not specified.	LD ₅₀ : 1320 mg/kg bw in males; 1130 mg/kg bw in females Maximum non-lethal oral dose. 500 mg/kg in males, 350 mg/kg in females	Not specified	Fuke <i>et al.</i> (1972) (translation of Japanese article)
Subchronic oral (gavage) toxicity Dose-range finding	Rat Wistar	α -lipoic acid (racemic), 99.0 % purity	Doses (mg/kg bw/day) 68.1 147 316 681 Administered for 2 weeks.	NOAEL: 68.1 mg/kg bw/day <u>68.1 mg/kg bw/day</u> No adverse effects noted <u>147 mg/kg bw/day</u> Severe symptoms of toxicity (hypokinesia, coordination disturbances, sunken sides, and clonic convulsions) noted. <u>316 and 681 mg/kg bw/day</u> Lethal effects.	Not specified	Cremer <i>et al.</i> (2006a)

Table 7-7 Summary of toxicological assays of α -lipoic acid in rodents (Cont'd)

Endpoint	Test System	Test Material	Dosage or Concentration	Result	OECD/ GLP Compliance	Reference
Subchronic oral (gavage) toxicity	Rat Wistar 15/sex/group	α -lipoic acid (racemic), 99.0 % purity	<p>Doses (mg/kg bw/day)</p> <p>0*</p> <p>31.6</p> <p>61.9</p> <p>121</p> <p>Administered for 4 weeks.</p> <p>*Vehicle: 1,2-propylene glycol</p>	<p>NOAEL: 61.9 mg/kg bw/day</p> <p>No mortality.</p> <p>Higher (statistically-significant and dose-dependent) relative liver weights in F. More frequent and/or severe rarefied periportal hepatocytes often accompanied by cytoplasmic basophilia in α-lipoic acid-treated animals.</p> <p><u>31.6 and 61.9 mg/kg bw/day</u> Higher relative kidney weights in F. No effects on clinical signs, hematology (slight effects in mid-dose F considered incidental), clinical chemistry, body weight, M organ weights; food intake, reflexes, hearing, dentition status, ophthalmological assessments, or urinalysis.</p> <p><u>121 mg/kg bw/day</u> Lower serum total protein and triglycerides, and slightly higher ALT and GDH.</p> <p>Males: slight hypokinesia (45-180 min post-dose) in 1 animal for 3 days during Wk 4; lower serum cholesterol that persisted until study end; higher liver (relative) and kidney weights (absolute/relative); more frequent and/or severe centrilobular hypertrophy; hepatic microgranulomas (mostly macrophages) tended to be of marginally to slightly greater severity, larger, more frequent, and associated with single-cell necrosis.</p> <p>Females: incoordination (staggered and stilted gait) within 30-180 min in several animals; reddish salivation and slight clonic convulsions one time, each in 1 animals; slightly higher blood urea and cholesterol; higher absolute kidney weights; marginally higher incidence of diffuse hyperplasia in mammary gland.</p>	GLP-compliant	Cremer <i>et al</i> (2006a)

Table 7-7 Summary of toxicological assays of α-lipoic acid in rodents (Cont'd)

Endpoint	Test System	Test Material	Dosage or Concentration	Result	OECD/ GLP Compliance	Reference
Chronic oral (diet) study	Rat Sprague-Dawley (Hsd/Win:WU) 40/sex/group ¹	α-lipoic acid (racemic), 99.0 % purity	Diets providing intakes of (mg/kg bw/day) 0* 20 60 180 Administered for 2 years. *Vehicle: 1,2-propylene glycol	NOAEL: 60 mg/kg bw/day No effects on behavior, hearing, hematology, clinical chemistry, urinalysis, relative organ weights, or overall incidence of neoplasms. The following subsets of animals died at or after 15 months due to pneumonia unrelated to treatment: <u>0 mg/kg bw/day</u> 10 M; 9 F <u>20 mg/kg bw/day</u> 10 M; 5 F <u>60 mg/kg bw/day</u> 3 M; 8 F <u>180 mg/kg bw/day</u> 3 M, 7 F Significantly lower food consumption, body weight gains (≥8 wk), and terminal body weights at 180 mg/kg bw/day.	Not specified	Cremer <i>et al.</i> (2006b)

¹ The control and high-dose groups each started with 50 rats/sex; 10 rats/sex from each of these groups was sacrificed at 6 months, leaving 40 rats/sex/group to complete the study.

M: male; F: female, LD₅₀: oral median lethal dose; NOAEL: no-observable-adverse-effect level; ALT alanine aminotransferase, GDH: glutamate dehydrogenase.

7.4 Reproductive Toxicity

No studies were found in the published scientific literature that specifically evaluated the effects of α -lipoic acid on reproduction. However, as a substance produced endogenously by most organisms, and present in the diet at low levels, reproductive toxicity studies of α -lipoic acid would generally be considered a low priority, especially considering that:

- (1) well-conducted repeat-dose toxicity tests can in most cases detect substance-related adverse effects on the male and female reproductive tract, and provide an alert for possible effects on fertility (Dent, 2007);
- (2) adverse effects of α -lipoic acid on the developing offspring might occur only with dosages that far exceed real-life exposures;
- (3) data from teratogenicity studies of thousands of chemicals over the past several decades suggest that there is substantial discordance among species (Bailey *et al.*, 2005); and
- (4) aside from being costly and using large numbers of animals, teratogenicity studies of α -lipoic acid would provide information that is of limited value because all chemicals, including those present in foods and essential to survival (*e.g.*, vitamins, water, sodium), can be classified as teratogenic if given to the right animal species at the right dose and time.

Additional considerations suggesting that exogenous α -lipoic acid (including racemic mixtures) is unlikely to cause reproductive toxicity include its:

- low level of toxicity – no demonstrated effects in reproductive tissues or clinical chemistry endpoints in dogs or rats
- rapid metabolism and excretion across multiple animal species
- potential to enhance endogenous antioxidant defenses
- reported ability to
 - protect against embryonic resorptions, intrauterine growth retardation, and/or fetal malformations associated with streptozocin-induced diabetes in rodents (Wiznitzer *et al.*, 1999; Al Ghafli *et al.*, 2004; Sugimura *et al.*, 2009);
 - protect against cyclophosphamide-induced testicular toxicity in the rat (Selvakumar *et al.*, 2004); and

- improve the quality (motility) and integrity (reduced DNA damage) of sperm during cryopreservation (Ibrahim *et al.*, 2008).

In the aforementioned studies of the effects of lipoic acid on offspring development following streptozocin-induced diabetes, subsets of intact animals (non-diabetic) received lipoic acid⁶ alone *via* intraperitoneal injection during gestation. With the exception of lower maternal weight gains among Sprague-Dawley rats receiving lipoic acid (0.5 mL in Tris buffer; 30 mg/kg) during the study by Wiznitzer *et al.* (1999), there were no significant differences among lipoic acid-treated, untreated, and/or vehicle-treated control rats (Sprague-Dawley or Wistar) or mice (ICR) in: implantations; viable offspring; resorptions; fetal weight/size; intrauterine growth; or morphological/skeletal abnormalities (Wiznitzer *et al.*, 1999; Al Ghafli *et al.*, 2004; Sugimura *et al.*, 2009). The difference in routes of administration precludes the use of these findings as direct evidence of lipoic acid's safety when administered in the diet to pregnant dogs. Nevertheless, the absence of adverse effects on multiple measures of offspring development in multiple studies provides supporting evidence that lipoic acid does not interfere with reproduction.

(b) (4) the intended supplier of the racemic mixture to be used by Hill's, has conducted reproductive toxicity studies. Although the findings of these studies have not been published, (b) (4) has graciously provided the overall results to Hill's. These results are discussed subsequently and are summarized in Table 7-8, along with the findings of other important α -lipoic acid multiple-dose toxicity studies previously discussed.

A study of fertility and early embryonic development in rats following oral (gavage) administration to males prior to and during mating, and to females until Day 7 of pregnancy, resulted in a no-observable-effect level (NOEL) of 68.1 mg/kg bw/day, the highest dosage tested. In a separate study, F₀ rats exposed orally (gavage) to 14.7, 31.6, or 68.1 mg/kg bw/day during gestation and lactation exhibited transient decreases in activity and food consumption at the mid- and high dose levels (NOEL: 14.7 mg/kg bw). Due to a slightly lower lactation index at the high dose, the NOEL for F₁ offspring through sexual maturity was considered to be 31.6 mg/kg bw. The NOEL for F₂ generation offspring until weaning was considered to be 68.1 mg/kg bw.

Although details about the design and conduct of the (b) (4) studies are presently unavailable, the results show no evidence reproductive toxicity in rats following exposure to α -lipoic acid doses 8 to 18 times higher than the intended dose in dogs (31.6 mg/kg bw/day NOEL vs. ~1.8 to 3.8 mg/kg bw/day depending on size; see Table 4-2), supporting the assertion that α -lipoic acid is unlikely to interfere with fertility and offspring development.

⁶ For most of these studies the form of lipoic acid used was not specified; a racemic mixture (*DL*- α -lipoic acid) was used by Selvakumar *et al.* (2004). It is presumed that a racemic mixture was used in all studies, since most commercially-available lipoic acids are synthesized mixtures of R- and S- enantiomers.

Table 7-8 Results of (b) (4) α-lipoic acid reproductive toxicity studies, compared to multiple-dose toxicity study findings

Species		NOAEL/NOEL (mg/kg bw/day)	Duration of exposure	Route of exposure	α-Lipoic acid dosage (mg/kg bw/day)
(b) (4) Studies (further details unavailable)	Rat (SD)	NOEL: 68.1 [for parental toxicity, fertility; embryonic development (to Day 13 of gestation)]	M. week 4 prior to mating to the end of mating F. 2 weeks prior to mating to Day 7 of gestation	Oral gavage	14.7 31.6 68.1
	Rat (SD)	F ₀ NOEL: 14.7 [decreased activity/food consumption noted at mid- and high-dose]	F ₀ dams only from Day 6 of gestation until Day 22 of lactation	Oral gavage	14.7 31.6 68.1
		F ₁ NOEL: 31.6 [slightly lower lactation index at high-dose]			
		F ₂ NOEL: 68.1 [to weaning]			
Dog ¹		NOAEL: 82	up to 1 year	Diet	82 53 26 2.5
Rat ² (Wistar)		NOAEL: 61.9	4 weeks	Oral gavage	61.9
Rat ³ (SD)		NOAEL: 60	2 years	Diet	60

NOAEL: no-observable-adverse-effect level, NOEL: no-observable-effect level; M: male; F: female.

¹ Zicker *et al.* (2002) published 6-month interim findings; 1-year data unpublished.

² Cremer *et al.* (2006a)

³ Cremer *et al.* (2006b)

8.0 SUPPORTING DATA

8.1 Studies conducted by (b) (4) *dl*- α -lipoic acid supplier

(b) (4) the intended supplier of the material to be used by Hill's, has independently conducted several toxicity studies for their *dl*- α -lipoic acid product. These studies are listed in Table 8-1. Although the details of the studies are not currently available, these data further support the safety of α -lipoic acid in the proposed application.

Table 8-1 Summary of studies conducted by (b) (4)

Study Type	Title
Ames test	<i>Salmonella typhimurium</i> Reverse Mutation Assay Report on D-20557
Subacute toxicity/dog/oral	D-20557 (Thioctic Acid, racemate) 4-week oral toxicity study after repeated oral administration in Beagle dogs
Gene mutation assay	Thioctic Acid (D-20557) <i>In Vitro</i> Mammalian Cell Gene Mutation (HPRT) Test in V79 Chinese Hamster Fibroblasts
Subchronic toxicity/rat/oral	D-20557 (Thioctic Acid, racemate) 26-Week Oral Toxicity Study After Repeated Administration in Rats and Subsequent 6-Week Recovery Period
Ames test	<i>Salmonella typhimurium</i> reverse mutation assay report on D-20557
Subacute toxicity/rat/oral	Thioctic Acid, racemate - 4-week oral toxicity study after repeated administration in rats
Reproduction/rat/1 generation	Examination of the Influence of D-20557 (Thioctic Acid, Racemate) on the Fertility and Early Embryonic Development to Implantation of Sprague-Dawley Rats by Oral Administration to the Animals of the F0-Generation - according to the ICH-Guideline -
Subacute toxicity/rat/oral	D-20557 (Thioctic Acid, racemate) 4-week oral toxicity study after repeated oral administration in rats
Palatability	D-20557 (Thioctic Acid Racemate) Orientating Palatability and Maximum Tolerable Dose Finding Study after 4 Weeks Oral Administration as Diet Admixture in Rats Inclusive Plasma Level Determination (Bridging Study to a Carcinogenicity Study in Rats, Report No. D-2055713000522843)
Teratogenicity/mouse Teratogenicity/rat	Effect of thioctic acid on fetuses when it is administered to pregnant animals
Subchronic toxicity/rat/oral	26-Week toxicity of thioctic acid on oral administration to Wistar rats
Teratogenicity/rat	Über den Einfluss von Thioctsaure, A.Nr. 31967 - hier kurz "Thioctsaure" genannt - Auf die trachtige Ratte und den Foetus bei Verabreichung per Magensonde
Acute toxicity/mouse/oral	Akute Toxizität von Thioctsaure A.Nr. 31967 an NMRI-Mäusen bei Peroraler Verabreichung
Micronucleus test/mouse	D-20557 (Thioctic Acid, racemate) Mouse Micronucleus Test (Single Oral Administration)
Subchronic toxicity/dog/oral	6-Monate-Toxizität von Thioctsaure an Beagle-Hunden bei Verabreichung per Kapsel
Micronucleus test	D-20557 (Thioctic Acid, racemate) - Mouse Micronucleus Test (Single Oral Administration)
Gene mutation	D-20557 (Thioctic Acid, Racemate) <i>In Vitro</i> Mammalian Cytogenetic Test in V79 Chinese Hamster Fibroblasts (Chromosome Analysis)
Fertility/rat	Examination of D-20557 (Thioctic Acid, Racemate) for Effects on the Pre and Postnatal Development (Including Maternal Function) Following Oral Administration to the Dams of Rats of the F0 - Generation - Segment 111 Study -
Toxicity/monkey/oral	Maximum-Tolerated-Dose (MTD) Study of D-20557 (Thioctic acid, Racemate) by Oral Administration to <i>Cynomolgus</i> Monkeys
Chronic toxicity/rat/oral	2-Jahre-Toxizität von Thioctsaure (kurz "TS" genannt) bei peroraler Verabreichung an Sprague-Dawley-Ratten
Acute toxicity/rat/oral	Über die Akute Toxizität von Thioctsaure, A.Nr. 31 967 - Kurz "TS" - an Sprague-Dawley-Ratten bei Peroraler Verabreichung

8.2 Supporting Studies in the Target Animals Species (Dog)

Hill's has sponsored several studies in dogs using α -lipoic acid at levels up to 135 ppm alone and in combination with other substances. These studies, some of which have been published, are summarized in Table 8-2.

At least 3 of the studies measured the nutritional adequacy of the food over 6 to 7 months, based on AAFCO requirements. None of these studies showed adverse effects on body weights, body weight gains, food consumption, or clinical chemistry parameters (hemoglobin, PCV, albumin, alkaline phosphatase). Similarly, other cognitive/behavioral studies in dogs showed no evidence of adverse effects on overall health, body weights, hematology, or clinical chemistry. The absence of adverse effects in these studies further support the conclusion that there is reasonable certainty that no harm will result from use of α -lipoic acid at 150 ppm in dry foods intended for adult dogs.

Table 8-2 Summary of published and unpublished studies of Hill's canine formulas containing α -lipoic acid

Endpoint Measured	Clinical Measures of Safety	Product Tested	Animals	Duration	Reference
<p>Nutritional adequacy of food for maintenance of adult dogs based on AAFCO Feeding Protocol (2000)</p> <p>Product met AAFCO requirements</p>	<p>Initial and final body weights at, body weight gains, food consumption, hemoglobin, packed cell volume (PCV), albumin, alkaline phosphatase</p> <p>All parameters were within acceptable limits.</p>	<p>Hill's Science Diet® Canine Senior® NM Prototype Dry Formula</p> <p>Formula: 16668</p> <p>Lot Number: 11/99, 1 MAR 00</p> <p>~135 ppm α-lipoic acid</p>	<p>8 Dogs (ID D054, D055, D056, D060, D064, D065, D067, D081)</p>	<p>1/27/00 to 9/6/00 (~6 months)</p> <p>Lovelace Respiratory Research Institute</p>	<p>Study Number: 100219 FY2000-010R</p> <p>Document Number: 100219 FY2000-010R</p> <p>Protocol: 2000 AAFCO Canine Adult Maintenance</p>
<p>Nutritional adequacy of food for maintenance of adult dogs based on AAFCO Feeding Protocol (2001)</p> <p>Product met AAFCO requirements</p>	<p>Initial and final body weights, body weight gains, food consumption, hemoglobin, packed cell volume (PCV), albumin, alkaline phosphatase</p> <p>All parameters were within acceptable limits.</p>	<p>Project Mikey Prototype (22204) dry canine formula</p> <p>Formula: 22204-1</p> <p>Lot Number: 2/1/01</p> <p>~135 ppm α-lipoic acid</p>	<p>7 Dogs* (Petunia, Daisy, George, Petey, Babs, Morris, Zed)</p> <p>*1 dog (Nigel) removed from the study at 2 weeks due to poor food intake.</p>	<p>2/14/01 to 8/15/01 (6 months)</p> <p>Ontario Nutri Lab Inc. (Canada)</p>	<p>Study Number: 100300 CMDO12374</p> <p>Document Number: 100300 CMDO12374R</p> <p>Protocol: 2001 AAFCO Canine Adult Maintenance</p>
<p>Nutritional adequacy of food for maintenance of adult dogs based on AAFCO Feeding Protocol (2001)</p> <p>Product met AAFCO requirements</p>	<p>Initial and final body weights at, body weight gains, food consumption, hemoglobin, packed cell volume (PCV), albumin, alkaline phosphatase</p> <p>All parameters were within acceptable limits.</p>	<p>Project Mikey Prototype (22205) dry canine formula</p> <p>Formula: 22205-1</p> <p>Lot Number: 2/1/01</p> <p>~120 ppm α-lipoic acid</p>	<p>7 Dogs* (Bandit, Dino, Dana, Hiwaj, Muffin, Kate, Fawn)</p> <p>*1 dog (Fred) removed from the study at 2 weeks due to poor food intake.</p>	<p>2/14/01 to 9/12/01 (~7 months)</p> <p>Ontario Nutri Lab Inc. (Canada)</p>	<p>Study Number: 100300 CMDO12375</p> <p>Document Number: 100300 CMDO12375R</p> <p>Protocol 2001 AAFCO Canine Adult Maintenance</p>

Table 8-2 Summary of published and unpublished studies of Hill's canine formulas containing α -lipoic acid (cont'd)

Endpoint Measured	Clinical Measures of Safety	Product Tested	Animals	Duration	Reference
Cognitive	<p>Physical, neurologic, and ocular exams, blood counts and serum chemistry prior to start, and at 3 and 6 months after treatment, and thyroid panel.</p> <p>No neurologic, musculoskeletal, ocular, or physical abnormalities that would have excluded participation in the study were noted. Blood chemistry analysis showed no differences within the young group. Within the old dogs, alkaline phosphatase and creatine kinase levels were significantly higher in control animals, and above the normal range in some animals from both the control and treated groups. The difference in creatine kinase was no longer significant at 6 months, but the difference in alkaline phosphatase persisted. Significant differences attributable to age included higher total protein, globulin, cholesterol, triglycerides, and red blood cells, and lower albumin, creatinine, calcium, sodium, and T3.</p>	<p>Approximately 300 g per day of test diet containing:</p> <p>1050 ppm <i>d</i>-alpha-tocopherol acetate (vs. 120 in control diet)</p> <p>260 ppm L-carnitine (vs. <20 ppm)</p> <p>128 ppm <i>d</i>-alpha-lipoic acid (vs. <20 ppm)</p> <p>80 ppm ascorbic acid as Stay-C (vs. <30 ppm)</p> <p>Fruits and vegetables rich in flavonoids, carotenoids, and other antioxidants (1% of each of the following as 1:1 exchange for corn): spinach flakes, tomato pomace, grape pomace, carrot granules, and citrus pulp.</p>	<p>Beagle dogs:</p> <p>12 aged (age ~10 years) and 9 young (age ~3 years) at the start of treatment</p>	6 months	Milgram <i>et al.</i> (2002)
Cognitive and behavioral	<p>Body weights at 30 days were comparable between treatment and control groups and not significantly different from baseline. No body weight measurements at 60 days (study end) were provided.</p>	<p>Diet formulated to include vitamin C, alpha-lipoic acid, L-carnitine, docosahexaenoic acid (DHA), and eicosapentaenoic acid (EPA) (similar to Hill's Prescription Diet Canine b/d)</p>	<p>61 dogs, most of mixed breed, with median age of 11 years (range 7 to 20) and median body weight of 40.5 lb (range 5.1 to 113.1) at the start of treatment</p>	60 days	Dodd <i>et al.</i> (2003)
Cognitive	<p>Physical exam, hematology and clinical chemistry at 7 days prior to treatment and at the end of the study.</p> <p>The results of these tests were not provided.</p>	<p>Approximately 300 g per day of test diet formulated to include low, moderate, and high levels of antioxidants</p> <p>Vitamin E: 83, 173, 799 ppm Vitamin C: <32, <32, 114 ppm L-Carnitine: 13, 42, 294 ppm Lipoic acid: <20, <20, 135 ppm</p>	<p>Low: 10 beagle dogs</p> <p>Moderate: 9 beagle dogs</p> <p>High 10 beagle dogs</p>	3 months	Ikeda-Douglas <i>et al.</i> (2004)

Table 8-2 Summary of published and unpublished studies of Hill's canine formulas containing α -lipoic acid (cont'd)

Endpoint Measured	Clinical Measures of Safety	Product Tested	Animals	Duration	Reference
Behavioral	<p>Physical, neurologic, and ocular exams, blood counts and serum chemistry prior to start, and at 6 and 12 months after treatment, and thyroid panel</p> <p>No neurologic, musculoskeletal, ocular, or physical abnormalities that would have excluded participation in the study were noted; the results of other tests were not provided.</p>	<p>Approximately 300 g per day of test diet containing:</p> <p>1000 ppm dl-alpha-tocopherol acetate (vs 120 in control diet)</p> <p>275 ppm L-carnitine (vs. 20 ppm)</p> <p>125 ppm dl-alpha-lipoic acid (vs 20 ppm)</p> <p>80 ppm ascorbic acid as Stay-C (vs. 30 ppm)</p> <p>Fruits and vegetables rich in flavonoids, carotenoids, and other antioxidants (1% of each of the following as 1:1 exchange for corn): spinach flakes, tomato pomace, grape pomace, carrot granules, and citrus pulp.</p>	<p>Beagle dogs: 12 aged (age ~10 years) and 9 young (age ~3 years) at the start of treatment</p>	2 years	Milgram <i>et al.</i> (2004, 2005)

9.0 ADDITIONAL CONSIDERATIONS

9.1 Reports of Accidental Toxicity in Dogs

Two cases of possible accidental alpha-lipoic acid toxicity in dogs were recently published by Loftin and Herold (2009). One dog, a 1.5-year-old neutered male Greater Swiss Mountain dog weighing 31.4 kg, developed hypoglycemia and associated clinical signs after ingesting approximately 191 mg/kg of a product described as Thioctic Acid D form (300-mg tablets). Various forms of treatment (intravenous fluids, plasma transfusion, *etc.*) were administered and the animal was discharged after a few days. Follow-up at 4 months after discharge revealed no lasting effects. A second dog, a 3.5-year-old spayed female American Staffordshire Terrier weighing 23.5 kg, developed weakness, lethargy, vomiting, and renal failure after ingesting approximately 50 100-mg gel tablets containing alpha-lipoic acid. The estimated intake of alpha-lipoic acid was 210 mg/kg. This animal's condition continued to decline and she was ultimately euthanized 16 hours after admission to the hospital.

The highest mean α -lipoic acid exposure level among dogs in the 1-year study presented herein as evidence of safety (see sections 6.1.1. and 6.1.2) was approximately 1200 mg/day or 82 mg/kg bw/day (see Appendix 8) from its inclusion in the diet at approximately 4500 ppm (1260 μ g/kcal). No adverse effects related to α -lipoic acid exposure were noted. The 2 dogs in the Loftin and Herold (2009) report consumed more than twice this amount of α -lipoic acid.

α -Lipoic acid is intended to be used in dry canine foods at levels up to 150 ppm (150 mg/kg or 42 μ g/kcal of food). This level of use approximates the lowest inclusion rate of 150 ppm (145 ppm as-fed and 157 ppm dry matter) used in the 1-year study in dogs, which resulted in an α -lipoic acid intake of approximately 2.5 mg/kg bw/day. In the 2 reported cases of possible alpha-lipoic acid toxicity, the dogs consumed more than 75 times this amount in a short period of time.

9.2 Toxicity in Cats

It has been suggested that cats are more susceptible to α -lipoic acid-related toxicity than humans, dogs, or rats. Hill *et al.* (2004) studied the effects of a single dose of α -lipoic acid given orally in a gelatin capsule to healthy intact adult (1.5 to 6.5 years old) male cats. Out of 10 cats, 3 received an empty capsule (control), 4 received 60 mg/kg bw of α -lipoic acid, and 3 received 30 mg/kg bw. Animals were monitored for clinical signs over 24 hours after dosing; blood samples were collected at 0, 2, and 24 hours for blood counts and serum chemistry, ammonia, total bile acid, and lipoic acid and dihydrolipoic concentrations. One high-dose animal died within 6 hours after dosing; the remaining 3 exhibited clinical signs of toxicity (hypersalivation, hyper-irritability, ataxia, and reduced food intake). A persistent increase (5 x baseline for up to 24 h) in serum ammonia was observed in high-dose animals, along with some changes in ALT,

and to a lesser extent AST, levels 2 hours after dosing. No clinical signs or significant differences in biochemical measures were noted between control and low-dose animals. However, histopathological examinations (liver, kidney, spleen, lung, duodenum, pancreas, skeletal muscle) revealed changes in the liver at both dose levels.

The centrilobular regions of the liver of animals receiving α -lipoic acid (low- and high-dose) showed swelling, granular to vesicular cytoplasm, loss of distinct sinusoidal linings, and lack of lipid or glycogen stores. Electron microscopy of one cat each from the high-dose and control groups revealed altered organelle organization and appearance, cytoplasmic vacuoles, and various other changes in the high-dose animal. The hepatocellular abnormalities observed in these animals were considered to be consistent with nonspecific acute toxicity that disrupts hepatic processes, such as those that occur in rodents exposed to acetaminophen or thiocyanate compounds. Based on these results, the authors suggested that the maximum tolerated dose (MTD) of α -lipoic acid given as a single oral dose to cats was < 30 mg/kg bw, and the calculated⁷ MTD was 13 mg/kg bw. However, it is important to note that there is no standard definition for MTD. Based on the prevailing toxicological definition, the 30 mg/kg bw dose would be considered the *maximum tolerable dose*, the "highest amount of a substance that, when introduced into the body, does not kill test animals"; it might also be more appropriate to define the 13 mg/kg bw dose as a no-effect level (NEL), the "maximum dose that produces no detectable changes under defined conditions of exposure" (IUPAC, 1993).

During the course of a subsequent study of the effects of dietary antioxidant supplementation on oral acetaminophen challenge, Hill *et al.* (2005) administered a test diet top-dressed with 150 mg of α -lipoic acid per kg diet on a dry-matter basis to healthy adult cats (3/sex/group) for at least 15 weeks; this is the same level being proposed herein for dry dog foods (150 ppm). α -Lipoic acid exposure among cats receiving the test diet was estimated to be 3 mg/kg bw/day, based on 4- to 5-kg body weight and 75 to 100 g diet/day food consumption estimates. Analysis of blood samples (Weeks 0, 5, 10, and 15) from cats receiving the α -lipoic acid diet revealed no significant differences in serum biochemical values at any time point. Mean plasma arginine concentrations were significantly lower in treated cats (94 ± 10 vs. 125 ± 19 nmol/mL in control) from Week 5 until the end of the study. This effect was considered possibly related to cellular damage induced by α -lipoic acid; however, no histopathological examinations were performed in this study.

α -Lipoic acid as proposed herein is intended for use in dry canine foods exclusively. It is neither intended nor expected that this diet would serve as a regular source of nutrition for felines. However, since in households with both dogs and cats, cats may be inadvertently exposed to α -

⁷ Based on the toxicity responses recorded in sequence and use of the equation $MTD = X_f + kd$, where X_f is the log of the final dose administered, k is the Dixon derived value (from Dixon computational tables) and d is the interval between the log of the doses.

lipoic acid through occasional consumption of dog food, estimates of potential exposure among cats with body weights ranging from 4 to 7 kg and consuming 60 to 100 g diet for maintenance have been determined and are listed in Table 9-1.

Table 9-1 Estimated α -lipoic acid exposure among cats of various sizes from collateral consumption of the proposed dry dog food[†]

Body weight (kg)	α -Lipoic acid intake (mg/kg bw/day) based on food intake of:	
	60 g/day (9 mg α -lipoic acid /day)	100 g/day (15 mg α -lipoic acid /day)
4	2.2	3.8 [‡]
5	1.8	3.0
6	1.5	2.5
7	1.3	2.1

[†] Values are based on the assumption that the dog food is equivalent to cat food in its caloric value.

[‡] Food consumption at this level not likely to be repeated day after day.

Depending on body weight, age, activity level, *etc.*, an adult domestic cat might consume 60 to 100 g of food per day for maintenance (0.06 to 0.1 kg/day). As is true of dogs (see section 4.2), consumption of dry dog food containing 150 ppm α -lipoic acid would result in higher exposures (on a per kg bw basis) among smaller cats. However, it is important to note that all species self-regulate food intake based on the calories needed for maintenance, and that exposure to α -lipoic acid is self-limiting across body sizes because the amount of α -lipoic acid/kcal will be constant in the diet (~42 μ g/kcal).

A 4-kg cat would need roughly 240 kcal/day to maintain body weight. Using a rule of thumb of 4 kcal/g of cat food, this cat would require about 60 g of food per day. If this cat ate dog food exclusively and the cat and dog diets had the same caloric value, α -lipoic acid intake would be about 2 mg/kg bw/day; 2.6 mg/kg bw/day from about 70 g of food per day for maintenance if the dog diet were to contain 3.5 rather than 4 kcal/g.

In a rare but worst-case scenario, a very hungry 4-kg adult cat consuming 100 grams of dog food (3.5 kcal/g assumed) per day would exceed the amount of food needed for maintenance by 30 g (approx 100 kcal), resulting in about 40% excess calories daily, and an intake of 3.8 mg α -lipoic acid /kg bw/day. However, routine consumption of 100 g of dog food per day by a 4-kg cat is considered unlikely.

α -Lipoic acid exposures among cats from collateral consumption of the proposed dog food is expected to be episodic and most likely in the 2 to 3 mg/kg bw/day range. This is 10 to 15 times lower than the 30 mg/kg bw we consider the *maximum tolerable dose* (not lethal) in cats based on the Hill *et al.* (2004) study, and 4 to 6 times lower than the 13 mg/kg bw we consider to be the no-effect level. Hill *et al.* (2005) reported that dietary exposure to 3 mg α -lipoic acid/kg bw/day was associated with slightly, but consistently, low mean plasma arginine concentrations.

However, it was not possible to determine whether this effect was related to cellular damage induced by α -lipoic acid, as suggested by the authors, because no histopathological examinations were performed. It is noteworthy that exposure to the α -lipoic acid-containing diet for up to 15 weeks was not associated with any significant differences in serum biochemistry values.

9.3 Studies of α -Lipoic Acid Polymer

Shimoda *et al.* (2007) examined the potential toxicity of α -lipoic acid polymers formed during manufacturing. Polymers produced by heating (LAP-A) and by ethanol treatment (LAP-B) were administered in the diet to mice (6/sex/group) at 0.1% and 0.2% for 4 weeks. Control animals received a standard diet. No statistically-significant differences were observed in food consumption, body weights, or body weight gain. Some slight but statistically-significant differences ($p < 0.05$ or $p < 0.01$) in serum biochemistry parameters were noted (higher uric acid levels in both sexes and higher potassium levels in females), but generally with no apparent relationship to dose. Organ weights were unaffected, except for relative liver weights, which were slightly but significantly higher ($p < 0.05$ or $p < 0.01$) among mice receiving either 0.1% or 0.2% of LAP-A, and those receiving 0.2% LAP-B.

With the exception of slightly but significantly ($p < 0.01$) higher serum bilirubin levels, oral administration of a single 500 mg/kg dose of LAP-B to fasted dogs ($n=4$) did not affect hematology or serum biochemistry parameters measured after 24 hours.

Although heating would be part of the process used for production of Hill's α -lipoic acid-containing canine foods, polymerization is considered unlikely due to the dilution effect. This is supported by the demonstrated high rate of recovery of α -lipoic acid (>80%) in the finished product (see Appendix 7).

10.0 SUMMARY AND CONCLUSION

Hill's Pet Nutrition, Inc. intends to use α -lipoic acid in dry foods for adult dogs (*i.e.*, at least 1 year old) at levels up to 150 ppm (150 mg/kg food or 0.0150%). α -Lipoic acid would be used as a cellular antioxidant and cofactor of enzymes involved in the metabolism of carbohydrates and amino acids.

Hill's sought to establish through scientific procedures that the use α -lipoic acid in dry foods for adult dogs as specified qualifies as generally recognized as safe (GRAS). To accomplish this task, Hill's and Cantox compiled information regarding the nature of the substance, specifications, manufacturing, proposed conditions of use, and technical evidence of safety into the present GRAS dossier. Hill's also sought the opinion of an "Expert Panel" specifically convened for the purpose of reviewing the information herein to determine whether there is a consensus among qualified experts that the use of α -lipoic acid as intended entails a reasonable certainty of no harm and would be generally recognized as safe. At the time of its review, the Expert Panel relied on the criteria established by FDA CFSAN for evaluation of GRAS substances added to human foods, in the expectation that the pending FDA CVM GRAS policy for substances used in animal foods would be similar. Having considered all the available information, the members of the Expert Panel concluded that there is reasonable certainty that no harm will result from the use of α -lipoic acid as described and that such use may be considered GRAS.

As discussed in previous sections of this document, the R-enantiomer of α -lipoic is synthesized endogenously by most organisms and is a cofactor essential to proper mitochondrial function. The material Hill's intends to use in canine foods (CAS RN 1077-28-7; *dl*- α -lipoic acid) is an exogenous racemic mixture (R- and S-enantiomers) produced by one or more manufacturers using conventional food industry processes, in accordance with Good Manufacturing Practice (GMP) standards, and, importantly, within rigid specifications established by Hill's. Such racemic mixtures are widely used in (human) dietary supplements providing up to 600 mg α -lipoic acid/person/day (10 mg/kg bw/day in a 60-kg person).

Several studies were presented herein as evidence of the safety of α -lipoic acid, including a 6-month to 1-year dietary safety study in dogs, and several published studies that included a chronic (2-year) oral toxicity study in rats, several dog studies with nutritional, cognitive, or behavioral endpoints, and genotoxicity assays. There were no treatment-related adverse effects in any of the animal studies, and *dl*- α -lipoic does not appear to possess any genotoxic or carcinogenic potential.

Exposure to α -lipoic acid among dogs from its use in canine foods as proposed (150 ppm) is expected to be approximately 2 to 4 mg/kg bw/day; highest in small dogs on a per kg body weight basis.⁸ As Figure 10-1 shows, this is at about 20 to 40 times lower than the NOAEL from the 1-year dog dietary study (82 mg/kg bw/day), 50 to 100 times lower than the dose reported to be toxic in dogs (200 mg/kg bw), and 15 to 30 times lower than the NOAEL from the 2-year rat dietary study (60 mg/kg bw/day). Exposure to α -lipoic acid among cats from collateral consumption of the proposed dog food would not be expected to exceed 3 mg/kg bw/day, which is 10 to 15 times lower than the reported maximum tolerable dose and 4 to 6 times lower than the no-effect level in cats.

Figure 10-1 Safety endpoints and estimated exposures to α -lipoic acid among various animal species

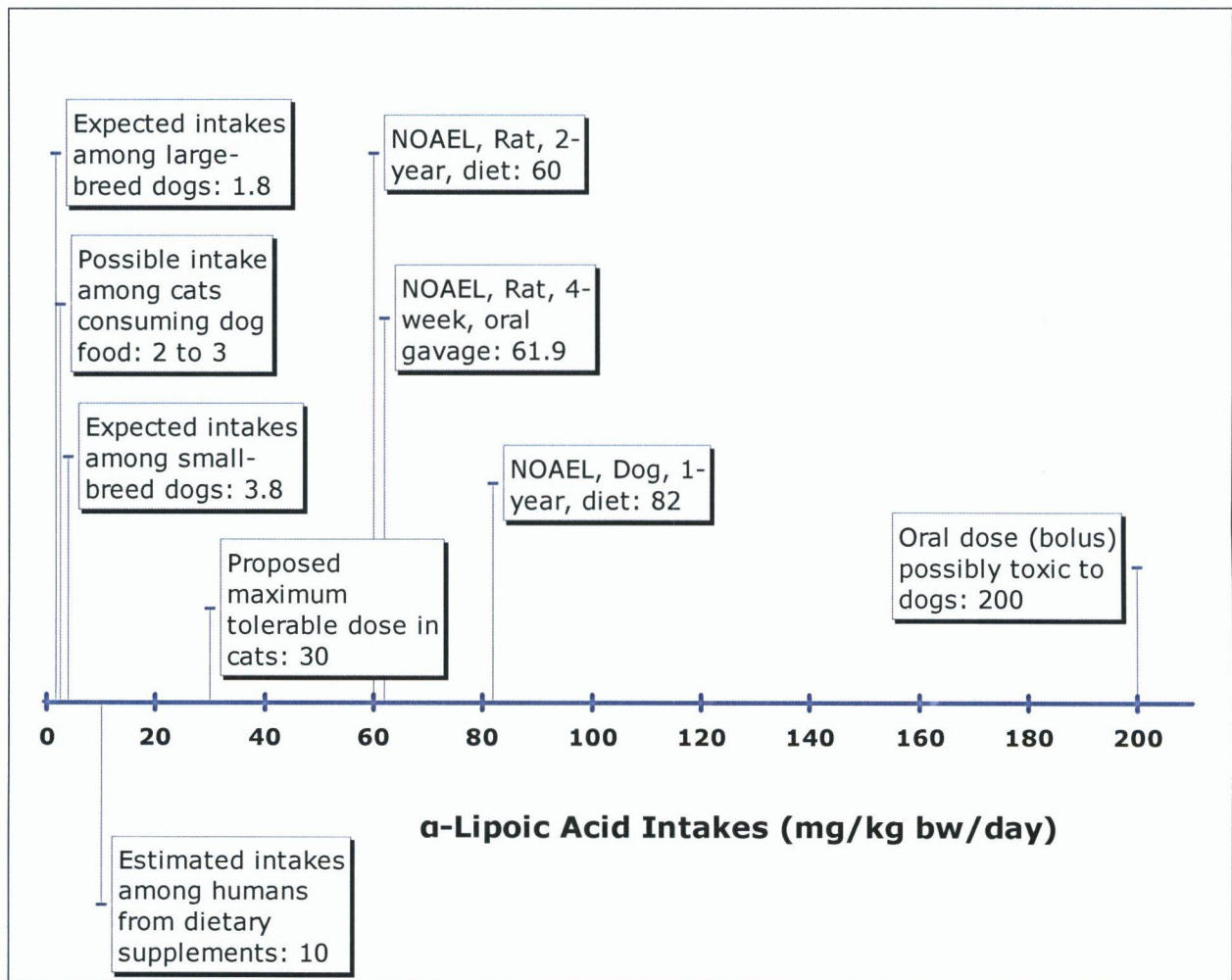

Expected intakes are based on an inclusion rate of 150 ppm α -lipoic acid (42 μ g/kcal) for adult dog dry foods.

⁸ Exposure across breed sizes did not vary greatly when considered on the basis of 100 kcal consumed.

The available safety data might support higher α -lipoic acid intakes (e.g., 26 mg/kg bw/day based on the lack of adverse effects in adult dogs (1 to 3 years old) receiving 1500 ppm in the diet, 420 μ g/kcal, for 1 year). However, 150 ppm α -lipoic acid (42 μ g/kcal) was selected as an inclusion rate for adult dog dry foods that would provide reasonable certainty that no harm will result and would be expected to provide some health benefits.

Having considered the information in the present GRAS dossier and the opinion an Expert Panel, Hill's Pet Nutrition, Inc. has determined that α -lipoic acid is exempt from the definition of "food additive" and thus from the premarket approval requirements outlined in section 201(s) of the Federal Food, Drug, and Cosmetic Act, because there is a consensus among qualified experts that the use of α -lipoic acid as described entails a reasonable certainty of no harm and is generally recognized as safe, as shown through scientific procedures.

11.0 REFERENCES

- AAFCO. 2010. Official Publication. Association of American Feed Control Officials Incorporated, p. 319.
- Al Ghafli MH, Padmanabham R, Kataya HH, Berg B. 2004. Effects of alpha-lipoic acid supplementation on maternal diabetes-induced growth retardation and congenital anomalies in rat fetuses. *Mol Cell Biochem* 261(1-2):123-135.
- Alexander C, Votruba M, Pesch UE, Thiselton DL, Mayer S, Moore A, Rodriguez M, Kellner U, Leo-Kottler B, Auburger G, *et al.* 2000. OPA1, encoding a dynamin-related GTPase, is mutated in autosomal dominant optic atrophy linked to chromosome 3q28. *Nat Genet* 26:211-215.
- Ames B. 1998. Micronutrients prevent cancer and delay aging. *Tox Let* 102-103:5-18.
- Arivazhagan P, Ramanathan K, Panneerselvam C. 2001. Effect of DL- α -lipoic acid on mitochondrial enzymes in aged rats. *Chem Biol Interact* 138:189-198.
- Bailey J, Knight A, Balcombe J. 2005. The future of teratology research is in vitro. *Biogenic Amines* 19(2):97-145.
- Baranowska I, Jaderlund KH, Nennesmo I, Holmqvist E, Heidrich N, Larsson NG, Andersson G, Wagner EGH, Hedhammar A, Wibom R, Andersson L. 2009. Sensory ataxic neuropathy in golden retriever dogs is caused by a deletion in the mitochondrial *tRNA^{Tyr}* gene. *PLoS Genet* 5(5): e1000499. doi:10.13771/journal.pgen.1000499.
- Barker RA and Barasi S. 2003. *Neuroscience at a Glance*, 2nd ed. Blackwell Publishing, Maiden, MA, pp. 48-119.
- Breitschwerdt EB, Kornegay JN, Wheeler SJ, Stenens JB, Baty CJ. 1992. Episodic weakness associated with exertional lactic acidosis and myopathy in Old English sheepdog littermates. *J Am Vet Med Assoc* 201(5):731-736.
- Carreau JP. 1979. Biosynthesis of lipoic acid via unsaturated fatty acids. *Methods Enzymol* 62:152-158.
- Chance B, Sies H, Boveris A. 1979. Hydroperoxide metabolism in mammalian organs. *Physiol Rev* 59:527-605.
- Cheville NF. 1994. *Ultrastructural Pathology: An Introduction to Interpretation*. Iowa State University Press, Ames, IA, pp. 192-228.

Cremer DR, Rabeler R, Roberts A, Lynch B. 2006a. Safety evaluation of α -lipoic acid (ALA). *Reg Tox Pharm* 46:29-41.

Cremer DR, Rabeler R, Roberts A, Lynch B. 2006b. Long-term safety of α -lipoic acid (ALA) consumption: A 2-year study. *Reg Tox Pharm* 46:193-201.

De Vivo DC. 1993. The expanding clinical spectrum of mitochondrial disease. *Brain Dev* 15:1-22.

Delettre C, Lenaers G, Griffoin JM, Gigarel N, Lorenzo C, Belenguer P, Pelloquin L, Grosgeorge J, Turc-Carel C, Perret E. 2000. Nuclear gene OPA1, encoding a mitochondrial dynamin-related protein, is mutated in dominant optic atrophy. *Nat Genet* 26:207-210.

Dent MP. 2007. Strengths and limitations of using repeat-dose toxicity studies to predict effects on fertility. *Regul Toxicol Pharmacol* 48(3):241-258.

Diaz-Cruz A, Serret M, Ramirez G, Ávila E, Guinzberg R, Piña E. 2003. Prophylactic action of lipoic acid on oxidative stress and growth performance in broilers at risk of developing ascites syndrome. *Avian Pathology* 32(6):645-653.

Dodd CE, Zicker SC, Jewell DE, Fritsch DA, Lowry SR, Allen TA. 2003. Can a fortified food affect the behavioral manifestations of age-related cognitive in dogs? *Veterinary Medicine (May 2003)*:396-408.

Dorland's Illustrated Medical Dictionary. 2003. Elsevier, p. 1295.

Farr SA, Poon HF, Dogrukol-Ak D, Drake J, Banks WA, Eyerman E, Butterfield DA, Morley JE. 2003. The antioxidants alpha-lipoic acid and N-acetylcysteine reverse memory impairment and brain oxidative stress in aged SAMP8 mice. *J Neurochem* 84(5):1173-1183.

Fujiwara K, Okamura-Ikeda K, Motokawa Y. 1994. Purification and characterization of lipoyl-AMP: N^{ϵ} -lysine lipoyltransferase from bovine liver mitochondria. *J Biol Chem* 269(24):16605-16609.

Fuke H, Iwanami K, Watanabe N, Kumada S. 1972. Acute, subacute and chronic toxicity of thioctic acid in rats. *Nippon Yakurigaku Zasshi (Folia Pharmacologica Japan)* 68:265-275. Article in Japanese.

Ghadially NF (ed). 1997. *Ultrastructural Pathology of the Cell and Matrix*, 4th ed. Vol. 1. Butterworths-Heinemann, Boston, MA, pp. 195-327.

Golden TR, Morten K, Johnson F, Samper E, Melov S. 2006. Mitochondria: A Critical Role in Aging. *In*: E Masoro and SN Austad (eds). Handbook of the Biology of Aging, 6th ed. Elsevier Academic Press, Burlington, MA. pp. 124-148.

Gross KL, Yamka RM, Khoo C, Friesen KG, Jewell DE, Schoenherr WD, Debraekeleer J, Zicker SC. 2010. Macronutrients. *In*: MS Hand, CD Thatcher, RL Remillard, P Roudebush, BJ Novotny (eds). Small Animal Clinical Nutrition. 5th Edition, p 49.

Gruber AD, Wessmann A, Vandevelde M, Summers BA, Tipold A. 2002. Mitochondriopathy with regional encephalic mineralization in a Jack Russell Terrier. *Vet Pathol* 39:732-736.

Gutteridge JM. 1994. Biological origin of free radicals, and mechanisms of antioxidant protection. *Chemico-Biol Interact* 91:133-140.

Hagen TM, Ingersoll RT, Lykkesfeldt J, Liu J, Wehr CM, Vinarsky V, Bartholomew JC, Bruce BN. 1999. (R)- α -Lipoic acid-supplemented old rats have improved mitochondrial function, decreased oxidative damage, and increased metabolic rate. *FASEB J* 13:411-418.

Hagen TM, Liu J, Lykkesfeldt J, Wehr CM, Ingersoll RT, Vinarsky V, Bartholomew JC, Ames BC. 2002. Feeding acetyl-L-carnitine and lipoic acid to old rats significantly improves metabolic function while decreasing oxidative stress. *PNAS* 99(4):1870-1875.

Hager K, Marahrens A, Kenklies M, Riederer P, Munch G. 2001. Alpha-lipoic acid as a new treatment option for Alzheimer type dementia. *Arch Gerontol Geriatr* 32(3):275-282.

Halliwell B. 1993. The chemistry of free radicals. *Toxicol Indust Health* 9:1-21.

Harman D. 1972. The biologic clock: the mitochondria? *J Am Geriatr Soc* 20:145-147.

Hill AS, Werner JA, Rogers QR, O'Neill SL, Christopher MM. 2004. Lipoic acid is 10 times more toxic in cats than reported in humans, dogs or rats. *J Anim Physiol Anim Nutr (Berl)* 88(3-4):150-156.

Ibrahim SF, Osman K, Das S, Othman AM, Majid NA, Rahman MPA. 2008. A study of the antioxidant effect of alpha lipoic acids on sperm quality. *Clinics* 64:545-550.

Ikeda-Douglas CJ, Zicker SC, Estrada J, Jewell DE, Milgram NW. 2004. Prior experience, antioxidants, and mitochondrial cofactors improve cognitive function in aged beagles. *Vet Therap* 5(1):5-16.

IUPAC. 1993. International Union of Pure and Applied Chemistry. Glossary for Chemists of Terms used in Toxicology. Information accessed via <http://sis.nlm.nih.gov/enviro/glossarymain.html>.

Kijima K, Numakura C, Izumino H, Umetsu K, Nezu A, Shiiki T, Ogawa M, Ishizaki Y, Kitamura T, Shozawa Y, *et al.* 2005. Mitochondrial GTPase mitofusin 2 mutation in Charcot-Marie-Tooth neuropathy type 2A. *Hum Genet* 116:23-27.

Kwong LK, Sohal RS. 1998. Substrate and site specificity of hydrogen peroxide generation in mouse mitochondria. *Arch Biochem Biophys* 350:118-126.

Lehninger AL, Nelson DL, Cox MM (eds). 2005. *Lehninger Principles of Biochemistry*, 4th Edition. MacMillan, pp. 601-630.

Lin MT and Beal MF. 2006. Mitochondrial dysfunction and oxidative stress in neurodegenerative diseases. *Nature* 443:787-795.

Liu J, Head E, Gharib AM, Yuan W, Ingersoll RT, Hagen TM, Cotman CW, Ames BN. 2002. Memory loss in old rats is associated with brain mitochondrial decay and RNA/DNA oxidation: partial reversal by feeding acetyl-L-carnitine and/or R-alpha -lipoic acid. *Proc Natl Acad Sci USA* 99(4):2356-2361.

Liu J. 2008. The effects and mechanisms of mitochondrial nutrient alpha-lipoic acid on improving age-associated mitochondrial and cognitive dysfunction: an overview. *Neurochem Res* 33(1):194-203.

Lodge JK, Youn HD, Handelman GJ, Konishi T, Matsugo S, Mathur VV, Packer L. 1997. Natural sources of lipoic acid: determination of lipoyllysine released from protease-digested tissues by high performance liquid chromatography incorporating electrochemical detection. *J Appl Nutr* 49:3-11.

Loftin EG and Herold LV. 2009. Therapy and outcome of suspected alpha lipoic acid toxicity in two dogs. *J Vet Emergency Crit Care* 19(5):501-506.

Lopes R, Solter PF, Sisson DD, Oyama MA, Prosek R. 2006. Characterization of canine mitochondrial protein expression in natural and induced forms of idiopathic dilated cardiomyopathy. *Am J Vet Res* 67(6):963-970.

McBride HM, Neuspiel M, Wasiak S. 2006. Mitochondria: more than just a powerhouse. *Curr Bio* 16:R551-560.

McMurry J. 1984. *Organic Chemistry*. Brooks/Cole Publishing Company, Monterey, p. 248.

Milgram MW, Araujo JA, Hagen TM, Treadwell BV, Ames BN. 2007. Acetyl-L-carnitine and alpha-lipoic acid supplementation of aged beagle dogs improved learning in two landmark discrimination tests. *FASEB J* 21:3756-3762

Milgram NW, Head E, Zicker SC, Ikeda-Douglas C, Murphey H, Muggenburg BA, Siwak CT, Dwight Tapp P, Lowry SR, Cotman CW. 2004. Long-term treatment with antioxidants and a program of behavioral enrichment reduces age-dependent impairment in discrimination and reversal learning in beagle dogs. *Experimental Gerontology* 39:753-765.

Milgram NW, Head E, Zicker SC, Ikeda-Douglas CJ, Murphey H, Muggenburg B, Siwak C, Tapp D, Cotman CW. 2005. Learning ability in aged beagle dogs is preserved by behavioral enrichment and dietary fortification: a two-year longitudinal study. *Neurobiol Aging* 26(1):77-90.

Milgram NW, Zicker SC, Head E, Muggenburg BA, Murphey H, Ikeda-Douglas CJ, Cotman CW. 2002. Dietary enrichment counteracts age-associated cognitive dysfunction in canines. *Neurobiology of Aging* 23:737-745.

Miquel J. 1998. An update on the oxygen stress-mitochondrial mutation theory of aging: genetic and evolutionary implications. *Exp Gerontol* 33:113-126.

NTP. 2004. Acetyl-L-Carnitine/ α -Lipoic Acid Supplements. Material prepared for the National Cancer Institute (NCI) for consideration by the Chemical Selection Working Group (CSWG) by Technical Resources International, Inc. under contract no. N02-07007. Available online through <http://ntp.niehs.nih.gov>.

OECD Test Guideline 425 (2001). Acute Oral Toxicity – Up-and-Down Procedure (UDP). Organization for Economic Cooperation and Development Test Guidelines for Testing of Chemicals. Available on-line through <http://www.oecd.org>.

Olby NJ, Chan KK, Targett MP, Houlton JE. 1997. Suspected mitochondrial myopathy in a Jack Russell terrier. *J Small Anim Pract* 38(5):213-216.

Paciello O, Maiolino P, Fatone G, Papparella S. 2003. Mitochondrial myopathy in a German Shepherd dog. *Vet Pathol* 40:507-511.

Paetau-Robinson I, Yamka RM, Friesen KG. 2008. Foods with lipoic acid and elevated levels of vitamin E and vitamin C correlate with whole blood antioxidant concentrations and may protect geriatric dogs from oxidative stress. *Int J Appl Res Vet Med* 6(2):93-100.

Papa S, Skulachev VP. 1997. Reactive oxygen species, mitochondria, apoptosis and aging. *Mol Cell Biochem* 174:305-319.

PDR for Nutritional Supplements. 2001. Medical Economics Co., Inc. Montvale, NJ, pp. 17-21.

Perez-Campo R, Lopez-Torres M, Cadenas S, Rojas C, Barja G. 1998. The rate of free radical production as a determinant of the rate of aging: evidence from the comparative approach. *J Comp Physiol* 168:149-158.

- Reed LJ. 2001. A trail of research from lipoic acid to α -keto acid dehydrogenase complexes. *J Biol Chem* 276(42):38329-38336.
- Sastre J, Pallardo FV, Vina J. 2000. Mitochondrial oxidative stress plays a key role in aging and apoptosis. *IUBMB Life* 49(5):427-435.
- Scheffler IE. 2000. A century of mitochondrial research: achievements and perspectives. *Mitochondrion* 1:3-31.
- Schupke, H, Hempel R, Peter G, Hermann R, Wessel K, Engel J, and Kronbach T. 2001. New metabolic pathways of α -lipoic acid. *Drug Metab Dispos* 29(6):855-862.
- Selvakumar E, Prahalathan C, Mythili Y, Varalakshmi P. 2004. Protective effect of DL- α -lipoic acid in cyclophosphamide induced oxidative injury in rat testis. *Repr Toxicol* 19:163-167.
- Shimoda H, Tanaka J, Seki A, Honda H, Akaogi S, Komatsubara H, Suzuki N, Kameyama M, Tamura S, Murakami N. 2007. Safety and structural analysis of polymers produced in manufacturing process of α -lipoic acid. *Shokuhin eiseigaku zasshi (Journal of the Food Hygienic Society of Japan)* 48(5):125-131. (Article in Japanese with abstract in English)
- Singh U and Jialal I. 2008. Alpha-lipoic acid supplementation and diabetes. *Nutr Rev* 66(11): 646-657.
- Sohal R S and Sohal BH. 1991. Hydrogen peroxide release by mitochondria increases during aging. *Mech Ageing Dev* 57:187-202.
- Sohal R S, Sohal BH, Orr WC. 1995. Mitochondrial superoxide and hydrogen peroxide generation, protein oxidative damage, and longevity in different species of flies. *Free Radical Biol Med* 19:499-504.
- Sugimura Y, Murase T, Kobayashi K, Oyama K, Hayasaka S, Kanou Y, Oiso Y, Murata Y. 2009. Alpha-lipoic acid reduces congenital malformations in the offspring of diabetic mice. *Diabetes Metab Res Rev* 25(3):287-294.
- Tauro A, Talbot CE, Pratt JN, Boydell IP. 2008. Suspected mitochondrial myopathy in a springer spaniel. *Vet Rec* 163(13):396-397.
- U.S. EPA. 1988. Recommendations for and Documentation of Biological Values for Use in Risk Assessment. EPA/600/6-87/008. (Rat and mouse default values for body weight, food and water consumption) available from Toxicology Excellence for Risk Assessment (TERA) on-line through <http://www.tera.org>.

Vijayasarathy C, Giger U, Prociuk U, Patterson DF, Breitschwerdt EB, Avadhani NG. 1994. Canine mitochondrial myopathy associated with reduced mitochondrial mRNA and altered cytochrome c oxidase activities in fibroblasts and skeletal muscle. *Comp Biochem Physiol A Physiol* 106(4):887-894.

Witkowski A, Joshi AK, Smith S. 2007. Coupling of the de novo fatty acid biosynthesis and lipoylation pathways in mammalian mitochondria. *J Biol Chem* 282(19):14178-14185.

Witt W and Rustow B. 1998. Determination of lipoic acid by precolumn derivatization with monobromobimane and reversed-phase high-performance liquid chromatography. *J Chromatogr B Biomed Sci Appl* 705(1):127-131.

Wiznitzer A, Ayalon N, Hershkovitz R, Khamaisi M, Reece EA, Trischler H, Bashan N. 1999. Lipoic acid prevention of neural tube defects in offspring of rats with streptozocin-induced diabetes. *Am J Obstet Gynecol* 180(1):188-193.

Zhang L, Joshi AK, Smith S. 2003. Cloning, expression, characterization, and interaction of two components of a human mitochondrial fatty acid synthase. *J Biol Chem* 278(41):40067-40074.

Zicker S, Hagen TM, Joisher N, Golder C, Joshi D, Phillip Miller E. 2002. Safety of long-term feeding of dl- α -lipoic acid and its effect on reduced glutathione:oxidized glutathione ratios in beagles. *Vet Ther* 3(2):167-176.

Zicker SC, Avila A, Joshi DK, Gross KL. 2010. Pharmacokinetics of orally administered DL- α -lipoic acid in dogs. *Am J Vet Res* 71(11):1377-1383.

Hill's Internal Reports

Study/Document Number: 100219 FY2000-010R

Product: Science Diet® Canine Senior® NM Prototype dry Formula

Objective: Evaluate the nutritional adequacy of the test food for the maintenance of adult dogs

Protocol: 2000 AAFCO Canine Adult Maintenance Protocol

Formula: 16668

Test Dates: 1/27/00-9/6/00

Study Number: 100300 CMDO12374

Document Number: 100300 CMDO12374R

Product: Project Mikey Prototype (22204) dry canine formula

Objective: Evaluate the nutritional adequacy of the test food for the maintenance of adult dogs

Protocol: 2001 AAFCO Canine Adult Maintenance Protocol

Formula: 22204-1

Test Dates: 2/14/01-8/15/01

Study Number: 100300 CMDO12375

Document Number: 100300 CMDO12375R

Product: Project Mikey Prototype (22205) dry canine formula

Objective: Evaluate the nutritional adequacy of the test food for the maintenance of adult dogs

Protocol: 2001 AAFCO Canine Adult Maintenance Protocol

Formula: 22205-1

Test Dates: 2/14/01-9/12/01

Title: The safety of Supplemental Dietary α -Lipoic Acid in the Target Species, Dogs

Study Number: 11635 (Hills); 449-00-69 (CAVL)

Document Number: 100293-CLIPD-11635R.2

Chemical name: α -Lipoic Acid

Proposed Usage: Antioxidant for dog foods

Amended Final Study Report (signed 02/2005)

Databases

The GeneCards Human Gene Database: Orthologs for pyruvate dehydrogenase complex component E2 (dihydrolipoamide S-acetyltransferase or DLAT) gene obtained through, accessed online through <http://www.genecards.org> in September, 2010.

Kyoto Encyclopedia of Genes and Genomes (KEGG) PATHWAY Database: Pathway for *Canis familiaris* (dog) obtained in September-October, 2010 through (<http://www.genome.jp/kegg>).



Final



APPENDIX 1: Specifications for *dl*- α -lipoic acid established by Hill's Pet Nutrition



Ingredient Specification

Alpha-Lipoic Acid

M2560

Issued: 8 June 2009

Replaces: 18 Dec 2008

Page: 1

DEFINITION: Alpha-Lipoic Acid, $C_8H_{14}O_2S_2$, is a yellow crystalline powder. Alpha-Lipoic Acid has an International non-proprietary name (INN) of Thiocctic Acid and a chemical name of 1,2-Dithiolane-3-pentanoic acid (dl-form). CAS no. 1077-28-7.

AAFCO REFERENCE: n/a

COUNTRY OF ORIGIN: Hill's approved source locations

CERTIFICATE OF ANALYSIS REQUIRED:

Parameter	Min	Target	Max	European Reference Method	US Reference Method
Loss on drying, %	-	-	≤0.2	Ph. Eur. 6.0 2.2.32	USP Monograph, Alpha Lipoic Acid
Residual Solvent, Cyclohexane, ppm	-	-	≤1000	Ph. Eur. 6.0 2.2.28	USP General Chapter, Residual Solvents <467>
Residual Solvent, Ethylacetate, ppm	-	-	≤1000	Ph. Eur. 6.0 2.2.28	USP General Chapter, Residual Solvents <467>
Residual Solvent, Toluol, ppm	-	-	≤50	Ph. Eur. 6.0 2.2.28	USP General Chapter, Residual Solvents <467>
HPLC – α-Lipoic Acid Assay, %	97.0	-	102.0	Ph. Eur. 6.0 2.2.29	USP Monograph, Alpha Lipoic Acid

Must be included in Certificate of Analysis. Sampling for this C of A must be according to GIPSA methods, USDA methods, AOAC 965.16, 950.02, or a method approved by Hill's Corporate Quality Assurance.

Hill's Pet Nutrition must receive adequate prior notice and give documented approval for changes to manufacturing procedures, sources or sourcing location of ingredients which are significant to the quality of the product.



Ingredient Specification

Alpha-Lipoic Acid

M2560

Issued: 8 June 2009

Replaces: 18 Dec 2008

Page: 2

CHARACTERISTICS: TARGET AND RANGE

Parameter	Min	Target	Max	European Reference Method	US Reference Method
Melting Point Range, °C	60.0	61.0	62.0	Ph. Eur. 6.0 2.2.14 or Ph. Eur. 6.0 2.2.15	USP Monograph, Alpha Lipoic Acid
Heavy Metals, ppm	-	-	≤10	Ph. Eur. 2.4.8, Method C	USP Monograph, Alpha Lipoic Acid
β-lipoic acid, %	-	-	≤0.10	Ph. Eur. 6.0 2.2.29	-
6,8-Epitrihiooctanoic acid, %	-	-	≤0.1	Ph. Eur. 6.0 2.2.29	USP Monograph, Alpha Lipoic Acid
Single Unknown Purities, %	-	-	≤0.10 each	Ph.Eur. 6.0 2.2.29	-
Sum of all Impurities, %	-	-	≤0.3	Ph.Eur. 6.0 2.2.29	-
Polymers, %	-	-	≤2	Ph.Eur. 6.0 2.2.2.7	USP Monograph, Alpha Lipoic Acid

PHYSICAL CHARACTERISTICS:

<u>Grade:</u>	n/a
<u>Odor:</u>	chemical, slightly sulfur
<u>Particle Size:</u>	Particle size and particle size distribution measurements are made by using either the Ro-Tap method (ASAE S319.4) or laser diffraction method. Ro-Tap Method: 90% through U.S. #20 sieve. Laser diffraction method: 50% <350 μm, 98% <950 μm.
<u>Color:</u>	Yellow, crystalline powder
<u>Uniformity:</u>	Uniform. Fresh material is devoid of clumps, however, material is susceptible to clumping during transportation.

PACKAGING: 50 kg drum**SHELF LIFE:** 1 year if stored in a tightly closed container in a dry, cool, and well ventilated area, protected from light. Desired storage temperature ≤25°C.



Ingredient Specification

Alpha-Lipoic Acid

M2560

Issued: 8 June 2009

Replaces: 18 Dec 2008

Page: 3

GENERAL AND REGULATORY REQUIREMENTS:

This ingredient will be used for the manufacturing of pet food. All deliveries of this ingredient shall at least comply with all relevant legislation applicable to these ingredients and to products produced from them.

This ingredient shall not be adulterated as defined in the *Federal Food, Drug, and Cosmetic Act*.

- It is considered adulterated if it bears or contains an added poisonous or deleterious (harmful) substance which may render it injurious to health (Sec. 402(a)(1)).
- It is considered adulterated if it bears or contains a naturally occurring poisonous or deleterious substance which ordinarily renders it injurious to health (Sec. 402(a)(1)).
- Food additives (Sec. 201(s)) must be determined to be safe by FDA before they may be used in a food, or become a part of a food as a result of processing, packaging, transporting, or holding the food (Sec. 409). Hill's Pet Nutrition must receive prior notice and give approval for the addition of any additives.
- Raw agricultural products are adulterated if they contain residues of pesticides not authorized by, or in excess of, tolerances established by regulations of the Environmental Protection Agency (Sec. 402(a)(2)(b) and Sec. 408)).
- It is considered adulterated if it has been prepared, packed, or held under unsanitary conditions whereby it may have been rendered injurious to health (Sec. 402(a)(4)).
- Food containers must be free from any poisonous or deleterious substance which may cause the contents to be injurious to health (Sec. 402(a)(6)). Some packaging materials, for example plastic or vinyl containers, may be "food additives" subject to regulations (Sec. 409).
- Only those colors found safe by the Food and Drug Administration may be added to food (Sec. 721) and Hill's Pet Nutrition must receive prior notice and give approval for the addition of any colors. It is considered adulterated if it bears or contains an unsafe color(s) (Sec. 402(c)). Unless exempt by regulation, colors for use in food must be from batches tested and certified by the Food and Drug Administration (Sec. 721(c)).
- It is considered adulterated if any part of it is filthy, putrid, decomposed, or otherwise "unfit" (Sec. 402(a)(3)).

This **feed material / additive** shall not be adulterated as defined by *EU and National legislation*.

- It should be safe for animal consumption in accordance with Regulation EC N° 178/2002 of 28 January 2002.
- It is considered adulterated if it bears or contains any poisonous or harmful substance, whether added or naturally present, which may render it injurious to animal or human health.
- Feed materials or premixes should not consist or contain any material listed in Commission Decision 2004/217 of 1 March 2004, establishing a list of materials whose use is prohibited in compound feeding stuffs, such as feces, urine, hide treated with tanning substances, any urban waste, etc.
- Feed materials or premixes are adulterated if they contain residues of pesticides not authorized by, or in excess of the Maximum Residue Level (MRL) established by Regulation EC N° 396/2005 of 23 February 2005 as amended.



Ingredient Specification

Alpha-Lipoic Acid

M2560

Issued: 8 June 2009

Replaces: 18 Dec 2008

Page: 4

- Feed materials or premixes are adulterated if they contain undesirable substances in excess of the maximum permitted levels laid down in the Annex of Directive 2002/32 of 7 May 2002.
- Feed materials or premixes are adulterated if they contain dioxins, furans, PCBs and dioxin-like PCBs in excess of the TEQs laid down in Commission Directive 2006/13/EC of 3 February 2006 amending the Annexes of Directive 2002/32 of 7 May 2002.
- Feed materials or premixes are adulterated if they contain mycotoxins in excess of the levels published in Commission Regulation (EC) N°1126/2007, Commission Recommendation 2006/576/EC of 17 August 2000.
- Feed materials, additives and premixes have to be manufactured, packed, stored and transported in accordance with Regulation EC N° 183/2005 of 12 January 2005 laying down requirements for feed hygiene.
- Feed materials of animal origin should meet the requirements laid down in Regulation EC N° 1774/2002 of 3 October 2002 as amended.
- Feed materials of animal origin should be free of any specified risk material (SRM) listed in ANNEX V of Regulation (EC) N° 999/2001 of 22 May 2001 as amended by Commission Regulation (EC) N° 722/2007 of June 2007.

Note:

Feed material: official legal name for raw material; Additives are defined differently in Europe than in the US, they include preservatives, antioxidants, colorants, trace elements, vitamins, gelling agents etc.

FOREIGN MATERIAL:

The equipment, facilities, and transportation container shall be maintained in a sanitary manner to minimize rodent, bird, microbiological and other contamination. It shall not be infested with live or dead insects. It shall not contain any level of contaminant that may be harmful or poisonous. Ingredient shall be free of stones, wood, plastic, metal or glass, rodent hair and excreta. Fumigated grain shall be devoid of pesticide odor and properly aired.

MATERIAL TRANSPORT:**Bulk transport**

- The bulk truck, railcar, ship, or barge shall be suitable for pet food ingredient use. The bulk truck, railcar, ship, or barge shall be free of evidence of past or current insect, bird, or rodent activity. Presence of water or any unusual odor, which might have contaminated the product, shall result in rejection. Trucks, railcars, ships, and barges are to be cleaned appropriately prior to loading to prevent cross contamination. Any container not passing inspection shall not be used. All transport containers shall protect the product against deterioration.
- Prior to unloading, Hill's Pet Nutrition personnel shall carefully inspect each container for contamination, foreign material, and infestation.



Ingredient Specification

Alpha-Lipoic Acid

M2560

Issued: 8 June 2009

Replaces: 18 Dec 2008

Page: 5

Bags and palletized product

- Transportation truck shall be suitable for pet food ingredient use. Inspection of the truck: the truck shall be free of evidence of past or current insect, bird or rodent activity or any other contamination. Ingredients shall not be transported together with toxic or otherwise harmful substances. Any container not passing inspection shall not be used. All transport containers shall protect the product against deterioration.
- The bags (incl. super sacks) and the pallets on which they are stacked shall be free of evidence of insect, bird, or rodent activity. Presence of water, damaged, torn, and leaking bags will result in rejection of individual pallet loads or the entire shipment. Top surface of the wooden pallet will be covered to prevent damage to bags. Pallets with broken boards or protruding nails, which may damage bags, shall not be used.
- Each bag or each pallet of bags must be labeled.
- Prior to unloading, Hill's Pet Nutrition personnel shall carefully inspect each container for contamination, foreign material, and infestation.

Documents / Labeling

- Supplier must include Purchase Order number on Invoice and Bill of Lading.
- Supplier must include Certificate of Analysis with each lot.
- Labeling / Lot Control:
 - Bulk- manufacture lot number or batch code must be on Bill of Lading
 - Drums labeled with:
 - supplier name
 - ingredient name
 - manufacture lot number or batch code
 - weight/unit
 - manufacturing date (open code date)
 - Pallets labeled with:
 - Hill's ingredient number
 - #units/pallet



Ingredient Specification

Alpha-Lipoic Acid

M2560

Issued: 8 June 2009

Replaces: 18 Dec 2008

Page: 6

MISCELLANEOUS

Hill's Pet Nutrition retains the right to inspect the facility at which the ingredient is produced, stored, and/or shipped in order to determine the supplier's ability to conform to Hill's Pet Nutrition requirements, and their ability to provide ingredients that consistently meet the specification requirements.

REJECTION

- Failure to meet any of the above mentioned criteria may result in rejection of the shipment.
- Samples will be analyzed for the criteria stated in the individual ingredient specification.
- In case of rejection, Hill's will contact the supplier to discuss measures to be taken.

Supplier acknowledges and agrees that ingredients received by or for Hill's Pet Nutrition shall be in conformance with the above specification requirements.

Company Name:

Source Location(s):

Authorized Vendor Agent Approval Signature:

Date:

Printed Signature and Title:



Ingredient Specification

Alpha-Lipoic Acid

M2560

Issued: 8 June 2009

Replaces: 18 Dec 2008

Page: 7

FOR HILL'S PET NUTRITION USE ONLY

PLANT INSTRUCTIONS: refer to Hill's Pet Nutrition Laboratory Methods and Quality Manual for method details.

TRACKING CHARACTERISTICS TARGET AND RANGE FOR EACH LOT:

Parameter	Minimum	Target	Maximum	Hill's Analysis Method
Moisture, %	-	-	≤0.2	USP Monograph, Alpha Lipoic Acid
Melting Point Range, °C	60.0	61.0	62.0	USP Monograph, Alpha Lipoic Acid
HPLC – α-Lipoic Acid Assay, %	97.0	-	102.0	USP Monograph, Alpha Lipoic Acid

INGREDIENT LISTING:

US: alpha-lipoic acid

Europe: alpha-lipoic acid

Japan: alpha-lipoic acid



Ingredient Specification

Alpha-Lipoic Acid

M2560

Issued: 8 June 2009

Replaces: 18 Dec 2008

Page: 8

FOR HILL'S PET NUTRITION USE ONLY

Mandatory Reject Criteria and Levels: per Corporate Quality Manual section QS-22-101

1. It is not from an **Approved Supplier** or **Approved Supplier Location**.
2. If the **Documents** are not correct the load shall not be accepted until corrected.
3. If the **Transport Container** is not clean or it has loose panels, dangerous protrusions, or leaks that have caused damage to the load.
4. If the **load** has been contaminated by moisture or any other harmful contaminants, the damaged portion or entire load shall be rejected, based on the severity.
5. If the **load** is contaminated by rodents, animal excreta, insects, or foreign materials.
6. If the **Analytical Data** is out of Specification and it is:
 - A Critical attribute to specification, the load shall automatically be rejected. All Critical attributes must be on Certificate of Analysis.
 - A Key attribute to specification, the material may be accepted or rejected based on the distance from specification range, need for material, and vendor history, etc. Plant Quality Manger to make decision and document.

Notification Requirements: see Corporate Quality Manual section QS-20-211

Handling: see Corporate Quality Manual section QS-20-202

Storage: see Corporate Quality Manual section QS-19-103

Safety: Refer to MSDS for special safety instructions.

Sampling: Each load received is to be sampled according to Corporate Quality Manual section QS-20-203.



Ingredient Specification

Alpha-Lipoic Acid

M2560

Issued: 8 June 2009

Replaces: 18 Dec 2008

Page: 9

FOR HILL'S PET NUTRITION USE ONLY

APPROVED SUPPLIER LIST:

Vendor	(b) (4)
Vendor SAP code	
Manufacturer	
Manufacturer code number	
Manufacturer location	
Hill's Location serviced	

Revision History:

12/10/08 – updated into new format, changed COA requirements, changed characteristic targets and ranges, changed tracking characteristics and ranges, and changed supplier information. Change form document 2560001. (SW)

• 6/08/09 :

- Moved melting point range testing from “Certificate of Analysis” section to “Characteristics: Target and Range” section
- Added “which are significant to the quality of the product” after “Hill’s Pet Nutrition must receive adequate prior notice and give documented approval for changes to manufacturing procedures, sources or sourcing locations of ingredients”
- Updated Ro-Tap method to ASAE S319.4
- Deleted the phrase “100% through US #10 sieve” from particle size section
- Included laser diffraction method in particle size section
- Modified uniformity section to include that material is susceptible to clumping during transportation
- Added desired storage temperature to shelf life section
- Deleted “material should pass through a functioning metal detection system prior to loading” in foreign material section
- Deleted “Additive added to a feed material must be authorized according to Regulation (EC) 1831/2003 of 22 September 2003 and listed in the Community Register of Feed Additives”
- Replaced “bags, supersacks” with “drums” in documents/labeling section
- Deleted “Hill’s ingredient number and #units/pallet” from “drums labeled with” and inserted them under “pallets labeled with” in labeling/Lot Control section
- Changed moisture method to USP Monograph, Alpha Lipoic Acid in “Tracking Characteristics” section.

**APPENDIX 2: Specifications for *dl*- α -lipoic acid established by
(b) (4) the intended supplier of material to be used by Hill's**

	Parameter	Specification	Analytical method
1.	Appearance	Yellow, crystalline powder	143-250/1
2.	Identification		
2.1	HPLC	The retention time of the main peak of the reference solution and the test solution must be identical	Ph. Eur. 2.2.29 and 143-193/1
2.2	IR spectroscopy	IR spectrum complies to reference spectrum	Ph. Eur. 2.2.24 and 143-193/1
3.	Characteristics		
	Solubility in 1M NaOH		
3.1	Clarity	≤ 3.0 FNU	Ph. Eur. 2.2.1 and 143-007/4
	Coloration	Slightly yellowish	
3.2	Loss on drying	≤ 0.2 %	Ph. Eur. 2.2.23 and 143-002/2
3.3	Heavy metals	≤ 10 ppm	Ph. Eur. 2.4.8, method C and 143-022/2/6
3.4	Sulphated ash	≤ 0.1 %	Ph. Eur. 2.4.14 and 143-005/3
	Residual solvents (GC)		
3.5	Cyclohexane	≤ 1000 ppm	143-042/3
	Ethyl acetate	≤ 1000 ppm	
4.	Purity		
	Related substances (HPLC)		
4.1	6,8-Epitrithiooctanoic acid	≤ 0.10 %	Ph. Eur. 2.2.29 and 143-193/1
	Unknown single impurities	each ≤ 0.10 %	
	Sum of all impurities	≤ 0.3 %	
4.2	Polymers (TLC) ¹	≤ 1.0 %	Ph. Eur. 2.2.27 and 143-212/2
5.	Assay (HPLC)	97.0-102.0 %	Ph. Eur. 2.2.29 and 143-193/1
6.	Microbiological tests²		
6.A1	Aerobic bacteria	≤ 10 ³ CFU/g	Ph. Eur. 2.6.12 and 143-045/2
	Yeast/Molds	≤ 10 ² CFU/g	Ph. Eur. 2.6.12 and 143-045/1
6.A2	<i>Escherichia coli</i>	absence in 1 g	Ph. Eur. 2.6.13 and 143-045/3
7.	Other		
7.A1	Particle size (laser diffraction)	50 % ≤ 350 μm 90 % ≤ 750 μm 98 % ≤ 950 μm	143-017/1
7.A2	Bulk volume	1.7-2.7 mL/g	
7.A3	Tapped volume	1.3-1.8 mL/g	

¹ Analytical method used by (b) (4) for polymer determination changed from gel permeation chromatography (GPC) to thin-layer chromatography (TLC) in December, 2007.

² Every tenth batch or at least once per year.

APPENDIX 3: Analytical method developed by Hill's for determination of α -lipoic acid in dry pet food



Hill's Pet Nutrition, Inc. Pet Nutrition Center

Title: Determination of Lipoic Acid in Extruded Foods Via HPLC Analysis

SOP Number.Version: LAB-RES-026.1

Total Pages: 6

Replaces: LAB-26.0

Revision:

Reason: Annual Review. Format change. No technical changes.

Author: Joe Greitl

Date: 11/29/2008

Reviewer: Stephen J. Davidson

Date: 03/26/2009

Reviewer: Chris Golder

Date: 03/26/2009

Reviewer: Al Avila

Date: 02/09/2009

Reviewer: Dinesh Joshi

Date: 04/24/2009

OBJECTIVE: This method has been designed and validated for the analysis of lipoic acid in extruded foods.

SCOPE: Lipoic acid is reduced to dihydrolipoic acid and labeled with monobromobimane which is separated and detected using HPLC with a fluorescence detector.

APPLICABLE TO:

RELATED PROCEDURES & REFERENCES:

1. Lipoic Acid Daily Recording Sheet (F-101-LAB-RES-026.1)
2. Standardized Naming Conventions, Data Processing and Data Storage in the Analytical Research Laboratory (LAB-RES-036);
3. Calibration and Accuracy in Routine Analytical Methods (LAB-RES-046).

Based on :

1. Witt, Rüstow " Determination of lipoic acid by precolumn derivatization of monobromobimane and reversed- phase high-performance liquid chromatography", Journal of Chromatography B, 705 (1998) pp127-131.
2. Zicker S et al "Safety of Long Term Feeding of dl-alpha-lipoic acid Its Effect on Reduced Gluthatione:Oxidized Glutathione Ratios in Beagles", Veterinary Therapeutics Vol 3 No 2 Summer 2002 pp 167-176.

DEFINITIONS:

SAFETY REQUIREMENTS: General laboratory safety practices should be followed at all times while performing this method. Safety assessment of all chemicals used and review of proper chemical storage requirements should be completed prior to implementing this procedure.

Materials:

Acetonitrile (MeCN): Mallinckrodt, HPLC Grade



Hill's Pet Nutrition, Inc. Pet Nutrition Center

Acetic Acid (HOAc): Fisher, Glacial ACS Grade
 Hydrochloric Acid (HCl): Fisher, ACS Grade
 Ethyl Ether: EM Science, Anhydrous ACS Grade
 Dichloromethane (CH₂Cl₂): Sigma, HPLC Grade
 Sodium Borohydride (NaBH₄): Sigma, >98%
 α-Lipoic Acid (ALA, (±)-1,2-Dithiolane-3-pentanoic Acid, CAS# 1077-28-7) : Sigma, >99%
 Monobromobimane (mBBR): Fluka, >95%.
 Phosphoric Acid (H₃PO₄): Aldrich, 99.99%+
 Dithioerythritol (DTE): Sigma, 99%+
 Sodium Phosphate (Na₂HPO₄): Fisher, Anhydrous Enzyme Grade
 EDTA (Dihydrate Sodium Salt): Sigma, ACS Grade
 Sodium Chloride (NaCl): Sigma, 99.5%+
 Sodium Hydroxide (NaOH): Fisherbrand, Certified 50% w/w
 Sodium Dodecyl Sulphate (SDS): Fisher, Certified
 Ammonium Bicarbonate (NH₄HCO₃): Sigma, 99%+
 Ammonium Hydroxide (NH₄OH): Sigma, ACS Grade
 Deionized Water (DI H₂O): In house, _ 18.2 MΩ
 Equivalent reagents may be used.

Equipment:

Grinder or Food Processor
 Analytical Balance: Mettler-Toledo, precise to 0.0001g
 Vortexer: Glass Col - Multi-Pulse Vortexer
 15mL polypropylene centrifuge tubes (CT) VWR # 20171-036
 1000mL, 500mL, 50mL, 25mL, 10ml glass Class A volumetric flasks
 10mL glass pipette
 50mL Centrifuge Tubes VWR# 21008-480
 5mL Disposable Glass Centrifuge tubes: Kimble, 73785-5
 Screw caps Teflon lined Corning #409330
 Centrifuge: Beckman model GS-6R
 N-Evap: Organomation Associates, Inc., Model 112
 Rainin Automatic Pipette: 2500 μL
 Rainin edp 3 Automatic Pipette: 10-100μL
 Rainin edp 3 Automatic Pipette: 100-1000μL
 Rainin edp 3 Automatic Pipette: 20-200μL
 Rainin edp 3 Automatic Pipette: 500-5000μL
 Autosampler Vials, National Scientific cat # C4011-11c Amber
 Caps for Autosampler vials, National Scientific cat # C4011-1A
 Disposable glass Pasteur Pipettes, 5 1/4", VWR Scientific Cat No. 53283-911
 pH Meter
 Component List: Agilent 1100 Series HPLC System with Chemstation instrument control
 On-line Mobile Phase Degasser G1322A
 Quaternary Gradient Pump G1311A
 Autosampler G1313A
 Thermostatted Column Compartment G1316A
 Fluorescence Detector G1321A
 Analytical Column: Alltech Hypersil MOS(C8) 100mm x 4.6mm x 3μm PN 9883
 Guard Column: Alltech Hypersil MOS-1 PN 96122
 Equivalent equipment may be used.

Preparation of Solutions

1. All materials should be measured to within 0.0005g of the weights listed.
2. Mobile Phase must be prepared the day the samples are started on the HPLC.



Hill's Pet Nutrition, Inc. Pet Nutrition Center

- 2.1. Using a 10mL disposable pipette, add 10mL HOAc to a 1000mL volumetric flask containing about 300mL of DI H₂O.
- 2.2. Add 300mL MeCN to the same flask using a 500mL-graduated cylinder.
- 2.3. Fill the flask to volume with DI H₂O, invert 10 times and transfer to a 1000mL HPLC reservoir.
- 2.4. Use 4.5M NH₃OH to get the pH of the solution to 3.950 ± 0.005. If the pH goes above 3.956, the mobile phase must be remade.
3. Phosphate Buffer
 - 3.1. Add the following to a 1000mL volumetric flask:
 - 3.1.1. 1.4200g Na₂HPO₄
 - 3.1.2. 0.7444g EDTA
 - 3.1.3. 8.7660g NaCl
 - 3.2. Fill the flask to volume with DI H₂O, cap, invert 10 times and transfer to a 1L Nalgene bottle.
 - 3.3. Adjust the pH of the solution to 7.4 with 3M H₃PO₄ or 6M NaOH, if necessary.
4. 100mM EDTA
 - 4.1. Add 1.861g of EDTA to a 50mL volumetric flask and fill to volume with DI H₂O.
 - 4.2. Transfer the solution to a 65mL Nalgene bottle and adjust to pH 7.8 with 6M NaOH.
5. SDS/EDTA
 - 5.1. Add the following to a 500mL volumetric flask:
 - 5.1.1. 4.383g NaCl
 - 5.1.2. 2.7915g EDTA
 - 5.1.3. 0.5500g SDS
 - 5.2. Fill the flask to volume with DI H₂O, cap, invert 10 times and transfer to a 500mL Nalgene bottle.
6. 2M HCl
 - 6.1. Use a 100mL graduated cylinder to add 82.6mL HCl to a 500mL volumetric flask already containing about 250mL DI H₂O.
 - 6.2. Fill the flask to volume with DI H₂O, cap, invert 10 times and transfer to a 1L Nalgene bottle.
7. 100mM NH₄HCO₃
 - 7.1. Add 3.9530g NH₄HCO₃ to a 500mL volumetric flask; fill to volume with DI H₂O.
8. 1M H₃PO₄
 - 8.1. Use a 5mL disposable pipette to add 2.91mL of H₃PO₄ to a 50mL volumetric flask already containing about 30mL of DI H₂O.
 - 8.2. Fill to volume with DI H₂O, cap, invert 10 times.
9. 5mM DTE
 - 9.1. This solution should be prepared within 1hr of use.
 - 9.2. Weigh 0.0386g DTE into a 50mL flask.
 - 9.3. Fill to volume with DI H₂O, cap and invert 10 times.
10. 1mM DTE
 - 10.1. This solution should be prepared within 30min of use.
 - 10.2. Weigh 0.0077g DTE into a 50mL flask.
 - 10.3. Fill to volume with DI H₂O, cap and invert 10 times.
11. 1M NaBH₄
 - 11.1. This solution should be prepared within 30min of use.
 - 11.2. Weigh 0.4161g NaBH₄ into a 10mL flask.
 - 11.3. Fill to volume with DI H₂O, cap and invert 10 times.
12. 100mM mBBr
 - 12.1. This solution should be prepared within 30min of use.
 - 12.2. Weigh 0.0068g mBBr into an amber autosampler vial.
 - 12.3. Add 250μL MeCN, cap and briefly vortex mix to dissolve.

Preparation of Standard Stock and Working Solutions

1. A Stock solution of 10,000μg/g ALA is made by weighing 0.1000g ALA into a 10mL volumetric flask and filling to volume with MeCN.



Hill's Pet Nutrition, Inc. Pet Nutrition Center

2. The 10000 μ g/g solution is added to separate 10mL volumetric flasks according to the table below to make a series of solutions as defined. Phosphate buffer is used to bring each to volume.

Concentration of ALA (μ g/g)	Amount of Stock Solution added to 10ml flask (μ L)
20	20 μ L
35	35 μ L
70	70 μ L
140	140 μ L
280	280 μ L
500	500 μ L
650	650 μ L

PROCEDURE

Sample Preparation

- All samples are ground in a food processor and approximately 0.1 \pm 0.0005g are weighed into labeled 15mL CTs.
 - Standards are prepared in duplicate.
 - Unknown Samples are weighed out in duplicate.
 - Control Samples are weighed out providing double bracketing around the unknowns.
 - Spike Recovery experiments use a single additional portion of an unknown sample.

Preparation of Standards, Controls, Samples and Spikes for Analysis

- Extraction of Standards, Samples, Controls, and Spikes
Solutions are added to the CTs as indicated in the following table.

	Amount of Standard Added, μ L	Amount of Sample Added, mg	Amount of Phosphate Buffer Added, mL		
Standards ^a	100	0	10.10		
Blanks ^b	0	0	10.20		
Samples	0	100	2.6 ^c	2.5 ^d	5.0 ^e
Controls	0	100	2.6	2.5	5.0
Spikes	100	100	2.5	2.5	5.0

^a See instructions beginning at step 2.1

^b Blanks are prepared by adding 100 μ L Phosphate Buffer to a 15mL CT and diluting with an additional 10.10mL Phosphate Buffer for a total volume of 10.20mL.

^c See instructions starting at step 2.2

^d See instructions starting at step 2.4

^e See instructions starting at step 2.8

- Calibration Standards
 - 100 μ L of each standard solution is added to a 15mL CT along with 10.10mL phosphate buffer.
 - Vortex mix each CT for 10sec.
- A total of 2.6mL of phosphate buffer is added to the 15mL CTs containing ~0.1g of sample.
 - Spiked samples use 100 μ L of a specified standard solution and 2.5mL phosphate buffer added to the 15mL CTs containing ~0.1g of a specified sample.
- All tubes are shaken to mix and then allowed to stand for 5 minutes.
- Another 2.5mL phosphate buffer is added to samples, controls and spikes. They are then inverted 5 times for mixing.
- Vortex mix all tubes for 10 min at 100% speed.



Hill's Pet Nutrition, Inc. Pet Nutrition Center

- 2.5.1. Column Temperature: 40°C
- 2.5.2. Lipoic acid Retention time 6.0 - 9 minutes.
- 2.5.3. Example Chromatogram : Typical Sample

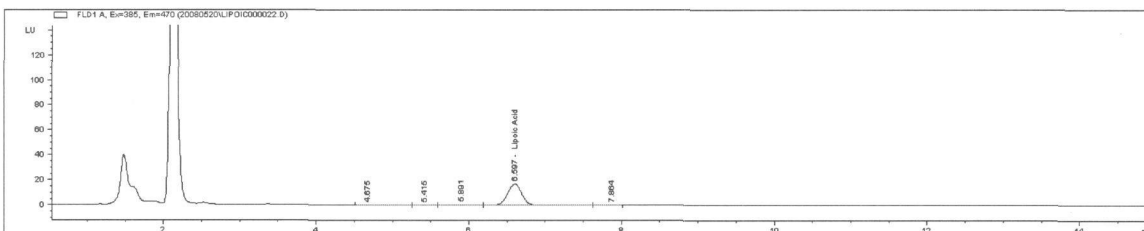

3. Calculations

- 3.1. The quality of the automated integration is checked. This includes review of :
 - 3.1.1. Correct peak identification including adjustment of the retention time in the method if necessary. Check of baseline for correct integration.
- 3.2. The calibration of the method is done using the Chemstation software.
 - 3.2.1. ALA uses an externally standardized linear response curve. The correlation coefficient should not be less than 0.98.
 - 3.2.2. Each standard is equally weighted and the origin is included in the calculation.
 - 3.2.3. Any prior calibration results are replaced with the average result of both sets of calibration solutions.
- 3.3. Chemstation is used to quantitate the results for each sample.
- 3.4. The summary report from Chemstation is imported into an Excel sheet. The equations needed to calculate the results on a weight basis are built into the sheet.
 - 3.4.1. The weights of the samples, spiked samples, and control samples are keyed into the template.
 - 3.4.2. The following equation is used to calculate the results.

$$\mu\text{g/g ALA in sample} = (\text{Chemstation result} \times 0.1) / \text{Sample Weight}$$
 - 3.4.3. The Spiked Sample results are calculated using the following equation:

$$\text{Recovery of Lipoic Acid} = [(A - B) / C] \times 100$$

Where "A" is the level of the analyte analytically determined in the spiked sample, "B" is the "background" level, and "C" is the amount of analyte added to the spiked sample. These should be 85-115% of the expected amount.
 - 3.4.4. The Control Sample results are calculated using the following equation:

$$\text{Recovery of Lipoic Acid} = \text{Control Sample Result} / \text{Expected Control Result} \times 100$$

These should be 85-115% of the expected amount
 - 3.4.5. The Check Standard results are calculated using the following equation:

$$\text{Recovery of Check Standards} = \text{End Standard Result} / \text{Beginning Standard Result} \times 100$$

These should be 85-115% of the calibration result.
 - 3.4.6. The Sample Result and Spike Result values used in the Recovery calculations are the weight corrected results from equation 5.4.2.
- 3.5. After the data is reviewed according to the above criteria the data is reported according to LAB-RES-036 (see Related Procedures and References above).

APPENDIX 4: Data validating the analytical method developed by Hill's for determination of α -lipoic acid in dry pet food

Summary of parameters evaluated in the validation Hill's analytical method for measuring α -lipoic acid in dry canine food

Parameter and Validation Procedure	Outcome
Linearity and Range: Analysis of 7 different calibration standards containing 10-2500 $\mu\text{g/g}$ lipoic acid	Correlation Coefficient ≥ 0.99
Accuracy: Recovery from food samples spiked with lipoic acid (low, medium, high levels) measured	80-120 % Recovery
Repeatability/Reproducibility: Calculate average of the percent coefficients of variance (% CV) <u>Average intraday method precision</u> Analysis in duplicate of 5 extruded pet food samples containing ALA <u>Average interday method precision</u> Analysis of same extruded pet food samples containing ALA, in duplicate on 3 different days	CV < 20 %
Specificity: Compare retention time of derivatized lipoic acid in standards and in samples on each day	Note: In the absence of a reference material to use for Quality Control purposes, Hill's uses a food sample that is measured routinely as in-house control. Validation of the benchmark for future analysis is based on the average of 12 control samples analyzed over 3 days.

The assay for routine analysis requires: (1) that results expressed in $\mu\text{g/g}$; (2) use of 7-point calibration daily; (3) a correlation coefficient of 0.98 or better; (4) analysis in duplicate, with a difference of 20 % or less between results; (5) analysis of at least 1 spiked sample to demonstrate accuracy, recovery of 80-120 %; (6) analysis of at least 2 in-house control samples with results within 20 % of the value observed during validation.

Formula for calculating spike recovery:

$$\text{Spike Recovery} = \frac{\text{Spike Result}}{(\text{Spike Amount} + \text{Sample Result})} \times 100$$

Results of linear regression analysis of data validating Hill's analytical method for measuring α -lipoic acid in dry canine food

Concentration			
$\mu\text{g/g}$	Day 1	Day 2	Day 3
0	0.00	5.81	0.00
10.00	0.00	16.68	0.00
50.00	45.78	55.46	30.33
100.00	93.56	109.41	100.87
500.00	506.72	480.45	514.97
1000.00	1004.62	988.30	1069.13
2000.00	2066.79	2008.13	1923.36
2500.00	2443.76	2501.57	2531.11
Slope	0.4569	0.4848	0.4402
Intercept	6.183	-1.329	10.608
R²	0.99935	0.99994	0.99897

Results of accuracy testing of Hill's analytical method based on recovery of α -lipoic acid from spiked samples of dry canine food

Spike Amount $\mu\text{g/g}$	Day 1	Day 2	Day 3
	Average Recovery	Average Recovery	Average Recovery
50.00	92.2%	102.3%	88.5%
100.00	99.5%	102.6%	98.8%
500.00	90.6%	102.5%	98.0%
Overall Average Recovery	94.1%	102.5%	95.1%

Results of inter- and intra-day precision testing of Hill's analytical method for measuring α -lipoic acid in dry canine food

Inter-Day Precision (over three days)

	Concentration $\mu\text{g/g}$	CV
Sample 1	2066.60	1.4%
Sample 2	173.60	7.9%
Sample 3	1214.70	2.1%
Sample 4	3.20	173.2%
Sample 5	1660.10	6.8%

Intra-Day Precision (duplicate analysis per sample)

Sample Prep Precision

	Day 1 CV	Day 2 CV	Day 3 CV
Sample 1	9.22%	6.75%	7.50%
Sample 2	0.88%	4.29%	0.61%
Sample 3	1.62%	9.74%	5.30%
Sample 4	0.00%	2.79%	0.00%
Sample 5	5.62%	6.44%	6.62%
Average CV	4.34%	6.80%	5.01%

Injection Precision

	CV	CV	CV
Sample 1	0.01%	0.07%	0.02%
Sample 2	0.03%	0.03%	0.01%
Sample 3	0.00%	0.21%	0.07%
Sample 4	0.00%	0.06%	0.00%
Sample 5	0.09%	0.09%	0.05%
Average CV	0.04%	0.09%	0.04%

APPENDIX 5: Results of HPLC analysis of canine foods containing *dl*- α -lipoic acid at various levels

Formula #	Target <i>dl</i> - α -lipoic acid concentration ppm	Date diet was prepared	Days since preparation	HPLC Analysis	
				Date analyzed	Results μ g/g
20409	0	10/09/2000	2	10/11/2000	27.52
			60	12/08/2000	0.00
			72	12/20/2000	10.00
			112	01/29/2001	21.47
		12/21/2000	18	01/08/2001	48.05
			46	02/05/2001	37.78
			92	03/23/2001	37.52
			116	04/16/2001	33.90
			168	06/07/2001	48.11
		05/02/2001	3	05/05/2001	0.00
			42	06/13/2001	10.33
			72	07/13/2001	13.20
			104	08/14/2001	0.00
			188	11/06/2001	0.00
			226	12/14/2001	0.42
20410	150	10/09/2000	2	10/11/2000	144.41
			60	12/08/2000	128.10
			72	12/20/2000	157.79
			112	01/29/2001	149.32
		12/21/2000	18	01/08/2001	147.76
			39	01/29/2001	149.00
			92	03/23/2001	165.09
			116	04/16/2001	145.42
			168	06/07/2001	172.88
		05/02/2001	3	05/05/2001	134.15
			36	06/07/2001	146.38
			72	07/13/2001	145.03
			117	08/27/2001	125.56
			188	11/06/2001	130.27
			226	12/14/2001	135.53
20411	1500	10/10/2000	1	10/11/2000	1360.29
			59	12/08/2000	1590.89
			71	12/20/2000	1652.78
			118	02/05/2001	1286.49
		12/21/2000	18	01/08/2001	1375.97
			39	01/29/2001	1414.00
			92	03/23/2001	1482.33
			116	04/16/2001	1430.74
			168	06/07/2001	1531.31
		05/02/2001	3	05/05/2001	1335.14
			36	06/07/2001	1307.77
			72	07/13/2001	1332.91
			104	08/14/2001	1474.30
			188	11/06/2001	1403.78
			226	12/14/2001	1339.17

Values expressed as mean values.

Results of HPLC analysis of canine foods containing α -lipoic acid at various levels (Cont'd)

Formula #	Target <i>d,l</i> - α -lipoic acid concentration ppm	Date diet was prepared	HPLC Analysis		
			Days since preparation	Date analyzed	Results μ g/g
20412	3000	10/10/2000	1	10/11/2000	2424.61
			59	12/08/2000	3212.78
			84	01/02/2001	2903.33
			111	01/29/2001	3029.90
		12/21/2000	18	01/08/2001	2679.52
			39	01/29/2001	2692.51
			92	03/23/2001	2848.29
			116	04/16/2001	2685.61
			168	06/07/2001	2848.53
		05/02/2001	3	05/05/2001	2938.37
			36	06/07/2001	2685.57
			72	07/13/2001	2721.25
			104	08/14/2001	2539.73
			188	11/06/2001	2747.30
			226	12/14/2001	2708.61
20413	4500	10/10/2000	1	10/11/2000	3837.69
			59	12/08/2000	5083.97
			71	12/20/2000	4753.39
			111	01/29/2001	3297.20
		12/21/2000	18	01/08/2001	4304.83
			39	01/29/2001	3164.74
			109	04/09/2001	4278.08
			116	04/16/2001	4351.84
			174	06/13/2001	4606.79
		05/02/2001	3	05/05/2001	4257.72
			36	06/07/2001	4023.29
			72	07/13/2001	3911.73
			104	08/14/2001	4428.21
			188	11/06/2001	3810.09
			226	12/14/2001	3883.56

Values expressed as mean values.

APPENDIX 6: Mean estimated food and α -lipoic acid intakes among dogs during a 1-year safety study based on: mean food consumption values and measured levels of α -lipoic acid in the study diets

Overall mean dietary α -lipoic acid intakes among dogs in a 1-year study

Group	Animal #	Mean Body Weight (kg)	Mean Daily Intake (gm)	Actual α -Lipoic Acid Content (PPM)	Total Daily α -Lipoic Acid Intake (mg)	α -Lipoic Acid Intake (mg/kg/day)
1	24637	12.5	211	18	3.8	0.3
	25028	17.8	248	18	4.5	0.3
	25898	18.3	306	18	5.5	0.3
	30329	19.8	259	18	4.7	0.2
	31927	16.6	289	18	5.2	0.3
	31977	11.4	210	18	3.8	0.3
Average						0.3
2	18661	17.0	239	145	34.7	2.0
	26051	15.0	241	145	34.9	2.3
	31258	14.9	301	145	43.6	2.9
	31662	20.9	291	145	42.2	2.0
	31921	17.9	377	145	54.7	3.1
	32011	13.7	266	145	38.6	2.8
Average						2.5
3	17087	17.0	344	1426	490.5	28.9
	17092	16.1	276	1426	393.6	24.4
	17266	17.9	324	1426	462.0	25.8
	25321	12.8	230	1426	328.0	25.6
	29674	20.4	333	1426	474.9	23.3
	31720	15.2	322	1426	459.2	30.2
Average						26.4
4	17422	15.5	258	2803	723.2	46.7
	29680	16.9	249	2803	697.9	41.3
	29687	19.1	337	2803	944.6	49.5
	30899	13.1	252	2803	706.4	53.9
	31976	12.3	317	2803	888.6	72.2
Average						52.7
5	18563	15.1	212	4138	877.3	58.1
	18789	16.2	286	4138	1183.5	73.1
	29692	16.3	341	4138	1411.1	86.6
	30901	12.6	351	4138	1452.4	115.3
	31669	13.7	256	4138	1059.3	77.3
Average						82.1

Group 1 (n=6): Control
 Group 2 (n=6): 150 ppm
 Group 3 (n=6): 1500 ppm
 Group 4 (n=5): 3000 ppm
 Group 5 (n=5): 4500 ppm

Mean daily food consumption (g) values

Group	Animal #	Week 2 Mean	Week 4 Mean p ¹	Week 8 Mean p ¹	Week 12 Mean p ¹	Week 16 Mean p ¹	Week 20 Mean p ¹	Week 24 Mean p ¹	Week 28 Mean p ¹	Week 32 Mean p ¹	Week 36 Mean p ¹	Week 40 Mean p ¹	Week 44 Mean p ¹	Week 48 Mean p ¹	Week 52 Mean p ¹
1	24637	234	234	228	211	209	209	215	209	209	209	209	209	203	184
	25028	274	349	349	324	324	324	293	237	187	155	149	155	187	224
	25896	289	364	364	339	339	339	327	314	302	277	264	264	264	264
	30329	302	327	327	302	302	296	283	268	255	215	202	202	202	202
	31927	271	346	334	321	321	321	321	302	284	259	246	246	246	246
	31977	196	196	196	196	196	196	196	196	150	176	200	226	271	254
2	18661	241	305	242	200	213	251	296	263	246	209	241	249	198	222
	26051	251	326	264	245	289	307	295	239	201	201	201	201	201	201
	31258	251	326	326	326 *	351 *	370 *	364 *	339 *	295	245	251	251	251	251
	31662	273	248	286	317	323	323	311	298	298	273	273	273	273	273
	31921	282	357	420 *	430 *	432 *	426 *	432 *	420 *	363 *	332	332	332	332	332
	32011	238	313	301	288	288	294	301 *	269	257	238	238	238	238	238
3	17087	277	352	340	346 *	377 *	390 *	377 *	365 *	327	327	327	327	327	327
	17092	262	337	337	337 *	337 *	337 *	306	275	225	212	212	212	237	262
	17266	287	362	362	362 *	362 *	368 *	375 *	331	287	279	262	275	312	312
	25321	200	251	289	276	276	276	257	226	189	176	176	182	220	226
	29574	312	387	387	362	375	387 *	375 *	331	267	287	287	293	312	312
	31720	253	328	384 *	378 *	378 *	384 *	372 *	341 *	303	278	278	278	272	253
4	17422	241	241	247	266	266	266	266	266	266	254	241	247	266	266
	29680	258	265	265	258	254	233	243	236	265	240	240	246	265	227
	29687	276	326	326	326	351	376 *	332	303	333	345	341	351	348	349
	30899	225	275	275	275	275	263	250	275	269	238	225	225	256	200
	31976	216	300	319 *	324 *	300 *	310 *	320 *	317 *	333 *	322 *	331 *	335 *	322 *	325 *
	31997	223	223	260	292	336	348	359	326	340	269	254			
5	18563	215	146 *	149	194	222	229	244	241	192	190	220	244	218	232
	18789	253	213	242	293	297	249	325	272	302	294	281	326	330	269
	29692	279	354	387 *	341	354 *	304	332	355 *	329	314	346	342	394 *	314
	30901	184	130	179	338 *	337 *	380 *	347 *	385 *	379 *	403 *	418 *	408 *	416 *	416 *
	31669	209	256	252	279	291	300	271	265	259	246	236	197	257	244

Group 1 (n=6): Control
 Group 2 (n=6): 150 ppm
 Group 3 (n=6): 1500 ppm
 Group 4 (n=5): 3000 ppm
 Group 5 (n=5): 4500 ppm

p¹: P-value associated with a comparison to negative control
 * Indicates P-value < 0.05

Actual α -lipoic acid levels (ppm) in diets administered to dogs for 1 year

Date of Manufact.	Date Analysed	Group 1 (Control)			Group 2 (150ppm)			Group 3 (1500ppm)			Group 4 (3000ppm)			Group 5 (4500ppm)		
		As Is	% Moist.	DM*	As Is	% Moist.	DM*	As Is	% Moist.	DM*	As Is	% Moist.	DM*	As Is	% Moist.	DM*
10/9/2000	10/11/2000	28	6.58	29	144	6.76	155	1360	7.51	1470	2425	8.60	2653	3838	8.27	4183
10/9/2000	12/8/2000	0	6.58	0	128	6.76	137	1591	7.51	1720	3213	8.60	3315	5084	8.27	5542
10/10/2000	12/20/2000	10	6.58	11	158	6.76	169	1653	7.51	1787	2903	8.60	3176	4753	8.27	5181
10/10/2000	1/29/2001	21	6.58	23	149	6.76	160	1286	7.51	1391	3030	8.60	3315	3297	8.27	3594
12/21/2000	1/8/2001	48	8.01	52	148	7.74	160	1376	7.62	1489	2680	7.71	2905	4305	7.65	4662
12/21/2000	1/29/2002	38	8.01	41	149	7.74	162	1414	7.62	1530	2693	7.71	2919	3165	7.65	3427
12/21/2000	2/26/2001	0	8.01	0	147	7.74	159	1491	7.62	1614	3174	7.71	3441	4209	7.65	4558
12/21/2000	3/23/2001	38	8.01	41	165	7.74	179	1482	7.62	1604	2848	7.71	3088	4278	7.65	4633
12/21/2000	4/16/2001	34	8.01	37	145	7.74	158	1431	7.62	1548	2686	7.71	2911	4352	7.65	4713
12/21/2000	6/7/2001	48	8.01	52	173	7.74	187	1531	7.62	1657	2849	7.71	3088	4607	7.65	4989
5/2/2001	5/5/2001	0	7.89	0	134	8.29	146	1335	8.63	1461	2938	8.65	3218	4258	8.60	4658
5/2/2001	6/7/2001	10	7.89	11	146	8.29	160	1308	8.63	1431	2686	8.65	2941	4023	8.60	4401
5/2/2001	7/13/2001	13	7.89	14	145	8.29	158	1333	8.63	1458	2721	8.65	2980	3912	8.60	4279
5/2/2001	8/14/2001	0	7.89	0	126	8.29	137	1474	8.63	1613	2540	8.65	2781	4428	8.60	4845
5/2/2001	11/6/2001	0	7.89	0	130	8.29	142	1404	8.63	1536	2747	8.65	3008	3810	8.60	4168
5/2/2001	12/14/2001	0	7.89	0	136	8.29	148	1339	8.63	1465	2709	8.65	2966	3884	8.60	4249
Group Average		18		19	145		157	1426		1548	2803		3044	4138		4505

DM*: Dry Matter

APPENDIX 7: Tabulated data from 1-year dietary safety study of *dl*- α -lipoic acid in the target species (dog)

Serum biochemistry values among dogs receiving dl- α -lipoic acid in the diet for 1 year (Week 0 to 24)

	Group	Initial				Week 2				Week 4				Week 8				Week 12				Week 16				Week 20				Week 24			
		Mean	SE	p ¹		Mean	SE	p ¹	p ²	Mean	SE	p ¹	p ²	Mean	SE	p ¹	p ²	Mean	SE	p ¹	p ²	Mean	SE	p ¹	p ²	Mean	SE	p ¹	p ²	Mean	SE	p ¹	p ²
Glucose (53.1-106.9 mg/dl)	1	93.4	4.10			92.0	2.85			87.7	3.75			75.5	4.00	*		88.2	3.67			74.3	3.38	*		73.7	2.83	*		65.8	3.39	*	*
	2	91.7	4.10			89.7	2.85			89.5	3.75			84.3	4.00	*		81.7	3.67	*		75.3	3.38	*		73.2	2.83	*		77.3	3.39	*	*
	3	85.8	4.10			96.8	2.85	*		95.2	3.75	*		90.7	4.00	*		83.5	3.67	*		83.5	3.38	*		81.8	2.83	*		79.8	3.39	*	*
	4	88.6	4.49			88.6	3.13			85.6	4.11			79.0	4.38	*		81.8	4.03			74.2	3.70	*		65.6	3.10	*		62.4	3.71	*	*
	5	88.2	4.49			98.0	3.13			93.4	4.11			82.8	4.38	*		83.4	4.03			84.4	3.70	*		75.2	3.10	*		78.0	3.71	*	*
SUN (8.7-30.5 mg/dl)	1	11.9	1.02			10.4	1.06			9.2	2.02	*		10.9	2.16			11.4	3.06			11.4	2.01			8.1	1.58	*		10.7	1.46		
	2	10.8	1.02			11.8	1.06			14.0	2.02			13.8	2.16			15.5	3.06			15.7	2.01			12.4	1.58	*		14.2	1.46		
	3	12.1	1.02			9.2	1.06	*		9.4	2.02	*		10.1	2.16			11.3	3.06			11.6	2.01			8.3	1.58	*		10.6	1.46		
	4	12.7	1.12			6.4	1.16	*		10.4	2.21	*		11.5	2.37			12.0	3.35			13.4	2.20			11.4	1.73	*		12.2	1.60		
	5	12.2	1.12			7.4	1.16	*		9.0	2.21	*		11.9	2.37			12.2	3.35			14.0	2.20			10.1	1.73	*		14.0	1.60		
Creatinine (0.68-1.45 mg/dl)	1	0.7	0.06			0.7	0.07			0.6	0.14			0.6	0.11			0.6	0.09			0.7	0.10			0.7	0.09			0.7	0.10		
	2	0.7	0.06			0.8	0.07			0.9	0.14			0.8	0.11			0.8	0.09			0.9	0.10			0.9	0.09			0.9	0.10		
	3	0.7	0.06			0.7	0.07			0.6	0.14			0.6	0.11			0.7	0.09			0.7	0.10			0.7	0.09			0.7	0.10		
	4	0.9	0.06	*		0.8	0.08			0.8	0.15			0.8	0.12			0.8	0.10			0.9	0.11			0.9	0.10			0.9	0.11		
	5	0.9	0.06	*		0.8	0.08			0.7	0.15			0.8	0.12			0.8	0.10			0.9	0.11			0.9	0.10			0.9	0.11		
Sodium (143-168 mmol/L)	1	151.5	0.59			152.8	1.05			145.7	0.54	*		148.8	1.34	*		150.2	0.85			149.3	0.80	*		152.0	0.62	*		150.8	0.68		
	2	150.3	0.59			151.5	1.05			144.7	0.54	*		147.8	1.34	*		150.3	0.85			149.0	0.80	*		152.3	0.62	*		150.8	0.68		
	3	150.0	0.59			153.5	1.05	*		145.5	0.54	*		149.5	1.34	*		151.2	0.85			149.0	0.80	*		152.5	0.62	*		151.2	0.68		
	4	151.2	0.65			154.6	1.15	*		147.2	0.59	*		152.0	1.47	*		152.0	0.93			151.4	0.87	*		153.6	0.68	*		151.2	0.75		
	5	151.4	0.65			154.0	1.15	*		147.2	0.59	*		150.8	1.47	*		152.6	0.93			149.6	0.87	*		153.8	0.68	*		150.2	0.75		
Chloride (108-131 mmol/L)	1	117.3	1.07			117.2	0.89			111.3	1.03	*		111.8	1.09	*		112.2	0.68	*		109.8	0.96	*		113.3	0.95	*		114.7	0.72	*	
	2	114.8	1.07			115.3	0.89			110.0	1.03	*		109.8	1.09	*		108.2	0.68	*		109.8	0.96	*		112.0	0.95	*		113.2	0.72	*	
	3	117.4	1.07			119.2	0.89			112.2	1.03	*		113.5	1.09	*		112.5	0.68	*		111.0	0.96	*		114.0	0.95	*		114.3	0.72	*	
	4	118.8	1.17			116.2	0.98			112.2	1.13	*		112.6	1.20	*		110.4	0.75	*		110.8	1.05	*		115.0	1.04	*		113.2	0.79	*	
	5	118.5	1.17			119.0	0.98			114.2	1.13	*		112.2	1.20	*		113.0	0.75	*		111.0	1.05	*		114.6	1.04	*		113.6	0.79	*	
Calcium (9.42-11.74 mg/dl)	1	10.1	0.17			10.6	0.18	*		10.5	0.16			13.7	0.24	*		10.2	0.18			11.0	0.18	*		11.1	0.19	*		10.5	0.16		
	2	10.1	0.17			10.4	0.18			10.5	0.16			14.0	0.24	*		10.5	0.18			11.2	0.18	*		11.3	0.19	*		10.7	0.16	*	
	3	10.0	0.17			10.4	0.18			10.2	0.16			13.9	0.24	*		10.2	0.18			10.8	0.18	*		11.1	0.19	*		10.7	0.16	*	
	4	10.3	0.19			10.9	0.20	*		10.9	0.18	*		14.7	0.26	*		10.9	0.19	*		11.5	0.20	*		11.5	0.21	*		11.0	0.18	*	
	5	10.2	0.19			10.6	0.20			10.5	0.18			14.2	0.26	*		10.4	0.19	*		11.0	0.20	*		11.3	0.21	*		10.6	0.18	*	
Phosphorus (2.8-6.2 mg/dl)	1	3.6	0.23			4.0	0.35			3.6	0.27			3.6	0.26			3.4	0.20			3.9	0.23			3.8	0.23			4.2	0.22	*	
	2	4.3	0.23	*		4.6	0.35			4.1	0.27			4.3	0.26			3.5	0.20	*		4.1	0.23			3.9	0.23			3.9	0.22		
	3	4.2	0.23			4.0	0.35			3.7	0.27			4.3	0.26			3.5	0.20	*		4.1	0.23			4.1	0.23			4.1	0.22		
	4	3.8	0.25			4.0	0.39			3.2	0.30			3.7	0.29			3.1	0.22			3.9	0.25			3.5	0.26			4.0	0.24		
	5	4.2	0.25			4.0	0.39			3.9	0.30			4.1	0.29			3.1	0.22	*		4.0	0.25			3.9	0.26			4.2	0.24		
Magnesium (1.3-2.0 mEq/L)	1	1.7	0.04			1.7	0.05			1.6	0.05	*		1.6	0.06			1.6	0.05	*		1.7	0.05			1.6	0.07	*		1.6	0.05		
	2	1.8	0.04			1.7	0.05			1.5	0.05	*		1.6	0.06	*		1.8	0.05	*		1.7	0.05			1.7	0.07	*		1.6	0.05	*	
	3	1.8	0.04			1.6	0.05	*		1.5	0.05	*		1.6	0.06	*		1.7	0.05	*		1.6	0.05	*		1.6	0.07	*		1.6	0.05	*	
	4	1.7	0.05			1.7	0.05			1.6	0.05			1.7	0.06			1.7	0.05			1.8	0.05			1.8	0.08			1.7	0.06		
	5	1.7	0.05			1.7	0.05			1.6	0.05			1.7	0.06			1.7	0.05			1.7	0.05			1.7	0.08			1.6	0.06		
Potassium (4.1-5.4 mmol/L)	1	4.6	0.09			4.6	0.11			4.6	0.10			4.6	0.09			4.7	0.11			4.6	0.09			5.3	0.11	*		4.9	0.10	*	
	2	4.6	0.09			4.5	0.11			4.4	0.10			4.7	0.09			4.9	0.11	*		4.7	0.09			5.1	0.11	*		4.8	0.10	*	
	3	4.6	0.09			4.5	0.11			4.2	0.10	*	*	4.6	0.09			4.7	0.11	*		4.5	0.09			4.7	0.11	*		4.7	0.10	*	
	4	4.4	0.10			4.4	0.12			4.3	0.10			4.6	0.10			4.6	0.12			4.4	0.10			5.1	0.12	*		4.6	0.11	*	
	5	4.6	0.10			4.4	0.12			4.3	0.10	*	*	4.6	0.10			4.5	0.12			4.4	0.10	*		4.7	0.12	*		4.6	0.11	*	

Group 1 (n=6): Control
 Group 2 (n=6): 150 ppm
 Group 3 (n=6): 1500 ppm
 Group 4 (n=5): 3000 ppm
 Group 5 (n=5): 4500 ppm

Serum biochemistry values among dogs receiving dl- α -lipoic acid in the diet for 1 year (Weeks 28 to 52)

	Group	Initial				Week 28				Week 32				Week 36				Week 40				Week 44				Week 48				Week 52			
		Mean	SE	p ¹	p ²	Mean	SE	p ¹	p ²	Mean	SE	p ¹	p ²	Mean	SE	p ¹	p ²	Mean	SE	p ¹	p ²	Mean	SE	p ¹	p ²	Mean	SE	p ¹	p ²	Mean	SE	p ¹	p ²
Glucose (63.1-109.9 mg/dl)	1	93.4	4.10			78.5	3.72	*		67.3	3.06	*		65.8	3.43	*		72.8	3.62	*		76.3	3.19	*		81.8	4.42	*		80.8	4.01	*	
	2	91.7	4.10			76.0	3.72	*		72.3	3.06	*		73.0	3.43	*		80.7	3.62	*		81.2	3.19	*		77.7	4.42	*		86.2	4.01	*	
	3	85.8	4.10			85.3	3.72			81.0	3.06	*		74.2	3.43	*		84.0	3.62	*		84.7	3.19	*		82.7	4.42	*		87.7	4.01	*	
	4	88.6	4.49			71.2	4.07	*		60.6	3.36	*		56.2	3.75	*		73.6	3.96	*		81.6	3.49	*		70.8	4.84	*		85.8	4.39	*	
	5	88.2	4.49			81.2	4.07			73.2	3.36	*		65.4	3.75	*		80.6	3.96	*		82.8	3.49	*		74.8	4.84	*		87.2	4.39	*	
SUN (8.7-30.5 mg/dl)	1	11.9	1.02			10.2	1.41			10.0	1.22			10.1	1.76			7.8	1.21	*		7.2	1.25	*		9.2	1.16	*		9.4	1.60	*	
	2	10.8	1.02			14.2	1.41			10.1	1.22			14.1	1.76			11.0	1.21	*		10.1	1.25	*		11.8	1.16	*		10.7	1.60	*	
	3	12.1	1.02			11.2	1.41			9.9	1.22			11.8	1.76			8.0	1.21	*		8.1	1.25	*		11.6	1.16	*		10.4	1.60	*	
	4	12.7	1.12			14.6	1.54			12.5	1.34			14.1	1.92			11.0	1.32	*		10.1	1.37	*		12.0	1.27	*		12.9	1.75	*	
	5	12.2	1.12			12.7	1.54			10.9	1.34			15.9	1.92	*		11.1	1.32	*		10.1	1.37	*		11.9	1.27	*		11.0	1.75	*	
Creatinine (0.68-1.45 mg/dl)	1	0.7	0.06			0.8	0.11			0.7	0.10			0.7	0.09			0.7	0.10			0.7	0.10			0.7	0.09			0.7	0.09		
	2	0.7	0.06			1.0	0.11			0.9	0.10			0.9	0.09			0.9	0.10	*		0.9	0.10	*		1.0	0.09	*		0.9	0.09		
	3	0.7	0.06			0.8	0.11			0.8	0.10			0.8	0.09			0.7	0.10			0.8	0.10			0.7	0.09			0.7	0.09		
	4	0.9	0.06	*		1.0	0.12			0.9	0.11			0.9	0.10			0.9	0.11			0.9	0.11			0.9	0.09			0.9	0.10		
	5	0.9	0.06	*		1.0	0.12			1.0	0.11			1.0	0.10	*		1.0	0.11	*		0.9	0.11	*		0.9	0.09	*		0.9	0.10		
Sodium (143-168 mmol/L)	1	151.5	0.59			152.3	0.84			149.0	0.71	*		149.2	1.11	*		150.5	0.58			148.0	0.70	*		151.5	0.79	*		147.7	0.74	*	
	2	150.3	0.59			152.5	0.84	*		149.8	0.71	*		153.0	1.11	*	*	150.5	0.58			148.0	0.70	*		152.7	0.79	*		147.8	0.74	*	
	3	150.0	0.59			153.2	0.84	*		148.3	0.71	*		151.5	1.11			149.7	0.58			149.8	0.70	*		153.7	0.79	*		149.0	0.74	*	
	4	151.2	0.65			153.4	0.92			150.0	0.78			151.6	1.21			150.0	0.64			150.0	0.77	*		153.8	0.86	*		148.6	0.81	*	
	5	151.4	0.65			154.6	0.92	*		150.4	0.78			152.0	1.21			150.8	0.64			149.4	0.77	*		154.8	0.86	*		149.4	0.81	*	
Chloride (108-131 mmol/L)	1	117.3	1.07			116.2	0.82			113.8	0.60	*		115.0	0.87			112.2	0.70	*		112.5	0.86	*		118.7	1.00	*		110.3	0.87	*	
	2	114.8	1.07			113.8	0.82			111.5	0.60	*	*	116.5	0.87			112.0	0.70	*		110.8	0.86	*		116.8	1.00	*		110.8	0.87	*	*
	3	117.4	1.07			117.3	0.82			114.2	0.60	*		118.5	0.87	*		113.3	0.70	*		113.7	0.86	*		119.8	1.00	*		113.3	0.87	*	*
	4	118.8	1.17			115.4	0.90	*		113.6	0.66	*		115.2	0.95	*		112.0	0.76	*		112.8	0.94	*		117.0	1.10	*		112.2	0.96	*	*
	5	118.5	1.17			116.8	0.90	*		114.4	0.66	*		116.8	0.95	*		112.8	0.76	*		113.0	0.94	*		119.4	1.10	*		113.8	0.96	*	*
Calcium (9.42-11.74 mg/dl)	1	10.1	0.17			10.8	0.18	*		10.6	0.17	*		10.4	0.19	*		10.2	0.17	*		10.8	0.16	*		10.5	0.16	*		10.5	0.13	*	
	2	10.1	0.17			11.0	0.18	*		10.7	0.17	*		10.7	0.19	*		10.3	0.17	*		10.8	0.17	*		11.1	0.16	*		10.5	0.13	*	
	3	10.0	0.17			10.9	0.18	*		10.5	0.17	*		10.3	0.19	*		10.0	0.17	*		10.6	0.17	*		11.0	0.16	*		10.4	0.13	*	
	4	10.3	0.19			11.4	0.20	*	*	11.1	0.19	*	*	10.9	0.22	*	*	10.5	0.19	*	*	11.2	0.19	*	*	11.5	0.18	*	*	10.8	0.14	*	*
	5	10.2	0.19			11.1	0.20	*	*	10.7	0.19	*	*	10.6	0.22	*	*	10.3	0.19	*	*	10.7	0.19	*	*	11.3	0.18	*	*	10.5	0.14	*	*
Phosphorus (2.8-6.2 mg/dl)	1	3.8	0.22			4.0	0.19			4.0	0.29			3.8	0.29			4.2	0.27	*		3.5	0.21	*		3.3	0.27	*		4.1	0.20	*	
	2	4.3	0.22	*		4.0	0.19			4.2	0.29			4.1	0.29			4.0	0.27	*		3.1	0.21	*		3.0	0.27	*		3.7	0.20	*	*
	3	4.2	0.22			4.3	0.19			4.1	0.29			4.0	0.29			3.9	0.27	*		3.0	0.21	*		3.4	0.27	*		3.7	0.20	*	*
	4	3.8	0.25			4.1	0.21			4.1	0.32			3.9	0.32			4.0	0.30	*		3.3	0.23	*		3.8	0.29	*		3.7	0.22	*	*
	5	4.2	0.25			4.2	0.21			4.1	0.32			4.0	0.32			4.0	0.30	*		3.0	0.23	*		3.0	0.29	*		4.4	0.22	*	*
Magnesium (1.3-2.0 mEq/L)	1	1.7	0.04			1.6	0.05	*		1.7	0.05			1.8	0.05			1.7	0.07			1.7	0.05			1.9	0.08			2.0	0.07	*	
	2	1.8	0.04			1.6	0.05	*		1.8	0.05			1.9	0.05			1.8	0.07			1.9	0.05	*		1.7	0.08			2.1	0.07	*	*
	3	1.8	0.04			1.7	0.05			1.8	0.05			1.8	0.05			1.7	0.07			1.8	0.05			1.8	0.08			2.0	0.07	*	*
	4	1.7	0.05			1.7	0.05			1.8	0.05			1.8	0.06			1.8	0.08			1.8	0.06			1.8	0.08			2.1	0.08	*	*
	5	1.7	0.05			1.7	0.05			1.7	0.05			1.8	0.06			1.8	0.08			1.9	0.06			1.8	0.08			2.1	0.08	*	*
Potassium (4.1-5.4 mmol/L)	1	4.6	0.09			4.9	0.10	*		5.0	0.11	*		5.1	0.08	*		4.7	0.09	*		4.7	0.09	*		4.9	0.09	*		4.8	0.08	*	
	2	4.6	0.09			4.8	0.10	*		4.8	0.11	*		5.0	0.08	*		4.5	0.09	*		4.6	0.09	*		4.9	0.09	*		4.5	0.08	*	*
	3	4.6	0.09			4.7	0.10	*		4.8	0.11	*		4.9	0.08	*	*	4.5	0.09	*		4.6	0.09	*		5.1	0.09	*		4.4	0.08	*	*
	4	4.4	0.10			4.6	0.11	*		4.8	0.12	*		4.8	0.08	*	*	4.4	0.10	*	*	4.5	0.10	*		4.8	0.10	*		4.7	0.09	*	*
	5	4.6	0.10			4.5	0.11	*		4.6	0.12	*		4.5	0.08	*	*	4.2	0.10	*	*	4.4	0.10	*	*	4.6	0.10	*		4.6	0.09	*	*

Group 1 (n=6): Control
 Group 2 (n=6): 150 ppm
 Group 3 (n=6): 1500 ppm
 Group 4 (n=5): 3000 ppm
 Group 5 (n=5): 4500 ppm

Serum biochemistry values among dogs receiving dl- α -lipoic acid in the diet for 1 year (Week 0 to 24, Cont'd)

	Group	Initial				Week 2				Week 4				Week 8				Week 12				Week 16				Week 20				Week 24			
		Mean	SE	p ¹		Mean	SE	p ¹	p ²	Mean	SE	p ¹	p ²	Mean	SE	p ¹	p ²	Mean	SE	p ¹	p ²	Mean	SE	p ¹	p ²	Mean	SE	p ¹	p ²	Mean	SE	p ¹	p ²
Total Protein (5.7-7.6 gm/dl)	1	7.0	0.27			6.7	0.21			6.5	0.23			6.5	0.23			6.6	0.22			6.5	0.24			6.7	0.22			6.6	0.22		
	2	7.1	0.27			7.0	0.21			6.7	0.23			6.9	0.23			7.1	0.22			6.8	0.24			6.8	0.22			6.6	0.22	*	
	3	6.7	0.27			6.4	0.21	*		6.1	0.23	*		6.5	0.23			6.5	0.22			6.3	0.24	*		6.3	0.22	*		6.4	0.22		
	4	7.3	0.29			7.2	0.23			7.0	0.25			7.0	0.26			7.3	0.24	*		7.0	0.26			7.3	0.24			7.1	0.24		
	5	7.1	0.29			6.7	0.23			6.5	0.25	*		6.8	0.26			6.5	0.24	*		6.3	0.26	*		6.5	0.24	*		6.3	0.24	*	
Albumin (2.6-3.9 gm/dl)	1	3.5	0.09			3.6	0.11			3.5	0.10			3.4	0.10			3.4	0.11			3.3	0.09			3.5	0.09			3.4	0.09		
	2	3.5	0.09			3.6	0.11			3.5	0.10			3.5	0.10			3.7	0.11			3.4	0.09			3.6	0.09			3.5	0.09		
	3	3.3	0.09	*		3.4	0.11			3.3	0.10			3.3	0.10			3.4	0.11			3.2	0.09			3.4	0.09			3.4	0.09		
	4	3.5	0.10			3.7	0.12			3.8	0.11	*		3.8	0.11	*		3.9	0.12	*		3.5	0.10			3.7	0.10			3.7	0.10		
	5	3.3	0.10	*		3.6	0.12			3.6	0.11			3.7	0.11	*		3.6	0.12	*		3.3	0.10			3.6	0.10	*		3.3	0.10		
Globulin (2.6-4.4 gm/dl)	1	3.5	0.32			3.1	0.24			2.9	0.28			3.1	0.28			3.1	0.26			3.2	0.26			3.2	0.26			3.2	0.23		
	2	3.6	0.32			3.4	0.24			3.2	0.28			3.4	0.28			3.4	0.26			3.4	0.26			3.2	0.26			3.1	0.23	*	
	3	3.4	0.32			3.0	0.24	*		2.8	0.28	*		3.1	0.28			3.0	0.26	*		3.0	0.26	*		3.0	0.26	*		3.0	0.23	*	
	4	3.8	0.35			3.5	0.26			3.2	0.31			3.2	0.31			3.4	0.29			3.5	0.29			3.5	0.28			3.4	0.25		
	5	3.8	0.35			3.2	0.26			2.9	0.31	*		3.1	0.31			2.9	0.29	*		2.9	0.29	*		2.9	0.28	*		2.9	0.25	*	
A:G Ratio (0.5-1.2)	1	1.03	0.09			1.20	0.10			1.23	0.12			1.10	0.12			1.12	0.10			1.05	0.09			1.10	0.10			1.10	0.08		
	2	1.01	0.09			1.10	0.10			1.12	0.12			1.07	0.12			1.12	0.10			1.03	0.09			1.15	0.10			1.15	0.08		
	3	1.00	0.09			1.12	0.10			1.23	0.12			1.06	0.12			1.13	0.10	*		1.08	0.09			1.12	0.10			1.15	0.08	*	
	4	0.98	0.10			1.12	0.11			1.30	0.14			1.30	0.13			1.20	0.11			1.12	0.10			1.18	0.11			1.18	0.09		
	5	1.00	0.10			1.16	0.11			1.32	0.14	*		1.28	0.13			1.30	0.11	*		1.16	0.10			1.28	0.11			1.16	0.09		
ALT (15-90 IU/L)	1	71.5	17.04			66.5	17.54			53.2	7.60			53.0	9.77			51.8	11.91			48.2	6.12			57.5	12.03			59.0	11.26		
	2	35.3	17.04	*		33.3	17.54			31.8	7.60			34.7	9.77			43.7	11.91			37.3	6.12			43.0	12.03			36.2	11.26		
	3	31.8	17.04	*		66.3	17.54	*		30.7	7.60	*		32.2	9.77			44.7	11.91			28.7	6.12	*		53.8	12.03	*		33.7	11.26		
	4	50.7	18.67			46.4	19.22			32.4	8.32			36.8	10.71			38.8	13.04			42.4	6.71			64.2	13.18			39.2	12.34		
	5	37.1	18.67			33.0	19.22			34.0	8.32			55.0	10.71			34.4	13.04			30.2	6.71			37.0	13.18			48.0	12.34		
ALP (18-94 IU/L)	1	37.3	7.27			48.0	21.66			75.2	16.58			84.7	20.27			85.0	20.45			79.2	21.07			67.3	16.97			64.2	15.30		
	2	30.7	7.27			50.0	21.66			68.2	16.58			69.7	20.27			70.5	20.45			70.0	21.07			61.0	16.97			61.7	15.30		
	3	60.4	7.27	*		67.5	21.66			70.7	16.58			86.0	20.27			94.8	20.45			96.5	21.07			68.8	16.97			64.8	15.30		
	4	41.1	7.96			95.4	23.73	*		50.4	18.16			50.8	22.20			52.2	22.41			50.8	23.08			49.2	18.59			44.0	16.76		
	5	44.8	7.96			47.6	23.73			39.8	18.16			63.2	22.20			52.8	22.41			46.8	23.08			41.4	18.59			41.6	16.76		
Total Billirubin (0.0-0.23 mg/dl)	1	0.13	0.02			0.15	0.02			0.15	0.03			0.18	0.02			0.15	0.02			0.18	0.02			0.12	0.02			0.17	0.02		
	2	0.21	0.02	*		0.15	0.02	*		0.15	0.03	*		0.20	0.02			0.13	0.02	*		0.13	0.02	*		0.15	0.02	*		0.12	0.02	*	
	3	0.18	0.02			0.18	0.02			0.17	0.03			0.15	0.02			0.12	0.02	*		0.10	0.02	*		0.17	0.02	*		0.12	0.02	*	
	4	0.16	0.02			0.18	0.02			0.16	0.03			0.20	0.02			0.18	0.03			0.18	0.02	*		0.18	0.02	*		0.18	0.02	*	
	5	0.16	0.02			0.20	0.02			0.16	0.03			0.18	0.02			0.18	0.03			0.18	0.02	*		0.18	0.02	*		0.12	0.02		
Triglycerides (14-131 mg/dl)	1	36.6	3.33			50.3	5.36			61.8	6.93	*		56.8	5.32			79.5	11.22	*		81.7	13.44	*		50.2	5.48			80.8	10.40	*	
	2	39.4	3.33			42.2	5.36			45.5	6.93			52.8	5.32			68.7	11.22	*		68.5	13.44	*		48.8	5.48			69.3	10.40	*	
	3	37.3	3.33			45.7	5.36			36.6	6.93	*		38.5	5.32	*		68.8	11.22	*		68.0	13.44	*		41.8	5.48			69.2	10.40	*	
	4	32.1	3.66			43.0	5.88			43.6	7.60			46.2	5.83	*		49.6	12.29	*		57.0	14.72	*		54.2	6.00	*		54.2	10.40	*	
	5	35.8	3.66			33.4	5.88	*		34.6	7.60	*		35.4	5.83	*		39.0	12.29	*		52.4	14.72	*		37.8	6.00			42.4	11.39	*	
Cholesterol (106.2-368.2 mg/dl)	1	160.4	15.29			180.7	16.26			237.5	21.54	*		234.8	19.78	*		219.5	19.18	*		182.3	16.15			162.8	14.30			188.7	15.46		
	2	198.1	15.29	*		219.7	16.26			249.2	21.54	*		245.3	19.78	*		218.3	19.18			199.7	16.15			200.7	14.30			212.7	15.46		
	3	197.3	15.29	*		199.5	16.26			208.3	21.54			192.8	19.78			208.8	19.18			204.3	16.15			189.2	14.30			209.2	15.46		
	4	170.0	16.75			184.6	17.81			201.4	23.80			203.4	21.87			212.8	21.01			196.0	17.69			191.2	15.67			200.8	16.94		
	5	154.6	16.75			163.4	17.81			159.8	23.80	*		171.8	21.87	*		157.0	21.01	*		167.6	17.69			173.8	15.67			184.2	16.94		

</

Serum biochemistry values among dogs receiving dl- α -lipoic acid in the diet for 1 year (Weeks 28 to 52, Cont'd)

	Group	Initial				Week 28				Week 32				Week 36				Week 40				Week 44				Week 48				Week 52			
		Mean	SE	p ¹	p ²	Mean	SE	p ¹	p ²	Mean	SE	p ¹	p ²	Mean	SE	p ¹	p ²	Mean	SE	p ¹	p ²	Mean	SE	p ¹	p ²	Mean	SE	p ¹	p ²	Mean	SE	p ¹	p ²
Total Protein (5.7-7.6 gm/dl)	1	7.0	0.27			6.4	0.18			7.0	0.25			6.7	0.30			6.8	0.20			6.6	0.24			7.0	0.32			7.0	0.23		
	2	7.1	0.27			6.3	0.18	*		6.8	0.25			6.4	0.30	*		6.8	0.20	*		6.5	0.24	*		6.8	0.32			6.6	0.23	*	
	3	6.7	0.27			6.3	0.18	*		6.6	0.25			6.3	0.30	*		6.2	0.20	*	*	6.3	0.24	*		6.7	0.32			6.6	0.23		
	4	7.3	0.30			6.6	0.20			7.2	0.27			6.9	0.33			7.1	0.22			7.1	0.26			7.5	0.35			7.0	0.26		
	5	7.1	0.30			6.2	0.20	*		6.6	0.27	*		6.2	0.33	*		6.4	0.22	*		6.3	0.26	*		6.7	0.35			6.5	0.26	*	
Albumin (2.8-3.9 gm/dl)	1	3.5	0.09			3.3	0.14			3.2	0.12	*		3.2	0.11	*		3.3	0.11	*		3.1	0.10	*		3.2	0.09	*		3.3	0.09		
	2	3.5	0.09			3.6	0.14			3.5	0.12			3.6	0.11	*		3.6	0.11	*		3.4	0.10	*		3.7	0.09	*		3.6	0.09		
	3	3.3	0.09	*		3.4	0.14			3.2	0.12			3.3	0.11			3.1	0.11			3.2	0.10			3.4	0.09			3.4	0.09		
	4	3.5	0.10			3.6	0.16			3.4	0.13			3.5	0.12			3.4	0.12			3.6	0.11	*		3.7	0.10	*		3.6	0.10	*	
	5	3.3	0.10	*		3.6	0.16			3.4	0.13			3.5	0.12			3.4	0.11	*		3.4	0.11	*		3.6	0.10	*		3.5	0.10		
Globulin (2.6-4.4 gm/dl)	1	3.5	0.32			3.1	0.24			3.9	0.28			3.5	0.33			3.8	0.26			3.5	0.28			3.8	0.35			3.7	0.27		
	2	3.6	0.32			2.7	0.24	*		3.3	0.28			2.8	0.33	*		3.0	0.26	*		3.0	0.28	*		3.1	0.35			3.1	0.27	*	
	3	3.4	0.32			2.8	0.24	*		3.5	0.28			3.0	0.33	*		3.0	0.26	*		3.1	0.28	*		3.3	0.35			3.2	0.27		
	4	3.8	0.36			3.0	0.27			3.8	0.31			3.4	0.36			3.7	0.28			3.5	0.31			3.8	0.38			3.4	0.29		
	5	3.8	0.36			2.7	0.27	*		3.2	0.31			2.7	0.36	*		3.0	0.28	*		2.9	0.31	*		3.1	0.38			3.0	0.29	*	
A:G Ratio (0.5-1.2)	1	1.03	0.09			1.10	0.13			0.87	0.09			0.98	0.12			0.95	0.10			0.92	0.10			0.92	0.09			1.0	0.09		
	2	1.01	0.09			1.33	0.13	*		1.07	0.09			1.32	0.12	*		1.18	0.10			1.15	0.10			1.18	0.09	*		1.2	0.09		
	3	0.98	0.09			1.22	0.13	*		0.93	0.09			1.12	0.12			1.07	0.10			1.07	0.10			1.03	0.09			1.1	0.09		
	4	0.98	0.10			1.30	0.14	*		0.98	0.09			1.16	0.13			1.00	0.11			1.10	0.11			1.06	0.10			1.1	0.09		
	5	0.92	0.10			1.46	0.15	*		1.10	0.09			1.34	0.13	*		1.20	0.11			1.20	0.11			1.14	0.10			1.1	0.09		
ALT (15-90 IU/L)	1	71.5	17.04			57.7	10.37			50.2	7.90			49.2	8.01			64.8	14.43			61.0	16.28			54.3	8.04			54.0	7.99		
	2	35.3	17.04	*		41.3	10.37			37.7	7.90			38.5	8.01			38.5	14.43			37.5	16.28			41.2	8.04			41.5	7.99		
	3	31.8	17.04	*		31.7	10.37			31.7	7.90			33.0	8.01			30.5	14.43			42.2	16.28			33.3	8.04			36.0	7.99		
	4	50.7	18.67			41.6	11.35			41.6	8.66			40.4	8.77			41.6	15.81			38.8	17.83			40.4	8.81			49.6	8.75		
	5	37.1	18.67			30.6	11.36			36.2	8.66			37.4	8.77			38.0	15.81			62.2	17.83	*		37.0	8.81			36.4	8.75		
ALP (18-94 IU/L)	1	37.3	7.27			94.0	23.56	*		65.5	15.47			75.0	16.63			75.0	15.82			60.0	12.09			70.2	16.37			84.5	15.87		
	2	30.7	7.27			80.2	23.56			57.3	15.47			56.8	16.63			57.0	15.82			46.2	12.09			59.3	16.37			79.2	15.87		
	3	60.4	7.27	*		65.3	23.56			63.2	15.47			64.5	16.63			57.3	15.82			57.5	12.09			68.8	16.37			92.2	15.87		
	4	41.1	7.96			50.6	25.80			40.4	16.94			45.2	18.21			40.8	17.33			40.0	13.24			45.6	17.93			61.8	17.38		
	5	44.8	7.96			41.2	25.80			35.0	16.94			40.4	18.21			40.6	17.33			38.8	13.24			40.2	17.93			51.0	17.38		
Total Bilirubin (0.0-0.23 mg/dl)	1	0.13	0.02			0.12	0.02			0.18	0.02			0.25	0.03	*		0.23	0.03	*		0.20	0.03			0.20	0.01			0.27	0.05	*	
	2	0.21	0.02	*		0.17	0.02			0.13	0.02	*		0.18	0.03			0.22	0.03			0.22	0.03			0.20	0.01			0.20	0.05		
	3	0.18	0.02			0.15	0.02			0.13	0.02			0.22	0.03			0.20	0.03			0.23	0.03	*		0.22	0.01			0.22	0.05		
	4	0.16	0.02			0.16	0.02			0.18	0.02			0.28	0.03	*		0.22	0.03	*		0.22	0.03			0.22	0.02			0.36	0.05	*	
	5	0.16	0.02			0.18	0.02	*		0.20	0.02			0.20	0.03			0.24	0.03	*		0.22	0.03	*		0.24	0.02			0.30	0.05	*	
Triglycerides (14-131 mg/dl)	1	36.6	3.34			63.3	9.30	*		80.3	8.30	*		68.7	8.03	*		80.7	9.14	*		68.0	7.63	*		60.3	8.26	*		67.2	7.46	*	
	2	39.4	3.34			66.0	9.30	*		55.8	8.30	*		57.5	8.03	*		60.7	9.14	*		62.8	7.63	*		58.5	8.26	*		55.8	7.46	*	
	3	37.3	3.34			47.0	9.30			66.2	8.30	*		56.0	8.03	*		63.9	9.14	*		60.2	7.63	*		62.8	8.26	*		52.2	7.46	*	
	4	32.1	3.66			45.0	10.17			59.0	9.10	*		50.8	8.80	*		47.6	10.02	*	*	49.8	8.36	*		52.0	9.04	*		53.8	8.17	*	
	5	35.8	3.66			27.0	10.17	*		32.6	9.10	*		30.2	8.80	*		28.0	10.02	*	*	39.4	8.36	*		36.4	9.04	*		60.0	8.17	*	
Cholesterol (106.2-368.2 mg/dl)	1	160.4	15.28			189.7	19.96			192.5	17.65			206.3	17.40	*		211.8	13.88	*		184.5	11.78			198.5	15.78			202.3	18.14		
	2	198.1	15.28	*		237.7	19.96			222.5	17.65			228.2	17.40	*		240.0	13.88	*		208.0	11.78			217.2	15.78			221.5	18.14		
	3	197.3	15.28	*		231.2	19.96			228.8	17.65			217.8	17.40	*		193.5	13.88			200.7	11.78			210.0	15.78			221.8	18.14		
	4	170.0	16.75			211.6	21.87			204.2	19.33			190.8	19.06			198.8	15.20			204.0	12.91			212.8	17.29			224.6	19.87	*	
	5	154.6	16.75			185.0	21.87			186.2	19.33	*		176.2	19.06			174.8	15.20			180.6	12.91			183.6	17.29			183.6	19.87		

Group 1 (n=6): Control
 Group 2 (n



Hematology values among dogs receiving dl- α -lipoic acid in the diet for 1 year (Week 0 to 24)

	Group	Initial			Week 2				Week 4				Week 8				Week 12				Week 16				Week 20				Week 24			
		Mean	SE	p ¹	Mean	SE	p ¹	p ²	Mean	SE	p ¹	p ²	Mean	SE	p ¹	p ²	Mean	SE	p ¹	p ²	Mean	SE	p ¹	p ²	Mean	SE	p ¹	p ²	Mean	SE	p ¹	p ²
WBC (6.02-16.02 Thousand/mm ³)	1	13.4	1.85		11.4	1.00			12.9	1.68			13.0	1.24			13.5	1.13			14.6	1.39			13.3	1.22			15.8	1.10		
	2	11.3	1.85		10.3	1.00			10.3	1.68			10.7	1.24			11.1	1.13			11.4	1.39			11.1	1.22			10.5	1.10	*	
	3	15.7	1.85		11.0	1.00		*	11.1	1.68		*	10.9	1.24		*	11.4	1.13		*	12.5	1.39		*	12.1	1.22		*	13.3	1.10		
	4	13.7	2.03		13.5	1.10			13.3	1.84			12.0	1.36			12.1	1.23			13.8	1.52			13.0	1.34			15.9	1.21		
	5	14.6	2.03		11.8	1.10			12.8	1.84			12.3	1.36			13.1	1.23			14.2	1.52			12.5	1.34			14.9	1.21		
RBC (6.15-8.70 Million/mm ³)	1	7.6	0.29		7.7	0.25			7.1	0.23			7.1	0.31			7.0	0.32			7.0	0.29			7.5	0.29			7.4	0.25		
	2	7.4	0.29		7.4	0.25			6.9	0.23			7.1	0.31			7.5	0.32			6.9	0.29			7.4	0.29			7.1	0.25		
	3	6.7	0.29	*	6.5	0.25	*		8.3	0.23	*		8.3	0.31	*		6.9	0.32			6.5	0.29			6.7	0.29		*	6.4	0.25	*	
	4	7.0	0.32		7.6	0.27			7.3	0.25			7.3	0.34			7.6	0.35			7.1	0.31			7.5	0.32			6.8	0.25		
	5	6.8	0.32	*	6.9	0.27	*		6.6	0.25			7.2	0.34			7.1	0.35			6.6	0.31			7.0	0.32			6.2	0.28	*	*
RDW (11.9-14.9%)	1	16.6	0.68		17.4	0.82			17.0	0.53			17.1	0.89			17.2	0.64			17.5	0.51			16.1	0.55			19.3	1.11	*	
	2	17.5	0.68		17.8	0.82			17.3	0.53			17.9	0.89			17.9	0.64			16.4	0.51			16.1	0.55			17.1	1.11		
	3	16.7	0.68		17.1	0.82			17.3	0.53			18.8	0.89			16.3	0.51			16.3	0.51			16.3	0.55			16.9	1.11		
	4	17.6	0.75		16.5	0.89			16.9	0.59			17.2	0.98			16.2	0.70			17.0	0.55			16.0	0.60			19.4	1.21		
	5	15.8	0.75		15.9	0.89			14.9	0.59	*		15.5	0.98			14.9	0.70	*		15.7	0.55	*		15.5	0.60			15.6	1.21	*	
Hemoglobin (14.1-20.0 gm/dl)	1	17.6	0.62		17.5	0.54			16.6	0.58			16.0	0.68			16.9	0.74			17.0	0.63			17.8	0.59			17.9	0.57		
	2	16.9	0.62		17.0	0.54			16.0	0.58			16.2	0.68			16.8	0.63			16.8	0.63			18.0	0.59			17.7	0.67		
	3	15.6	0.62	*	15.1	0.54	*		14.8	0.58	*		14.6	0.68			16.9	0.74			16.1	0.63			16.3	0.59			16.4	0.57		
	4	16.3	0.68	*	17.5	0.59			16.8	0.64			16.4	0.74			18.2	0.82	*		17.0	0.69			18.3	0.65	*		17.1	0.62		
	5	16.1	0.68	*	15.9	0.59	*		15.2	0.64			16.3	0.74			16.8	0.82			16.1	0.69			17.0	0.65			16.9	0.62	*	
Hematocrit (43.4-59.3%)	1	54.8	2.00		54.8	1.89			50.3	1.73			50.3	2.25			50.5	2.29			50.7	1.90			54.1	2.01			54.2	1.76		
	2	52.1	2.00		52.4	1.89			49.3	1.73			50.1	2.25			54.0	2.29			49.8	1.90			53.6	2.01			51.4	1.76		
	3	47.1	2.00	*	46.0	1.69	*		44.9	1.73	*		45.1	2.25			49.5	2.29			47.1	1.90			48.1	2.01			47.3	1.76	*	
	4	49.5	2.20	*	53.4	1.85			51.3	1.90			51.7	2.47			53.9	2.50			50.3	2.08			54.5	2.20	*		49.3	1.93		
	5	48.5	2.20	*	48.8	1.85	*		46.5	1.90			50.5	2.47			50.5	2.50			47.2	2.08			50.5	2.20			45.4	1.93	*	
MCV (63.0-77.1 fl)	1	71.7	0.96		71.4	1.05			71.1	1.03			70.8	1.06			72.2	0.93			72.7	0.93			72.8	1.01			73.4	1.16	*	
	2	70.7	0.96		70.5	1.05			69.9	1.03			70.9	1.06			71.5	0.93			72.4	0.93			72.1	1.01			73.0	1.16		
	3	70.6	0.96		70.8	1.05			71.6	1.03			72.0	1.06			71.8	0.93			72.1	0.93			72.2	1.01			73.4	1.16		
	4	70.6	1.06		70.3	1.15			70.5	1.13			70.9	1.16			70.8	1.01			71.5	1.02			72.4	1.11			72.5	1.27		
	5	70.8	1.06		71.0	1.15			70.6	1.13			70.5	1.16			71.2	1.01			72.0	1.02			72.2	1.11			73.2	1.27		
MCH (21.1-24.8 pg)	1	23.1	0.44		22.9	0.42			23.5	0.46			22.6	0.47			24.2	0.43	*		24.4	0.46	*		23.9	0.44	*		24.3	0.47	*	
	2	23.0	0.44		22.8	0.42			23.1	0.46			22.9	0.47			24.1	0.43	*		24.4	0.46	*		24.3	0.44	*		25.0	0.47	*	
	3	23.4	0.44		23.3	0.42			23.6	0.46			23.3	0.47			24.5	0.43	*		24.7	0.46	*		24.6	0.44	*		25.5	0.47	*	
	4	23.3	0.48		23.0	0.46			23.2	0.51			22.5	0.52			24.0	0.48			24.2	0.50			24.3	0.48			25.2	0.52	*	
	5	23.4	0.48		23.1	0.46			23.1	0.51			22.6	0.52			23.6	0.48			24.7	0.50			24.3	0.48			25.7	0.52	*	
MCHC (29.9-35.6 %)	1	32.2	0.30		32.0	0.29			33.0	0.40			31.9	0.31			33.5	0.37	*		33.5	0.36	*		33.0	0.34			33.1	0.42	*	
	2	32.5	0.30		32.4	0.29			33.1	0.40			32.3	0.31			33.7	0.37	*		33.7	0.36	*		33.7	0.34	*		34.3	0.42	*	*
	3	33.2	0.30	*	32.9	0.29	*		33.0	0.40			32.4	0.31			34.1	0.37	*		34.2	0.36	*		34.1	0.34	*		34.7	0.42	*	*
	4	33.0	0.33	*	32.7	0.32	*		32.9	0.44			31.7	0.34	*		33.6	0.41			33.8	0.39			33.6	0.37			34.8	0.46	*	*
	5	33.1	0.33	*	32.5	0.32	*		32.7	0.44			32.3	0.34	*		33.4	0.41			34.2	0.39	*		33.7	0.37	*		35.1	0.46	*	*
Platelets (164-510 Thousand/mm ³)	1	149.6	24.90		168.0	30.85			191.3	29.41			208.5	25.36			250.8	28.99	*		222.0	29.66	*		195.3	29.87			137.7	17.85		
	2	176.3	24.90		203.5	30.85			242.8	29.41	*		226.3	25.36			232.3	28.99	*		224.0	29.66	*		217.5	29.87			191.7	17.85	*	
	3	209.6	24.90		196.8	30.85			247.0	29.41	*		216.5	25.36			237.8	28.99	*		224.5	29.66	*		220.2	29.87			190.7	17.85	*	
	4	167.7	27.27		257.6	33.90	*		220.4	28.93			230.6	27.78			214.6	31.76			241.8	29.66	*		186.8	32.72			206.0	19.56	*	
	5	199.8	27.27		265.4	33.90	*		258.2	28.93			241.6	27.78			261.2	31.76			256.8	32.49	*		221.2	32.72			266.0	19.56	*	
MPV (6.2-10.0 fl)	1	10.7	0.31		10.3	0.30			10.2	0.35			10.0	0.31	*		10.6	0.32			10.1	0.28	*		10.0	0.35	*		9.8			

Hematology values among dogs receiving dl- α -lipoic acid in the diet for 1 year (Weeks 28 to 52)

	Group	Initial			Week 28				Week 32				Week 36				Week 40				Week 44				Week 48				Week 52			
		Mean	SE	p ¹	Mean	SE	p ¹	p ²	Mean	SE	p ¹	p ²	Mean	SE	p ¹	p ²	Mean	SE	p ¹	p ²	Mean	SE	p ¹	p ²	Mean	SE	p ¹	p ²	Mean	SE	p ¹	p ²
WBC (6.02-16.02 Thousand/mm ³)	1	13.4	1.85		15.2	1.16			14.6	0.96			14.4	1.09			12.0	1.05			13.7	1.17			14.0	1.25			13.2	1.23		
	2	11.3	1.85		10.8	1.06	*		12.2	0.96			10.3	1.09	*		10.1	1.05			10.5	1.17			10.8	1.25			9.3	1.23	*	*
	3	15.7	1.85		12.6	1.06			13.4	0.96			13.6	1.09			11.1	1.05		*	11.3	1.17		*	11.7	1.25		*	12.4	1.23		*
	4	13.7	2.03		15.5	1.16			13.6	1.05			14.5	1.20			14.0	1.15			12.5	1.29			13.8	1.37			14.2	1.35		
	5	14.6	2.03		14.7	1.16			13.9	1.05			13.8	1.20			15.2	1.15	*		13.0	1.29			15.2	1.37			14.2	1.35		
RBC (6.15-8.70 Million/mm ³)	1	7.6	0.29		6.7	0.31	*		6.2	0.29	*		6.6	0.25	*		6.8	0.31	*		6.7	0.25	*		6.9	0.24			7.5	0.28		
	2	7.4	0.29		7.2	0.28			6.2	0.29	*		6.7	0.25	*		6.8	0.31	*		6.9	0.25			7.4	0.24			7.5	0.28		
	3	6.7	0.29	*	6.2	0.28			6.2	0.29	*		6.2	0.25	*		6.0	0.31			6.9	0.25			7.0	0.24			7.1	0.28		
	4	7.0	0.32		7.0	0.31			6.2	0.31	*		6.9	0.27	*		7.1	0.34			7.4	0.27			7.6	0.27	*		7.5	0.31		
	5	6.8	0.32	*	6.2	0.31	*		5.7	0.31	*		6.5	0.27	*		6.6	0.34			6.6	0.27			6.8	0.27			6.8	0.31		
RDW (11.9-14.9 %)	1	16.6	0.68		16.6	0.77			17.8	0.53			16.0	0.47			15.6	0.50			17.0	0.68			16.4	0.61			17.4	0.78		
	2	17.5	0.68		17.4	0.70			16.8	0.53			16.0	0.47			16.2	0.50			16.9	0.68			16.1	0.61			16.4	0.78		
	3	16.7	0.68		15.8	0.70			16.4	0.53			16.7	0.47			15.5	0.50			15.2	0.68			16.4	0.61			17.2	0.78		
	4	17.6	0.75		18.3	0.77			17.0	0.58			16.3	0.52			15.4	0.55			15.8	0.75		*	18.8	0.67	*		18.2	0.85		
	5	15.8	0.75		17.0	0.77			16.8	0.58			15.1	0.52			15.2	0.55			16.0	0.75			15.2	0.67			15.6	0.85		
Hemoglobin (14.1-20.0 gm/dl)	1	17.6	0.62		16.4	0.60			16.3	0.62			16.3	0.47			16.6	0.70			16.5	0.56			16.6	0.55			17.7	0.63		
	2	16.9	0.62		17.3	0.60			17.1	0.62			16.9	0.47			16.8	0.70			17.4	0.56			18.1	0.55			18.2	0.63		
	3	15.6	0.62	*	15.7	0.60			15.5	0.62			15.6	0.47			15.4	0.70			17.2	0.56			17.3	0.55			17.3	0.63		
	4	16.3	0.68	*	17.1	0.66			16.4	0.68			16.7	0.51			17.1	0.77			17.4	0.62			18.3	0.61	*	*	17.8	0.70	*	
	5	16.1	0.68	*	15.7	0.66			15.6	0.68			16.5	0.51			16.2	0.77			16.3	0.62			17.0	0.61			17.1	0.70		
Hematocrit (43.4-59.3 %)	1	54.8	2.00		48.6	2.20	*		45.4	1.96	*		47.9	1.69	*		49.4	2.20			48.3	1.74	*		50.1	1.69			54.6	2.15		
	2	52.1	2.00		51.6	2.01			45.8	1.96	*		49.1	1.69	*		49.4	2.20			50.5	1.74			54.5	1.69			55.4	2.15		
	3	47.1	2.00	*	45.6	2.01			42.6	1.96	*		45.7	1.69	*		44.6	2.20			50.1	1.74			51.4	1.69			52.0	2.15		
	4	49.5	2.19	*	49.8	2.01			43.9	2.15	*		49.1	1.85	*		50.8	2.41			52.7	1.91			55.3	1.85	*	*	54.3	2.36	*	
	5	48.5	2.19	*	44.9	2.20			42.4	2.15	*		47.7	1.85	*		48.6	2.41			48.8	1.91			50.5	1.85			50.3	2.36		
MCV (63.0-77.1 f)	1	71.7	0.97		72.2	1.17			73.9	1.14	*		72.7	1.17			72.9	1.04			72.0	1.21			72.9	1.05			73.0	1.13		
	2	70.7	0.97		72.0	1.06			73.4	1.14	*		73.4	1.17	*		73.2	1.04			73.4	1.21	*		74.0	1.05	*		73.6	1.13	*	
	3	70.6	0.97		73.2	1.06			74.3	1.14	*		73.8	1.17	*		73.7	1.04	*		72.9	1.21			73.3	1.05			73.3	1.13		
	4	70.6	1.06		71.3	1.17			71.6	1.25	*		71.7	1.28	*		71.6	1.14			71.1	1.33			72.4	1.15			73.0	1.24		
	5	70.8	1.06		72.5	1.17			74.5	1.25	*		73.5	1.28	*		73.9	1.14			73.8	1.33			74.4	1.15	*		73.6	1.24		
MCH (21.1-24.8 pg)	1	23.1	0.44		24.4	0.59	*		26.6	0.64	*		24.8	0.51	*		24.5	0.48	*		24.6	0.50	*		24.2	0.53	*		23.7	0.46		
	2	23.0	0.44		24.1	0.50	*		27.4	0.64	*		25.2	0.51	*		25.0	0.48	*		25.3	0.50	*		24.6	0.53	*		24.1	0.46	*	
	3	23.4	0.44		25.2	0.50	*		27.2	0.64	*		25.3	0.51	*		25.5	0.48	*		25.0	0.50	*		24.6	0.53	*		24.4	0.46		
	4	23.3	0.48		24.5	0.55	*		26.7	0.70	*		24.5	0.56	*		24.2	0.53	*		23.6	0.55	*		24.0	0.58	*		24.0	0.50	*	
	5	23.4	0.48		25.4	0.55	*		27.4	0.70	*		25.5	0.56	*		24.7	0.53	*		24.7	0.55	*		25.0	0.58	*		25.0	0.50	*	
MCHC (29.9-35.6 %)	1	32.2	0.30		33.8	0.43	*		35.9	0.63	*		34.1	0.40	*		33.8	0.38	*		34.3	0.29	*		33.2	0.40	*		32.5	0.35		
	2	32.5	0.30		33.6	0.39	*		37.4	0.63	*		34.3	0.40	*		34.1	0.38	*		34.4	0.29	*		33.2	0.40	*		32.8	0.35		
	3	33.2	0.30	*	34.4	0.39	*		36.7	0.63	*		34.2	0.40	*		34.6	0.38	*		34.3	0.29	*		33.6	0.40	*		33.3	0.35		
	4	33.0	0.33	*	34.3	0.43	*		37.4	0.69	*		34.1	0.44	*		33.7	0.42	*		33.1	0.31	*		33.2	0.43	*		32.8	0.38		
	5	33.1	0.33	*	35.1	0.43	*		36.8	0.69	*		34.7	0.44	*		33.4	0.42	*		33.4	0.31	*		33.6	0.43	*		34.0	0.38	*	
Platelets (164-510 Thousand/mm ³)	1	149.6	24.90		195.8	23.86			157.0	25.19			225.7	27.01	*		220.5	24.90	*		192.3	20.21			189.0	24.99			219.7	21.62	*	
	2	176.3	24.90		214.0	21.78			187.0	25.19			214.3	27.01	*		213.2	24.90	*		194.8	20.21			176.8	24.99			210.8	21.62	*	
	3	209.6	24.90		198.2	21.78			150.5	25.19	*		193.7	27.01	*		238.3	24.90	*		200.0	20.21			198.2	24.99			227.7	21.62	*	
	4	167.7	27.27		212.2	23.86			192.6	27.59			193.4	29.59	*		213.4	27.27	*		176.0	22.14			206.6	27.37			238.6	23.69	*	
	5	199.8	27.27		209.8	23.86	*		218.8	27.59	*		243.0	29.59	*		181.6	27.27	*		193.0	22.14			181.4	27.37			217.6	23.69	*	
MPV (6.2-10.0 f)	1	10.7	0.31		10.3	0.36			10.3	0.32			10.3	0.29	*		10.1	0.29	*		10.0	0.25	*		10.0	0.22	*		10.1			

Mean body weight and body weight changes (kg) among dogs receiving *dl*- α -lipoic acid in the diet for 1 year

Group	Animal Number	Day 0	Week 1		Weeks 2-3		Weeks 4-7		Weeks 8-11		Weeks 12-15		Weeks 16-19		Weeks 20-23	
		Weight	Weight	Change	p ¹	Mean	Change	p ¹	Mean	Change	p ¹	Mean	Change	p ¹	Mean	Change
1	24637	12.4	12.4	0.0	12.5	0.1	12.3	-0.2	12.4	0.1	12.1	-0.3	12.1	0.1	12.0	-0.2
	25028	15.6	15.6	0.0	15.9	0.4	16.9	1.0 *	17.9	1.0 *	18.6	0.7 *	18.9	0.4 *	19.6	0.7 *
	25898	16.9	16.8	-0.1	17.0	0.3	17.8	0.8	18.3	0.5	18.4	0.1	18.7	0.3	18.9	0.2
	30329	18.0	18.2	0.1	18.4	0.2	19.0	0.6	19.5	0.5	19.8	0.3 *	20.4	0.7 *	20.9	0.5 *
	31927	15.4	15.6	0.2	15.6	0.0	16.5	0.9	16.6	0.0	16.8	0.2	17.3	0.6	17.5	0.2 *
	31977	11.4	11.7	0.4	11.6	-0.1	11.6	0.1	11.7	0.0	11.6	-0.1	12.0	0.4	11.9	-0.1
2	18661	15.8	16.3	0.6	16.4	0.1 *	16.3	-0.1	16.3	0.0	15.8	-0.5	15.9	0.1	16.9	1.0
	26051	13.8	12.4	-1.4	14.5	2.1	15.1	0.6	14.7	-0.3	14.9	0.2	14.9	0.0	15.8	0.9
	31258	13.8	13.7	-0.1	13.8	0.1	14.2	0.4	14.5	0.4	14.6	0.0	14.4	-0.1	15.4	0.9
	31662	19.9	20.5	0.6	19.8	-0.6	19.5	-0.3	20.0	0.5	20.8	0.7	20.9	0.1	21.3	0.4
	31921	16.3	16.2	-0.2	15.8	-0.3	16.8	0.9	17.9	1.1	18.0	0.2	17.7	-0.3	18.1	0.3
	32011	12.7	10.9	-1.9 *	12.9	2.0	13.4	0.5	13.9	0.5	14.1	0.3	13.6	-0.5	14.4	0.8
3	17087	15.9	16.2	0.3	16.4	0.2	17.0	0.7	16.4	-0.7	16.3	-0.1	16.9	0.5	17.5	0.6
	17092	14.6	15.3	0.7	15.3	0.0 *	15.9	0.6 *	16.2	0.4	16.4	0.2 *	17.1	0.7 *	17.3	0.2 *
	17266	16.8	17.0	0.3	16.9	-0.1	17.3	0.4	17.7	0.4	17.9	0.2	18.0	0.1	18.9	0.9 *
	25321	11.6	12.2	0.6	12.0	-0.2	12.3	0.3	13.2	0.9 *	13.5	0.3 *	13.7	0.2	14.0	0.3 *
	29674	18.9	19.1	0.3	19.3	0.2 *	20.2	0.9 *	20.6	0.4 *	20.6	0.0 *	21.1	0.5	21.5	0.4 *
	31720	13.9	14.0	0.1	13.8	-0.2	13.7	-0.1	14.7	1.0	15.2	0.4	15.9	0.7	16.5	0.6 *
4	17422	15.0	15.8	0.8	15.6	-0.2	15.7	0.1	15.6	-0.1	15.2	-0.4	15.3	0.1	15.4	0.1
	29680	16.3	16.5	0.2	16.7	0.2	17.2	0.4	17.3	0.1	17.1	-0.2	17.2	0.1	17.3	0.1
	29687	17.9	18.3	0.4	18.3	0.0	18.3	0.0	18.5	0.2	18.2	-0.3	18.8	0.5	19.4	0.7
	30899	11.7	12.1	0.4	12.7	0.6 *	12.7	0.0	12.9	0.1	12.9	0.0	12.9	0.0	12.8	-0.1
	31976	11.7	11.8	0.1	11.7	-0.1	12.1	0.4	12.0	-0.1	12.0	0.0	12.0	0.0	12.1	0.1
	31997	13.5	13.5	0.1	13.4	-0.1	13.2	-0.2	13.2	0.0	13.5	0.3	14.4	0.9	14.6	0.2
5	18563	16.3	16.8	0.4	16.2	-0.5	15.7	-0.6	15.3	-0.4	15.1	-0.2	14.4	-0.7	14.7	0.3
	18789	17.1	17.3	0.3	17.1	-0.2	16.0	-1.1 *	15.2	-0.8 *	15.5	0.3	14.9	-0.6	15.9	1.0
	29692	16.1	16.5	0.4	16.3	-0.3	16.4	0.1	16.2	-0.1	16.4	0.2	15.7	-0.7	16.0	0.3
	30901	13.4	13.1	-0.3	12.6	-0.5 *	11.9	-0.7 *	12.0	0.1	12.2	0.2	11.1	-1.1	12.7	1.6
	31669	12.6	12.7	0.1	12.2	-0.4	12.1	-0.1	11.6	-0.6	12.5	1.0	12.6	0.0	13.6	1.0

Group 1 (n=6): Control
 Group 2 (n=6): 150 ppm
 Group 3 (n=6): 1500 ppm
 Group 4 (n=5): 3000 ppm
 Group 5 (n=5): 4500 ppm

p¹: P-value associated with a comparison to negative control
 * Indicates P-value < 0.05

Mean body weight and body weight changes (kg) among dogs receiving *d*- α -lipoic acid in the diet for 1 year (Cont'd)

Group	Animal Number	Day 0 Weight	Weeks 24-27		Weeks 28-31		Weeks 32-35		Weeks 36-39		Weeks 40-43		Weeks 44-47		Week 48-52	
			Mean	Change p ¹	Mean	Change p ¹	Mean	Change p ¹	Mean	Change p ¹	Mean	Change p ¹	Mean	Change p ¹	Mean	Change p ¹
1	24637	12.4	12.2	-0.2	12.6	0.4	12.7	0.1	13.0	0.3	12.9	-0.1	13.2	0.3	13.0	-0.2
	25028	15.6	19.9	4.3 *	19.3	-0.6 *	18.7	-0.6 *	17.8	-0.9 *	16.6	-1.2	15.8	-0.8	16.1	0.3
	25898	16.9	19.0	2.1	19.2	0.2 *	19.0	-0.2 *	18.5	-0.5	17.7	-0.8	17.7	0.0	17.9	0.2
	30329	18.0	20.8	2.8 *	20.6	-0.2 *	20.3	-0.3 *	20.1	-0.2 *	19.5	-0.6 *	19.1	-0.4	18.7	-0.4
	31927	15.4	17.6	2.2 *	17.5	-0.1	17.4	-0.1 *	16.7	-0.7	16.1	-0.6	15.8	-0.3	15.2	-0.6
	31977	11.4	11.8	0.4	10.3	-1.5	10.2	-0.1	10.5	0.3	10.8	0.3	11.8	1.0	12.6	0.8 *
2	18661	15.8	17.5	1.7	17.7	0.2	17.5	-0.2	17.5	0.0 *	17.6	0.1 *	17.6	0.0 *	17.9	0.3 *
	26051	13.8	15.9	2.1	15.7	-0.2	15.3	-0.4	15.1	-0.2	14.8	-0.3	14.4	-0.4	14.3	-0.1
	31258	13.8	15.6	1.8	15.6	0.0	15.6	0.0 *	15.5	-0.1 *	14.8	-0.7	14.7	-0.1	14.8	0.1
	31662	19.9	21.5	1.6	21.7	0.2	21.4	-0.3	21.1	-0.3	20.9	-0.2	20.7	-0.2	21.1	0.4
	31921	16.3	18.7	2.4 *	19.0	0.3 *	18.6	-0.4 *	18.3	-0.3 *	17.9	-0.4 *	17.5	-0.4 *	18.2	0.7 *
	32011	12.7	14.5	1.8	14.5	0.0	14.2	-0.3	13.6	-0.6	13.3	-0.3	13.3	0.0	13.4	0.1
3	17087	15.9	17.8	1.9	17.8	0.0	17.2	-0.6	16.9	-0.3	16.9	0.0	17.0	0.1	17.1	0.1
	17092	14.6	17.4	2.8 *	16.9	-0.5 *	16.3	-0.6	16.1	-0.2	15.4	-0.7	14.3	-1.1	14.6	0.3
	17266	16.8	19.4	2.6 *	18.7	-0.7	18.4	-0.3	17.9	-0.5	17.2	-0.7	17.0	-0.2	17.5	0.5
	25321	11.6	14.0	2.4 *	13.6	-0.4	12.9	-0.7	12.1	-0.8	11.6	-0.5	11.5	-0.1	11.9	0.4
	29674	18.9	21.9	3.0 *	21.1	-0.8 *	20.6	-0.5	20.1	-0.5	19.3	-0.8	19.1	-0.2	19.7	0.5
	31720	13.9	16.6	2.7 *	15.9	-0.7	15.7	-0.2	15.3	-0.4	14.8	-0.5	15.0	0.2	14.8	-0.3
4	17422	15.0	15.5	0.5	15.3	-0.2	15.9	0.6	16.0	0.1	15.3	-0.7	15.4	0.1	15.7	0.3
	29680	16.3	16.5	0.2	17.0	0.5	17.1	0.1	16.7	-0.4	16.4	-0.3	16.6	0.2	16.6	0.0
	29687	17.9	19.4	1.5	19.9	0.5	19.6	-0.3	19.4	-0.2	19.0	-0.4	19.3	0.3 *	20.0	0.7 *
	30899	11.7	13.2	1.5	13.7	0.5	13.8	0.1 *	13.7	-0.1 *	13.4	-0.3 *	13.0	-0.4 *	13.2	0.2 *
	31976	11.7	12.2	0.5	12.7	0.5	12.5	-0.2	12.5	0.0	12.4	-0.1	12.6	0.2	12.4	-0.2
	31997	13.5	15.2	1.7	15.8	0.6	15.7	-0.1	15.5	-0.2						
5	18563	16.3	15.1	-1.2	15.0	-0.1	14.9	-0.1	15.0	0.1	14.9	-0.1 *	15.2	0.3	15.1	-0.1
	18789	17.1	16.4	-0.7	16.4	0.0	16.8	0.4	16.9	0.1	16.3	-0.6	16.8	0.5	16.9	0.1
	29692	16.1	16.8	0.7	16.5	-0.3	16.2	-0.3	16.5	0.3	16.2	-0.3	16.4	0.2	16.1	-0.3
	30901	13.4	12.9	-0.5	12.8	-0.1	13.1	0.3	13.0	-0.1	12.6	-0.4	13.1	0.5	13.7	0.6
	31669	12.6	14.3	1.7	14.4	0.1	14.5	0.1 *	14.9	0.4 *	14.4	-0.5 *	14.8	0.4 *	15.2	0.4 *

Group 1 (n=6): Control
 Group 2 (n=6): 150 ppm
 Group 3 (n=6): 1500 ppm
 Group 4 (n=5): 3000 ppm
 Group 5 (n=5): 4500 ppm

p¹: P-value associated with a comparison to negative control
 * Indicates P-value < 0.05

Serum biochemistry and hematology values of dogs that did not complete a 1-year dietary *dl*- α -lipoic acid study

Death of Dog # 31997 (Female, Group 4: 3000 ppm) attributed to heartworm infection

ELEMENT	Normal Range		11/15/00	11/29/00	12/13/00	1/2/01	1/24/01	2/21/01	3/21/01	4/18/01	5/16/01	6/13/01	7/11/01	8/8/01
CBC HEMATOLOGY														
WBC	6.0	16.0	8.1	9.8	9.2	8.2	7.2	7.5	8.7	8.4	9.5	11.5	9	13.3
RBC	6.15	8.70	6.42	6.37	6.74	6.53	6.62	6.67	5.65	6.27	6.11	5.7	4.89	4.86
HEMOGLOBIN	14.1	20.0	15.4	15.3	16.3	16.3	16.5	16.5	14.5	16.4	16	14.6	14.2	13.2
HEMATOCRIT	43.4	59.3	45.8	46.1	49.5	48.8	49.5	48.4	42.9	47.3	46.3	42.6	37.3	37.8
MCV	63.0	77.1	71.3	72.4	73.4	74.7	74.8	72.5	75.9	75.4	75.8	74.8	76.3	77.8
MCH	21.1	24.8	24	24	24.2	25	24.9	24.7	25.7	26.2	26.1	25.6	29	27.2
MCHC	29.9	35.6	33.6	33.2	32.9	33.4	33.3	34.1	33.8	34.7	34.6	34.3	38.1	34.9
RDW	11.9	14.9	17.6	17.4	18.7	17.7	16.4	16.9	16	15.5	16.8	18.4	21.1	18.6
PLATELET ESTIMATE	164	510	27	86	116	36	64	41	72	57	63	77	43	63
MPV	6.2	10.0	11.5	11.7	11.2	11	10.6	11.5	11.5	11	10.8	11.6	10.8	11.7
CHEM SCREEN														
GLUCOSE	63	107	102	104	101	96	92	91	81	77	78	76	75	64
SERUM UREA NITROGEN	8.7	30.5	14.1	9.5	4.9	8.7	10	9.4	12.1	8.3	8.2	13.1	13.4	10.4
CREATININE	0.68	1.45	0.8	0.8	0.8	0.7	0.8	0.7	0.8	0.7	0.8	0.9	0.8	1
SODIUM	143	168	150	153	155	148	150	152	150	155	149	151	149	155
POTASSIUM	108.0	131.0	4.6	4.1	4.9	4.3	4.6	4.4	4.4	5.2	4.4	4.8	4.6	5.4
CHLORIDE	108	131	118	120	118	113	111	111	112	116	112	114	114	121
CALCIUM	9.4	11.7	11.2	10.4	10.9	11	15.2	10.7	11.5	11.9	11.1	11.1	11.1	11.2
PHOSPHORUS	2.8	6.2	5.86	5.14	5.54	4.19	4.52	4.33	5.01	4.51	4.59	4.64	4.11	4.1
TOTAL PROTEIN	5.7	7.6	6.6	6.1	6.1	6.3	7.1	6.5	6.6	7.4	7.7	7.4	7.9	8
ALBUMIN	2.8	3.9	3.2	3.3	3.5	3.7	3.7	3.6	3.3	3.5	3.3	3.2	3	3.1
GLOBULIN	2.8	3.9	3.4	2.8	2.6	2.6	3.4	2.9	3.3	3.9	4.4	4.2	4.9	4.9
AVG RATIO	0.5	1.2	0.9	1.2	1.3	1.4	1.1	1.2	1	0.9	0.8	0.8	0.6	0.6
ALT	15	90	27	24	25	26	28	46	69	113	120	106	94	88
ALP	18	94	94	52	67	58	69	60	57	66	59	53	45	54
TOTAL BILIRUBIN	0.0	0.2	0.2	0.1	0.1	0.2	0.2	0.2	0.3	0.2	0.1	0.2	0.1	0.2
TRIGLYCERIDES	14	131	31	38	53	52	58	48	59	66	59	46	51	61
CHOLESTEROL	106	368	213	208	203	218	212	190	207	195	167	162	198	164
MAGNESIUM	1.3	2.0	1.7	1.6	1.8	1.7	1.7	1.6	1.6	1.7	1.5	1.5	1.5	1.7
Body Weights			11.5	13.45	13.35	13.1	13.2	13.35	12.05	11.75	12.05	10.5	9.95	10.45

Serum biochemistry and hematology values of dogs that did not complete a 1-year dietary dl- α -lipoic acid study (Cont'd)

Dog # 31153 (Female, Group 5: 4500 ppm) removed from study due to weight loss and leukocytosis

ELEMENT	Normal Range		11/15/00	11/29/00	12/13/00	1/3/01	4/3/01
CBC HEMATOLOGY							
WBC	6.0	16.0		10.8	14.4	27.8	18
RBC	6.15	8.70		8.11	8.12	5.55	8.69
HEMOGLOBIN	14.1	20.0		16.7	16.8	12.6	18.3
HEMATOCRIT	43.4	59.3		52.4	53.4	37.1	56
MCV	63.0	77.1		84.8	65.8	68.9	64.4
MCH	21.1	24.8		20.6	20.4	22.7	21.1
MCHC	29.9	35.6		31.9	31.1	34	32.7
RDW	11.9	14.9		19.3	22	23.4	19.3
PLATELET ESTIMATE	164	510		96	89	273	105
MPV	6.2	10.0		11.6	12.2	11.4	11.7
CHEM SCREEN							
GLUCOSE	63	107	71	99	104	122	65
SERUM UREA NITROGEN	8.7	30.5	8.4	13	8.5	25.4	9.7
CREATININE	0.68	1.45	0.5	0.7	0.5	0.6	0.7
SODIUM	143	168	147	154	158	156	150
POTASSIUM	108.0	131.0	4.3	4.8	4.3	4.4	4.9
CHLORIDE	108	131	111	122	117	120	110
CALCIUM	9.4	11.7	10.4	9.7	11	9.3	10.5
PHOSPHORUS	2.8	6.2	3.6	3.94	6.1	4.82	4.45
TOTAL PROTEIN	5.7	7.6	6.8	6.9	6.6	6.4	7.1
ALBUMIN	2.8	3.9	3.3	3.5	3.7	3	3.4
GLOBULIN	2.8	3.9	3.5	3.4	3.1	3.4	3.7
AVG RATIO	0.5	1.2	0.9	1	1.2	0.9	0.9
ALT	15	90	42	53	51	41	39
ALP	18	94	22	6	22	69	24
TOTAL BILIRUBIN	0.0	0.2	0.2	0.4	0.1	0.2	0.1
TRIGLYCERIDES	14	131	29	34	36	86	41
CHOLESTEROL	106	368	158	169	197	204	154
MAGNESIUM	1.3	2.0	1.7	1.9	2	1.8	1.7

Body Weights

15-Nov	28-Nov	13-Dec	17-Jan	24-Jan	31-Jan	7-Feb	14-Feb	28-Feb	7-Mar	14-Mar
11.25	10.05	9.7	11.5	11.8	11.95	11.7	11.7	12.45	12.75	12.85
21-Mar	28-Mar	4-Apr	11-Apr	18-Apr	25-Apr	2-May	9-May	16-May	23-May	30-May
12.45	12.2	12.45	12.8	12.75	12.85	12.15	13.65	13.15	12.8	12.95
6-Jun	13-Jun	20-Jun	27-Jun	4-Jul	11-Jul	18-Jul	25-Jul	1-Aug	8-Aug	15-Aug
12.8	13.2	12.8	12.75	13	13.25	13.2	12.95	12.5	12.5	12.95
22-Aug	29-Aug	5-Sep	12-Sep	19-Sep	3-Oct	10-Oct	17-Oct	24-Oct	31-Oct	7-Nov
12.9	12.4	13.15	12.6	12.85	12.3	11.85	12.2	12.25	12.05	12.35
14-Nov	21-Nov	28-Nov								
12.5	12.4	12.7								

SUBMISSION

CONTINUED

IN

NEXT

VOLUME

SUBMISSION

CONTINUED

FROM

PREVIOUS

VOLUME

Pages 160-1266 have been removed in accordance with copyright laws. Please see pages 110-116 for the list of references that have been removed.