

SYSTEM USER GUIDE



MiniMed™ 780G
with the Guardian™ Sensor (3)

Includes technology developed by [dreaMed](#)
diabetes.ai

MiniMed™ 780G
with the Guardian™ Sensor (3)
System User Guide



Medtronic and Medtronic logo are trademarks of Medtronic. ^{™*} Third-party brands are trademarks of their respective owners. All other brands are trademarks of a Medtronic company. The following list includes trademarks or registered trademarks of a Medtronic entity in the United States or in other countries.

Bolus Wizard[™], CareLink[™], Dual Wave[™], Easy Bolus[™], Enlite[™], Guardian Connect[™], Guardian[™], MiniMed[™], Mio[™], Quick-set[™], Silhouette[™], SmartGuard[™], Square Wave[™], Sure-T[™]

Contacts:**Africa:**

Medtronic South Africa and Southern Africa
Office Reception Tel: +27(0) 11 260 9300
Diabetes: 24/7 Helpline: 0800 633 7867
Sub-Sahara 24/7 Helpline: +27(0) 11 260 9490

Albania:

Net Electronics Albania
Tel: +355 697070121

Argentina:

Corpomedica S.A.
Tel: +(11) 4 814 1333
Medtronic Directo 24/7:
+0800 333 0752

Armenia:

Exiol LLC
Tel: +374 98 92 00 11
or +374 94 38 38 52

Australia:

Medtronic Australasia Pty. Ltd.
Tel: 1800 668 670

Bangladesh:

Sonargaon Healthcare Pvt Ltd.
Mobile: (+91)-9903995417
or (+880)-1714217131

Belarus:

Zarga Medica
Tel: +37517 336 97 00
+37529 613 08 08
+37517 215 02 89
Helpline: +74995830400

België/Belgique:

N.V. Medtronic Belgium S.A.
Tel: 0800-90805

Bosnia and Herzegovina:

"Novopharm" d.o.o. Sarajevo
Tel: +387 33 476 444
Helpline: 0800 222 33
Epsilon Research Intern. d.o.o.
Tel: +387 51 251 037
Helpline: 0800 222 33

Brasil:

Medtronic Comercial Ltda.
Tel: +(11) 2182-9200
Medtronic Directo 24/7:
+0800 773 9200

Bulgaria:

RSR EOOD
Tel: +359 888993083
Helpline: +359 884504344

Canada:

Medtronic Canada ULC
Tel: 1-800-284-4416 (toll free/sans-frais)

Česká republika:

Medtronic Czechia s.r.o.
Tel: +420 233 059 111
Non-stop helpLine (24/7):
+420 233 059 059
Zákaznický servis (8:00 - 17:00):
+420 233 059 950

Chile:

Medtronic Chile
Tel: +(9) 66 29 7126
Medtronic Directo 24/7:
+1 230 020 9750
Medtronic Directo 24/7 (From Santiago): +(2) 595 2942

China:

Medtronic (Shanghai) Management Co., Ltd.
Landline: +86 800-820-1981
Mobile Phone: +86 400-820-1981
Calling from outside China: +86 400-820-1981

Colombia:

Medtronic Latin America Inc. Sucursal Colombia
Tel: +(1) 742 7300
Medtronic Directo 24/7 (Landline):
+01 800 710 2170
Medtronic Directo 24/7 (Cellular):
+1 381 4902

Croatia:

Mediligo d.o.o.
Tel: +385 1 6454 295
Helpline: +385 1 4881144
Medtronic Adriatic d.o.o.
Helpline: +385 1 4881120

Danmark:

Medtronic Danmark A/S
Tel: +45 32 48 18 00

Deutschland:

Medtronic GmbH
Geschäftsbereich Diabetes
Telefon: +49 2159 8149-370
Telefax: +49 2159 8149-110
24-Stdn-Hotline: 0800 6464633

Eire:

Accu-Science LTD.
Tel: +353 45 433000

España:

Medtronic Ibérica S.A.
Tel: +34 91 625 05 42
Fax: +34 91 625 03 90
24 horas: +34 900 120 330

Estonia:

AB Medical Group Estonia Ltd
Tel: +372 6552310
Helpline: +372 5140694

Europe:

Medtronic Europe S.A. Europe, Middle East and Africa HQ
Tel: +41 (0) 21-802-7000

France:

Medtronic France S.A.S.
Tel: +33 (0) 1 55 38 17 00

Hellas:

Medtronic Hellas S.A.
Tel: +30 210677-9099

Hong Kong:

Medtronic Hong Kong Medical Ltd.
Tel: +852 2919-1300
To order supplies: +852 2919-1322
24-hour helpline: +852 2919-6441

India:

India Medtronic Pvt. Ltd.
Tel: (+91)-80-22112245 / 32972359
Mobile: (+91)-9611633007
Patient Care Helpline:
1800 209 6777

Indonesia:

Medtronic International Ltd.
Tel: +65 6436 5090
or +65 6436 5000

Israel:

Medtronic Trading Ltd.
Tel.: +972-9-9724400
Tel. (product support –
8:00-17:00): +972-9-9724489
Helpline (weekends & holidays):
1-800-611-888

Italia:

Medtronic Italia S.p.A.
Tel: +39 02 24137 261
Fax: +39 02 24138 210
Servizio assistenza tecnica:
N° verde: 800 60 11 22

Japan:

Medtronic Japan Co. Ltd.
24 Hr. Support Line: 0120-56-32-56
日本：日本メドトロニック株式会
社
24時間サポートライン：
0120-56-32-56

Kazakhstan:

TOO "Медтроник Казахстан"
Tel: +7 727 321 13 30 (Almaty)
Круглосуточная линия поддержки:
8 800 080 5001

Kosovo:

Yess Pharma
Tel: +377 44 999 900
Helpline: +37745888388

Latin America:

Medtronic, Inc.
Tel: 1(305) 500-9328
Fax: 1(786) 709-4244

Latvija:

RAL SIA
Tel: +371 67316372
Helpline (9am to 6pm):
+371 29611419

Lithuania:

Monameda UAB
Tel: +370 68405322
Helpline: +370 68494254

Macedonia:

Alkaloid Kons Dooel
Tel: +389 23204438

Magyarország:

Medtronic Hungária Kft.
Tel: +36 1 889 0688

Malaysia:

Medtronic International Ltd.
Tel: +603 7946 9000

México:

Medtronic Servicios S. de R. L. de C.V.
Tel (México DF): +(11) 029 058
Tel (Interior): +01 800 000 7867
Medtronic Directo 24/7 (from México
DF):
+(55) 36 869 787
Medtronic Directo 24/7:
+01 800 681 1845

Middle East and North Africa:

Regional Office
Tel: +961-1-370 670

Montenegro:

Glosarij d.o.o.
Tel: +382 20642495

Nederland, Luxembourg:

Medtronic B.V.
Tel: +31 (0) 45-566-8291
Gratis: 0800-3422338

New Zealand:

Medica Pacifica
Phone: 64 9 414 0318
Free Phone: 0800 106 100

Norge:

Medtronic Norge A/S
Tel: +47 67 10 32 00
Fax: +47 67 10 32 10

Österreich:

Medtronic Österreich GmbH
Tel: +43 (0) 1 240 44-0
24 – Stunden – Hotline: 0820 820 190

Philippines:

Medtronic International Ltd.
Tel: +65 6436 5090
or +65 6436 5000

Россия

ООО «Медтроник»
Tel: +7 495 580 73 77
Круглосуточная линия поддержки
8 800 200 76 36

Polska:

Medtronic Poland Sp. z o.o.
Tel: +48 22 465 6934

Portugal:

Medtronic Portugal Lda
Tel: +351 21 7245100
Fax: +351 21 7245199

Puerto Rico:

Medtronic Puerto Rico
Tel: 787-753-5270

Republic of Korea:

Medtronic Korea, Co., Ltd.
Tel: +82.2.3404.3600

Romania:

Medtronic Romania S.R.L
Regional Office
Tel: +40372188017
Helpline: +40 726677171

Schweiz:

Medtronic (Schweiz) AG
Tel: +41 (0)31 868 0160
24-Stunden-Hotline: 0800 633333
Fax Allgemein: +41 (0)318680199

Serbia:

Epsilon Research International d.o.o.
Tel: +381 113115554
Medtronic Serbia D.o.o.
Helpline: +381 112095900

Singapore:

Medtronic International Ltd.
Tel: +65 6436 5090
or +65 6436 5000

Slovenija:

Zaloker & Zaloker d.o.o.
Tel: +386 1 542 51 11
24-urna tehnična pomoč:
+386 51316560

Slovenská republika:

Medtronic Slovakia, s.r.o.
Tel: +421 26820 6942
HelpLine: +421 26820 6986

Sri Lanka:

Swiss Biogenics Ltd.
Mobile: (+91)-9003077499
or (+94)-777256760

Suomi:

Medtronic Finland Oy
Tel: +358 20 7281 200
Help line: +358 800 164 064

Sverige:

Medtronic AB
Tel: +46 8 568 585 20
Fax: +46 8 568 585 11

Taiwan:

Medtronic (Taiwan) Ltd.
Tel: 02-21836000
Toll free: +886-800-005285

Thailand:

Medtronic (Thailand) Ltd.
Tel: +662 232 7400

Türkiye:

Medtronic Medikal Teknoloji
Ticaret Ltd. Sirketi.
Tel: +90 216 4694330

USA:

Medtronic Diabetes Global
Headquarters
24-Hour Technical
Support: +1-800-646-4633
To order supplies: +1-800-843-6687

Ukraine:

ТОВ «Медтронік Україна»
Лінія цілодобової підтримки:
Тел.: 0 800 508 300











United Kingdom:









Medtronic Ltd.
Tel: +44 1923-205167

Vietnam:

Medtronic Vietnam
Tel: +84 283 926 2000

Icon table

	Bluetooth® wireless technology or Bluetooth® enabled
	Consult instructions for use
	Manufacturer
	Date of manufacture
	Do not resterilize
	Do not reuse
	Do not use if package is damaged
FCC ID	Complies with United States regulations for radio frequency devices
	Fragile, handle with care
IPX8	Protected against the effects of continuous immersion in water.
	Keep dry
LOT	Batch code
MD	Medical device
	Magnetic Resonance (MR) Unsafe

	Non-pyrogenic
(1x)	One per container/package
	Open here
	Recyclable, contains recycled content
REF	Catalogue number
RF	Identification number for global radio frequency certification
R _x Only	Requires prescription in the USA
	Single patient, multi-use
	Single sterile barrier system
SN	Serial number
STERILE R	Sterilized using irradiation
	Storage humidity limits
	Storage temperature limits
	Type BF applied part
	Use-by date

	Do not dispose of this product in unsorted municipal waste stream
---	---

WARNING: Do not use the SmartGuard feature for people who require less than eight units or more than 250 units of total daily insulin per day. A total daily dose of at least eight units, but no more than 250 units, is required to use the SmartGuard feature.

Contents

■ Safety and indications

- 29 Important system information
- 30 Using this guide
- 30 Conventions
- 31 Emergency kit
- 32 User safety
- 32 Intended use
- 35 Contraindications
- 36 Intended target population
- 36 Risks and side effects
- 40 General warnings
- 40 Pump
- 44 Reservoir and infusion sets
- 46 Sensor and serter
- 49 Transmitter
- 49 Meter
- 52 Exposure to magnetic fields and radiation
- 53 General precautions
- 53 Waterproof capabilities
- 54 Electrostatic discharge
- 54 Extreme temperatures

54	Skin care products
55	Infusion sets and sites, sensor, transmitter, and meter
55	Adverse reactions
55	Security precautions
56	Insulin guidelines
57	Consumables
58	Other MiniMed 780G system devices
59	Accessories

■ System overview

63	What are the components of the MiniMed 780G system?
64	Modes
65	Manual mode without CGM
65	Manual mode with CGM
66	SmartGuard

■ Pump basics

70	Using the buttons
70	Sleep mode
71	Pump delivery system
71	Infusion set
72	Reservoir
72	Pump
72	Inserting the battery
74	Startup settings
76	Home screen in Manual mode
77	Shortcuts from the Home screen
78	Status icons
81	Menu screen
82	Menu map
82	Sound & Vibration screen

83 Status screen

■ Setting up insulin delivery

- 87 Setting up basal insulin
- 87 Basal rate
- 88 Max basal rate
- 89 Basal patterns
- 95 Suspending all insulin delivery and resuming basal insulin delivery
- 98 Temp basal rates
- 100 Entering a blood glucose (BG) meter reading
- 101 Setting up bolus delivery
- 101 About bolus deliveries
- 101 Bolus delivery options
- 102 Max bolus
- 103 Bolus Wizard feature
- 109 Normal bolus
- 112 Stopping a bolus delivery

■ Reservoir and infusion set

- 118 Setting up the reservoir and infusion set
- 118 Removing the reservoir and rewinding the pump
- 122 Filling the reservoir and connecting it to the infusion set tubing
- 126 Placing the reservoir into the pump and filling the tubing with insulin
- 129 Inserting the infusion set into the body
- 130 Filling the cannula
- 133 Disconnecting the infusion set
- 133 Reconnecting the infusion set

■ Paired devices

- 137 Setting up the Accu-Chek™* Guide Link meter
- 137 Pairing the pump and meter

139	Pairing the pump and transmitter
142	MiniMed Mobile app
142	Uploading device data to CareLink software
142	Sharing device data with the CareLink Connect app
143	Medtronic Diabetes Updater app
143	Downloading the pump software update
143	Preparing to install the pump software update
144	Installing the pump software update
146	Completing the pump software update

■ **Continuous glucose monitoring with Guardian sensor (3)**

149	CGM overview
150	What is blood glucose (BG) and sensor glucose (SG)?
151	Calibrating the sensor
152	Home screen with CGM in Manual mode
153	SG alert settings
153	High SG settings
154	Low SG settings
161	Setting up CGM
162	Turning the Sensor feature on or off
162	Setting up the High SG settings
165	Setting up the low SG settings
168	Manually resuming basal insulin delivery during a Suspend before low or Suspend on low event
169	Inserting the sensor
169	Connecting the transmitter to the sensor
170	Starting the sensor
171	Calibrating the sensor
172	Reconnecting the sensor
173	Using CGM
173	The sensor graph when using CGM

175 Silencing sensor alerts

■ SmartGuard

- 181 Introduction
- 183 Auto Basal
- 183 Auto Correction
- 183 Giving a bolus when the SmartGuard feature is active
- 183 Preparing to set up the SmartGuard feature
- 185 Setting up the SmartGuard feature
- 186 Conditions to activate the SmartGuard feature
- 186 Suspending manually while using the SmartGuard feature
- 186 Suspend before low and Suspend on low features while using the SmartGuard feature
- 187 SmartGuard Checklist
- 189 Home screen with the SmartGuard feature
- 190 Using the SmartGuard feature
- 190 The sensor graph with the SmartGuard feature
- 191 Entering a BG value in the SmartGuard feature
- 193 Delivering a bolus in the SmartGuard feature
- 199 Setting a temp target
- 200 Staying in the SmartGuard feature
- 202 Exiting the SmartGuard feature
- 202 Returning to the SmartGuard feature after an exit
- 203 Using Block mode with the SmartGuard feature
- 203 Alert silence feature

■ General settings

- 207 Time and date
- 207 Display options
- 208 Block mode
- 210 Self Test

211	Manage Settings
211	Saving the settings
212	Restoring the settings
212	Clearing the settings
213	Clearing the active insulin
214	Viewing the pump setting history
214	Auto suspend
215	Language

■ History and graph

219	Introduction
219	History & Graph menu
219	History
219	Summary screen
220	Understanding the Summary screen
223	Daily History screen
224	Alarm History screen
224	Paired Sensors screen
225	SG Review screen
226	Graph screen
227	Time in Range screen

■ Notifications and reminders

231	Notifications in the MiniMed Mobile app
231	Reminders
232	Personal reminders
233	Bolus BG Check reminder
233	Missed Meal Bolus reminder
234	Low Reservoir reminder
235	Set Change reminder
236	Calibration reminder

- 236 Alarms, alerts, and messages
- 237 Alarms
- 238 Alerts
- 239 Messages
- 240 Pump alarms, alerts, and messages

■ Additional basal features

- 243 Preset temp basal rates
- 245 Starting a preset temp basal delivery
- 246 Canceling a temp basal or preset temp basal
- 246 Additional basal patterns
- 246 Adding an additional basal pattern
- 247 Editing, copying, or deleting a basal pattern
- 248 Changing from one basal pattern to another

■ Additional bolus features

- 253 Bolus types
- 254 Bolus type example
- 254 Bolus settings
- 254 Bolus increment
- 255 Bolus speed
- 256 Changing the Bolus Wizard settings
- 256 Changing the carb ratio
- 256 Changing the insulin sensitivity factor
- 257 Changing the BG target
- 258 Changing the active insulin time
- 259 Square Wave bolus
- 259 Turning the Square Wave bolus feature on or off
- 260 Delivering a Square Wave bolus using the Bolus Wizard feature
- 261 Delivering a Square Wave bolus using the Manual bolus feature
- 263 Dual Wave bolus

- 263 Turning the Dual Wave bolus feature on or off
- 263 Delivering a Dual Wave bolus using the Bolus Wizard feature
- 265 Delivering a Dual Wave bolus using the Manual bolus feature
- 267 Easy bolus
- 267 Setting up the Easy bolus feature
- 269 Delivering a bolus using the Easy bolus feature
- 270 Preset bolus
- 270 Setting up and managing preset bolus deliveries
- 273 Delivering a preset bolus
- 274 Stopping a Square Wave or Dual Wave bolus delivery

■ Troubleshooting

- 280 Pump issues
- 283 Sensor issues

■ Maintenance

- 289 Pump maintenance
- 289 Cleaning the pump
- 290 Storing the pump
- 292 Pump disposal
- 292 Meter maintenance
- 292 Unpairing a meter from the pump
- 294 Deleting the pump from a meter
- 294 Transmitter and sensor maintenance
- 294 Unpairing the transmitter from the pump
- 295 Disconnecting the transmitter from the sensor
- 295 Removing the sensor
- 295 Cleaning the transmitter
- 295 Storing the transmitter
- 295 Removing the battery

■ **Appendix A: List of alarms, alerts, and messages**

- 299 Pump alarms, alerts, and messages
- 311 CGM (sensor) alarms, alerts, and messages
- 319 SmartGuard feature alerts and messages
- 322 CareLink software alert and message

■ **Appendix B: Product specifications**

- 325 Specifications and default settings
- 325 Alarm and alert escalation
- 326 Altitude range
- 326 Backlight
- 326 Basal delivery
- 327 BG meter reading
- 327 Bolus delivery
- 328 Bolus Wizard feature default settings
- 328 Bolus Wizard feature specifications
- 331 Carb ratios
- 331 Delivery accuracy
- 333 Easy bolus feature
- 333 Environmental conditions
- 333 Essential performance
- 334 Expected service life
- 334 Filling the infusion set and cannula
- 334 Infusion pressure
- 334 Insulin delivery default settings
- 336 Low Reservoir reminder
- 336 Max bolus
- 336 Normal bolus
- 336 Occlusion detection
- 337 Percent temp basal

337	Program safety checks
337	Pump dimensions
337	Pump memory
337	Pump weight
338	Sensor default settings
339	Sound frequency
340	IEC 60601-1
340	IEC 60601-1-2, Special EMC Precautions for Medical Electrical Equipment
341	IEC 60601-1
341	IEC 60601-1-10: PCLCS
342	Guidance and manufacturer's declaration
345	Wireless communication
345	FCC notice
347	Open Source Software disclosure

■ Appendix C: Menu map

351	Menu map
-----	----------

■ Appendix D: Performance data

357	A. Device performance for users seven years and older
358	The SmartGuard feature
366	The Suspend before low feature
368	B. Guardian Sensor (3) Performance for 14 years old and older
368	CGM performance
368	Clinical study description
370	Results
385	C. Alert performance for users 14 years and older
386	Glucose TRUE Alert Rate
387	Glucose FALSE Alert Rate
389	Glucose Correct Detection Rate
390	Glucose Missed Detection Rate

391	E. Guardian Sensor (3) Performance in users ages 7 to 13
391	CGM performance
391	Clinical study description
392	Results
406	F. Alert performance for user ages 7 through 13
407	Glucose TRUE Alert Rate
409	Glucose FALSE Alert Rate
410	Glucose Correct Detection Rate
411	Glucose Missed Detection Rate

■ **Glossary**

■ **Index**

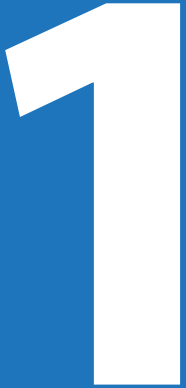

Safety and Indications

1

Safety and indications

This user guide describes the operation of the MiniMed 780G system with smart device connectivity and SmartGuard technology. SmartGuard technology adjusts insulin delivery based on sensor glucose (SG) values. The MiniMed 780G insulin pump operates in Manual mode when the SmartGuard feature is not active.

Consult a healthcare professional before starting insulin pump therapy.

Important system information

Only use rapid-acting U-100 Humalog™* or U-100 NovoLog™** insulin with the MiniMed 780G system. For more information see *Insulin guidelines, page 56*.

The MiniMed 780G system uses the Guardian Sensor (3) and Guardian Link (3) transmitter for continuous glucose monitoring. For more information see *Continuous glucose monitoring with Guardian sensor (3), page 149*.

A BG meter reading is required to calibrate the Guardian Sensor (3) and for optimal sensor performance. For more information see *Calibrating the sensor, page 171*.

The Guardian Sensor (3) is indicated for abdomen and buttock insertion for user ages 7-13, and abdomen and arm insertion for user ages 14 and older. For more information see *Inserting the sensor, page 169*.



Note: Do not use the Guardian Sensor (3) in other body sites due to unknown or different performance that could result in hypoglycemia or hyperglycemia.





Only use MiniMed or Medtronic reservoirs and infusion sets that are specifically designed for use with the MiniMed 780G system. For more information on compatible reservoirs and infusion sets see *Consumables, page 57*.

Using this guide

Use the table of contents at the beginning of the user guide and the index at the end of the user guide to locate specific information.

Refer to the glossary for definitions of terms and acronyms used.

Conventions

Convention	Definition
Select	Press  to activate a screen item, accept a value, or initiate an action.
Select and hold	Press and hold  to perform an action.
Press	Press and release a button.
Press and hold	Press and hold a button.
Bold text	Indicates screen items and buttons, such as “Select Next to continue.”
X	Indicates a value that might appear differently on the pump screen.
Note	Note: A note provides helpful information.
Caution	 CAUTION: A caution informs of a potential hazard which, if not avoided, might result in minor or moderate injury, or damage to the equipment.
WARNING	 WARNING: A warning informs of a potential safety hazard which, if not avoided, may result in serious injury or death. It may also describe potential serious adverse reactions.

For instructions about setting up devices on the MiniMed 780G system, such as a sensor or infusion set, refer to the user guide for the related device.

Emergency kit

Keep an emergency kit available at all times to confirm that necessary supplies are ready. Tell a family member or friend where to find the emergency kit.

When traveling, test blood glucose (BG) more frequently to accommodate for changes in activity levels and meal times.

Include the following items in the emergency kit:

- Rapid-acting glucose tablets
- BG monitoring supplies
- Urine or blood ketone monitoring supplies
- Extra infusion set and reservoir
- Extra new AA lithium or alkaline batteries, or fully charged NiMH batteries
- Insulin syringe and rapid-acting U-100 insulin (with dosage instructions from a healthcare professional)
- Adhesive dressing
- Glucagon



WARNING: Do not use the Bolus Wizard feature to calculate a bolus for a period of time after giving a manual injection of insulin by syringe or pen. Manual injections are not accounted for in the active insulin amount. Using the Bolus Wizard feature too soon after a manual injection may result in over-delivery of insulin and may cause hypoglycemia. Consult a healthcare professional for how long to wait after a manual injection before using the Bolus Wizard feature.



WARNING: Do not use the SmartGuard feature for a period of time after giving a manual injection of insulin by syringe or pen. Manual injections are not accounted for in the active insulin amount. Using the SmartGuard feature too soon after a manual injection may result in over-delivery of insulin and may cause hypoglycemia. Consult a healthcare professional for how long to wait after a manual injection before using the SmartGuard feature.

User safety



WARNING: Do not use the MiniMed 780G system until appropriate training has been received from a healthcare professional. Training is essential to ensure the safe use of the MiniMed 780G system.

Intended use

MiniMed 780G system

The MiniMed 780G system is intended for continuous delivery of basal insulin at selectable rates, and the administration of insulin boluses at selectable amounts for the management of type 1 diabetes mellitus in persons seven years of age and older requiring insulin. The system is also intended to continuously monitor glucose values in the fluid under the skin. The MiniMed 780G system includes SmartGuard technology, which can be programmed to automatically adjust insulin delivery based on continuous glucose monitoring (CGM) sensor glucose values and can suspend delivery of insulin when the SG value falls below or is predicted to fall below predefined threshold values.

This MiniMed 780G system consists of the following devices:

- MiniMed 780G insulin pump
- Guardian Link (3) transmitter
- Guardian Sensor (3)
- One-press server

- Accu-Chek™* Guide Link blood glucose meter
- Accu-Chek™* Guide Test Strips

The system requires a prescription from a healthcare professional.



WARNING: The MiniMed 780G system has not been studied in persons under age seven and its safety in these persons is unknown.



WARNING: Do not use the Suspend before low or Suspend on low features to prevent or treat low glucose. Always follow the instructions of a healthcare professional to treat low glucose. Using Suspend before low or Suspend on low features to prevent or treat low BG may result in prolonged hypoglycemia.

Guardian Sensor (3)

The Guardian Sensor (3) is intended for use with the MiniMed 780G system, MiniMed 770G system, MiniMed 670G system, MiniMed 630G system, and Guardian Connect system to continuously monitor glucose levels in persons with diabetes.

The sensor is intended for single use and requires a prescription. The Guardian Sensor (3) is indicated for seven days of continuous use.

The Guardian Sensor (3) is not intended to be used directly to make therapy adjustments while the MiniMed 780G system is operating in manual mode. All therapy adjustments in manual mode should be based on measurements obtained using a blood glucose meter and not on values provided by the Guardian Sensor (3).

The Guardian Sensor (3) has been studied and is approved for use in the systems, insertion sites, and ages listed in the following table:

System	Approved Age	Sensor Insertion Site
MiniMed 780G system	7-13	Abdomen and Buttocks
	14 and older	Abdomen and Arm
MiniMed 770G system	2-13	Abdomen and Buttocks
	14 and older	Abdomen and Arm

System	Approved Age	Sensor Insertion Site
MiniMed 670G system	7-13	Abdomen and Buttocks
	14 and older	Abdomen and Arm
MiniMed 630G system	14 and older	Abdomen and Arm
Guardian Connect system	14 and older	Abdomen and Arm

One-pressserter

Theserter is used as an aid for inserting the sensor. It is indicated for single-patient use and is not intended for multiple patient use.

Guardian Link (3) transmitter

The Guardian Link (3) transmitter is intended for use with the MiniMed 780G system. The Guardian Link (3) transmitter powers the glucose sensor, collects and calculates sensor data, and wirelessly sends the data to the MiniMed 780G insulin pump. The transmitter is intended for single-patient multi-use.

Accu-Chek™* Guide Link Blood Glucose Monitoring System

The Accu-Chek™* Guide Link Blood Glucose Monitoring System is comprised of the Accu-Chek™* Guide Link meter and the Accu-Chek™* Guide test strips.

The Accu-Chek™* Guide Link Blood Glucose Monitoring System is intended to quantitatively measure glucose in fresh capillary whole blood from the fingertip, palm, and upper arm as an aid in monitoring the effectiveness of glucose control.

The Accu-Chek™* Guide Link Blood Glucose Monitoring System is intended for in vitro diagnostic single-patient use by people with diabetes.

The Accu-Chek™* Guide Link Blood Glucose Monitoring System is intended to be used by a single person and should not be shared.

This system is not for use in diagnosing or screening for diabetes mellitus and not for neonatal use.

Alternative site testing should be done only during steady-state times (when glucose is not changing rapidly).

The Accu-Chek™ Guide Link Blood Glucose Monitoring System is intended to be used to wirelessly transmit glucose values to the MiniMed 780G system and MiniMed 770G system with Bluetooth™ wireless technology through the use of Bluetooth™ low energy communication.

**WARNINGS:**

- Do not use Alternative Site Testing to calibrate a continuous glucose monitoring system.
- Do not use Alternative Site Testing to make insulin dosing calculations.

Contraindications

Pump therapy is not recommended for people whose vision or hearing does not allow for the recognition of pump signals, alerts, or alarms.

Do not use the serter to insert sensors other than the Guardian Sensor (3). Medtronic cannot guarantee the safety or efficacy of this product if used with other sensors.

The reservoir is contraindicated for the infusion of blood or blood products.

Infusion sets are indicated for subcutaneous use only and not for intravenous (IV) infusion.

Infusion sets are not indicated for the infusion of blood or blood products.

Insulin pump therapy is not recommended for persons who are unwilling to perform at least four BG meter readings per day. As insulin pumps use rapid-acting insulin only, BG testing is required to help identify rapid glycemic deterioration due to insulin infusion occlusion, infusion site problems, insulin stability issues, user error, or a combination of these.



WARNING: Do not use the SmartGuard feature for people who require less than eight units or more than 250 units of total daily insulin per day. A total daily dose of at least eight units, but no more than 250 units, is required to use the SmartGuard feature.

Pump therapy is not recommended for people who are unwilling or unable to maintain contact with their healthcare professional.

Intended target population

The intended target population for the MiniMed 780G insulin pump includes children, adolescents, and adults who are responsive to insulin delivered subcutaneously.

Risks and side effects

Risks related to insulin administration and pump use

Risks related to insulin infusion and potential interruptions of insulin delivery include:

- Hypoglycemia
- Hyperglycemia
- Diabetic ketoacidosis
- Seizure
- Coma
- Death

Risks related to insulin pump infusion set

Risks related to insulin pump infusion set use include:

- Localized infection
- Skin irritation or redness
- Bruising
- Discomfort or pain
- Bleeding
- Irritation
- Rash
- Occlusions that may interrupt insulin delivery and lead to hyperglycemia and diabetic ketoacidosis

Follow the instructions in the provided user guides for the insertion and care of infusion sets. If an infusion site becomes irritated or inflamed, dispose of the infusion set in a sharps container, and select a different location to insert a new infusion set.

Risks related to sensor use

Risks related to sensor use include:

- Skin irritation or other reactions
- Bruising
- Discomfort
- Redness
- Bleeding
- Pain
- Rash
- Infection
- Raised bump
- Appearance of a small freckle-like dot where needle was inserted
- Fainting secondary to anxiety or fear of needle insertion
- Allergic reaction
- Soreness or tenderness
- Swelling at insertion site
- Sensor filament fracture, breakage, or damage
- Minimal blood splatter associated with sensor needle removal
- Residual redness associated with adhesive, tape, or both
- Scarring

Specific risks related to sensor use

Do not use continuous glucose monitoring if hydroxyurea, also known as hydroxycarbamide, is taken. Hydroxyurea is used to treat certain diseases, such as cancer and sickle cell anemia. Hydroxyurea use results in higher sensor glucose

readings compared to blood glucose readings. Taking hydroxyurea while using continuous glucose monitoring can result in hypoglycemia caused by over-delivery of insulin, inaccurate or missed alarms and alerts, delay or loss of sensor-enabled insulin suspension, and substantially higher sensor glucose readings in reports than actual blood glucose readings.

Always check the label of any medication being taken to confirm if hydroxyurea or hydroxycarbamide is an active ingredient. If hydroxyurea is taken, consult a healthcare professional. Turn the Sensor feature off to disable continuous glucose monitoring. For more information, see *Turning the Sensor feature on or off*, page 162. Use additional blood glucose meter readings to verify glucose levels.

Consult a healthcare professional if a medication that contains acetaminophen or paracetamol is taken while wearing the sensor. Medications that contain acetaminophen or paracetamol can falsely raise sensor glucose readings. The level of inaccuracy depends on the amount of acetaminophen or paracetamol active in the body and can differ for each person. Falsely elevated sensor readings can result in over-delivery of insulin, which can cause hypoglycemia. Medications that contain acetaminophen or paracetamol include, but are not limited to, cold medicines and fever reducers. Check the label of any medications being taken to see if acetaminophen or paracetamol is an active ingredient. Use additional blood glucose meter readings to confirm blood glucose levels.

While the SmartGuard feature is active, if acetaminophen or paracetamol is taken, program a temp target for up to eight hours, or the amount of time recommended by a healthcare provider. For more information, see *Setting a temp target*, page 199. Use blood glucose values instead of sensor glucose readings to calculate a meal bolus or correction bolus up to eight hours, or the duration recommended by a healthcare provider, after taking acetaminophen or paracetamol.

Do not use SG values to make treatment decisions, including delivering a bolus, while the pump is in Manual mode. When the SmartGuard feature is active and you are no longer in Manual mode, the pump uses an SG value, when available, to calculate a bolus amount. However, if your symptoms do not match the SG value, use a BG meter to confirm the SG value. Failure to confirm glucose levels when your symptoms do not match the SG value can result in the infusion of too much or too little insulin, which may cause hypoglycemia or hyperglycemia. For more information on using CGM, see

Continuous glucose monitoring with Guardian sensor (3), page 149. For more information on using the SmartGuard feature, see *SmartGuard, page 181.*

For persons seven to thirteen years of age, sensor placement and insertion has been studied in the belly (abdomen) and buttocks only and is not approved for other sites.

For persons fourteen years and older, sensor placement and insertion has been studied in the belly (abdomen) and back of upper arm only and is not approved for other sites.

Risks related to meter use

- For the most current warnings, see the User's Manual that came with your device.
- A list of warnings for the meter are provided in the meter section, see *Meter, page 49.*



WARNINGS:

- Do not use Alternative Site Testing to calibrate a continuous glucose monitoring system.
- Do not use Alternative Site Testing to make insulin dosing calculations.

Risks related to serter use

General risks with serter use may include skin infection around the area where the serter is used.

Risks related to the MiniMed 780G system

- Hypoglycemia
- Hyperglycemia
- Diabetic ketoacidosis
- Seizure
- Coma
- Death

Removing the pump for temporary storage

If there is a need or desire to remove the pump, use the following guidelines:

- Write down the current basal rates and use the Save Settings feature. For more information, see *Saving the settings, page 211*.
- Remove the battery. For more information, see *Storing the pump, page 290*.
- If the pump is disconnected for less than one hour, an insulin adjustment may not be required. If the pump is disconnected for more than one hour, consult a healthcare professional to determine an alternate method of insulin delivery.

General warnings

Pump

- Do not use the pump in the presence of anesthetic mixtures that include oxidizing agents such as oxygen or nitrous oxide. Exposure to these conditions may damage the pump and result in serious injury.
- Always use the fingertip for blood samples when entering a BG meter reading into the pump while using the SmartGuard feature. Blood samples from other locations, such as the palm or forearm, have not been studied for use with the SmartGuard feature, and the accuracy of these samples is unknown.
- When the SmartGuard feature is active, SG readings are used to calculate basal insulin delivery and correction boluses. Do not use SG readings to make treatment decisions while the pump is in Manual mode. SG and BG values may differ. Sensor performance may occasionally vary from sensor to sensor and in different situations for a sensor, such as on the first day of use.

A BG meter reading is required in the following situations:

- Before a correction bolus is given in Manual mode.
- The SG reading is lower than expected.
- The SG reading is higher than expected.
- Suspected hypoglycemia or symptoms of hypoglycemia.
- Suspected hyperglycemia or symptoms of hyperglycemia.
- Suspected diabetic ketoacidosis or symptoms of diabetic ketoacidosis.

Do not use SG readings to make treatment decisions while the pump is in Manual mode.

- For MiniMed 780G System Users Ages 7-13:
The low SG alert functionality is distinct from the automated insulin dosing function of the MiniMed 780G system. When using the SmartGuard feature, the MiniMed 780G system has been shown to be safe and effective for its intended use in this population. However, do not rely solely on the use of the Low SG alarm, or the use of “Alert on Low” and “Alert before Low” when those alerts are set at or below 60 mg/dL. At these BG levels, a low SG alarm or alert may not reflect the user’s true BG, and you may not be notified. Do not ignore symptoms of low glucose. Always confirm SG readings with a BG meter, and treat according to the recommendation of a healthcare professional. Solely relying on these SG alerts and readings for treatment decisions could result in missing severe hypoglycemia (low BG) events.
- Do not rely on the pump tones or vibrations to navigate the pump screens or menus. Relying on pump tones or vibrations may result in incorrect menu or setting selection. Always view the pump screen when selecting menus and entering information into the system.
- Only use rapid-acting U-100 insulin (Humalog™* and NovoLog™*) prescribed by a healthcare professional for use with an infusion pump. Use of any other drug or medication in the reservoir can cause serious injury.
- Confirm that the infusion set is disconnected from the body before rewinding the pump or filling the infusion set tubing. Never insert the reservoir into the pump while the tubing is connected to the body. Doing so may result in an accidental infusion of insulin, which may cause hypoglycemia.
- Do not insert the reservoir before rewinding the pump. Doing so may result in an accidental infusion of insulin, and may result in hypoglycemia.
- Do not use the MiniMed 780G insulin pump or additional system devices next to other electrical equipment, which may cause interference. This includes mobile communication devices such as cell phones that are not paired with the MiniMed 780G system, GPS navigation systems, anti-theft systems, radio-frequency identification (RFID) systems, and any electrical equipment that

has an output transmitter power greater than 1 W. The recommended separation distance between the insulin pump and common RF emitters is 12 in (30 cm). For more information about recommended separation distance guidelines between the insulin pump and common RF emitters, see *Guidance and manufacturer's declaration, page 342*. Other electrical equipment that may compromise normal system operation has been contraindicated. For more information, see *Exposure to magnetic fields and radiation, page 52*.

- Do not unscrew or retighten the tubing connector on the reservoir while the infusion set is connected to the body. Doing so may result in an accidental infusion of insulin, and may cause hypoglycemia.
- Do not use standard Luer sets with the MiniMed 780G system. Only use MiniMed or Medtronic reservoirs and infusion sets that are specifically designed for use with the MiniMed 780G system.
- Do not change or modify the MiniMed or Medtronic reservoir and infusion set. Modification of these components may cause serious injury, interfere with device operation, and void the warranty.
- Do not rely on preset pump alarms or reminders alone to check BG levels. Set additional reminders on other devices, such as a cell phone.
- Do not change or modify the internal RF transmitter or antenna. Doing so may interfere with the safe operation of the equipment.
- The MiniMed 780G system is only approved for use with the Guardian Link (3) transmitter with Bluetooth™* wireless technology (MMT-7910NA). The Guardian Link (3) transmitter can be identified by the "GL3" marking on the top of the device. Use of a transmitter not approved for communication with the pump may cause damage to system components and may result in inaccurate SG readings.
- If other devices that employ radio frequencies are in use, such as cell phones that are not paired with the MiniMed 780G system, cordless phones, walkie-talkies, and wireless networks, they may prevent communication between the transmitter and the insulin pump. This interference does not cause any incorrect data to be sent and does not cause any harm to devices. Moving away from, or turning off, these other devices may enable communication. Contact 24-Hour Technical Support if RF interference continues.

- Special Precautions regarding Electromagnetic Compatibility (EMC): This body-worn device is intended to be operated within a residential, domestic, public or work environment, where common levels of radiated “E” (V/m) or “H” fields (A/m) exist. Technologies that emit these fields include: cellular phones that are not paired with the MiniMed 780G system, wireless technology, electric can openers, microwaves, and induction ovens. The MiniMed 780G system generates, uses, and can radiate radio frequency energy and, if not installed and used in accordance with the provided instructions, may cause harmful interference to radio communications.
- Portable and mobile RF communications equipment can affect the operation of the MiniMed 780G system. If interference occurs, move away from the RF transmitter.
- The MiniMed 780G insulin pump can generate, use, and radiate radio frequency energy and, if not installed and used in accordance with the instructions, may cause harmful interference to radio communications. If the MiniMed 780G insulin pump does cause interference to radio or television reception, try to correct the interference by one or more of the following measures:
 - Decrease the distance between the transmitter and the insulin pump to 6 feet (1.8 meters) or less.
 - Decrease the distance between the meter and the insulin pump to 6 feet (1.8 meters) or less.
 - Increase the separation between the transmitter and the device that is receiving/emitting interference.
- The safety of the MiniMed 780G system has not been studied in persons with impaired kidney function. Persons with kidney disease should consult a healthcare professional to determine if the potential benefits of pump therapy outweigh the risks.
- The safety of the MiniMed 780G system has not been studied in pregnant women, persons with type 2 diabetes, or in persons using other anti-hyperglycemic therapies that do not include insulin. Persons in these situations should consult a healthcare professional to determine if the potential benefits of pump therapy outweigh the risks.

- The safety of using the Suspend before low and Suspend on low features in patients who have no pump experience is not known. The Suspend before low and Suspend on low features should not be used if insulin pump settings have not been previously established. Insulin pump settings include basal rates, insulin to carb ratio, and insulin sensitivity factors. Consult a healthcare professional before using the Suspend before low or Suspend on low features.

Reservoir and infusion sets

See the user guides that came with the device for the most current warnings related to the reservoir and infusion set.

- If insulin, or any other liquid, gets inside the tubing connector, it can temporarily block the vents that allow the pump to properly fill the infusion set. This may result in the infusion of too little or too much insulin, and may result in hyperglycemia or hypoglycemia. If this occurs, start over with a new reservoir and infusion set.
- Do not reinsert the introducer needle into the infusion set. Reinsertion may cause tearing of the soft cannula, which may cause unpredictable insulin delivery, and may result in hypoglycemia or hyperglycemia.
- If a BG reading is unexpectedly high during the infusion of insulin or if an occlusion alarm occurs, check the infusion set for clogs and leaks.

If in doubt, change the infusion set in case the soft cannula is dislodged, crimped, or partially clogged. Consult a healthcare professional to create a plan for rapid insulin replacement in the event this occurs. Check BG to confirm that the appropriate amount of insulin has been administered.

- Do not reuse the infusion set. Reuse of the infusion set may damage the cannula or needle, and lead to infection, site irritation, and inaccurate insulin delivery.
- Dispose of the transfer guard safely in a sharps container.
- Do not fill the infusion set tubing or attempt to free a clogged line while the set is inserted into the body. Filling the infusion set tubing while it is connected to the body may cause an unintended infusion of insulin, and result in hypoglycemia.
- Keep the infusion set away from contact with disinfectants, perfumes, or deodorant. These products may affect the integrity of the infusion set, and result in inaccurate insulin delivery and cause hypoglycemia or hyperglycemia.

- Do not clean, reuse, or re-sterilize the infusion set and introducer needle. Reuse of the infusion set or introducer needle can lead to infection, insulin degradation, and inaccurate insulin delivery. Always dispose of the infusion set and introducer needle directly in a sharps container after use.
- Store infusion sets in a cool, dry place. Do not leave infusion sets in direct sunlight, inside a vehicle, or in other environments subject to excessive heating.
- Only use reservoir and infusion sets manufactured or distributed by Medtronic Diabetes. The pump has been tested to operate when used with compatible reservoirs and infusion sets. Medtronic Diabetes cannot guarantee appropriate operation if the pump is used with reservoirs or infusion sets offered by third parties. Medtronic Diabetes is not responsible for any injury or pump malfunction that may occur in association with the use of incompatible components.
- Always wash hands with soap and water before temporarily disconnecting the infusion set. Consult a healthcare professional for ways to compensate for missed insulin while the infusion set is disconnected to prevent hyperglycemia.
- Monitor BG levels when the infusion set is disconnected, and after the infusion set is reconnected to the body.
- Do not clean, reuse, or re-sterilize the reservoir or transfer guard after use. The reservoir and transfer guard are sterile, non-pyrogenic, and for single use only. Reusing the reservoir or transfer guard may lead to insulin degradation, infection, inaccurate insulin delivery, and may damage the pump.
- Always follow the instructions for insertion of the infusion set. Improper insertion of the infusion set or improper maintenance of the infusion site can result in infection and inaccurate insulin delivery.
- If using the infusion set for the first time, perform the first set-up in the presence of a healthcare professional.
- Before use, fill the infusion set tubing to remove all air from the set.
- Do not use the insulin, infusion set, and reservoir longer than the duration of use indicated. Check the corresponding user guide or labeling for more information. Replace the insulin, infusion set, and reservoir according to the shortest duration of use indicated. Using the insulin, infusion set, or reservoir longer than the

indicated duration of use can increase the risk of set occlusions and cause problems with insulin absorption, which can lead to severe hyperglycemia and diabetic ketoacidosis.

- Do not change the infusion set just before bedtime without checking BG one to three hours after insertion.
- Confirm sterility by checking that the sterile paper and tamper-proof seal are not damaged.
- The infusion set is sterile and non-pyrogenic unless the package has been opened or damaged. Do not use if the package has been opened or damaged, or if the tubing connector needle is damaged. If the package has been opened or damaged, or if there is damage to the infusion set, start over with a new infusion set.
- Before insertion, clean the insertion site with isopropyl alcohol.
- Check frequently to confirm that the soft cannula remains firmly in place. If the soft cannula becomes dislodged or is improperly inserted, the full amount of insulin may not be delivered, which may result in hyperglycemia.
- When unwinding MiniMed Mio infusion set tubing, use caution as a hard pull of the tubing can result in damage to the infusion set and introducer needle. Confirm that the infusion set is properly in place when the tubing is fully released.
- If the infusion site becomes inflamed, replace the set and use a new site until the first site has healed. Replace the infusion set if the tape becomes loose or if the soft cannula becomes fully or partially dislodged from the skin.
- Check the infusion set to confirm that no air bubbles are present in the tubing. Air in the tubing may result in inaccurate insulin delivery, and result in hyperglycemia.
- Never point a loaded insertion device towards a body part where insertion is not desired.
- Remove the needle guard before inserting the infusion set.

Sensor andserter

For the most current warnings, see the user guide that came with the device.

- Do not attempt to connect a transmitter that is not compatible with the sensor. The sensor is designed to work with approved transmitters only. Connecting the sensor to a transmitter that is not approved for use with the sensor may damage the components.
- Consult a healthcare professional if a medication that contains acetaminophen or paracetamol is taken while wearing the sensor. Medications that contain acetaminophen or paracetamol can falsely raise sensor glucose readings. The level of inaccuracy depends on the amount of acetaminophen or paracetamol active in the body and can differ for each person. Falsely elevated sensor readings can result in over-delivery of insulin, which can cause hypoglycemia. Medications that contain acetaminophen or paracetamol include, but are not limited to, cold medicines and fever reducers. Check the label of any medications being taken to see if acetaminophen or paracetamol is an active ingredient. Use additional blood glucose meter readings to confirm blood glucose levels.
- While the SmartGuard feature is active, if acetaminophen or paracetamol is taken, program a temp target for up to eight hours, or the amount of time recommended by a healthcare provider. For more information, see *Setting a temp target, page 199*. Use blood glucose values instead of sensor glucose readings to calculate a meal bolus or correction bolus for up to eight hours, or the duration recommended by a healthcare provider, after taking acetaminophen or paracetamol.
- Always inspect the packaging for damage prior to use. Sensors are sterile and non-pyrogenic, unless the package has been opened or damaged. If the sensor packaging is open or damaged, discard the sensor directly into a sharps container. Use of a non-sterile sensor may result in infection at the insertion site.
- Instructions for using the One-pressserter (MMT-7512N) are different from other Medtronic insertion devices. Failure to follow directions, or using a differentserter, may result in improper insertion, pain, or injury.
- Confirm that the sensor is securely placed in theserter to avoid improper insertion, pain, or minor injury.
- Do not allow children to put small parts in their mouth. This product poses a choking hazard for young children.
- Healthcare professionals and caregivers:

- Always wear gloves to insert the sensor. A retractable needle is attached to the sensor. Minimal bleeding may occur.
 - Cover the sensor with sterile gauze to remove the needle housing from the sensor.
- Place the needle housing directly into a sharps container after sensor insertion to prevent accidental needle stick injury.
- Watch for bleeding at the insertion site (under, around, or on top of the sensor). If bleeding occurs, do the following:
 1. Apply steady pressure, using sterile gauze or a clean cloth placed on top of the sensor, for up to three minutes. The use of unsterile gauze can cause site infection.
 2. If bleeding stops, connect the transmitter to the sensor. If bleeding does not stop, do not connect the transmitter to the sensor because blood can get into the transmitter connector, and may damage the device.
- If bleeding continues, causes excessive pain or discomfort, or blood is significantly visible in the plastic base of the sensor, do the following:
 1. Remove the sensor and continue to apply steady pressure until the bleeding stops. Discard the sensor in a sharps container.
 2. Check the site for redness, bleeding, irritation, pain, tenderness, or inflammation. Treat based on instructions from a healthcare professional.
 3. Insert a new sensor in a different location.
- Wear gloves when inserting the sensor into someone other than yourself to avoid contact with patient blood. Minimal bleeding may occur. Contact with patient blood can cause infection.
- Never point a loadedserter toward any body part where insertion is not desired. An accidental button-push may cause the needle to inject the sensor in an undesired location and cause minor injury.
- The safety of sensor use in critically ill patients is not known. Sensor use in critically ill patients is not recommended.

Transmitter

See the user guide included with the device for the most current warnings related to transmitter use.

- Always refer to the sensor user guide for all precautions, warnings, and instructions related to the sensor. Not referring to the sensor user guide can result in serious injury or damage to the sensor.
- Do not allow children to put small parts in their mouth. This product may pose a choking hazard that can result in serious injury or death.
- Do not change or modify the device. Modifying the device can cause serious injury, interfere with the ability to operate the device, and void the warranty.
- Do not use the tester if it comes into contact with blood. Contact with blood may cause infection. If the tester comes into contact with blood, dispose directly into a sharps container.
- Bleeding may occur after inserting the sensor. Always make sure that the site is not bleeding before connecting the transmitter to the sensor. Blood can get into the transmitter connector and damage the device. Discard the device if damaged. If bleeding occurs, apply steady pressure with a sterile gauze, pad, or clean cloth at the insertion site until bleeding stops. After bleeding stops, connect the transmitter to the sensor.
- Do not discard the transmitter in a medical waste container or expose it to extreme heat. The transmitter contains a battery that may ignite and result in serious injury.
- Do not use the transmitter next to other electrical equipment that may cause interference. This includes mobile communication devices such as cell phones, GPS navigation systems, and other devices that have an output transmitter power greater than 1 W. Other electrical equipment that may compromise normal system operation has been contraindicated.

Meter

For the most current warnings, see the User's Manual that came with the device.

Always use the fingertip for blood samples when entering a BG meter reading into the pump while using the SmartGuard feature. Blood samples from other locations, such as

the palm or forearm, have not been studied for use with the SmartGuard feature, and the accuracy of these samples is unknown.

Limitations

- Do not use the meter at high hematocrit levels above 65% or low hematocrit levels below 10%.
- Not for use in diagnosis or screening of diabetes mellitus.
- Not for neonatal use.
- Abnormally high concentrations of ascorbic acid (vitamin C) resulting in blood concentrations in excess of 5 mg/dL may cause inaccurate test results. If you are not sure please check with your doctor.
- Do not use the meter system to measure blood glucose in people who are experiencing cardiovascular collapse (severe shock) or decreased peripheral blood flow.
- Do not use this system during xylose absorption test.
- Not for use on critically ill patients, patients in shock, dehydrated patients, or hyperosmolar patients.
- This system has not been tested at altitudes higher than 10,150 feet.



CAUTION: Every BG reading provided to the pump is used to calibrate the sensor. Do not use Alternative Site Testing to calibrate a continuous glucose monitoring system. Do not use Alternative Site Testing to make insulin dosing calculations.

Potential Biohazard

- During normal testing, any blood glucose meter or lancing device may come in contact with blood. All parts of the kit are considered biohazardous and can

potentially transmit infectious diseases from bloodborne pathogens, even after you have performed cleaning and disinfecting.^{1,2}

- The meter and lancing device should never be used by more than one person. Do not share the meter and lancing device with anyone, including family members, due to the risk of infection from bloodborne pathogens.^{3,4} Do not use on multiple patients!
- Cleaning and disinfecting the meter and lancing device destroys most, but not necessarily all, bloodborne pathogens.⁵

¹ FDA Public Health Notification: "Use of Fingerstick Devices on More than One Person Poses Risk for Transmitting Bloodborne Pathogens: Initial Communication: Update 11/29/2010." <http://wayback.archive-it.org/7993/20161022010458/http://www.fda.gov/MedicalDevices/Safety/AlertsandNotices/ucm224025.htm>. Accessed January 17, 2018.

² CDC Clinical Reminder: "Use of Fingerstick Devices on More than One Person Poses Risk for Transmitting Bloodborne Pathogens (2010)." <http://www.cdc.gov/injectionsafety/Fingerstick-DevicesBGM.html>. Accessed January 17, 2018.

³ FDA Public Health Notification: "Use of Fingerstick Devices on More than One Person Poses Risk for Transmitting Bloodborne Pathogens: Initial Communication: Update 11/29/2010." [http:// wayback.archive-it.org/7993/20161022010458/http://www.fda.gov/MedicalDevices/Safety/AlertsandNotices/ucm224025.htm](http://wayback.archive-it.org/7993/20161022010458/http://www.fda.gov/MedicalDevices/Safety/AlertsandNotices/ucm224025.htm). Accessed January 17, 2018.

⁴ CDC Clinical Reminder: "Use of Fingerstick Devices on More than One Person Poses Risk for Transmitting Bloodborne Pathogens, (2010)." <http://www.cdc.gov/injectionsafety/Fingerstick-DevicesBGM.html>. Accessed January 17, 2018

⁵ Centers for Disease Control and Prevention (CDC): "Guideline for Disinfection and Sterilization in healthcare Facilities, 2008." Update: May 2019. William A. Rutala, Ph.D., M.P.H., and David J. Weber, M.D., M.P.H., and the Healthcare Infection Control Practices Advisory Committee (HICPAC). <https://www.cdc.gov/infectioncontrol/pdf/guidelines/disinfection-guidelines-H.pdf>. Accessed September 23, 2019.

- If the meter is being operated by a second person who is providing testing assistance to the user, the meter and lancing device should be cleaned and disinfected prior to use by the second person.
- Disinfect the meter and lancing device before allowing anyone else to handle them. Do not allow anyone else to test with the meter or lancing device.
- It is important to keep the meter and lancing device clean and disinfected. For instructions on how to clean and disinfect the meter and lancing device, see the chapter Meter and Lancing Device Cleaning and Disinfecting.
- Wash hands and dry thoroughly before and after handling the meter, lancing device, or test strips.

Exposure to magnetic fields and radiation

- Do not expose the pump, transmitter, or sensor to MRI equipment, diathermy devices, or other devices that generate strong magnetic fields (for example, x-ray, CT scan, or other types of radiation). Strong magnetic fields can cause the system to malfunction, and result in serious injury. If the pump is exposed to a strong magnetic field, discontinue use and contact 24-Hour Technical Support for further assistance.

Magnetic fields, and direct contact with magnets, may affect the accurate functioning of the system which may lead to health risks such as hypoglycemia or hyperglycemia.

- Remove the pump, sensor, transmitter, and meter before entering a room with x-ray, MRI, diathermy, or CT scan equipment. The magnetic fields and radiation in the immediate vicinity of this equipment can make the devices nonfunctional or damage the part of the pump that regulates insulin delivery, possibly resulting in over-delivery and severe hypoglycemia.
- Do not expose the pump to a magnet, such as pump cases that have a magnetic clasp. Exposure to a magnet may interfere with the motor inside the pump. Damage to the motor can cause the device to malfunction, and result in serious injury.

- Do not send the pump or transmitter through an x-ray scanning machine. The radiation can damage the pump components that regulate insulin delivery, and may result in over-delivery of insulin and hypoglycemia.
All system components, including the pump, transmitter, and sensor, must be removed prior to being screened with a full-body scanner. To avoid system removal, request an alternative screening method, if necessary.
- Carry the Medical emergency card provided with the device when traveling. The Medical emergency card provides critical information about airport security systems and pump use on an airplane. Not following the guidance on the Medical emergency card may result in serious injury.

General precautions

Check BG levels at least every 12 hours. Pump alarms do not notify the patient of leaks in the infusion set or degradation of insulin. If BG is out of range, check the pump and the infusion set to confirm that the necessary amount of insulin is being delivered.

Check for adverse reactions where the pump comes into contact with skin. These reactions include redness, swelling, irritation, sensitization, rash, and other allergic reactions. Do not allow the pump to come into contact with skin wounds, as the pump materials have only been evaluated for safe contact with intact skin.



Note: If you drop your pump, be sure to monitor your glucose levels for the next four hours.

Waterproof capabilities

- The pump is waterproof at the time of manufacture and when the reservoir and tubing are properly inserted. It is protected against the effects of being underwater to a depth of up to 12 feet (3.6 meters) for up to 24 hours.
- If the pump is dropped, hit against a hard object, or otherwise damaged, the waterproof characteristics of the outer casing of the pump may be compromised. If the pump is dropped or might be damaged, carefully inspect it to confirm that there are no cracks before exposing the pump to water.
- This waterproof capability rating applies only to the pump.

- If water may have entered the pump or other pump malfunction is observed, check BG and treat high BG as necessary using an alternative source of insulin. Contact 24-Hour Technical Support for further assistance, and consult a healthcare professional about high or low BG levels or with any other questions about care.

Electrostatic discharge

- Very high levels of ESD can result in a reset of the pump's software and a pump error alarm. After clearing the alarm, confirm that the pump is set to the correct date and time, and that all other settings are programmed to the desired values. Following a pump reset, the SmartGuard feature will be unavailable for five hours to allow active insulin to be updated.
- For more information on pump alarms, see *Pump alarms, alerts, and messages*, page 299. Contact 24-Hour Technical Support with any problems entering pump settings.

Extreme temperatures

Exposure to extreme temperatures can damage the device. Avoid the following conditions:

- Pump storage temperature above 122 °F (50 °C) or below –4 °F (–20 °C).
- Pump operating temperature above 98.6 °F (37 °C) or below 41 °F (5 °C). Insulin solutions freeze near 32 °F (0 °C) and degrade at temperatures higher than 98.6 °F (37 °C). In cold weather, wear the pump close to the body and cover it with warm clothing. In a warm environment, take measures to keep the pump and insulin cool.
- Do not steam, sterilize, autoclave, or otherwise heat the pump.

Skin care products

Some skin care products, such as lotion, sunscreen, and insect repellents, can damage the plastic in the pump case. After using skin care products, wash hands prior to handling the pump. If a skin care product comes into contact with the pump, wipe it off as soon as possible with a damp cloth and mild soap. For instructions on cleaning the pump, see *Cleaning the pump*, page 289.

Infusion sets and sites, sensor, transmitter, and meter

Refer to the corresponding device user guide for all warnings, precautions, and instructions relating to the device. Failure to reference the corresponding device user guide can result in minor injury, or damage to the device.

Adverse reactions

Refer to the sensor user guide for adverse reactions related to sensor use. Failure to reference the sensor user guide may result in minor injury, or damage to the sensor.

Security precautions

The MiniMed 780G insulin pump system is designed with security features to help keep the system and the data secure. These security features in the insulin pump system are set in the factory and ready to use when the insulin pump is received. For example, when the pump communicates with other devices in the system, such as the BG meter, transmitter, or compatible mobile device, the data that it sends and receives is encrypted and protected by cyclic redundancy checks. This helps prevent other people from being able to see system data, or to interfere with insulin pump therapy.

To help keep the system secure, follow these instructions:

- Do not leave the insulin pump or the paired devices unattended.
- Do not share the pump, transmitter, or BG meter serial number.
- Do not connect the pump to any third-party devices not authorized by Medtronic.
- Do not use any software not authorized by Medtronic to control the system.
- Be attentive to pump notifications, alarms, and alerts because they may indicate that someone else is trying to connect to or interfere with the device.
- Disconnect the Blue Adapter from the computer whenever it is not being used.
- Use good cyber security practices; use anti-virus software and keep computer software up to date.
- Refer to the MiniMed Mobile App User Guide for information on how to keep the compatible mobile device safe to use with the Medtronic devices.

The pump only communicates with paired devices. The short time that it takes to pair the pump with other devices is a sensitive time for security. During this time, it is possible for an unintended device to pair with the pump. While Medtronic has designed security features into the system to prevent this, to keep the system safe during pairing always follow these instructions:

- Pair the transmitter, BG meter, or the compatible mobile device with the pump away from other people and devices.
- When the transmitter successfully pairs with the pump, the green LED on the transmitter stops blinking. If the green LED on the transmitter continues to blink for several minutes or more after it is successfully paired, it may have been paired with an unintended device. See *Unpairing the transmitter from the pump, page 294* to delete the transmitter from the pump and then follow the steps to pair it again.
- After pairing the BG meter or the compatible mobile device with the pump, make sure that the BG meter or compatible mobile device indicates that pairing was successful.

Consult a healthcare professional if there are symptoms of severe hypoglycemia or diabetic ketoacidosis, or suspect that the insulin pump settings, or insulin delivery changed unexpectedly.

If there is a concern that someone else is trying to connect to or interfere with the device, stop using it and contact 24-Hour Technical Support immediately.

Insulin guidelines



WARNING: Do not insert an insulin-filled reservoir into the pump, or connect an insulin-filled infusion set into the body, when training with the system. Doing so may result in the unintentional infusion of insulin, which may result in hypoglycemia. Start insulin therapy only when directed by a healthcare professional.

The MiniMed 780G system has been studied with, and is intended for use with, the following rapid-acting U-100 insulins:

- U-100 NovoLog™*
- U-100 Humalog™*

The use of any other insulin in the MiniMed 780G system has not been tested and is contraindicated for use with this device.



WARNING: Only use rapid-acting U-100 insulin (Humalog™* and NovoLog™*), as prescribed by a healthcare professional, in the MiniMed 780G system. Use of the incorrect type of insulin, or insulin with a greater or lesser concentration may result in over-delivery or under-delivery of insulin, which may result in hypoglycemia or hyperglycemia. Consult a healthcare professional with any questions about the type of insulin that is compatible with the pump.

Consumables

The pump uses disposable, single-use MiniMed and Medtronic reservoirs and infusion sets for insulin delivery.



WARNING: Only use reservoir and infusion sets manufactured or distributed by Medtronic Diabetes. The pump has undergone extensive testing to confirm appropriate operation when used with compatible reservoirs and infusion sets manufactured or distributed by Medtronic Diabetes. Medtronic Diabetes cannot guarantee appropriate operation if the pump is used with reservoirs or infusion sets offered by third parties and therefore Medtronic Diabetes is not responsible for any injury or malfunctioning of the pump that may occur in association with such use.

- **Reservoirs**—If using a Medtronic Extended infusion set, use the Medtronic Extended reservoir MMT-342, 3.0 mL (300-unit). Otherwise, use the MiniMed reservoir MMT-332A, 3.0 mL (300-unit).

- **Infusion sets**—Contact a healthcare professional for help in choosing a Medtronic Diabetes infusion set. Change the infusion set per the duration of use in the infusion set user guide.

The following table lists the compatible infusion sets. The MMT numbers may change if other compatible infusion sets become available.



Note: Some MMT numbers also include “A” versions, such as MMT-396, MMT-396A, and MMT-396AT, that are compatible with the pump system.

Type	MMT number
MiniMed Quick-set infusion set	MMT-386, MMT-387, MMT-394, MMT-396, MMT-397, MMT-398, MMT-399
MiniMed Silhouette infusion set	MMT-368, MMT-377, MMT-378, MMT-381, MMT-382, MMT-383, MMT-384
MiniMed Sure-T infusion set	MMT-862, MMT-864, MMT-866, MMT-874, MMT-876, MMT-884, MMT-886
MiniMed Mio infusion set	MMT-921, MMT-923, MMT-925, MMT-941, MMT-943, MMT-945, MMT-965, MMT-975
MiniMed Mio Advance infusion set	MMT 213A, MMT-242, MMT-243A, MMT-244A
Medtronic Extended infusion set	MMT-430A, MMT-431A, MMT-432A, MMT-433A, MMT-440A, MMT-441A, MMT-442A, MMT-443A

Other MiniMed 780G system devices

- **Accu-Chek™* Guide Link meter**—The meter sends BG meter readings to the pump.
- **Guardian Link (3) transmitter (MMT-7911)**—The transmitter pairs with the pump, collects data measured by the sensor, and wirelessly sends this data to monitoring devices. This device is required for CGM.
- **Guardian Sensor (3) (MMT-7020)**—The sensor is a disposable, single-use device inserted just below the skin to measure glucose levels in interstitial fluid. This

device is required for CGM. The Guardian Sensor (3) (MMT-7020) glucose sensor is the only sensor compatible with the MiniMed 780G insulin pump and Guardian Link (3) transmitter.

Accessories

The following accessories may be used with the MiniMed 780G system.

- **Pump clip**—The pump clip attaches to a belt and can be used to open the battery compartment.
- **Activity guard**—The activity guard helps to prevent the reservoir from being rotated or removed from the pump during physical activities.
- **Blue Adapter**—The Blue Adapter uploads system data to CareLink software through a USB port on a computer. Refer to the CareLink software user guide for setup and operation of the Blue Adapter.
- **MiniMed Mobile app (MMT-6101 for Android™* or MMT-6102 for iOS™*)**—The app provides a secondary display of insulin pump data and CGM, and uploads system data to CareLink software. The app can be installed on multiple mobile devices, but only one device can be paired with the pump at a time.
- **CareLink Connect app (MMT-6111 for Android™* or MMT-6112 for iOS™*)**—The app can be downloaded onto compatible mobile devices from the app store. Refer to the app user guide for setup and operation within the app. This optional app is available to care partners to view patient therapy data and to be notified of selected patient alerts. This app does not replace the real-time display of insulin pump or CGM data on the primary display device. All therapy decisions should be based on the primary display device. Refer to the local Medtronic Diabetes website for information about supported devices and operating systems.
- **Medtronic Diabetes Updater app (MMT-6121 for Android™* or MMT-6122 for iOS™*)**—The app can be paired with the pump to update the MiniMed 780G insulin pump software when a pump software update is available. Refer to the local Medtronic Diabetes website for information about supported devices and operating systems.



2



System overview

2

System overview

In this chapter, you will learn about the components of the system and some important concepts and terminology that you will need to understand when using the system.

What are the components of the MiniMed 780G system?

The following items are the main system components:

- **MiniMed 780G pump**—The pump delivers insulin into your body through the infusion set, based on the settings provided by your healthcare professional.
- **Infusion sets**—An infusion set connects to both the pump and your body. It carries the insulin as it is pushed out of the pump and delivers it.
- **Reservoirs**—The reservoir is filled with insulin and placed in the pump so that insulin can be delivered into your body through the infusion set.
- **Sensors and transmitter**—The sensor measures glucose in the fluid under your skin. The transmitter communicates with the pump through a wireless connection. The sensor and transmitter make up the continuous glucose monitoring (CGM) system.
- **Accu-Chek Guide Link meter**—Use this meter to measure the glucose in your blood. The meter sends this blood glucose (BG) information to your pump through a wireless connection.

The following diagram shows what the pump, meter, and sensor and transmitter look like and how you may wear them on your body. A diagram later in chapter 3 will show you more details about the infusion set and reservoir.

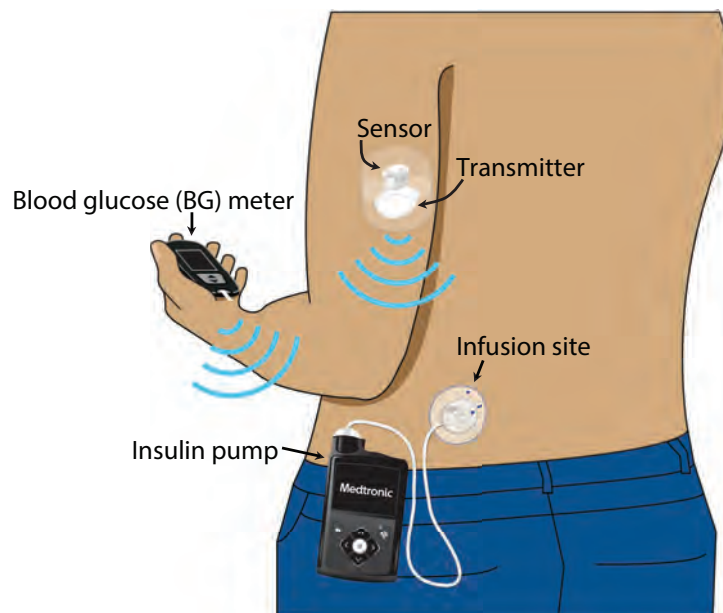

Modes

Your pump operates in two different modes: Manual mode and SmartGuard.

When you first use your 780G insulin pump, it is in Manual mode. Manual mode refers to a group of features that requires your input to deliver boluses for meals and to correct glucose levels. You may use Manual mode with or without CGM. When using CGM in Manual mode, you can see sensor glucose trends, receive low and high sensor glucose alerts, and suspend insulin delivery according to your settings.

After several days of use in Manual mode, and at the direction of your healthcare provider, you can turn the SmartGuard feature on. When in SmartGuard, the pump automatically adjusts and delivers basal insulin and can also deliver automatic correction boluses to regulate glucose levels to a target SG value. You will still need to enter carbs that you eat to deliver a food bolus.

The following table show the main features of Manual mode and the SmartGuard mode. There are details on each of these topics later in this guide.

Manual mode without CGM



Bolus delivery options	Basal delivery features	Suspend options
<ul style="list-style-type: none"> Bolus Wizard calculates a bolus based on your settings <ul style="list-style-type: none"> A blood glucose (BG) meter reading is needed for a correction bolus A carb entry is needed for a food bolus Manual bolus 	<ul style="list-style-type: none"> Programmed basal delivery settings A Temp basal rate can be used to temporarily increase or decrease basal insulin delivery 	<ul style="list-style-type: none"> Manual suspend

Manual mode with CGM

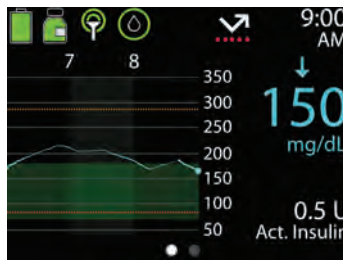

Bolus delivery options	Basal delivery features	Suspend options
<ul style="list-style-type: none"> Same as Manual mode without CGM 	<ul style="list-style-type: none"> Same as Manual mode without CGM 	<ul style="list-style-type: none"> Manual suspend Suspend before low Suspend on low

SmartGuard



Bolus delivery options	Basal delivery features	Suspend options
<ul style="list-style-type: none"> • SmartGuard bolus feature delivers bolus insulin based on sensor glucose (SG) values and carb entries • A blood glucose (BG) meter reading may be required when a sensor glucose (SG) value does not appear on the Bolus screen • The bolus amount cannot be adjusted • The pump may automatically deliver an Auto Correction bolus to maximize the time in range. 	<ul style="list-style-type: none"> • The pump automatically delivers basal insulin based on recent insulin delivery needs, Sensor glucose (SG) values, and your glucose target • A Temp target can be set when less insulin is needed, such as for exercise 	<ul style="list-style-type: none"> • Manual suspend

3



Pump basics

3

Pump basics

This chapter provides information about the basic features, buttons, and screens of the MiniMed 780G insulin pump.













CAUTION: Do not use sharp objects to press the pump buttons. The use of sharp objects can damage the pump.

Using the buttons



The following table describes the notification light and how to use the pump buttons.

Item	Description
①	Press  to go to the Menu screen from the Home screen and to select a highlighted menu option.
②	Press  or  to scroll up or down, select an item on a screen, select the icons on the Menu screen, or to increase or decrease the value of a setting. Press  or  to move left or right on certain screens, or to select the icons on the Menu screen.
③	Press  to access the Graph screen. Press and hold  to put the pump in Sleep mode.
④	Press  to go back to the previous screen. Press and hold  to return to the Home screen.
⑤	The notification light  flashes when the pump has an alarm or alert. The notification light is not visible unless it flashes.

Sleep mode

The pump enters Sleep mode after two minutes to conserve battery power. Sleep mode does not affect insulin delivery. Press any button to wake up the pump. Press and hold  for two seconds to manually enter Sleep mode.

Pump delivery system

The following diagram shows the parts of the pump delivery system, including the infusion set*, reservoir, and pump.

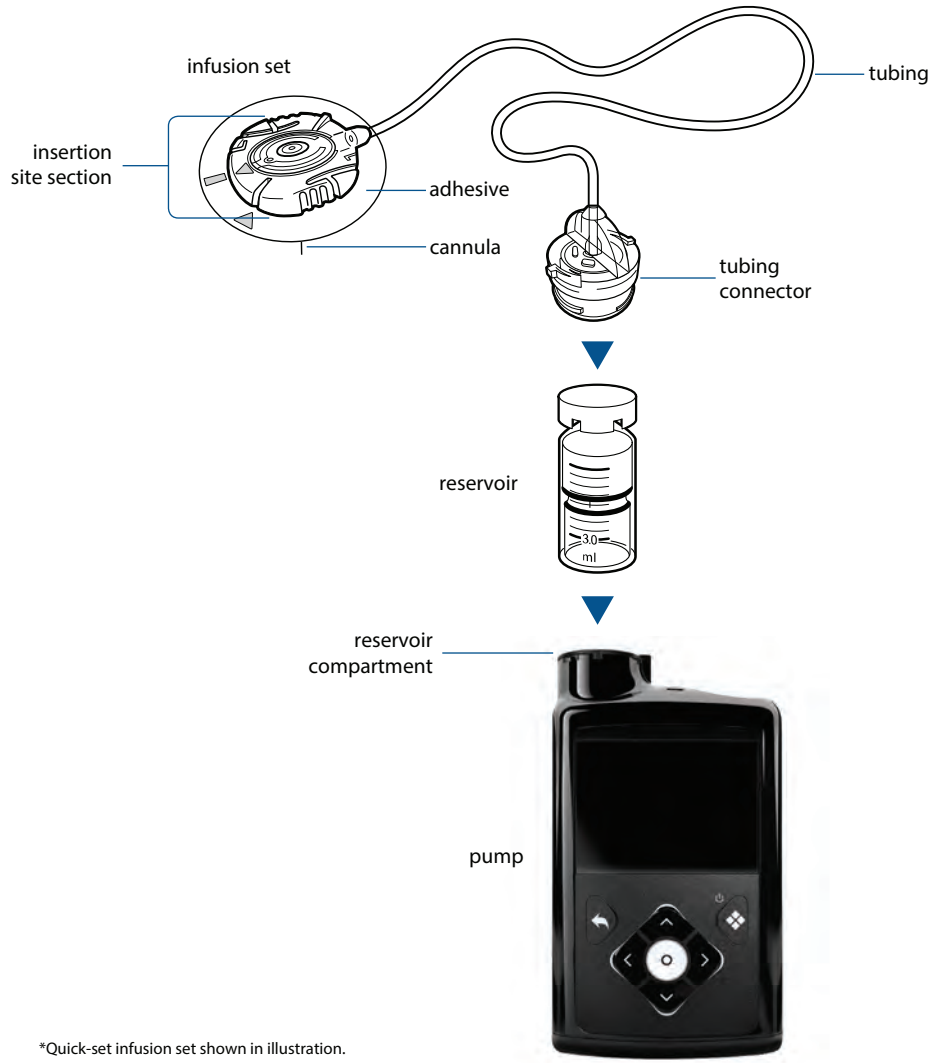

*Quick-set infusion set shown in illustration.

Infusion set

The infusion set consists of the following components:

- The tubing carries insulin from the reservoir into the body.
- The tubing connector attaches to the reservoir.
- The insertion piece attaches to the body.
- The cannula is a small, flexible tube inserted into the body. Some infusion sets use a small needle instead of a cannula.
- The adhesive holds the infusion set in place.

Change the infusion set according to the user guide provided with the infusion set.

Reservoir

The reservoir stores insulin for delivery and is inserted into the pump reservoir compartment.

Pump

Underneath the reservoir compartment, a piston pushes up on the bottom of the reservoir to move insulin into the tubing, through the cannula, and into the body.

The pump delivers small doses of insulin, as low as 0.025 units. The piston inside the pump must be rewound each time a newly filled reservoir is inserted into the reservoir compartment.

Inserting the battery

The pump requires one new AA (1.5 V) battery. For best results, use a new AA lithium (FR6) battery. The pump also accepts an AA alkaline (LR6) or a fully charged AA NiMH (HR6) nickel-metal hydride rechargeable battery.



CAUTION: Do not use a carbon zinc battery in the pump. Carbon zinc batteries are not compatible with the pump and can cause the pump to report inaccurate battery levels.



Note: Do not use cold batteries because the battery life may incorrectly appear low. Allow cold batteries to reach room temperature before they are inserted into the pump.

The battery cap is located in the pump box with the accessories.

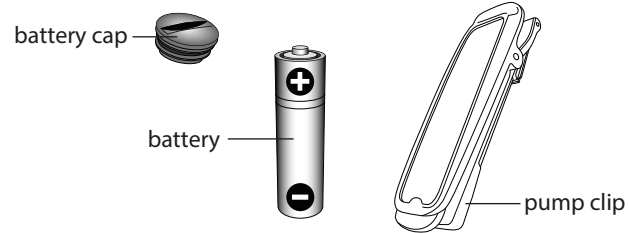

To insert the battery:

1. Insert a new or fully charged AA battery. Make sure to insert the negative end (-) first.

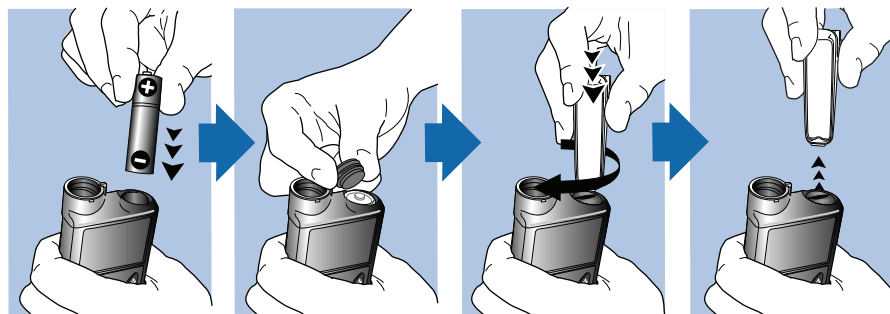

2. Place the battery cap onto the pump. Use the bottom edge of the pump clip or a coin to tighten the cap.



CAUTION: Do not overtighten or undertighten the battery cap. A battery cap that is too tight can cause damage to the pump case. A battery cap that is too loose can prevent detection of the new battery. Turn the battery cap clockwise until the cap slot is aligned horizontally with the pump case, as shown in the following example.

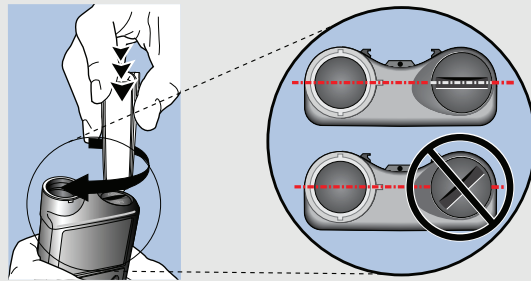

The first time a battery is inserted into the pump, the Startup Wizard begins. Any other time a battery is inserted into the pump, the Home screen appears and the pump resumes basal delivery.

Startup settings

The Startup Wizard appears after a battery is inserted for the first time. Use the Startup Wizard to set the language, time format, current time and date, and to rewind the pump. To re-enter these settings later, see *Pump issues*, page 280.

To use the Startup Wizard:

1. On the Select Language screen, select a language, and then press .



The Select Time Format screen appears.

2. Select a time format, and then press **⊙**.

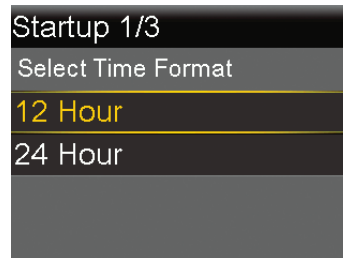

3. Enter the current time, and then select **Next**.

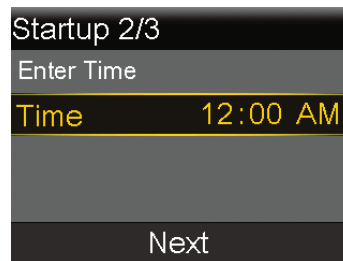

The Enter Date screen appears.

4. Enter the current date, and then select **Next**.

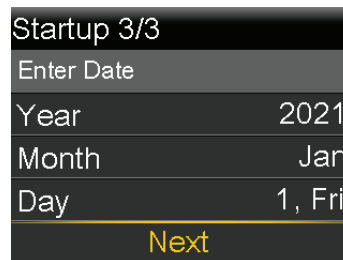

A "Rewinding" message appears. The piston returns to its start position in the reservoir compartment. This may take several seconds.



When rewinding is complete, a message appears to confirm the startup is complete.

5. Select **OK** to go to the Home screen.

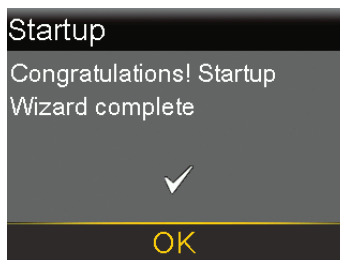

Home screen in Manual mode

The Home screen appears after the battery is changed, when the pump wakes from Sleep mode, and when another screen is not actively being used.



Note: This example shows the Home screen in Manual mode when the Sensor feature is turned off. For information about the Home screen when the Sensor feature is turned on, see *Home screen with CGM in Manual mode, page 152*. For information about the Home screen with the SmartGuard feature, see *Home screen with the SmartGuard feature, page 189*.



The following items appear on the Home screen:

Item	Description
Status icons	The status icons show a quick status of the pump system. For more information, see <i>Status icons</i> , page 78.
Current time	For details on setting the time, see <i>Time and date</i> , page 207.
BG readings	The current blood glucose (BG) meter reading is shown. The BG is either entered manually or received from a paired Accu-Chek™* Guide Link meter.
Active insulin	Active insulin is bolus insulin delivered by the insulin pump that continues to lower BG levels. Active insulin is not necessarily reflective of the pharmacokinetics and pharmacodynamics of rapid acting insulins. For more details on active insulin, see the description of Active Insulin Time in <i>Bolus Wizard settings</i> , page 103.











Shortcuts from the Home screen

The following table describes shortcuts that can be used to quickly access certain pump functions. These shortcuts only work on the Home screen.

Shortcut	Description
^	Press this button to access the Status screen.
>	Press this button to access the Time in Range screen when the Sensor feature is turned on.
✓	Press this button to access the Bolus screen. The Bolus screen that appears varies depending on the bolus feature that is currently active.

Status icons



The status icons provide the current status of the pump system. For information on viewing detailed status screens, see *Status screen, page 83*.



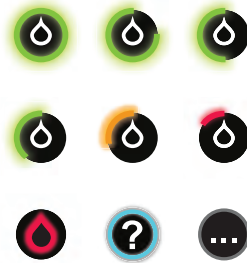

Icon name	Description
Active Insulin reset to zero	After the Active Insulin reset to zero alarm occurs,  appears on the Home screen and Bolus screens until the time shown in the alarm. For more information, see <i>Pump issues, page 280</i> .
Battery	The color and fill level of the icon indicate the charge level of the pump battery. As the battery is used, the icon changes from solid green in the following order:  <ul style="list-style-type: none"> The battery is full. The battery is low. The battery can be used for less than 30 minutes and needs to be replaced.
Reservoir	The reservoir icon shows the fill status of the MiniMed or Medtronic 3.0 mL (300-unit) reservoir. <ul style="list-style-type: none"> Approximately 85%–100% of the insulin remains in the reservoir. Approximately 71%–84% of the insulin remains in the reservoir. Approximately 57%–70% of the insulin remains in the reservoir. Approximately 43%–56% of the insulin remains in the reservoir. Approximately 29%–42% of insulin remains in the reservoir. Approximately 15%–28% of the insulin remains in the reservoir.

Icon name	Description
	<ul style="list-style-type: none"> • Approximately 1%–14% of the insulin remains in the reservoir. • The amount of insulin remaining in the reservoir is unknown.
Connection	<p>The connection icon shows the following information:</p> <ul style="list-style-type: none"> • The Sensor feature is on and communicating. • The Sensor feature is on, but the transmitter is not communicating with the pump.
Temporary network connection	<p> The temporary network connection icon shows when the pump is temporarily connected to a remote upload device.</p>
Calibration	<p>The calibration icon shows the amount of time remaining until the next sensor calibration is needed. These icons only appear when the Sensor feature is on.</p>



- The color and the circle around the icon indicate the status.
- When the sensor is recently calibrated, the icon has a solid green circle around it. As the time for the next sensor calibration approaches, the green circle around the icon becomes smaller and the color of the icon changes.
- When the icon turns red, a sensor calibration is required.
- If the time until the next sensor calibration is unavailable, the icon has a solid blue circle around a question mark.

Icon name	Description
	<ul style="list-style-type: none"> When the sensor is not ready for a calibration, the circle shows three dots. This occurs when a new sensor is connected or within 15 minutes of a Calibration not accepted alert.
Trend arrows	<p>The trend arrows indicate the rate at which the most recent SG readings are rising or falling. Glucose readings may trend up or down during certain activities, such as eating, giving a bolus, or when exercising. These icons appear only when the sensor feature is turned on.</p> <ul style="list-style-type: none"> ↑ or ↓: SG has been rising or falling at a rate of 20-40 mg/dL over the last 20 minutes, or 1-2 mg/dL per minute. ↑↑ or ↓↓: SG has been rising or falling at a rate of 40-60 mg/dL over the last 20 minutes, or 2-3 mg/dL per minute. ↑↑↑ or ↓↓↓: SG has been rising or falling at a rate of more than 60 mg/dL over the last 20 minutes, or more than 3 mg/dL per minute.
Sensor life	<p>The number on the sensor life icon indicates the number of days that remain in the life of the sensor. The icon appears on the Status screen and only when the Sensor feature is turned on. After a new sensor is inserted, the icon is solid green. When one day remains in the life of the sensor, the icon turns red. When the sensor expires, the icon turns solid black with an X.</p> <p></p> <p>If the number of days that remain in the life of the sensor is not yet available, such as when the sensor is warming up, the sensor life icon appears with three dots. </p> <p>If the number of days that remain in the life of the sensor is unknown, the sensor life icon appears with a question mark. </p>

Icon name	Description
Block mode	The Block mode icon  shows that the pump is locked. For more information about Block mode, see <i>Block mode</i> , page 208.
Suspend by sensor	<p>When the current low alert time segment has either the Suspend before low or Suspend on low feature turned on, the Suspend by sensor icon appears on the Home screen.</p> <p> When Suspend before low or Suspend on low feature suspends insulin delivery, the icon flashes.</p> <p> If the Suspend before low or Suspend on low feature is turned on but unavailable, the icon has a red X.</p> <p> This can be due to a recent suspend by sensor event or when no SG values are available.</p> <p>For more information, see <i>The Suspend before low feature</i>, page 156 and <i>The Suspend on low feature</i>, page 158.</p>
Alert silence	The Alert silence icon  indicates that the Alert Silence feature is turned on and some alerts will not make a sound or vibration. Sensor alerts can be silenced for a specific duration using the Alert silence feature. For more information, see <i>Silencing sensor alerts</i> , page 175.











Note: Status icons provide limited information. For example, the reservoir icon may indicate the reservoir is low on insulin. The Status screen shows more detailed information about how many units are left. For more information about the status screens, see *Status screen*, page 83.

Menu screen

Use the menu to go to screens that show various features and functions of the system. Press  from the Home screen to go to the menu. The selected menu option appears in color. All other menu options appear in black and gray.



Use the menu to go to the following screens:

Menu selection	Menu icon	Description
Insulin		Deliver a bolus, set up and deliver basal insulin, suspend insulin delivery, and stop bolus during bolus delivery.
History & Graph		View history, SG review, graph, and time in range.
SmartGuard		Set up the SmartGuard feature.
Sound & Vibration		Set sound, vibrate, and volume options for notifications.
Reservoir & Set		Set up a new reservoir and infusion set, and fill a cannula.
Blood Glucose		Enter a BG value.
Status		View the status of the pump and other system features.
Paired Devices		Pair devices or CareLink software.
Settings		Set up device settings, delivery settings, and alert settings.











Menu map

Refer to *Menu map, page 351* to see the menu map diagrams.

Sound & Vibration screen

The sound and vibration options are set on the Sound & Vibration screen. Sensor alerts can also be temporarily silenced. For information about silencing alerts, see *Silencing sensor alerts, page 175*. A status icon on the Home screen indicates when alerts are silenced. For more information, see *Status icons, page 78*.

To adjust the sound and vibration settings:

1. From the Home screen, press , and then select .
2. Adjust the volume:
 - a. Select **Volume**.
 - b. Press .
 - c. Press , , , or , and then press .
3. Select **Sound**, and then press  to turn the sound on or off.
4. Select **Vibration**, and then press  to turn the vibration on or off.

Status screen

The Status screen provides access to information about the pump and information about the sensor, if applicable. The Status screen also provides the option to suspend all insulin delivery or resume basal insulin delivery.

Use the Status screen to access the following screens or options:

Screen or option	Description
Stop Bolus	This option appears when a bolus delivery is in progress. Select Stop Bolus to stop the active bolus.
Suspend All Delivery or Resume Basal	This option indicates whether insulin delivery is currently suspended. Select Suspend All Delivery to suspend insulin delivery. Select Resume Basal to resume basal insulin delivery. For more information see <i>Suspending all insulin delivery and resuming basal insulin delivery, page 95</i> .
SmartGuard Checklist screen	This screen shows a list of the required conditions before the pump can use the SmartGuard feature. For more information, see <i>SmartGuard Checklist, page 187</i> .
Pump status screen	This screen shows a detailed view of the pump status, the reservoir status, infusion set status, battery status, pump serial number, pump name, model number, and other pump details.

Screen or option	Description
Sensor status screen	This screen appears when the Sensor feature is turned on. The Sensor status screen includes sensor life, transmitter battery life, and shows the serial number and version number of the transmitter.

To view the status screens:

1. From the Home screen, press , and then select .

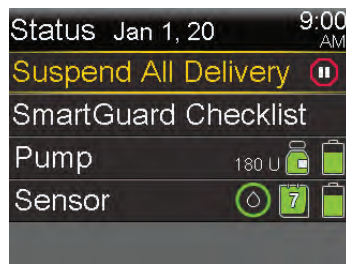

2. Press  or  to select a status screen, and then press .

4



Setting up insulin delivery

4

Setting up insulin delivery

This chapter explains how to use different types of insulin delivery.

Setting up basal insulin

Basal insulin is the “background” insulin that the body needs throughout the day and night to maintain target blood glucose (BG) meter readings when food is not eaten. Basal insulin accounts for approximately one half of daily insulin requirements. The MiniMed 780G insulin pump simulates a pancreas by delivering insulin continuously over 24 hours.



WARNING: The pump is intended to be used with a basal pattern. The basal pattern must be manually entered and saved into the pump. The pump will operate with a basal rate of 0.0 U/hr until a basal pattern is entered and saved. There is no reminder message to program basal rates. Consult a healthcare professional to determine what basal pattern is needed. For more information about basal patterns, see *Basal patterns, page 89*.

Basal rate



Basal rate is the specific amount of basal insulin that the pump continuously delivers each hour. While some people use one basal rate all day, others require different rates at different times of the day.

Basal rates are set in one or more basal patterns. Each basal pattern covers 24 hours. For specific information about basal patterns, see *Basal patterns, page 89*.

Max basal rate

The Max basal rate is the maximum amount of basal insulin that the pump can deliver per hour. Set the Max basal rate as indicated by a healthcare professional. It is not possible to set a basal rate, a temp basal rate, or a preset temp basal rate that would exceed the Max basal rate limit. After the basal patterns or preset temp basal rates are set, the Max basal rate cannot be lower than any of the existing basal rates. The Max basal rate can be set from 0 to 35 units per hour.

To set the Max basal rate:

1. From the Home screen, press , and then select .
2. Select **Delivery Settings** > **Max Basal/Bolus**.

The Max Basal/Bolus screen appears.



3. Select **Max Basal**.

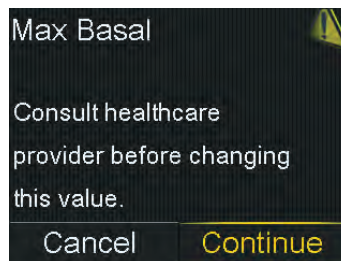

4. To continue to the Max Basal Rate screen, select **Continue**.
5. Select **Max Basal**, and then set the maximum number of basal insulin units per hour.



6. Select **Save**.

Basal patterns

The basal pattern determines the amount of basal insulin delivered throughout the day and night. A basal pattern is made up of one to 48 basal rates that are set to cover a full 24-hour period. Because basal insulin needs can vary, up to eight basal patterns can be set.

The following example represents one basal pattern with three basal rates set for three different time periods.

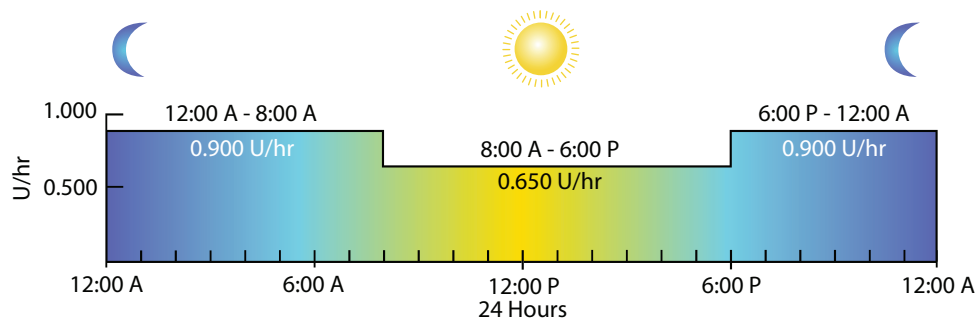

Consult a healthcare professional to determine the basal pattern. The basal pattern must be manually entered and saved into the pump. There will be no reminder message to program basal rates.





WARNING: Confirm a basal pattern is entered. If a basal pattern is needed but not entered and saved, this could result in an under-delivery of basal insulin. Under-delivery of insulin can potentially cause severe hyperglycemia, which may lead to diabetic ketoacidosis.

Setting up a basal pattern

This procedure shows how to set up a basal pattern for the first time. To add an additional basal pattern, see *Adding an additional basal pattern*, page 246.

To set up a basal pattern:

1. From the Home screen, press , and then select .
2. Select **Delivery Settings** > **Basal Pattern Setup**.



3. Select **Basal 1**.
4. Select **Options**, and then select **Edit**.

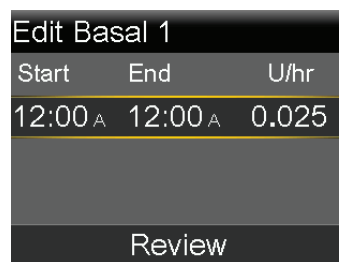

5. For one basal rate, the End time does not need to change. Press  on the 12:00 A.



Note: For instructions on setting up multiple basal rates over a 24-hour period, see *Settings covering a 24-hour period, page 91*.

6. Enter the unit value for the time period.
7. Select **Review**.

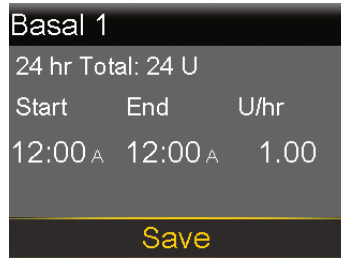

Review the basal pattern. Press to return to the previous screen to make changes.



Note: If is pressed and **Save** is not selected, the changes are not saved.

8. Select **Save**.

Settings covering a 24-hour period

Some pump functions allow settings to change over a 24-hour period. Basal rates are one of those settings.

Setting up multiple values over a 24-hour period applies to the following settings:

- Basal patterns
See *Setting up a basal pattern, page 90*
- High SG settings
See *Setting up the High SG settings, page 162*
- Low SG settings
See *Setting up the low SG settings, page 165*
- Carb ratios, insulin sensitivities, and BG targets in the Bolus Wizard feature

See *Setting up the Bolus Wizard feature*, page 105

The following screen is an example of a basal pattern with different rates of basal insulin for specific times of the day.

Edit Basal 1		
Start	End	U/hr
12:00 _A	8:00 _A	0.900
8:00 _A	6:00 _P	0.650
6:00 _P	12:00 _A	0.900
Review		

To set up values over a 24-hour period:

1. On the appropriate settings screen, select the End time and enter the end time for the first time period. In this example, the first desired time period is 8 hours. The start time always begins at 12:00 A. To set an 8-hour period, enter an end time of 8:00 A.

Edit Basal 1		
Start	End	U/hr
12:00 _A	12:00 _A	0.025
Review		

2. Enter the unit value for the first time period.

Edit Basal 1		
Start	End	U/hr
12:00 _A	8:00 _A	0.900
Review		

3. Press .

The start time for the next time period appears.

Edit Basal 1		
Start	End	U/hr
12:00 _A	8:00 _A	0.900
8:00 _A	8:30 _A	---
Review		

4. Enter the end time for the next time period.

Edit Basal 1		
Start	End	U/hr
12:00 _A	8:00 _A	0.900
8:00 _A	6:00 _P	---
Review		

5. Enter the unit value for the next time period.

Edit Basal 1		
Start	End	U/hr
12:00 _A	8:00 _A	0.900
8:00 _A	6:00 _P	0.650
Review		

6. Press .

The start time for the next time period appears.

Edit Basal 1		
Start	End	U/hr
12:00 _A	8:00 _A	0.900
8:00 _A	6:00 _P	0.650
6:00 _P	12:00 _A	---
Review		

- Repeat steps 3-5 for every desired time period until the end time of 12:00 A is reached. This completes the 24-hour duration.

Edit Basal 1		
Start	End	U/hr
12:00 _A	8:00 _A	0.900
8:00 _A	6:00 _P	0.650
6:00 _P	12:00 _A	0.900
Review		

- Select **Review**.

Edit Basal 1		
Start	End	U/hr
00:00	08:00	0.900
08:00	18:00	0.650
18:00	24:00	0.900
Review		

Review the basal pattern. Press  to return to the previous screen to make changes.





Note: If  is pressed and **Save** is not selected, the changes are not saved.

- Select **Save**.



Viewing basal delivery information

To view the current basal rate:

1. From the Home screen, press , and then select .
2. Select **Basal**.

The current basal rate appears at the top of the screen.

To view basal patterns:

1. From the Home screen, press , and then select .
2. Select **Basal**.
3. Select **Basal Patterns**.

The Basal Patterns screen shows a list of configured basal patterns and the 24-hour insulin total for each basal pattern. A check mark appears next to the active basal pattern.

4. To view details for a basal pattern, select the basal pattern.

For more information about basal patterns, see *Basal patterns*, page 89.

Suspending all insulin delivery and resuming basal insulin delivery

Use this feature to suspend all active basal and bolus insulin deliveries. A reminder that insulin is not being delivered occurs every 15 minutes while this feature is active. The pump beeps, vibrates, or both every 15 minutes as a reminder that insulin is not being delivered.



Note: The first reminder occurs 15 minutes after the pump display times out. The pump beeps, vibrates, or both 15 minutes after the pump display times out. If a button is pressed to wake up the pump, the pump beeps, vibrates, or both 15 minutes after the pump display times out again. To adjust the timeout setting, see *Display options*, page 207.

To continue basal insulin delivery, use the Resume Basal feature. The pump starts the programmed basal pattern but does not start any previously programmed bolus deliveries.



Note: To stop a bolus delivery without stopping the basal delivery, see *Stopping a bolus delivery*, page 112.





WARNING: If insulin delivery is suspended during a bolus, check the pump daily history to determine the amount of insulin that was delivered before resuming insulin delivery. Bolus delivery and fill cannula do not restart when insulin delivery is resumed. If needed, program a new bolus or fill the cannula. Failure to resume basal insulin delivery can result in hyperglycemia and diabetic ketoacidosis.



WARNING: Do not rely solely on the sound or vibration notifications when using the sound or vibrate options. These notifications may not occur as expected if the speaker or vibrator in the pump malfunctions. A missed notification may result in the delivery of too much or too little insulin. This is most common when using the Easy bolus feature or when the pump is in manual suspend. Contact 24-Hour Technical Support with any concerns.

To suspend all insulin delivery:



1. From the Home screen, press , and then select .
2. Select **Suspend All Delivery**.
3. Select **Yes** to suspend all insulin delivery.

The pump functions are limited until insulin delivery is resumed.

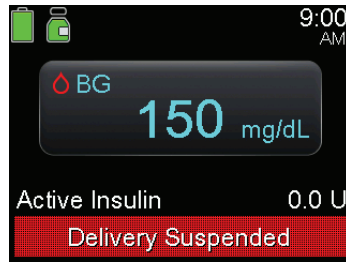
The Delivery Suspended banner appears on the Home screen while insulin is suspended.



To resume basal insulin delivery:

1. While insulin delivery is suspended, from the Home screen press , and then select .
2. Select **Resume Basal**.
A confirmation message appears.

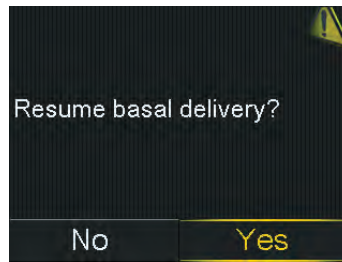

3. To resume basal insulin delivery, select **Yes**.
If a temp basal was active when the pump was suspended, it resumes, provided the time is still within the duration set.



Note: If a bolus delivery that was in progress before delivery was suspended is needed, check the Daily History screen for the actual bolus units delivered and the intended bolus amount. Then set up a new bolus amount as needed. For details about using the Daily History screen, see *Daily History screen, page 223*.

Temp basal rates

The temp basal feature helps set and start a temporary basal rate that can be used immediately to manage BG for short-term activities or conditions.



Preset temp basal rates can be set for recurring short term situations. For more information on Preset temp basal rates, see *Preset temp basal rates, page 243*. The duration of the temp basal rate can range from 30 minutes to 24 hours. After the temp basal rate delivery is completed or canceled, the programmed basal pattern resumes. The temp basal rates and preset temp basal rates can be defined using either a percentage of the current basal pattern or by setting a specific rate, as described in the following table:

Temp basal rate type	Description
Percent	Percent delivers a percentage of the basal rates programmed in the active basal pattern for the duration of the temp basal rate. The temp basal amount is rounded down to the next 0.025 units if the basal rate is set at less than 1 unit per hour, or to the next 0.05 units if the basal rate is set at more than 1 unit per hour. Temp basal rates can be set to deliver from 0% to 200% of the scheduled basal rate. The percentage used is based on the largest basal rate scheduled during the temp basal rate duration and is limited by the Max basal rate.
Rate	Rate delivers a fixed basal insulin rate in units per hour for the duration of the temp basal rate. The amount set is limited by the Max basal rate.

Starting a temp basal rate

When a temp basal rate starts, basal delivery changes to the temp basal rate for the set duration. When the duration completes, the basal insulin automatically returns to the active basal pattern.

To start a temp basal rate:

1. From the Home screen, press , and then select .
2. Select **Basal > Temp Basal**.
3. Set the **Duration**.

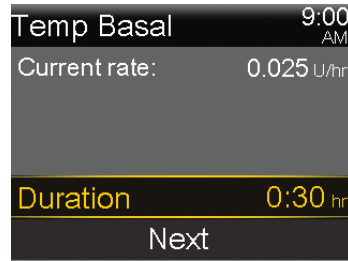

4. Select **Next**.
5. Select **Type** to select Rate or Percent.

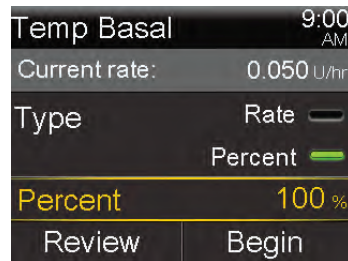

6. Depending on the type selected, do one of the following:
 - Enter a percentage.
 - Enter a basal rate.

Select **Review** to review the temp basal setting.

7. Select **Begin** to start the temp basal rate.



The Temp Basal banner appears on the Home screen during delivery.





Entering a blood glucose (BG) meter reading

The system may request a blood glucose (BG) meter reading to continue use. Additionally, a blood glucose (BG) meter reading can be entered at any time, if desired. The BG screen allows manual entry of a blood glucose (BG) meter reading. Previously entered manual or meter BG readings do not appear on the BG screen. A blood glucose (BG) meter reading received from a linked meter appears in a separate BG Meter screen that requires confirmation.

To manually enter blood glucose (BG) meter readings:

1. From the Home screen, press , and then select .
2. Enter a blood glucose (BG) meter reading. Do not enter a sensor glucose (SG) value in place of a blood glucose (BG) meter reading. A blood glucose (BG) meter reading must always come from a blood glucose meter. The entered glucose value is used to calibrate the sensor.
3. Select **Save**.



Note: A blood glucose (BG) meter reading can be entered on the Bolus Wizard screen or on the Bolus screen while using the SmartGuard feature. To enter a blood glucose (BG) meter reading on the Bolus Wizard screen, select **BG**. To enter a blood glucose (BG) meter reading on the Bolus screen while using the SmartGuard feature, press , and then press .

To confirm a blood glucose (BG) meter reading from a blood glucose meter:

When the BG Meter screen with the message Confirm BG? shows, select **Yes** to confirm the blood glucose (BG) meter reading.

The BG received message shows.

Setting up bolus delivery

A bolus is given for two reasons: to cover food that contains carbohydrates or to correct glucose levels that are above the target range.

About bolus deliveries

A bolus can be delivered using either the Manual bolus feature or the Bolus Wizard feature. Multiple types of bolus deliveries are also available, including normal bolus, Square Wave bolus, and Dual Wave bolus. The bolus type depends on individual insulin needs. Discuss these options with a healthcare professional to determine what is best. For details about the different types of bolus deliveries available, see *Bolus types*, page 253.



Note: Do not use a blood glucose (BG) meter reading if more than 12 minutes have passed since the last BG meter reading was taken. That BG meter reading and the calculated bolus amount may no longer be accurate.

Bolus delivery options

The following table describes how to deliver a bolus using the Bolus Wizard feature or Manual bolus feature. These bolus options are only available in Manual mode.

Delivery method	Description
Bolus Wizard feature	Enter the BG meter value or the amount of carbs expected from a meal, or both. Then the Bolus Wizard feature calculates an estimated bolus amount based on the individual settings. For details about using the Bolus Wizard feature, see <i>Bolus Wizard feature</i> , page 103.

Delivery method	Description
Manual bolus feature	Calculate and manually enter the bolus amount. For details about using the Manual bolus feature, see <i>Delivering a normal bolus using the Manual bolus feature</i> , page 111.



Max bolus

The Max bolus setting limits the amount of insulin that can be delivered in a single bolus. The pump prevents single bolus insulin deliveries that exceed the Max bolus amount. The Max bolus can be set from 0 to 25 units. Set the Max bolus as indicated by a healthcare professional.

If the Max bolus is set up after the preset bolus deliveries are set, the Max bolus cannot be set lower than any of the existing preset bolus amounts.

The Max bolus setting applies to boluses delivered in Manual mode and delivered with the SmartGuard feature.

To set the Max bolus:

1. From the Home screen, press , and then select .
2. Select **Delivery Settings > Max Basal/Bolus**.
The Max Basal/Bolus screen appears.



3. Select **Max Bolus**.

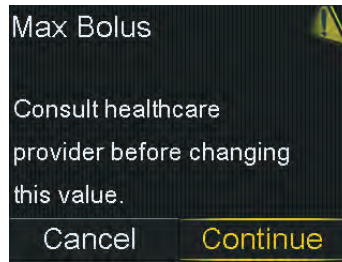

4. To continue to the Max Bolus screen, select **Continue**.
5. Select **Max Bolus**, and then set the maximum number of insulin units the pump can deliver in one bolus.

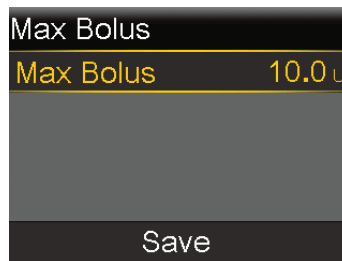

6. Select **Save**.

Bolus Wizard feature

The Bolus Wizard feature uses Bolus Wizard settings to calculate an estimated bolus amount based on the BG readings and carbs that are entered.

After the Bolus Wizard feature is set up, use a normal bolus to deliver a food bolus, a correction bolus, or a food plus correction bolus. For more information, see *Delivering a normal bolus with the Bolus Wizard feature*, page 109.

The Bolus Wizard feature can also be used to deliver a Dual Wave bolus or a Square Wave bolus. For more information, see *Bolus types*, page 253.

Bolus Wizard settings

To use the Bolus Wizard feature, consult a healthcare professional to determine the personal settings that should be used. The carb ratio, insulin sensitivity factor, BG target, and the active insulin time are needed to complete the setup. Always consult a

healthcare professional before changes are made to the Bolus Wizard settings. The setup procedure begins on *Setting up the Bolus Wizard feature, page 105*.



Setting	Description
Carb Ratio	The carb ratio setting is used for food bolus calculations. The number of carb grams that are covered by 1 unit of insulin.
Insulin Sensitivity Factor	The insulin sensitivity factor setting is used to calculate correction bolus amounts. The insulin sensitivity factor is the amount that BG is reduced by 1 unit of insulin.
BG Target	The Bolus Wizard feature calculates the estimated bolus based on the BG target range. The high and low values set are the values to which the BG is corrected. To use a single target value rather than a range, set the same value for the high and low value of the BG target. If the BG reading is above the high target value, a correction dose is calculated. If the BG reading is below the low target value, a negative correction is calculated and subtracted from the food bolus.
Active Insulin Time	Active insulin is the bolus insulin that has been delivered by the pump and is still working to lower glucose levels. In the Bolus Wizard and SmartGuard Bolus feature, the Active Insulin Time setting is used to calculate a correction bolus by subtracting the estimated active insulin from each bolus. In SmartGuard, auto correction boluses are delivered up to every 5 minutes. A shorter Active Insulin Time setting may result in more insulin being delivered in correction boluses. A healthcare professional provides the personalized active insulin time based on historic glycemic control data for the individual user. When using SmartGuard, the recommended initial setting is an Active Insulin Time of 2-3 hours. The Active Insulin Time setting in the MiniMed 780G system

Setting	Description
	is not necessarily reflective of the physiological insulin metabolism. Adjustments are not based on the pharmacokinetics and pharmacodynamics of the rapid-acting insulin. Please see <i>Table 7, page 364</i> and <i>Table 8, page 365</i> in <i>Performance data, page 357</i> for the effect of Active Insulin Time on glycemic outcomes. The current active insulin amount appears on the Home screen and includes only the bolus insulin received.

Setting up the Bolus Wizard feature

To use the Bolus Wizard feature to calculate a bolus, first turn on the Bolus Wizard feature and enter the Bolus Wizard settings. There are four settings needed to set up the Bolus Wizard. Each setting is shown using 1/4, 2/4, 3/4, and 4/4 on the screens.

To set up the Bolus Wizard feature:

1. From the Home screen, press , and then select .
2. Select **Delivery Settings > Bolus Wizard Setup**.

The Bolus Wizard Setup screen appears.

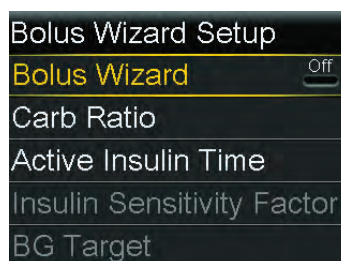

3. Select **Bolus Wizard** to turn on the feature.

If this is the first time the Bolus Wizard feature has been turned on, the following screen appears.

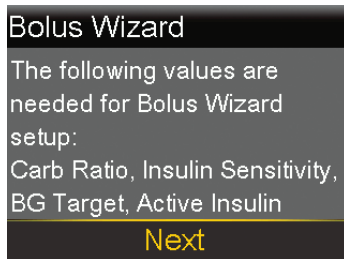

4. Confirm the values needed are ready to be entered, then select **Next**.
The Carb Ratio 1/4 screen appears.

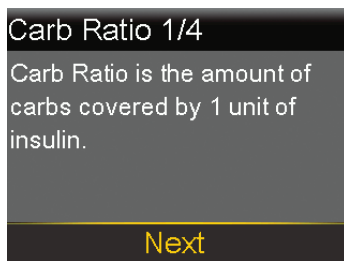

5. Select **Next**.
The Edit Carb Ratio 1/4 screen appears.



6. To enter one carb ratio, enter the g/U, and then press .



Note: For instructions on setting up more than one carb ratio over a 24-hour period, see *Settings covering a 24-hour period*, page 91.

7. Select **Next**.



Note: If the values are outside of the value range, a message asks to confirm the settings.

The Sensitivity 2/4 screen appears.

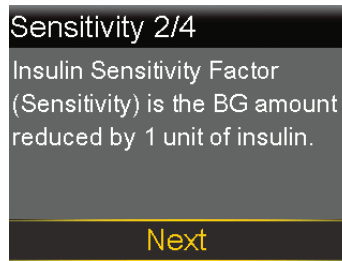

8. Select **Next**.

The Edit Sensitivity 2/4 screen appears.

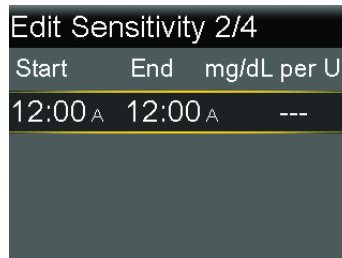

9. For one sensitivity factor, enter the mg/dL per U, and then press



Note: For instructions on setting up more than one sensitivity factor over a 24-hour period, see *Settings covering a 24-hour period*, page 91.

10. Select **Next**.

The BG Target 3/4 screen appears.

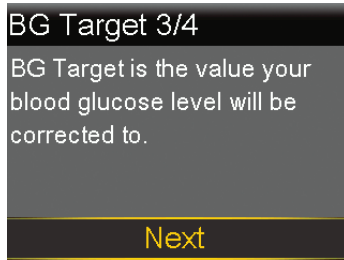

11. Select **Next**.

The Edit BG Target 3/4 screen appears.



12. For one BG target range, enter the Lo and Hi target, and then press .



Note: For instructions on setting up more than one BG target range over a 24-hour period, see *Settings covering a 24-hour period, page 91*.

13. Select **Next**.

The Active Insulin Time 4/4 screen appears.

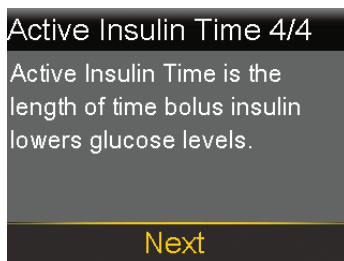

14. Select **Next**.

The Active Insulin Time 4/4 screen appears.

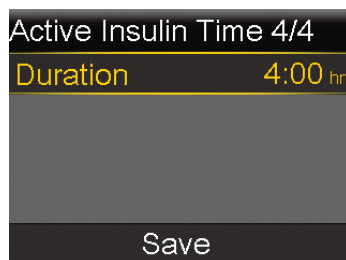



15. Enter the **Duration** of the active insulin time, and then press .
16. Select **Save**.

The Bolus Wizard feature setup is now complete.

Turning the Bolus Wizard feature off

The Bolus Wizard feature can be turned off at any time. The Bolus Wizard settings remain in the pump. When the Bolus Wizard feature is turned off, the Bolus Wizard menu selection does not appear on the Bolus screen, and the insulin sensitivity factor or BG target settings can not be edited on the Bolus Wizard Setup screen.

To turn the Bolus Wizard feature off:

1. From the Home screen, press , and then select .
2. Select **Delivery Settings > Bolus Wizard Setup**.
3. Select **Bolus Wizard** to turn the feature off.

Normal bolus

A normal bolus provides a single immediate dose of insulin. Use a normal bolus to cover food intake or to correct a high BG meter reading.



Note: The pump can deliver a normal bolus while a Square Wave bolus or the Square portion of a Dual Wave bolus is being delivered.

Delivering a normal bolus with the Bolus Wizard feature

The Bolus Wizard screen shows the most recent BG reading, if available. The table indicates the different ways that the Bolus Wizard screen shows the BG reading.

Bolus Wizard screen

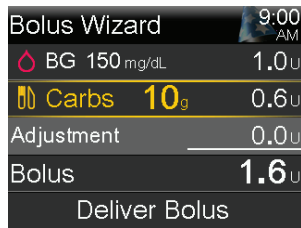

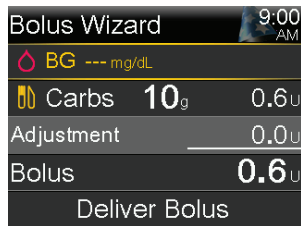

Glucose reading information

The  icon indicates that a recent blood glucose (BG) meter reading is used by the Bolus Wizard feature to calculate a correction bolus. DO NOT enter a sensor glucose (SG) value in place of a blood glucose (BG) meter reading.



The BG appears as dashes when no BG is available for the Bolus Wizard feature to calculate a correction bolus.

To deliver a normal bolus using the Bolus Wizard feature:

1. From the Home screen, press , and then select .
2. Select **Bolus > Bolus Wizard**.

The Bolus Wizard screen appears.

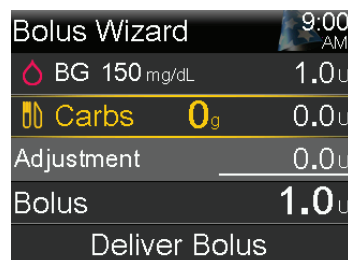

3. For a correction bolus or a food bolus with a correction, use a blood glucose (BG) meter for a blood glucose (BG) meter reading. Do not enter a sensor glucose (SG) value in place of a blood glucose (BG) meter reading. A blood glucose (BG) meter reading must always come from a blood glucose meter. The entered glucose value is used to calibrate the sensor.



Note: A blood glucose (BG) meter reading can be entered on the Bolus Wizard screen. On the Bolus Wizard screen, select **BG**.

- For a food bolus, select **Carbs** to enter the carb count of the meal. For a correction bolus where no food was eaten, leave the carbs value at 0.

The calculated bolus appears in the Bolus field.

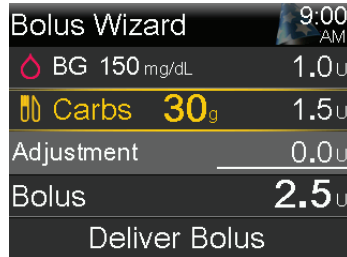

- If a change to the bolus amount is needed, select **Bolus** and modify the bolus amount.

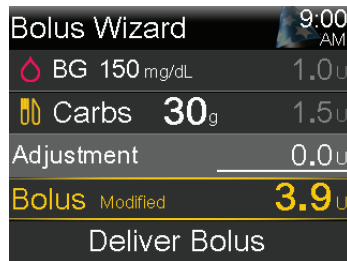



- Select **Deliver Bolus** to start the bolus.

The pump beeps or vibrates and a message appears when the bolus starts. The Home screen shows the bolus amount as it is being delivered. The pump beeps or vibrates when bolus delivery is complete.

Delivering a normal bolus using the Manual bolus feature

The following procedure describes how to deliver a normal bolus using the Manual bolus feature.

To deliver a normal bolus using the Manual bolus feature:

- From the Home screen, press , and then select .
- Do one of the following:

- Select **Bolus** if the Bolus Wizard feature is turned off.
- Select **Bolus > Manual Bolus** if the Bolus Wizard feature is turned on.

The Manual Bolus screen appears.

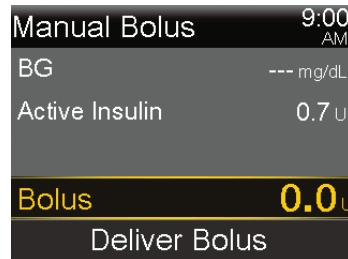



3. Select **Bolus** to set the bolus delivery amount in units.
4. Select **Deliver Bolus** to start the bolus.



Stopping a bolus delivery

These procedures describe how to stop a bolus.





WARNING: Always press , select , and then select **Stop Bolus** to stop bolus insulin delivery. Do not use the Suspend All Delivery feature to stop bolus insulin. The Suspend All Delivery feature stops both basal insulin and bolus insulin delivery. Failure to resume basal insulin delivery could result in too little insulin, which may cause high BG.



Note: To stop all insulin delivery, use the Suspend All Delivery feature (press , select , and then select **Suspend All Delivery**). For more information on using the Suspend All Delivery feature, see *Suspending all insulin delivery and resuming basal insulin delivery*, page 95.

To stop a bolus delivery:

1. While the pump delivers a bolus, press  and then select .
The Insulin menu appears.

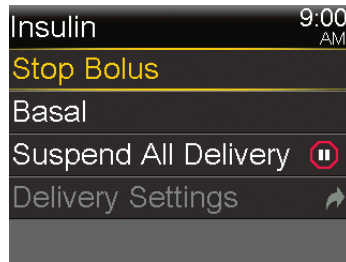

2. Select **Stop Bolus**.

A message appears confirming if bolus delivery should be stopped.

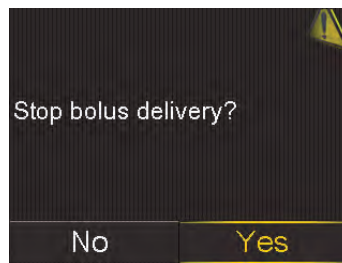

3. Select **Yes** to confirm.

The Bolus Stopped screen appears and shows the amount of bolus delivered, and the original bolus amount set up.



4. Select **Done**.



Note: The delivered amount can be viewed in the insulin delivery history screen after the procedure is closed. For more information, see *Daily History screen, page 223*.

5



Reservoir and infusion set

5

Reservoir and infusion set

The pump has options to change the reservoir and infusion set, reservoir only, or infusion set only. This chapter provides information about setting up the reservoir and infusion set with the Reservoir & Set option.

If the reservoir runs out of insulin and the infusion set has not been used for the duration of use indicated for the infusion set, the New Reservoir Only option may be used to change the reservoir. If only the infusion set needs to be changed, the New Set Only option may be used to change the infusion set.

Refer to the infusion set user guide for the duration of use indicated for the infusion set. Refer to the reservoir user guide for the duration of use indicated for the reservoir.

Do not begin the steps to replace the reservoir and infusion set until training has been received.



WARNING: Always confirm that the infusion set tubing is disconnected from the body before doing the following steps:

- placing the reservoir into the pump
- rewinding the pump
- loading the reservoir
- filling the infusion set tubing

Failing to disconnect the infusion set tubing from the body may result in an accidental infusion of insulin, and may cause hypoglycemia.

Setting up the reservoir and infusion set

Confirm that the time and date on the pump are correct before insulin is used with the pump for the first time. For information about how to change the time and date on the pump, see *Time and date*, page 207. Consult a healthcare professional to determine the appropriate pump settings before insulin is used with the pump.

The following items are needed:

- MiniMed 780G insulin pump
- vial of rapid-acting U-100 insulin
- MiniMed or Medtronic reservoir
- MiniMed or Medtronic infusion set and its user guide



WARNING: Do not use the pump to deliver insulin for the first time until the active insulin has been cleared. If the pump has been used for training with bolus delivery before insulin is used, the active insulin value may be inaccurate. This may result in inaccurate insulin delivery, and serious injury. For details, see *Clearing the active insulin*, page 213.



Note: Different infusion sets may have different instructions for insertion into the body. All the procedures in the sections within this chapter must be followed in order to change the reservoir and infusion set.

Removing the reservoir and rewinding the pump

If this is the first time a reservoir is inserted into the pump, proceed to the pump rewind instructions. For more information about the reservoir see the reservoir user guide.



WARNING: Always confirm that the infusion set is disconnected from the body before rewinding the pump or filling the infusion set tubing. Never insert the reservoir into the pump while the tubing is connected to the body. Doing so may result in an unintentional infusion of insulin, and may cause hypoglycemia.

When the pump rewinds, the piston in the reservoir compartment returns to its starting position and allows a new reservoir to be placed into the pump.

The piston is located in the reservoir compartment of the pump. It engages the reservoir and pushes insulin through the tubing.

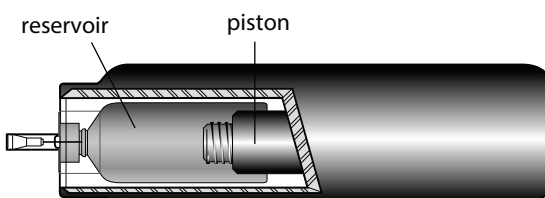

Start here:

1. Wash hands with soap and water. On the pump, press  to go to the Menu screen.

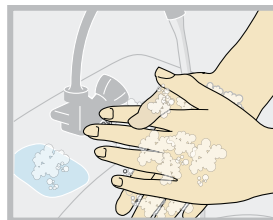

2. Select , and then select **New Reservoir & Set**.

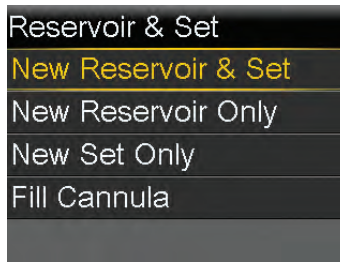

3. Remove the infusion set by loosening the adhesive and pulling the set away from the body. Select **Next**.

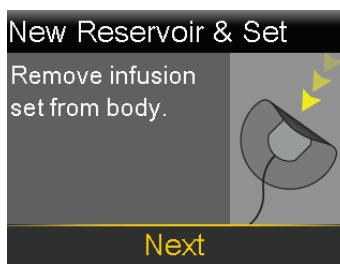

Note: For instructions on how to remove the infusion set from the body refer to the user guide that came with the infusion set.

4. If the optional activity guard is attached to the reservoir compartment on the pump, remove it now.
5. Remove the used reservoir from the pump.

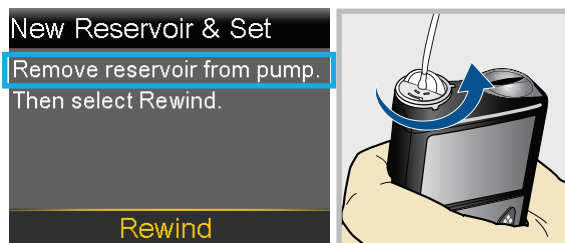

6. Dispose of the used reservoir and infusion set per the disposal information in the corresponding user guide.
7. Select **Rewind**.

Do not connect the infusion set to the body.

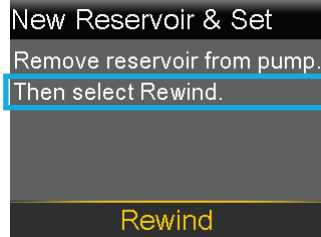

WARNING: Always confirm that the infusion set is disconnected from the body before rewinding the pump. Failing to disconnect the infusion set from the body may result in an accidental infusion of insulin, and may cause hypoglycemia.



8. Follow the next steps to fill the new reservoir with insulin and to connect the infusion set tubing.

Do not select **Next**.

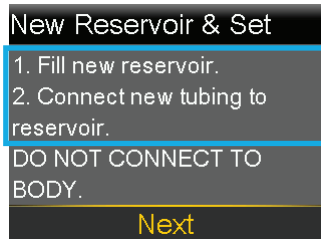

Filling the reservoir and connecting it to the infusion set tubing



WARNING: Always allow the insulin to reach room temperature before use. Cold insulin may cause air bubbles in the reservoir and tubing, which may result in inaccurate insulin delivery.

The following procedures must be performed in the order presented.

To fill the reservoir and connect it to the infusion set tubing:

1. Remove the reservoir from the package. Make sure the insulin vial is at room temperature to reduce the risk of air bubbles.

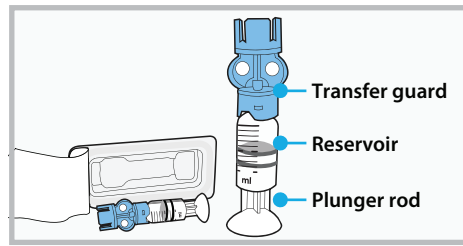

2. Pull the plunger down based on the planned insulin fill amount for the duration of use indicated for the reservoir.

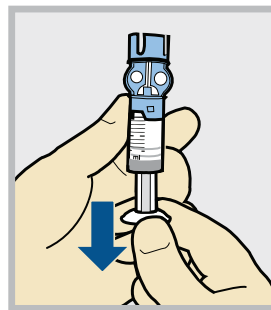

3. Wipe the top of the vial with alcohol. Place the vial on a sturdy flat surface. Firmly press the transfer guard onto the vial.

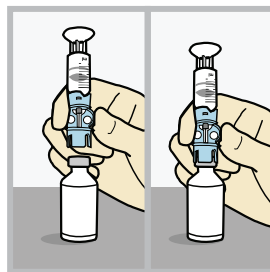

4. Push and hold the plunger down.

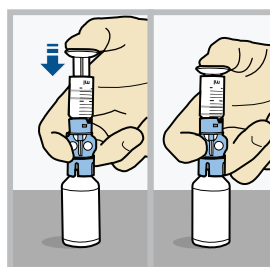

WARNING: Do not use the reservoir or infusion set if insulin or any liquid gets on the top of the reservoir or inside the tubing connector, as shown in the image. Insulin or any liquid may temporarily block the vents. This may result in the delivery of too little or too much insulin, which may cause hyperglycemia or hypoglycemia. If insulin or any liquid gets on the top of the reservoir or inside the tubing connector, start over with a new reservoir and infusion set.

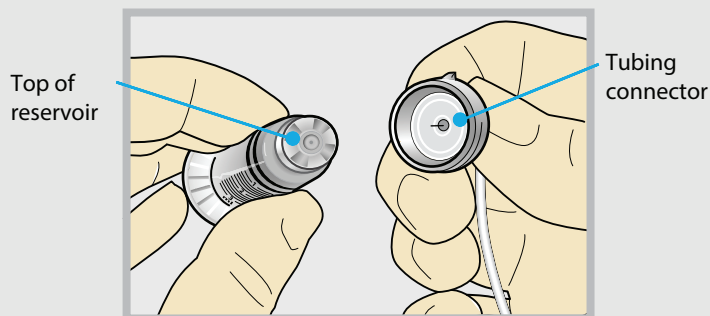

5. Keeping a thumb on the plunger, flip the vial over so the vial is on top. Release the thumb and pull the plunger down to fill the reservoir with insulin.

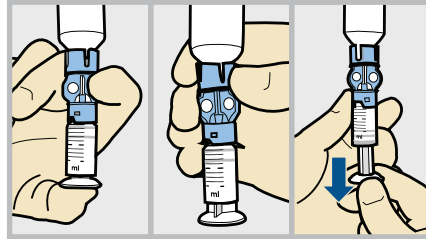

6. Tap the reservoir to move air bubbles to top of reservoir. Push the plunger up to move air into vial.

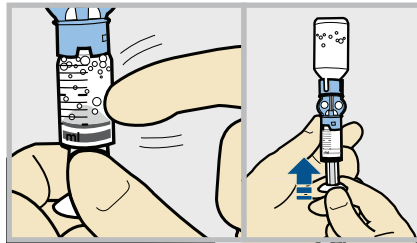

7. Pull the plunger back down to allow the reservoir to fill with the amount of insulin needed for the duration of use indicated for the reservoir.

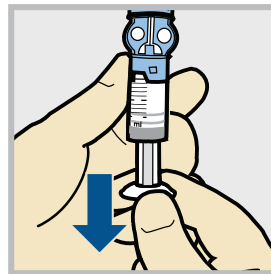

8. To avoid getting insulin on the top of the reservoir, **flip the vial over again so the reservoir is on top**. Hold the transfer guard and turn the reservoir counter-clockwise and remove the reservoir from the transfer guard.

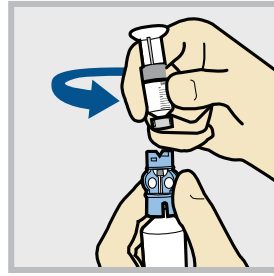

9. Follow the instructions in the infusion set user guide to access the infusion set tubing.
10. Gently push the tubing connector onto the reservoir. Turn the connector clockwise until it is locked into place.

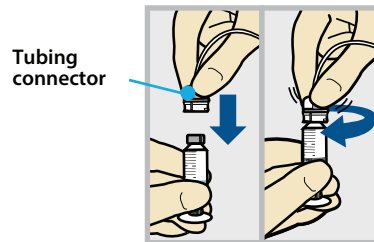

11. Tap the reservoir to move any air bubbles to the top. Push the plunger slightly to move the bubbles into the tubing.

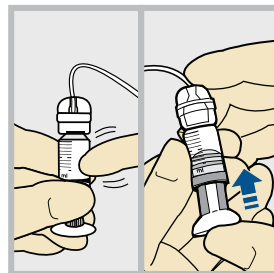

12. Twist the plunger counter-clockwise to loosen it and to remove it.

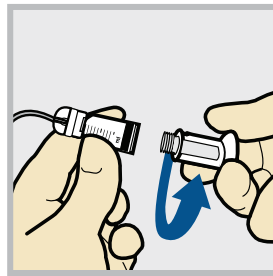



Placing the reservoir into the pump and filling the tubing with insulin



WARNING: Always rewind the pump before placing a new reservoir. Failing to rewind the pump may result in an unintentional infusion of insulin, which may cause hypoglycemia.

To place the reservoir into the pump and fill the tubing with insulin:



Note: The backlight may have turned off. Press any button to turn the screen back on. Press  to go to the Menu screen, and then select .

1. Select **Next**.

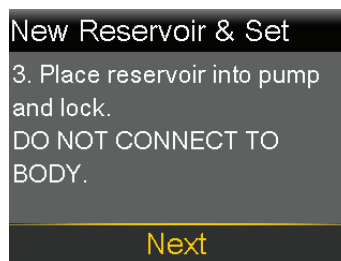

2. Place the reservoir into the pump.
Do not connect the infusion set to the body.

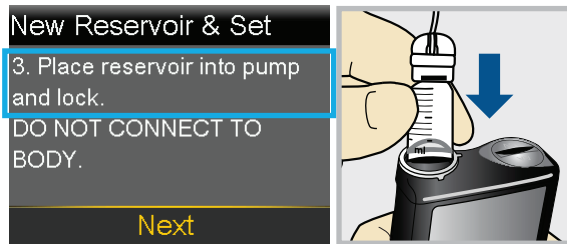

WARNING: Always confirm that the infusion set is disconnected from the body before placing the reservoir into the pump. Failing to disconnect the infusion set from the body may result in an accidental infusion of insulin, and may cause hypoglycemia.

- Turn the reservoir clockwise until the reservoir locks into place, and select **Next**.

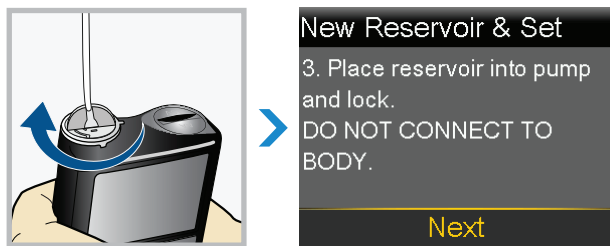

- Select **Load** and hold  until the checkmark appears on the screen.

Do not connect the infusion set to the body.



- When the checkmark appears, select **Next**.



WARNING: Always confirm that the infusion set is disconnected from the body before loading the reservoir and filling the tubing. Failing to disconnect the infusion set from the body may result in an accidental infusion of insulin, and may cause hypoglycemia.

6. Select **Fill** and keep holding  until there are no air bubbles visible in the tubing, and there are drops at the end of the tubing.

Do not connect the infusion set to the body.

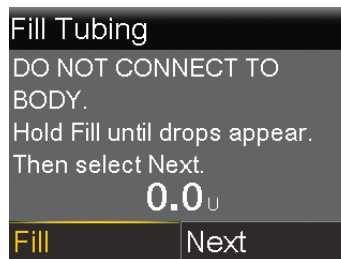

WARNING: Always check the tubing for air bubbles. Continue to press Fill until no bubbles remain in the tubing. Air bubbles may result in inaccurate insulin delivery.

7. After drops appear, press  and select **Next**.



Note: The location of the infusion set needle may be different depending on the type of infusion set being used.

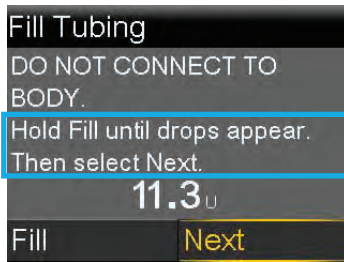

8. Follow the steps in the infusion set user guide to insert the infusion set into the body before proceeding with the steps on the pump screen.

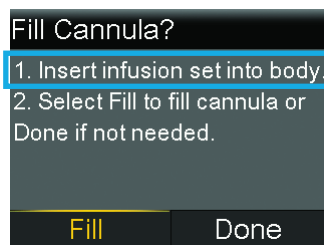

Note: If an infusion set with a steel cannula is used, the cannula does not need to be filled, and **Done** may be selected.

Inserting the infusion set into the body

Always refer to the infusion set user guide and the sarter user guide, if needed, for instructions about how to insert an infusion set into the body.



WARNING: Do not remove the reservoir from the pump while the infusion set is connected to the body. Doing so may result in the delivery of too little or too much insulin, which may cause hyperglycemia or hypoglycemia.

Choose an insertion site from the shaded areas shown here. Wipe the site with alcohol or other antiseptic.

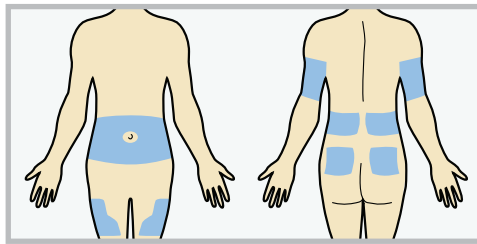

CAUTION: Do not use the same infusion set insertion site for an extended period of time. This may cause the site to become overused. Rotate the infusion set insertion sites regularly.



CAUTION: Always change the infusion set as indicated by the infusion set user guide. Using the same infusion set for an extended period of time beyond its product labeling can cause infusion set occlusion or site infection.

After the infusion set is inserted into the body follow the steps in the following section to fill the cannula.

Filling the cannula

Filling the soft cannula with insulin is required after the infusion set is inserted into the body and the introducer needle is pulled out. The insulin amount required to fill the cannula depends on the type of infusion set used. Refer to the user guide that came with the infusion set for more information.



Note: The Fill Cannula action is not required during a reservoir only change. If performing a reservoir only change, select **Done** on the **Fill Cannula?** screen.



WARNING: Never leave the pump on the Fill Cannula? screen. Insulin delivery is suspended while on the Fill Cannula? screen. Always finish filling the cannula or return to the Home screen, to avoid continued insulin delivery suspension. Prolonged suspension of insulin delivery may cause hyperglycemia.

To fill the cannula:

1. After the infusion set is inserted into the body, select **Fill**.

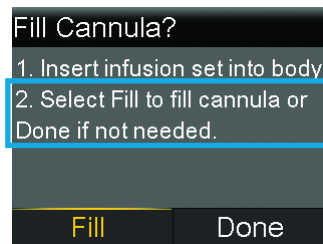

Note: Always verify that the amount shown in the **Fill amount** field is correct. The pump will remember the fill amount last used. Change the **Fill amount** if needed.

- If the Fill amount is correct, press \checkmark to select **Fill Now** and then press \odot .
- If the Fill amount is incorrect, press \odot . Change to the correct amount and press \odot . Then select **Fill Now**.

2. Select **Fill amount** and enter the amount per the infusion set user guide. After entering the cannula size, press \odot .



3. Select **Fill Now**.

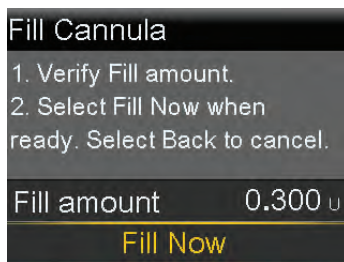

The Home screen displays the insulin amount as insulin fills the cannula.

The reservoir and infusion set change is now complete.

Always check blood glucose (BG) using a blood glucose meter one to three hours after changing the infusion set or reservoir.

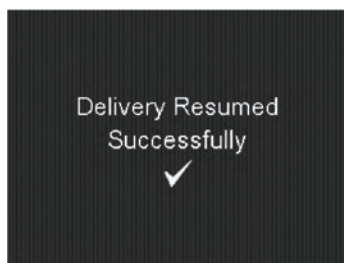

Note: Use the following procedure only when it is necessary to stop filling the cannula.

To stop filling the cannula:

1. Select **Stop Filling** to stop filling the cannula.

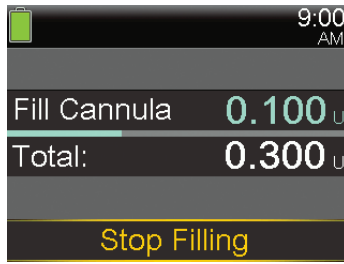

2. Select **Yes**.

The Fill Stopped screen appears.

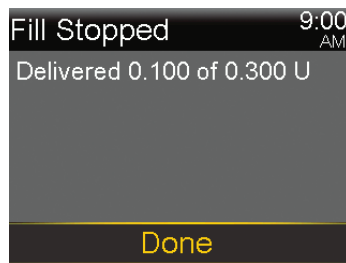

3. Select **Done**.

Disconnecting the infusion set

Refer to the infusion set user guide for instructions on how to disconnect the infusion set.

Reconnecting the infusion set

Refer to the infusion set user guide for instructions on how to reconnect the infusion set.

6



Paired devices

6

Paired devices

This chapter explains how to pair the MiniMed 780G insulin pump with compatible devices.

Setting up the Accu-Chek™* Guide Link meter

The MiniMed 780G insulin pump with smart device connectivity can pair only with an Accu-Chek™* Guide Link meter to automatically receive blood glucose (BG) meter readings. If the Accu-Chek™* Guide Link meter is not paired with the pump, enter BG readings manually. The pump beeps, vibrates, or simultaneously beeps and vibrates when the pump receives a BG reading. Confirm the BG reading and deliver a bolus, if necessary. If a BG reading is not confirmed within 12 minutes, the BG will not be stored. If the BG reading is outside the range of 70 mg/dL to 250 mg/dL, an alert appears. Follow instructions from a healthcare professional to treat low BG or high BG.

To pair the pump and meter, use the following items:

- MiniMed 780G insulin pump with smart device connectivity
- Accu-Chek™* Guide Link meter

Pairing the pump and meter

The MiniMed 780G insulin pump with smart device connectivity can pair with up to four Accu-Chek™* Guide Link meters.

To prepare the meter to pair with the pump:

1. Press the **OK** button on the meter to turn on the meter.

2. Select **Settings**.

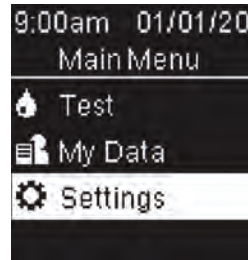

3. Select **Wireless**.

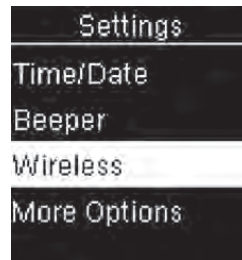

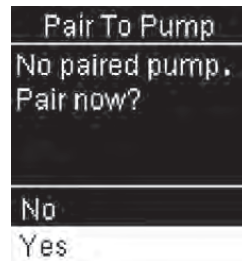

4. Select **Yes** if the confirmation screen appears on the meter screen. Or, if the confirmation screen does not appear, select **Pairing**.



The meter serial number appears on the meter screen. The meter is now ready to pair with the pump.

To prepare the pump to pair with the meter:

1. From the Home screen, press , and then select .
2. Select **Pair New Device**.

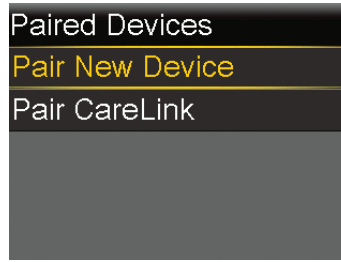

The Searching... screen appears. After the pump is done searching, the Select Device screen appears.

3. Select the meter that matches the serial number that displays on the meter screen.

If the correct serial number does not appear, select **Search Again**.



If the connection is successful, a "Pairing successful!" message appears on the pump. A "Paired with pump" message with the serial number of the pump appears on the meter screen. If a Device not found alert appears, see *Pump alarms, alerts, and messages, page 299* for more information.

Pairing the pump and transmitter



The pump and transmitter must be paired to use the sensor. When paired, the pump and transmitter communicate with each other through a wireless connection. Only one transmitter can be paired with the pump. If a transmitter is already paired with the pump, delete the transmitter, and then continue. For instructions on how to delete a transmitter from the pump, see *Unpairing the transmitter from the pump, page 294*.

To pair the pump and transmitter:

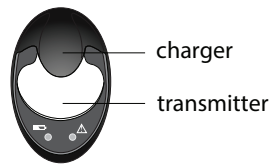
1. Attach the transmitter to the charger. Fully charge the transmitter. Keep the transmitter attached to the charger.



Note: Both lights on the charger are off when the transmitter is fully charged. For more information, see the transmitter user guide.

2. From the Home screen, press , and then select .
3. Place the transmitter (still attached to the charger) next to the pump.

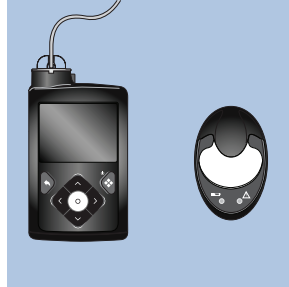

4. Select **Pair New Device** and immediately remove the transmitter from the charger.

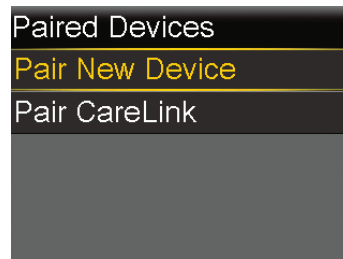

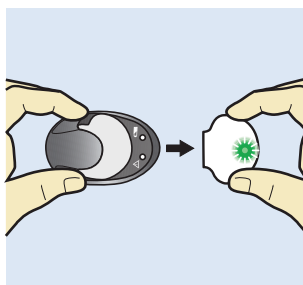

The following events happen when the search process starts:

- On the pump, the Searching... screen appears.
- On the transmitter, the light flashes 10 times and turns off.



Note: The search process can take up to 20 seconds.

The Select Device screen appears with a list of available devices.

5. Select the CGM device that matches the serial number indicated on the back of the transmitter.

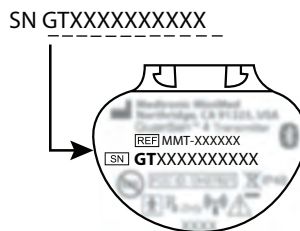

If the correct serial number does not appear, select **Search Again**.

If the connection is successful, a “Pairing successful!” message appears on the pump. When the transmitter is communicating with the pump, the Sensor feature is turned on and  appears on the Home screen. For information on using the sensor with the transmitter, see *Connecting the transmitter to the sensor, page 169*. If a Device not found alert appears, see *Pump alarms, alerts, and messages, page 299* for more information.



MiniMed Mobile app

The MiniMed Mobile app is an optional accessory that is compatible with the MiniMed 780G system. The app provides a secondary display that allows the user to view CGM and pump data. A compatible smartphone is required for the app to function. The app is available for both iOS™* and Android™* platforms. Consult the MiniMed Mobile app user guide for installation instructions.

Uploading device data to CareLink software

Upload system data to CareLink software with the MiniMed Mobile app or the Blue Adapter. Follow the instructions found on the CareLink software to upload system data with the Blue Adapter. Refer to the MiniMed Mobile app user guide for instructions to upload MiniMed 780G system data to CareLink software with the app.

To prepare the pump to upload to CareLink software:

1. From the Home screen, press , and then select .
2. Select **Pair CareLink**.

Follow instructions on the CareLink uploader to complete steps.

Sharing device data with the CareLink Connect app

The CareLink Connect app works with CareLink software. Through the CareLink Connect app, care partners can see information sent from a connected MiniMed Mobile app. A compatible smartphone is required for the app to function. The app is available for both iOS™* and Android™* platforms.

For more information about sharing data with the CareLink Connect app, see the MiniMed Mobile app user guide and the CareLink Connect app user guide.

Medtronic Diabetes Updater app

After an eligibility message for a pump software update is received, use the Medtronic Diabetes Updater app to perform the pump software update. The app provides instructions for each step of the process. Follow the instructions provided on the app screens to perform the update.



CAUTION: A stable internet connection is required throughout the entire update process. Avoid the use of unsecure Wi-Fi™* networks or public Wi-Fi™* hotspots.

Downloading the pump software update

After logging in and confirming the update is available, follow the instructions on the Updater app to download the pump software update. The Software is Ready screen appears on the Updater app when the download is complete.

Preparing to install the pump software update

To prepare to install the pump software update:



Note: After installation is complete, the SmartGuard feature requires a 5-hour warm-up period before it is active.

- Ensure glucose is within target before starting the update.
- Clear active alerts or alarms.
- If the pump is Suspended on low or Suspended before low, wait until insulin delivery resumes and BG recovers before starting the update.
- If a bolus delivery is in progress, wait until the bolus delivery completes before installing the pump software update.
- If the battery is low, the pump software update will not install. If the battery icon is not green, replace the battery before installing the pump software update.
- Insulin is not delivered and sensor glucose (SG) values are not shown for up to 20 minutes during the pump software installation. Manual injections are not

accounted for in the active insulin amount. If an injection is needed during the software update, consult a healthcare professional for how long to wait after a manual injection before using the Bolus Wizard feature. Refer to *Emergency kit*, page 31 for necessary supplies to use for backup insulin delivery if needed.

Installing the pump software update

1. When instructed by the Updater app, go to the Home screen on the pump. On the pump, a screen appears when the pump is ready for the software update.
2. Select **Continue**.

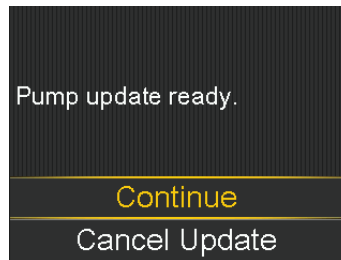

3. Select **Suspend Delivery** to suspend bolus and basal insulin delivery.

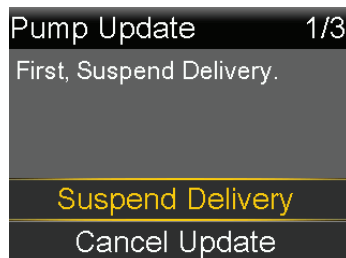

4. Disconnect the infusion set from the body, and then select **Confirm**.

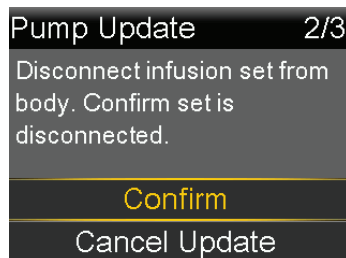

5. Select **Start Update**.

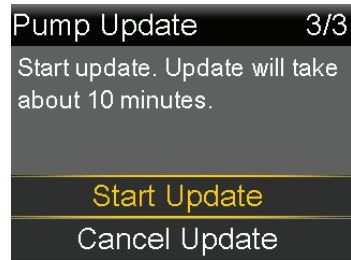

While the pump updates, a screen shows the progress.

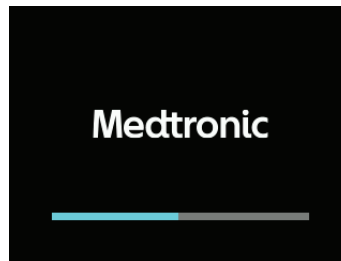

6. Select **Continue**.

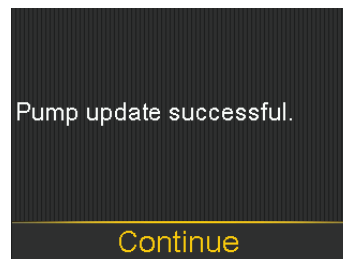

7. Reconnect the infusion set to the body.
8. Select **Yes** to resume basal insulin delivery.

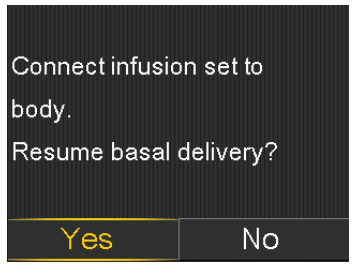

Note: The previous version of the software is retained if the update is not successful.

Completing the pump software update

Follow the instructions on the Updater app to complete the pump software update.

Continuous glucose monitoring with Guardian sensor (3)



7

Continuous glucose monitoring with Guardian sensor (3)

This chapter explains how to enter sensor settings and set up continuous glucose monitoring (CGM). CGM requires these items:

- MiniMed 780G insulin pump
- Sensor glucose (SG) settings provided by a healthcare professional
- Guardian Sensor (3) sensor
- Guardian Link (3) transmitter

CGM overview

CGM is an SG monitoring tool that uses a glucose sensor to continuously measure the amount of glucose in interstitial fluid. CGM helps manage blood glucose in these ways:

- It tracks and displays SG readings throughout the day and night.
- It shows the effects that diet, exercise, and medication can have on glucose levels.
- It provides additional tools, such as alerts, to help prevent high and low glucose levels.
- It measures glucose in the interstitial fluid, while a meter measures glucose in the blood. SG readings and meter readings may not be the same.



WARNING: Do not use SG values to make treatment decisions, including delivering a bolus, while the pump is in Manual mode. When the SmartGuard feature is active and you are no longer in Manual mode, the pump uses an SG value, when available, to calculate a bolus amount. However, if your symptoms do not match the SG value, use a BG meter to confirm the SG value. Failure to confirm glucose levels when your symptoms do not match the SG value can result in the infusion of too much or too little insulin, which may cause hypoglycemia or hyperglycemia. For more information on using the SmartGuard feature, see *SmartGuard*, page 181.

What is blood glucose (BG) and sensor glucose (SG)?

Blood glucose and sensor glucose are measured in different places. It is important to understand the differences between the two, as there are times when the system requires you to enter a blood glucose and there are other times when the system will use a sensor glucose.

Glucose travels between the blood and interstitial fluid. The glucose meter measures glucose levels in your blood. The glucose sensor measures glucose in the interstitial fluid. Blood glucose (BG) meter readings and sensor glucose (SG) readings will be close but will rarely exactly match. This difference is normal and should be expected.

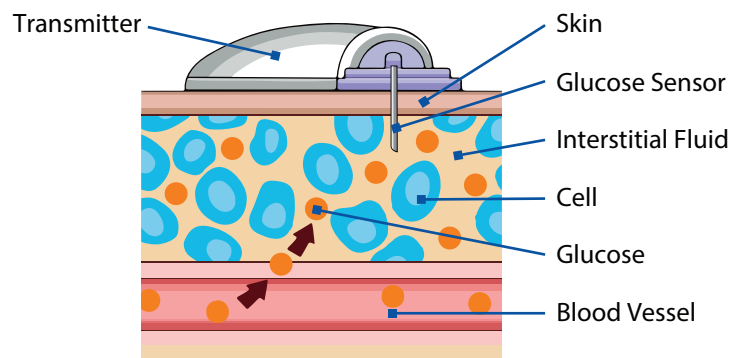

IMPORTANT: When a glucose value is entered into the pump, it must be from a blood glucose (BG) meter.

The system automatically uses the entered glucose value to calibrate the sensor, unless the system gives you the option to calibrate the sensor.

The following table shows when to use a blood glucose (BG) meter reading:

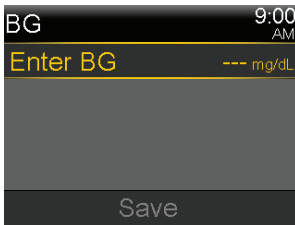
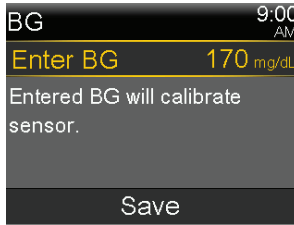
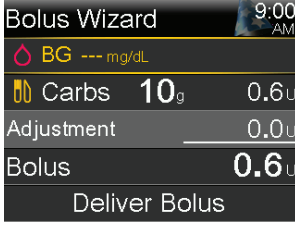
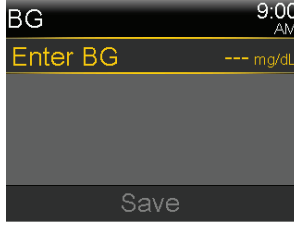
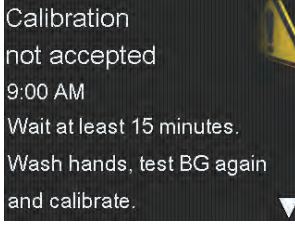
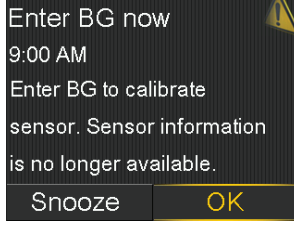
When to use a BG	Examples	
Anytime glucose is entered into the pump, it needs to be a blood glucose (BG) meter reading, not a sensor glucose (SG) value.	Enter BG screen without CGM 	Enter BG screen with CGM 
Anytime you deliver a bolus in Manual Mode and you want to use a glucose for a correction.		
Anytime the system requests a blood glucose (BG) meter reading.		



Note: See when to use a blood glucose (BG) meter reading when SmartGuard is active in *Entering a BG value in the SmartGuard feature*, page 191.

Calibrating the sensor

Calibration is the process of using a blood glucose (BG) meter reading to help the sensor glucose (SG) readings more closely match the glucose measured in your blood. For more information, see *When to enter a BG reading for calibration*, page 171.

When you are using the MiniMed 780G system with the Guardian Sensor (3) Sensor CGM, you will need to calibrate from time to time, when the system requests it. Anytime you enter a blood glucose (BG) meter reading into the pump, the system uses it to calibrate the sensor.

Home screen with CGM in Manual mode

When the Sensor feature is active, the Home screen displays a real-time graph that shows SG information.



Note: To see the Home screen while the SmartGuard feature is active, see *Home screen with the SmartGuard feature, page 189*.

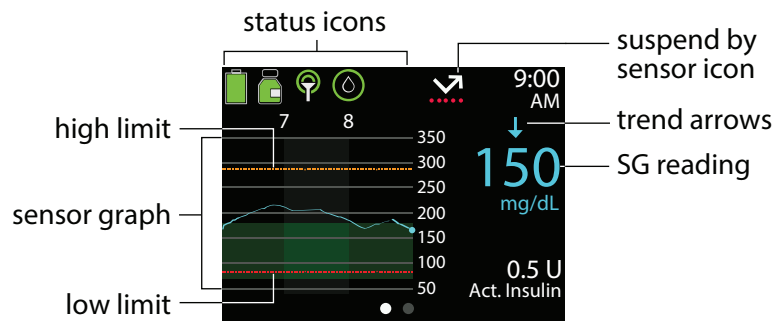

For more information about the icons that appear on the Home screen with CGM in Manual mode, see *Status icons, page 78*.

Trend arrows

The trend graph indicates how sensor glucose (SG) may have recently changed. The trend arrows indicate the rate at which the most recent SG readings are rising or falling. SG readings may trend up or down during certain activities, such as eating, giving a bolus, or when exercising. These icons appear only when the sensor feature is turned on.

- **↑** or **↓**: SG has been rising or falling at a rate of 20 to 40 mg/dL over the last 20 minutes, or 1 to 2 mg/dL per minute.

- **↑↑** or **↓↓**: SG has been rising or falling at a rate of 40 to 60 mg/dL over the last 20 minutes, or 2 to 3 mg/dL per minute.
- **↑↑↑** or **↓↓↓**: SG has been rising or falling at a rate of more than 60 mg/dL over the last 20 minutes, or more than 3 mg/dL per minute.

SG alert settings

An SG alert occurs when an SG reading changes at a particular rate, reaches a specified high or low limit, or before a high or low limit is reached. The pump can also be set to suspend insulin delivery before or when a low limit is reached.

High SG settings

High SG settings provide alerts under the following conditions:

- When SG rises rapidly (Rise Alert).
- When SG approaches the high limit (Alert before high).
- When SG reaches the high limit (Alert on high).

The following graph shows the types of high SG settings.



High SG alert settings

High glucose setting	Description
High limit	The high limit is used as a basis for some high SG settings. The high limit can be set from 100 to 400 mg/dL, for up to eight different time segments.
Alert before high	This setting provides an alert when SG is predicted to reach the high limit, raising awareness of potential high SG.
Time before high	This setting determines how long an Alert before high occurs before the high limit may be reached. It can be set between 5 and 30 minutes.
Alert on high	This setting provides an alert when SG reaches or exceeds the high limit.
High SG alert	This setting provides an alert when SG is at 250 mg/dL or higher for 3 hours. This is a fixed setting and cannot be changed.
Rise Alert	<p>This setting provides an alert when glucose is rising rapidly, such as after a meal or if a bolus is missed. Set the rise rates to match the trend arrows, as shown below, or to a custom rise rate.</p> <ul style="list-style-type: none"> • ↑ - SG is rising at a rate of 1 mg/dL per minute or more. • ↑↑ - SG is rising at a rate of 2 mg/dL per minute or more. • ↑↑↑ - SG is rising at a rate of 3 mg/dL per minute or more. • Custom - SG is rising at a custom rate, set from 1.0 mg/dL to 5.0 mg/dL per minute.
Rise Limit	This setting determines when a Rise Alert occurs.

To set up high SG settings, turn the sensor on and then see *Setting up the High SG settings, page 162*.

Low SG settings

Low SG settings alert or suspend insulin delivery when SG either approaches or reaches the low limit.



Note: The MiniMed Mobile app may be used to view the sensor graph on a mobile device. Always read and acknowledge all alarms and alerts on the pump. If the pump simultaneously generates more than one alarm or alert, only one of the alarms or alerts appears on the mobile device.

The following graph shows the available low SG settings.

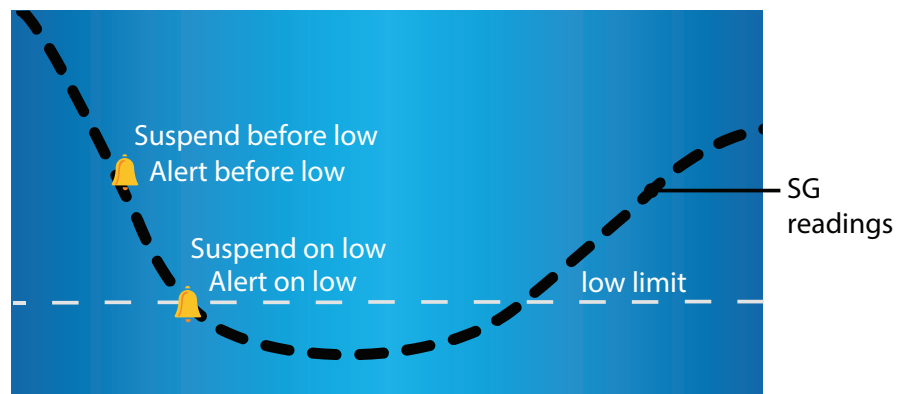

Low SG alert and suspend settings



WARNING: The Suspend before low and Suspend on low features are not intended to treat low BG. Suspending insulin delivery when SG is low may not bring BG back to the target range for several hours, which may cause hypoglycemia. Confirm SG readings using a BG meter and consult a healthcare professional.

For information about how to program low SG settings in Manual mode, see *Setting up the low SG settings*, page 165. The sensor must be turned on before low SG settings can be programmed.

Low limit

The low limit is used as a basis for some low SG settings. The low limit can be set from 50 mg/dL to 90 mg/dL, for up to eight different time segments.

The Low SG alarm appears when SG readings fall below 54 mg/dL. This is a fixed setting and cannot be changed. When the alarm appears, it shows the SG reading next to the Low SG alarm.

The Suspend before low feature

The Suspend before low feature stops insulin delivery when SG is approaching the low limit. This feature can help minimize the amount of time spent with low glucose.



WARNING: Do not use the Suspend before low feature without first reading the information in this user guide and receiving training from a healthcare professional. The Suspend before low feature temporarily suspends insulin delivery for a maximum of two hours. Under some conditions of use, the pump can suspend insulin delivery again, resulting in under-delivery. Prolonged under-delivery of insulin may increase the risk of hyperglycemia and diabetic ketoacidosis. Always be aware of symptoms. If symptoms don't match SG readings, confirm SG with a BG meter reading.

The Suspend before low feature is turned off by default. Consult a healthcare professional before the Suspend before low feature is used.

If the Suspend before low feature is turned on, Alert on low is automatically turned on. Enabling Alert before low is optional.

- If Alert before low is off, a Suspend before low alert occurs, but the pump does not beep or vibrate when insulin delivery is suspended.
- The Suspend before low and Suspend on low features cannot be on at the same time. When either feature is on, the Resume basal alert can be activated.

Suspend before low conditions

When a Suspend before low event occurs, insulin delivery is suspended. A Suspend before low event occurs if both of the following conditions are met:

- SG reading is at the low limit or is within 70 mg/dL above the low limit.
- SG is predicted to reach or fall below a level that is 20 mg/dL above the low limit within approximately 30 minutes.

The following image is an example of what can happen during a Suspend before low event.

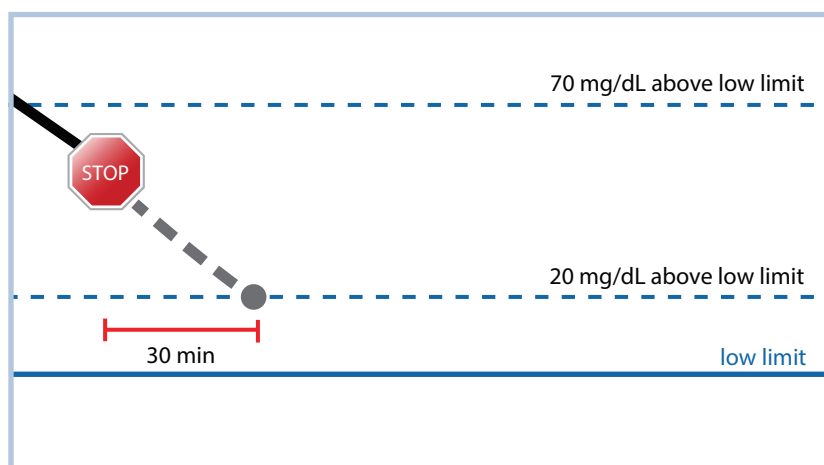

Responding to a Suspend before low event

When the Suspend before low feature suspends insulin delivery, the icon flashes. If SG reaches the low limit, an Alert on low occurs.

When a Suspend before low event occurs, insulin delivery can be suspended for a minimum of 30 minutes or up to a maximum of two hours. Basal insulin delivery can be manually resumed at any time. For details, see *Manually resuming basal insulin delivery during a Suspend before low or Suspend on low event*, page 168. After 30 minutes, basal insulin delivery resumes if both of the following conditions are met:

- SG is at least 20 mg/dL above the low limit.
- SG is predicted to be more than 40 mg/dL above the low limit within 30 minutes.

If the Suspend before low alert is not cleared within two hours, the pump resumes insulin delivery and displays a Basal delivery resumed alert.

Alert before low

Alert before low provides an alert when SG is predicted to reach the low limit, and increases awareness of potential low SG.

The Alert before low feature works as follows:

- If Alert before low is on, and both suspend features are off, Alert before low occurs 30 minutes before the low limit is reached.
- If the Suspend on low feature is on and Alert before low is on, Alert before low occurs 30 minutes before the low limit is reached.
- If the Suspend before low feature is on and Alert before low is on, a Suspend before low alert occurs when insulin delivery is suspended. For details, see *The Suspend before low feature, page 156*.

The Suspend on low feature

The Suspend on low feature stops insulin delivery when SG readings reach or fall below the low limit. When a Suspend on low event occurs, insulin delivery is suspended. This feature is for situations when a person cannot respond to a low glucose condition and can help minimize the amount of time spent with low glucose.



WARNING: Do not use the Suspend on low feature without first reading the information in this user guide and receiving training from a healthcare professional. The Suspend on low feature temporarily suspends insulin delivery for a maximum of two hours. Under some conditions of use, the pump can suspend insulin delivery again, resulting in under-delivery. Prolonged suspension of insulin delivery may increase the risk of serious hyperglycemia, ketosis, and ketoacidosis.

The Suspend on low feature is off by default. Consult a healthcare professional for guidance before the Suspend on low feature is used.

When the Suspend on low feature is on, Alert on low is activated automatically. For more information, see *Alert on low*, page 160.

The following image is an example of what can happen during a Suspend on low event.

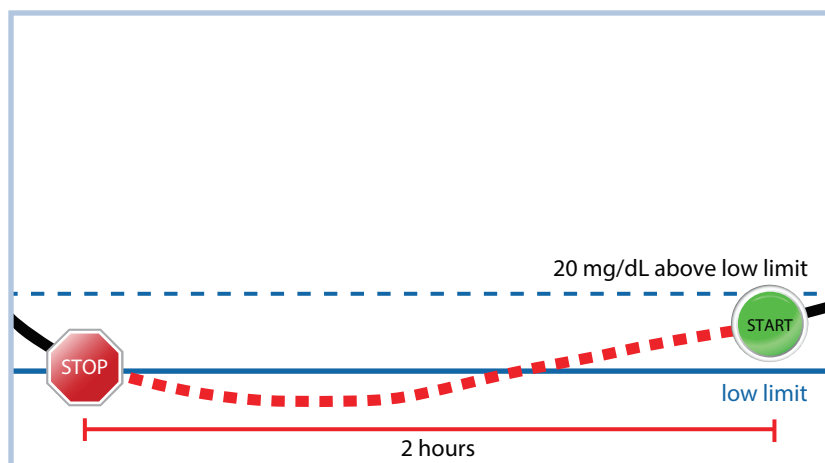

Responding to a Suspend on low event

When the Suspend on low feature suspends insulin delivery, the icon flashes.

When a Suspend on low event occurs, a pump alarm occurs and insulin delivery remains suspended for a minimum of 30 minutes, up to a maximum of two hours. Insulin delivery can be resumed manually at any time. For details, see *Manually resuming basal insulin delivery during a Suspend before low or Suspend on low event*, page 168. After 30 minutes, basal insulin delivery resumes under the following conditions:

- SG is at least 20 mg/dL above the low limit.
- SG is predicted to be more than 40 mg/dL above the low limit within 30 minutes.

If the Suspend on low alarm is not cleared within two hours, the pump resumes insulin delivery and displays an emergency message.

When the Suspend before low or Suspend on low features are unavailable

After a Suspend before low or Suspend on low event, both features are not active for a period of time to help prevent prolonged suspension of insulin delivery. Insulin delivery is suspended for a maximum of two hours. Insulin delivery can be manually suspended

at any time. For details, see *Suspending all insulin delivery and resuming basal insulin delivery*, page 95.

When the Suspend before low and the Suspend on low features are unavailable, the suspend by sensor icon on the Home screen appears with a red X .

Response to Suspend before low or Suspend on low events	Duration that the Suspend before low or Suspend on low feature is unavailable
The alert is cleared within two hours and the pump stays suspended for the maximum two-hour suspend time.	The feature is unavailable for 30 minutes after basal insulin delivery resumes.
The alert is cleared within two hours and insulin delivery automatically resumes due to rising SG levels.	The feature is unavailable for 30 minutes after basal insulin delivery resumes.
The alert is cleared within two hours and basal insulin delivery is manually resumed.	The feature is unavailable for 30 minutes after basal insulin delivery resumes.
The alert is not cleared within 2 hours.	Basal insulin delivery automatically resumes and the feature is available.
The alert is cleared within 30 minutes after basal insulin delivery is automatically resumed.	The feature is unavailable for the remaining time left in the 30 minutes after basal insulin delivery resumed.
The alert is cleared between 30 minutes and four hours after basal insulin delivery is resumed.	The feature is available.
The alert is not cleared.	The feature is unavailable for four hours after basal delivery automatically resumes.

Alert on low

The Suspend before low and the Suspend on low features automatically activate Alert on low. When Alert on low is on, the pump displays an alert when SG reaches or falls below the low limit. If insulin delivery is suspended and the alert is not cleared, an emergency message appears.

Automatically resuming basal insulin delivery after a Suspend before low or Suspend on low event

If insulin delivery is suspended by either the Suspend before low or the Suspend on low feature, basal insulin delivery automatically resumes under one of the following conditions:

- If insulin delivery is suspended for a minimum of 30 minutes and SG readings are at least 20 mg/dL above the low limit and expected to be more than 40 mg/dL above the low limit within 30 minutes
- After a maximum of two hours

Resume basal alert

The Resume basal alert indicates when basal insulin is resumed automatically. When basal insulin delivery resumes and the Resume basal alert is off, a message appears indicating that basal insulin delivery has resumed.

If basal insulin delivery resumes after the maximum suspend time of two hours, an alert appears even if the Resume basal alert is off.

To set up the Resume basal alert, see *Setting up the low SG settings*, page 165.

Setting up CGM





WARNING: Do not use SG values to make treatment decisions, including delivering a bolus, while the pump is in Manual mode. When the SmartGuard feature is active and you are no longer in Manual mode, the pump uses an SG value, when available, to calculate a bolus amount. However, if your symptoms do not match the SG value, use a BG meter to confirm the SG value. Failure to confirm glucose levels when your symptoms do not match the SG value can result in the infusion of too much or too little insulin, which may cause hypoglycemia or hyperglycemia. For more information on using the SmartGuard feature, see *SmartGuard*, page 181.

Turning the Sensor feature on or off

The Sensor feature must be on before SG alerts can be set up and SG levels can be monitored.

The Sensor feature may be turned off at any time. When the transmitter is disconnected from the sensor, turn off the Sensor feature to avoid a sensor alert. The Sensor feature must be turned on again before settings can be changed.



To turn the Sensor feature on or off:

1. From the Home screen, press , and then select .
2. Select **Device Settings** > **Sensor**.
3. Select **Sensor** to turn the feature on or off.

Setting up the High SG settings

For details about high SG settings, see *High SG settings, page 153*.

To set up the high SG settings:

1. From the Home screen, press , and then select .
2. Select **Alert Settings** > **High Alert**.

The High Setup screen appears.

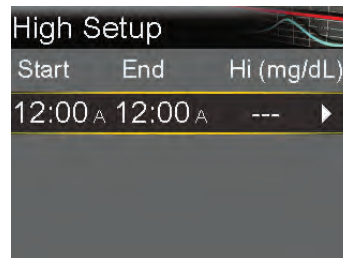

3. Select the time segment. The end time flashes.
The start time of the first time segment is always 12:00 A. Up to eight time segments can be set, each with a different high limit. All the time segments must add up to a 24-hour period.
4. Set the End time.

5. Set the high limit, from 100 mg/dL to 400 mg/dL, in increments of 5 mg/dL.
6. Select the arrow to the right of the End time to select the high alerts for the time segment.

A screen appears and shows the high alerts for the selected time segment.



7. Set the following alerts, as desired:
 - a. Select **Alert before high** to receive an alert before the high limit is reached.
 - b. Set the **Time before high** option between 5 to 30 minutes to receive an alert before the high limit is reached.
 - c. Select **Alert on high** to receive an alert when the high limit is reached.
 - d. Select **Rise Alert** to receive an alert when SG is rising quickly.
8. If Rise Alert is on, perform the following steps to set up the Rise Limit. Otherwise, proceed to step 9.
 - a. Scroll down and select **Rise Limit**.
The Rise Limit screen appears.

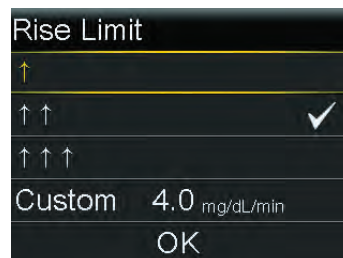

- b. Select one, two, or three arrows for the rise rate, or enter a custom rate.

Arrow selection	Minimum rate that SG is rising when an alert occurs.
↑	SG is rising at a rate of 1 mg/dL per minute or more.
↑↑	SG is rising at a rate of 2 mg/dL per minute or more.
↑↑↑	SG is rising at a rate of 3 mg/dL per minute or more.



Note: These arrows appear on the Home screen to indicate the rate at which SG is rising.



- c. To enter a custom rate, select **Custom**, enter the Rise Limit on the Custom Limit screen, and then select **OK**.
- d. Select **OK** again to confirm the Rise Limit settings.
9. Select **Next**.
10. If necessary, enter the remaining time segments to complete the 24-hour period.



Note: For instructions on setting up more than one high limit over a 24-hour period, see *Settings covering a 24-hour period*, page 91.

11. Select **Review**.
12. Review the high SG settings and select **Save**.

To change the high SG settings:



- From the Home screen, press , and then select .
- Select **Alert Settings > High Alert**.
The High Setup screen appears.

3. Select **Edit**.
4. Select and adjust the time segment.
5. Select any alert setting to make adjustments, or to turn the setting on or off.
6. Select **Next**.
7. Select **Review**.
8. Review the high SG settings and select **Save**.

High Snooze

The High Snooze feature sets the amount of time before a high alert repeats. The pump shows the high alert again if the high alert condition still exists after the specified snooze time.



To set the High Snooze:

1. From the Home screen, press , and then select .
2. Select **Alert Settings > Snooze High & Low**.
The Snooze screen appears.
3. Select **High Snooze** and enter a time in 5-minute increments from 5 minutes to 3 hours.
4. Select **Save**.

Setting up the low SG settings

For information about the low SG settings, see *Low SG settings, page 154*.

To set up the low SG settings:

1. From the Home screen, press , and then select .
2. Select **Alert Settings > Low Alert**.
The Low Setup screen appears.

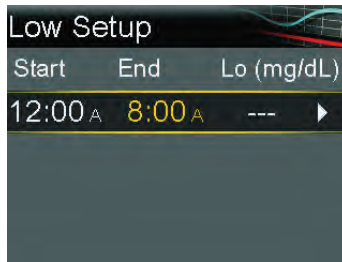

3. Select the time segment. The end time flashes.
The start time of the first time segment is always 12:00 A. Up to eight time segments can be set, each with a different low limit. All the time segments must add up to a 24-hour period.
4. Set the End time.
5. Set the low limit, from 50 mg/dL to 90 mg/dL, in increments of 5 mg/dL.
6. Select the arrow to the right of the End time to select the low SG settings for the time segment.

A screen appears and shows the available settings for the selected time period.

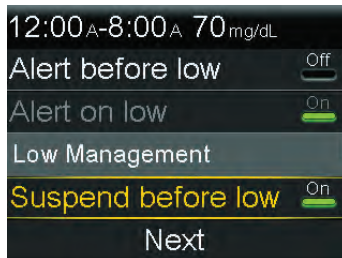

7. Set the following alerts, as desired:
 - a. Select **Suspend before low** to set the pump to suspend insulin delivery before the low limit is reached.
 - b. Select **Alert before low** to receive an alert before the low limit is reached.
 - c. Select **Suspend on low** to set the pump to suspend insulin delivery when SG reaches or falls below the low limit.

- d. Select **Alert on low** to receive an alert when SG reaches or falls below the low limit.
- e. Select **Resume basal alert** to receive an alert when basal insulin delivery resumes during a suspend event. When this alert is off, the Basal delivery resumed message still appears.



Note: The Suspend before low and the Suspend on low features cannot both be on during the same time segment.



- 8. Select **Next**.
- 9. If necessary, enter the remaining time segments to complete the 24-hour period.



Note: For instructions on setting up more than one low limit over a 24-hour period, see *Settings covering a 24-hour period*, page 91.

- 10. Select **Review**.
- 11. Review the low SG settings, and select **Save**.



To change the low SG settings:

- 1. From the Home screen, press , and then select .
- 2. Select **Alert Settings > Low Alert**.
The Low Setup screen appears.
- 3. Select **Edit**.
- 4. Select and adjust the time segment.
- 5. Select any alert setting to make adjustments, or to turn the setting on or off.
- 6. Select **Next**.
- 7. Select **Review**.
- 8. Review the low SG settings, and select **Save**.

Low Snooze

The Low Snooze feature sets the amount of time before a low alert repeats. The pump shows the low alert again if the low alert condition still exists after the specified snooze time.

To set the Low Snooze:

1. From the Home screen, press , and then select .
2. Select **Alert Settings** > **Snooze High & Low**.
The Snooze screen appears.
3. Select **Low Snooze** and enter a time in 5-minute increments from 5 minutes to 1 hour.
4. Select **Save**.

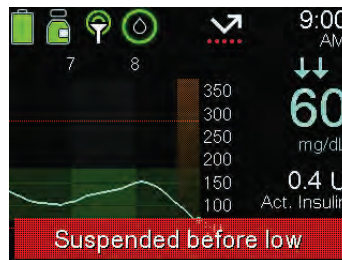

Manually resuming basal insulin delivery during a Suspend before low or Suspend on low event

When the pump suspends insulin due to a Suspend before low or Suspend on low event, the Home screen shows which feature is active.



Basal insulin delivery automatically resumes when certain conditions are met. Basal delivery can be manually resumed at any time.

To manually resume basal delivery:

1. From the Home screen, press , and then select .
2. Select **Resume Basal**.
3. Select **Yes** to resume basal insulin delivery.

Inserting the sensor

Choose an insertion site that has an adequate amount of subcutaneous fat. The Guardian Sensor (3) has been studied and is approved for use in the following sensor insertion sites by persons of the following ages:

Refer to the sensor user guide for instructions on how to insert the sensor.

Approved Age	Sensor Insertion Site
7-13	Abdomen and Buttocks
14 and older	Abdomen and Arm

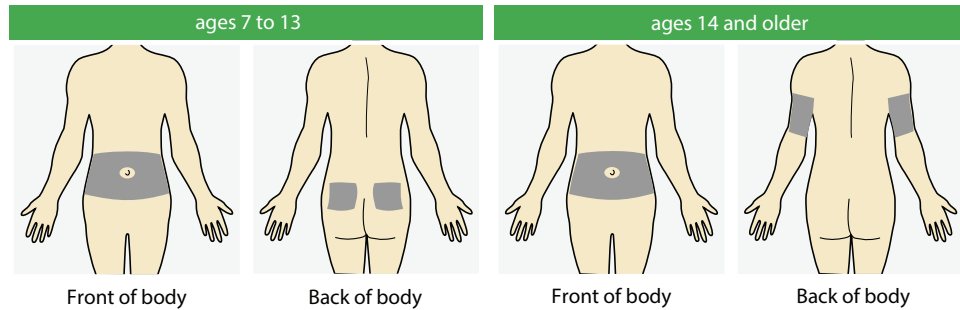

 **Note:** Do not use the Guardian Sensor (3) in other body sites due to unknown or different performance that could result in hypoglycemia or hyperglycemia.

 **Note:** Assistance will likely be needed for sensor insertion into the back of the upper arm. Some users find it difficult to insert the sensor into their arm by themselves.

Connecting the transmitter to the sensor

Refer to the transmitter user guide for instructions on how to connect the transmitter to the sensor.

Starting the sensor

After the sensor is inserted and paired with the transmitter, the pump will display a Start New Sensor screen.

To start a new sensor:

1. Select **Start New Sensor** when it appears on the pump screen.

The “Sensor warm up X:XX hr” message appears.

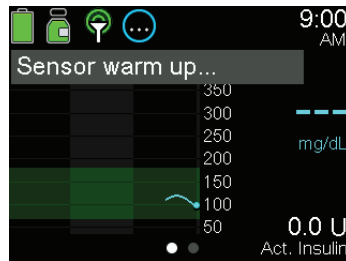

WARNING: Sensor glucose and blood glucose values may differ. If the sensor glucose reading is low or high, or there are symptoms of low or high blood glucose, use a BG meter to confirm blood glucose before making therapy decisions. Failure to confirm that BG levels match symptoms prior to making therapy decisions can result in the infusion of too much or too little insulin, which may cause hyperglycemia or hypoglycemia. If SG readings continue to be different from symptoms, consult a healthcare professional about how to use SG readings to help manage diabetes.



Note: It may take up to five minutes for the “Sensor warm up X:XX hr” message to appear. The warm up period lasts two hours.

2. Select **OK**.

The “Sensor warm up...” message appears on the Home screen until the sensor is ready for its first calibration.

Calibrating the sensor

A BG meter reading is required to calibrate the sensor and for optimal sensor performance. Calibration must occur regularly to maintain accurate SG data. For details, see *Entering a BG reading for calibration*, page 172.



Note: Only a BG value between 40 mg/dL to 400 mg/dL can be used to calibrate the sensor. Calibration should be performed at least every 12 hours for optimal results.

When to enter a BG reading for calibration

The following table describes when to enter a BG reading for sensor calibration.

Calibrate	Description
After warm-up is complete.	The pump displays an Enter BG now alert within two hours of starting a new sensor. The first SG reading appears up to five minutes after calibration.
Within six hours after the first calibration.	Six hours after the first calibration, an Enter BG now alert appears, and the pump stops calculating SG readings. It takes up to five minutes after calibration to receive SG readings again.
Within 12 hours of the second calibration and at least every 12 hours after.	After the second calibration, calibrate the sensor at least every 12 hours. For better sensor performance, calibrate the sensor three or four times each day. If 12 hours pass without sensor calibration, an Enter BG now alert appears. It takes up to five minutes after calibration to receive SG readings again.
When the Enter BG now alert appears.	Additional Enter BG now alerts may appear, and indicate that another calibration is required to improve sensor performance. It takes up to five minutes after calibration to receive SG readings again.



Note: When a BG value is entered for calibration, the BG reading appears in place of the SG reading on the Home screen. This BG reading is replaced by the next SG reading that is received. If no SG reading is received after 12 minutes, dashes appear on the Home screen.

Entering a BG reading for calibration

Sensor calibration occurs when a BG value is entered or received from a meter.

Follow these guidelines for best sensor calibration results:

- Enter a BG reading at least every 12 hours.
- Enter BG meter readings immediately after they are taken. Do not calibrate with a BG meter reading taken more than 12 minutes earlier as that BG reading is no longer valid. If BG meter readings are significantly different from SG readings, wash hands and calibrate again.
- Always use clean, dry fingers to check BG levels.
- Only use fingertips to obtain blood samples for calibration.

For information about entering a BG value to calibrate the sensor, see *Entering a blood glucose (BG) meter reading*, page 100.

Reconnecting the sensor

If the transmitter is removed from a sensor while the sensor is inserted in the body, the pump detects when the transmitter is reconnected to the sensor and a “Sensor connected” message appears.

To reconnect a sensor:

1. Select **Reconnect Sensor**.

The “Sensor warm up...” message appears.



Note: It may take up to five minutes for the “Sensor warm up...” message to appear. The warm up period lasts two hours.

2. Select **OK**.

The “Sensor warm up...” message appears on the Home screen until the sensor is ready for its first calibration.

Using CGM

CGM can help identify SG trends and provide notifications when SG falls or rises rapidly. Use the following information to interpret historical SG readings and to silence sensor alerts, when necessary.



WARNING: Do not use SG values to make treatment decisions, including delivering a bolus, while the pump is in Manual mode. When the SmartGuard feature is active and you are no longer in Manual mode, the pump uses an SG value, when available, to calculate a bolus amount. However, if your symptoms do not match the SG value, use a BG meter to confirm the SG value. Failure to confirm glucose levels when your symptoms do not match the SG value can result in the infusion of too much or too little insulin, which may cause hypoglycemia or hyperglycemia. For more information on using the SmartGuard feature, see *SmartGuard*, page 181.

The sensor graph when using CGM

The sensor graph provides current SG reading information that is transmitted to the pump. If the MiniMed Mobile app is in use, the sensor graph can be viewed on a mobile device.

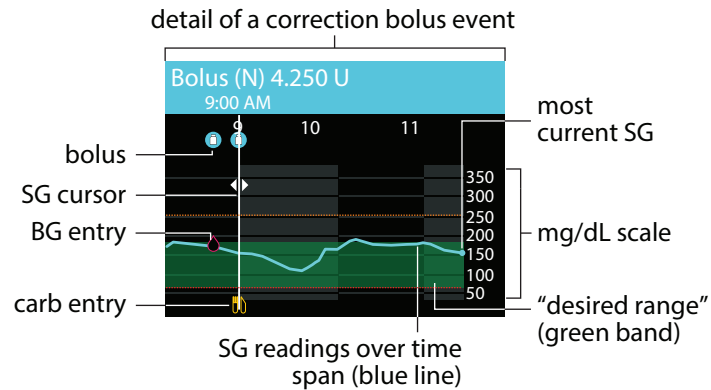

The sensor graph includes the following information:

- The most recent SG reading.
- Historical SG readings for the last 3-hour, 6-hour, 12-hour, or 24-hour periods.
- High and low SG limits.
- Carb entries.
- Boluses delivered during the time period displayed on the graph.
- Suspend events caused by Suspend before low or Suspend on low.
- BG entries.

There are several reasons why an SG reading may not appear on the graph:

- A recently inserted sensor is still warming up.
- A new sensor has initialized, but is still calibrating.
- A recently reconnected sensor is not ready.
- More than six hours have passed since the initial sensor calibration
- More than 12 hours have passed since the last sensor calibration
- An error condition or a sensor-related alert is occurring. For a list of sensor alerts, see *CGM (sensor) alarms, alerts, and messages, page 311*.

To view the sensor graph:

1. From the Home screen, press the  button.

A full-screen view of the 3-hour graph appears.

2. Press ^ to navigate to the 6-hour, 12-hour, and 24-hour graphs.
3. Press < to view SG readings and event details.
4. To exit the full-screen view, press ↩, or press the ⚡ button again.

Silencing sensor alerts

The Alert silence feature silences certain sensor alerts for a set period of time. When using this option, the Alert silence icon  appears on the Home screen. The system still displays any alerts that occur, but there is no sound or vibration if they are silenced. This information can be reviewed in the Alarm History screen.

The Alert silence feature does not silence:



- **High SG alert**—When your sensor glucose (SG) value is above 250 mg/dL for more than three hours
- **Low SG alarm**—When your sensor glucose (SG) value falls under 54 mg/dL
- **SmartGuard exit alert**—When the pump exits the SmartGuard feature

The following table describes the sensor alerts that are silenced with each option.

Option	Silences these alerts
High Alerts Only	Alert on high, Alert before high, and Rise Alert
High & Low Alerts	Alert on high, Alert before high, Rise alert, Alert on low, Alert before low, Suspend before low, and Resume basal alert Note: Alert on low cannot be silenced if the Suspend before low or Suspend on low features are turned on.
All Sensor Alerts	All of the alerts listed previously for High & Low Alerts, as well as the following: <ul style="list-style-type: none"> • All calibration alerts, reminders, or error messages that may result from entering a BG reading

Option	Silences these alerts
	<ul style="list-style-type: none"> All alerts related to sensor insertion, including alerts about sensor warm-up, changing the sensor, sensor expiration, sensor updating, connection issues. All alerts related to the transmitter, including transmitter battery alerts and connection issues

To silence sensor alerts:

- From the Home screen, press , and then select .
- Select **Silence Sensor Alerts**.



- Select **High Alerts Only**, **High & Low Alerts**, or **All Sensor Alerts**. Refer to the previous table for details about the alerts silenced with each selection.



Note: Silencing **All Sensor Alerts** prevents the sound and vibration of most alerts related to SG readings, the sensor, and the transmitter. The Low SG alarm, for when SG drops below 54 mg/dL, the SmartGuard exits alert, and the High SG alert cannot be silenced.

- Set the **Duration**. The duration can be set in 15-minute increments from 30 minutes to 24 hours.
- Select **Begin**.

To cancel Alert Silence:

- From the Home screen, press , and then select .

2. Select **Alert Silence**.

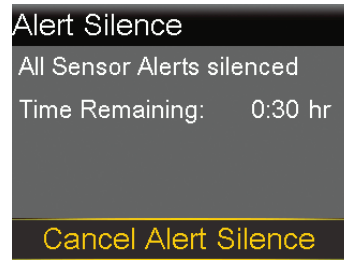

3. Select **Cancel Alert Silence**.



8



SmartGuard

8

SmartGuard

This chapter provides information about how to set up and start using the SmartGuard feature.

Introduction

The SmartGuard feature uses meal information, sensor glucose (SG), and SmartGuard target values to control basal insulin delivery. It also can automatically deliver a correction bolus to help correct a high SG reading. The MiniMed 780G insulin pump requires a minimum of eight units and a maximum of 250 units per day to operate using the SmartGuard feature.



Note: The Auto correction feature uses SG values to determine bolus insulin doses. Auto correction boluses are delivered without user acknowledgment. The accuracy of SG values can be lower than the accuracy of blood glucose (BG) meter readings, which are checked with a blood glucose (BG) meter.

The SmartGuard feature is designed to maximize the amount of time that glucose levels stay in the range of 70 mg/dL to 180 mg/dL. The following table describes features that the system uses to maximize time in range.

Feature name	Description
SmartGuard target: 100 mg/dL, 110 mg/dL, or 120 mg/dL	Consult a healthcare provider to determine which SmartGuard target to use to maximize time in range. The default setting is 100 mg/dL.

Feature name	Description
Auto Basal	When using the SmartGuard feature, basal insulin is automatically delivered based on SG readings and recent insulin delivery needs.
Target for Auto correction bolus based on SG: 120 mg/dL	The MiniMed 780G system may deliver a bolus automatically, as frequently as every five minutes, if the SmartGuard feature determines that a correction bolus is necessary. The default setting for Auto correction is set to On.
Temp Target: 150 mg/dL	A temp target can be set for events such as exercise or other times when less insulin is needed. If a temp target is used for exercise, consider starting it one to two hours before beginning the exercise. Auto correction boluses are not delivered while a temp target is active.



Note: When using the SmartGuard feature, meal boluses are still required, as well as BG meter readings to calibrate the sensor.

The SmartGuard feature requires accurate sensor measurements and carb information to deliver insulin for meals. This insulin therapy requires the use of the Bolus feature to deliver boluses to cover meals.

When using the SmartGuard feature:

- If an Enter BG alert occurs, enter a BG meter reading.
- Do not enter an SG reading when the system requests a BG reading.
- Bolus amount cannot be adjusted when delivering a bolus in the SmartGuard feature. If SG readings do not match with symptoms, enter a BG value from a BG meter reading.
- The system requires periodic testing of blood glucose (BG) values using a BG meter to calibrate the sensor. The sensor should be calibrated at least every 12 hours. The pump may also request additional BG readings throughout the day.

Auto Basal

When the SmartGuard feature is active, the basal insulin dose is calculated using SG values from the sensor. The automatic delivery of insulin is called Auto Basal.

Auto Correction

The pump may deliver a bolus automatically when the SmartGuard feature determines it is needed for correction, to maximize the time in range, between 70 mg/dL and 180 mg/dL. Because this is an automated bolus, no action is required. The Home screen shows when an Auto Correction bolus occurs.

Giving a bolus when the SmartGuard feature is active

A meal bolus can be delivered while using the SmartGuard feature. For more information, see *Delivering a bolus in the SmartGuard feature*, page 193.



WARNING: Always confirm an SG value that does not match your symptoms. When the SmartGuard feature is active and you are no longer in Manual mode, the pump uses an available SG value to calculate a bolus amount. However, if your symptoms do not match, the SG value can result in the infusion of too much or too little insulin, which may cause hypoglycemia or hyperglycemia.

Preparing to set up the SmartGuard feature

The SmartGuard feature requires a 48-hour warm-up period before activation. This warm-up period begins at midnight after the pump starts delivering insulin and it does not require sensor use. During the warm-up period, the pump collects and processes data for use by the SmartGuard feature.



Note: A basal pattern must be programmed for use during the warm-up period and for instances when the pump is in manual mode. During the warm-up period the pump should also be used to give boluses.

To prepare the pump for the SmartGuard feature:

1. Cancel any active Temp Basal rates. See *Canceling a temp basal or preset temp basal*, page 246.
2. Confirm that insulin delivery is not suspended. See *Suspending all insulin delivery and resuming basal insulin delivery*, page 95.
3. Set the carb ratio. See *Changing the carb ratio*, page 256.
4. Review the high and low limit settings. High and low limit settings apply when in Manual mode and when using the SmartGuard feature. See *SG alert settings*, page 153 for details.
5. Enter a new BG reading. If a new sensor is used, enter a BG reading to calibrate the new sensor. For more information about calibrating the sensor, see *Calibrating the sensor*, page 171.



WARNING: If the pump has been used in the last 14 days to practice button pressing, or if insulin that was programmed into the pump was not the user's actual insulin delivery, clear active insulin and the total daily doses tracked by the SmartGuard feature before using the SmartGuard feature. Failure to do so may result in the delivery of too little or too much insulin, which can cause hyperglycemia or hypoglycemia. The SmartGuard feature uses the recent delivery history on the pump to determine the insulin delivery amount.

Consult with your healthcare professional about using the Clear Active Insulin feature in the Manage Settings menu to clear both active insulin and the total daily dose for the SmartGuard feature.



Consider the following when SG values are used to make treatment decisions in the SmartGuard feature.

- If an Enter BG alert occurs, enter a BG meter reading.
- Do not calibrate the sensor using an SG reading when the system requests a BG meter reading.
- Bolus amount cannot be adjusted when delivering a bolus in the SmartGuard feature. If SG readings do not match with symptoms, enter a BG value from a BG meter reading.

Setting up the SmartGuard feature

The SmartGuard feature requires 48-hours of insulin delivery before the feature can be used. This warm up period begins at the first midnight after delivery has started. For more information, see *Preparing to set up the SmartGuard feature, page 183*.

To set up the SmartGuard feature:

1. From the Home screen, press , and then select .
2. Select **SmartGuard** to turn the feature on or off.



Note: Certain additional requirements must be met before the SmartGuard feature activates. For more information, see *SmartGuard Checklist, page 187*.

3. Select **SmartGuard Settings** and enter the following information:
 - Select the SmartGuard target: 100 mg/dL, 110 mg/dL, or 120 mg/dL.
 - Confirm that **Auto Correction** is on to activate automatic correction boluses.



Note: The Auto correction feature is turned on by default. When this setting is on, the pump automatically delivers correction boluses to help correct a high SG reading. For information, see *Delivering a bolus in the SmartGuard feature, page 193*.

4. Select **Save**.

Conditions to activate the SmartGuard feature

If the pump is turned off for more than two weeks and is turned back on, the pump requires 48 hours before the SmartGuard feature activates.

If the pump has been off for two weeks or less and is turned back on, a five-hour warm-up period is required before the SmartGuard feature activates.

If the SmartGuard feature is on but not active, the SmartGuard Checklist screen indicates the requirements needed to activate the SmartGuard feature. See *SmartGuard Checklist, page 187*.

The system requires five hours for the SmartGuard active insulin amount to update. This update time begins under the following conditions:

- The pump is turned on for the first time.
- A complete pump reset caused by a loss of power or a software error.
- When the insulin is resumed after being manually suspended for four hours or longer.

SmartGuard active insulin information is valid until one of the conditions listed above occurs, which restarts the five-hour update time. The SmartGuard feature is unavailable during this time.

Suspending manually while using the SmartGuard feature



For information about manually suspending insulin delivery, see *Suspending all insulin delivery and resuming basal insulin delivery, page 95*.

Suspend before low and Suspend on low features while using the SmartGuard feature





When the SmartGuard feature is active, the Suspend before low and the Suspend on low features are unavailable and automatically turn off. If the system exits the SmartGuard feature, the Suspend before low and the Suspend on low features return to the state they were in before using the SmartGuard feature. For information about turning on the Suspend before low or the Suspend on low feature, see *Low SG settings, page 154*.



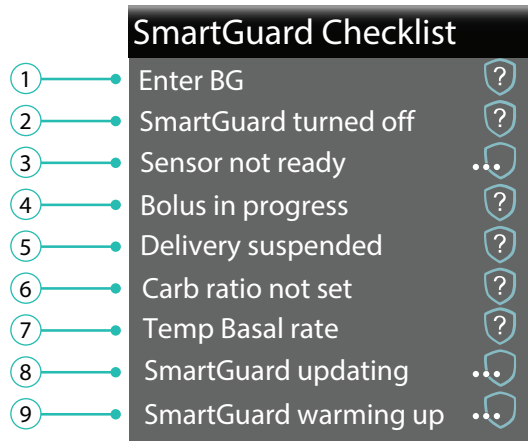



SmartGuard Checklist



The SmartGuard Checklist screen indicates the requirements necessary to start or continue using the SmartGuard feature. For more information, see *Staying in the SmartGuard feature, page 200*.

The following table shows what to do when the wait icon  or the question icon  appear by items on the SmartGuard Checklist screen.



Line	Item	Instructions
1	Calibration required 	Enter a new BG meter reading.
	Enter BG 	Enter a new BG meter reading.
	Wait to calibrate 	The system requires a BG reading and will ask when it is ready.
2	SmartGuard turned off 	Turn on the SmartGuard feature.

Line	Item	Instructions
3	Sensor not ready 	<ul style="list-style-type: none"> Confirm the pump shows a sensor serial number on the Paired Devices screen. Example: CGM XXXXXXXX Make sure the pump is paired with a sensor. For more information, see <i>Pairing the pump and transmitter</i>, page 139. Check the Home screen. If  displays, move the pump and sensor closer together. It may take 15 minutes to find the sensor signal. If after 30 minutes the pump and sensor are still not communicating, a Lost sensor signal alert appears. Check that the sensor is still inserted in the skin. Move the pump closer to the sensor. If SG is outside of the 50 to 400 mg/dL range, the SmartGuard feature is unavailable.
	Sensor off 	Turn on the Sensor feature in Settings > Device Settings.
	No paired CGM 	Pair the pump and sensor. For more information, see <i>Pairing the pump and transmitter</i> , page 139.
4	Bolus in progress 	Wait until the bolus is complete or stop the bolus before the SmartGuard feature can be used.
5	Delivery suspended 	If insulin delivery is suspended, the SmartGuard feature cannot be used. Treat low BG as instructed by a healthcare professional.
6	Carb ratio not set 	Enter a carb ratio in the Bolus Wizard feature or in the Bolus Wizard Setup screen.

Line	Item	Instructions
7	Temp Basal rate 	Stop the temp basal rate delivery before the SmartGuard feature can be used or wait until the temp basal rate delivery is complete.
8	SmartGuard updating 	If SmartGuard active insulin is updating, it will take up to five hours to complete. Wait for the update time to end before the SmartGuard feature can activate.
9	SmartGuard warming up 	Wait for the SmartGuard feature to gather insulin delivery history and determine the basal rate.

To view the SmartGuard Checklist:

1. From the Home screen, press , and then select .
2. Select **SmartGuard Checklist**.

Home screen with the SmartGuard feature

When the pump is using the SmartGuard feature, the Home screen displays a shield with the current SG level.



Note: When the SmartGuard feature first activates, the value in the shield shows the entered BG reading until the first SG reading is received from the sensor.

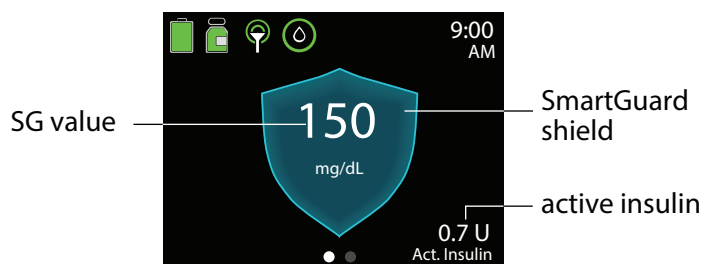

Using the SmartGuard feature

The sensor graph with the SmartGuard feature

The sensor graph with the SmartGuard feature shows historical SG readings provided by the sensor.

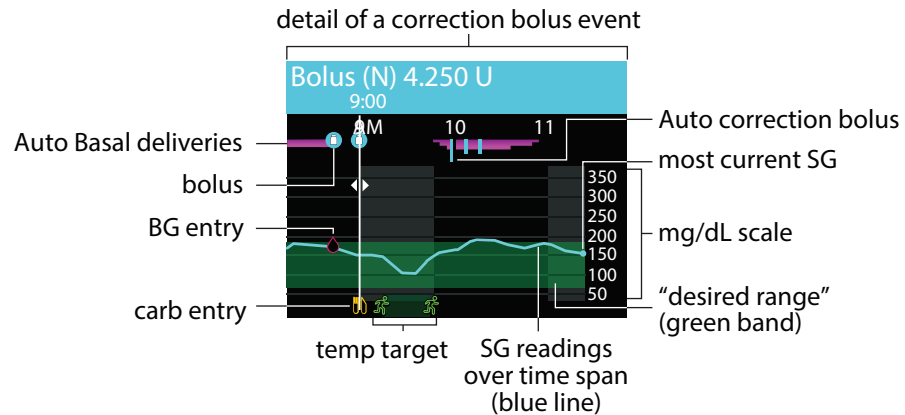





The SmartGuard feature sensor graph includes the following information:

- When a location on the graph is selected, specific details of the SG or event appear, such as a correction bolus.
- Historical SG readings are displayed for the last 3-hour, 6-hour, 12-hour, or 24-hour periods. They appear as a blue line across the screen.
- Boluses are shown as white vials inside blue circles.
- Carb entries are shown as yellow knife and fork symbols. These represent any bolus amounts that include a carb entry.
- BG entries appear as red drop symbols.
- Magenta bands across the top represent Auto Basal deliveries provided by the SmartGuard feature.
- Blue vertical bars at the top represent Auto correction boluses delivered by the SmartGuard feature.

- A time change event appears as a white clock symbol.
- Temp target is shown as green runners.

To view the sensor graph:

1. From the Home screen, press the  button to display the SG graph.
A full-screen view of the 3-hour graph appears.
2. Press  to navigate to the 6-hour, 12-hour, and 24-hour graphs.
3. Press  to view SG readings and event details.
4. To exit the sensor graph, press  or press the  button again.

Entering a BG value in the SmartGuard feature

A BG value must be entered into the pump for the following reasons:

- Enter a BG value to calibrate the sensor.
- Enter a BG value when the pump requires it to continue using the SmartGuard feature.

There are two ways to enter a BG value when using the SmartGuard feature. Manually enter a BG value or enter a BG value using the compatible Accu-Chek™* Guide Link meter. For more information on manually entering a BG, see *Entering a blood glucose (BG) meter reading*, page 100.

The following table shows when to use a blood glucose (BG) meter reading:

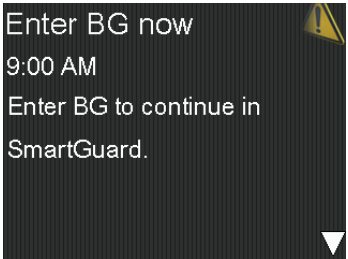
When to use a blood glucose (BG) meter reading	Examples
Anytime the system requests a blood glucose (BG) meter reading.	

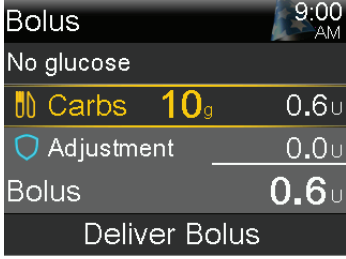
When to use a blood glucose (BG) meter reading	Examples
	 <p>The screenshot shows a mobile application interface with a dark background. At the top right, the time is 9:00 AM. In the center, a large white shield contains the number '150' and 'mg/dL' below it. To the left of the shield, it says 'Exit in 0:30 hr'. To the right, it says '0.6 U Act. Insulin'. At the bottom, there is a blue button labeled 'Enter BG'. There are also icons for battery, signal, and a red drop icon at the top.</p>
<p>Anytime you deliver a bolus in SmartGuard when a sensor glucose (SG) value is not displayed on the bolus screen and you want to use a glucose for a correction.</p>	 <p>The screenshot shows a 'Bolus' screen with a dark background. At the top right, the time is 9:00 AM. The text 'No glucose' is displayed. Below that, there are three rows of data: 'Carbs 10g' with '0.6U' to its right, 'Adjustment' with a horizontal line and '0.0U' to its right, and 'Bolus' with '0.6U' to its right. At the bottom, there is a button labeled 'Deliver Bolus'.</p>
<p>When using a medication that impacts glucose levels.</p>	
<p>When your sensor glucose (SG) values are different than the symptoms you are experiencing.</p>	
<p>The most recent sensor glucose (SG) reading is unavailable. Sensor glucose (SG) readings are unavailable in the following conditions:</p> <ul style="list-style-type: none"> • A new sensor is started. • A Sensor Updating notification appears. • The sensor requires a new blood glucose (BG) meter reading to be entered because the system was unable to use the blood glucose (BG) meter reading that was entered to calibrate the sensor. All blood glucose (BG) meter readings that are entered are used to calibrate the sensor. 	
<p>There is doubt that sensor glucose (SG) values are correct.</p>	



WARNING: Consult a healthcare professional before using sensor glucose values to make treatment decisions if a medication that contains acetaminophen or paracetamol is taken while wearing the sensor. Medications that contain acetaminophen or paracetamol can falsely raise sensor glucose readings. The level of inaccuracy depends on the amount of acetaminophen or paracetamol active in the body and can differ for each person. Falsely elevated sensor readings can result in over-delivery of insulin, which can cause hypoglycemia. Medications that contain acetaminophen or paracetamol include, but are not limited to, cold medicines and fever reducers. Check the label of any medications being taken to see if acetaminophen or paracetamol is an active ingredient. Use additional blood glucose meter readings to confirm blood glucose levels.

If acetaminophen or paracetamol is taken, stop the use of the medication before using sensor glucose readings to make treatment decisions. Use additional blood glucose meter readings to confirm blood glucose levels. If acetaminophen or paracetamol is taken while the SmartGuard feature is active, program a temp target for up to eight hours, or the amount of time recommended by a healthcare provider. For more information, see *Setting a temp target, page 199*. Use blood glucose values instead of sensor glucose readings to calculate a meal bolus or correction bolus up to eight hours, or the duration recommended by a healthcare provider, after taking acetaminophen or paracetamol.

Delivering a bolus in the SmartGuard feature



WARNING: Always confirm an SG value that does not match your symptoms. When the SmartGuard feature is active and you are no longer in Manual mode, the pump uses an available SG value to calculate a bolus amount. However, if your symptoms do not match, the SG value can result in the infusion of too much or too little insulin, which may cause hypoglycemia or hyperglycemia.



WARNING: Do not use the SmartGuard feature for a period of time after giving a manual injection of insulin by syringe or pen. Manual injections are not accounted for in the active insulin amount. Using the SmartGuard feature after a manual injection may result in over-delivery of insulin. Too much insulin may cause hypoglycemia. Consult a healthcare professional for how long to wait after a manual injection before resuming the SmartGuard feature.



WARNING: Do not use SG values to make treatment decisions, including delivering a bolus, while the pump is in Manual mode. When the SmartGuard feature is active and you are no longer in Manual mode, the pump uses an SG value, when available, to calculate a bolus amount. However, if your symptoms do not match the SG value, use a BG meter to confirm the SG value. Failure to confirm glucose levels when your symptoms do not match the SG value can result in the infusion of too much or too little insulin, which may cause hypoglycemia or hyperglycemia. For more information on using the SmartGuard feature, see *SmartGuard*, page 181.



WARNING: SG readings are used to calculate meal boluses or correction boluses when delivering a bolus in the SmartGuard feature. SG is not the same as BG. Sensor performance may occasionally vary from sensor to sensor and in different situations for a sensor, such as on the first day of use.

When SG readings are used for meal boluses and for correction boluses, there is a risk of both hypoglycemia and hyperglycemia. If an SG reading is much lower than a BG reading would be at that time, there is a risk of hyperglycemia, because the amount of insulin delivered could be smaller. If an SG reading is much higher than a BG and there are symptoms of feeling low, but the SG reading is not low, and if there are symptoms of a severe hypoglycemic event, a severe hyperglycemic event, or diabetic ketoacidosis, a BG meter reading is needed.

This can also occur when SG readings are used when the Auto correction feature is turned on. For example, when an SG reading is much higher than a BG reading at that time, there is a risk of hypoglycemia, because the amount of insulin delivered could be larger.

If there are symptoms of feeling low, but the SG reading is not low, and if there are symptoms of a severe hyperglycemic event or diabetic ketoacidosis, a BG meter reading is needed.

A current BG or SG reading is used to determine the bolus amount. A carb amount can be entered for a food bolus.

If the BG or SG is under 120 mg/dL, or if the bolus is zero after the pump accounts for active insulin, or if the SmartGuard feature estimates current basal delivery is sufficient, no correction is recommended.

The following table describes how glucose readings are shown on the SmartGuard bolus screen.

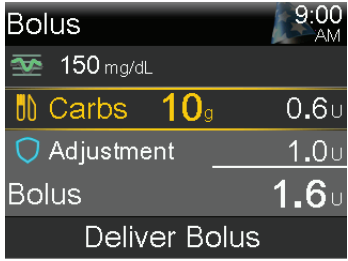
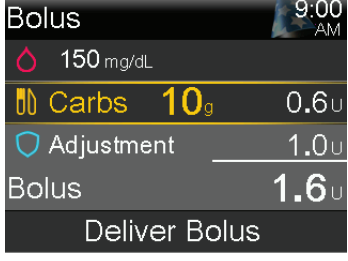
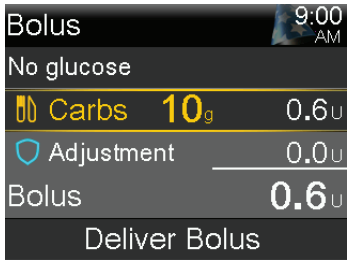
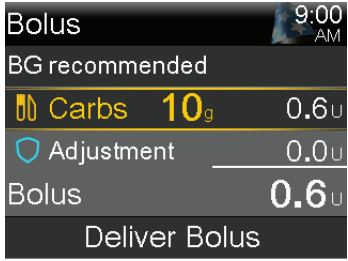

Bolus screen	Glucose reading information
 <p>Bolus 9:00 AM BG 150 mg/dL Carbs 10g 0.6u Adjustment 1.0u Bolus 1.6u Deliver Bolus</p>	<p>The BG icon indicates there is no recent blood glucose (BG) meter reading available, but a sensor glucose (SG) value is available.</p> <p>A blood glucose (BG) meter reading can be entered to calculate a correction bolus. The correction bolus is included in the Adjustment.</p>
 <p>Bolus 9:00 AM ● 150 mg/dL Carbs 10g 0.6u Adjustment 1.0u Bolus 1.6u Deliver Bolus</p>	<p>A blood glucose (BG) meter reading is available to calculate a correction bolus. The correction bolus is included in the Adjustment.</p>
 <p>Bolus 9:00 AM No glucose Carbs 10g 0.6u Adjustment 0.0u Bolus 0.6u Deliver Bolus</p>	<p>There are no blood glucose (BG) meter readings or sensor glucose (SG) values available.</p> <p>You can enter a carb amount for a food bolus or a blood glucose (BG) meter reading for a correction bolus.</p>
 <p>Bolus 9:00 AM BG recommended Carbs 10g 0.6u Adjustment 0.0u Bolus 0.6u Deliver Bolus</p>	<p>The BG recommended message indicates that neither a blood glucose (BG) meter reading nor a sensor glucose (SG) reading is available to calculate a correction bolus.</p>

Bolus screen	Glucose reading information
	<p>Note: If a sensor glucose (SG) value shows on the Home screen, but does not show on the Bolus screen, the system determined that the sensor glucose (SG) value is not optimal to use to calculate a correction bolus. Enter a blood glucose (BG) meter reading if a correction bolus is desired.</p>

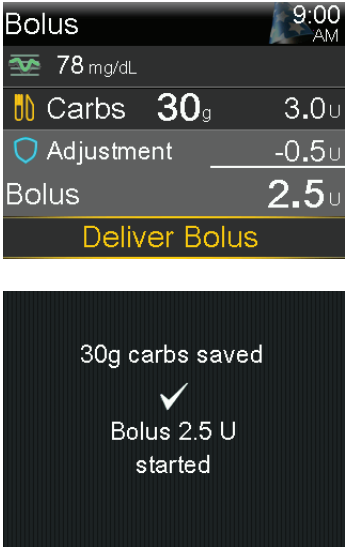

Bolus adjustments in the SmartGuard feature

The SmartGuard feature calculates a bolus based on the current BG or SG reading and carbs, and may make an additional adjustment to the bolus.

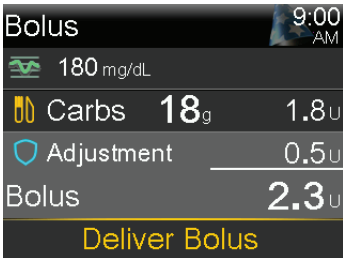
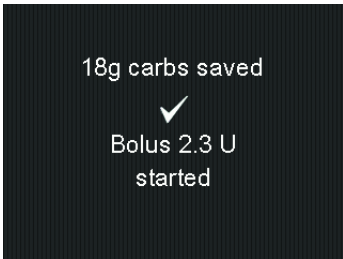
Bolus adjustment	Example screens
<p>The bolus amount is adjusted down if the SmartGuard feature predicts a risk of hypoglycemia after the meal.</p> <p>Carbs are saved for use in future bolus adjustment calculations.</p>	

Bolus adjustment	Example screens
<p>If the bolus amount is adjusted down to 0.0 for the bolus, no bolus is delivered.</p> <p>Carbs are saved for use in future bolus adjustment calculations.</p>	 
<p>The bolus amount is adjusted up if a correction bolus is calculated based on high glucose and low active insulin.</p> <p>Carbs are saved for use in future bolus adjustment calculations.</p>	 

To deliver a bolus with the SmartGuard feature:

1. From the Home screen, press , and then select .
2. Select **Bolus**.
3. Enter a carb amount, if desired.

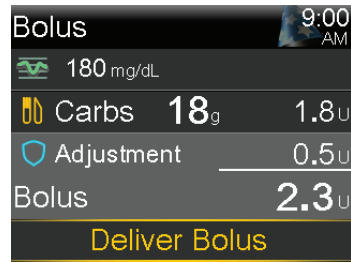

The screen indicates the amount of the calculated bolus.



4. Select **Deliver Bolus**.

A screen appears briefly to indicate the bolus delivery has started. The Home screen appears and shows the progress of the bolus delivery.



Note: To stop a bolus, press  from the Home screen, select , and then select **Stop Bolus**. Select **Yes** to confirm.



Setting a temp target

A temporary target (temp target) of 150 mg/dL can be set for events such as exercise or other times when less insulin is needed. Consult a healthcare professional before using a temp target.



Note: The Auto correction feature is not active during an active temp target. It resumes after the temp target completes.

To set a temp target:

1. From the Home screen, press , and then select .
2. Select **Temp Target** to turn the feature on or off.



3. Set the duration, from 30 minutes to 24 hours, in 30-minute increments.

4. Select **Start**.

The screen shows a Temp Target Started message, and then changes to the Home screen, where a banner shows the remaining temp target time.



To cancel a temp target:

1. From the Home screen, press , and then select .

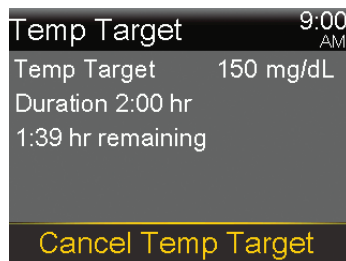

2. Select **Cancel Temp Target**.

Staying in the SmartGuard feature

When the pump requires an action to stay in the SmartGuard feature, it delivers insulin at a fixed basal rate for up to a maximum of four hours. The message “Exit in X:XX hr”

appears on the Home screen, showing the time remaining before the pump enters Manual mode. The basal rate delivered during this time is based on insulin delivery history and represents a delivery rate that minimizes the risk of hypoglycemia in situations when SG values are temporarily unavailable. The pump provides a notification of any required actions.

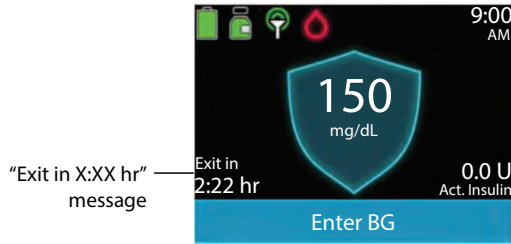

The pump resumes using SG readings for basal insulin delivery when certain conditions are met. The following table describes these conditions and the notification and required action to resume using SG readings for basal insulin delivery.

Condition	Notification and action
The SmartGuard feature has reached the time limit for minimum delivery. The minimum delivery time is three to six hours, depending on the reason.	A SmartGuard min delivery alert appears. Enter a BG.
The SmartGuard feature has been delivering basal insulin at its maximum limit for seven hours.	A SmartGuard max delivery alert appears. Check the SmartGuard Checklist to determine the required steps. Enter a BG.
SG readings may be lower than actual glucose values.	An Enter BG alert appears. Enter a BG.
No SG data has been received for more than five minutes.	<ul style="list-style-type: none"> If SG data is not available, three dashes appear on the screen in place of the SG data. If the

Condition	Notification and action
	<p>loss of SG data is intermittent, no action is required.</p> <ul style="list-style-type: none"> • If an action is not required, an alert appears such as a Lost sensor signal alert. • If SG data is not available because sensor calibration is required, the Enter BG now alert appears. Calibrate the sensor. See <i>CGM (sensor) alarms, alerts, and messages, page 311</i>.



Note: When the sensor is changed, the pump delivers basal insulin based on insulin delivery history, not SG readings, for up to four hours. Enter a BG reading to calibrate the sensor and to keep the SmartGuard feature active. For more information, see *Entering a blood glucose (BG) meter reading, page 100*.

Exiting the SmartGuard feature

The SmartGuard feature may stop functioning under the following conditions:

- The SmartGuard feature is turned off.
- The pump is delivering basal insulin based on insulin delivery history, and not SG readings, for four hours. See *Staying in the SmartGuard feature, page 200*.
- All insulin delivery has been manually suspended and has not resumed for four hours.
- The Sensor feature is turned off or the transmitter is disconnected.

The SmartGuard feature can be turned off at any time. For more information, see *Setting up the SmartGuard feature, page 185*.

Returning to the SmartGuard feature after an exit

The pump indicates any required actions on the Home screen, after an exit from the SmartGuard feature. In the example below, a BG entry is needed. Once the BG is entered, the pump resumes using the SmartGuard feature.



While in Manual mode, resume using the SmartGuard feature by meeting all requirements in the SmartGuard Checklist. For more information, see *SmartGuard Checklist*, page 187.

The SmartGuard feature can be resumed under the following conditions:

- The SmartGuard feature is turned on.
- The sensor is providing SG readings.
- A bolus is not in progress.
- A temp basal rate is not in progress.
- The 48-hour warm-up is complete.
- The SmartGuard feature is not in a five-hour warm-up period.
- A new BG reading is entered.

If any of these conditions are not met, the SmartGuard feature cannot restart.

Using Block mode with the SmartGuard feature

Block mode lets caregivers lock the pump to restrict access to critical pump features. While the pump is locked, Auto Basal delivery is active, and Auto correction boluses can occur if the feature is turned on. BG readings received from the Accu-Chek™* Guide Link meter can be confirmed. For more information on Block mode, see *Block mode*, page 208.

Alert silence feature

The Alert silence feature silences certain sensor alerts for a set period of time. For more information, see *Silencing sensor alerts*, page 175.



9



General settings

9



General settings

This chapter provides information about common tasks for various settings.

Time and date

Confirm that the time and date are always set correctly on the MiniMed 780G insulin pump. Incorrect time and date settings can affect basal insulin delivery and the accuracy of pump history. Change the time or the date to match the time zone or daylight saving time. After the time and date are changed, the pump adjusts all settings automatically.



To change the time and the date:

1. From the Home screen, press , and then select .
2. Select **Device Settings > Time & Date**.
3. Select and change the **Time**, **Time Format**, or **Date** as necessary. If a 12-hour clock is being used, specify AM or PM.
4. Select **Save**.

Display options

The brightness of the pump screen can be controlled from the Display Options screen. The duration the backlight is on can also be adjusted.

To adjust the display options:

1. From the Home screen, press , and then select .
2. Select **Device Settings** > **Display**.
3. Select **Brightness** to adjust the brightness of the screen. A level from 1 to 5 can be set, or select **Auto** for the screen to automatically adjust to the current environment.
4. Select **Backlight** to adjust the timeout for the backlight on the pump screen. Select 15 seconds, 30 seconds, 1 minute, or 3 minutes.
5. Select **Save**.



Note: The brightness and backlight can affect the life of the battery. Use a lower brightness level setting, and set the backlight timeout to 15 or 30 seconds to help the battery last longer.



CAUTION: Inactivity can cause the pump screen to go dark. If **Save** is not selected after settings are entered, the pump loses the unsaved changes two minutes after the screen goes dark from inactivity.

Block mode

Block mode lets caregivers lock the pump to restrict access to critical pump features. While the pump is in Block mode, the pump automatically locks two minutes after the screen goes dark from inactivity.



WARNING: Always monitor the pump while it is locked. The pump can still be manually suspended while locked using the shortcut to the Status screen, which could result in hyperglycemia and ketoacidosis.

The following are examples of functions that are blocked while the pump is locked:



- Access the Menu screen.
- Deliver a bolus

- Start a new basal pattern
- Start a new temp basal delivery
- Change settings

The following are examples of important functions that remain available while the pump is locked:

- Previous bolus and basal deliveries continue normally
- Stop a bolus delivery using the shortcut to the Status screen
- Suspend and resume insulin delivery using the shortcut to the Status screen
- Receive sensor glucose (SG) values and blood glucose (BG) meter readings
- Clear alarms and alerts

To turn Block mode on or off:

1. From the Home screen, press , and then select .
2. Select **Device Settings** > **Block Mode**.
3. Select **Block Mode** to turn the feature on or off.
4. Select **Save**.

The pump is in Block mode, but it is not yet locked.

To lock the pump:

Press and hold  to manually enter Sleep mode.

The pump locks when it goes to sleep. While the pump is locked,  appears on the Home screen.

To unlock the pump:

1. Press any button to wake up the pump.
2. Press .

The Screen locked message appears.

3. Press and hold .



Note: When the pump goes to sleep it will lock again.

Self Test

The **Self Test** option can be used for maintenance or to confirm the pump is operating properly. Self test is additional to the routine tests that run independently while the pump operates.





Note: Insulin delivery is suspended for up to two minutes while the pump runs a self test.

The **Self Test** option includes the following tests. Observe the pump during these tests.

Test	Description
Display	The display turns on for up to 45 seconds.
Notification light	The notification light turns on for three seconds, and then it turns off.
Vibration	Two vibration tones are generated.
Tone	An alert tone, an Easy bolus step tone, and an alarm tone are generated.

To run the self test:

1. From the Home screen, press , and then select .
2. Select **Device Settings > Self Test**.

A message confirms self test is in progress.

Self test takes up to two minutes to complete. During that time, the display briefly turns white, the notification light blinks, the pump vibrates and then beeps.

If self test does not detect a problem, the Device Settings screen appears. If a problem is detected, a message appears with more information.

If an error message appears or the pump does not perform as indicated during the test, contact 24-Hour Technical Support.

Manage Settings

The Manage Settings screen includes the following options:





- **Save Settings**
- **Restore Settings**
- **Clear All Settings**
- **Clear Active Insulin**
- **Settings History**

For information on how to use these options, see the procedures in this section.

Saving the settings

The Save Settings option saves a record of the settings to restore the settings at a later date, if necessary.

To save the current settings:

1. From the Home screen, press , and then select .
2. Select **Device Settings** > **Manage Settings**.
3. Simultaneously press and hold  and  until the Manage Settings screen appears.
4. Select **Save Settings**.





If these are the first settings saved, a message confirms that the settings are saved.

If the settings have been saved previously, a screen asks to replace the previous settings with the current settings. Select **Yes** to accept. Select **No** to cancel.

Restoring the settings

The **Restore Settings** option replaces the current pump settings with the last settings that were saved. The **Restore Settings** option is available only if settings were previously saved.

To restore the previous settings:

1. From the Home screen, press , and then select .
2. Select **Device Settings** > **Manage Settings**.
3. Simultaneously press and hold  and  until the Manage Settings screen appears.
4. Select **Restore Settings**.
A screen asks to confirm.
5. Select **Yes** to accept. Select **No** to cancel.

Clearing the settings



The **Clear All Settings** option erases the current settings and returns them to the factory defaults. After the settings are cleared, the Startup Wizard appears and pump settings can be re-entered. The settings must be entered to continue using the pump.



The Clear All Settings option does not delete paired devices, such as the sensor or meter.



CAUTION: Do not clear the pump settings unless directed by a healthcare professional. If pump settings are cleared they must be re-programmed as directed by a healthcare professional.

To clear all settings:

1. Disconnect the pump from the body.
2. From the Home screen, press , and then select .
3. Select **Device Settings** > **Manage Settings**.

4. Simultaneously press and hold  and  until the Manage Settings screen appears.
5. Select **Clear All Settings**.
A screen asks to confirm.
6. Select **Yes** to continue. Select **No** to cancel.
After the settings are cleared, the Startup Wizard appears. For more details on entering the startup settings, see *Startup settings*, page 74.





Clearing the active insulin

Use the **Clear Active Insulin** option to use the pump with insulin for the first time. This option clears the TDD and any active insulin values that the pump has tracked.

After the existing insulin values are cleared, it sets the active insulin value to zero. If bolus delivery was practiced with the pump prior to using the pump with insulin, the active insulin must be cleared. Clearing active insulin confirms that the Bolus Wizard feature has an accurate active insulin amount for bolus calculations.

Active insulin can be cleared only once. After the active insulin is cleared, this option is no longer available.

To clear the active insulin:

1. From the Home screen, press , and then select .
2. Select **Device Settings > Manage Settings**.
3. Simultaneously press and hold  and  until the Manage Settings screen appears.
The Manage Settings screen appears. If the active insulin has never been cleared, the **Clear Active Insulin** option appears.

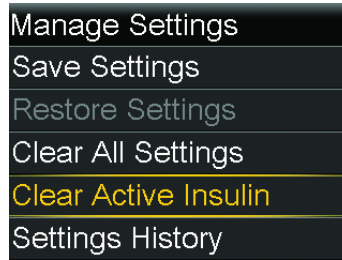





Note: If the **Clear Active Insulin** option does not appear on the Manage Settings screen, the active insulin has already been cleared.

4. Select **Clear Active Insulin**.
A screen asks to confirm.
5. To clear the active insulin, select **Clear**. If the active insulin should not be cleared, select **Cancel**.
A message confirms that the active insulin is cleared.

Viewing the pump setting history

The **Settings History** option shows a history of activities performed through the Manage Settings screen, such as when pump settings were saved, restored, or cleared.

To view the pump setting history:



1. From the Home screen, press , and then select .
2. Select **Device Settings** > **Manage Settings**.
3. Simultaneously press and hold  and  until the Manage Settings screen appears.
4. Select **Settings History**.

Auto suspend

Auto suspend is a safety feature that stops all insulin delivery and sounds an alarm if a button is not pressed within a specified period of time. Consult a healthcare professional about how to best use this feature.

Auto suspend continues to work if the SmartGuard feature is active.



To set up auto suspend:

1. From the Home screen, press , and then select .
2. Select **Device Settings** > **Auto Suspend**.
3. Select **Alarm**.
4. Select **Time** and enter the number of hours.
5. Select **Save**.

Language

The language that the pump uses to show information can be updated after the startup.

To change the language:

1. From the Home screen, press , and then select .
A checkmark indicates which language is active.
2. Select **Device Settings** > **Language**.
3. Select a language.
A screen asks to confirm.
4. Select **Yes** to accept. Select **No** to cancel.



10

History and graph

10

History and graph

This chapter provides information about how to read historical data in the MiniMed 780G system.

Introduction

The History screens provide details about personal therapy history in the MiniMed 780G insulin pump. The SG Review and Graph screens are available if the Sensor feature is turned on. The Time in Range screen shows the percent of time glucose levels are between 70 mg/dL and 180 mg/dL.

History & Graph menu



The History & Graph menu provides information about insulin delivery, blood glucose (BG) meter readings, sensor glucose (SG) values, paired sensors, and any alarms and alerts received.

History

Summary screen

The Summary screen displays information about past insulin deliveries, SG readings, and meter readings. Historical details can be viewed for a single day or for multiple days.

To view the Summary screen:

1. From the Home screen, press , and then select .
2. Select **History** > **Summary**.

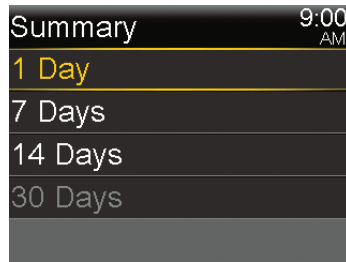

3. Select the desired time period for the Summary screen.

The Summary screen appears and displays information for the number of days selected.



4. Scroll down to view the entire screen. In the **1 Day** view, use the < and > buttons on the pump to view the history of a specific day.

Understanding the Summary screen

The Summary screen separates information into the following categories:

- Time in range information
- Insulin delivery overview
- Bolus Wizard
- Bolus in the SmartGuard feature
- BG
- Sensor
- Low management mode

Summary screen: Time in SmartGuard and Time in range information

The following table describes the Time in SmartGuard, Time in Target Range, Time below range, and Time above range portions of the Summary screen.

Name	Description
Time in SmartGuard	number of hours / percent of time in the SmartGuard feature
Time in Target Range	number of hours / percent of time in target range (70 mg/dL to 180 mg/dL)
Time below range	number of hours / percent of time below target range (below 70 mg/dL)
Time above range	number of hours / percent of time above target range (above 180 mg/dL)

Summary screen: insulin delivery overview

If **1 Day** view is selected, the values are shown for that day. If multiple days are selected, the values shown are an average of the values for the selected number of days.

Name	Description
TDD	Total daily dose of insulin units.
Basal	<ul style="list-style-type: none"> Insulin units devoted to basal delivery. Percentage of insulin devoted to basal delivery.
Bolus	<ul style="list-style-type: none"> Insulin units devoted to bolus delivery. Percentage of insulin devoted to bolus delivery.
Total Carbs	Daily carbohydrate amount, in grams.

Summary screen: Bolus Wizard

If **1 Day** view is selected, the values are shown for that day. If multiple days are selected, the values shown are an average of the values for the selected number of days.

Name	Description
Carb bolus	<ul style="list-style-type: none"> Total insulin units delivered using the Bolus Wizard feature with food amount or with food and glucose correction. Number of times the Bolus Wizard feature delivered a food bolus or a food plus correction bolus.

Name	Description
Glucose correction only	<ul style="list-style-type: none"> Total insulin units delivered using the Bolus Wizard feature or a bolus with BG correction amount only. Number of times the Bolus Wizard feature delivered a correction bolus.

Summary screen: SmartGuard

If **1 Day** view is selected, the values are shown for that day. If multiple days are selected, the values shown are an average of the values for the selected number of days.

Name	Description
Auto Correction	Total insulin units delivered by the Auto correction feature.
Bolus	<ul style="list-style-type: none"> Total insulin units delivered using the SmartGuard bolus feature. Number of times the SmartGuard bolus feature was used.

Summary screen: BG

The pump is only compatible with the Accu-Chek™* Guide Link meter.

Name	Description
BG	Total number of BG meter readings, including readings from an Accu-Chek™* Guide Link meter and BG meter readings entered manually.
Average BG	Average BG meter readings.
BG Std. Dev.	Standard deviation of BG meter readings.
Low BG	Lowest BG meter reading.
High BG	Highest BG meter reading.

Summary screen: sensor

The sensor portion appears if a sensor has been used at least once.

Name	Description
SG Average	Average SG reading.

Name	Description
SG Std. Dev.	Standard deviation of the SG readings.

Summary screen: low management mode

For information about the Suspend before low and Suspend on low features, see *Low SG settings, page 154*.



Name	Description
Suspend before low	The average number of Suspend before low events per day.
Suspend on low	The average number of Suspend on low events per day.
Time suspended by sensor	The average duration (amount of time) suspended as a result of Suspend before low or Suspend on low events per day.

Daily History screen

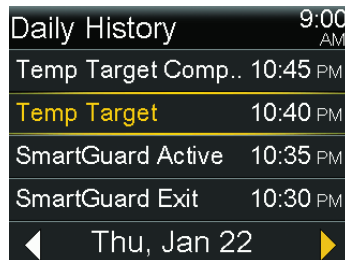
Actions performed on the pump can be viewed on the Daily History screen for the selected day. The list shown on the screen provides further details and shows the most recent action first.



To view the Daily History screen:



1. From the Home screen, press , and then select .
2. Select **History** > **Daily History**.
A list of dates appears.

3. Select a specific date. A list appears with any pump actions or events entered on the specified day.
4. Select any item in the list to open the Detail screen and view more information about the selected action or event.

Alarm History screen

Select a specific day to view the history of alarms and alerts that occurred on the selected day. The list provides further details and shows the most recent alarm or alert first.

To view the Alarm History screen:



1. From the Home screen, press , and then select .
2. Select **History > Alarm History**.
A list of dates appears.
3. Select a specific date. A list appears showing any alarms or alerts that occurred on the specified day.
4. Select any alarm or alert in the list to open the Detail screen and view more information about the selected alarm or alert.

Paired Sensors screen

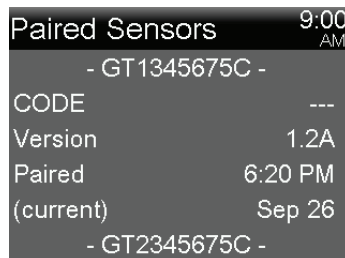
The Paired Sensors screen displays the serial number, date, and time of the current transmitter paired to the pump. The screen also provides a history of the transmitters that were paired with and unpaired from the pump. The code is not applicable for the MiniMed 780G insulin pump with the Guardian Sensor (3) sensor.



To view the Paired Sensors screen:



1. From the Home screen, press , and then select .
2. Select **History > Paired Sensors**.
A list of transmitters appears.
3. Scroll down to view the entire screen.

SG Review screen

Pair the pump with a sensor to view a graph of SG history based on high and low limits entered. Information can be viewed for one day or refer to an average of SG data over multiple days.

High and low limits set in the SG Review screen are only used to view SG data. These limits are not the same as the high and low glucose limits used for SG alerts. Changing the limits in the SG Review screen will not affect the high and low glucose limits used for the SG alerts.

To review the SG history:

1. From the Home screen, press , and then select .
2. Select **Sensor Glucose Review**.

The SG Review screen appears. The high and low limits that appear are either the values entered for the last SG Review, or the default values of 180 mg/dL for the high limit and 70 mg/dL for the low limit.

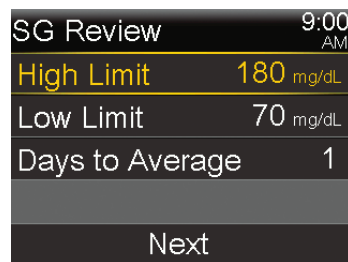

3. Enter the High Limit and Low Limit for the SG data review.

There must be a minimum of 20 mg/dL difference between the High Limit and the Low Limit.

4. Enter the number of days of SG history to average, and select **Next**.

If only one day is entered, the graph shows details about when the SG was above, below, or within the specified limits. Use the arrow keys to see the data for specific dates. Press ∇ to see information about the time that SG was above, within, or below range. A message appears and states there is no data available if no data was saved.

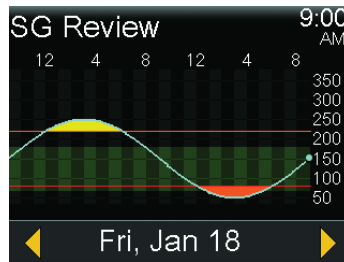

If multiple days are entered, the pie chart shows the average percentage of time that the SG was above, below, or within the specific limits over an average of multiple days. A message appears and states there is no data available if no data was saved.

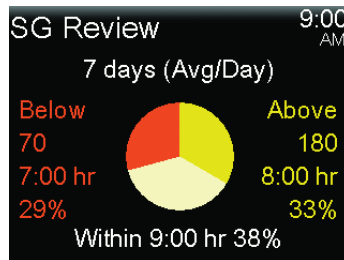

Graph screen

The graph shows information about the SG readings and trends, BG entries, auto correction bolus deliveries, and bolus entries. The below screen is an example of the graph screen using the SmartGuard feature.

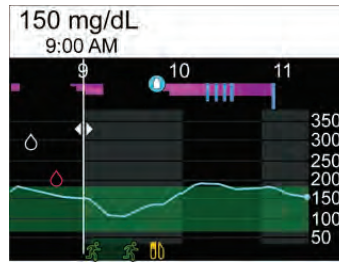

To view the Graph screen:

- Press , or select **Graph** on the History & Graph screen.



Time in Range screen

Time in range is the percentage of time SG is between 70 mg/dL and 180 mg/dL. These values cannot be changed. Use the Time in Range screen to see how much time is spent below, above, and within range in the last 24 hours.

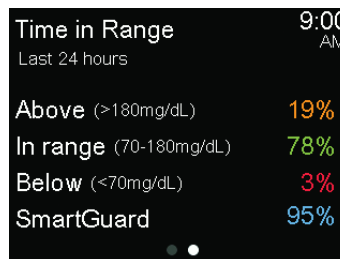
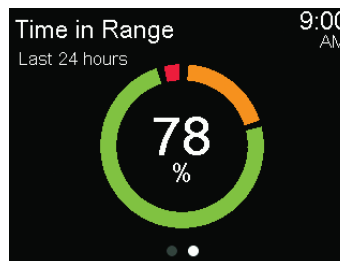
When using CGM, the following information can be viewed:



To view the Time in Range screen:

1. From the Home screen, press , and then select .
2. Select **Time in Range**.

11



Notifications and reminders

11

Notifications and reminders

This chapter describes how to use reminders. It also covers the general behavior of the most common and the most serious notifications and how to resolve them.

Notifications in the MiniMed Mobile app

If the MiniMed Mobile app is used, alarms, alerts, and messages can be viewed on the paired mobile device. For information about how to set the notification preferences in the app, see the MiniMed Mobile app user guide. For a table that describes the meaning, consequences, reasons, and resolutions for the most common or serious notifications, see *Pump alarms, alerts, and messages, page 299*.



WARNING: Do not rely on the MiniMed Mobile app to view all alerts. Alerts will not appear on the MiniMed Mobile app during reservoir set up. Some alerts may only appear on the pump. In some cases, alerts could be sent to the MiniMed Mobile app after they appear on the pump. Relying on the MiniMed Mobile app for all alerts could result in an alert being missed, which may lead to hypoglycemia or hyperglycemia.



Reminders

There are several specific reminders that prompt a specific action. Personal reminders can be used for any purpose. If the sensor feature is turned on, a Calibration reminder appears when it is time to calibrate the sensor.

Personal reminders

Up to six personal reminders can be set, along with the specific reminders for blood glucose (BG) meter readings and medication.

To create a new Personal reminder:



1. From the Home screen, press , and then select .
2. Select **Alert Settings > Reminders > Personal**.
3. Select **Add New**.

The Select Name screen shows the available reminders.

4. Select a reminder.
An edit screen appears for the selected reminder.
5. Enter the time the reminder should occur.
6. Select **Save**.

The Personal reminder occurs at the specified time each day unless it is edited or deleted.



To edit, rename, or delete an existing Personal reminder:

1. From the Home screen, press , and then select .
2. Select **Alert Settings > Reminders > Personal**.
3. Select a reminder.
4. Do any of the following:
 - Select **Reminder** to turn the reminder on or off.
 - Select **Edit** to change the time of the reminder.
 - Select **Rename** to assign a different name to the reminder. When the Select Name screen appears, select any available name from the list.
 - Select **Delete** to delete the reminder.

Bolus BG Check reminder

The Bolus BG Check reminder notifies when BG needs to be checked after a bolus delivery. After a bolus is started, the BG Check screen appears and the timer must be set for the reminder. The timer counts down from the time the bolus was started.

To turn on or turn off Bolus BG Check reminders:

1. From the Home screen, press , and then select .
2. Select **Alert Settings** > **Reminders** > **Bolus BG Check**.
3. To turn the reminder on or off, select **Reminder**.
4. Select **Save**.

To use a Bolus BG Check reminder if a bolus is being delivered:

1. If the Bolus BG Check reminder is on, the BG Check screen appears each time a bolus is started.

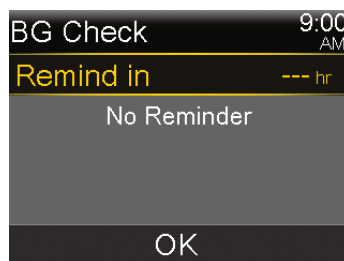



2. Enter a time between 30 minutes and 5 hours and select **OK**. If no reminder is necessary after the bolus delivery, select the dashes without adding a time, and select **OK**.



Missed Meal Bolus reminder

Missed Meal Bolus reminders can be set up around typical meal times. Up to 8 reminders can be set.

To create a new Missed Meal Bolus reminder:

1. From the Home screen, press , and then select .
2. Select **Alert Settings** > **Reminders** > **Missed Meal Bolus**.
3. Select **Add New**.
4. Select **Start Time** and enter a time.
5. Select **End Time** and enter a time.
6. Select **Save**.

To turn on or off, edit, or delete existing Missed Meal Bolus reminders:

1. From the Home screen, press , and then select .
2. Select **Alert Settings** > **Reminders** > **Missed Meal Bolus**.
3. Select a reminder.
4. Change any of the following:
 - Select **Reminder** to turn this reminder on or off.
 - Select **Edit** to change the time of this reminder.
 - Select **Delete** to delete this reminder.

Low Reservoir reminder

Set a Low Reservoir reminder to occur when the insulin level in the reservoir reaches a specified number of units and again when half of those units have been used.





Note: The number of units that remain in the reservoir can be found on the Pump status screen. For more information, see *Status screen*, page 83.



WARNING: Always check the amount of insulin left in the reservoir when the Low reservoir alert occurs. Confirm that the MiniMed 780G insulin pump has sufficient insulin. The insulin level in the reservoir can reach a low level during a bolus delivery or fill cannula delivery. If this occurs, the Low reservoir alert displays. If the pump does not have sufficient insulin, under-delivery of insulin can occur, which may cause hyperglycemia.



To set up the Low Reservoir reminder:

1. From the Home screen, press , and then select .
2. Select **Alert Settings** > **Reminders** > **Low Reservoir**.
3. Select **Units** to enter the number of units. Set a value from 5 to 50 units.
4. Select **Save**.

Set Change reminder

The Set Change reminder tracks the time between infusion set changes and provides a reminder to change the infusion set.

To turn on or off, or edit the Set Change reminder:

1. From the Home screen, press , and then select .
2. Select **Alert Settings** > **Reminders** > **Set Change**.
3. Select **Reminder** to turn the reminder on or off.
4. Select **Time** and choose the number of days needed for the reminder.
5. Select **Save**.





WARNING: When changing the Set Change reminder, do not set a duration greater than what is indicated on the infusion set labeling. If the infusion set is labeled for three days then the reminder must only be set to two or three days.

Calibration reminder

When using a sensor, the Calibration reminder indicates when calibration is needed. For example, if the reminder is set to 4 hours, a Calibration expires message appears 4 hours before a BG meter reading is required for calibration.

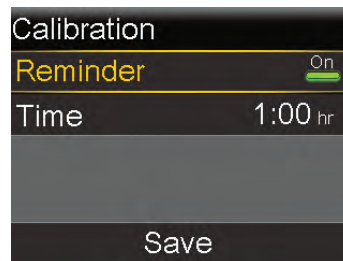

To turn on or off, or change the Calibration reminder:

1. From the Home screen, press , and then select .
2. Select **Alert Settings** > **Reminders** > **Calibration**.



3. Select **Reminder** to turn the reminder on or off.
4. Select **Time**, and enter a time between 5 minutes and 6 hours.
5. Select **Save**.

Alarms, alerts, and messages

The pump has a sophisticated safety network. If this safety network detects anything unusual, it communicates this information in the form of notifications. Notifications include alarms, alerts, and messages. When more than one notification is received, and there are multiple messages to view, a small white flap appears on the notification icon in the upper-right corner of the screen . When the first notification is cleared, the next notification becomes visible. A white triangle in the lower right corner means that  must be pressed to continue.



Note: The notification light flashes when the pump has an alarm or alert.



Note: Promptly address all notifications and confirmations that appear on the pump screen. The notification will remain on the pump screen until it is cleared. When responding to a message, there may be times when another message appears.



WARNING: When a critical pump error occurs, the following screen appears and the pump siren goes off:



Immediately disconnect the pump and discontinue use. Contact 24-Hour Technical Support.

Insulin delivery is still required when the pump is removed. Consult a healthcare professional to determine an alternate method of insulin delivery while the pump is removed.

Alarms

An alarm warns of a condition that requires immediate attention. Stopped insulin delivery and low glucose levels are the most common reasons for alarms.

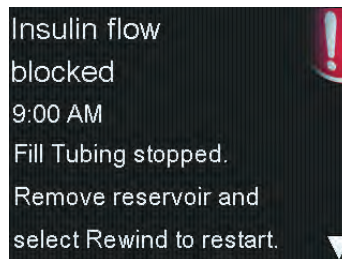

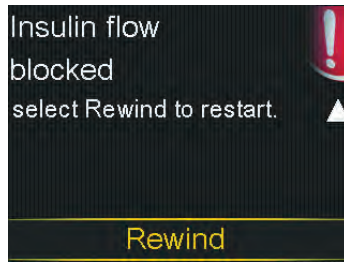

WARNING: Always address alarms immediately when they occur. Ignoring an alarm can result in hyperglycemia or hypoglycemia.

When an alarm occurs:

Display: The pump displays a notification with a red icon and instructions.

Notification light: The red notification light blinks twice, followed by a pause, in a continuous repeating pattern.

Audio: Depending on the sound and vibration settings, the pump emits an alarm tone, a continuous three-pulse-and-pause vibration pattern, or both the alarm tone and vibration.

The underlying problem that triggered the alarm must be resolved. In most cases, press  and then make a selection to clear the alarm. Sometimes the underlying problem is not resolved when the alarm is cleared. The alarm repeats until the underlying problem is fixed. If the alarm condition is not resolved after 10 minutes, the alarm tone escalates to a loud emergency siren.

Alerts

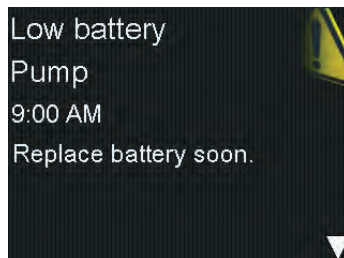

Alerts indicate that a situation may require attention. When an alert occurs, check the pump screen to see if any action is required.

When an alert occurs:

Display: The pump displays a notification with a yellow icon and instructions.

Notification light: The red notification light on the pump blinks once, followed by a pause, then blinks once again in a continuous repeating pattern.

Audio: Depending on the sound and vibration settings, the pump beeps, vibrates in a continuous three-pulse-and-pause pattern or does both.

To clear an alert, press  and then make a selection. The pump beeps every 5 minutes or every 15 minutes, depending on the alert, until the alert is resolved. Some alerts will also escalate to a loud emergency siren after 10 minutes.



Note: If an alert occurs when the pump is on a screen other than the Home screen, the alert message may only appear after the pump returns to the Home screen.

Messages

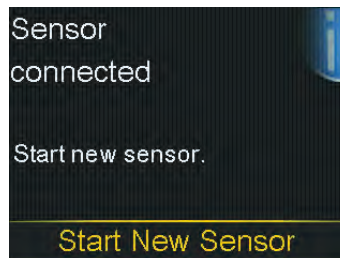

A message is a notification that shows the status of the pump or displays when a decision needs to be made.

When a message occurs:

Display: The pump displays a notification with a blue icon and instructions.

Notification light: The red notification light on the pump does not blink.

Audio: Depending on the sound and vibration settings, the pump emits a tone, a one-pulse-only vibration, or it emits a tone and a one-pulse-only vibration. To clear a message, press  and then make a selection.

Pump alarms, alerts, and messages

For a table that describes the meaning, consequences, reasons, and resolutions for the most common or serious notifications, see *Pump alarms, alerts, and messages, page 299*.

12



Additional basal features

12



Additional basal features

This chapter provides information about setting up additional features for basal insulin delivery.

Preset temp basal rates

Set up preset temp basal rates for reoccurring short-term situations. Up to four preset temp basal rates can be set up for specific situations. There are also four additional preset temp rates available for use in other circumstances (Temp 1 through Temp 4).

To set up a preset temp basal rate:

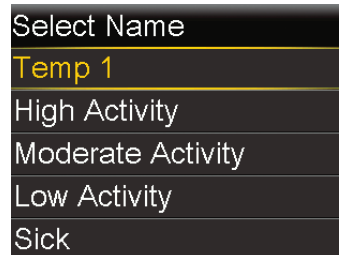

1. From the Home screen, press , and then select .
2. Select **Delivery Settings** > **Preset Temp Setup**.
3. Select **Add New**.



4. Select a name for the preset temp basal rate.
5. Select **Type** to select Percent or Rate, and then enter the percentage or the rate in units per hour.

6. Set the **Duration** for the preset temp basal rate to be active.
7. Select **Save**.

To edit, rename, or delete a preset temp basal rate:

1. From the Home screen, press , and then select .
2. Select **Delivery Settings > Preset Temp Setup**.

The Preset Temp Setup screen appears and shows the settings for any existing preset temp basal rate.

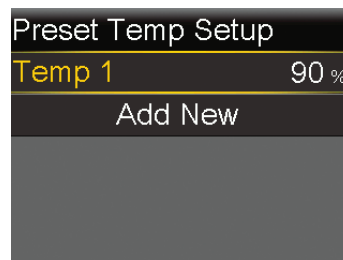

3. Select a preset temp basal rate.

A screen appears that shows the preset temp basal rate information.

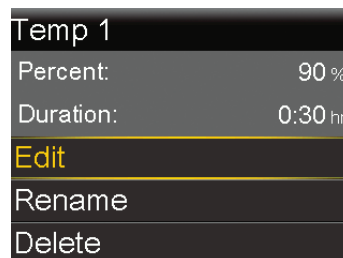

4. Do any of the following:
 - Select **Edit** to adjust the type (Percent or Rate), the percent or rate amount, and the duration.
 - Select **Rename** to assign a different name to the preset temp basal rate. When the Select Name screen appears, select any available name from the list.
 - Select **Delete** to delete the preset temp basal rate.

Starting a preset temp basal delivery

Follow the steps to use the preset temp basal rate for basal insulin delivery. If a preset temp basal rate has not yet been set up, see *Preset temp basal rates, page 243*. After the preset temp basal delivery is completed or canceled, basal insulin delivery resumes using the programmed basal rate.

To start a preset temp basal delivery:

1. From the Home screen, press , and then select .
2. Select **Basal > Preset Temp**.

The Preset Temp screen appears and shows the preset temp basal rates set up, along with their percentage or rate amounts.

Preset Temp	9:00 AM
Current rate:	0.025 U/hr
Temp 1	0.100 U/hr
High Activity	25 %
Moderate...	50 %



Note: If a percentage preset temp basal rate is set up so that it could exceed the current Max basal limit, that rate is grayed out in the list and cannot be selected.

3. Select a preset temp basal rate to start.
4. Select **Begin**.



The Temp Basal banner appears on the Home screen during delivery.



Canceling a temp basal or preset temp basal

A temp basal rate or preset temp basal rate can be canceled at any time. After it is canceled, the scheduled basal pattern automatically resumes.

To cancel a temp basal rate:

1. From the Home screen, press , and then select .
2. Select **Cancel Temp Basal**.
The Temp Basal screen appears.



3. Select **Cancel Temp Basal**.

Additional basal patterns



Adding an additional basal pattern

This procedure shows how to add a new basal pattern after at least one basal pattern has been set. If this is the first time a basal pattern is being set, see *Setting up a basal pattern*, page 90.

The following basal patterns can be set up:



- Basal 1
- Basal 2
- Workday
- Day Off
- Sick Day

To add an additional basal pattern:

1. From the Home screen, press , and then select .
2. Select **Basal > Basal Pattern Setup**.
The Basal Pattern Setup screen appears.
3. To add a new basal pattern, select **Add New**.
The Select Name screen appears.
4. Select a name for the basal pattern.
5. Set the basal rate.
6. Select **Review**.
7. Select **Save**.

Editing, copying, or deleting a basal pattern

To edit, copy, or delete a basal pattern:

1. From the Home screen, press , and then select .
2. Select **Delivery Settings > Basal Pattern Setup**.
The Basal Pattern Setup screen appears



3. Select a basal pattern.
4. Select **Options**.
5. Do any of the following:
 - Select **Edit** to adjust the end time or rate values.
 - Select **Copy** to copy the basal rate information from the selected basal pattern to a new basal pattern. When the Select Name screen appears, select any available name from the list.
 - Select **Delete** to delete the selected basal pattern. The active basal pattern cannot be deleted.

Changing from one basal pattern to another

If more than one basal pattern has been set, the basal pattern can be changed. The MiniMed 780G insulin pump delivers basal insulin according to the selected basal pattern.

To change to a different basal pattern:

1. From the Home screen, press , and then select .
2. Select **Basal > Basal Patterns**.

The Basal Patterns screen appears. A check mark displays next to the active basal pattern.

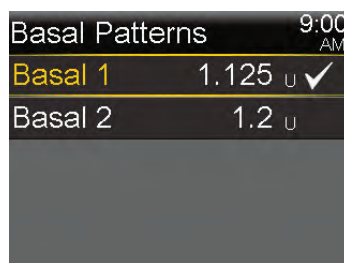

3. Select a basal pattern.

Basal 2		9:00 AM
24 hr Total: 1.2 U		
Start	End	Rate (U/hr)
12:00 _A	12:00 _A	0.050
Begin		

4. Select **Begin**.



13



Additional bolus features

13

Additional bolus features

This chapter provides information about additional features for bolus delivery. Square Wave, Dual Wave, Easy, Manual, and Preset bolus are only available in Manual mode. Since these bolus types are only available in Manual mode, remember that you must enter a blood glucose (BG) meter reading when setting up the bolus delivery. Do not use a sensor glucose (SG) value when delivering a bolus in Manual mode.

Bolus types

The following table provides general information about the available bolus types.

Bolus type	Description	Purpose
Normal	Normal bolus provides a single immediate dose of insulin.	This is the typical bolus type used to cover food intake or to correct a high blood glucose (BG) meter reading. For details about delivering a normal bolus, see <i>Normal bolus, page 109</i> .
Square Wave bolus	Square Wave bolus delivers a single bolus evenly over an extended period of time from 30 minutes up to 8 hours.	A Square Wave bolus can be used for the following reasons: <ul style="list-style-type: none"> • A delayed food digestion due to gastroparesis or meals high in fat. • Snacking over an extended period of time. • A normal bolus drops the BG too rapidly.

Bolus type	Description	Purpose
		For details about using the Square Wave bolus feature, see <i>Square Wave bolus</i> , page 259.
Dual Wave bolus	Dual Wave bolus delivers a combination of an immediate normal bolus followed by a Square Wave bolus.	<p>A Dual Wave bolus can be used for the following reasons:</p> <ul style="list-style-type: none"> • When meals are high in carbs and fat, which may delay digestion. • When a meal bolus is combined with a correction bolus for an elevated BG. <p>For details about using a Dual Wave bolus, see <i>Dual Wave bolus</i>, page 263.</p>

Bolus type example

The following example shows how the different bolus types work.

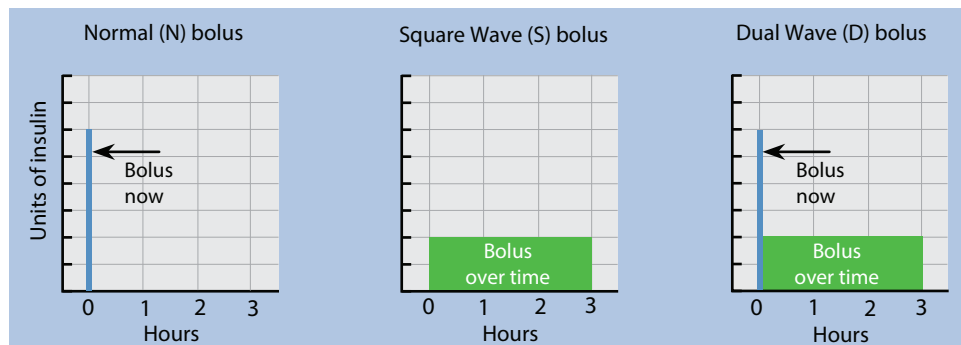

Bolus settings



Additional settings are required to use the Bolus Wizard feature. These are described in the section, *Bolus delivery options*, page 101.

Bolus increment

The Bolus increment is the number of units that are increased or decreased with each button press for the bolus delivery amount in the Bolus Wizard, Manual Bolus, and

Preset Bolus screens. Depending on the typical bolus amount, the increment can be set to 0.1 units, 0.05 units, or 0.025 units.

To set the bolus increment:

1. From the Home screen, press , and then select .
2. Select **Delivery Settings** > **Bolus Increment**.
3. Select **Increment** to set the desired increment value.

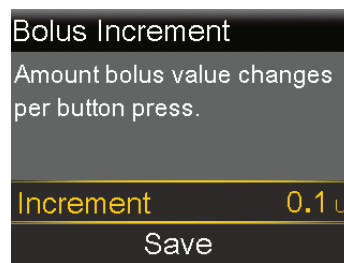



4. Select **Save**.

Bolus speed

The bolus speed sets the rate at which the pump delivers bolus insulin. Set a standard rate (1.5 units per minute), or a quick rate (15 units per minute).

To set the bolus speed:

1. From the Home screen, press , and then select .
2. Select **Delivery Settings** > **Bolus Speed**.
3. Select **Standard** or **Quick**.

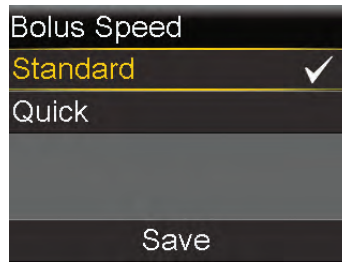

4. Select **Save**.



Changing the Bolus Wizard settings

This section shows how to make changes to personal settings after the initial Bolus Wizard feature setup. Consult a healthcare professional before changes are made to the personal settings.

Changing the carb ratio

The carb ratio can be set whether or not the Bolus Wizard feature is turned on.

To change the carb ratio:

1. From the Home screen, press , and then select .
2. Select **Delivery Settings > Bolus Wizard Setup > Carb Ratio**.
3. Select **Edit**.
4. Select the carb ratio. For one carb ratio, enter the g/U, and then press .

For more than one carb ratio, enter one carb ratio at a time to complete the full 24 hours, which ends at 12:00 A.







Note: For instructions on setting up more than one carb ratio over a 24-hour period, see *Settings covering a 24-hour period*, page 91.



5. Select **Save**.

Changing the insulin sensitivity factor

The insulin sensitivity factor can be set only if the Bolus Wizard feature is turned on.

To change the insulin sensitivity factor:

1. From the Home screen, press , and then select .
2. Select **Delivery Settings** > **Bolus Wizard Setup** > **Insulin Sensitivity Factor**.
3. Select **Edit**.
4. Select the insulin sensitivity factor. For one insulin sensitivity factor, press  and  to enter the mg/dL per U, and then press .

For more than one insulin sensitivity factor, press  or  to enter one insulin sensitivity factor at a time to complete the full 24 hours, which ends at 12:00 A.





Note: For instructions on setting up more than one insulin sensitivity factor over a 24-hour period, see *Settings covering a 24-hour period, page 91*.

5. Select **Save**.

Changing the BG target

The BG target can be from 60 to 250 mg/dL. The BG target can be set only if the Bolus Wizard feature is turned on.

To change the BG target:

1. From the Home screen, press , and then select .
2. Select **Delivery Settings** > **Bolus Wizard Setup** > **BG Target**.
3. Select **Edit**.
4. Select the BG target. For one BG target, enter the low BG limit and the high BG limit, and then press .

For more than one BG target, enter one BG target at a time to complete the full 24 hours, which ends at 12:00 A.



Note: For instructions on setting up more than one BG target over a 24-hour period, see *Settings covering a 24-hour period*, page 91.



5. Select **Save**.

Changing the active insulin time

Active insulin is the bolus insulin that has been delivered by the pump and is still working to lower glucose levels. In the Bolus Wizard and SmartGuard Bolus feature, the Active Insulin Time setting is used to calculate a correction bolus by subtracting the estimated active insulin from each bolus. In SmartGuard, auto correction boluses are delivered up to every 5 minutes. A shorter Active Insulin Time setting may result in more insulin being delivered in correction boluses.

A healthcare professional provides the personalized active insulin time based on historic glycemic control data for the individual user. When using SmartGuard, the recommended initial setting is an Active Insulin Time of 2-3 hours. The Active Insulin Time setting in the MiniMed 780G system is not necessarily reflective of the physiological insulin metabolism. Adjustments are not based on the pharmacokinetics and pharmacodynamics of the rapid-acting insulin. Please see *Table 7, page 364* and *Table 8, page 365* in *Performance data, page 357* for the effect of Active Insulin Time on glycemic outcomes. The current active insulin amount appears on the Home screen and includes only the bolus insulin received.

To change the active insulin time:

1. From the Home screen, press , and then select .
2. Select **Delivery Settings > Bolus Wizard Setup > Active Insulin Time**.
3. Select **Duration**, and adjust the active insulin time in hours, using 15-minute increments.

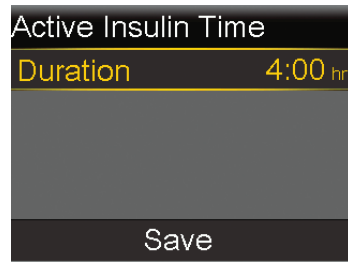

4. Select **Save**.

Square Wave bolus

A Square Wave bolus delivers a bolus evenly over a period of time from 30 minutes up to 8 hours.

When using the Bolus Wizard feature, a Square Wave bolus is available only when giving a food bolus without a correction for an elevated BG. A Square Wave bolus is not available for a correction bolus alone or a correction bolus with food bolus. A normal bolus can be delivered while a Square Wave bolus is being delivered, as needed.

A Square Wave bolus can be useful in the following situations:



- Delayed food digestion due to gastroparesis or meals high in fat.
- When snacking over an extended period of time.
- A normal bolus drops BG too rapidly.

Since the Square Wave bolus extends delivery over a period of time, the insulin is more likely to be available as needed.

Turning the Square Wave bolus feature on or off

A Square Wave bolus can be set up and delivered only after the Square Wave bolus feature is turned on.

To turn the Square Wave bolus feature on or off:



1. From the Home screen, press , and then select .
2. Select **Delivery Settings > Dual/Square Wave**.

3. Select **Square Wave** to turn the feature on or off.
4. Select **Save**.

Delivering a Square Wave bolus using the Bolus Wizard feature

The Bolus Wizard feature only delivers a Square Wave bolus if the Square Wave bolus feature is turned on and a carb value is entered. If a BG reading causes the Bolus Wizard feature to calculate that a correction bolus is necessary, then a Square Wave bolus cannot be delivered.

To deliver a Square Wave bolus using the Bolus Wizard feature:

1. From the Home screen, press , and then select .
2. Select **Bolus > Bolus Wizard**.

The Bolus Wizard screen appears.



3. For a food bolus, select **Carbs** to enter the carb count of the meal.
4. The calculated bolus appears in the Bolus field. To modify the bolus amount, select **Bolus**.
5. Select **Next** to review the bolus information.

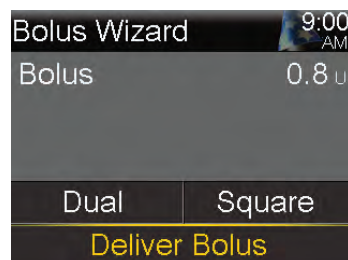

6. Select **Square**.
7. Select **Duration** to adjust the time period when the Square Wave bolus needs to be delivered.



8. Select **Deliver Bolus** to start the bolus.

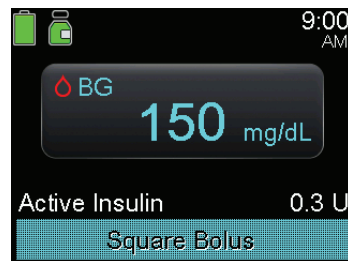



Note: To stop bolus delivery or to see details on the insulin that has been delivered, see *Stopping a Square Wave or Dual Wave bolus delivery*, page 274.

Delivering a Square Wave bolus using the Manual bolus feature

The Square Wave bolus option is available in the Manual Bolus screen only after the Square Wave feature is turned on.

To deliver a Square Wave bolus using the Manual bolus feature:

1. From the Home screen, press , and then select .
2. Do one of the following:

- Select **Bolus** if the Bolus Wizard feature is turned off.
- Select **Bolus > Manual Bolus** if the Bolus Wizard feature is turned on.

The Manual Bolus screen appears.

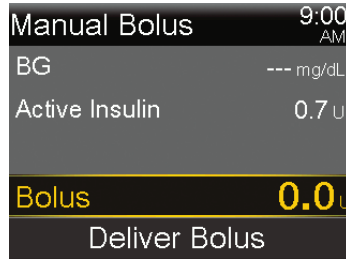

3. Set the bolus delivery amount in units, and then select **Next**.

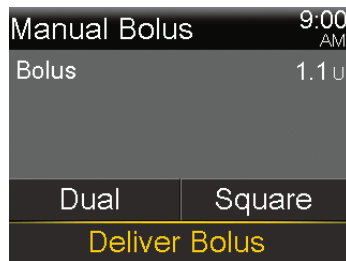

4. Select **Square**.
5. Select **Duration** to adjust the time period when the Square Wave bolus is to be delivered.
6. Select **Deliver Bolus** to start the bolus.

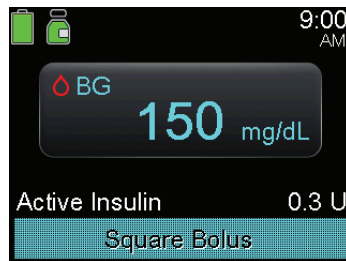



Note: To stop bolus delivery or to see details on the insulin that has been delivered, see *Stopping a Square Wave or Dual Wave bolus delivery*, page 274.

Dual Wave bolus

The Dual Wave bolus feature meets both immediate and extended insulin needs by delivering a combination of an immediate normal bolus followed by a Square Wave bolus. A normal bolus can be delivered while the Square portion of a Dual Wave bolus is being delivered, as needed.



A Dual Wave bolus can be useful in these situations:

- When an elevated BG needs to be corrected before a meal, and a delayed bolus is needed for food that is absorbed slowly.
- When eating meals with mixed nutrients, such as carbs, fats and proteins, that are absorbed at different rates.

Turning the Dual Wave bolus feature on or off

A Dual Wave bolus can be delivered only after the Dual Wave bolus feature is turned on.



To turn the Dual Wave feature on or off:

1. From the Home screen, press , and then select .
2. Select **Delivery Settings** > **Dual/Square Wave**.
3. Select **Dual Wave** to turn the feature on or off.
4. Select **Save**.

Delivering a Dual Wave bolus using the Bolus Wizard feature

A Dual Wave bolus with the Bolus Wizard feature can be delivered only after the Dual Wave bolus feature is turned on.

To deliver a Dual Wave bolus with the Bolus Wizard feature:

1. For a correction bolus or a food bolus with a correction, use a BG meter to check BG. For a food bolus only, go to step 2.
2. From the Home screen, press , and then select .
3. Select **Bolus** > **Bolus Wizard**.

The Bolus Wizard screen appears.

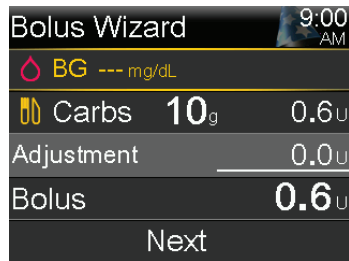

Note: For more information on how to manually enter the BG meter reading, see *Entering a blood glucose (BG) meter reading*, page 100.

4. For a food bolus, select **Carbs** to enter the carb count of the meal. For a correction bolus where no food was eaten, leave the carbs value as 0.

The calculated bolus appears in the Bolus field.

5. To modify the bolus amount, select **Bolus**.
6. Select **Next** to review the bolus information.

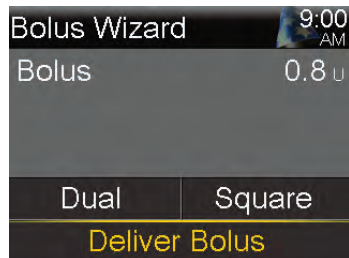

7. Select **Dual**.

The Bolus Wizard screen appears.

- To change the amounts, select the area of the screen with the Now % and Square % values and adjust the **Now** % amount.

When adjusting the Now amount, the Square amount adjusts automatically.

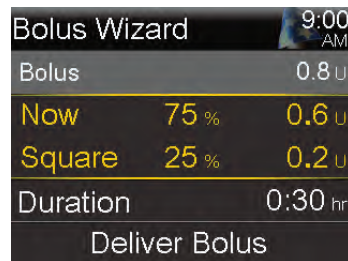

- Adjust the **Duration** of the square portion of the bolus to be delivered.
- Select **Deliver Bolus** to start the bolus.

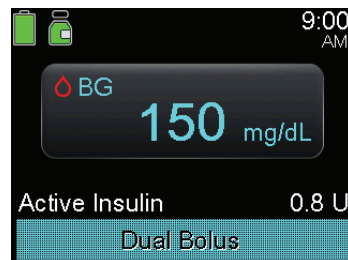

Note: To stop bolus delivery or to see details on the insulin that has been delivered, see *Stopping a Square Wave or Dual Wave bolus delivery*, page 274.

Delivering a Dual Wave bolus using the Manual bolus feature

The Dual Wave bolus option is available in the Manual Bolus screen only after the Dual Wave feature is turned on.

To deliver a Dual Wave bolus using the Manual bolus feature:

- From the Home screen, press , and then select .

2. Do one of the following:
 - Select **Bolus** if the Bolus Wizard feature is turned off.
 - Select **Bolus > Manual Bolus** if the Bolus Wizard feature is turned on.

The Manual Bolus screen appears.

3. Set the bolus delivery amount in units, and then select **Next**.

The Manual Bolus screen appears, with the option to select the bolus type.

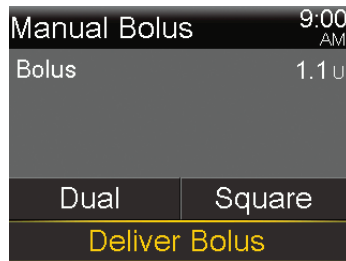

4. Select **Dual**.
The Manual Bolus screen appears.
5. To change the amounts, select the area of the screen with the Now % and Square % values and adjust the **Now** % value. When the Now amount is adjusted, the Square amount adjusts automatically.

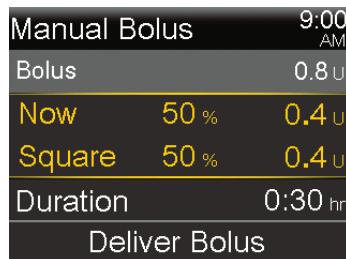

6. Select **Duration** to adjust the time period when the Square Wave bolus is to be delivered.
7. Select **Deliver Bolus** to start the bolus.

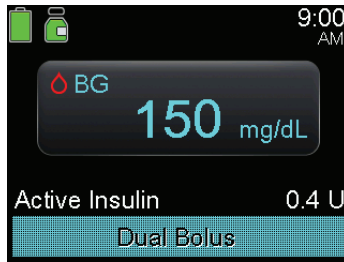

Note: To stop bolus delivery or to see details on the insulin that has been delivered, see *Stopping a Square Wave or Dual Wave bolus delivery*, page 274.

Easy bolus

The Easy bolus feature can be used to deliver a normal bolus using only the \wedge button. The Easy bolus feature only works when the pump is in Sleep mode.

When the \wedge button is pressed while the Easy bolus feature is used, the bolus amount increases by a certain amount. This amount, or step size, can be set from 0.1 to 2.0 units of insulin. The pump makes a tone or vibration each time the \wedge button is pressed to help keep count of the steps.





Note: The step size cannot be greater than the Max bolus amount. The maximum number of steps is 20 for each bolus delivery.

Setting up the Easy bolus feature

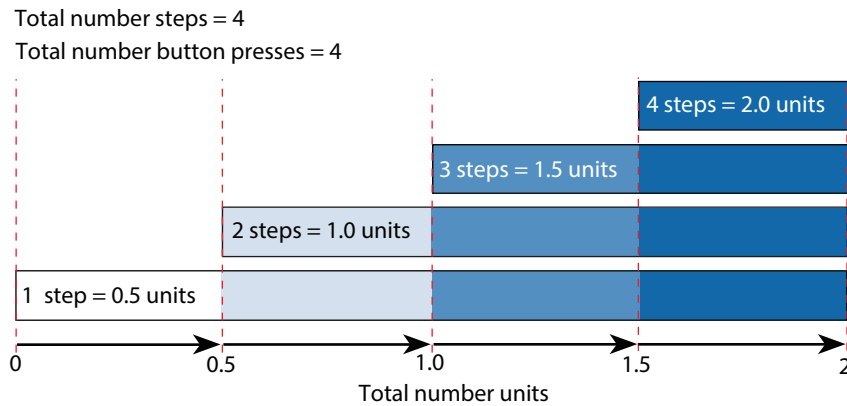
The following graph provides an example of setting up a bolus of 2.0 units of insulin using a step size of 0.5 units.



To set up the Easy bolus feature:

1. From the Home screen, press , and then select .
2. Select **Device Settings** > **Easy Bolus**.
3. Select **Easy Bolus** to turn on the feature.
4. Set the **Step Size** amount in units.

Select a step size to a number that makes it easy to calculate the total bolus amount.



5. Select **Save**.

Delivering a bolus using the Easy bolus feature



WARNING: Never rely on beeps or vibrations alone while using the Easy bolus feature. Always confirm the insulin delivery by looking at the pump screen. When using the Sound & Vibration options, it is possible that a sound or vibration notification may not occur as expected if the speaker or vibrator in the pump malfunctions. Relying on beeps or vibrations while using the Easy bolus feature may result in over-delivery of insulin.

To deliver a bolus using the Easy bolus feature:

1. While the pump is in Sleep mode, press and hold \wedge for one second or until the pump beeps or vibrates. The bolus can now be set up.



Note: If the pump does not respond when \wedge is pressed, it may not be in Sleep mode, even if the screen is dark. For more information, see *Sleep mode*, page 70.

2. Press \wedge the number of times needed to set the bolus amount. Count the tones or vibrations for each button press to confirm the total bolus amount.



Note: If \wedge is pressed too many times and the bolus amount is too high, press \vee to cancel the Easy bolus delivery and start at step 1 to set up a new bolus.

3. When the needed bolus amount is reached, press and hold \wedge to confirm the amount.
4. Press and hold \wedge for one second, or until the pump beeps or vibrates, to deliver the bolus.

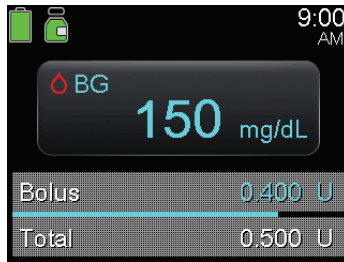

Note: If the \wedge button is not pressed within 10 seconds after the bolus amount is confirmed, the bolus is canceled and a message appears that the bolus was not delivered.

Preset bolus

The Preset Bolus feature allows frequently used bolus deliveries to be set up in advance. There are four preset bolus names that can be used to match a bolus to a meal that has a known carb content. Four additional preset bolus names can be set for other circumstances. These are numbered from Bolus 1 to Bolus 4.



Note: To set up a Preset bolus as a Dual Wave bolus or Square Wave bolus, the Dual Wave bolus feature or Square Wave bolus feature must be turned on.

Setting up and managing preset bolus deliveries

To set up preset bolus amounts:

1. From the Home screen, press \odot , and then select ⚙ .
2. Select **Delivery Settings** > **Preset Bolus Setup**.



3. Select **Add New**.

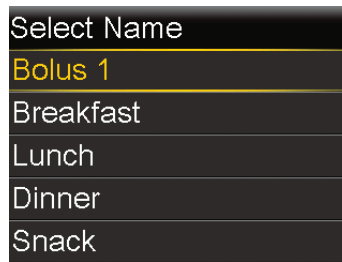

4. Select a preset bolus.
An edit screen appears.

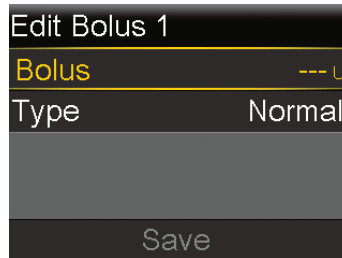

5. Select **Bolus** to set the bolus amount.
6. Select **Type** to set this as a normal bolus, Square Wave bolus, or Dual Wave bolus.



Note: Square Wave and Dual Wave can be selected in the **Type** field only if the Square Wave bolus and Dual Wave bolus features are turned on.

If the type is set to Square or Dual, do the following:

- For a Square Wave bolus, set the **Duration** of time for the bolus delivery.
- For a Dual Wave bolus, adjust the **Now** % amount. When the **Now** amount is adjusted, the **Square** amount adjusts automatically. Then set the **Duration** of time for the Square portion of the bolus.



Note: If the Dual Wave bolus feature or Square Wave bolus feature is turned off, the existing Preset Bolus settings are still available for use.

7. Select **Save**.



Editing, renaming, or deleting a preset bolus

Dual Wave Preset Boluses and Square Wave Preset Boluses can only be edited when the Dual Wave Bolus and Square Wave Bolus features are turned on.



Note: A preset bolus cannot be edited, renamed, or deleted during preset bolus delivery.

To edit, rename, or delete a preset bolus:



1. From the Home screen, press , and then select .
2. Select **Delivery Settings > Preset Bolus Setup**.
3. Select a preset bolus.
4. Select **Options**.
5. Do any of the following:
 - Select **Edit** to adjust the bolus value and type, if applicable. If changing to a Square Wave bolus, enter the duration. If changing to a Dual Wave bolus, enter the Now and Square values and the Duration.

- Select **Rename** to assign a different name to this preset bolus. When the Select Name screen appears, select any available name from the list.
- Select **Delete** to delete this preset bolus.

Delivering a preset bolus

A preset bolus must be set before the Preset Bolus feature can be used. For more information, see *Setting up and managing preset bolus deliveries*, page 270.

To deliver a preset bolus:

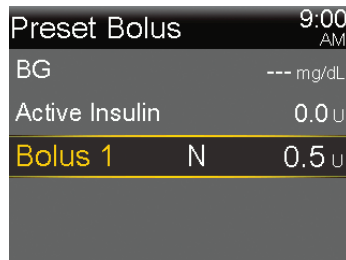

1. From the Home screen, press , and then select .
2. Select **Bolus > Preset Bolus**.
3. Select the preset bolus to be delivered.

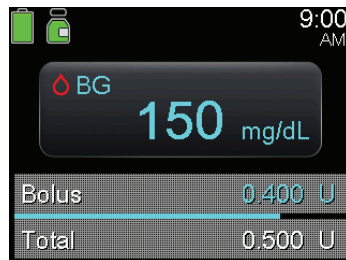

4. Review the bolus amount, and then select **Deliver Bolus** to start the bolus.



Stopping a Square Wave or Dual Wave bolus delivery

This section describes how to stop a bolus in progress. It does not stop basal insulin delivery. To stop all insulin delivery, use the Suspend All Delivery feature (press , select , and select **Suspend All Delivery**).

This section describes how to stop the following bolus deliveries:

- A Dual Wave bolus during the Now portion delivery
- A Square Wave bolus delivery or a Dual Wave bolus during the Square portion delivery

To stop a normal bolus delivery see *Stopping a bolus delivery*, page 112.



Note: When delivering a normal bolus and a Square Wave bolus at the same time, or a normal bolus and the Square portion of a Dual Wave bolus at the same time, both boluses are stopped.

To stop a Dual Wave bolus delivery during the Now portion:

1. While the pump is delivering the Now portion of a Dual Wave bolus, press  from the Home screen.

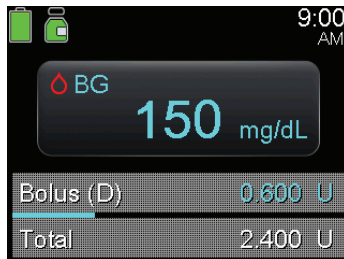

2. Select .
3. Select **Stop Bolus**, then select **Yes** to confirm.

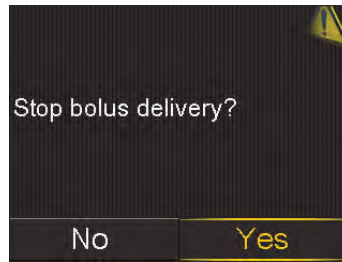

The Bolus Stopped screen appears and shows the amount of bolus delivered, and bolus amount that was originally set up.





Note: When a Dual Wave bolus is stopped during the Now portion, the Now portion is stopped and the Square portion is canceled.



4. Select **Done**.

To stop a Square Wave bolus delivery or the Square portion of a Dual Wave bolus delivery:

1. While the pump is delivering a Square Wave bolus delivery or the Square portion of a Dual Wave bolus delivery, press  from the Home screen.
2. Select  and then select **Bolus**.
3. Select **Stop Bolus**, then select **Yes** to confirm.

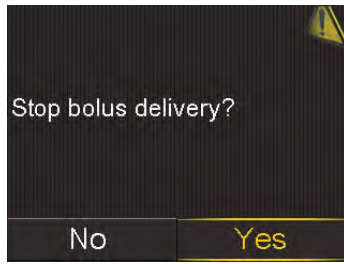

The Bolus Stopped screen appears and shows the amount of bolus delivered, and the bolus amount that was originally set up.

4. Select **Done**.

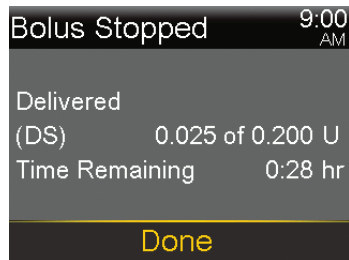

14

Troubleshooting

14

Troubleshooting

This chapter provides information about common MiniMed 780G insulin pump and sensor issues, as well as possible resolutions.

For a list of alarms, alerts, and messages, see *List of alarms, alerts, and messages*, page 299.

Pump issues



WARNING: When a critical pump error occurs, the following screen appears and the pump siren goes off:





Immediately disconnect the pump and discontinue use. Contact 24-Hour Technical Support.

Insulin delivery is still required when the pump is removed. Consult a healthcare professional to determine an alternate method of insulin delivery while the pump is removed.

The following table provides troubleshooting information for the insulin pump:

Issue	Resolution
? appears on the Home screen or Bolus screens after an Active Insulin reset to zero alarm occurs.	Select OK to clear the alarm. Contact 24-Hour Technical Support for assistance with the following steps: <ol style="list-style-type: none">1. Check the Daily History screen or the sensor graph for the recent bolus amounts, and when they were delivered, before giving any bolus.2. Consult a healthcare professional for how long to wait after active insulin has been reset to zero before relying on the active insulin calculation of the Bolus Wizard feature. The

Issue	Resolution
	<p>active insulin tracked prior to the Active Insulin reset to zero alarm is not included in new Bolus Wizard calculations.</p> <ol style="list-style-type: none"> 3. Check blood glucose (BG) using a blood glucose meter and treat as needed. <div data-bbox="600 535 1369 804" style="background-color: #f0f0f0; padding: 10px; border: 1px solid #ccc;">  <p>WARNING: Do not rely on active insulin tracked in the pump when giving any bolus after active insulin has been reset to zero. Relying on the active insulin shown on the pump screen can result in the infusion of too much insulin, which can cause hypoglycemia.</p> </div>
<p>The pump buttons are stuck during airplane travel.</p>	<p>During atmospheric pressure changes, the pump buttons may not work for up to 45 minutes. For example, during airplane travel, pump buttons may get stuck and the pump will alarm. This is rare. If this occurs, either wait for the problem to correct itself, or confirm the AA battery connection:</p> <ol style="list-style-type: none"> 1. Remove the battery cap. 2. Place the battery cap back onto the pump. The pump will check the AA battery power, and may require a new AA battery. 3. If prompted, insert a new AA battery. For more information about changing the battery, see <i>Removing the battery</i>, page 295. <p>If these steps do not correct the problem, contact 24-Hour Technical Support for assistance.</p>
<p>The pump was dropped or there are concerns that the pump may be damaged.</p>	<div data-bbox="600 1476 1369 1726" style="background-color: #f0f0f0; padding: 10px; border: 1px solid #ccc;">  <p>CAUTION: Always inspect the pump for cracks before exposing the pump to water, especially if the pump was dropped or damaged. Water leakage can cause the pump to malfunction and result in injury.</p> </div>

Issue	Resolution
	<ol style="list-style-type: none"> 1. Disconnect the pump from body. Confirm all infusion set and reservoir connections are secure. 2. Disconnect the pump from body. Check the infusion set, including the tubing connector and tubing, for cracks or damage. 3. Check the display, button area, and pump case for cracks or damage. 4. Confirm the information on the Status screen, and the settings for the basal rates and the pump are correct. 5. Confirm the settings for the basal rates and the pump are correct. 6. Perform a self test. For more information, see <i>Self Test</i>, page 210. 7. If necessary, contact 24-Hour Technical Support and check BG. <p>For health-related questions or concerns, consult a healthcare professional.</p>
The pump display times out too quickly.	In order to conserve battery, the pump display times out after 15 seconds. To increase the time, see <i>Display options</i> , page 207.
The pump displays a Check Settings alarm.	The pump has reset to factory settings. Review any settings that were not already set in the Startup Wizard and re-enter them, if necessary.
The pump settings have been cleared and need to be re-entered.	Do not clear pump settings unless directed to do so by a healthcare professional. Certain pump errors may cause the pump to reset to factory default values, which clears the current pump settings. To restore saved pump settings, see <i>Restoring the settings</i> , page 212. Consult a healthcare professional to determine the necessary settings. Have the settings that need to be entered into the pump ready before starting the procedure below.

Issue	Resolution
	<p>Use the following procedure to re-enter personalized pump settings using the Startup Wizard:</p> <ol style="list-style-type: none"> 1. After the pump resets, the Startup Wizard appears. Select a language, and then press ⊙. 2. Select a time format, and then press ⊙. 3. Enter the current time, and then select Next. 4. Enter the current date, and then select Next. 5. Select the carb unit, and then press ⊙. 6. When the Active Insulin Time screen appears, select Next. For more information, see <i>Bolus Wizard settings, page 103</i>. 7. Enter the Duration, and then select Next. 8. Enter the basal rates for the new basal pattern, and then select Next. For more information, see <i>Setting up a basal pattern, page 90</i>. 9. Review the basal pattern information, and then select Next. 10. On the Startup screen, a message displays to ask to set up Bolus Wizard now. Do one of the following: <ul style="list-style-type: none"> • Select Yes to enter the Bolus Wizard settings. For more information, see <i>Bolus Wizard settings, page 103</i>. • Select No to skip the Bolus Wizard setup.

Sensor issues

Issue	Resolution
The pump has lost connection with the sensor.	After 30 minutes without a signal, the Lost sensor signal alert appears. Follow the steps on the pump screen or the steps below to try to resolve the issue.

Issue	Resolution
	<p>Note: If alerts are silenced and a sensor alert occurs, the alert still appears on the screen.</p> <ol style="list-style-type: none"> 1. Move the pump closer to the transmitter, and then select OK. It can take up to 15 minutes for the pump to find the sensor signal. If the pump still cannot find the sensor signal, the Possible signal interference alert appears. 2. Move away from electronic devices that may cause interference, and then select OK. Wait 15 minutes for the pump to locate the sensor signal. If a signal is not found, the Check connection alert appears. 3. Confirm that the connection between the transmitter and sensor is secure, and then select OK. The “Check sensor insertion” message appears. 4. Do one of the following: <ul style="list-style-type: none"> • If the sensor connection is secure, select Yes. Contact 24-Hour Technical Support if the pump cannot find the sensor signal within 15 minutes or if the “Sensor signal not found - See User guide” alert appears on the sensor glucose (SG) graph. • If the sensor is not securely connected to the transmitter, select No. A Change sensor alert appears. Select OK and change the sensor.
A calibration is not accepted.	<p>A Calibration not accepted alert occurs in one of the following situations:</p> <ul style="list-style-type: none"> • The system cannot use the entered BG meter reading. Only a BG value between 40 mg/dL and 400 mg/dL can be used to calibrate the sensor. Wait at least 15 minutes, wash hands, and try again. • The entered BG meter reading differs too greatly from the most recent sensor glucose (SG) value. Check the accuracy of the BG meter reading and try again.

Issue	Resolution
	<ul style="list-style-type: none"> The transmitter cannot receive the calibration BG meter readings from the pump due to a failed sensor signal. Troubleshoot the failed sensor signal. For more information, see <i>Calibrating the sensor</i>, page 171.
<p>The suspend by sensor icon appears with a red X.</p>	<p>The suspend by sensor icon appears with a red X when the Suspend before low or the Suspend on low feature is unavailable. This can occur in the following situations:</p> <ul style="list-style-type: none"> A suspend event recently occurred. For information about the availability of the suspend functionality, see <i>The Suspend before low feature</i>, page 156 or <i>The Suspend on low feature</i>, page 158. Sensor glucose (SG) readings are unavailable. <p>SG readings may be unavailable in the following situations:</p> <ul style="list-style-type: none"> The sensor needs calibration. For more information, see <i>Calibrating the sensor</i>, page 171. The pump has lost communication with the sensor. Restore pump communication with the sensor. The sensor is updating. Clear the alert and wait up to 3 hours for the SG readings to resume. <p>If necessary, insert a new sensor. If the issue continues after a new sensor is inserted, contact 24-Hour Technical Support.</p>



15

Maintenance

15

Maintenance

This chapter provides information about maintaining the components of the MiniMed 780G system.

Pump maintenance

Cleaning the pump

Prepare the following supplies to clean the pump:

- four small, clean, soft cloths
- mixture of water and mild detergent
- clean water
- 70% alcohol
- clean cotton swabs
- clean cotton balls



CAUTION: Never use organic solvents, such as lighter fluid, nail polish remover, or paint thinner to clean the MiniMed 780G insulin pump. Never use lubricants with the pump. When the pump is being cleaned, be sure to keep the reservoir compartment dry and away from moisture. If organic solvents are used to clean the pump, they can cause the pump to malfunction and result in minor injury.

To clean the pump:

1. Dampen a cloth with water mixed with a mild detergent.
2. Use the cloth to wipe the outside of the pump while keeping the inside of the reservoir compartment dry.
3. Dampen a clean cloth with water and wipe to remove any detergent residue.
4. Dry with a clean cloth.
5. Wipe the pump with a 70% alcohol wipe.
6. Use a dry, clean cotton swab to remove any battery residue from the battery cap.
7. Use a dry, clean cotton swab to remove any battery residue from the battery compartment housing.

Storing the pump

The pump can be stored when it is not in use.



WARNING: After the pump is stored, do not rely on active insulin tracked in the pump when making new Bolus Wizard calculations. Storage mode clears active insulin. Inaccurate Bolus Wizard calculations may result in inaccurate insulin delivery and serious injury.

To place the pump in storage mode:

1. Remove the AA battery from the pump. For details, see *Removing the battery*, page 295.



Note: When the battery is removed, the pump issues an Insert Battery alarm for 10 minutes or until the pump is in storage mode.

2. Press and hold  until the screen turns off.



CAUTION: Never expose the pump to temperatures below -4 °F (-20 °C) or above 122 °F (50 °C). Storing the pump in temperatures outside of this range can damage the pump.

To use the pump after it has been stored:

1. Insert a new AA battery into the pump. For details, see *Inserting the battery*, page 72.

A Pump Error alarm appears.

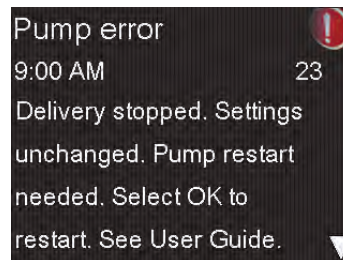

2. Select **OK**.

The pump displays a Power Loss alarm.

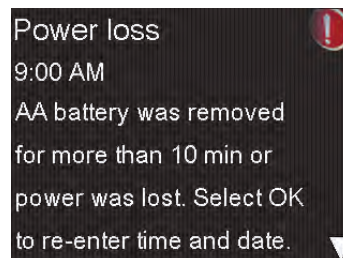

3. Select **OK**.

The Time & Date screen appears.

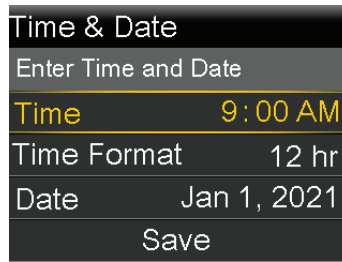

4. Enter the current **Time**, **Time Format**, and **Date**.

5. Select **Save**.

The pump displays an Active Insulin Cleared alert.

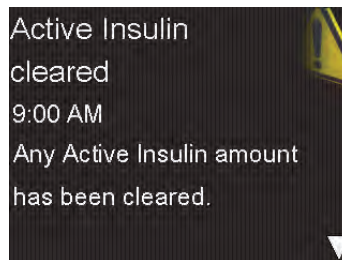

6. Select **OK**.

Confirm that all the settings, such as basal rate, are set as desired. Use the Restore Settings option to reapply the last saved settings, if needed. For more information, see *Restoring the settings*, page 212.

7. Repeat the pairing process for the transmitter and meter. For transmitter details, see *Pairing the pump and transmitter*, page 139. For meter details, see *Pairing the pump and meter*, page 137.

Pump disposal



Always follow local laws and regulations for the disposal of medical devices.

Meter maintenance

Unpairing a meter from the pump

Follow this procedure to unpair the Accu-Chek™* Guide Link meter from the pump.

To unpair the meter from the pump:

1. From the Home screen, press , and then select .
The Paired Devices screen appears.

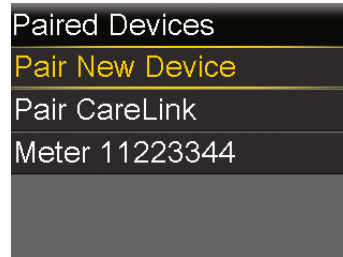

2. Select the serial number of the meter to unpair the device. The Accu-Chek™^{TMx} Guide Link meter serial number is located on the back of the meter.
The Device Info screen appears.

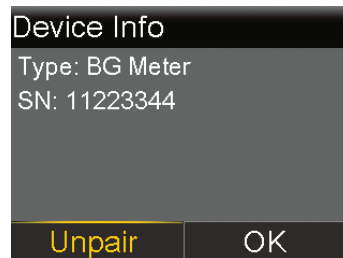

3. Select **Unpair**.
The Unpair Device? screen appears.

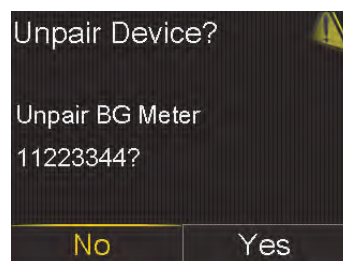

4. Select **Yes** to confirm. Select **No** to cancel.

Deleting the pump from a meter

For steps to delete the pump from a meter, see the Accu-Chek™* Guide Link User's Manual.

Transmitter and sensor maintenance

Unpairing the transmitter from the pump

Follow this procedure to unpair the transmitter from the pump, including when the transmitter needs to be replaced.

To unpair the transmitter from the pump:

1. From the Home screen, press , and then select .

The Paired Devices screen appears.

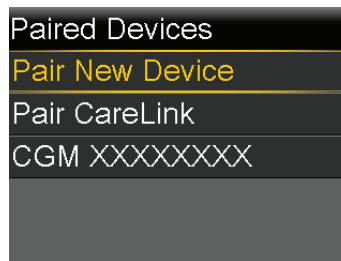

2. Select CGM with the correct serial number.

The Device Info screen appears.

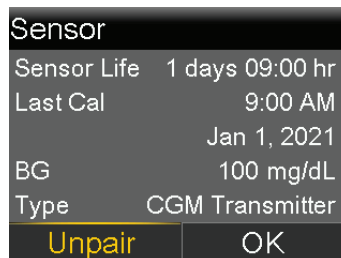

3. Select **Unpair**.

The Unpair Device? screen appears.

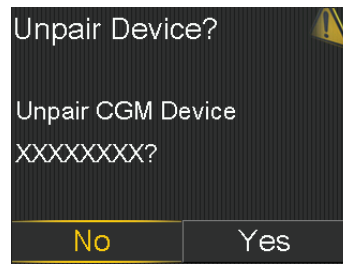

4. Select **Yes** to confirm. Select **No** to cancel.

When the transmitter is unpaired from the pump, a No Paired CGM banner appears on the Home screen.

Disconnecting the transmitter from the sensor

Refer to the transmitter user guide for instructions on how to disconnect the transmitter from the sensor.

Removing the sensor

Refer to the sensor user guide for instructions on how to remove the sensor.

Cleaning the transmitter

Refer to the transmitter user guide for instructions on how to clean the transmitter.

Storing the transmitter

Refer to the transmitter user guide for instructions on how to store the transmitter.

Removing the battery



CAUTION: Do not remove the battery unless a new battery needs to be inserted or to store the pump. The pump cannot deliver insulin while the battery is removed. After an old battery is removed, make sure to replace it with a new battery within 10 minutes to clear the Insert battery alarm and avoid a Power loss alarm. If power loss occurs, the time and date settings must be re-entered.

To remove the battery:

1. Before a battery is removed from the pump, clear any active alarms or alerts.
2. Use the pump clip or a coin to loosen and remove the battery cap.
3. Remove the battery.

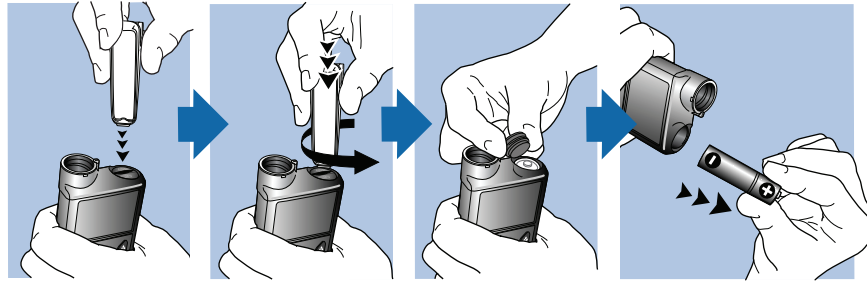

4. Dispose of old batteries in an appropriate container and in accordance with local laws for battery disposal.
5. After a battery is removed, wait until the Insert Battery screen appears before inserting a new battery.

If a battery is removed to place the pump in storage, see *Storing the pump*, page 290 for more information.

Appendix A: List of alarms, alerts, and messages



Appendix A: List of alarms, alerts, and messages

This appendix provides information about alarms, alerts, and messages that can occur in the MiniMed 780G system.

Pump alarms, alerts, and messages

The following table lists the most common or serious alarms, alerts, and messages related to the MiniMed 780G insulin pump. The table also explains the meaning, consequences, and the reasons why these notifications appear, and provides steps for problem resolution.



Note: Use the MiniMed Mobile app to view the sensor graph on a mobile device. Always read and acknowledge all alarms and alerts on the pump. If the pump simultaneously generates more than one alarm or alert, only one of the alarms or alerts appears on the mobile device.

Title and text	Type	Explanation	Next steps
<p>Active Insulin cleared</p> <p>Any Active Insulin amount has been cleared.</p>	Alert	The pump shows the active insulin amount at 0 units. The pump shows this alert when the active insulin is cleared from the Clear Active Insulin option on the Manage Settings screen or if the pump has been shut down and is powered back on.	<ul style="list-style-type: none"> Select OK to clear the alert. The active insulin tracked prior to pump restart is not included in new Bolus Wizard calculations. Consult a health-care professional for how long to wait after active insulin is cleared before relying on the

Title and text	Type	Explanation	Next steps
			<p>active insulin calculation of the Bolus Wizard feature.</p> <ul style="list-style-type: none"> • Check Daily History for the last bolus amount and when it was delivered.
<p>Active Insulin reset to zero ? Call local Medtronic support for assistance. See User Guide for phone numbers. Pump Active Insulin may be incorrect until XX:XX AM/PM due to a pump error. Monitor glucose.</p>	Alarm	The pump shows the active insulin amount at 0 units. This occurs when a pump error clears active insulin in the pump. After the Active Insulin reset to zero alarm occurs, ? appears on the Home screen and Bolus screens until the time shown in the alarm.	<p>Select OK to clear the alarm. Contact 24-Hour Technical Support for assistance.</p>
<p>Active Insulin Reminder ? Call local Medtronic support for assistance if needed. See User Guide for phone numbers. Pump Active Insulin was reset to zero at XX:XX AM/PM. Active insulin may be incorrect until XX:XX AM/PM. Monitor glucose.</p>	Message	The Active Insulin Reminder message occurs when the Bolus Wizard screen or the Manual Bolus screen is accessed before the time shown in the message. After the Active Insulin reset to zero alarm occurs, ? appears on the Home screen and Bolus screens until the time shown in the Active Insulin reset to zero alarm or the Active Insulin Reminder message.	<p>Select OK to clear the message. Contact 24-Hour Technical Support for assistance with the following steps.</p> <ul style="list-style-type: none"> • Check the Daily History screen or the sensor graph for the recent bolus amounts, and when they were delivered, before giving any bolus. • Consult a healthcare professional for how long to wait after active insulin has been reset to zero before relying on the active insulin calculation of the Bolus Wizard feature. The active insulin tracked prior to the Active Insulin reset to zero alarm is not included in new Bolus Wizard calculations. • Check blood glucose (BG) using a blood glucose meter and treat as needed.

Title and text	Type	Explanation	Next steps
<p>Auto Suspend Insulin delivery suspended. No buttons pressed within time set in Auto Suspend.</p>	Alarm	Insulin delivery is currently suspended by Auto Suspend. The Auto Suspend feature automatically suspends insulin delivery and triggers an alarm after no buttons are pressed for a specified period of time. Insulin delivery is suspended until the alarm is cleared and basal insulin delivery resumed.	<ul style="list-style-type: none"> Select Resume Basal to clear the alarm and resume basal insulin delivery. Check BG and treat as needed.
<p>Battery failed Insert a new AA battery.</p>	Alarm	The battery in the pump is low on power.	<ul style="list-style-type: none"> Select OK to clear the alarm. Remove the old battery and insert a new AA battery.
<p>Battery not compatible. See User Guide.</p>	Alarm	The inserted battery is not compatible with the pump.	<ul style="list-style-type: none"> Remove the incompatible battery to clear the alarm. Insert a new AA battery.
<p>Bolus not delivered Bolus entry timed out before delivery. If bolus intended, enter values again.</p>	Alert	A bolus value was entered, but a bolus was not delivered within 30 seconds.	<ul style="list-style-type: none"> Select OK to clear the alert. If a bolus delivery was intended, check BG, re-enter bolus values and redeliver the bolus.
<p>Bolus stopped Cannot resume bolus or cannula fill. XX.XXX of YY.YYY U delivered. ZZ.ZZZ U not delivered. If needed, enter values again.</p>	Alarm	The battery power was exhausted while a bolus delivery or Fill Cannula procedure was in progress or the Resume bolus? message appeared and was not cleared.	<ul style="list-style-type: none"> Note the amount of insulin not delivered. Replace the AA battery. Select OK to clear the alarm. Deliver the remaining bolus amount if needed.
<p>Check settings Startup Wizard settings complete. Check and set up your other settings.</p>	Alert	Some settings have been cleared or reverted to factory default values.	<ul style="list-style-type: none"> Select OK to clear the alert. Review any settings that have not already been set in Startup Wizard and re-enter the values if necessary.
<p>Critical pump error Delivery stopped. Pump not working properly. Stop using</p>	Alarm	The pump has encountered an error that cannot be resolved. For example, the pump may have a mechanical problem.	The pump is not able to deliver insulin. Disconnect the infusion set and stop using the pump.

Title and text	Type	Explanation	Next steps
pump. Remove infusion set from body. Consider other insulin treatment. See User Guide.			<ul style="list-style-type: none"> • Consider another form of insulin delivery. • Check BG, and treat as necessary. • Write down the error code that appears on the alarm screen. • Contact 24-Hour Technical Support for assistance with the pump.
Delivery limit exceeded Delivery stopped. Check BG. See User Guide for more information.	Alarm	The pump has suspended insulin delivery because the hourly delivery limit was reached. This limit is based on the maximum bolus and maximum basal setting. If this alarm occurs during a bolus, the bolus is canceled before it can complete.	<ul style="list-style-type: none"> • Check BG. • Select Resume Basal. • Check Bolus History and re-evaluate insulin needs. • Continue to monitor BG.
Device Limit You must delete an existing device (device type) before you can pair a new one (device type).	Message	The pump is already paired with the maximum number of devices for this type. The following list describes the maximum number of each device type to pair with the pump: <ul style="list-style-type: none"> • Meter—four Accu-Chek™^{TMX} Guide Link meters • CGM—one Guardian Link (3) transmitter (MMT-7910NA) • Mobile Device—one compatible mobile device 	<ul style="list-style-type: none"> • Select OK to clear the message. • Go to the Paired Devices screen and select the device to unpair from the list of devices. Select Unpair, and then select Yes to confirm or No to cancel. Pair the pump and the desired device.
Device not compatible Device cannot be used with this pump.	Alert	The pump cannot pair with the selected device.	<ul style="list-style-type: none"> • Select OK to clear the alert. • Contact 24-Hour Technical Support for assistance.
Device not found Make sure device is in range and in pairing mode.	Alert	The pump did not pair with the device.	<ul style="list-style-type: none"> • Select OK to clear the alert. • Confirm that the device is not already paired with a pump.

Title and text	Type	Explanation	Next steps
			<ul style="list-style-type: none"> • Confirm that the device is ready to pair with the pump. • Make sure the pump is away from any electronic devices that might cause interference, such as cellular phones that are not paired with the MiniMed 780G system and other wireless devices. • Move the device closer to the pump. • Try to pair the pump with the device again.
<p>Fill Cannula? Select Fill to fill cannula or select Done if not needed.</p>	Alarm	The Fill Cannula? screen has been active for 15 minutes.	<ul style="list-style-type: none"> • To fill the cannula, select Fill. • If the cannula does not need to be filled, select Done to skip this process.
<p>High BG XXX mg/dL Check infusion set. Check ketones. Consider insulin injection. Monitor BG. Confirm BG?</p>	Alert	The BG meter reading is above 250 mg/dL. This alert appears in Manual mode. For High BG XXX mg/dL while the SmartGuard feature is on, see <i>SmartGuard feature alerts and messages, page 319</i> .	<ul style="list-style-type: none"> • Select No to prevent the remote BG from being used by the pump. Select Yes to confirm the BG reading. • Check BG and treat as necessary.
<p>Insert battery Delivery stopped. Insert a new battery now.</p>	Alarm	The battery was removed from the pump. If a bolus was in progress when the battery was removed, a Resume bolus? message appears and a tone sounds when a new battery is inserted. The message indicates how much of the bolus was delivered.	<ul style="list-style-type: none"> • Insert a new AA battery. • The alarm clears when a new battery is inserted. • The pump powers off after 10 minutes unless a new battery is inserted.

Title and text	Type	Explanation	Next steps
<p>Insulin flow blocked</p> <p>Check BG. Consider testing ketones.</p> <p>Check reservoir and infusion set.</p>	Alarm	The pump has detected that the basal or bolus insulin flow was blocked.	<ul style="list-style-type: none"> • Check BG and ketones. Administer an insulin injection if necessary. • Remove the infusion set and reservoir. • Select Reservoir & Set to start the process with a new infusion set and reservoir. <p>If the alarm occurs during a bolus delivery:</p> <ul style="list-style-type: none"> • Check the Daily History screen for the amount of bolus already delivered before the pump alarmed. • Consider delivering remaining bolus, if the bolus insulin was not included in an insulin injection.



WARNING: Do not use the SmartGuard feature for a period of time, determined by a healthcare professional, after giving a manual injection of insulin by syringe or pen. Manual injections are not accounted for in the active insulin amount. Therefore, the SmartGuard feature could deliver too much insulin. Too much insulin may cause hypoglycemia. Consult a healthcare professional for how long to wait after a manual injection of insulin before resuming the SmartGuard feature.

<p>Insulin flow blocked</p> <p>Check BG. Consider testing ketones. Estimated 0 U insulin in reservoir. Change reservoir and infusion set.</p>	Alarm	The pump has detected that the insulin flow is blocked and there is no insulin in the reservoir.	<ul style="list-style-type: none"> • Check BG and ketones. Administer an insulin injection if necessary. • Remove the infusion set and reservoir. • Select Reservoir & Set to start the process with a new infusion set and reservoir. <p>If the alarm occurs during a bolus delivery:</p> <ul style="list-style-type: none"> • Check the Daily History screen for the amount of bo-
--	-------	--	---

Title and text	Type	Explanation	Next steps
			<p>lus already delivered before the pump alarmed.</p> <ul style="list-style-type: none"> Consider delivering remaining bolus, if the bolus insulin was not included in an insulin injection.
<p>Insulin flow blocked Fill Cannula stopped. Remove infusion set from body. Change reservoir and infusion set.</p>	Alarm	The pump has detected that the insulin flow is blocked while filling the cannula.	<ul style="list-style-type: none"> Check BG and ketones. Administer an insulin injection if necessary. Remove the infusion set and reservoir. Select Reservoir & Set to start the process with a new infusion set and reservoir.
<p>Insulin flow blocked Fill Tubing stopped. Remove reservoir and select Rewind to restart.</p>	Alarm	The pump has detected that the insulin flow is blocked while filling the tubing. Possible connection issue between the tubing and reservoir.	<ul style="list-style-type: none"> Remove the reservoir and select Reservoir & Set to restart the fill tubing process. Disconnect the tubing from the reservoir. Confirm that the tubing is not crimped or bent. Continue to follow the steps displayed on the pump using the same infusion set and reservoir. If this alarm occurs again, replace the infusion set.
<p>Loading incomplete Remove reservoir and select Rewind to restart loading.</p>	Alarm	⬅️ was pressed after loading began.	<ul style="list-style-type: none"> Remove the reservoir to start again. Select Rewind and follow the on-screen instructions.
<p>Low battery Pump Replace battery soon.</p>	Alert	The battery in the pump is low on power. Remaining battery life is 10 hours or fewer.	<ul style="list-style-type: none"> Select OK to clear the alert. Replace the AA battery as soon as possible. Otherwise, insulin delivery stops, and the

Title and text	Type	Explanation	Next steps
<p>Low BG XX mg/dL Treat Low BG. Do not bolus until BG is normal. Monitor BG. Confirm BG?</p>	Alert	The BG meter reading is below 70 mg/dL.	<p>Replace battery now alarm occurs.</p> <ul style="list-style-type: none"> If the pump is delivering a bolus or filling the cannula, wait until delivery is complete to replace battery. <ul style="list-style-type: none"> Select No to prevent the remote BG reading from being used by the pump. Select Yes to confirm the BG reading. Check BG and treat as necessary.
<p>Low reservoir XX units remaining. Change reservoir.</p>	Alert	The reservoir is low on insulin, according to the number of units set in the Low Reservoir reminder.	<ul style="list-style-type: none"> Select OK to clear the alert. Change the reservoir soon. If the reservoir is not changed after this alert is received, a second Low reservoir alert appears when the insulin level reaches half of the original alert amount.
<p>Manage settings error Delivery stopped. Backup settings cleared from Manage Settings. Current settings are working properly. Select OK to restart. See User Guide.</p>	Alarm	A pump error occurred and the pump needs to be restarted. The backup settings have been lost, but the current settings are unchanged.	<ul style="list-style-type: none"> Select OK to restart the pump. The current settings are unchanged. Only the backup settings are lost. When the pump restarts, follow instructions on the pump display. If the pump was delivering a bolus or filling the cannula, check Daily History and evaluate if insulin is needed.

Title and text	Type	Explanation	Next steps
Max Fill reached 3X.X U. Did you see drops at the end of tubing?	Alarm	The number of units expected to fill the tubing has been exceeded. By now, insulin should be visible at the end of the tubing.	<ul style="list-style-type: none"> If there are drops of insulin at the end of the tubing, select Yes. If there are no drops of insulin at the end of the tubing, select No. Follow instructions displayed on the pump.
Max Fill reached 4X.X U. Remove reservoir and select Rewind to restart New Reservoir procedure.	Alarm	The number of units expected to fill the tubing has been exceeded. By now, insulin should be visible at the end of the tubing.	<ul style="list-style-type: none"> Remove the reservoir. Check if there is still insulin in the reservoir. If there is insulin in the reservoir the same reservoir can be used. Select Rewind to restart the new reservoir procedure.
No reservoir detected Rewind before loading reservoir.	Alarm	There is no reservoir in the pump or the reservoir is not properly locked into place.	<ul style="list-style-type: none"> Select Rewind. Confirm that the reservoir is filled with insulin. When prompted, confirm that the reservoir is inserted and properly locked into place.
Power error detected Delivery stopped. Record your settings by uploading to CareLink or write your settings on paper. See User Guide.	Alarm	The internal power source in the pump is unable to charge. The pump is operating on the AA battery only.	<ul style="list-style-type: none"> Select OK to clear the alarm. Check BG and treat as necessary. Record the pump settings as soon as possible because the AA battery may not last long. Contact 24-Hour Technical Support for assistance with the pump.
Power loss AA battery was removed for more than 10 min or power was lost. Select OK to re-enter time and date.	Alarm	The battery has been out of the pump for more than ten minutes and the pump has lost power. The date and time must be reset.	<ul style="list-style-type: none"> Select OK to go to the Time & Date screen. Enter the current time, time format, and date.

Title and text	Type	Explanation	Next steps
<p>Pump error Delivery stopped. Current settings cleared. Pump restart needed. Select OK to restart and then re-enter your settings. See User Guide.</p>	Alarm	The pump encountered an error and will restart. The pump settings will return to factory default values.	<ul style="list-style-type: none"> Select OK to restart the pump. When the pump restarts, follow instructions on the pump display. After the pump restarts, check settings and re-enter values as needed. If the backup settings were recently saved in Manage Settings, use Restore Settings. If the pump was delivering a bolus or filling the cannula, check Daily History and re-evaluate if insulin is needed. If this alarm recurs frequently, write down the error code on the alarm screen (it can also be found in the Alarm History) and contact 24-Hour Technical Support for assistance.
<p>Pump error Delivery stopped. Settings unchanged. Pump restart needed. Select OK to restart. See User Guide.</p>	Alarm	A pump error has occurred, the pump needs to be restarted.	<ul style="list-style-type: none"> Select OK to restart the pump. If the pump was delivering a bolus or filling the cannula, check Daily History and re-evaluate if insulin is needed. If this alarm recurs frequently, write down the error code on the alarm screen (it can also be found in the Alarm History) and contact 24-Hour Technical Support for assistance.
<p>Pump error Delivery stopped. Settings unchanged. Select OK to continue. See User Guide.</p>	Alarm	The pump encountered an error but a restart is not necessary. The issue is resolved. The settings are not changed.	<ul style="list-style-type: none"> Select OK to resume basal insulin delivery. If the pump was delivering a bolus or filling the cannula, check Daily History and

Title and text	Type	Explanation	Next steps
			<p>re-evaluate if insulin is needed.</p> <ul style="list-style-type: none"> If this alarm recurs frequently, write down the error code on the alarm screen (it can also be found in the Alarm History) and contact 24-Hour Technical Support for assistance.
<p>Pump restarted Delivery stopped. Settings unchanged. Select OK to continue. See User Guide.</p>	Alarm	The pump has encountered a problem and has restarted. The settings have not been changed.	<ul style="list-style-type: none"> Select OK to continue. If the pump was delivering a bolus or filling the cannula, check Daily History and re-evaluate if insulin is needed. If this alarm recurs frequently, write down the error code on the alarm screen (it can also be found in the Alarm History) and contact 24-Hour Technical Support for assistance.
<p>Replace battery Battery life less than 30 minutes. To ensure insulin delivery, replace battery now.</p>	Alert	Battery power is low and will be exhausted within 30 minutes.	<ul style="list-style-type: none"> Select OK to clear the alert. Replace the AA battery.
<p>Replace battery now Delivery stopped. Battery must be replaced to resume delivery.</p>	Alarm	Insulin delivery has stopped due to low power. The battery was not replaced after the Low battery Pump alert.	Replace the battery immediately to resume insulin delivery.
<p>Reservoir estimate at 0 U To ensure insulin delivery, change reservoir.</p>	Alert	The reservoir level is estimated at 0 U.	<ul style="list-style-type: none"> Select OK to clear the alert. Change the reservoir.

Title and text	Type	Explanation	Next steps
Resume bolus? XXX of YYY U delivered. Resume delivery of ZZZ U?	Message	A normal bolus delivery has been interrupted because the pump battery was removed. If it is within ten minutes since this interruption, the bolus can be resumed.	<ul style="list-style-type: none"> • Check the message to see how much of the bolus was delivered. • To cancel the remaining bolus delivery, select Cancel. • To resume the bolus delivery, select Resume.
Resume Dual bolus? XX of YYU delivered. Resume delivery of ZZ U for XX:XX hr?	Message	The Square portion of Dual Bolus delivery has been interrupted. If it is within ten minutes since this interruption, the bolus can be resumed.	<ul style="list-style-type: none"> • Check the message to see how much of the Dual Wave bolus was delivered. • To cancel the remaining bolus delivery, select Cancel. • To resume the bolus delivery, select Resume.
Resume Dual bolus? XX of YYU delivered. Resume delivery of ZZ U now, and AA U Square for XX:XX hr?	Message	The Now portion of a Dual Wave bolus delivery has been interrupted because the pump battery was removed. If it is within ten minutes since this interruption, the bolus can be resumed.	<ul style="list-style-type: none"> • Check the message to see how much of the Dual Wave bolus was delivered. • To cancel the remaining bolus delivery, select Cancel. • To resume the bolus delivery, select Resume.
Resume Square bolus? XX of YY U delivered for XX:XX hr. Resume delivery of ZZ U for XX:XX hr?	Message	The Square Wave bolus delivery was interrupted. If it is within ten minutes since this interruption, the bolus can be resumed.	<ul style="list-style-type: none"> • Check the message to see how much of the Square Wave bolus was delivered. • To cancel the remaining bolus delivery, select Cancel. • To resume the bolus delivery, select Resume.
Rewind required Delivery stopped. Rewind was required due to pump error. Select OK to continue. See User Guide.	Alarm	The pump encountered an error.	<ul style="list-style-type: none"> • Select OK to clear the alarm after the pump has completed rewinding. • Select Reservoir & Set from the Menu screen to start the new reservoir process with a new infusion set and reservoir. For details, see <i>Setting up</i>

Title and text	Type	Explanation	Next steps
			<p><i>the reservoir and infusion set, page 118.</i></p> <ul style="list-style-type: none"> If this alarm recurs frequently, contact 24-Hour Technical Support for assistance.
Stuck button Button pressed for more than 3 minutes.	Alarm	The pump has detected that a button has been pressed for an unusually long time.	<ul style="list-style-type: none"> Select OK to clear the alarm. If this alarm occurs again, contact 24-Hour Technical Support for assistance with the pump. <p>If the alarm cannot be cleared</p> <ul style="list-style-type: none"> See <i>Pump issues, page 280.</i> Consider another form of insulin, because the pump is not delivering insulin. Check BG and treat as necessary. Contact 24-Hour Technical Support for assistance with the pump.

CGM (sensor) alarms, alerts, and messages

The following table lists the most common or serious alarms, alerts, and messages related to sensor glucose (SG) values, as well as the status of the transmitter and sensor. The table also explains the meaning, consequences, and the reasons why these notifications appear, and provides steps for problem resolution.

Title and text	Type	Explanation	Next steps
Alert before high Sensor glucose approaching High Limit. Check BG.	Alert	The SG reading is approaching the specified high limit.	<ul style="list-style-type: none"> Select OK to clear the alert. Check BG. Follow instructions from a healthcare professional and continue to monitor BG.

Title and text	Type	Explanation	Next steps
Alert before low Sensor glucose approaching Low Limit. Check BG.	Alert	The SG reading is approaching the specified low limit.	<ul style="list-style-type: none"> • Select OK to clear the alert. • Check BG. • Follow instructions from a healthcare professional and continue to monitor BG.
Alert on high XXX mg/dL High sensor glucose. Check BG.	Alert	The SG reading is at or above the specified high limit.	<ul style="list-style-type: none"> • Select OK to clear the alert. • Check BG. • Follow instructions from a healthcare professional and continue to monitor BG.
Alert on low XX mg/dL Low sensor glucose. Check BG.	Alert	The SG reading is at or below the specified low limit.	<ul style="list-style-type: none"> • Select OK to clear the alert. • Check BG. • Follow instructions from a healthcare professional and continue to monitor BG.
Alert on low XX mg/dL Low sensor glucose. Insulin delivery suspended since XX:XX AM/PM. Check BG.	Alarm	The SG reading is at or below the specified low limit, and the pump has suspended insulin delivery due to a Suspend before low or Suspend on low.	<ul style="list-style-type: none"> • Select OK to clear the alarm. • Check BG. • Follow instructions from a healthcare professional and continue to monitor BG.
Basal delivery resumed Basal delivery resumed at XX:XX AM/PM after suspend by sensor. Check BG.	Message	The pump is resuming basal insulin delivery after a Suspend before low or Suspend on low event occurred.	<ul style="list-style-type: none"> • Select OK to clear the message. • Check BG. • Follow instructions from a healthcare professional and continue to monitor BG.
Basal delivery resumed Low settings change caused basal to be resumed at XX:XX AM/PM. Check BG.	Alert	The pump is resuming basal insulin delivery after a Suspend before low or a Suspend on low event occurred, because the Suspend before low or the Suspend on low feature was turned off.	<ul style="list-style-type: none"> • Select OK to clear the alert. • Check BG. • Follow instructions from a healthcare professional and continue to monitor BG.

Title and text	Type	Explanation	Next steps
<p>Basal delivery resumed</p> <p>Maximum 2 hour suspend time reached. Check BG.</p>	Alert	The pump is resuming basal insulin delivery two hours after a Suspend before low or Suspend on low event occurred.	<ul style="list-style-type: none"> • Select OK to clear the alert. • Check BG. • Follow instructions from a healthcare professional and continue to monitor BG.
<p>Basal delivery resumed</p> <p>Maximum 2 hour suspend time reached. SG is still under Low limit. Check BG.</p>	Alarm	The pump is resuming basal insulin delivery two hours after a Suspend before low or Suspend on low event occurred.	<ul style="list-style-type: none"> • The pump has resumed basal insulin delivery; however, the SG reading is still at or below the low limit. • Select OK to clear the alarm. • Check BG. • Follow instructions from a healthcare professional and continue to monitor BG.
<p>BG not received</p> <p>Place pump close to transmitter. Select OK to resend BG to transmitter.</p>	Alert	The transmitter was unable to receive the calibration BG meter reading from the pump.	<ul style="list-style-type: none"> • Move the pump and transmitter closer together. • Select OK to clear the alert, and then enter a new BG meter reading.
<p>Calibration not accepted</p> <p>Wait at least 15 minutes. Wash hands, test BG again and calibrate.</p>	Alert	The system was unable to use the BG meter readings entered to calibrate the sensor.	<ul style="list-style-type: none"> • Wash and dry hands thoroughly. See <i>Entering a BG reading for calibration, page 172</i>. • Select OK to clear the alert. • After 15 minutes, enter a new BG meter reading for calibration as instructed in <i>Calibrating the sensor, page 171</i>. If a Calibration not accepted alert is received on the second calibration after 15 minutes, a Change sensor alert occurs. • Contact 24-Hour Technical Support for assistance, if needed.
<p>Change sensor</p> <p>Insert new sensor and Start New Sensor.</p>	Alert	No was selected in the Check sensor insertion message, indicating that the sensor is not fully inserted.	<ul style="list-style-type: none"> • Select OK to clear the alert. • Change the sensor. For details, see the sensor user guide. • After the sensor is changed, refer to <i>Starting the sensor, page 170</i>.

Title and text	Type	Explanation	Next steps
Change sensor Second calibration not accepted. Insert new sensor.	Alert	This alert occurs when two Calibration not accepted alerts are received in a row.	<ul style="list-style-type: none"> • Select OK to clear the alert. • Change the sensor. For details, see the sensor user guide.
Change sensor Sensor not working properly. Insert new sensor.	Alert	This alert occurs when the transmitter diagnoses a problem with the sensor that cannot be resolved.	<ul style="list-style-type: none"> • Select OK to clear the alert. • Change the sensor. For details, see the sensor user guide.
Check connection Ensure transmitter and sensor connection is secure, then select OK.	Alert	The pump fails to detect the transmitter and is unable to receive sensor signal.	<ul style="list-style-type: none"> • Select OK to clear the alert. • If the sensor is fully inserted, select Yes. If the sensor is not fully inserted, select No. • If the sensor was not fully inserted, insert a new sensor. • See <i>Pump issues, page 280</i> for additional assistance, if needed.
Enter BG now Enter BG to calibrate sensor.	Alert	A BG meter reading is required to calibrate the sensor. SG readings cannot be received until the sensor is calibrated.	<ul style="list-style-type: none"> • Select OK to clear the alert. If no BG meter reading is entered, the Enter BG now alert occurs again under the following conditions: <ul style="list-style-type: none"> – After 30 minutes if no Snooze time was previously set. – After the previously entered Snooze time, if the Snooze time was one hour or less. – After one hour if the previously entered Snooze time was greater than one hour. • Select Snooze, enter the desired Snooze time. The Snooze time can be set between five minutes and four hours in increments of five minutes. Select OK. If no BG meter reading is entered before the Snooze time has

Title and text	Type	Explanation	Next steps
			<p>ended, the Enter BG now alert occurs again.</p> <ul style="list-style-type: none"> Enter a BG meter reading to calibrate the sensor.
<p>Enter BG now Enter BG to calibrate sensor. Sensor information is no longer available</p>	Alert	A BG meter reading is required to calibrate the sensor. SG readings cannot be received until the sensor is calibrated.	<ul style="list-style-type: none"> Select OK to clear the alert. If no BG meter reading is entered within 30 minutes, the Enter BG now alert occurs again. Select Snooze, enter the desired snooze time, and select OK. If no BG meter reading is entered before the Snooze time has ended, the Enter BG now alert occurs again. Enter a BG meter reading to calibrate the sensor.
<p>High SG Glucose was 250 mg/dL or higher for more than 3 hours. Check infusion set. Check ketones. Monitor glucose.</p>	Alert	SG was 250 mg/dL or higher for three hours.	<ul style="list-style-type: none"> Select OK to clear the alert. Check BG and treat as necessary.
<p>Lost sensor signal Move Pump closer to transmitter. May take 15 minutes to find signal.</p>	Alert	A transmitter signal has not been received for 30 minutes during or after sensor initialization.	<ul style="list-style-type: none"> Move the pump closer to the transmitter. It can take up to 15 minutes for the pump to establish communication with the transmitter. Select OK to clear the alert.
<p>Low battery transmitter Recharge transmitter within 24 hours.</p>	Alert	The battery in the transmitter needs to be recharged within 24 hours.	<ul style="list-style-type: none"> Select OK to clear the alert. Recharge the transmitter as soon as possible.
<p>Low SG XX mg/dL SG is under 54 mg/dL. Check BG and treat.</p>	Alarm	The SG reading has fallen below 54 mg/dL. This alarm is factory set and cannot be changed or turned off. This alarm cannot be silenced and is always active, whether	<ul style="list-style-type: none"> Select OK to clear the alarm. Check BG and treat as necessary.

Title and text	Type	Explanation	Next steps
		the pump is using the SmartGuard feature or Manual mode.	
Note: This alarm does not suspend insulin delivery.			
Note: XX represents the current SG reading that appears on the pump. This alarm remains until the alarm is cleared, even if glucose values reach or rise above 54 mg/dL.			
 <p>WARNING: For MiniMed 780G Users Ages 7-13: Do not rely solely on the use of a low sensor glucose (SG) value for “Alert on Low” or “Alert before Low” or the “Low SG” alarm. A low sensor glucose alert may not reflect the user’s true blood glucose at these levels, or may not alert. Do not ignore symptoms of low glucose. Always confirm sensor glucose readings with a blood glucose meter, and treat according to the recommendations of a healthcare professional. Solely relying on these sensor glucose alerts and readings for treatment decisions could result in missing severe hypoglycemia (low blood glucose) events.</p>			
Medical device CALL FOR EMERGENCY ASSISTANCE. I have diabetes.	Alarm	The pump is suspended due to low SG and there has been no response to the alarm within 10 minutes.	<ul style="list-style-type: none"> Select Dismiss. Immediately call for emergency assistance.
No calibration occurred Confirm sensor signal. Calibrate by XX:XX AM/PM.	Alert	The transmitter was unable to receive the calibration BG meter readings from the pump.	<ul style="list-style-type: none"> Select OK to clear the alert. Check the status icons on the Home screen to confirm that the pump has a signal from the sensor. If there is no sensor signal, see <i>Sensor issues</i>, page 283. For SG readings to be monitored without interruption, enter or confirm a BG meter reading by the time displayed on the pump screen.
No calibration occurred Confirm sensor signal. Check BG again to calibrate sensor.	Alert	The transmitter was unable to receive the required calibration BG meter readings from the pump. Calibration is required by the system for SG readings to resume. “Calibration required”	<ul style="list-style-type: none"> Select OK to clear the alert. Take another BG meter reading and calibrate again.

Title and text	Type	Explanation	Next steps
		appears on the sensor graph.	
Possible signal interference Move away from electronic devices. May take 15 minutes to find signal.	Alert	There may be interference from another electronic device that is affecting the communication between the pump and the transmitter.	<ul style="list-style-type: none"> Move away from other electronic devices. It can take up to 15 minutes for the pump to start communicating with the transmitter. Select OK to clear the alert.
Rise Alert Sensor glucose rising rapidly.	Alert	The SG reading has been rising as fast or faster than the preset Rise Alert limit.	<ul style="list-style-type: none"> Select OK to clear the alert. Check BG using a meter. Follow instructions from a healthcare professional.
Sensor connected If new sensor, select Start New. If not, select Reconnect.	Message	The transmitter has detected that a sensor is connected. The pump needs to know if this is a new sensor or if an old sensor has been reconnected.	<ul style="list-style-type: none"> If a new sensor has been connected, select Start New Sensor. If a sensor that was already being used has been reconnected, select Reconnect Sensor. In either case, a "Sensor warm up ..." message appears on the Home screen when the sensor is ready for calibration. The pump starts receiving SG readings again after the two hour initialization is complete.
Sensor connected Start new sensor.	Message	The pump has detected that this is a new sensor, which needs to be started and warmed-up.	<p>Select Start New Sensor.</p> <p>The alert closes and a "Warm-up" message appears on the sensor graph with a progress bar.</p>
Sensor expired Insert new sensor.	Alert	The sensor has reached the end of its useful life.	<ul style="list-style-type: none"> Change the sensor. For details, see the sensor user guide. Select OK to clear the alert.
Sensor signal not found See User Guide.	Alert	After multiple attempts, the pump failed to detect the transmitter and is unable to receive sensor signal.	<ul style="list-style-type: none"> Select OK to clear the alert. If the pump still cannot find the sensor signal, contact 24-Hour Technical Support for assistance.

Title and text	Type	Explanation	Next steps
<p>Sensor updating</p> <p>Updating can take up to 3 hours. Monitor BG. Entered BGs will not calibrate the sensor, but can still be used for therapy.</p>	Alert	The SG reading is unavailable due to a temporary situation.	<ul style="list-style-type: none"> Select OK to clear the alert. Follow the instructions on the pump screen. The sensor does not need to be changed.
<p>Sensor warm-up started</p> <p>Warm-up takes up to 2 hours. You will be notified when calibration is needed.</p>	Message	The sensor warm-up has started.	<p>Select OK to clear the message.</p> <p>A "Warm-up" message with a progress bar appears on the sensor graph during warm-up. Warm-up takes up to two hours to complete.</p> <p>A notification will appear when calibration is needed.</p>
<p>Suspend before low</p> <p>Delivery stopped. Sensor glucose approaching Low Limit. Check BG.</p>	Alert	The SG reading is falling. Insulin delivery is suspended according to the Suspend before low setting and the SG is approaching the specified low limit. The Suspend before low feature is not available with the SmartGuard feature.	<ul style="list-style-type: none"> Select OK to clear the alert. Check BG. If necessary, treat BG as directed by a healthcare professional.
<p>Suspend on low</p> <p>Delivery stopped. Sensor glucose XX mg/dL. Check BG.</p>	Alarm	The SG reading is at or below the specified low limit. The Suspend on low feature is not available with the SmartGuard feature.	<ul style="list-style-type: none"> Select OK to clear the alarm. Check BG. If necessary, treat BG as directed by a healthcare professional.
<p>Transmitter battery depleted</p> <p>Recharge transmitter now.</p>	Alert	The battery in the transmitter needs to be recharged. SG readings cannot be recorded or transmitted until the transmitter is recharged.	<ul style="list-style-type: none"> Select OK to clear the alert. Recharge the transmitter.

SmartGuard feature alerts and messages

The following table lists the most common or serious alerts and messages related to the SmartGuard feature. The table also explains the meaning, consequences, and the reasons why these notifications appear, and provides any necessary steps for problem resolution.

Title and text	Type	Explanation	Next steps
SmartGuard started Current action canceled.	Alert	An operation that is not allowed while transitioning to the SmartGuard feature has been selected.	<ul style="list-style-type: none"> Select OK to clear the alert. Allow the pump to complete its transition to the SmartGuard feature.
SmartGuard exit Basal xxxx started. Would you like to review the SmartGuard Checklist?	Alert	<p>The pump has exited the SmartGuard feature because:</p> <ul style="list-style-type: none"> the sensor has been turned off the pump has been delivering basal insulin based on insulin delivery history, and not SG readings for the maximum of four hours. <p>This alert cannot be silenced, and is always active whenever the system is using the SmartGuard feature.</p>	<ul style="list-style-type: none"> Select No to clear the alert. Select Yes to view the SmartGuard Checklist. Enter a BG meter reading to calibrate the sensor. Follow instructions from a healthcare professional and continue to monitor BG. <p>For details, see <i>Exiting the SmartGuard feature</i>, page 202 and <i>Returning to the SmartGuard feature after an exit</i>, page 202.</p>
SmartGuard exit Insulin delivery is still suspended.	Alert	<p>The pump has exited the SmartGuard feature because:</p> <ul style="list-style-type: none"> the sensor has been turned off a suspend event message has not 	<ul style="list-style-type: none"> Enter a BG meter reading to calibrate the sensor. Manually resume basal insulin delivery, when appropriate. Follow instructions from a healthcare professional and continue to monitor BG.

Title and text	Type	Explanation	Next steps
		<p>been cleared within four hours</p> <ul style="list-style-type: none"> the pump has been delivering basal insulin based on insulin delivery history, and not SG readings for the maximum of four hours. <p>This alert cannot be silenced, and is always active whenever the system is using the SmartGuard feature.</p>	<p>For details, see <i>Exiting the SmartGuard feature, page 202</i> and <i>Returning to the SmartGuard feature after an exit, page 202</i>.</p>
<p>Enter BG now SmartGuard has been at maximum delivery rate for 7 hours. Enter BG to continue in SmartGuard.</p>	Alert	<p>SmartGuard has been delivering at the maximum SmartGuard basal delivery rate for seven hours. This rate is determined automatically by the system.</p>	<ul style="list-style-type: none"> Select OK to clear the alert. Enter a BG meter reading to return to Auto Basal. Follow instructions from a healthcare professional and continue to monitor BG.
<p>Enter BG now SmartGuard has been at maximum delivery rate for 7 hours. Enter BG to continue in SmartGuard. This event occurred while pump was suspended, and action is required to resume delivery.</p>	Alert	<p>The pump is suspended and the SmartGuard feature has been unable to lower the SG reading. SG is predicted to remain above the SmartGuard target.</p>	<ul style="list-style-type: none"> Select OK to clear the alert. Enter a BG meter reading. Follow instructions from a healthcare professional and continue to monitor BG.
<p>Notes:</p> <ul style="list-style-type: none"> The title of the alert appears the same as the previous SmartGuard max delivery alert in the table. If the pump is suspended, there will be no delivery. However, the alert may still occur. 			

Title and text	Type	Explanation	Next steps
Enter BG now SmartGuard has reached the time limit for minimum delivery rate. Enter BG to continue in SmartGuard.	Alert	The SmartGuard feature has reached the time limit for minimum delivery. The minimum delivery time is three to six hours, depending on the reason for the minimum delivery rate.	<ul style="list-style-type: none"> Select OK to clear the alert. Enter a BG meter reading to return to Auto Basal. Follow instructions from a healthcare professional and continue to monitor BG.
Enter BG now SmartGuard has reached the time limit for minimum delivery rate. Enter BG to continue in SmartGuard. This event occurred while pump was suspended, and action is required to resume delivery.	Alert	SmartGuard has reached the time limit for minimum delivery. The minimum delivery time is three to six hours, depending on the reason for the minimum delivery rate.	<ul style="list-style-type: none"> Select OK to clear the alert. Enter a BG meter reading. Follow instructions from a healthcare professional and continue to monitor BG.
Notes:			
<ul style="list-style-type: none"> The title of the alert appears the same as the previous SmartGuard min delivery alert in the table. If the pump is suspended, there will be no delivery. However, the alert may still occur. 			
Enter BG now Enter BG to continue in SmartGuard.	Alert	The SmartGuard feature requires a BG reading to check the reliability of the sensor.	<ul style="list-style-type: none"> Select OK to clear the alert. Enter a BG meter reading to return to Auto Basal, or to enter the SmartGuard feature from Manual mode.
High BG XXX mg/dL Check infusion set. Check ketones. Monitor BG. Confirm BG?	Alert	The BG meter reading is above 250 mg/dL. This alert applies only to the SmartGuard feature. There is a similar alert for Manual mode when the SmartGuard feature is off. See <i>SmartGuard</i> , page 181.	<ul style="list-style-type: none"> Select No to prevent the remote BG from being used by the pump. Select Yes to confirm the BG reading.

CareLink software alert and message

The following table lists the most common or serious alerts and messages related to CareLink software. The table also explains the meaning, consequences, and the reasons why these notifications appear, and provides steps for problem resolution. If an alarm, alert, or message occurs that is not listed, select **OK** to clear the notification and contact 24-Hour Technical Support.

Title and text	Type	Explanation	Next steps
CareLink uploader not found. Follow instructions on the CareLink uploader.	Message	The pump cannot find the CareLink uploader because the wrong pump code was entered, or the search timed out before the pump found the uploader.	<ul style="list-style-type: none">• Select OK to clear the message.• Follow the instructions on the CareLink uploader. For details, see <i>Uploading device data to CareLink software</i>, page 142.
Download slow Insulin delivery not affected. CareLink download may take longer than usual. Select OK to continue. See User Guide.	Alert	The download of pump data is taking longer than expected. Data will not be affected.	<ul style="list-style-type: none">• Select OK to clear the alert.• Wait for the data to finish downloading.• If problem still persists or if there is no progress in download, call 24-Hour Technical Support for assistance.

Appendix B: Product specifications



Appendix B: Product specifications

This appendix provides detailed product specifications.

Specifications and default settings

Alarm and alert escalation

The following alerts may escalate to a siren if not cleared:

- Alert before high
- Alert before low
- Alert on high
- Alert on low
- Basal delivery resumed
- BG not received
- Calibration not accepted
- Change sensor
- Enter BG now
- Lost sensor signal
- No calibration occurred
- Possible signal interference
- High SG
- Rise Alert
- Sensor expired
- Sensor signal not found
- Low SG XX mg/dL (XX is a value below 54 mg/dL)
- Sensor updating
- Warm up not started

The MiniMed 780G insulin pump may generate a siren if the alert is not cleared within ten minutes. Before ten minutes, the pump beeps, vibrates, or both, depending on the sound and vibration settings.

Minutes	Sound	Vibration	Sound and vibration
0-5	Beep	Vibrate	Beep and vibrate
6-9	Beep and vibrate	Sound and vibrate	Beep and vibrate
10	Siren and vibrate	Siren and vibrate	Siren and vibrate



Note: The Medical device alarm plays a siren when this screen appears.

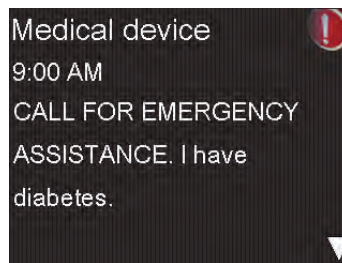

Altitude range

- Operating range: 10.2 psiA (70.33 kPa) to 15.4 psiA (106.18 kPa)
- Storage range: 7.2 psiA (49.64 kPa) to 15.4 psiA (106.18 kPa)

Backlight

Type	LED (Light-emitting Diode)
Time out	15 seconds (default), 30 seconds, one minute, three minutes
Time out when battery is low	15 seconds (default), 30 seconds

Basal delivery

Delivery rate range	0 to 35 units per hour or the Max Basal Rate amount, whichever is lower.
Max Basal Rate default	2 units per hour

Basal patterns	Maximum of 8 patterns. Each pattern covers a 24-hour period and can have up to 48 rates. Rates are set in 30-minute increments.
Basal pattern names	Fixed names: Basal 1, Basal 2, Basal 3, Basal 4, Basal 5, Workday, Day Off, Sick Day
Increments	<ul style="list-style-type: none"> • 0.025 units per hour for basal amounts in the range 0 to 0.975 units • 0.05 units per hour for basal amounts in the range 1 to 9.95 units • 0.1 units per hour for basal amounts of 10 to 35 units

BG meter reading

The BG meter reading refers to the most recent blood glucose (BG) meter reading received from the blood glucose meter. When an Accu-Chek™* Guide Link meter is used, the reading appears on the Home screen when the Sensor feature is off. The reading also appears in the Bolus Wizard screen when a bolus is programmed.

Expiration	12 minutes
Range	20 to 600 mg/dL

Bolus delivery

Bolus Speed options	<ul style="list-style-type: none"> • Standard: 1.5 units/minute • Quick: 15 units/minute
Bolus programming increments	<ul style="list-style-type: none"> • 0.025 units • 0.05 units • 0.1 units
Fluid delivered/stroke	<ul style="list-style-type: none"> • 0.25 µL (microliter) for 0.025 unit pump stroke • 0.5 µL for 0.05 unit pump stroke • 2.0 µL for 0.2 unit pump stroke

Bolus Wizard feature default settings



Note: When using the SmartGuard feature, the Bolus Wizard feature is called the Bolus feature.

Item	Default	Limits	Maximum available segments	Increments
Carb units	grams	-	8	-
Insulin to carb ratio	None	1–200 g/U	8	0.1 g/U for 1–9.9 g/U; 1 g/U for ratios of 10 g/U to 200 g/U
Insulin Sensitivity Factor*	None	5–400 mg/dL	8	1 mg/dL
BG Target*	None	60–250 mg/dL	8	1 mg/dL
Active Insulin Time	4 hours	2 to 8 hours	1	15 minutes

*Applies to Manual mode only.

Bolus Wizard feature specifications

The Bolus Wizard feature uses four formulas to estimate a bolus, depending on the current BG reading. The following formulas apply only when the carb units are in grams.

1. If the current BG reading is higher than the High BG Target, the Bolus Wizard feature subtracts active insulin from the BG correction estimate, then adds this value to the food estimate to get the total bolus estimate. However, if the result of subtracting the active insulin amount from the BG correction estimate is a negative number (less than zero), the total bolus estimate is based only on the food estimate.

$$\text{total bolus estimate} = \frac{\text{(food estimate)}}{B} + \frac{\text{(correction estimate)}}{E} - \text{active insulin}$$

where: A = food (grams)
 B = carb ratio
 C = current BG
 D = High BG Target
 E = insulin sensitivity

Food estimate:

Carb grams ÷ Carb ratio = Units of insulin

Correction estimate:

(Current BG - High BG Target) ÷ Insulin sensitivity - Active insulin = Units of insulin

Total bolus estimate:

Food estimate + Correction estimate = Units of insulin

- If the current BG is less than the Low BG Target, the Bolus Wizard feature adds the BG correction estimate to the food estimate to get the total bolus estimate.

$$\text{total bolus estimate} = \frac{\text{(food estimate)}}{B} + \frac{\text{(correction estimate)}}{E}$$

where: A = food (grams)
 B = carb ratio
 C = current BG
 D = Low BG Target
 E = insulin sensitivity

Food estimate:

Carb grams ÷ Carb ratio = Units of insulin

Correction estimate:

(Current BG - Low BG Target) ÷ Insulin sensitivity = Units of insulin

Total bolus estimate:

Food estimate + Correction estimate = Units of insulin

3. If the current BG reading is within the High or Low BG Target, the total bolus estimate is based only on the food estimate.

$$\text{total bolus estimate} = \frac{\text{(food estimate)} \times \text{food (grams)}}{\text{carb ratio}}$$

Food estimate:

Carb grams ÷ Carb ratio = Units of insulin



Note: When the current BG reading is below the Low BG Target, an active insulin amount is not considered in the Bolus Wizard feature calculations.

Total bolus estimate = Food estimate

4. If no BG reading is entered, the total bolus estimate is based only on the food estimate.

The following list includes additional conditions to consider when using the Bolus Wizard feature.

- If a Dual Wave bolus amount is less than the estimate due to the Max bolus limit or a change that is made, the Square portion of the bolus is reduced first.
- Active insulin is the bolus insulin that has been delivered by the pump and is still working to lower glucose levels. In the Bolus Wizard and SmartGuard Bolus feature, the Active Insulin Time setting is used to calculate a correction bolus by subtracting the estimated active insulin from each bolus. This is shown as Active Insulin, or Act. Insulin, on the Home screen, Bolus screen, Manual Bolus screen, Preset Bolus screen, and Daily History screen. This prevents over-infusion of insulin and reduces the risk of hypoglycemia.

- The Bolus Wizard feature may use the current BG reading, carb units, and active insulin to calculate the estimated bolus.
- The Active Insulin Curve graph shows how the Active Insulin Time setting affects the active insulin amount that is subtracted from correction boluses over time. The percentage of insulin remaining changes at varying rates depending on the Active Insulin Time setting.

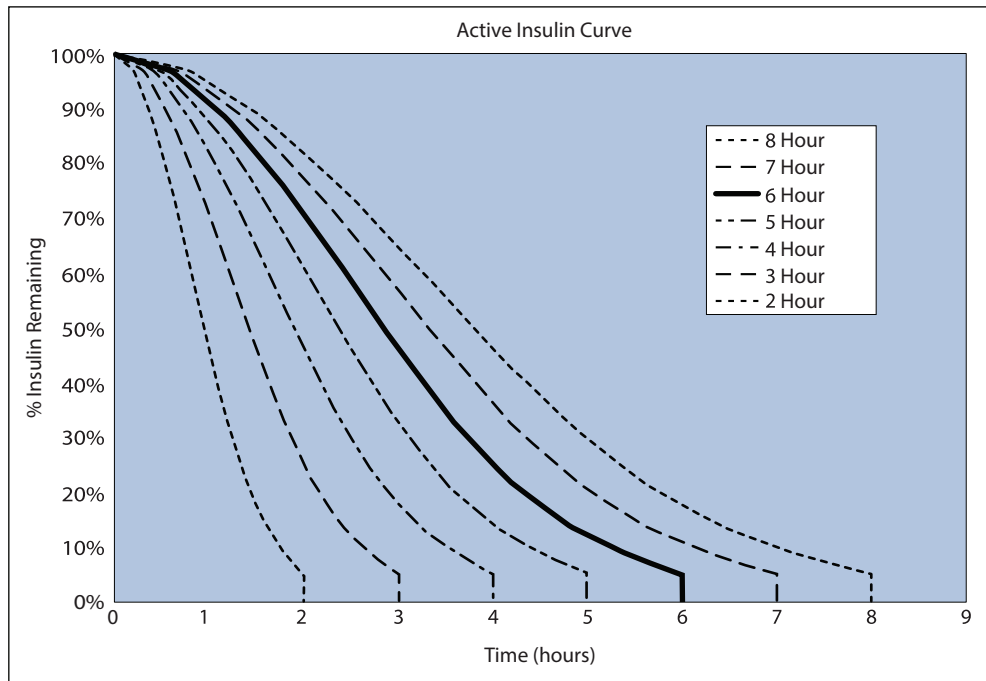

Graph adapted from Mudaliar and colleagues, Diabetes Care, Volume 22, Number 9, Sept. 1999, page 1501.

Carb ratios

Maximum ratio settings	Range
8	1 to 200 g/U

Delivery accuracy

- For a basal rate of 1.0 U/hr, the delivery accuracy is $\pm 5\%$.
For a basal rate of 0.025 U/hr, the delivery accuracy is $\pm 10\%$.

Delivery accuracy for bolus volumes < 0.1 unit is $\pm 20\%$ and delivery accuracy for bolus volumes ≥ 0.1 unit is $\pm 5\%$.

- All normal boluses are delivered within 16 minutes, 41 seconds ± 3 seconds at Standard rate (25 units, at 1.5 units per minute), and within 1 minute, 41 seconds ± 3 seconds at Quick rate (25 units, at 15 units per minute).
- During delivery, the maximum infusion pressure generated and the occlusion threshold pressure using a 3.0-mL reservoir is 13.15 psi (90.67 kPa). The average resulting bolus volume generated upon clearing the occlusion is 0.0112 mL (equivalent to 1.12 units of U-100 insulin).
- The following image is a representative delivery accuracy curve. The Trumpet Curve represents the maximum percentage change from the expected insulin dosage for a given time interval, known as the observation window, during the infusion of insulin. The upper curve corresponds to positive changes, and the lower curve corresponds to negative changes.

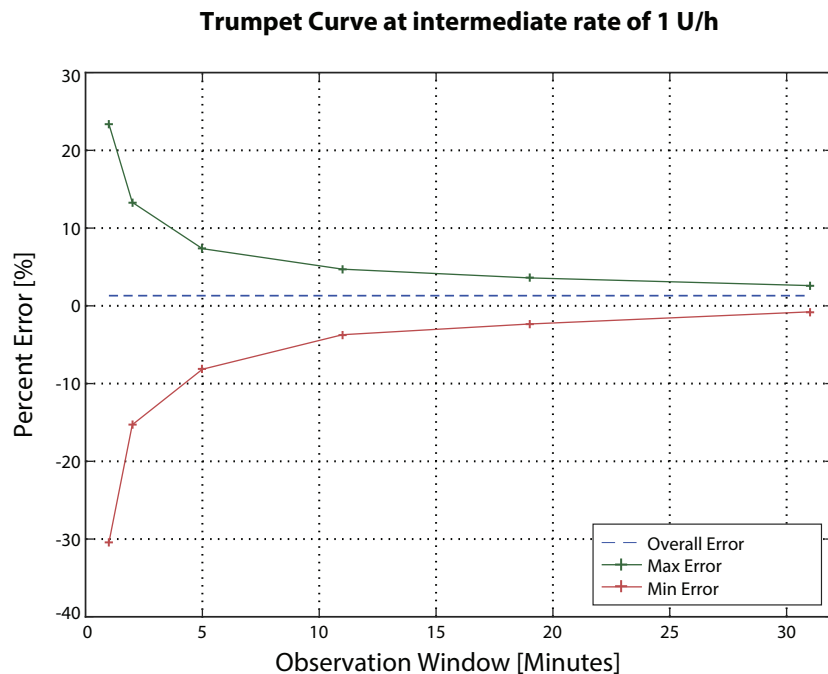

Easy bolus feature

Use the Easy bolus feature to set up and deliver a normal bolus when the pump is in Sleep mode. This is done using  and with the help of sound and vibration cues.

Sound mode range	0 to 20 increments or Max bolus limit, whichever comes first
Vibrate mode range	0 to 20 increments or Max bolus limit, whichever comes first
Default step size	0.1 unit
Adjustable step size	0.1 to 2 units per increment up to Max bolus limit

Environmental conditions

The MiniMed 780G system is designed to withstand most conditions encountered in daily life. For more details about environmental conditions, such as exposure to magnetic fields and radiation, waterproof capabilities, and extreme temperatures, see *User safety, page 32*.

- Pump storage and transport temperature range without a AA battery is from -4 °F (-20 °C) to 122 °F (50 °C).
- Pump operating temperature range is from 41 °F (5 °C) to 98.6 °F (37 °C).
- Operating air pressure range is from 10.2 psi (700 hPa) to 15.4 psi (1060 hPa).
- Storage and transport air pressure range is from 7.2 psi (496.4 hPa) to 15.4 psi (1060 hPa).
- Relative humidity (RH) range during operation is from 20% to 90%.
- RH range during storage and transport is from 5% to 95%.

Essential performance

The pump will maintain the following functionalities to avoid under-infusion and over-infusion:

- Delivery accuracy
- Occlusion detection
- Empty reservoir detection

- Detection of power loss
- Pump therapy status–UI component: LCD
- Notification annunciation and display–UI components: piezo-electric speaker, LCD–applies to all features above

Expected service life

The overall expected service life for the MiniMed 780G insulin pump is four years when used in accordance with this guide.

If there are concerns that the insulin pump may be damaged, contact 24-Hour Technical Support.

For additional information, see *Pump issues, page 280*.

For health-related questions or concerns, consult a healthcare professional.

Filling the infusion set and cannula

- The cannula can be filled from 0.025 units to 5.1 units, in increments of 0.025 units.
- The standard fill rate is 1.5 units per minute.
The quick fill rate is 15 units per minute.
- When filling the tubing, a warning occurs at 30 units. A second warning occurs at 40 units indicating that the pump must be rewound.
- Insulin used to fill the infusion set is recorded in the Daily History. This insulin is NOT included in the Total Daily Delivery (TDD) totals on the Summary screen.

Infusion pressure

The maximum infusion pressure and occlusion pressure during the fill tubing process are 25 psi (172.4 kPa).

Insulin delivery default settings

Bolus settings

Item	Default setting	Limits	Increments
Bolus Wizard feature:	Off	-	-

Item	Default setting	Limits	Increments
Easy bolus feature:	Off	-	-
Easy bolus step size:	0.1 U	0.1 U to 2 U	-
Bolus increment:	0.10 U	0.025 U 0.05 U 0.10 U	-
Dual/Square bolus:	Off	-	-
Max bolus:	10 U	0 to 25 U (per single bolus)	-
Bolus BG Check Reminder:	Off	0:30 to 5:00	0:30

Basal settings

Item	Default setting	Limits	Increments
Max Basal Rate	2 U/hr	0–35 U/hr	0.025 U for 0.025–0.975 U/hr 0.05 U for 1.00–9.95 U/hr 0.1 U for rates of 10.0 U/hr or more
Basal Rate	0.000 U/hr	0.000 U/hr to Max basal rate setting	0.025 U for 0.025–0.975 U/hr 0.05 U for 1.00–9.95 U/hr 0.1 U for rates of 10.0 U/hr or more
Temp Basal Type	Percent	Percent, Rate	N/A
Temp Basal Percent	100%	0–200%	5%
Temp Basal Rate	Current basal rate	0.0 U/hr to Max Basal Rate	0.025 U for 0.025–0.975 U/hr

Item	Default setting	Limits	Increments
			0.05 U for 1.00–9.95 U/hr 0.1 U for rates of 10.0 U/hr or more

Low Reservoir reminder

The values are based on amount shown, not actual amount.

Alert range	Increment	Default value
The first reminder occurs at 5 to 50 units. The second reminder occurs at half of the remaining specified amount. The second reminder is automatic and cannot be changed.	1 unit	20 units

Max bolus

Range	0 to 25 units
Default	10 units

Normal bolus

Range is 0.025 to 25 units of insulin, and limited by the Max bolus setting.

Occlusion detection

When occlusion is detected, the Insulin flow blocked alarm occurs. The occlusion alarm is triggered by an average of 2.23 units of missed insulin (standard bolus) or 1.97 units of missed insulin (quick bolus). This table shows occlusion detection for four different situations when using U-100 insulin.

Rate	Minimum time before alarm	Average time before alarm	Maximum time before alarm
bolus delivery (10 units at standard speed)	71 seconds	95 seconds	136 seconds
bolus delivery (10 units at quick speed)	9 seconds	10 seconds	14 seconds

Rate	Minimum time before alarm	Average time before alarm	Maximum time before alarm
basal delivery (1.0 U/hr)	2.00 hours	2.50 hours	3.80 hours
basal delivery (0.025 U/hr)	123.38 hours	142.03 hours	178.33 hours



Note: Certain factors, such as ambient temperature changes or the presence of air in the infusion set or the reservoir, can delay an occlusion alarm.

Percent temp basal

The default value is 100 percent of basal programming. For example, if six units of basal insulin are delivered per day, the default temp basal amount will be six units per day.

Range	0 to 200%
Default	100% of basal programming
Increment	5%

Program safety checks

A single fault condition causes the pump to suspend insulin delivery. Maximum infusion with a single fault condition is 0.2 units.

Pump dimensions

The pump dimensions in inches are no greater than 3.81 length x 2.18 width x 1.01 depth.

The pump dimensions in centimeters are no greater than 9.68 length x 5.36 width x 2.49 depth.

Pump memory

User settings and pump history are stored in pump memory. The pump keeps at least 35 days of history.

Pump weight

The mass of the insulin pump without battery and consumables is less than 106 grams.

Sensor default settings

High sensor settings			
Item	Default setting	Limits	Increments
High SG alert limit	250 mg/dL	100 to 400 mg/dL	5 mg/dL
High SG fixed alert	On (cannot be turned off)	250 mg/dL for 3 hours	-
Alert before high	Off	-	-
Alert on high	Off	-	-
Time before high	15 minutes	5 to 30 minutes	5 minutes
Rise Alert	Off	-	-
Rise Limit	Two up arrows	<ul style="list-style-type: none"> • 1 up arrow (1 mg/dL/min) • 2 up arrows (2 mg/dL/min) • 3 up arrows (3 mg/dL/min) • Custom limit (1.0 to 5.0 mg/dL/min) 	
High Snooze	1 hour	5 minutes to 3 hours	5 minutes
Low sensor settings			
Item	Default setting	Limits	Increments
Low SG alert limit	60 mg/dL	50 to 90 mg/dL	5 mg/dL
Low SG alarm	On (cannot be turned off)	54 mg/dL	-
Suspend before low	Off	-	-
Suspend on low	Off	-	-

Low sensor settings

Item	Default setting	Limits	Increments
Alert before low	Off	-	-
Alert on low	Off	-	-
Low Snooze	20 minutes	5 minutes to 1 hour	5 minutes
Resume basal alert	Off	-	-

The SmartGuard feature settings

Item	Default setting	Limits	Increments
SmartGuard	Off	-	-
Target	100 mg/dL	100 to 120 mg/dL	10 mg/dL
Auto Correction	On	120 mg/dL	-
Temp Target	Off	150 mg/dL	-
Temp Target Duration	2 hours	30 minutes to 24 hours	30 minutes

Sound frequency

The following table lists audible tones that the pump emits, and their corresponding frequencies:

Tone name	Frequency
Alarm	1655 Hz followed by 3310 Hz
Alternate Alarm	1850 Hz
Siren (escalated alarm)	1655 Hz, followed by 3310 Hz
Alert	934 Hz
High SG	1312 Hz, followed by 1410 Hz, 1500 Hz, 1619 Hz, 1722 Hz
Low SG	1722 Hz, 1619 Hz, 1500 Hz, 1410 Hz, 1312 Hz
Lost SG	1485 Hz, followed by 1395 Hz, 1320 Hz, 1395 Hz

Tone name	Frequency
Message tone	1655 Hz
Suspend message tone	2100 Hz, followed by 1800 Hz and 2100 Hz
Reminder tone	934 Hz
Fill tubing tone	1850 Hz
Bolus delivery cancellation tone	1485 Hz, followed by 1655 Hz and 1485 Hz
Loading complete tone	934 Hz
Reservoir loading in progress tone	1850 Hz
Easy bolus activation	1045 Hz
Easy bolus step 1 increment	1175 Hz
Easy bolus step 2 increment	1320 Hz
Easy bolus step 3 increment	1395 Hz
Easy bolus step 4 increment	1570 Hz
Easy bolus step 5 increment	1760 Hz

IEC 60601-1

IEC 60601-1-2, Special EMC Precautions for Medical Electrical Equipment

1. Special Precautions regarding Electromagnetic Compatibility (EMC): This body worn device is intended to be operated within a reasonable residential, domestic, public or work environment, where common levels of radiated "E" (V/m) or "H" fields (A/m) exist; such as cellular phones that are not paired with the MiniMed 780G system, Wi-Fi™* networks, Bluetooth™* wireless technology, electric can openers, microwave and induction ovens. This device generates, uses, and can radiate radio frequency energy and, if not installed and used in accordance with the provided instructions, may cause harmful interference to radio communications.
2. Portable and mobile RF communications equipment can affect Medical Electrical Equipment as well. If RF interference from a mobile or stationary RF transmitter is encountered, move away from the RF transmitter that is causing the interference.

IEC 60601-1

The MiniMed 780G system should not be used adjacent to other electrical equipment. If adjacent use becomes necessary, the MiniMed 780G system should be observed to confirm normal system operation.

IEC 60601-1-10: PCLCS

The MiniMed 780G is a Physiological Closed-Loop Controlled system (PCLCS).

Auto Mode manages basal delivery using a closed loop control algorithm based on a Proportional Integral Derivative controller with insulin feedback (PID-IFB). The PID-IFB monitors the Rate Of Change (ROC) of sensor glucose (SG) and calculates the insulin volume using the Insulin On Board (IOB) and the reported Carbs. The closed loop controller uses continual feedback of SG values to calculate the insulin delivery rate for basal insulin control. The control algorithm is part of the pump application code. SG values are received by the pump via RF from the CGM sensor. This theory of operation is described in the following block diagram.

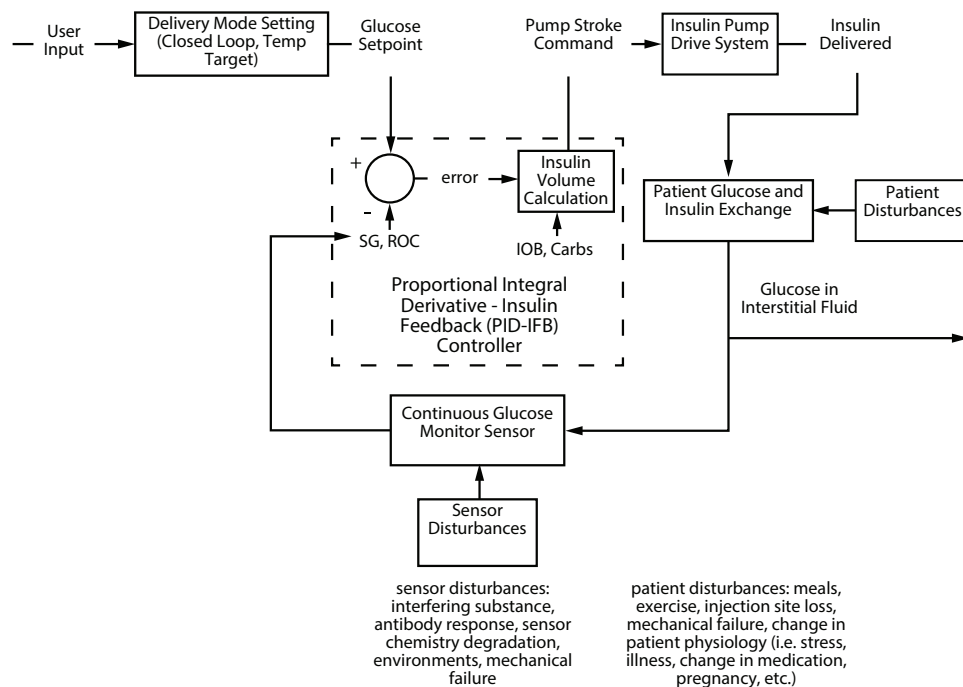

Guidance and manufacturer's declaration

Guidance and Manufacturer's Declaration - Electromagnetic Emissions		
<p>The MiniMed 780G insulin pump is intended for use in the electromagnetic environment specified below. Make sure that the MiniMed 780G insulin pump is used in such an environment.</p>		
Emissions Test	Compliance	Electromagnetic Environment - Guidance
RF emissions Test: 47 CFR Part 15, Subpart C Section 15.247/FCC Part 15 Subpart B Section 15.109	<ul style="list-style-type: none"> • 6 dB and 99% Bandwidths: Complies • Maximum Output Power: Complies • TX Spurious Emissions: Complies • Power Spectral Density: Complies • Radiated Emissions at Band Edge: Complies 	The MiniMed 780G insulin pump must emit electromagnetic energy in order to perform its intended function. Nearby electronic equipment may be affected.
Harmonic emissions IEC 61000-3-2	Not applicable	
Voltage fluctuations/flicker emissions IEC 61000-3-3	Not applicable	
RF emissions CISPR 11 (2009)+A1	Complies Group 1 Class B	The MiniMed 780G insulin pump is suitable for use in aircraft and in all establishments, including domestic and those directly connected to the public low-voltage power supply network that supplies buildings used for domestic purposes.
RTCA DO 160G (2010) 20.5 and 21.5	Complies	

Guidance and Manufacturer's Declaration - Electromagnetic Immunity			
The MiniMed 780G insulin pump is intended for use in the electromagnetic environment specified below. Make sure that the MiniMed 780G insulin pump is used in such an environment.			
Immunity Test	IEC 60601-1-2 Test Level	Compliance Level	Electromagnetic Environment - Guidance
Electrostatic discharge (ESD) IEC 61000-4-2, 60601-1-2	±8 kV contact ±2, 4, 8, 15 kV air	±8 kV contact ±2, 4, 8, 15 kV air	For use in a typical domestic, commercial, or hospital environment.
Conducted disturbances induced by RF fields	3 V _{RMS} 150 kHz to 80 MHz 6 V _{RMS} ISM bands between 150 kHz to 80 MHz	Not applicable	Requirement does not apply to this battery powered device.
Electrical fast transient/burst IEC 61000-4-4	±2 kV 100 kHz repetition frequency	Not applicable	Requirement does not apply to this battery powered device.
Surge IEC 61000-4-5	Line to Line: ±0.5 kV, ±1 kV Line to Ground: ±0.5 kV, ±1 kV, ±2 kV	Not applicable	Requirement does not apply to this battery powered device.
Voltage dips, short interruptions, and voltage variations on power supply lines IEC 61000-4-11	0% U _T ; 0.5 cycle (at 0°, 45°, 90°, 135°, 180°, 225°, 270°, and 315°) 0% U _T ; 1 cycle (at 0°) 70% for 25/30 cycles (at 0°)	Not applicable	Requirement does not apply to this battery powered device.

Guidance and Manufacturer's Declaration - Electromagnetic Immunity			
	0% for 250/300 cycles		
Power frequency (50/60 Hz) electromagnetic field IEC 61000-4-8, IEC 60601-1-2	30 A/m (continuous field at 60 seconds)	30 A/m 400 A/m per IEC 60601-2-24	Power frequency magnetic fields should be at levels characteristic of a typical location in a typical commercial or hospital environment.
Proximity fields from RF wireless communications equipment IEC 61000-4-3	IEC 60601-1-2	IEC 60601-1-2	For use in a typical domestic, commercial, or hospital environment.
Note: U_T is the a.c. mains voltage prior to application of the test level.			

Guidance and Manufacturer's Declaration - Electromagnetic Immunity			
The MiniMed 780G insulin pump is intended for use in the electromagnetic environment specified below. The customer or user of the MiniMed 780G insulin pump should assure that it is used in such an electromagnetic environment.			
Immunity Test	IEC 60601-1-2 Test Level	Compliance Level	Electromagnetic Environment Guidance
Radiated RF IEC 61000-4-3 IEC 60601-1-2 EN 301 489-17	10 V/m 80 MHz to 2.7 GHz 80% AM at 1 kHz	10 V/m 80 MHz to 2.7 GHz 80% AM at 1 kHz	Portable and mobile RF communications equipment should be used no closer to any part of the MiniMed 780G insulin pump, including cables, than the recommended separation distance of 12 in (30 cm). Field strengths from fixed RF transmitters, as determined by an electromagnetic site survey, should be less than

Guidance and Manufacturer's Declaration - Electromagnetic Immunity			
			<p>the compliance level in each frequency range.</p> <p>Interference may occur in the vicinity of equipment marked with the following symbol:</p> 

Wireless communication

The MiniMed 780G insulin pump communicates using smart device connectivity.

Operating frequency/Modulation type(s)	2.4 GHz band, GFSK
Effective radiated power (ERP)	1.48 mW (1.69 dBm)
Effective isotropic radiated power (EIRP)	2.42 mW (3.83 dBm)

FCC notice

This device complies with the United States Federal Communications Commission (FCC) and international standards for electromagnetic compatibility. This device complies with Part 15 of the FCC Rules. Operation is subject to the following two conditions: (1) This device may not cause harmful interference, and (2) this device must accept any interference received, including interference that may cause undesired operation. These standards are designed to provide reasonable protection against excessive radio frequency interference, and to prevent undesirable operation of the devices from unwanted electromagnetic interference.



Note: This equipment has been tested and found to comply with the limits for a Class B digital device, pursuant to Part 15 of the FCC rules. These limits are designed to provide reasonable protection against harmful interference in a residential installation. This equipment generates, uses, and can radiate radio frequency energy and, if not installed and used in accordance with the instructions, may cause harmful interference to radio communications. However, there is no guarantee that interference will not occur in a particular installation. If this equipment does cause harmful interference to radio or television reception, which can be determined by turning the equipment off and on, the user is encouraged to try to correct the interference by one or more of the following measures:

- Reorient or relocate the receiving antenna.
- Increase the separation between the equipment and receiver.
- Decrease the distance between the transmitter and the insulin pump to 6 feet (1.8 meters) or less.
- Decrease the distance between the meter and the insulin pump to 6 feet (1.8 meters) or less.
- Increase the separation between the transmitter and the device that is receiving/emitting interference.

IMPORTANT: Do not change or modify the internal RF transmitter or antenna unless expressly approved by Medtronic Diabetes. Doing so could interfere with your ability to operate the equipment.



Note: Harmful interference is defined by the FCC as follows. Any emission, radiation or induction that endangers the functioning of a radio navigation service or of other safety services or seriously degrades, obstructs or repeatedly interrupts a radio communications service operating in accordance with FCC rules.

Open Source Software disclosure

This document identifies the Open Source Software that may be separately called, executed, linked, affiliated, or otherwise utilized by this product.

Such Open Source Software is licensed to users subject to the terms and conditions of the separate software license agreement for such Open Source Software.

Use of the Open Source Software shall be governed entirely by the terms and conditions of such license.

The source and object code, and applicable license for any Open Source Software can be obtained at the following site(s):

- LZ4-compression library (v1.9.1): <http://www.lz4.org>
- SWIG (v3.0.12): <http://www.swig.org>
- FNV-1 hash algorithm (v5.1): <http://www.isthe.com/chongo/tech/comp/fnv/> and <http://www.isthe.com/chongo/src/fnv/fnv64.c>
- CRC32 algorithm:
<https://opensource.apple.com/source/xnu/xnu-792.13.8/bsd/libkern/crc32.c>



Appendix C: Menu map

Menu map

The following diagrams provide a map to the screens and features that are available from the Menu screen.

1	2	3
<p>Insulin</p> <p>Bolus/Stop Bolus*</p> <ul style="list-style-type: none"> • Bolus Wizard • Manual Bolus • Preset Bolus* • Delivery Settings ➔ <p>Basal/Cancel Temp Basal*</p> <ul style="list-style-type: none"> • Temp Basal • Preset Temp* • Basal Patterns • Basal Pattern Setup ➔ <p>Suspend All Delivery/Resume Basal*</p> <p>Delivery Settings ➔</p>	<p>History & Graph</p> <p>History</p> <ul style="list-style-type: none"> • Summary • Daily History • Alarm History • Paired Sensors <p>Sensor Glucose Review</p> <ul style="list-style-type: none"> • High Limit • Low Limit • Days to Average <p>Graph</p> <p>Time in Range</p>	<p>SmartGuard</p> <p>SmartGuard Checklist</p> <p>Temp Target/Cancel Temp Target*</p> <p>SmartGuard Settings</p> <ul style="list-style-type: none"> • Target • Auto Correction <p>SmartGuard (On and Off)</p> <div style="background-color: #993366; text-align: center; padding: 5px;"> 4 </div> <p>Sound & Vibration</p> <p>Silence Sensor Alerts</p> <p>Volume</p> <p>Sound</p> <p>Vibration</p> <p>Alert Settings ➔</p> <div style="background-color: #cc0000; text-align: center; padding: 5px;"> 5 </div> <p>Blood Glucose</p> <p>BG</p>
<p>* indicates an item that is shown when applicable. For example, Stop Bolus is shown when a bolus is being delivered. Preset Bolus is shown when the Preset Bolus feature is set up.</p> <p>The ➔ icon indicates a shortcut to the screen.</p>		

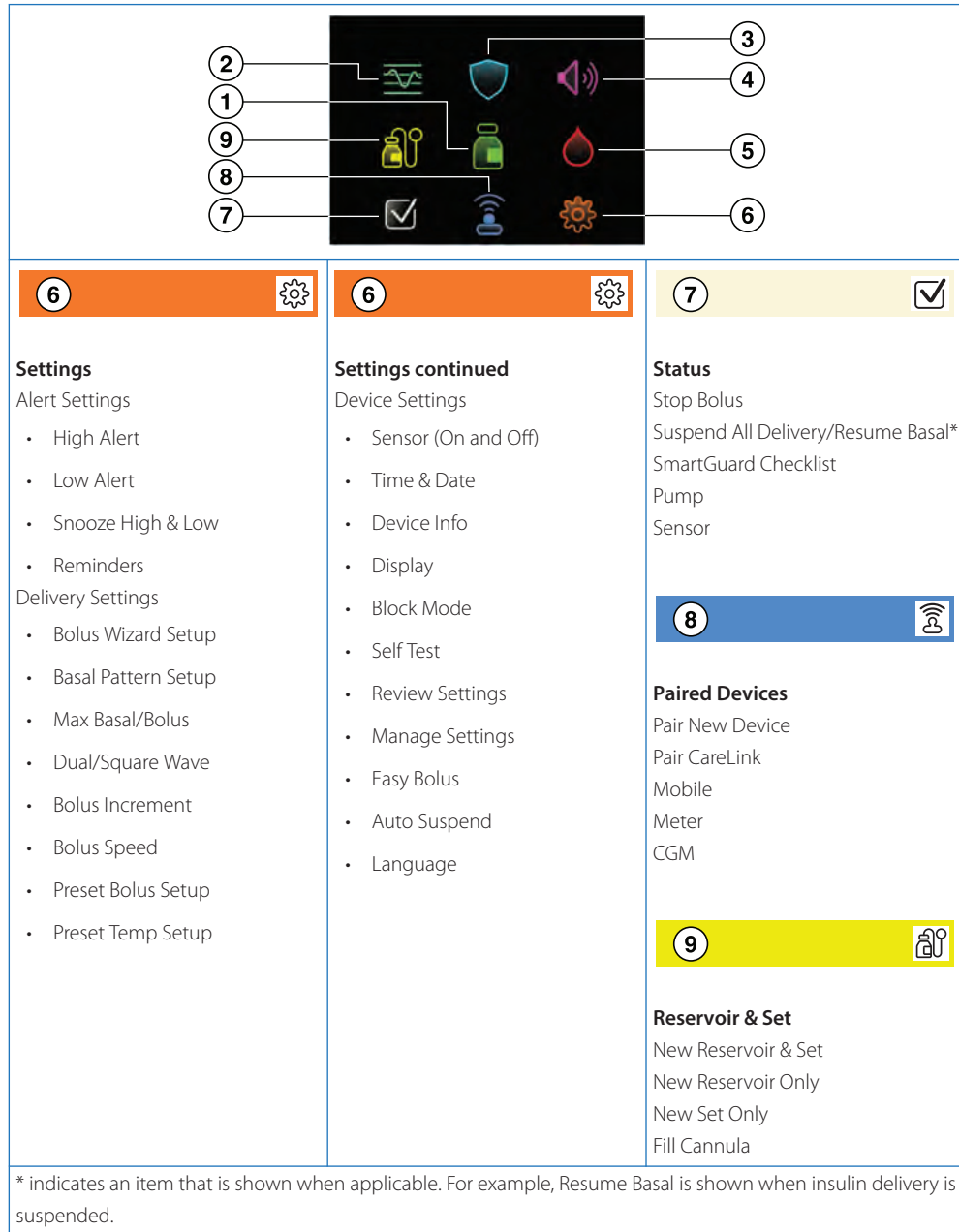

Appendix D: Performance data



Appendix D: Performance data

A. Device performance for users seven years and older

The MiniMed 780G system adjusts insulin delivery based on sensor glucose (SG) values from CGM, while alleviating the complexity of trying to maintain glucose levels around meals. Clinical studies have shown that integrated insulin pump and CGM systems may provide better diabetes management, compared with multiple daily injections, or with a pump alone. Studies suggest that pump therapy, when regulated by sensor information, can improve HbA1C levels significantly without increasing the risk of hypoglycemia.^{6,7,8}

The MiniMed 780G system continues to use the SmartGuard feature, which automatically adjusts basal insulin dosage every five minutes, delivering more or less insulin when it predicts that SG values are trending too high or too low. In addition, the system offers the following new features:

- **Adjustable glycemic target settings.** With the help of a healthcare provider, patients can program the device to one of three setpoints to target their ideal SG

⁶ Bergenstal RM, Tamborlane WV, Ahmann A, et al. Effectiveness of sensor-augmented insulin-pump therapy in type 1 diabetes [STAR3 Study]. *N Engl J Med.* 2010;363:311–320.

⁷ Battelino T, Conget I, Olsen B, et al. The use and efficacy of continuous glucose monitoring in type 1 diabetes treated with insulin pump therapy [SWITCH study]. *Diabetologia.* 2012 Dec;55(12):3155-62. doi: 10.1007/s00125-012-2708-9. Epub 2012 Sept 11.

⁸ Bergenstal RM, Klonoff DC, Bode BW, et al. Threshold-based insulin-pump interruption for reduction of hypoglycemia [ASPIRE in-home study]. *N Engl J Med.* 2013;369(3):224-232.

value (100, 110, or 120 mg/dL). The device uses the programmed setpoint as a reference to adjust the rate of insulin delivered.

- **Automatic correction boluses.** Mealtimes can be stressful and require that patients calculate boluses prior to and after meals to avoid hyperglycemia. The SmartGuard feature also includes an Auto correction feature that can calculate and deliver correction boluses every five minutes if the patient underestimates the amount of carbs in a meal or if they accidentally forget to deliver a meal bolus prior to eating.

The MiniMed 780G system includes some features that were introduced in prior Medtronic insulin pumps, referred to as the Suspend on low and Suspend before low features. These features temporarily stop insulin delivery when SG values reach a preset low target (Suspend on low) or are predicted to reach the preset low target within 15 or 30 minutes (Suspend before low). Insulin delivery also resumes when SG values return to a safe range. These optional features are available when the pump is in Manual mode and function as a backup for the SmartGuard feature.

The SmartGuard feature

Clinical study overview

The SmartGuard feature (that controls insulin dosing in the MiniMed 780G system) was studied with subjects who wore the MiniMed 670G Version 4.0 pump with the Guardian Sensor (3) at home for three months. This clinical study evaluated the safety of the system and did not include a control group. The study included subjects from different clinics around the US who were between 7 and 75 years old. Subjects had to have been diagnosed with type 1 diabetes mellitus for at least one year for subjects aged 7 to 13 years, and at least two years for subjects aged 14 to 75 years. All subjects in the study had to have used pump therapy for at least 6 months prior to screening and had an HbA1C value of less than 10.0% at the time of screening.

This study started with a run-in (baseline) period, during which the MiniMed 670G Version 4.0 system was used in Manual mode, or with the SmartGuard feature turned ON and the Auto correction feature turned OFF. The run-in period included 299

⁹ Medtronic Inc., Clinical Study Report: CIP321 Data Analysis for Subjects 7-17 Years Old and 18-75 Years Old, D00340772/B. May 2021.

subjects, and 275 of these subjects completed the study period. The system was tested for 37,705 patient days.

The MiniMed 780G system is compatible with the Guardian 4 Sensor, but the clinical study tested similar earlier-generation devices. The devices tested are considered clinically equivalent,^{10,11,12} therefore, the study results are comparable for the MiniMed 780G system. The key differences were:

MiniMed 670G Version 4.0 insulin pump – the study used this pump to evaluate the SmartGuard feature. This pump is similar to the MiniMed 780G insulin pump, except that it did not yet have the latest Bluetooth capability, the new user interface, the new 110 mg/dL setpoint, the new standard low glucose alert threshold, and the new SG range.



CAUTION: Since the clinical study supporting approval of MiniMed 780G did not include a control group, in general, conclusions regarding effectiveness cannot be drawn from the US pivotal clinical study.

Safety

Table 1 lists the device-related adverse events reported during the different phases of the clinical trial. No device-related serious adverse events, no diabetic ketoacidosis, and one episode of severe hypoglycemia (which was not device-related) were reported during the study.

¹⁰ Medtronic Inc., Engineering Report: Performance Evaluation Based on Data Collected During the CIP324 Study Using the C Algorithm, D00355118/A. Jan 2021.

¹¹ Medtronic Inc., Engineering Report: Comparison between Zeus and C Algorithms in the CIP324 Study, D00408700/A. Feb 2021.

¹² Medtronic Inc., Engineering Report: Evaluation of GST5G (Zeus) for Closed Loop (CL) Systems Use and Comparison of Insulin Delivery between AHCL with Sensor Data from GST3C and GST5G, D00409589/A. Feb 2021.

Table 1. Device-related adverse events

Event	Age 7-17 Years (N = 179)			Age 18-75 Years (N = 150)		
	Prior to run-in	Run-in period	Study period	Prior to run-in	Run-in period	Study period
Bleeding at sensor site	0	0	2	0	0	0
Bleeding from infusion site	0	0	0	0	0	1
Bruise on upper arm	0	0	1	1	0	0
Discomfort with sensor insertion	0	1	0	0	0	0
Erythema abdomen from old sensor site	0	0	0	0	1	0
Gastroenteritis ^a	0	0	1	0	0	0
Hyperglycemia	0	2	2	0	0	0
Infusion set failure	0	0	2	0	0	0
Pump site infection	0	0	1	0	0	0
Rash or contact dermatitis (sensor/tape related)	0	3	1	0	2	2
Severe hyperglycemia	0	7	15	0	1	2
Skin irritation with excoriation	0	0	1	0	0	0

^a This event was described as gastroenteritis combined with hyperglycemia and was classified as possibly device-related due to the concurrent hyperglycemia.

SmartGuard Use

During the study period, subjects used the system with the SmartGuard feature and the Auto correction feature turned ON. *Table 2* presents percentage of time that subjects spent using the sensor and the percentage of time spent using the SmartGuard (Auto mode) feature with the Auto correction feature turned ON. This information shows that the SmartGuard feature was ON greater than 90% of the time.

Table 2. Sensor and Auto Mode Usage (Percentage of Time)

Category	Age 7-17 Years (N = 160)	Age 18-75 Years (N = 128)
Time spent using sensor	88.0%	91.2%
Time spent not using sensor	12.0%	8.8%
Time spent in Auto mode	93.5%	95.2%
Time spent in Manual mode	6.5%	4.8%

SmartGuard Performance

Table 3 shows the mean percentage of daily SG values in specific glucose ranges during the run-in and study periods by all subjects. An international group of diabetes experts and the American Diabetes Association (ADA) consider patients in good control when patients are in the target glucose range of 70–180 mg/dL for more than 70% of the day.¹³ The data in *Table 3* shows that using the SmartGuard feature with the Auto correction feature kept SG values in range and reduced time above range that may

have been caused by underestimation of meal carbohydrate amounts. Specifically, adult subjects spent more time in range (70–180 mg/dL) and less time in hypoglycemia (<70 mg/dL) and hyperglycemia (>180 mg/dL) during the study period compared with the run-in period. Pediatric subjects spent more time in range (70–180 mg/dL) and less time in hyperglycemia (>180 mg/dL) without increasing time in hypoglycemia (<70 mg/dL) during the study period compared with the run-in period.

Table 3. Mean Percent of SG values in Specific Glucose Ranges (Mean ± SD)

Glucose Range (mg/dL)	Age 7-17 Years (N = 160)		Age 18-75 Years (N = 128)	
	Run-in period	Study period	Run-in period	Study period
<50	0.4 ± 0.5	0.4 ± 0.4	0.5 ± 0.7	0.3 ± 0.4
<54	0.7 ± 0.7	0.6 ± 0.5	0.8 ± 1.1	0.5 ± 0.6
<60	1.2 ± 1.1	1.2 ± 0.8	1.4 ± 1.7	1.0 ± 0.9
<70	2.7 ± 2.0	2.7 ± 1.6	3.4 ± 3.0	2.3 ± 1.7
70-180	59.4 ± 11.8	70.3 ± 6.5	70.5 ± 9.8	75.0 ± 7.2
>180	38.0 ± 12.4	27.0 ± 6.7	26.2 ± 10.2	22.6 ± 7.4
>250	12.1 ± 7.5	7.1 ± 3.8	5.5 ± 4.1	4.4 ± 3.0
>350	1.3 ± 1.6	0.7 ± 0.8	0.4 ± 0.6	0.3 ± 0.4

During the run-in and study periods, subjects performed meal challenges involving eating a meal without giving a meal bolus. These challenges were intended to evaluate how subjects' glucose would respond when a meal dose is sometimes missed. Missed meal boluses when using the SmartGuard feature with the Auto correction feature at the 100 mg/dL and 120 mg/dL SG setpoints were compared to missed meal boluses when using Manual mode. *Table 4* shows the mean SG values up to two hours before, and 1 to 3 hours after, a regular-sized dinner with a missed meal bolus during the run-in and study periods.

This data shows that using the SmartGuard feature with the Auto correction feature reduced mean SG after meals when meal boluses were missed.

¹³ Battelino T, Danne T, Bergenstal RM, et al. Clinical Targets for Continuous Glucose Monitoring Data Interpretation: Recommendations From the International Consensus on Time in Range. *Diabetes Care*. 2019 Aug; 42(8): 1593-1603. doi: 10.2337/ dci19-0028. Epub 2019 Jun 8.

Table 4. Change in Mean SG values before and after a Regular-Sized Dinner with Missed Meal Bolus

Category	Age 7-17 Years (N = 94)			Age 18-75 Years (N = 70)		
	Run-in period	Study period		Run-In Period	Study period	
		Setpoint 100 mg/dL	Setpoint 120 mg/dL		Setpoint 100 mg/dL	Setpoint 120 mg/dL
Mean SG before meal (mg/dL), Mean ± SD	140.6 ± 48.0	152.9 ± 50.5	151.5 ± 43.6	132.9 ± 42.3	138.0 ± 51.5	139.8 ± 38.7
Mean SG 2 Hours after meal (mg/dL), Mean ± SD	255.6 ± 65.0	204.7 ± 53.8	202.6 ± 51.4	210.5 ± 53.3	198.8 ± 53.3	203.1 ± 41.6
Change in Mean SG before and after the meal (mg/dL), Mean ± SD	115.0 ± 81.6	51.8 ± 62.3	51.0 ± 71.3	77.6 ± 68.5	60.8 ± 75.0	63.4 ± 60.7

During the study period, subjects exercised on 3 consecutive days while using the SmartGuard feature with the Auto correction feature at the 100 mg/dL and 120 mg/dL setpoints, and with the Temp Target feature turned ON. Temp Target allows the user to temporarily change the SG setpoint to 150 mg/dL. When Temp Target is enabled, the SmartGuard feature reverts to the previous SG setpoint after the user-set time at the 150 mg/dL setpoint elapses. *Table 5* shows the mean SG values up to two hours before, and 1 to 3 hours after, exercise during the study period only. This data shows that the SmartGuard feature with the Auto correction feature kept subject glucose levels stable during and after exercise.

Table 5. Change in Mean SG values During Exercise

Category	Age 7-17 Years (N = 131)		Age 18-75 Years (N = 115)	
	Setpoint 100 mg/dL	Setpoint 120 mg/dL	Setpoint 100 mg/dL	Setpoint 120 mg/dL
Mean SG before exercise (mg/dL), Mean ± SD	154.6 ± 30.0	156.4 ± 34.8	141.6 ± 30.3	154.0 ± 30.9
Mean SG 2 Hours after exercise (mg/dL), Mean ± SD	149.9 ± 31.7	151.2 ± 33.4	134.1 ± 26.8	141.7 ± 31.4
Change in Mean SG before and after the exercise (mg/dL), Mean ± SD	-4.7 ± 42.1	-5.2 ± 42.0	-7.5 ± 36.0	-12.3 ± 43.1

Figure 1 below shows the percentage of subjects that had an HbA1C that was less than 7% during the run-in (baseline) and study periods. The ADA considers a HbA1C target of less than 7% appropriate for non-pregnant adults and many children.^{14,15} *Figure 1*

shows that a greater percentage of subjects had an HbA1C that was less than 7% at the end of the study than at baseline.

Figure 1. Percentage of Patients with less than 7% HbA1C

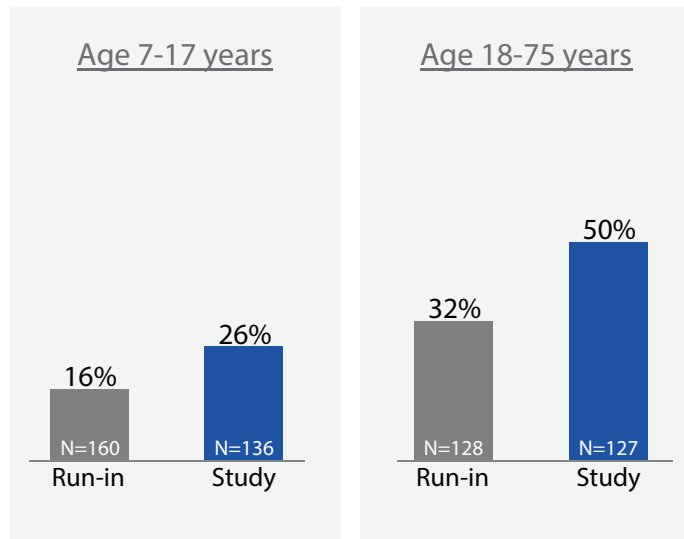

Table 6 shows changes in mean HbA1C, total daily dose of insulin (TDD), and weight, from baseline to the end of the study. Subjects mean HbA1C decreased, and TDD and weight increased slightly. This data helps explain how using the SmartGuard feature with the Auto correction feature might affect a patient’s HbA1C, TDD, and weight.

Table 6. Changes in Mean HbA1C, TDD and Weight

Category	Age 7-17 Years		Age 18-75 Years	
	Baseline	End of Study	Baseline	End of Study
HbA1C (%), Mean ± SD (Median) [N]	7.9 ± 0.9 (7.9) [160]	7.4 ± 0.7 (7.3) [136]	7.4 ± 0.8 (7.5) [128]	6.9 ± 0.5 (7.0) [127]

¹⁴ American Diabetes Association. 6. Glycemic Targets: Standards of Medical Care in Diabetes-2020. Diabetes Care 2020 Jan; 43 (Supplement 1): S66-S76.
<https://doi.org/10.2337/dc20-S006>

¹⁵ American Diabetes Association. 13. Children and Adolescents: Standards of Medical Care in Diabetes—2020. Diabetes Care. 2020 Jan; 43 (Supplement 1): S163-S182.
<https://doi.org/10.2337/dc20-S013>

Table 6. Changes in Mean HbA1C, TDD and Weight (continued)

Category	Age 7-17 Years		Age 18-75 Years	
	Baseline	End of Study	Baseline	End of Study
TDD (U), Mean ± SD (Median) [N]	42.3 ± 19.5 (40.5) [160]	44.9 ± 20.5 (43.2) [160]	53.7 ± 27.3 (49.6) [128]	55.4 ± 30.1 (48.8) [128]
Weight (kg), Mean ± SD (Median) [N]	45.8 ± 14.8 (43.1) [160]	48.5 ± 15.0 (47.4) [136]	83.3 ± 18.5 (80.2) [128]	84.1 ± 19.1 (81.2) [121]

The two tables below show the results when subjects pumps were programmed to setpoints of 100 mg/dL (*Table 7*) and 120 mg/dL (*Table 8*), while also programmed to different active insulin times according to the subject's needs. These results show that subjects spent more time in range from programming the setpoint to 100 mg/dL and the active insulin time (AIT) to 2-3 hours.

Table 7 shows that subjects with the AIT set at 2-3 hours and the 100 mg/dL target setpoint spent more time in range (70-180 mg/dL) than subjects with AIT set at any other AIT setting.



Note: The AIT setting in the MiniMed 780G system is not necessarily reflective of the physiologic insulin metabolism. Adjustments are not based on the pharmacokinetics and pharmacodynamics of the rapid-acting insulin.

Table 7. Glycemic Control Outcomes by Active Insulin Time, Setpoint 100 mg/dL^a

Category	Age 7-17 Years			Age 18-75 Years		
	AIT 120-180 minutes	AIT 195-240 minutes	AIT >240 minutes	AIT 120-180 minutes	AIT 195-240 minutes	AIT >240 minutes
Number of Subjects	107	52	2	74	54	4
Overall Average SG (mg/dL)	148.0 ± 11.8 (147.5)	153.1 ± 12.7 (151.2)	155.4 ± 9.1 (155.4)	141.4 ± 11.2 (141.0)	145.3 ± 10.4 (144.3)	145.1 ± 17.3 (150.8)
Overall SD SG (mg/dL)	56.7 ± 8.9 (56.1)	61.4 ± 8.7 (60.5)	61.6 ± 8.8 (61.6)	48.8 ± 7.9 (48.6)	51.8 ± 8.1 (50.8)	53.9 ± 7.8 (54.4)
Overall CV SG (%)	38.2 ± 4.3 (37.4)	40.0 ± 4.2 (39.6)	39.5 ± 3.3 (39.5)	34.4 ± 4.2 (34.3)	35.6 ± 4.6 (35.3)	37.1 ± 1.9 (36.3)
SG < 54 mg/dL (%)	0.7 ± 0.7 (0.5)	0.8 ± 0.8 (0.7)	0.3 ± 0.2 (0.3)	0.7 ± 0.8 (0.4)	0.6 ± 0.8 (0.3)	1.4 ± 1.1 (0.9)
SG < 70 mg/dL (%)	3.1 ± 2.0 (2.5)	3.5 ± 2.3 (3.0)	2.3 ± 0.5 (2.3)	2.9 ± 2.2 (2.4)	2.7 ± 2.2 (2.1)	4.8 ± 3.2 (3.7)
70-180 mg/dL (%)	71.9 ± 6.9 (72.0)	67.8 ± 6.8 (68.6)	68.0 ± 6.5 (68.0)	77.4 ± 7.4 (77.5)	74.8 ± 6.9 (75.7)	70.6 ± 7.9 (70.2)
SG > 180 mg/dL (%)	25.0 ± 7.1 (24.8)	28.7 ± 7.5 (27.8)	29.8 ± 6.0 (29.8)	19.7 ± 7.5 (19.2)	22.5 ± 6.9 (21.8)	24.6 ± 10.1 (26.6)
SG > 250 mg/dL (%)	6.3 ± 3.9 (5.5)	8.3 ± 4.3 (7.3)	8.6 ± 4.0 (8.6)	3.5 ± 2.8 (3.0)	4.5 ± 3.0 (4.0)	5.2 ± 3.5 (5.8)

^a Values are presented by Mean ± SD (Median) except for number of subjects.

Table 8 shows that subjects with the AIT set at 2-3 hours and the 120 mg/dL target setpoint spent more time in range (70-180 mg/dL) than subjects with the AIT set at any other AIT setting.

Table 8. Glycemic Control Outcomes by Active Insulin Time, Setpoint 120 mg/dL^a

Category	Age 7-17			Age 18-75		
	AIT 120-180 minutes	AIT 195-240 minutes	AIT>240 minutes	AIT 120-180 minutes	AIT 195-240 minutes	AIT>240 minutes
Number of Subjects	122	53	2	76	63	2
Overall Average SG (mg/dL)	153.8 ± 10.3 (153.6)	158.8 ± 11.7 (160.0)	166.9 ± 11.7 (166.9)	148.9 ± 10.8 (148.9)	153.5 ± 10.8 (153.0)	160.8 ± 16.3 (160.8)
Overall SD SG (mg/dL)	55.4 ± 9.0 (54.2)	58.5 ± 8.3 (58.9)	66.2 ± 3.3 (66.2)	47.5 ± 8.0 (46.7)	49.8 ± 8.6 (51.1)	57.0 ± 8.4 (57.0)
Overall CV SG (%)	35.9 ± 4.6 (36.1)	36.8 ± 4.0 (36.6)	39.7 ± 0.8 (39.7)	31.8 ± 4.0 (31.5)	32.4 ± 4.4 (33.1)	35.3 ± 1.6 (35.3)
SG < 54 mg/dL (%)	0.6 ± 0.6 (0.4)	0.6 ± 0.5 (0.4)	0.7 ± 0.7 (0.7)	0.4 ± 0.5 (0.3)	0.4 ± 0.5 (0.2)	0.3 ± 0.3 (0.3)
SG < 70 mg/dL (%)	2.3 ± 1.6 (1.9)	2.2 ± 1.3 (2.0)	2.7 ± 2.0 (2.7)	2.0 ± 1.7 (1.6)	1.7 ± 1.3 (1.5)	1.4 ± 0.4 (1.4)
70-180 mg/dL (%)	71.1 ± 6.6 (70.9)	67.4 ± 7.6 (66.7)	60.6 ± 4.9 (60.6)	75.8 ± 7.2 (75.9)	72.5 ± 8.0 (72.4)	68.1 ± 10.7 (68.1)
SG > 180 mg/dL (%)	26.6 ± 6.8 (26.9)	30.4 ± 7.8 (31.0)	36.7 ± 7.0 (36.7)	22.2 ± 7.6 (21.6)	25.8 ± 8.2 (25.3)	30.5 ± 10.3 (30.5)
SG > 250 mg/dL (%)	6.7 ± 3.8 (5.8)	8.4 ± 4.1 (9.0)	13.2 ± 4.6 (13.2)	4.0 ± 3.0 (3.2)	5.1 ± 3.4 (4.6)	8.3 ± 4.8 (8.3)

^a Values are presented by Mean ± SD (Median) except for number of subjects.

Figure 2 below shows the percentage of subjects that spent more than 70% of time in range (70-180 mg/dL), which is considered good glucose control by diabetes experts and the ADA, during the run-in (baseline) and study periods. The system offers three SG target setpoint options that allow users to customize insulin delivery. For the study period, percentages are shown for subjects that used the SmartGuard feature with the Auto correction feature at the 100 mg/dL and the 120 mg/dL setpoint.

The greatest percentage of subjects spent more than 70% of time in range when using the SmartGuard feature with the Auto correction feature at the 100 mg/dL setpoint compared to use with the 120 mg/dL setpoint or Manual mode. The data shows that using the SmartGuard feature with the Auto correction feature ON at any of the setpoints resulted in more subjects spending more than 70% of time in range (70-180 mg/dL) than during run-in. This data also shows that more subjects using the SmartGuard feature with the Auto correction feature at the 100 mg/dL setpoint spent more time in range than at the 120 mg/dL setpoint.

Figure 2. Percentage of Subjects who Spent More than 70% of Time in Range (70-180 mg/dL)

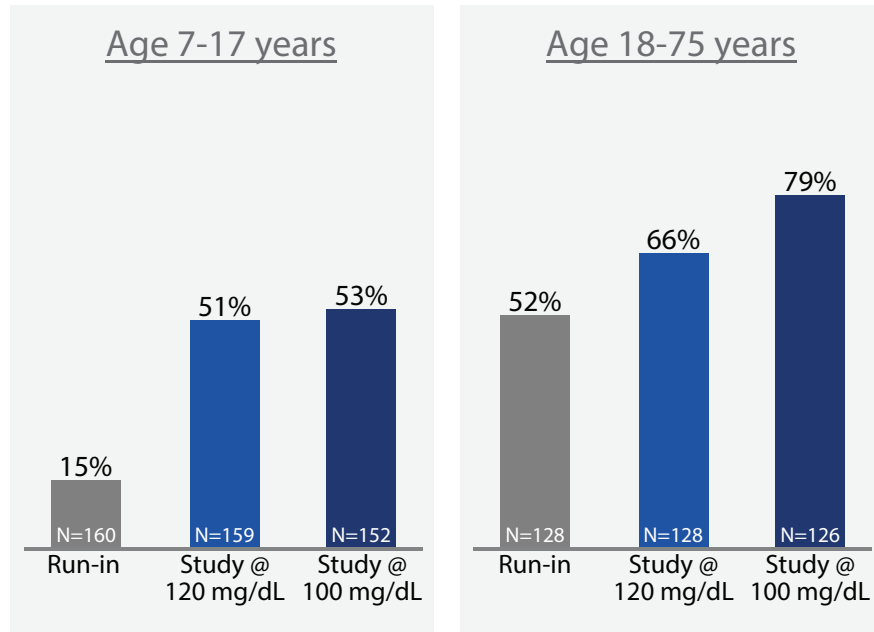

The clinical study suggested that the system was safe, and subjects showed improvements in HbA1C and TIR. However, the study had the following limitation:

It did not compare subjects who were using the Auto correction feature to those who were not on a system (control group). Instead, the study compared how subjects did before using the Auto correction feature (run in period -2 weeks) against results while using the Auto correction feature (study period -3 months).

Due to this limitation, the results of the study should be interpreted with caution and you should understand that your individual results may vary.

The Suspend before low feature

Clinical study overview (Ages 14-75 Years)

The Suspend before low feature was evaluated for safety in a multi-center, single-arm, in-clinic study of the MiniMed 640G System.¹⁶ This feature is the same in the

MiniMed 780G system. Study subjects included persons aged 14 to 75 years diagnosed with type 1 diabetes mellitus who were on pump therapy at the time of screening.

A total of 71 subjects were subjected to hypoglycemic induction, followed by an observation period. For hypoglycemic induction, the target was set to 65 mg/dL, using the rate of change basal increase algorithm. The Suspend before low feature was activated with the Low Limit setting for the Suspend before low feature ON set to 65 mg/dL, and the subject was observed with frequent sample testing (FST, or frequent blood sampling for glucose measurements) for a maximum of 19 hours. The observation period included the suspension period, the insulin resumption period, and if applicable, an insulin resuspension after basal insulin delivery resumed.

Feature performance and safety

Of the 71 subjects with induced hypoglycemia, 69 inductions were successful, 27 subjects experienced a hypoglycemic event and 42 subjects did not. At 120 minutes after the start of the pump suspension events, the mean reference glucose value (measured using a Yellow Springs Instrument [YSI™*]) was 102 ± 34.6 mg/dL.

Five adverse events were reported during the study. Four adverse events were neither device nor procedure related. One adverse event was procedure related.

Data from this in-clinic study demonstrated that the Suspend before low feature is safe to use. Study success criteria, as defined in the protocol, were met (i.e. there were no device related serious adverse events, no diabetic ketoacidosis events related to the Suspend before low feature, and no unanticipated adverse device effects).

Clinical study overview (Ages 7-13 Years)

The Suspend before low feature was also evaluated in a study of the MiniMed 670G system that included subjects 7-13 years, diagnosed with type 1 diabetes mellitus.¹⁷ This feature is the same in the MiniMed 780G system.

¹⁶ Buckingham BA, Bailey TS, Christiansen M, et al. Evaluation of a Predictive Low-Glucose Management System In-Clinic. *Diabetes Technology and Therapeutics*. 2017;19(5):288-292.

¹⁷ Forlenza G, Shulman D, Wood M, et al. Evaluation of the MiniMed™ 670G system predictive low glucose management feature in children. *Diabetes Technology and Therapeutics*. 2018;20:A19-A20.

A total of 105 study subjects were observed overnight after exercise/activity while using the system with the Suspend before low feature activated. The Low Limit setting for the Suspend before low feature turned ON was set to 65 mg/dL and the subjects were observed with FST for a maximum of 12 hours.

Feature performance and safety

In 79.7% of cases, after activation of the Suspend before low feature, the threshold of \leq 65 mg/dL was avoided. Mean glucose levels up to six hours after the suspend feature was activated remained below the starting glucose levels.

Data from this in-clinic evaluation demonstrated that the Suspend before low feature is safe to use in a pediatric population.

B. Guardian Sensor (3) Performance for 14 years old and older CGM performance

The use of the Guardian Sensor (3) with the Guardian Link (3) transmitter enables CGM technology. The transmitter transmits SG values calculated by the real-time algorithm to a primary display device, allowing you to monitor your SG values.

Clinical study description

The performance of the Guardian Sensor (3) was evaluated in a clinical study.¹⁸ This inpatient (in-clinic) and outpatient (at home) study included subjects 14 to 75 years in age. The study design was a multi-center, prospective single-sample correlational design without controls.

All subjects were assigned to treatment. Three sensors were worn at the same time by each subject.

Each subject was instructed to wear two real-time CGM systems in the abdomen area:

- One Guardian Sensor (3) connected to the Guardian Link (3) transmitter, which transmitted to the insulin pump (for display purposes only).

¹⁸ Medtronic Inc., A Performance Evaluation of the Enlite™ 3 Glucose Sensor to Support a Full 168 hours (7 Days) of Use, CER292DOC/F. Oct 2016.

- One Guardian Sensor (3) connected to the Guardian Connect transmitter which transmitted to the Guardian Connect app, a standalone CGM display device.

Each subject was also instructed to wear another Guardian Sensor (3) in the arm area that was connected to a blinded glucose sensor recorder (GSR).

The SG data collected by the blinded GSRs were retrospectively processed through the real-time CGM algorithm. This is the same algorithm used in the Guardian Connect and pump CGM systems. Thus all data is representative of real-time sensor usage.

The CONTOUR NEXT™ LINK 2.4 Wireless Meter was the study meter used for all calibrations in this study, and was the only meter evaluated with the Guardian Sensor (3) CGM systems. The sensor has not been tested with other meters. Therefore, the performance with other BG meters may differ from the performance with the CONTOUR NEXT™ LINK 2.4 Wireless Meter described below.

FST was performed on days 1, 3, and 7 over the life of the sensor. Reference blood (plasma) glucose values were obtained with a Yellow Springs Instrument (YSI) Glucose Analyzer every 5 to 15 minutes. During the FSTs, the subjects were instructed to calibrate the sensors once every 12 hours, or as requested by the display device. During home use (outside the clinic), subjects were instructed to calibrate both sensors 3 or 4 times spread throughout the day.

A total of 93 subjects previously diagnosed with type 1 or 2 diabetes were enrolled in the study, and 88 subjects participated in at least one day of FST. The overall number of subjects that participated in FST procedures on days 1, 3, and 7 were 88, 87, and 79, respectively. During each FST period, subjects with an established insulin sensitivity ratio and insulin carbohydrate ratio underwent a hypoglycemic challenge and a hyperglycemic challenge to evaluate performance at high and low glycemic ranges.

During the study, subjects were instructed to continue with their current diabetes regimen (including glucose monitoring with their own meter when appropriate) independent of their use of the study devices. The insulin pumps were not used to infuse insulin, and neither of the two real-time CGM systems nor the blinded GSR system was used to manage diabetes during this study. The study meter was used for confirmation of alerts, treatment decisions, and sensor calibrations.

Results

Sensor accuracy

The following information highlights the Guardian Sensor (3) performance from 88 subjects only during FST.

Mean absolute relative difference, by number of daily calibrations

Table 9 shows the sensor accuracy measured by the mean absolute relative difference (MARD). MARD represents the average relative difference (regardless if positive or negative) between the SG values and the paired BG values measured by YSI™*.

Table 9. SG MARD Versus YSI™* (within YSI™* glucose ranges).

YSI™* glucose ranges (mg/dL)	Abdomen Insertion Site				Arm Insertion Site			
	Calibration every 12 hours		Calibration 3 or 4 times a day		Calibration every 12 hours		Calibration 3 or 4 times a day	
	Number of paired SG-YSI™*	MARD (%)	Number of paired SG-YSI™*	MARD (%)	Number of paired SG-YSI™*	MARD (%)	Number of paired SG-YSI™*	MARD (%)
Overall	12090	10.55	11664	9.64	10526	9.09	10771	8.68
<40*	12	17.03	11	16.41	7	17.24	7	17.24
40–60*	353	7.96	324	7.53	335	6.44	349	6.42
61–80*	1445	9.44	1403	8.81	1345	7.76	1372	7.44
81–180	6505	9.94	6342	9.33	5644	8.64	5795	8.35
181–300	3277	10.00	3114	8.57	2766	8.58	2785	7.95
301–350	366	9.63	341	8.13	308	9.09	338	8.27
351–400	117	9.58	114	8.56	111	8.47	115	8.23
>400	15	10.85	15	10.92	10	10.71	10	11.44

* For YSI™* reference range ≤80 mg/dL, the differences in mg/dL are included instead of percent difference (%).

Note: SG Readings are within 40–400 mg/dL.

Percent agreement, by number of daily calibrations

In Table 10 through Table 17, the agreement of the SG values to paired YSI™* values was assessed by calculating the percentage of YSI™* values that were within 15%, 20%, 30%, 40% and greater than 40% of the paired SG values. For readings less than or equal to 80 mg/dL, the absolute difference in mg/dL between the SG and paired YSI™* values was calculated.

Results are shown for defined SG ranges when calibrating every 12 hours and calibrating three or four times a day for sensors.

Table 10. Overall agreement (%) of SG-YSI™ paired points within SG ranges on FST Days 1, 3, and 7; Calibration every 12 hours, Abdomen.

SG ranges (mg/dL)	Number of paired SG-YSI™	Percent of YSI™ within 15/15% of SG (%)	Percent of YSI™ within 20/20% of SG (%)	Percent of YSI™ within 30/30% of SG (%)	Percent of YSI™ within 40/40% of SG (%)	Percent of YSI™ greater than 40/40% of SG (%)
Overall	12090	76.6	85.7	94.3	97.3	2.7
≥40–60*	781	57.7	73.2	90.7	96.9	3.1
>60–80*	1350	76.1	83.4	93.4	96.8	3.2
>80–180	6769	76.5	85.3	93.5	96.5	3.5
>180–300	2833	80.8	90	97.1	98.9	1.1
>300–350	286	86.4	95.1	99.7	100	0
>350–400	71	93	100	100	100	0

* For reference range ≤80 mg/dL, agreement was based on 15/20/30/40 mg/dL.
Note: SG Readings are within 40–400 mg/dL.

Table 11. Agreement (%) of SG paired points within SG ranges on FST Day 1; Calibration every 12 hours, Abdomen.

SG ranges (mg/dL)	Number of paired SG-YSI™	Percent of YSI™ within 15/15% of SG (%)	Percent of YSI™ within 20/20% of SG (%)	Percent of YSI™ within 30/30% of SG (%)	Percent of YSI™ within 40/40% of SG (%)	Percent of YSI™ greater than 40/40% of SG (%)
Overall	4294	65.3	76.6	89.5	94.7	5.3
≥40–60*	278	46.8	61.9	83.5	94.2	5.8
>60–80*	474	61	71.7	88	93.5	6.5
>80–180	2443	64.9	75.4	87.6	93.2	6.8
>180–300	985	71.6	83.8	95.5	98.5	1.5
>300–350	90	82.2	95.6	100	100	0
>350–400	24	91.7	100	100	100	0

* For reference range ≤ 80 mg/dL, agreement was based on 15/20/30/40 mg/dL.
Note: The overall number of available paired SG-YSI™ points on FST Day 1 was from 88 subjects. SG Readings are within 40–400 mg/dL.

Table 12. Overall agreement (%) of SG-YSI™ paired points within SG ranges on FST Days 1, 3, and 7; Calibration 3 or 4 times a day, Abdomen.

SG ranges (mg/dL)	Number of paired SG-YSI™	Percent of YSI™ within 15/15% of SG (%)	Percent of YSI™ within 20/20% of SG (%)	Percent of YSI™ within 30/30% of SG (%)	Percent of YSI™ within 40/40% of SG (%)	Percent of YSI™ greater than 40/40% of SG (%)
Overall	11664	80.6	88.9	95.9	98.2	1.8
≥40–60*	686	60.2	75.1	92	98.1	1.9
>60–80*	1303	78.7	85.7	93.5	96.7	3.3
>80–180	6549	79.9	88.5	95.7	98	2
>180–300	2782	86.4	93.5	98	99.4	0.6
>300–350	279	92.5	97.8	99.6	100	0
>350–400	65	95.4	100	100	100	0

* For reference range ≤ 80 mg/dL, agreement was based on 15/20/30/40 mg/dL.
Note: SG Readings are within 40–400 mg/dL.

Table 13. Agreement (%) of SG paired points within SG ranges on FST Day 1; Calibration 3 or 4 times a day, Abdomen.

SG ranges (mg/dL)	Number of paired SG-YSI™*	Percent of YSI™* within 15/15% of SG (%)	Percent of YSI™* within 20/20% of SG (%)	Percent of YSI™* within 30/30% of SG (%)	Percent of YSI™* within 40/40% of SG (%)	Percent of YSI™* greater than 40/40% of SG (%)
Overall	4136	71.4	81.9	92.3	96.3	3.7
≥40–60*	247	50.2	64.4	84.6	95.5	4.5
>60–80*	429	66.2	73.9	86.5	92.8	7.2
>80–180	2353	70.6	81.4	91.8	95.5	4.5
>180–300	988	78.6	89.1	97.2	99.5	0.5
>300–350	97	88.7	96.9	100	100	0
>350–400	22	100	100	100	100	0

* For reference range ≤ 80 mg/dL, agreement was based on 15/20/30/40 mg/dL.
Note: The overall number of available paired SG-YSI™* points on FST Day 1 was from 88 subjects. SG Readings are within 40–400 mg/dL.

Table 14. Overall agreement (%) of SG-YSI™* paired points within SG ranges on FST Days 1, 3, and 7; Calibration every 12 hours, Arm.

SG ranges (mg/dL)	Number of paired SG-YSI™*	Percent of YSI™* within 15/15% of SG (%)	Percent of YSI™* within 20/20% of SG (%)	Percent of YSI™* within 30/30% of SG (%)	Percent of YSI™* within 40/40% of SG (%)	Percent of YSI™* greater than 40/40% of SG (%)
Overall	10526	82.5	90.3	96.3	98.7	1.3
≥40–60*	520	77.1	86.9	96	99.6	0.4
>60–80*	1238	88.2	92.5	96.4	99	1
>80–180	5957	80.3	88.5	95.5	98.2	1.8
>180–300	2495	85	93.2	98	99.4	0.6
>300–350	256	90.6	96.9	100	100	0
>350–400	60	90	93.3	100	100	0

* For reference range ≤ 80 mg/dL, agreement was based on 15/20/30/40 mg/dL.
Note: SG Readings are within 40–400 mg/dL.

Table 15. Agreement (%) of SG-YSI™* paired points within SG ranges on FST Day 1; Calibration every 12 hours, Arm.

SG ranges (mg/dL)	Number of paired SG-YSI™*	Percent of YSI™* within 15/15% of SG (%)	Percent of YSI™* within 20/20% of SG (%)	Percent of YSI™* within 30/30% of SG (%)	Percent of YSI™* within 40/40% of SG (%)	Percent of YSI™* greater than 40/40% of SG (%)
Overall	3390	74.7	84.2	93.2	97.8	2.2
≥40–60*	168	60.1	73.2	90.5	98.8	1.2
>60–80*	339	75.5	79.4	88.8	97.3	2.7
>80–180	2017	73.2	83.1	92	97	3
>180–300	760	80.5	90.8	98.2	99.6	0.4
>300–350	91	84.6	93.4	100	100	0
>350–400	15	60	73.3	100	100	0

* For reference range ≤ 80 mg/dL, agreement was based on 15/20/30/40 mg/dL.
Note: The overall number of available paired SG-YSI™* points on FST Day 1 was from 82 subjects. SG Readings are within 40–400 mg/dL.

Table 16. Overall agreement (%) of SG-YSI™* paired points within SG ranges on FST Days 1, 3, and 7; Calibration 3 or 4 times a day, Arm.

SG ranges (mg/dL)	Number of paired SG-YSI™*	Percent of YSI™* within 15/15% of SG (%)	Percent of YSI™* within 20/20% of SG (%)	Percent of YSI™* within 30/30% of SG (%)	Percent of YSI™* within 40/40% of SG (%)	Percent of YSI™* greater than 40/40% of SG (%)
Overall	10771	84.3	91.6	97.3	99.1	0.9
≥40–60*	503	77.1	87.5	96.6	99.6	0.4
>60–80*	1291	89.3	93.4	97.7	99.1	0.9
>80–180	6076	82	90	96.7	98.7	1.3
>180–300	2569	87	94.4	98.3	99.7	0.3
>300–350	271	94.8	98.5	100	100	0
>350–400	61	95.1	96.7	100	100	0

* For reference range ≤ 80 mg/dL, agreement was based on 15/20/30/40 mg/dL.
Note: SG Readings are within 40–400 mg/dL.

Table 17. Agreement (%) of SG-YSI™* paired points within SG ranges on FST Day 1; Calibration 3 or 4 times a day, Arm.

SG ranges (mg/dL)	Number of paired SG-YSI™*	Percent of YSI™* within 15/15% of SG (%)	Percent of YSI™* within 20/20% of SG (%)	Percent of YSI™* within 30/30% of SG (%)	Percent of YSI™* within 40/40% of SG (%)	Percent of YSI™* greater than 40/40% of SG (%)
Overall	3591	76.8	86	95	98.5	1.5
≥40–60*	162	62.3	75.3	91.4	98.8	1.2
>60–80*	346	76.3	81.5	92.8	97.4	2.6
>80–180	2108	75.1	85	94.2	98	2
>180–300	869	81.8	91	97.7	99.9	0.1
>300–350	93	92.5	96.8	100	100	0
>350–400	13	84.6	84.6	100	100	0

* For reference range ≤ 80 mg/dL, agreement was based on 15/20/30/40 mg/dL.
Note: The overall number of available paired SG-YSI™* points on FST Day 1 was from 83 subjects. SG Readings are within 40–400 mg/dL.

Agreement when the CGM system reads “Below 40 mg/dL” or “Above 400 mg/dL”

The real-time CGM systems display glucose values between 40 mg/dL and 400 mg/dL. It displays “Below 40 mg/dL” when the SG value detected is below 40 mg/dL. It displays “Above 400 mg/dL” when the SG value detected is above 400 mg/dL. Tables B-10, B-11, B-12, and B-13 illustrate the number and percentage of the paired YSI™* values in different BG levels when the CGM system displays “Below 40 mg/dL” (LOW) or “Above 400 mg/dL” (HIGH).

Table 18. The number and percentage of YSI™* values collected when CGM displays “Below 40 mg/dL” (LOW); Calibration every 12 hours.

CGM Display	Insertion Site	CGM-YSI™* pairs	YSI™* (mg/dL)					Total
			<55	<60	<70	<80	>80	
LOW	Abdomen	Cumulative, n	42	77	139	150	4	154
		Cumulative %	27%	50%	90%	97%	3%	100%
	Arm	Cumulative, n	17	35	67	74	1	75
		Cumulative %	23%	47%	89%	99%	1%	100%

Table 19. The number and percentage of YSI™* values collected when CGM displays “Below 40 mg/dL” (LOW); Calibration 3 or 4 times a day.

CGM Display	Insertion Site	CGM-YSI™* pairs	YSI™* (mg/dL)					Total
			<55	<60	<70	<80	>80	
LOW	Abdomen	Cumulative, n	33	64	108	119	4	123
		Cumulative %	27%	52%	88%	97%	3%	100%
	Arm	Cumulative, n	18	35	66	72	1	73
		Cumulative %	25%	48%	90%	99%	1%	100%

Table 20. The number and percentage of YSI™* values collected when CGM displays “Above 400 mg/dL” (HIGH); Calibration every 12 hours.

CGM Display	Insertion Site	CGM-YSI™* pairs	YSI™* (mg/dL)					Total
			<340	<320	<280	<240	>240	
HIGH	Abdomen	Cumulative, n	8	9	9	9	0	9
		Cumulative %	89%	100%	100%	100%	0%	100%
	Arm	Cumulative, n	8	8	9	9	0	9
		Cumulative %	89%	89%	100%	100%	0%	100%

Table 21. The number and percentage of YSI™* values collected when CGM displays “Above 400 mg/dL” (HIGH); Calibration 3 or 4 times a day.

CGM Display	Insertion Site	CGM-YSI™* pairs	YSI™* (mg/dL)					Total
			<340	<320	<280	<240	>240	
HIGH	Abdomen	Cumulative, n	8	9	9	9	0	9
		Cumulative %	89%	100%	100%	100%	0%	100%
	Arm	Cumulative, n	8	8	8	8	0	8
		Cumulative %	100%	100%	100%	100%	0%	100%

Concurrence of SG and YSI™* values

Table 22 through Table 29 show, for each SG range, the percentage of concurring data points where the paired YSI™* values were in different BG ranges.

Table 22. Overall concurrence of YSI™* values and SG readings using SG ranges on FST Days 1, 3, and 7; Calibration every 12 hours, Abdomen.

Percent of matched pairs in each YSI™* glucose range for each SG range (mg/dL)												
SG ranges (mg/dL)	Number of paired SG-YSI™*	YSI™* Glucose Range (mg/dL)										
		<40	≥40-60	>60-80	>80-120	>120-160	>160-200	>200-250	>250-300	>300-350	>350-400	>400
A) <40	154	0.0% (0/154)	50.0% (77/154)	47.4% (73/154)	2.6% (4/154)	0.0%(0/154)	0.0% (0/154)	0.0% (0/154)	0.0% (0/154)	0.0% (0/154)	0.0% (0/154)	0.0% (0/154)
B) ≥40-60	781	1.2% (9/781)	30.7% (240/781)	57.2% (447/781)	10.6% (83/781)	0.3% (2/781)	0.0% (0/781)	0.0% (0/781)	0.0% (0/781)	0.0% (0/781)	0.0% (0/781)	0.0% (0/781)
C) >60-80	1350	0.2% (3/1350)	8.3% (112/1350)	60.1% (811/1350)	29.2% (394/1350)	2.1% (28/1350)	0.1% (2/1350)	0.0% (0/1350)	0.0% (0/1350)	0.0% (0/1350)	0.0% (0/1350)	0.0% (0/1350)
D) >80-120	2953	0.0% (0/2953)	0.0% (1/2953)	6.3% (185/2953)	73.0% (2157/2953)	18.2% (537/2953)	2.0% (60/2953)	0.4% (13/2953)	0.0% (0/2953)	0.0% (0/2953)	0.0% (0/2953)	0.0% (0/2953)
E) >120-160	2784	0.0% (0/2784)	0.0% (0/2784)	0.1% (2/2784)	8.8% (245/2784)	67.7% (1885/2784)	20.3% (565/2784)	2.8% (79/2784)	0.3% (8/2784)	0.0% (0/2784)	0.0% (0/2784)	0.0% (0/2784)
F) >160-200	1875	0.0% (0/1875)	0.0% (0/1875)	0.0% (0/1875)	0.1% (2/1875)	10.0% (188/1875)	60.2% (1128/1875)	28.2% (529/1875)	1.5% (28/1875)	0.0% (0/1875)	0.0% (0/1875)	0.0% (0/1875)
G) >200-250	1382	0.0% (0/1382)	0.0% (0/1382)	0.0% (0/1382)	0.0% (0/1382)	0.3% (4/1382)	8.0% (111/1382)	61.1% (844/1382)	28.1% (389/1382)	2.3% (32/1382)	0.1% (2/1382)	0.0% (0/1382)
H) >250-300	608	0.0% (0/608)	0.0% (0/608)	0.0% (0/608)	0.0% (0/608)	0.0%(0/608)	0.3% (2/608)	10.9% (66/608)	61.2% (372/608)	25.5% (155/608)	2.1% (13/608)	0.0% (0/608)
I) >300-350	286	0.0% (0/286)	0.0% (0/286)	0.0% (0/286)	0.0% (0/286)	0.0%(0/286)	0.0% (0/286)	1.0% (3/286)	19.9% (57/286)	55.2% (158/286)	22.4% (64/286)	1.4% (4/286)
J) >350-400	71	0.0% (0/71)	0.0% (0/71)	0.0% (0/71)	0.0% (0/71)	0.0%(0/71)	0.0% (0/71)	0.0% (0/71)	1.4% (1/71)	29.6% (21/71)	53.5% (38/71)	15.5% (11/71)
K) >400	9	0.0% (0/9)	0.0% (0/9)	0.0% (0/9)	0.0% (0/9)	0.0%(0/9)	0.0% (0/9)	0.0% (0/9)	0.0% (0/9)	11.1% (1/9)	77.8% (7/9)	11.1% (1/9)

Table 23. Concurrence of YSI™* values and SG readings using SG ranges on FST Day 1; Calibration every 12 hours, Abdomen

Percent of matched pairs in each YSI™* glucose range for each SG range (mg/dL)												
SG ranges (mg/dL)	Number of paired SG-YSI™*	YSI™* Glucose Range (mg/dL)										
		<40	≥40-60	>60-80	>80-120	>120-160	>160-200	>200-250	>250-300	>300-350	>350-400	>400
A) <40	71	0.0% (0/71)	38.0% (27/71)	57.7% (41/71)	4.2% (3/71)	0.0% (0/71)	0.0% (0/71)	0.0% (0/71)	0.0% (0/71)	0.0% (0/71)	0.0% (0/71)	0.0% (0/71)

Table 23. Concurrence of YSI™* values and SG readings using SG ranges on FST Day 1; Calibration every 12 hours, Abdomen (continued)

Percent of matched pairs in each YSI™* glucose range for each SG range (mg/dL)												
SG ranges (mg/dL)	Number of paired SG-YSI™*	YSI™* Glucose Range (mg/dL)										
		<40	≥40-60	>60-80	>80-120	>120-160	>160-200	>200-250	>250-300	>300-350	>350-400	>400
B) ≥40-60	278	2.2% (6/278)	23.0% (64/278)	55.8% (155/278)	18.7% (52/278)	0.4% (1/278)	0.0% (0/278)	0.0% (0/278)	0.0% (0/278)	0.0% (0/278)	0.0% (0/278)	0.0% (0/278)
C) >60-80	474	0.4% (2/474)	12.0% (57/474)	47.7% (226/474)	34.8% (165/474)	4.6% (22/474)	0.4% (2/474)	0.0% (0/474)	0.0% (0/474)	0.0% (0/474)	0.0% (0/474)	0.0% (0/474)
D) >80-120	1071	0.0% (0/1071)	0.1% (1/1071)	4.6% (49/1071)	66.6% (713/1071)	23.4% (251/1071)	4.5% (48/1071)	0.8% (9/1071)	0.0% (0/1071)	0.0% (0/1071)	0.0% (0/1071)	0.0% (0/1071)
E) >120-160	978	0.0% (0/978)	0.0% (0/978)	0.1% (1/978)	8.3% (81/978)	58.4% (571/978)	26.8% (262/978)	5.9% (58/978)	0.5% (5/978)	0.0% (0/978)	0.0% (0/978)	0.0% (0/978)
F) >160-200	662	0.0% (0/662)	0.0% (0/662)	0.0% (0/662)	0.3% (2/662)	9.1% (60/662)	52.6% (348/662)	35.3% (234/662)	2.7% (18/662)	0.0% (0/662)	0.0% (0/662)	0.0% (0/662)
G) >200-250	515	0.0% (0/515)	0.0% (0/515)	0.0% (0/515)	0.0% (0/515)	0.0% (0/515)	6.2% (32/515)	56.3% (290/515)	33.8% (174/515)	3.3% (17/515)	0.4% (2/515)	0.0% (0/515)
H) >250-300	202	0.0% (0/202)	0.0% (0/202)	0.0% (0/202)	0.0% (0/202)	0.0% (0/202)	0.0% (0/202)	9.4% (19/202)	55.0% (111/202)	32.2% (65/202)	3.5% (7/202)	0.0% (0/202)
I) >300-350	90	0.0% (0/90)	0.0% (0/90)	0.0% (0/90)	0.0% (0/90)	0.0% (0/90)	0.0% (0/90)	0.0% (0/90)	20.0% (18/90)	54.4% (49/90)	23.3% (21/90)	2.2% (2/90)
J) >350-400	24	0.0% (0/24)	0.0% (0/24)	0.0% (0/24)	0.0% (0/24)	0.0% (0/24)	0.0% (0/24)	0.0% (0/24)	4.2% (1/24)	37.5% (9/24)	50.0% (12/24)	8.3% (2/24)
K) >400	1	0.0% (0/1)	0.0% (0/1)	0.0% (0/1)	0.0% (0/1)	0.0% (0/1)	0.0% (0/1)	0.0% (0/1)	0.0% (0/1)	0.0% (0/1)	0.0% (0/1)	100.0% (1/1)

Note: The overall number of available paired SG-YSI™* points on FST Day 1 was from 88 subjects.

Table 24. Overall concurrence of YSI™* values and SG readings using SG ranges on FST Days 1, 3, and 7; Calibration 3 or 4 times a day, Abdomen.

Percent of matched pairs in each YSI™* glucose range for each SG range (mg/dL)												
SG ranges (mg/dL)	Number of paired SG-YSI™*	YSI™* Glucose Range (mg/dL)										
		<40	≥40-60	>60-80	>80-120	>120-160	>160-200	>200-250	>250-300	>300-350	>350-400	>400
A) <40	123	0.0% (0/123)	52.0% (64/123)	44.7% (55/123)	3.3% (4/123)	0.0% (0/123)	0.0% (0/123)	0.0% (0/123)	0.0% (0/123)	0.0% (0/123)	0.0% (0/123)	0.0% (0/123)

Table 24. Overall concurrence of YSI™* values and SG readings using SG ranges on FST Days 1, 3, and 7; Calibration 3 or 4 times a day, Abdomen. (continued)

Percent of matched pairs in each YSI™* glucose range for each SG range (mg/dL)												
SG ranges (mg/dL)	Number of paired SG-YSI™*	YSI™* Glucose Range (mg/dL)										
		<40	≥40-60	>60-80	>80-120	>120-160	>160-200	>200-250	>250-300	>300-350	>350-400	>400
B) ≥40-60	686	1.3% (9/686)	31.6% (217/686)	57.0% (391/686)	9.9% (68/686)	0.1% (1/686)	0.0% (0/686)	0.0% (0/686)	0.0% (0/686)	0.0% (0/686)	0.0% (0/686)	0.0% (0/686)
C) >60-80	1303	0.2% (2/1303)	8.1% (106/1303)	63.4% (826/1303)	26.2% (342/1303)	1.9% (25/1303)	0.2% (2/1303)	0.0% (0/1303)	0.0% (0/1303)	0.0% (0/1303)	0.0% (0/1303)	0.0% (0/1303)
D) >80-120	2864	0.0% (0/2864)	0.0% (1/2864)	6.5% (186/2864)	74.5% (2133/2864)	17.5% (502/2864)	1.3% (36/2864)	0.2% (6/2864)	0.0% (0/2864)	0.0% (0/2864)	0.0% (0/2864)	0.0% (0/2864)
E) >120-160	2681	0.0% (0/2681)	0.0% (0/2681)	0.0% (0/2681)	9.0% (241/2681)	69.9% (1874/2681)	19.1% (512/2681)	1.8% (49/2681)	0.2% (5/2681)	0.0% (0/2681)	0.0% (0/2681)	0.0% (0/2681)
F) >160-200	1820	0.0% (0/1820)	0.0% (0/1820)	0.0% (0/1820)	0.1% (2/1820)	10.3% (188/1820)	63.6% (1157/1820)	24.9% (454/1820)	1.0% (19/1820)	0.0% (0/1820)	0.0% (0/1820)	0.0% (0/1820)
G) >200-250	1314	0.0% (0/1314)	0.0% (0/1314)	0.0% (0/1314)	0.0% (0/1314)	0.5% (7/1314)	8.5% (112/1314)	65.3% (858/1314)	24.6% (323/1314)	1.1% (14/1314)	0.0% (0/1314)	0.0% (0/1314)
H) >250-300	652	0.0% (0/652)	0.0% (0/652)	0.0% (0/652)	0.0% (0/652)	0.0% (0/652)	0.3% (2/652)	11.3% (74/652)	63.5% (414/652)	22.9% (149/652)	2.0% (13/652)	0.0% (0/652)
I) >300-350	279	0.0% (0/279)	0.0% (0/279)	0.0% (0/279)	0.0% (0/279)	0.0% (0/279)	0.0% (0/279)	0.0% (0/279)	17.9% (50/279)	59.5% (166/279)	21.1% (59/279)	1.4% (4/279)
J) >350-400	65	0.0% (0/65)	0.0% (0/65)	0.0% (0/65)	0.0% (0/65)	0.0% (0/65)	0.0% (0/65)	0.0% (0/65)	0.0% (0/65)	18.5% (12/65)	64.6% (42/65)	16.9% (11/65)
K) >400	9	0.0% (0/9)	0.0% (0/9)	0.0% (0/9)	0.0% (0/9)	0.0% (0/9)	0.0% (0/9)	0.0% (0/9)	0.0% (0/9)	11.1% (1/9)	77.8% (7/9)	11.1% (1/9)

Table 25. Concurrence of YSI™* values and SG readings using SG ranges on FST Day 1; Calibration 3 or 4 times a day, Abdomen.

Percent of matched pairs in each YSI™* glucose range for each SG range (mg/dL)												
SG ranges (mg/dL)	Number of paired SG-YSI™*	YSI™* Glucose Range (mg/dL)										
		<40	≥40-60	>60-80	>80-120	>120-160	>160-200	>200-250	>250-300	>300-350	>350-400	>400
A) <40	62	0.0% (0/62)	37.1% (23/62)	58.1% (36/62)	4.8% (3/62)	0.0% (0/62)	0.0% (0/62)	0.0% (0/62)	0.0% (0/62)	0.0% (0/62)	0.0% (0/62)	0.0% (0/62)
B) ≥40-60	247	2.4% (6/247)	21.5% (53/247)	58.7% (145/247)	17.0% (42/247)	0.4% (1/247)	0.0% (0/247)	0.0% (0/247)	0.0% (0/247)	0.0% (0/247)	0.0% (0/247)	0.0% (0/247)

Table 25. Concurrence of YSI™* values and SG readings using SG ranges on FST Day 1; Calibration 3 or 4 times a day, Abdomen. (continued)

Percent of matched pairs in each YSI™* glucose range for each SG range (mg/dL)												
SG ranges (mg/dL)	Number of paired SG-YSI™*	YSI™* Glucose Range (mg/dL)										
		<40	≥40-60	>60-80	>80-120	>120-160	>160-200	>200-250	>250-300	>300-350	>350-400	>400
C) >60-80	429	0.2% (1/429)	12.6% (54/429)	52.0% (223/429)	30.3% (130/429)	4.4% (19/429)	0.5% (2/429)	0.0% (0/429)	0.0% (0/429)	0.0% (0/429)	0.0% (0/429)	0.0% (0/429)
D) >80-120	1014	0.0% (0/1014)	0.1% (1/1014)	5.3% (54/1014)	70.7% (717/1014)	20.4% (207/1014)	3.1% (31/1014)	0.4% (4/1014)	0.0% (0/1014)	0.0% (0/1014)	0.0% (0/1014)	0.0% (0/1014)
E) >120-160	973	0.0% (0/973)	0.0% (0/973)	0.0% (0/973)	9.1% (89/973)	61.6% (599/973)	24.8% (241/973)	4.0% (39/973)	0.5% (5/973)	0.0% (0/973)	0.0% (0/973)	0.0% (0/973)
F) >160-200	633	0.0% (0/633)	0.0% (0/633)	0.0% (0/633)	0.3% (2/633)	10.7% (68/633)	56.7% (359/633)	30.3% (192/633)	1.9% (12/633)	0.0% (0/633)	0.0% (0/633)	0.0% (0/633)
G) >200-250	497	0.0% (0/497)	0.0% (0/497)	0.0% (0/497)	0.0%(0/497)	0.2% (1/497)	7.8% (39/497)	64.6% (321/497)	26.4% (131/497)	1.0% (5/497)	0.0% (0/497)	0.0% (0/497)
H) >250-300	224	0.0% (0/224)	0.0% (0/224)	0.0% (0/224)	0.0%(0/224)	0.0%(0/224)	0.0% (0/224)	12.9% (29/224)	58.0% (130/224)	23.7% (53/224)	5.4% (12/224)	0.0% (0/224)
I) >300-350	97	0.0% (0/97)	0.0% (0/97)	0.0% (0/97)	0.0%(0/97)	0.0%(0/97)	0.0% (0/97)	0.0% (0/97)	19.6% (19/97)	59.8% (58/97)	18.6% (18/97)	2.1% (2/97)
J) >350-400	22	0.0% (0/22)	0.0% (0/22)	0.0% (0/22)	0.0%(0/22)	0.0%(0/22)	0.0% (0/22)	0.0% (0/22)	0.0% (0/22)	27.3% (6/22)	63.6% (14/22)	9.1% (2/22)
K) >400	1	0.0% (0/1)	0.0% (0/1)	0.0% (0/1)	0.0%(0/1)	0.0%(0/1)	0.0% (0/1)	0.0% (0/1)	0.0% (0/1)	0.0% (0/1)	0.0% (0/1)	100.0% (1/1)

Note: The overall number of available SG-YSI™* points on FST Day 1 was from 88 subjects.

Table 26. Overall concurrence of YSI™* values and SG readings using SG ranges on FST Days 1, 3, and 7; Calibration every 12 hours, Arm.

Percent of matched pairs in each YSI™* glucose range for each SG range (mg/dL)												
SG ranges (mg/dL)	Number of paired SG-YSI™*	YSI™* Glucose Range (mg/dL)										
		<40	≥40-60	>60-80	>80-120	>120-160	>160-200	>200-250	>250-300	>300-350	>350-400	>400
A) <40	75	2.7% (2/75)	44.0% (33/75)	52.0% (39/75)	1.3% (1/75)	0.0%(0/75)	0.0% (0/75)	0.0% (0/75)	0.0% (0/75)	0.0% (0/75)	0.0% (0/75)	0.0% (0/75)
B) ≥40-60	520	1.0% (5/520)	41.9% (218/520)	51.7% (269/520)	5.4% (28/520)	0.0%(0/520)	0.0% (0/520)	0.0% (0/520)	0.0% (0/520)	0.0% (0/520)	0.0% (0/520)	0.0% (0/520)

Table 26. Overall concurrence of YSI™* values and SG readings using SG ranges on FST Days 1, 3, and 7; Calibration every 12 hours, Arm. (continued)

Percent of matched pairs in each YSI™* glucose range for each SG range (mg/dL)												
SG ranges (mg/dL)	Number of paired SG-YSI™*	YSI™* Glucose Range (mg/dL)										
		<40	≥40–60	>60–80	>80–120	>120–160	>160–200	>200–250	>250–300	>300–350	>350–400	>400
C) >60–80	1238	0.2% (2/1238)	9.2% (114/1238)	70.3% (870/1238)	20.0% (247/1238)	0.4% (5/1238)	0.0% (0/1238)	0.0% (0/1238)	0.0% (0/1238)	0.0% (0/1238)	0.0% (0/1238)	0.0% (0/1238)
D) >80–120	2722	0.0% (0/2722)	0.1% (3/2722)	7.5% (203/2722)	74.0% (2014/2722)	17.7% (481/2722)	0.8% (21/2722)	0.0% (0/2722)	0.0% (0/2722)	0.0% (0/2722)	0.0% (0/2722)	0.0% (0/2722)
E) >120–160	2348	0.0% (0/2348)	0.0% (0/2348)	0.1% (3/2348)	9.2% (215/2348)	70.4% (1652/2348)	18.0% (423/2348)	2.3% (54/2348)	0.0% (1/2348)	0.0% (0/2348)	0.0% (0/2348)	0.0% (0/2348)
F) >160–200	1614	0.0% (0/1614)	0.0% (0/1614)	0.0% (0/1614)	0.1% (2/1614)	9.4% (151/1614)	64.7% (1044/1614)	24.8% (400/1614)	0.9% (14/1614)	0.2% (3/1614)	0.0% (0/1614)	0.0% (0/1614)
G) >200–250	1212	0.0% (0/1212)	0.0% (0/1212)	0.0% (0/1212)	0.0%(0/1212)	0.6% (7/1212)	6.8% (83/1212)	63.9% (774/1212)	27.3% (331/1212)	1.4% (17/1212)	0.0% (0/1212)	0.0% (0/1212)
H) >250–300	556	0.0% (0/556)	0.0% (0/556)	0.0% (0/556)	0.0%(0/556)	0.0%(0/556)	0.2% (1/556)	9.4% (52/556)	65.1% (362/556)	23.9% (133/556)	1.4% (8/556)	0.0% (0/556)
I) >300–350	256	0.0% (0/256)	0.0% (0/256)	0.0% (0/256)	0.0%(0/256)	0.0%(0/256)	0.0% (0/256)	0.0% (0/256)	18.0% (46/256)	56.6% (145/256)	24.6% (63/256)	0.8% (2/256)
J) >350–400	60	0.0% (0/60)	0.0% (0/60)	0.0% (0/60)	0.0%(0/60)	0.0%(0/60)	0.0% (0/60)	0.0% (0/60)	3.3% (2/60)	16.7% (10/60)	66.7% (40/60)	13.3% (8/60)
K) >400	9	0.0% (0/9)	0.0% (0/9)	0.0% (0/9)	0.0%(0/9)	0.0%(0/9)	0.0% (0/9)	0.0% (0/9)	0.0% (0/9)	11.1% (1/9)	55.6% (5/9)	33.3% (3/9)

Table 27. Concurrence of YSI™* values and SG readings using SG ranges on FST Day 1; Calibration every 12 hours, Arm.

Percent of matched pairs in each YSI™* glucose range for each SG range (mg/dL)												
SG ranges (mg/dL)	Number of paired SG-YSI™*	YSI™* Glucose Range (mg/dL)										
		<40	≥40–60	>60–80	>80–120	>120–160	>160–200	>200–250	>250–300	>300–350	>350–400	>400
A) <40	54	3.7% (2/54)	29.6% (16/54)	64.8% (35/54)	1.9%(1/54)	0.0%(0/54)	0.0% (0/54)	0.0% (0/54)	0.0% (0/54)	0.0% (0/54)	0.0% (0/54)	0.0% (0/54)
B) ≥40–60	168	1.8% (3/168)	22.0% (37/168)	64.3% (108/168)	11.9% (20/168)	0.0%(0/168)	0.0% (0/168)	0.0% (0/168)	0.0% (0/168)	0.0% (0/168)	0.0% (0/168)	0.0% (0/168)
C) >60–80	339	0.6% (2/339)	11.2% (38/339)	58.1% (197/339)	29.2% (99/339)	0.9% (3/339)	0.0% (0/339)	0.0% (0/339)	0.0% (0/339)	0.0% (0/339)	0.0% (0/339)	0.0% (0/339)

Table 27. Concurrence of YSI™* values and SG readings using SG ranges on FST Day 1; Calibration every 12 hours, Arm. (continued)

Percent of matched pairs in each YSI™* glucose range for each SG range (mg/dL)												
SG ranges (mg/dL)	Number of paired SG-YSI™*	YSI™* Glucose Range (mg/dL)										
		<40	≥40-60	>60-80	>80-120	>120-160	>160-200	>200-250	>250-300	>300-350	>350-400	>400
D) >80-120	895	0.0% (0/895)	0.3% (3/895)	6.6% (59/895)	69.8% (625/895)	21.6% (193/895)	1.7% (15/895)	0.0% (0/895)	0.0% (0/895)	0.0% (0/895)	0.0% (0/895)	0.0% (0/895)
E) >120-160	803	0.0% (0/803)	0.0% (0/803)	0.0% (0/803)	10.0% (80/803)	64.6% (519/803)	21.4% (172/803)	4.0% (32/803)	0.0% (0/803)	0.0% (0/803)	0.0% (0/803)	0.0% (0/803)
F) >160-200	549	0.0% (0/549)	0.0% (0/549)	0.0% (0/549)	0.2% (1/549)	8.9% (49/549)	61.4% (337/549)	28.1% (154/549)	1.5% (8/549)	0.0% (0/549)	0.0% (0/549)	0.0% (0/549)
G) >200-250	355	0.0% (0/355)	0.0% (0/355)	0.0% (0/355)	0.0%(0/355)	0.3% (1/355)	7.9% (28/355)	63.9% (227/355)	27.0% (96/355)	0.8% (3/355)	0.0% (0/355)	0.0% (0/355)
H) >250-300	175	0.0% (0/175)	0.0% (0/175)	0.0% (0/175)	0.0%(0/175)	0.0%(0/175)	0.0% (0/175)	10.9% (19/175)	65.7% (115/175)	21.1% (37/175)	2.3% (4/175)	0.0% (0/175)
I) >300-350	91	0.0% (0/91)	0.0% (0/91)	0.0% (0/91)	0.0%(0/91)	0.0%(0/91)	0.0% (0/91)	0.0% (0/91)	20.9% (19/91)	52.7% (48/91)	24.2% (22/91)	2.2% (2/91)
J) >350-400	15	0.0% (0/15)	0.0% (0/15)	0.0% (0/15)	0.0%(0/15)	0.0%(0/15)	0.0% (0/15)	0.0% (0/15)	13.3% (2/15)	33.3% (5/15)	53.3% (8/15)	0.0% (0/15)
K) >400	1	0.0% (0/1)	0.0% (0/1)	0.0% (0/1)	0.0%(0/1)	0.0%(0/1)	0.0% (0/1)	0.0% (0/1)	0.0% (0/1)	100.0% (1/1)	0.0% (0/1)	0.0% (0/1)

Note: The overall number of available paired SG-YSI™* points on FST Day 1 was from 82 subjects.

Table 28. Overall concurrence of YSI™* values and SG readings using SG ranges on FST Days 1, 3, and 7; Calibration 3 or 4 times a day, Arm.

Percent of matched pairs in each YSI™* glucose range for each SG range (mg/dL)												
SG ranges (mg/dL)	Number of paired SG-YSI™*	YSI™* Glucose Range (mg/dL)										
		<40	≥40-60	>60-80	>80-120	>120-160	>160-200	>200-250	>250-300	>300-350	>350-400	>400
A) <40	73	2.7% (2/73)	45.2% (33/73)	50.7% (37/73)	1.4% (1/73)	0.0%(0/73)	0.0% (0/73)	0.0% (0/73)	0.0% (0/73)	0.0% (0/73)	0.0% (0/73)	0.0% (0/73)
B) ≥40-60	503	1.0% (5/503)	45.9% (231/503)	48.3% (243/503)	4.8% (24/503)	0.0%(0/503)	0.0% (0/503)	0.0% (0/503)	0.0% (0/503)	0.0% (0/503)	0.0% (0/503)	0.0% (0/503)
C) >60-80	1291	0.2% (2/1291)	8.9% (115/1291)	72.3% (933/1291)	18.4% (237/1291)	0.3% (4/1291)	0.0% (0/1291)	0.0% (0/1291)	0.0% (0/1291)	0.0% (0/1291)	0.0% (0/1291)	0.0% (0/1291)

Table 28. Overall concurrence of YSI™* values and SG readings using SG ranges on FST Days 1, 3, and 7; Calibration 3 or 4 times a day, Arm. (continued)

Percent of matched pairs in each YSI™* glucose range for each SG range (mg/dL)												
SG ranges (mg/dL)	Number of paired SG-YSI™*	YSI™* Glucose Range (mg/dL)										
		<40	≥40-60	>60-80	>80-120	>120-160	>160-200	>200-250	>250-300	>300-350	>350-400	>400
D) >80-120	2756	0.0% (0/2756)	0.1% (3/2756)	7.0% (194/2756)	75.9% (2092/2756)	16.5% (456/2756)	0.4% (11/2756)	0.0% (0/2756)	0.0% (0/2756)	0.0% (0/2756)	0.0% (0/2756)	0.0% (0/2756)
E) >120-160	2442	0.0% (0/2442)	0.0% (0/2442)	0.1% (2/2442)	9.3% (228/2442)	71.4% (1743/2442)	18.0% (439/2442)	1.2% (30/2442)	0.0% (0/2442)	0.0% (0/2442)	0.0% (0/2442)	0.0% (0/2442)
F) >160-200	1588	0.0% (0/1588)	0.0% (0/1588)	0.0% (0/1588)	0.1% (2/1588)	9.4% (150/1588)	66.3% (1053/1588)	23.5% (373/1588)	0.6% (9/1588)	0.1% (1/1588)	0.0% (0/1588)	0.0% (0/1588)
G) >200-250	1246	0.0% (0/1246)	0.0% (0/1246)	0.0% (0/1246)	0.0% (0/1246)	0.5% (6/1246)	7.4% (92/1246)	65.7% (818/1246)	25.1% (313/1246)	1.4% (17/1246)	0.0% (0/1246)	0.0% (0/1246)
H) >250-300	613	0.0% (0/613)	0.0% (0/613)	0.0% (0/613)	0.0% (0/613)	0.0% (0/613)	0.2% (1/613)	8.6% (53/613)	65.1% (399/613)	24.6% (151/613)	1.5% (9/613)	0.0% (0/613)
I) >300-350	271	0.0% (0/271)	0.0% (0/271)	0.0% (0/271)	0.0% (0/271)	0.0% (0/271)	0.0% (0/271)	0.0% (0/271)	16.2% (44/271)	59.8% (162/271)	23.2% (63/271)	0.7% (2/271)
J) >350-400	61	0.0% (0/61)	0.0% (0/61)	0.0% (0/61)	0.0% (0/61)	0.0% (0/61)	0.0% (0/61)	0.0% (0/61)	4.9% (3/61)	11.5% (7/61)	70.5% (43/61)	13.1% (8/61)
K) >400	8	0.0% (0/8)	0.0% (0/8)	0.0% (0/8)	0.0% (0/8)	0.0% (0/8)	0.0% (0/8)	0.0% (0/8)	0.0% (0/8)	0.0% (0/8)	62.5% (5/8)	37.5% (3/8)

Table 29. Concurrence of YSI™* values and SG readings using SG ranges on FST) Day 1; Calibration 3 or 4 times a day, Arm.

Percent of matched pairs in each YSI™* glucose range for each SG range (mg/dL)												
SG ranges (mg/dL)	Number of paired SG-YSI™*	YSI™* Glucose Range (mg/dL)										
		<40	≥40-60	>60-80	>80-120	>120-160	>160-200	>200-250	>250-300	>300-350	>350-400	>400
A) <40	54	3.7% (2/54)	29.6% (16/54)	64.8% (35/54)	1.9% (1/54)	0.0% (0/54)	0.0% (0/54)	0.0% (0/54)	0.0% (0/54)	0.0% (0/54)	0.0% (0/54)	0.0% (0/54)
B) ≥40-60	162	1.9% (3/162)	25.3% (41/162)	61.7% (100/162)	11.1% (18/162)	0.0% (0/162)	0.0% (0/162)	0.0% (0/162)	0.0% (0/162)	0.0% (0/162)	0.0% (0/162)	0.0% (0/162)
C) >60-80	346	0.6% (2/346)	11.6% (40/346)	61.3% (212/346)	25.7% (89/346)	0.9% (3/346)	0.0% (0/346)	0.0% (0/346)	0.0% (0/346)	0.0% (0/346)	0.0% (0/346)	0.0% (0/346)
D) >80-120	899	0.0% (0/899)	0.3% (3/899)	6.3% (57/899)	74.0% (665/899)	18.2% (164/899)	1.1% (10/899)	0.0% (0/899)	0.0% (0/899)	0.0% (0/899)	0.0% (0/899)	0.0% (0/899)

Table 29. Concurrence of YSI™* values and SG readings using SG ranges on FST) Day 1; Calibration 3 or 4 times a day, Arm. (continued)

Percent of matched pairs in each YSI™* glucose range for each SG range (mg/dL)												
SG ranges (mg/dL)	Number of paired SG-YSI™*	YSI™* Glucose Range (mg/dL)										
		<40	≥40–60	>60–80	>80–120	>120–160	>160–200	>200–250	>250–300	>300–350	>350–400	>400
E) >120–160	878	0.0% (0/878)	0.0% (0/878)	0.0% (0/878)	10.0% (88/878)	67.0% (588/878)	21.0% (184/878)	2.1% (18/878)	0.0% (0/878)	0.0% (0/878)	0.0% (0/878)	0.0% (0/878)
F) >160–200	571	0.0% (0/571)	0.0% (0/571)	0.0% (0/571)	0.2% (1/571)	9.3% (53/571)	62.3% (356/571)	27.3% (156/571)	0.9% (5/571)	0.0% (0/571)	0.0% (0/571)	0.0% (0/571)
G) >200–250	427	0.0% (0/427)	0.0% (0/427)	0.0% (0/427)	0.0%(0/427)	0.2% (1/427)	8.2% (35/427)	62.5% (267/427)	27.6% (118/427)	1.4% (6/427)	0.0% (0/427)	0.0% (0/427)
H) >250–300	202	0.0% (0/202)	0.0% (0/202)	0.0% (0/202)	0.0%(0/202)	0.0%(0/202)	0.0% (0/202)	9.9% (20/202)	59.9% (121/202)	26.7% (54/202)	3.5% (7/202)	0.0% (0/202)
I) >300–350	93	0.0% (0/93)	0.0% (0/93)	0.0% (0/93)	0.0%(0/93)	0.0%(0/93)	0.0% (0/93)	0.0% (0/93)	16.1% (15/93)	59.1% (55/93)	22.6% (21/93)	2.2% (2/93)
J) >350–400	13	0.0% (0/13)	0.0% (0/13)	0.0% (0/13)	0.0%(0/13)	0.0%(0/13)	0.0% (0/13)	0.0% (0/13)	15.4% (2/13)	7.7% (1/13)	76.9% (10/13)	0.0% (0/13)
K) >400	-	-	-	-	-	-	-	-	-	-	-	-

Note: The overall number of available paired SG-YSI™* points on FST Day 1 was from 83 subjects.
Note: For the blank cells (-), there are no paired points in this reference range.

Percent agreement post calibration

The agreement of the SG values to paired YSI™* values was assessed for every 2-hour period post sensor calibration. For readings less than or equal to 80 mg/dL, the absolute difference in mg/dL between the SG and paired YSI™* values was calculated.

Table 30 and Table 31 show the percent agreement rates post calibration for sensors inserted into the abdomen. Performance when sensors are inserted in the arm is at least comparable to results when sensors are inserted in the abdomen.

Table 30. Agreement rates for every 2-hour period post calibration period; Calibration every 12 hours, Abdomen.

Time after calibration	Number of paired SG-YSI™*	Percent Agreement (%)				
		Percent of SG within 15/15% of YSI™*	Percent of SG within 20/20% of YSI™*	Percent of SG within 30/30% of YSI™*	Percent of SG within 40/40% of YSI™*	Percent of SG greater than 40/40% of YSI™*
0–2 hours	2999	85	92.6	97.8	99.6	0.4
2–4 hours	2667	75.1	85.9	95.3	98.8	1.2

Table 30. Agreement rates for every 2-hour period post calibration period; Calibration every 12 hours, Abdomen. (continued)

Time after calibration	Number of paired SG-YSI™*	Percent Agreement (%)				
		Percent of SG within 15/15% of YSI™*	Percent of SG within 20/20% of YSI™*	Percent of SG within 30/30% of YSI™*	Percent of SG within 40/40% of YSI™*	Percent of SG greater than 40/40% of YSI™*
4–6 hours	2138	71.4	82	92.7	97.6	2.4
6–8 hours	1521	77.6	88.4	97	99.3	0.7
8–10 hours	1523	84.2	91.1	97.6	99.3	0.7
10–12 hours	1242	79.8	89.5	96.3	98.6	1.4

* For reference range ≤80 mg/dL, agreement was based on 15/20/30/40 mg/dL.
Note: SG Readings are within 40–400 mg/dL.

Table 31. Agreement rates for every 2-hour period post calibration; Calibration 3 or 4 times a day, Abdomen.

Time after calibration	Number of paired SG-YSI™*	Percent Agreement (%)				
		Percent of SG within 15/15% of YSI™*	Percent of SG within 20/20% of YSI™*	Percent of SG within 30/30% of YSI™*	Percent of SG within 40/40% of YSI™*	Percent of SG greater than 40/40% of YSI™*
0–2 hours	4585	87	93.5	98.1	99.7	0.3
2–4 hours	3949	80.7	89.9	96.7	99	1
4–6 hours	2856	78.7	87.6	95.5	98.5	1.5
6–8 hours	227	74.9	86.3	96.9	99.6	0.4
8–10 hours	35	82.9	85.7	91.4	94.3	5.7
10–12 hours	12	91.7	91.7	91.7	100	0

* For reference range ≤80 mg/dL, agreement was based on 15/20/30/40 mg/dL.
Note: SG Readings are within 40–400 mg/dL.

Trend accuracy

Table 32 and Table 33 show, for each SG rate-of-change range (indicated on display by number of arrows), percentage of SG-YSI™* paired values that fell into different YSI™* rate-of-change ranges. The tables show the trend accuracy for sensors inserted into the abdomen. Performance when sensors are inserted in the arm is at least comparable to results when sensors are inserted into the abdomen.

Table 32. Trend accuracy; Calibration every 12 hours, Abdomen.

SG Rate-of-Change Range (mg/dL/min)	Number of Paired SG-YSI™*	Percent of Matched Pairs-in Each YSI™* Rate-of-Change Range for Each SG Rate-of-Change Range					
		YSI™* Rate-of-Change Ranges (mg/dL/min)					
		<-2	[-2, -1]	[-1, 0]	[0, 1]	[1, 2]	>2
A) <-2	162	38.3% (62/162)	40.1% (65/162)	20.4% (33/162)	0.6% (1/162)	0.6% (1/162)	0.0% (0/162)
B) [-2, -1]	1001	4.8% (48/1001)	39.9% (399/1001)	51.3% (514/1001)	3.7% (37/1001)	0.3% (3/1001)	0.0% (0/1001)
C) [-1, 0]	5960	0.5% (30/5960)	3.8% (228/5960)	77.6% (4627/5960)	17.1% (1020/5960)	0.8% (49/5960)	0.1% (6/5960)

Table 32. Trend accuracy; Calibration every 12 hours, Abdomen. (continued)

SG Rate-of-Change Range (mg/dL/min)	Number of Paired SG-YSI™	Percent of Matched Pairs-in Each YSI™ Rate-of-Change Range for Each SG Rate-of-Change Range					
		YSI™ Rate-of-Change Ranges (mg/dL/min)					
		<-2	[-2, -1]	[-1, 0]	[0, 1]	[1, 2]	>2
D) [0, 1]	3517	0.2% (7/3517)	0.5% (18/3517)	25.7% (903/3517)	63.4% (2231/3517)	9.3% (326/3517)	0.9% (32/3517)
E) [1, 2]	1059	0.1% (1/1059)	0.4% (4/1059)	4.5% (48/1059)	37.9% (401/1059)	48.6% (515/1059)	8.5% (90/1059)
F) >2	391	0.0% (0/391)	0.0% (0/391)	2.8% (11/391)	7.4% (29/391)	40.9% (160/391)	48.8% (191/391)

Table 33. Trend accuracy; Calibration 3 or 4 times a day, Abdomen.

SG Rate-of-Change Range (mg/dL/min)	Number of Paired SG-YSI™	Percent of Matched Pairs-in Each YSI™ Rate-of-Change Range for Each SG Rate-of-Change Range					
		YSI™ Rate-of-Change Ranges (mg/dL/min)					
		<-2	[-2, -1]	[-1, 0]	[0, 1]	[1, 2]	>2
A) <-2	159	39.0% (62/159)	39.6% (63/159)	19.5% (31/159)	0.6% (1/159)	1.3% (2/159)	0.0% (0/159)
B) [-2, -1]	967	5.1% (49/967)	38.7% (374/967)	51.9% (502/967)	4.0% (39/967)	0.3% (3/967)	0.0% (0/967)
C) [-1, 0]	5753	0.5% (28/5753)	4.0% (228/5753)	77.5% (4456/5753)	17.2% (990/5753)	0.8% (46/5753)	0.1% (5/5753)
D) [0, 1]	3387	0.2% (8/3387)	0.5% (18/3387)	26.5% (898/3387)	62.5% (2118/3387)	9.3% (316/3387)	0.9% (29/3387)
E) [1, 2]	1024	0.0% (0/1024)	0.2% (2/1024)	5.0% (51/1024)	38.8% (397/1024)	47.5% (486/1024)	8.6% (88/1024)
F) >2	374	0.0% (0/374)	0.0% (0/374)	2.4% (9/374)	8.0% (30/374)	42.8% (160/374)	46.8% (175/374)

Precision

Precision of the system was evaluated by comparing the results from two separate sensors worn in the abdomen on the same subject at the same time. A total of 83 subjects provided 30,350 paired SG-YSI™ measurements, with a mean Percent Absolute Relative Difference (PARD) of 9.07% with a coefficient of variation (%CV) of 6.5%.

Though precision in the arm has not been specifically assessed, arm vs. arm and arm vs. abdomen is likely comparable to the abdomen precision based on internal evaluation by Medtronic.

Sensor life

After the first successful calibration, 72.5% of sensors worn in the arm functioned more than six days and up to the full seven days of wear (144 to 168 hours). The median functional sensor life for sensors worn in the arm insertion site over the course of the study was 167.9 hours, with a mean functional life of 146.1 hours.

After the first successful calibration, 71.3% of sensors worn in the abdomen functioned more than six days and up to the full seven days of wear (144 to 168 hours). The median functional sensor life for sensors worn in the abdomen insertion site over the course of the study was 167.6 hours, with a mean functional life of 144.2 hours.

Safety

There were no moderate or severe device-related or procedure-related adverse events, device-related or procedure-related serious adverse events, or unanticipated adverse device effects through seven days of use.

C. Alert performance for users 14 years and older

The CGM system enables your device to display SG readings, glucose trend arrows, glucose trend graphs, and SG alerts (for example, High and Low Limit Threshold alerts, High and Low Predictive alerts, and Rise and Fall rate-of-change alerts).

The high and low limit alerts (Threshold alerts) let the user know when the SG is at or above the high limit or at or below the low limit. Using only a high or low limit alert may reduce the number of false alerts, but does not provide a warning before reaching a high or low limit. The default alert thresholds are highlighted in gray in the tables below.

Predictive alerts notify users that their SG level may soon reach a high or low limit setting. Users may select how early they would like to be notified before their SG level reaches a high limit setting. The earliest warning is 30 minutes before reaching a high limit setting, but users can reduce the amount of warning down to 5 minutes. Users will receive a warning approximately 30 minutes prior to when their SG level is predicted to reach their low limit setting. In general, the earlier the warning, the more time a user will have to react to a potential high or low limit setting, but this also increases the potential for false alerts.

A predictive alert is simply an estimation of a future SG level compared to the high or low limit setting. If the predicted SG value is above the high limit or below the low limit, then a predictive alert is sounded even though the current SG level has not crossed the high or low limit. The predicted SG level is calculated using the current SG level, the derivative of previous SG readings (the trend or slope of the SG readings) and the amount of early warning duration the user selects.

The device will always alert the user when the CGM system reads that the user is below 54 mg/dL, regardless of the high threshold, low threshold, or predictive alerts that the user sets.

Glucose TRUE Alert Rate

The glucose true alert rate is the rate at which the BG confirmed that the CGM alert was triggered correctly. For example:

True Threshold Hypoglycemic alert rate alerted when the CGM system read that the user was below the low threshold and the user's BG was actually below that low threshold.

True Threshold Hyperglycemic alert rate alerted when the CGM system read that the user was above the high threshold and the user's BG was actually above that high threshold.

True Predictive Hypoglycemic alert rate alerted when the CGM system predicted that the user would reach below the low threshold and the user's BG was actually below that low threshold within 15 or 30 minutes.

True Predictive Hyperglycemic alert rate alerted when the CGM system predicted that the user would reach above the high threshold and the user's BG was actually above that high threshold within 15 or 30 minutes.

The true alert rate is important because it is necessary that users be notified when their BG is low (or high) so that they can correct the low (or high) BG. A high true alert rate indicates that when the CGM system says that their glucose values are, or will reach a specified threshold, the user's BG is likely to be at or approaching that threshold.

For example, per the following table, the low glucose alerts would have correctly indicated that the user was below (i.e. threshold only), or predicted to reach below the threshold (i.e. predictive only) or both (predictive and threshold) 66.9%, 52.7%, or 58.3% of the time within 30 minutes (or 66.9%, 47.7%, or 55.2% of the time within 15 minutes) when the user had BG values lower than 70 mg/dL for a sensor inserted in the abdomen.

Table 34. Glucose TRUE Alert Performance using Calibration every 12 hours

mg/dL	Insertion Site	Glucose TRUE Alert Rate					
		Threshold Only		Predictive Only		Threshold & Predictive	
		30 min	15 min	30 min	15 min	30 min	15 min
50	Abdomen	25.0%	25.0%	15.2%	12.3%	18.2%	16.2%
	Arm	36.8%	36.8%	21.9%	16.7%	26.1%	22.4%
54	Abdomen	32.9%	32.9%	-	-	-	-
	Arm	50.9%	50.9%	-	-	-	-
60*	Abdomen	53.5%	51.9%	40.7%	37.1%	46.2%	43.4%
	Arm	69.0%	67.8%	47.5%	45.6%	55.1%	53.5%
70	Abdomen	66.9%	66.9%	52.7%	47.7%	58.3%	55.2%
	Arm	77.4%	75.3%	57.4%	54.5%	65.6%	63.0%
80	Abdomen	69.3%	69.3%	57.8%	51.1%	62.2%	58.2%
	Arm	77.5%	76.4%	59.9%	53.0%	66.5%	61.9%
90	Abdomen	75.1%	74.4%	64.0%	58.5%	67.9%	64.3%
	Arm	74.9%	74.9%	69.0%	63.2%	71.3%	68.0%
180	Abdomen	93.7%	92.8%	70.5%	66.9%	78.0%	75.4%
	Arm	92.9%	92.9%	68.0%	63.2%	76.5%	73.7%
220	Abdomen	91.9%	91.9%	68.9%	66.3%	76.6%	74.8%
	Arm	92.2%	92.2%	65.7%	62.2%	74.5%	72.2%
250	Abdomen	90.2%	90.2%	64.0%	60.1%	72.5%	69.8%
	Arm	91.4%	91.4%	62.0%	59.8%	71.1%	69.6%
300	Abdomen	81.3%	81.3%	57.8%	54.0%	65.4%	62.7%
	Arm	81.9%	80.6%	51.7%	49.7%	61.2%	59.3%

*The default alert threshold is highlighted in gray.

Glucose FALSE Alert Rate

The glucose false alert rate is the rate at which the BG did not confirm that the CGM alert was triggered correctly. For example:

False Threshold Hypoglycemic alert rate alerted when the CGM system read that the user was below the low threshold but the user's BG was actually above that low threshold.

False Threshold Hyperglycemic alert rate alerted when the CGM system read that the user was above the high threshold but the user's BG was actually below that high threshold.

False Predictive Hypoglycemic alert rate alerted when the CGM system predicted that the user would be below the low threshold but the user's BG was actually above that low threshold within 15 or 30 minutes.

False Predictive Hyperglycemic alert rate alerted when the CGM system predicted that the user would be above the high threshold but the user’s BG was actually below the high threshold within 15 or 30 minutes.

The false alert rate is important because it is necessary that users be correctly notified when their BG is low (or high) so that they can correct the low (or high) BG. A low false alert rate indicates that when the CGM system says that their glucose values are, or will reach a specified threshold, the user’s BG is likely to be at or approaching that threshold.

For example, per the following table, the high glucose threshold alerts would have incorrectly indicated that the user was above (i.e. threshold only), or predicted to reach above the threshold (i.e. predictive only), or both (threshold and predictive) 6.30%, 29.5%, or 22% of the time within 30 minutes (or 7.2%, 33.1%, or 24.6% of the time within 15 minutes) when the user had BG less than 180 mg/dL for a sensor inserted in the abdomen.

Table 35. Glucose FALSE Alert Performance using Calibration every 12 hours

mg/dL	Insertion Site	Glucose FALSE Alert Rate					
		Threshold Only		Predictive Only		Threshold and Predictive	
		30 min	15 min	30 min	15 min	30 min	15 min
50	Abdomen	75.0%	75.0%	84.8%	87.7%	81.8%	83.8%
	Arm	63.2%	63.2%	78.1%	83.3%	73.9%	77.6%
54	Abdomen	67.1%	67.1%	-	-	-	-
	Arm	49.1%	49.1%	-	-	-	-
60*	Abdomen	46.5%	48.1%	59.3%	62.9%	53.8%	56.6%
	Arm	31.0%	32.2%	52.5%	54.4%	44.9%	46.5%
70	Abdomen	33.1%	33.1%	47.3%	52.3%	41.7%	44.8%
	Arm	22.6%	24.7%	42.6%	45.5%	34.4%	37.0%
80	Abdomen	30.7%	30.7%	42.2%	48.9%	37.8%	41.8%
	Arm	22.5%	23.6%	40.1%	47.0%	33.5%	38.1%
90	Abdomen	24.9%	25.6%	36.0%	41.5%	32.1%	35.7%
	Arm	25.1%	25.1%	31.0%	36.8%	28.7%	32.0%
180	Abdomen	6.30%	7.20%	29.5%	33.1%	22.0%	24.6%
	Arm	7.10%	7.10%	32.0%	36.8%	23.5%	26.3%
220	Abdomen	8.10%	8.10%	31.1%	33.7%	23.4%	25.2%
	Arm	7.80%	7.80%	34.3%	37.8%	25.5%	27.8%
250	Abdomen	9.80%	9.80%	36.0%	39.9%	27.5%	30.2%
	Arm	8.60%	8.60%	38.0%	40.2%	28.9%	30.4%
300	Abdomen	18.8%	18.8%	42.2%	46.0%	34.6%	37.3%
	Arm	18.1%	19.4%	48.3%	50.3%	38.8%	40.7%

*The default alert threshold is highlighted in gray.

Glucose Correct Detection Rate

Glucose Correct Detection Rate is the rate that the device alerted when it should have alerted. For example, the BG was below the hypoglycemic threshold, or above the hyperglycemic threshold, and the device sounded an alert.

Glucose detection rates are important because it is necessary that users be notified when their BG is low (or high) so that they can correct the low (or high) BG. A high glucose correct detection rate indicates that users can have confidence that they will be notified by the device if their BG is low or high.

For example, per the following table, the threshold alert, the predictive alert, or both (threshold and predictive) notified the user 64%, 76%, or 76% of the time within 30 minutes (or 64%, 68%, or 68% within 15 minutes) when the user had BG less than 50 mg/dL for a sensor inserted in the abdomen.

Table 36. Glucose Correct Detection Alert Performance using Calibration every 12 hours

mg/dL	Insertion Site	Glucose Correct Detection Rate					
		Threshold Only		Predictive Only		Threshold & Predictive	
		30 min	15 min	30 min	15 min	30 min	15 min
50	Abdomen	64.0%	64.0%	76.0%	68.0%	76.0%	68.0%
	Arm	66.7%	66.7%	95.2%	71.4%	95.2%	76.2%
54	Abdomen	68.3%	68.3%	-	-	-	-
	Arm	80.0%	80.0%	-	-	-	-
60*	Abdomen	83.3%	82.1%	94.0%	88.1%	94.0%	89.3%
	Arm	86.3%	83.6%	98.6%	94.5%	98.6%	97.3%
70	Abdomen	90.5%	90.5%	94.2%	89.8%	94.2%	92.0%
	Arm	90.2%	88.6%	92.7%	90.2%	93.5%	91.9%
80	Abdomen	87.2%	87.2%	93.6%	87.2%	93.6%	89.9%
	Arm	89.0%	88.4%	94.8%	86.6%	95.9%	92.4%
90	Abdomen	91.1%	88.7%	94.6%	89.5%	95.7%	92.2%
	Arm	91.7%	90.4%	96.9%	91.7%	97.8%	95.6%
180	Abdomen	93.1%	91.4%	96.6%	93.4%	96.9%	95.4%
	Arm	93.2%	92.2%	98.1%	94.2%	98.7%	96.4%
220	Abdomen	90.1%	89.2%	94.8%	93.5%	95.3%	94.4%
	Arm	90.1%	89.2%	96.1%	93.6%	96.1%	95.6%
250	Abdomen	81.5%	80.9%	96.5%	91.3%	96.5%	93.6%
	Arm	80.9%	79.6%	96.7%	90.8%	96.7%	91.4%
300	Abdomen	75.3%	75.3%	95.3%	92.9%	95.3%	94.1%
	Arm	74.4%	71.8%	93.6%	89.7%	93.6%	89.7%

*The default alert threshold is highlighted in gray.

Glucose Missed Detection Rate

The Missed Detection Rate is the rate that the device did not alert when it should have. For example, the BG was below the hypoglycemic threshold, or above the hyperglycemic threshold, and the device did not sound a threshold or predictive alert.

Missed detection rates are important because it is necessary that users be notified when their BG is low (or high), so that they can correct the low (or high) BG. A low missed detection rate indicates that users can have confidence that they will be notified by the device if their BG is low or high.

For example, per the following table, the threshold alert, predictive alert, or both alerts (threshold and predictive) did not sound 36%, 24%, or 24% of the time within 30 minutes (or 36%, 32%, or 32% within 15 minutes) when the user had BG less than 50 mg/dL for a sensor inserted in the abdomen.

Table 37. Glucose Missed Detection Alert Performance using Calibration every 12 hours

mg/dL	Insertion Site	Glucose Missed Detection Rate					
		Threshold Only		Predictive Only		Threshold & Predictive	
		30 min	15 min	30 min	15 min	30 min	15 min
50	Abdomen	36.0%	36.0%	24.0%	32.0%	24.0%	32.0%
	Arm	33.3%	33.3%	4.8%	28.6%	4.8%	23.8%
54	Abdomen	31.7%	31.7%	-	-	-	-
	Arm	20.0%	20.0%	-	-	-	-
60*	Abdomen	16.7%	17.9%	6.0%	11.9%	6.0%	10.7%
	Arm	13.7%	16.4%	1.4%	5.5%	1.4%	2.7%
70	Abdomen	9.5%	9.5%	5.8%	10.2%	5.8%	8.0%
	Arm	9.8%	11.4%	7.3%	9.8%	6.5%	8.1%
80	Abdomen	12.8%	12.8%	6.4%	12.8%	6.4%	10.1%
	Arm	11.0%	11.6%	5.2%	13.4%	4.1%	7.6%
90	Abdomen	8.9%	11.3%	5.4%	10.5%	4.3%	7.8%
	Arm	8.3%	9.6%	3.1%	8.3%	2.2%	4.4%
180	Abdomen	6.9%	8.6%	3.4%	6.6%	3.1%	4.6%
	Arm	6.8%	7.8%	1.9%	5.8%	1.3%	3.6%
220	Abdomen	9.9%	10.8%	5.2%	6.5%	4.7%	5.6%
	Arm	9.9%	10.8%	3.9%	6.4%	3.9%	4.4%
250	Abdomen	18.5%	19.1%	3.5%	8.7%	3.5%	6.4%
	Arm	19.1%	20.4%	3.3%	9.2%	3.3%	8.6%
300	Abdomen	24.7%	24.7%	4.7%	7.1%	4.7%	5.9%
	Arm	25.6%	28.2%	6.4%	10.3%	6.4%	10.3%

*The default alert threshold is highlighted in gray.

E. Guardian Sensor (3) Performance in users ages 7 to 13

CGM performance

The use of the Guardian Sensor (3) with the Guardian Link (3) transmitter enables CGM technology. The transmitter transmits SG values calculated by the real-time algorithm to a primary display device, allowing you to monitor your SG values.

Clinical study description

The performance of the Guardian Sensor (3) was evaluated in a clinical study¹⁹. This in-patient (in-clinic) and outpatient (at home) study included subjects 7 to 13 years in age. The study design was a multi-center, prospective single sample correlational design without controls.

All subjects were assigned to treatment. Each subject was instructed to wear two Guardian Sensor (3) sensors in the abdomen or buttock.

- One Guardian Sensor (3) connected to the Guardian Connect Transmitter, which transmitted to the Guardian Connect app, a standalone CGM display device.
- One Guardian Sensor (3) connected to the Guardian Link (3) transmitter, which served as a glucose sensor recorder (GSR, transmitter and recorder for sensor-integrated pump systems).

The SG data collected by the blinded GSRs were retrospectively processed through the real-time CGM algorithm. This is the same algorithm used in the Guardian Connect and pump CGM systems. Thus all data is representative of real-time sensor usage.

The CONTOUR NEXT™ LINK 2.4 Wireless Meter was the study meter used for all calibrations in this study, and was the only meter evaluated with the Guardian Sensor (3) CGM systems. The sensor has not been tested with other meters. Therefore, the performance with other BG meters may differ from the performance with the CONTOUR NEXT™ LINK 2.4 Wireless Meter described below.

FST was performed on day 1, 3, or 7 for 6 hours each, over the life of the sensor. Reference blood (plasma) glucose values were obtained with a YSI™ Glucose Analyzer every 5 to

¹⁹ Medtronic Inc., A Performance Evaluation of the Enlite™ and Enlite™ 3 Glucose Sensor to Support Use in Children; CEP249 Data From Subjects 7-13 Years of Age 10703807DOC. November 2017.

15 minutes. During the FSTs, the subjects were instructed to calibrate the sensors once every 12 hours, or as requested by the display device. During home use (outside the clinic), subjects were instructed to calibrate both sensors three to four times spread throughout the day. During the FST procedures, glucose challenges were limited to 30 minutes of exercise. Therefore, there were a limited number of glucose values in the high and low glucose ranges.

The overall number of subjects that participated in FST procedures on day 1, 3, or 7 were 21, 13, and 10 respectively.

During the study, the meter was used for confirmation of alarms, treatment decisions, and sensor calibrations.

Results

Sensor accuracy

The following information highlights the Guardian Sensor (3) performance from 50 subjects (7 to 13 years old) wearing the Guardian Link (3) Transmitter that served as a glucose sensor recorder (GSR, transmitter and recorder for sensor-integrated pump systems) and the Guardian Connect Transmitter, which transmitted to the Guardian Connect app (a standalone CGM display device) during FST.

Mean absolute relative difference, by number of daily calibrations

Table 38 shows the sensor accuracy measured by the MARD. MARD represents the average relative difference (regardless if positive or negative) between the SG values and the paired BG values measured by YSI™.*

Table 38. SG MARD Versus YSI™.* (within YSI™.* glucose ranges)

YSI™.* Glucose Ranges (mg/dL)	Abdomen Insertion Site				Buttock Insertion Site			
	Calibration every 12 hours		Calibration 3 or 4 times a day		Calibration every 12 hours		Calibration 3 or 4 times a day	
	Number of Paired SG-YSI™.*	MARD (%)	Number of Paired SG-YSI™.*	MARD (%)	Number of Paired SG-YSI™.*	MARD (%)	Number of Paired SG-YSI™.*	MARD (%)
Overall	733	10.46	710	9.84	710	9.14	686	8.79
40-60*	4	19.16	2	31.9	7	5.43	7	3.61
61-80*	20	10.59	18	8.54	34	10.85	28	7.86
81-180	378	11.59	367	11.04	393	9.63	374	8.99
181-300	290	8.76	282	8.4	255	7.92	253	8.56
301-350	32	7.11	32	5.63	15	4.64	18	7.67
351-400	9	8.59	9	5.57	6	5.05	6	3.01

Table 38. SG MARD Versus YSI™* (within YSI™* glucose ranges) (continued)

YSI™* Glucose Ranges (mg/dL)	Abdomen Insertion Site				Buttock Insertion Site			
	Calibration every 12 hours		Calibration 3 or 4 times a day		Calibration every 12 hours		Calibration 3 or 4 times a day	
	Number of Paired SG-YSI™*	MARD (%)	Number of Paired SG-YSI™*	MARD (%)	Number of Paired SG-YSI™*	MARD (%)	Number of Paired SG-YSI™*	MARD (%)
* For YSI™* reference range ≤ 80 mg/dL, the differences in mg/dL are included instead of percent difference (%).								
Note: SG Readings are within 40–400 mg/dL.								

Percent agreement, by number of daily calibrations

In *Table 39* through *Table 46*, the agreement of the SG values to paired YSI™* values was assessed by calculating the percentage of YSI™* values that were within 15%, 20%, 30%, 40%, and greater than 40% of the paired SG values. For readings less than or equal to 80 mg/dL, the absolute difference in mg/dL between the SG and paired YSI™* values was calculated.

Results are shown for defined SG ranges when calibrating every 12 hours and calibrating three or four times a day for sensors.

Table 39. Agreement (%) of SG-YSI™* paired points within YSI™* glucose ranges on FST Days 1, 3, and 7; Calibration every 12 hours, Abdomen

YSI™* Glucose Ranges (mg/dL)	Number of Paired SG-YSI™*	Percent of SG Within 15/15% of YSI™*	Percent of SG Within 20/20% of YSI™*	Percent of SG Within 30/30% of YSI™*	Percent of SG Within 40/40% of YSI™*	Percent of SG greater than 40/40% of YSI™*
Overall	733	78.9	87.7	95.9	98.9	1.1
≥40-60*	4	50	50	75	100	0
>60-80*	20	70	80	90	95	5
>80-180	378	74.1	83.1	92.9	98.1	1.9
>180-300	290	83.1	93.1	100	100	0
>300-350	32	100	100	100	100	0
>350-400	9	100	100	100	100	0
* For glucose ranges ≤ 80 mg/dL, agreement was based on 15/20/30/40 mg/dL.						
Note: SG readings are within 40–400 mg/dL.						

Table 40. Agreement (%) of SG-YSI™* paired points within YSI™* glucose ranges on FST Day 1; Calibration every 12 hours, Abdomen

YSI™* Glucose Ranges (mg/dL)	Number of Paired SG-YSI™*	Percent of SG Within 15/15% of YSI™*	Percent of SG Within 20/20% of YSI™*	Percent of SG Within 30/30% of YSI™*	Percent of SG Within 40/40% of YSI™*	Percent of SG greater than 40/40% of YSI™*
Overall	403	81.9	90.6	96.5	99	1
≥40-60*	2	100	100	100	100	0
>60-80*	11	63.6	72.7	90.9	100	0
>80-180	196	75.5	84.2	93.4	98	2

Table 40. Agreement (%) of SG-YSI™* paired points within YSI™* glucose ranges on FST Day 1; Calibration every 12 hours, Abdomen (continued)

YSI™* Glucose Ranges (mg/dL)	Number of Paired SG-YSI™*	Percent of SG Within 15/15% of YSI™*	Percent of SG Within 20/20% of YSI™*	Percent of SG Within 30/30% of YSI™*	Percent of SG Within 40/40% of YSI™*	Percent of SG greater than 40/40% of YSI™*
>180-300	160	86.9	97.5	100	100	0
>300-350	27	100	100	100	100	0
>350-400	7	100	100	100	100	0
* For glucose ranges ≤ 80 mg/dL, agreement was based on 15/20/30/40 mg/dL.						
Note: The overall number of available paired SG-YSI™* points on FST Day 1 was from 16 subjects. SG readings are within 40–400 mg/dL.						

Table 41. Agreement (%) of SG-YSI™* paired points within YSI™* glucose ranges on FST Days 1, 3, and 7; Calibration 3 or 4 times a day, Abdomen

YSI™* Glucose Ranges (mg/dL)	Number of Paired SG-YSI™*	Percent of SG Within 15/15% of YSI™*	Percent of SG Within 20/20% of YSI™*	Percent of SG Within 30/30% of YSI™*	Percent of SG Within 40/40% of YSI™*	Percent of SG greater than 40/40% of YSI™*
Overall	710	81.7	90	97.2	99.4	0.6
≥40-60*	2	0	0	50	100	0
>60-80*	18	83.3	88.9	94.4	94.4	5.6
>80-180	367	74.9	84.5	95.1	99.2	0.8
>180-300	282	88.3	96.5	100	100	0
>300-350	32	100	100	100	100	0
>350-400	9	100	100	100	100	0
* For glucose ranges ≤ 80 mg/dL, agreement was based on 15/20/30/40 mg/dL.						
Note: SG readings are within 40–400 mg/dL.						

Table 42. Agreement (%) of SG-YSI™* paired points within YSI™* glucose ranges on FST Day 1; Calibration 3 or 4 times a day, Abdomen

YSI™* Glucose Ranges (mg/dL)	Number of Paired SG-YSI™*	Percent of SG Within 15/15% of YSI™*	Percent of SG Within 20/20% of YSI™*	Percent of SG Within 30/30% of YSI™*	Percent of SG Within 40/40% of YSI™*	Percent of SG greater than 40/40% of YSI™*
Overall	372	83.9	92.2	97.3	99.5	0.5
>60-80*	9	77.8	88.9	100	100	0
>80-180	182	76.9	86.3	94.5	98.9	1.1
>180-300	147	89.1	98	100	100	0
>300-350	27	100	100	100	100	0
>350-400	7	100	100	100	100	0
* For glucose ranges ≤ 80 mg/dL, agreement was based on 15/20/30/40 mg/dL.						
Note: The overall number of available paired SG-YSI™* points on FST Day 1 was from 15 subjects. SG readings are within 40–400 mg/dL.						

Table 43. Agreement (%) of SG-YSI™* paired points within YSI™* glucose ranges on FST Days 1, 3, and 7; Calibration every 12 hours, Buttock

YSI™* Glucose Ranges (mg/dL)	Number of Paired SG-YSI™*	Percent of SG Within 15/15% of YSI™*	Percent of SG Within 20/20% of YSI™*	Percent of SG Within 30/30% of YSI™*	Percent of SG Within 40/40% of YSI™*	Percent of SG greater than 40/40% of YSI™*
Overall	710	84.8	92.3	96.8	98.6	1.4

Table 43. Agreement (%) of SG-YSI™* paired points within YSI™* glucose ranges on FST Days 1, 3, and 7; Calibration every 12 hours, Buttock (continued)

YSI™* Glucose Ranges (mg/dL)	Number of Paired SG-YSI™*	Percent of SG Within 15/15% of YSI™*	Percent of SG Within 20/20% of YSI™*	Percent of SG Within 30/30% of YSI™*	Percent of SG Within 40/40% of YSI™*	Percent of SG greater than 40/40% of YSI™*
≥40-60*	7	100	100	100	100	0
>60-80*	34	70.6	79.4	94.1	100	0
>80-180	393	80.9	89.8	94.9	97.5	2.5
>180-300	255	91	96.9	99.6	100	0
>300-350	15	100	100	100	100	0
>350-400	6	100	100	100	100	0

* For glucose ranges ≤ 80 mg/dL, agreement was based on 15/20/30/40 mg/dL.
Note: SG readings are within 40–400 mg/dL.

Table 44. Agreement (%) of SG-YSI™* paired points within YSI™* glucose ranges on FST Day 1; Calibration every 12 hours, Buttock

YSI™* Glucose Ranges (mg/dL)	Number of Paired SG-YSI™*	Percent of SG Within 15/15% of YSI™*	Percent of SG Within 20/20% of YSI™*	Percent of SG Within 30/30% of YSI™*	Percent of SG Within 40/40% of YSI™*	Percent of SG greater than 40/40% of YSI™*
Overall	335	78.8	87.2	93.7	97	3
>60-80*	19	52.6	63.2	89.5	100	0
>80-180	178	71.9	82.6	89.9	94.4	5.6
>180-300	133	91	96.2	99.2	100	0
>300-350	3	100	100	100	100	0
>350-400	2	100	100	100	100	0

* For glucose ranges ≤ 80 mg/dL, agreement was based on 15/20/30/40 mg/dL.
Note: The overall number of available paired SG-YSI™* points on FST Day 1 was from 14 subjects. SG readings are within 40–400 mg/dL.

Table 45. Agreement (%) of SG-YSI™* paired points within YSI™* glucose ranges on FST Days 1, 3, and 7; Calibration 3 or 4 times a day, Buttock

YSI™* Glucose Ranges (mg/dL)	Number of Paired SG-YSI™*	Percent of SG Within 15/15% of YSI™*	Percent of SG Within 20/20% of YSI™*	Percent of SG Within 30/30% of YSI™*	Percent of SG Within 40/40% of YSI™*	Percent of SG greater than 40/40% of YSI™*
Overall	686	84.7	92.7	97.1	99.1	0.9
≥40-60*	7	100	100	100	100	0
>60-80*	28	85.7	89.3	100	100	0
>80-180	374	82.4	90.4	95.7	98.4	1.6
>180-300	253	87.4	96	98.4	100	0
>300-350	18	83.3	94.4	100	100	0
>350-400	6	100	100	100	100	0

* For glucose ranges ≤ 80 mg/dL, agreement was based on 15/20/30/40 mg/dL.
Note: SG readings are within 40–400 mg/dL.

Table 46. Agreement (%) of SG-YSI™* paired points within YSI™* glucose ranges on FST Day 1; Calibration 3 or 4 times a day, Buttock

YSI™* Glucose Ranges (mg/dL)	Number of Paired SG-YSI™*	Percent of SG Within 15/15% of YSI™*	Percent of SG Within 20/20% of YSI™*	Percent of SG Within 30/30% of YSI™*	Percent of SG Within 40/40% of YSI™*	Percent of SG greater than 40/40% of YSI™*
Overall	311	80.7	90.4	95.5	98.7	1.3
>60-80*	13	69.2	76.9	100	100	0
>80-180	159	77.4	86.8	92.5	97.5	2.5
>180-300	131	87	96.2	98.5	100	0
>300-350	6	50	83.3	100	100	0
>350-400	2	100	100	100	100	0

* For glucose ranges ≤ 80 mg/dL, agreement was based on 15/20/30/40 mg/dL.

Note: The overall number of available paired SG-YSI™* points on FST Day 1 was from 13 subjects. SG readings are within 40–400 mg/dL.

Agreement when CGM reads “Below 40 mg/dL” or “Above 400 mg/dL”

The real-time CGM systems display glucose values between 40 mg/dL and 400 mg/dL. It displays “Below 40 mg/dL” when the SG value detected is below 40 mg/dL. It displays “Above 400 mg/dL” when the SG value detected is above 400 mg/dL. Tables E-10 through E-13 illustrate the number and percentage of the paired YSI™* values in different BG levels when the CGM system displays “Below 40 mg/dL” (LOW) or “Above 400 mg/dL” (HIGH).

Table 47. The number and percentage of YSI™* values collected when CGM displays “Below 40 mg/dL” (LOW); Calibration every 12 hours

CGM Display	Insertion Site	CGM-YSI™* pairs	YSI™* (mg/dL)					Total
			<55	<60	<70	<80	>80	
LOW	Abdomen	Cumulative, n	2	2	2	2	0	2
		Cumulative %	100%	100%	100%	100%	0%	
	Buttocks	Cumulative, n	3	4	7	7	1	8
		Cumulative %	38%	50%	88%	88%	13%	

Table 48. The number and percentage of YSI™* values collected when CGM displays “Below 40 mg/dL” (LOW); Calibration 3 or 4 times a day

CGM Display	Insertion Site	CGM-YSI™* pairs	YSI™* (mg/dL)					Total
			<55	<60	<70	<80	>80	
LOW	Abdomen	Cumulative, n	0	0	0	0	0	0
		Cumulative %	0%	0%	0%	0%	0%	
	Buttocks	Cumulative, n	3	4	6	6	1	7
		Cumulative %	43%	57%	86%	86%	14%	

Table 49. The number and percentage of YSI™ values collected when CGM displays “Above 400 mg/dL” (HIGH); Calibration every 12 hours

CGM Display	Insertion Site	CGM-YSI™ pairs	YSI™ (mg/dL)					Total
			>340	>320	>280	>240	<240	
HIGH	Abdomen	Cumulative, n	0	0	0	0	0	0
		Cumulative %	0%	0%	0%	0%	0%	
	Buttocks	Cumulative, n	0	0	0	0	0	0
		Cumulative %	0%	0%	0%	0%	0%	

Table 50. The number and percentage of YSI™ values collected when CGM displays “Above 400 mg/dL” (HIGH); Calibration 3 or 4 times a day.

CGM Display	Insertion Site	CGM-YSI™ pairs	YSI™ (mg/dL)					Total
			>340	>320	>280	>240	<240	
HIGH	Abdomen	Cumulative, n	0	0	0	0	0	0
		Cumulative %	0%	0%	0%	0%	0%	
	Buttocks	Cumulative, n	0	0	0	0	0	0
		Cumulative %	0%	0%	0%	0%	0%	

Concurrence of SG and YSI™ values

The following tables show the percentage of concurring SG readings with FST reference values.

Table 51. Overall concurrence of YSI™ values and SG readings using YSI™ ranges on FST Days 1, 3, and 7; Calibration every 12 hours, Abdomen

Percent of Matched Pairs-in Each SG Glucose Range for Each YSI™ Glucose Range												
YSI™ Glucose Ranges (mg/dL)	Number of Paired SG-YSI™ *	SG (mg/dL)										
		<40	≥40-60	>60-80	>80-120	>120-160	>160-200	>200-250	>250-300	>300-350	>350-400	>400
B) ≥40-60	6	33.3% (2/6)	33.3% (2/6)	0.0% (0/6)	33.3% (2/6)	0.0% (0/6)	0.0% (0/6)	0.0% (0/6)	0.0% (0/6)	0.0% (0/6)	0.0% (0/6)	0.0% (0/6)
C) >60-80	20	0.0% (0/20)	10.0% (2/20)	55.0% (11/20)	35.0% (7/20)	0.0% (0/20)	0.0% (0/20)	0.0% (0/20)	0.0% (0/20)	0.0% (0/20)	0.0% (0/20)	0.0% (0/20)
D) >80-120	124	0.0% (0/124)	4.8% (6/124)	13.7% (17/124)	66.1% (82/124)	15.3% (19/124)	0.0% (0/124)	0.0% (0/124)	0.0% (0/124)	0.0% (0/124)	0.0% (0/124)	0.0% (0/124)
E) >120-160	169	0.0% (0/169)	0.0% (0/169)	0.6% (1/169)	21.3% (36/169)	62.1% (105/169)	15.4% (26/169)	0.6% (1/169)	0.0% (0/169)	0.0% (0/169)	0.0% (0/169)	0.0% (0/169)
F) >160-200	160	0.0% (0/160)	0.0% (0/160)	0.0% (0/160)	1.9% (3/160)	25.0% (40/160)	64.4% (103/160)	8.8% (14/160)	0.0% (0/160)	0.0% (0/160)	0.0% (0/160)	0.0% (0/160)
G) >200-250	151	0.0% (0/151)	0.0% (0/151)	0.0% (0/151)	0.0% (0/151)	1.3% (2/151)	40.4% (61/151)	56.3% (85/151)	2.0% (3/151)	0.0% (0/151)	0.0% (0/151)	0.0% (0/151)

Table 51. Overall concurrence of YSI™* values and SG readings using YSI™* ranges on FST Days 1, 3, and 7; Calibration every 12 hours, Abdomen (continued)

Percent of Matched Pairs-in Each SG Glucose Range for Each YSI™* Glucose Range												
YSI™* Glucose Ranges (mg/dL)	Number of Paired SG-YSI™* *	SG (mg/dL)										
		<40	≥40-60	>60-80	>80-120	>120-160	>160-200	>200-250	>250-300	>300-350	>350-400	>400
H) >250-300	64	0.0% (0/64)	0.0% (0/64)	0.0% (0/64)	0.0% (0/64)	0.0% (0/64)	0.0% (0/64)	32.8% (21/64)	64.1% (41/64)	3.1% (2/64)	0.0% (0/64)	0.0% (0/64)
I) >300-350	32	0.0% (0/32)	0.0% (0/32)	0.0% (0/32)	0.0% (0/32)	0.0% (0/32)	0.0% (0/32)	0.0% (0/32)	40.6% (13/32)	59.4% (19/32)	0.0% (0/32)	0.0% (0/32)
J) >350-400	9	0.0% (0/9)	0.0% (0/9)	0.0% (0/9)	0.0% (0/9)	0.0% (0/9)	0.0% (0/9)	0.0% (0/9)	0.0% (0/9)	88.9% (8/9)	11.1% (1/9)	0.0% (0/9)

Table 52. Overall concurrence of YSI™* values and SG readings using YSI™* ranges on FST Day 1; Calibration every 12 hours, Abdomen

Percent of Matched Pairs-in Each SG Glucose Range for Each YSI™* Glucose Range												
YSI™* Glucose Ranges (mg/dL)	Number of Paired SG-YSI™* *	SG (mg/dL)										
		<40	≥40-60	>60-80	>80-120	>120-160	>160-200	>200-250	>250-300	>300-350	>350-400	>400
B) ≥40-60	4	50.0% (2/4)	50.0% (2/4)	0.0% (0/4)	0.0% (0/4)	0.0% (0/4)	0.0% (0/4)	0.0% (0/4)	0.0% (0/4)	0.0% (0/4)	0.0% (0/4)	0.0% (0/4)
C) >60-80	11	0.0% (0/11)	18.2% (2/11)	45.5% (5/11)	36.4% (4/11)	0.0% (0/11)	0.0% (0/11)	0.0% (0/11)	0.0% (0/11)	0.0% (0/11)	0.0% (0/11)	0.0% (0/11)
D) >80-120	50	0.0% (0/50)	6.0% (3/50)	8.0% (4/50)	62.0% (31/50)	24.0% (12/50)	0.0% (0/50)	0.0% (0/50)	0.0% (0/50)	0.0% (0/50)	0.0% (0/50)	0.0% (0/50)
E) >120-160	94	0.0% (0/94)	0.0% (0/94)	1.1% (1/94)	19.1% (18/94)	58.5% (55/94)	20.2% (19/94)	1.1% (1/94)	0.0% (0/94)	0.0% (0/94)	0.0% (0/94)	0.0% (0/94)
F) >160-200	95	0.0% (0/95)	0.0% (0/95)	0.0% (0/95)	2.1% (2/95)	17.9% (17/95)	69.5% (66/95)	10.5% (10/95)	0.0% (0/95)	0.0% (0/95)	0.0% (0/95)	0.0% (0/95)
G) >200-250	83	0.0% (0/83)	0.0% (0/83)	0.0% (0/83)	0.0% (0/83)	1.2% (1/83)	27.7% (23/83)	68.7% (57/83)	2.4% (2/83)	0.0% (0/83)	0.0% (0/83)	0.0% (0/83)
H) >250-300	34	0.0% (0/34)	0.0% (0/34)	0.0% (0/34)	0.0% (0/34)	0.0% (0/34)	0.0% (0/34)	44.1% (15/34)	52.9% (18/34)	2.9% (1/34)	0.0% (0/34)	0.0% (0/34)
I) >300-350	27	0.0% (0/27)	0.0% (0/27)	0.0% (0/27)	0.0% (0/27)	0.0% (0/27)	0.0% (0/27)	0.0% (0/27)	37.0% (10/27)	63.0% (17/27)	0.0% (0/27)	0.0% (0/27)
J) >350-400	7	0.0% (0/7)	0.0% (0/7)	0.0% (0/7)	0.0% (0/7)	0.0% (0/7)	0.0% (0/7)	0.0% (0/7)	0.0% (0/7)	100.0% (7/7)	0.0% (0/7)	0.0% (0/7)

Note: The overall number of available paired SG-YSI™* points on FST Day 1 was from 16 subjects.

Table 53. Overall concurrence of YSI™ values and SG readings using YSI™ ranges on FST Days 1, 3, and 7; Calibration 3 or 4 times a day, Abdomen

Percent of Matched Pairs-in Each SG Glucose Range for Each YSI™ Glucose Range												
YSI™ Glucose Ranges (mg/dL)	Number of Paired SG-YSI™ *	SG (mg/dL)										
		<40	≥40-60	>60-80	>80-120	>120-160	>160-200	>200-250	>250-300	>300-350	>350-400	>400
B) ≥40-60	2	0.0% (0/2)	0.0% (0/2)	0.0% (0/2)	100.0% (2/2)	0.0% (0/2)	0.0% (0/2)	0.0% (0/2)	0.0% (0/2)	0.0% (0/2)	0.0% (0/2)	0.0% (0/2)
C) >60-80	18	0.0% (0/18)	0.0% (0/18)	61.1% (11/18)	38.9% (7/18)	0.0% (0/18)	0.0% (0/18)	0.0% (0/18)	0.0% (0/18)	0.0% (0/18)	0.0% (0/18)	0.0% (0/18)
D) >80-120	120	0.0% (0/120)	3.3% (4/120)	15.8% (19/120)	67.5% (81/120)	13.3% (16/120)	0.0% (0/120)	0.0% (0/120)	0.0% (0/120)	0.0% (0/120)	0.0% (0/120)	0.0% (0/120)
E) >120-160	162	0.0% (0/162)	0.0% (0/162)	0.0% (0/162)	17.9% (29/162)	64.8% (105/162)	16.7% (27/162)	0.6% (1/162)	0.0% (0/162)	0.0% (0/162)	0.0% (0/162)	0.0% (0/162)
F) >160-200	161	0.0% (0/161)	0.0% (0/161)	0.0% (0/161)	1.2% (2/161)	25.5% (41/161)	65.2% (105/161)	8.1% (13/161)	0.0% (0/161)	0.0% (0/161)	0.0% (0/161)	0.0% (0/161)
G) >200-250	145	0.0% (0/145)	0.0% (0/145)	0.0% (0/145)	0.0% (0/145)	1.4% (2/145)	42.8% (62/145)	53.8% (78/145)	2.1% (3/145)	0.0% (0/145)	0.0% (0/145)	0.0% (0/145)
H) >250-300	61	0.0% (0/61)	0.0% (0/61)	0.0% (0/61)	0.0% (0/61)	0.0% (0/61)	0.0% (0/61)	32.8% (20/61)	65.6% (40/61)	1.6% (1/61)	0.0% (0/61)	0.0% (0/61)
I) >300-350	32	0.0% (0/32)	0.0% (0/32)	0.0% (0/32)	0.0% (0/32)	0.0% (0/32)	0.0% (0/32)	0.0% (0/32)	37.5% (12/32)	62.5% (20/32)	0.0% (0/32)	0.0% (0/32)
J) >350-400	9	0.0% (0/9)	0.0% (0/9)	0.0% (0/9)	0.0% (0/9)	0.0% (0/9)	0.0% (0/9)	0.0% (0/9)	0.0% (0/9)	55.6% (5/9)	44.4% (4/9)	0.0% (0/9)

Table 54. Overall concurrence of YSI™ values and SG readings using YSI™ ranges on FST Day 1; Calibration 3 or 4 times a day, Abdomen

Percent of Matched Pairs-in Each SG Glucose Range for Each YSI™ Glucose Range												
YSI™ Glucose Ranges (mg/dL)	Number of Paired SG-YSI™ *	SG (mg/dL)										
		<40	≥40-60	>60-80	>80-120	>120-160	>160-200	>200-250	>250-300	>300-350	>350-400	>400
C) >60-80	9	0.0% (0/9)	0.0% (0/9)	55.6% (5/9)	44.4% (4/9)	0.0% (0/9)	0.0% (0/9)	0.0% (0/9)	0.0% (0/9)	0.0% (0/9)	0.0% (0/9)	0.0% (0/9)
D) >80-120	46	0.0% (0/46)	2.2% (1/46)	10.9% (5/46)	67.4% (31/46)	19.6% (9/46)	0.0% (0/46)	0.0% (0/46)	0.0% (0/46)	0.0% (0/46)	0.0% (0/46)	0.0% (0/46)
E) >120-160	85	0.0% (0/85)	0.0% (0/85)	0.0% (0/85)	16.5% (14/85)	60.0% (51/85)	22.4% (19/85)	1.2% (1/85)	0.0% (0/85)	0.0% (0/85)	0.0% (0/85)	0.0% (0/85)
F) >160-200	91	0.0% (0/91)	0.0% (0/91)	0.0% (0/91)	2.2% (2/91)	16.5% (15/91)	70.3% (64/91)	11.0% (10/91)	0.0% (0/91)	0.0% (0/91)	0.0% (0/91)	0.0% (0/91)

Table 54. Overall concurrence of YSI™* values and SG readings using YSI™* ranges on FST Day 1; Calibration 3 or 4 times a day, Abdomen (continued)

Percent of Matched Pairs-in Each SG Glucose Range for Each YSI™* Glucose Range												
YSI™* Glucose Ranges (mg/dL)	Number of Paired SG-YSI™* *	SG (mg/dL)										
		<40	≥40-60	>60-80	>80-120	>120-160	>160-200	>200-250	>250-300	>300-350	>350-400	>400
G) >200-250	76	0.0% (0/76)	0.0% (0/76)	0.0% (0/76)	0.0% (0/76)	1.3% (1/76)	27.6% (21/76)	68.4% (52/76)	2.6% (2/76)	0.0% (0/76)	0.0% (0/76)	0.0% (0/76)
H) >250-300	31	0.0% (0/31)	0.0% (0/31)	0.0% (0/31)	0.0% (0/31)	0.0% (0/31)	0.0% (0/31)	38.7% (12/31)	58.1% (18/31)	3.2% (1/31)	0.0% (0/31)	0.0% (0/31)
I) >300-350	27	0.0% (0/27)	0.0% (0/27)	0.0% (0/27)	0.0% (0/27)	0.0% (0/27)	0.0% (0/27)	0.0% (0/27)	29.6% (8/27)	70.4% (19/27)	0.0% (0/27)	0.0% (0/27)
J) >350-400	7	0.0% (0/7)	0.0% (0/7)	0.0% (0/7)	0.0% (0/7)	0.0% (0/7)	0.0% (0/7)	0.0% (0/7)	0.0% (0/7)	57.1% (4/7)	42.9% (3/7)	0.0% (0/7)

Note: The overall number of available paired SG-YSI™* points on FST Day 1 was from 15 subjects.

Table 55. Overall concurrence of YSI™* values and SG readings using YSI™* ranges on FST Days 1, 3, and 7; Calibration every 12 hours, Buttock

Percent of Matched Pairs-in Each SG Glucose Range for Each YSI™* Glucose Range												
YSI™* Glucose Ranges (mg/dL)	Number of Paired SG-YSI™* *	SG (mg/dL)										
		<40	≥40-60	>60-80	>80-120	>120-160	>160-200	>200-250	>250-300	>300-350	>350-400	>400
B) ≥40-60	11	36.4% (4/11)	63.6% (7/11)	0.0% (0/11)	0.0% (0/11)	0.0% (0/11)	0.0% (0/11)	0.0% (0/11)	0.0% (0/11)	0.0% (0/11)	0.0% (0/11)	0.0% (0/11)
C) >60-80	37	8.1% (3/37)	24.3% (9/37)	43.2% (16/37)	24.3% (9/37)	0.0% (0/37)	0.0% (0/37)	0.0% (0/37)	0.0% (0/37)	0.0% (0/37)	0.0% (0/37)	0.0% (0/37)
D) >80-120	156	0.6% (1/156)	5.1% (8/156)	9.0% (14/156)	75.6% (118/156)	9.6% (15/156)	0.0% (0/156)	0.0% (0/156)	0.0% (0/156)	0.0% (0/156)	0.0% (0/156)	0.0% (0/156)
E) >120-160	170	0.0% (0/170)	0.0% (0/170)	2.9% (5/170)	16.5% (28/170)	67.6% (115/170)	12.9% (22/170)	0.0% (0/170)	0.0% (0/170)	0.0% (0/170)	0.0% (0/170)	0.0% (0/170)
F) >160-200	144	0.0% (0/144)	0.0% (0/144)	0.0% (0/144)	0.0% (0/144)	16.0% (23/144)	75.7% (109/144)	8.3% (12/144)	0.0% (0/144)	0.0% (0/144)	0.0% (0/144)	0.0% (0/144)
G) >200-250	130	0.0% (0/130)	0.0% (0/130)	0.0% (0/130)	0.0% (0/130)	2.3% (3/130)	38.5% (50/130)	56.2% (73/130)	3.1% (4/130)	0.0% (0/130)	0.0% (0/130)	0.0% (0/130)
H) >250-300	49	0.0% (0/49)	0.0% (0/49)	0.0% (0/49)	0.0% (0/49)	0.0% (0/49)	0.0% (0/49)	40.8% (20/49)	53.1% (26/49)	6.1% (3/49)	0.0% (0/49)	0.0% (0/49)

Table 55. Overall concurrence of YSI™* values and SG readings using YSI™* ranges on FST Days 1, 3, and 7; Calibration every 12 hours, Buttock (continued)

Percent of Matched Pairs-in Each SG Glucose Range for Each YSI™* Glucose Range													
YSI™* Glucose Ranges (mg/dL)	Number of Paired SG-YSI™* *	SG (mg/dL)											
		<40	≥40-60	>60-80	>80-120	>120-160	>160-200	>200-250	>250-300	>300-350	>350-400	>400	
I) >300-350	15	0.0% (0/15)	0.0% (0/15)	0.0% (0/15)	0.0% (0/15)	0.0% (0/15)	0.0% (0/15)	0.0% (0/15)	0.0% (0/15)	33.3% (5/15)	60.0% (9/15)	6.7% (1/15)	0.0% (0/15)
J) >350-400	6	0.0% (0/6)	0.0% (0/6)	0.0% (0/6)	0.0% (0/6)	0.0% (0/6)	0.0% (0/6)	0.0% (0/6)	0.0% (0/6)	0.0% (0/6)	50.0% (3/6)	50.0% (3/6)	0.0% (0/6)

Table 56. Overall concurrence of YSI™* values and SG readings using YSI™* ranges on FST Day 1; Calibration every 12 hours, Buttock

Percent of Matched Pairs-in Each SG Glucose Range for Each YSI™* Glucose Range													
YSI™* Glucose Ranges (mg/dL)	Number of Paired SG-YSI™* *	SG (mg/dL)											
		<40	≥40-60	>60-80	>80-120	>120-160	>160-200	>200-250	>250-300	>300-350	>350-400	>400	
B) ≥40-60	4	100.0% (4/4)	0.0% (0/4)	0.0% (0/4)	0.0% (0/4)	0.0% (0/4)	0.0% (0/4)	0.0% (0/4)	0.0% (0/4)	0.0% (0/4)	0.0% (0/4)	0.0% (0/4)	0.0% (0/4)
C) >60-80	22	13.6% (3/22)	27.3% (6/22)	31.8% (7/22)	27.3% (6/22)	0.0% (0/22)	0.0% (0/22)	0.0% (0/22)	0.0% (0/22)	0.0% (0/22)	0.0% (0/22)	0.0% (0/22)	0.0% (0/22)
D) >80-120	68	1.5% (1/68)	11.8% (8/68)	13.2% (9/68)	58.8% (40/68)	14.7% (10/68)	0.0% (0/68)	0.0% (0/68)	0.0% (0/68)	0.0% (0/68)	0.0% (0/68)	0.0% (0/68)	0.0% (0/68)
E) >120-160	74	0.0% (0/74)	0.0% (0/74)	6.8% (5/74)	23.0% (17/74)	56.8% (42/74)	13.5% (10/74)	0.0% (0/74)	0.0% (0/74)	0.0% (0/74)	0.0% (0/74)	0.0% (0/74)	0.0% (0/74)
F) >160-200	76	0.0% (0/76)	0.0% (0/76)	0.0% (0/76)	0.0% (0/76)	18.4% (14/76)	72.4% (55/76)	9.2% (7/76)	0.0% (0/76)	0.0% (0/76)	0.0% (0/76)	0.0% (0/76)	0.0% (0/76)
G) >200-250	67	0.0% (0/67)	0.0% (0/67)	0.0% (0/67)	0.0% (0/67)	3.0% (2/67)	19.4% (13/67)	73.1% (49/67)	4.5% (3/67)	0.0% (0/67)	0.0% (0/67)	0.0% (0/67)	0.0% (0/67)
H) >250-300	27	0.0% (0/27)	0.0% (0/27)	0.0% (0/27)	0.0% (0/27)	0.0% (0/27)	0.0% (0/27)	44.4% (12/27)	48.1% (13/27)	7.4% (2/27)	0.0% (0/27)	0.0% (0/27)	0.0% (0/27)
I) >300-350	3	0.0% (0/3)	0.0% (0/3)	0.0% (0/3)	0.0% (0/3)	0.0% (0/3)	0.0% (0/3)	0.0% (0/3)	0.0% (0/3)	100.0% (3/3)	0.0% (0/3)	0.0% (0/3)	0.0% (0/3)
J) >350-400	2	0.0% (0/2)	0.0% (0/2)	0.0% (0/2)	0.0% (0/2)	0.0% (0/2)	0.0% (0/2)	0.0% (0/2)	0.0% (0/2)	50.0% (1/2)	50.0% (1/2)	0.0% (0/2)	0.0% (0/2)

Note: The overall number of available paired SG-YSI™* points on FST Day 1 was from 14 subjects.

Table 57. Overall concurrence of YSI™ values and SG readings using YSI™ ranges on FST Days 1, 3, and 7; Calibration 3 or 4 times a day, Buttock

Percent of Matched Pairs-in Each SG Glucose Range for Each YSI™ Glucose Range												
YSI™ Glucose Ranges (mg/dL)	Number of Paired SG-YSI™ *	SG (mg/dL)										
		<40	≥40-60	>60-80	>80-120	>120-160	>160-200	>200-250	>250-300	>300-350	>350-400	>400
B) ≥40-60	11	36.4% (4/11)	63.6% (7/11)	0.0% (0/11)	0.0% (0/11)	0.0% (0/11)	0.0% (0/11)	0.0% (0/11)	0.0% (0/11)	0.0% (0/11)	0.0% (0/11)	0.0% (0/11)
C) >60-80	30	6.7% (2/30)	10.0% (3/30)	50.0% (15/30)	33.3% (10/30)	0.0% (0/30)	0.0% (0/30)	0.0% (0/30)	0.0% (0/30)	0.0% (0/30)	0.0% (0/30)	0.0% (0/30)
D) >80-120	144	0.7% (1/144)	1.4% (2/144)	7.6% (11/144)	80.6% (116/144)	9.7% (14/144)	0.0% (0/144)	0.0% (0/144)	0.0% (0/144)	0.0% (0/144)	0.0% (0/144)	0.0% (0/144)
E) >120-160	164	0.0% (0/164)	0.0% (0/164)	1.8% (3/164)	16.5% (27/164)	67.1% (110/164)	14.0% (23/164)	0.6% (1/164)	0.0% (0/164)	0.0% (0/164)	0.0% (0/164)	0.0% (0/164)
F) >160-200	140	0.0% (0/140)	0.0% (0/140)	0.0% (0/140)	0.0% (0/140)	14.3% (20/140)	75.0% (105/140)	10.7% (15/140)	0.0% (0/140)	0.0% (0/140)	0.0% (0/140)	0.0% (0/140)
G) >200-250	127	0.0% (0/127)	0.0% (0/127)	0.0% (0/127)	0.0% (0/127)	1.6% (2/127)	42.5% (54/127)	51.2% (65/127)	4.7% (6/127)	0.0% (0/127)	0.0% (0/127)	0.0% (0/127)
H) >250-300	53	0.0% (0/53)	0.0% (0/53)	0.0% (0/53)	0.0% (0/53)	0.0% (0/53)	0.0% (0/53)	41.5% (22/53)	39.6% (21/53)	17.0% (9/53)	1.9% (1/53)	0.0% (0/53)
I) >300-350	18	0.0% (0/18)	0.0% (0/18)	0.0% (0/18)	0.0% (0/18)	0.0% (0/18)	0.0% (0/18)	0.0% (0/18)	38.9% (7/18)	38.9% (7/18)	22.2% (4/18)	0.0% (0/18)
J) >350-400	6	0.0% (0/6)	0.0% (0/6)	0.0% (0/6)	0.0% (0/6)	0.0% (0/6)	0.0% (0/6)	0.0% (0/6)	0.0% (0/6)	16.7% (1/6)	83.3% (5/6)	0.0% (0/6)

Table 58. Overall concurrence of YSI™ values and SG readings using YSI™ ranges on FST Day 1; Calibration 3 or 4 times a day, Buttock

Percent of Matched Pairs-in Each SG Glucose Range for Each YSI™ Glucose Range												
YSI™ Glucose Ranges (mg/dL)	Number of Paired SG-YSI™ *	SG (mg/dL)										
		<40	≥40-60	>60-80	>80-120	>120-160	>160-200	>200-250	>250-300	>300-350	>350-400	>400
B) ≥40-60	4	100.0% (4/4)	0.0% (0/4)	0.0% (0/4)	0.0% (0/4)	0.0% (0/4)	0.0% (0/4)	0.0% (0/4)	0.0% (0/4)	0.0% (0/4)	0.0% (0/4)	0.0% (0/4)
C) >60-80	15	13.3% (2/15)	0.0% (0/15)	40.0% (6/15)	46.7% (7/15)	0.0% (0/15)	0.0% (0/15)	0.0% (0/15)	0.0% (0/15)	0.0% (0/15)	0.0% (0/15)	0.0% (0/15)
D) >80-120	56	1.8% (1/56)	3.6% (2/56)	12.5% (7/56)	66.1% (37/56)	16.1% (9/56)	0.0% (0/56)	0.0% (0/56)	0.0% (0/56)	0.0% (0/56)	0.0% (0/56)	0.0% (0/56)
E) >120-160	68	0.0% (0/68)	0.0% (0/68)	4.4% (3/68)	25.0% (17/68)	57.4% (39/68)	13.2% (9/68)	0.0% (0/68)	0.0% (0/68)	0.0% (0/68)	0.0% (0/68)	0.0% (0/68)

Table 58. Overall concurrence of YSI™* values and SG readings using YSI™* ranges on FST Day 1; Calibration 3 or 4 times a day, Buttock (continued)

Percent of Matched Pairs-in Each SG Glucose Range for Each YSI™* Glucose Range												
YSI™* Glucose Ranges (mg/dL)	Number of Paired SG-YSI™* *	SG (mg/dL)										
		<40	≥40-60	>60-80	>80-120	>120-160	>160-200	>200-250	>250-300	>300-350	>350-400	>400
F) >160-200	72	0.0% (0/72)	0.0% (0/72)	0.0% (0/72)	0.0% (0/72)	15.3% (11/72)	75.0% (54/72)	9.7% (7/72)	0.0% (0/72)	0.0% (0/72)	0.0% (0/72)	0.0% (0/72)
G) >200-250	64	0.0% (0/64)	0.0% (0/64)	0.0% (0/64)	0.0% (0/64)	1.6% (1/64)	29.7% (19/64)	62.5% (40/64)	6.3% (4/64)	0.0% (0/64)	0.0% (0/64)	0.0% (0/64)
H) >250-300	31	0.0% (0/31)	0.0% (0/31)	0.0% (0/31)	0.0% (0/31)	0.0% (0/31)	0.0% (0/31)	45.2% (14/31)	29.0% (9/31)	22.6% (7/31)	3.2% (1/31)	0.0% (0/31)
I) >300-350	6	0.0% (0/6)	0.0% (0/6)	0.0% (0/6)	0.0% (0/6)	0.0% (0/6)	0.0% (0/6)	0.0% (0/6)	50.0% (3/6)	50.0% (3/6)	0.0% (0/6)	0.0% (0/6)
J) >350-400	2	0.0% (0/2)	0.0% (0/2)	0.0% (0/2)	0.0% (0/2)	0.0% (0/2)	0.0% (0/2)	0.0% (0/2)	0.0% (0/2)	50.0% (1/2)	50.0% (1/2)	0.0% (0/2)

Note: The overall number of available paired SG-YSI™* points on FST Day 1 was from 13 subjects.

Percent Agreement Post Calibration

The agreement of the SG values to paired YSI™* values was assessed for every 2-hour period post sensor calibration. For readings less than or equal to 80 mg/dL, the absolute difference in mg/dL between the SG and paired YSI™* values was calculated.

Table 59 through Table 62 show the percent agreement rates post calibration for sensors inserted into the abdomen and buttock.

Table 59. Agreement rates for every 2-hour period post calibration period; Calibration every 12 hours, Abdomen

Time after cali- bration	Number of paired YSI™*- sensor points	Percentage (%) Agreement				
		±15% (±15 mg/dL)	±20% (±20 mg/dL)	±30% (±30 mg/dL)	±40% (±40 mg/dL)	>±40% (±40 mg/dL)
0-2 hours	224	84.4	93.3	98.7	99.6	0.4
2-4 hours	181	77.9	85.1	94.5	98.3	1.7
4-6 hours	145	72.4	84.1	94.5	98.6	1.4
6-8 hours	77	74	83.1	97.4	100	0
8-10 hours	52	80.8	82.7	86.5	96.2	3.8
10-12 hours	54	81.5	94.4	100	100	0

Table 60. Agreement rates for every 2-hour period post calibration; Calibration 3 or 4 times a day, Abdomen

Time after calibration	Number of paired YSI™*-sensor points	Percentage (%) Agreement				
		±15% (±15 mg/dL)	±20% (±20 mg/dL)	±30% (±30 mg/dL)	±40% (±40 mg/dL)	>±40% (±40 mg/dL)
0-2 hours	360	83.3	90.8	97.8	99.4	0.6
2-4 hours	174	83.9	92.5	98.3	100	0
4-6 hours	53	75.5	90.6	98.1	100	0
6-8 hours	64	73.4	82.8	96.9	100	0
8-10 hours	36	75	77.8	83.3	94.4	5.6
10-12 hours	23	87	95.7	100	100	0

Table 61. Agreement rates for every 2-hour period post calibration period; Calibration every 12 hours, Buttock

Time after calibration	Number of paired YSI™*-sensor points	Percentage (%) Agreement				
		±15% (±15 mg/dL)	±20% (±20 mg/dL)	±30% (±30 mg/dL)	±40% (±40 mg/dL)	>±40% (±40 mg/dL)
0-2 hours	196	81.6	94.9	96.4	98.5	1.5
2-4 hours	195	78.5	85.1	92.8	96.9	3.1
4-6 hours	157	87.9	91.1	99.4	99.4	0.6
6-8 hours	76	96.1	100	100	100	0
8-10 hours	45	97.8	100	100	100	0
10-12 hours	41	82.9	95.1	97.6	100	0

Table 62. Agreement rates for every 2-hour period post calibration period; Calibration 3 or 4 times a day, Buttock

Time after calibration	Number of paired YSI™*-sensor points	Percentage (%) Agreement				
		±15% (±15 mg/dL)	±20% (±20 mg/dL)	±30% (±30 mg/dL)	±40% (±40 mg/dL)	>±40% (±40 mg/dL)
0-2 hours	314	81.8	92.4	95.9	98.1	1.9
2-4 hours	195	79.5	88.2	96.4	100	0
4-6 hours	70	94.3	95.7	100	100	0
6-8 hours	52	94.2	100	100	100	0
8-10 hours	37	100	100	100	100	0
10-12 hours	18	94.4	100	100	100	0

Trend accuracy

Tables E-26 through E-29 show, for each SG rate-of-change range (indicated on display by number of arrows), percentage of SG-YSI™* paired values that fell into different YSI™* rate-of-change ranges. The tables show the trend accuracy for sensors inserted into the abdomen or buttock.

Table 63. Trend Accuracy; Calibration every 12 hours, Abdomen

Percent of Matched Pairs-in Each YSI™ Rate Range for Each SG Rate Range							
SG Rate Ranges (mg/dL/min)	Numbered of Paired SG-YSI™	YSI™ (mg/dL/min)					
		<-2	[-2, -1]	[-1, 0]	[0, 1]	[1, 2]	>2
<-2	19	47.4% (9/19)	47.4% (9/19)	0.0% (0/19)	5.3% (1/19)	0.0% (0/19)	0.0% (0/19)
[-2, -1]	107	2.8% (3/107)	31.8% (34/107)	60.7% (65/107)	3.7% (4/107)	0.9% (1/107)	0.0% (0/107)
[-1, 0]	276	0.7% (2/276)	5.8% (16/276)	71.7% (198/276)	21.0% (58/276)	0.7% (2/276)	0.0% (0/276)
[0, 1]	209	0.0% (0/209)	1.0% (2/209)	22.5% (47/209)	62.2% (130/209)	13.9% (29/209)	0.5% (1/209)
[1, 2]	98	0.0% (0/98)	0.0% (0/98)	1.0% (1/98)	37.8% (37/98)	59.2% (58/98)	2.0% (2/98)
>2	23	0.0% (0/23)	0.0% (0/23)	4.3% (1/23)	8.7% (2/23)	30.4% (7/23)	56.5% (13/23)

Table 64. Trend Accuracy; Calibration 3 or 4 times a day, Abdomen

Percent of Matched Pairs-in Each YSI™ Rate Range for Each SG Rate Range							
SG Rate Ranges (mg/dL/min)	Numbered of Paired SG-YSI™	YSI™ (mg/dL/min)					
		<-2	[-2, -1]	[-1, 0]	[0, 1]	[1, 2]	>2
<-2	17	41.2% (7/17)	47.1% (8/17)	5.9% (1/17)	5.9% (1/17)	0.0% (0/17)	0.0% (0/17)
[-2, -1]	105	2.9% (3/105)	32.4% (34/105)	60.0% (63/105)	3.8% (4/105)	1.0% (1/105)	0.0% (0/105)
[-1, 0]	273	0.4% (1/273)	6.2% (17/273)	72.5% (198/273)	20.1% (55/273)	0.7% (2/273)	0.0% (0/273)
[0, 1]	199	0.5% (1/199)	0.5% (1/199)	22.6% (45/199)	63.3% (126/199)	12.6% (25/199)	0.5% (1/199)
[1, 2]	98	0.0% (0/98)	0.0% (0/98)	2.0% (2/98)	36.7% (36/98)	59.2% (58/98)	2.0% (2/98)
>2	17	0.0% (0/17)	0.0% (0/17)	5.9% (1/17)	11.8% (2/17)	41.2% (7/17)	41.2% (7/17)

Table 65. Trend Accuracy; Calibration every 12 hours, Buttock

Percent of Matched Pairs-in Each YSI™ Rate Range for Each SG Rate Range							
SG Rate Ranges (mg/dL/min)	Numbered of Paired SG-YSI™	YSI™ (mg/dL/min)					
		<-2	[-2, -1]	[-1, 0]	[0, 1]	[1, 2]	>2
<-2	35	37.1% (13/35)	45.7% (16/35)	17.1% (6/35)	0.0% (0/35)	0.0% (0/35)	0.0% (0/35)
[-2, -1]	83	7.2% (6/83)	31.3% (26/83)	59.0% (49/83)	2.4% (2/83)	0.0% (0/83)	0.0% (0/83)
[-1, 0]	272	0.0% (0/272)	4.8% (13/272)	69.9% (190/272)	21.7% (59/272)	2.9% (8/272)	0.7% (2/272)
[0, 1]	199	0.0% (0/199)	0.5% (1/199)	22.1% (44/199)	60.8% (121/199)	15.6% (31/199)	1.0% (2/199)
[1, 2]	97	0.0% (0/97)	0.0% (0/97)	4.1% (4/97)	36.1% (35/97)	54.6% (53/97)	5.2% (5/97)
>2	23	0.0% (0/23)	0.0% (0/23)	0.0% (0/23)	26.1% (6/23)	34.8% (8/23)	39.1% (9/23)

Table 66. Trend Accuracy; Calibration 3 or 4 times a day, Buttock

Percent of Matched Pairs-in Each YSI™ Rate Range for Each SG Rate Range							
SG Rate Ranges (mg/dL/min)	Numbered of Paired SG-YSI™	YSI™ (mg/dL/min)					
		<-2	[-2, -1]	[-1, 0]	[0, 1]	[1, 2]	>2
<-2	31	41.9% (13/31)	38.7% (12/31)	19.4% (6/31)	0.0% (0/31)	0.0% (0/31)	0.0% (0/31)
[-2, -1]	83	7.2% (6/83)	32.5% (27/83)	56.6% (47/83)	3.6% (3/83)	0.0% (0/83)	0.0% (0/83)
[-1, 0]	261	0.0% (0/261)	5.0% (13/261)	71.6% (187/261)	21.1% (55/261)	2.3% (6/261)	0.0% (0/261)
[0, 1]	194	0.0% (0/194)	0.5% (1/194)	22.2% (43/194)	62.9% (122/194)	13.4% (26/194)	1.0% (2/194)
[1, 2]	94	0.0% (0/94)	0.0% (0/94)	4.3% (4/94)	36.2% (34/94)	56.4% (53/94)	3.2% (3/94)
>2	22	0.0% (0/22)	0.0% (0/22)	0.0% (0/22)	22.7% (5/22)	36.4% (8/22)	40.9% (9/22)

Precision

Precision of the system was evaluated by comparing the results from two separate sensors worn on the same subject at the same time.

Data from two sensors worn at the same time for 11 subjects, both inserted in the abdomen, provided 772 pairs of CGM measurements, with a mean PARD during the study of 7.83% and a coefficient of variation (%CV) of 5.7%.

Data from two sensors worn at the same time for 18 subjects, one inserted in the abdomen and one in the buttock, provided 1302 pairs of CGM measurements, with a mean PARD during the study of 11.33% and a coefficient of variation (%CV) of 7.8%.

Data from two sensors worn at the same time for 10 subjects, both inserted in the buttock, provided 695 pairs of CGM measurements, with a mean PARD during the study of 10.93% and a coefficient of variation (%CV) of 8.1%.

Sensor life

After the first successful calibration, 70.0% of sensors worn in the buttock functioned more than six days and up to the full seven days of wear (144 to 168 hours). The median functional sensor life for sensors worn in the buttock insertion site over the course of the study was 158.1 hours, with a mean functional life of 142.7 hours.

After the first successful calibration, 42.5% of sensors worn in the abdomen functioned more than six days and up to the full seven days of wear (144 to 168 hours). The median functional sensor life for sensors worn in the abdomen insertion site over the course of the study was 128.4 hours, with a mean functional life of 122.1 hours.

Safety

There were no moderate or severe device-related or procedure-related adverse events, device-related or procedure-related serious adverse events, or unanticipated adverse device effects through seven days of use.

F. Alert performance for user ages 7 through 13

The CGM system enables your device to display SG readings, glucose trend arrows, glucose trend graphs, and SG alerts (for example, High and Low Limit Threshold alerts, High and Low Predictive alerts, and Rise and Fall rate-of-change alerts).

The high and low limit alerts (Threshold alerts) let the user know when the SG is at or above the high limit or at or below the low limit. Using only a high or low limit alert may reduce the number of false alerts, but does not provide a warning before reaching a high or low limit. The default alert thresholds are highlighted in gray in the tables below.

Predictive alerts notify users that their SG level may soon reach a high or low limit setting. Users may select how early they would like to be notified before their SG level reaches a high limit setting. The earliest warning is 30 minutes before reaching a high, but users can reduce the amount of warning down to 5 minutes. Users will receive a warning approximately 30 minutes prior to when their SG level is predicted to reach their low limit setting. In general, the earlier the warning, the more time a user will have to react to a potential high or low, but this also increases the potential for false alerts.

A predictive alert is simply an estimation of a future SG level compared to the high or low limit setting. If the predicted SG value is above the high limit or below the low limit, then a predictive alert is sounded even though the current SG level has not crossed the high or low limit. The predicted SG level is calculated using the current SG level, the derivative of previous SG readings (the trend or slope of the SG readings) and the amount of early warning duration the user selects.

The device will always alert the user when the CGM system reads that the user is below 50 mg/dL, regardless of the high threshold, low threshold, or predictive alerts that the user sets.

Glucose TRUE Alert Rate

The glucose true alert rate is the rate at which the blood glucose (BG) confirmed that the CGM alert was triggered correctly. For example

True Threshold Hypoglycemic alert rate alerted when the CGM system read that the user was below the low threshold and the user's BG was actually below that low threshold.

True Threshold Hyperglycemic alert rate alerted when the CGM system read that the user was above the high threshold and the user's BG was actually above that high threshold.

True Predictive Hypoglycemic alert rate alerted when the CGM system predicted that the user would reach below the low threshold and the user's BG was actually below that low threshold within 15 or 30 minutes.

True Predictive Hyperglycemic alert rate alerted when the CGM system predicted that the user would reach above the high threshold and the user's BG was actually above that high threshold within 15 or 30 minutes.

The true alert rate is important because it is necessary that users be notified when their BG is low (or high) so that they can correct the low (or high) BG. A high true alert rate indicates that when the CGM system says that their glucose values are, or will reach a specified threshold, the user's BG is likely to be at or approaching that threshold.

For example, per the following table, when wearing the sensor in the abdomen, the low glucose alerts would have correctly indicated that the user was below (i.e. threshold only), or predicted to reach below the threshold (i.e. predictive only), or both (predictive and threshold) 44.4%, 28.6%, or 36.4% of the time within 30 minutes (or 44.4%, 14.3%, or 27.3% of the time within 15 minutes) when the user had BG values lower than 70 mg/dL.

Table 67. Glucose TRUE Alert Performance using Calibration every 12 hours

mg/dL	Insertion Site	Glucose TRUE Alert Rate					
		Threshold Only		Predictive Only		Threshold & Predictive	
		30 min	15 min	30 min	15 min	30 min	15 min
50	Abdomen	33.3% (1/3)	33.3% (1/3)	12.5% (1/8)	12.5% (1/8)	18.2% (2/11)	18.2% (2/11)
	Buttock	25.0% (1/4)	25.0% (1/4)	11.1% (1/9)	11.1% (1/9)	16.7% (2/12)	16.7% (2/12)
54	Abdomen	25.0% (1/4)	25.0% (1/4)	-	-	-	-
	Buttock	20.0% (1/5)	20.0% (1/5)	-	-	-	-
60*	Abdomen	25.0% (1/4)	25.0% (1/4)	8.3% (1/12)	8.3% (1/12)	12.5% (2/16)	12.5% (2/16)
	Buttock	60.0% (3/5)	60.0% (3/5)	25.0% (3/12)	16.7% (2/12)	35.3% (6/17)	29.4% (5/17)
70	Abdomen	44.4% (4/9)	44.4% (4/9)	28.6% (4/14)	14.3% (2/14)	36.4% (8/22)	27.3% (6/22)
	Buttock	60.0% (6/10)	60.0% (6/10)	36.8% (7/19)	26.3% (5/19)	40.7% (11/27)	33.3% (9/27)
80	Abdomen	33.3% (4/12)	33.3% (4/12)	31.6% (6/19)	15.8% (3/19)	32.3% (10/31)	22.6% (7/31)
	Buttock	61.1% (11/18)	61.1% (11/18)	46.2% (12/26)	38.5% (10/26)	51.2% (22/43)	46.5% (20/43)
90	Abdomen	55.0% (11/20)	55.0% (11/20)	46.2% (12/26)	30.8% (8/26)	47.7% (21/44)	38.6% (17/44)
	Buttock	70.8% (17/24)	70.8% (17/24)	58.3% (21/36)	44.4% (16/36)	62.5% (35/56)	53.6% (30/56)
180	Abdomen	78.4% (40/51)	78.4% (40/51)	66.2% (47/71)	66.2% (47/71)	70.5% (79/112)	70.5% (79/112)
	Buttock	83.3% (40/48)	81.3% (39/48)	64.3% (45/70)	62.9% (44/70)	70.6% (77/109)	68.8% (75/109)
220	Abdomen	87.5% (21/24)	87.5% (21/24)	60.0% (27/45)	57.8% (26/45)	68.2% (45/66)	66.7% (44/66)
	Buttock	75.0% (21/28)	75.0% (21/28)	51.0% (25/49)	49.0% (24/49)	58.3% (42/72)	56.9% (41/72)
250	Abdomen	81.3% (13/16)	81.3% (13/16)	53.1% (17/32)	46.9% (15/32)	63.0% (29/46)	58.7% (27/46)
	Buttock	73.3% (11/15)	73.3% (11/15)	41.2% (14/34)	35.3% (12/34)	50.0% (23/46)	45.7% (21/46)

Table 67. Glucose TRUE Alert Performance using Calibration every 12 hours
(continued)

mg/dL	Insertion Site	Glucose TRUE Alert Rate					
		Threshold Only		Predictive Only		Threshold & Predictive	
		30 min	15 min	30 min	15 min	30 min	15 min
300	Abdomen	77.8% (7/9)	77.8% (7/9)	44.4% (8/18)	44.4% (8/18)	55.6% (15/27)	55.6% (15/27)
	Buttock	57.1% (4/7)	57.1% (4/7)	31.3% (5/16)	31.3% (5/16)	38.1% (8/21)	38.1% (8/21)

Note: Given the small sample size of data available in the low range, the alert performance in the 50 mg/dL and 60 mg/dL should be interpreted with caution and may not reflect actual use performance.

*The default alert threshold is highlighted in gray.

Glucose FALSE Alert Rate

The glucose false alert rate is the rate at which the BG did not confirm that the CGM alert was triggered correctly. For example:

False Threshold Hypoglycemic alert rate alerted when the CGM system read that the user was below the low threshold but the user's BG was actually above that low threshold.

False Threshold Hyperglycemic alert rate alerted when the CGM system read that the user was above the high threshold but the user's BG was actually below that high threshold.

False Predictive Hypoglycemic alert rate alerted when the CGM system predicted that the user would be below the low threshold but the user's BG was actually above that low threshold within 15 or 30 minutes.

The false alert rate is important because it is necessary that users be correctly notified when their BG is low (or high) so that they can correct the low (or high) BG. A low false alert rate indicates that when the CGM system says that their glucose values are, or will reach a specified threshold, the user's BG is likely to be at or approaching that threshold.

For example, per the following table, when wearing the sensor in the abdomen, the high glucose threshold alerts would have incorrectly indicated that the user was above (i.e. threshold only), or predicted to reach above the threshold (i.e. predictive only), or both (threshold and predictive) 21.6%, 33.8%, or 29.5% of the time within 30 minutes (or 21.6%, 33.8%, or 29.5% of the time within 15 minutes) when the user had BG less than 180 mg/dL.

Table 68. Glucose FALSE Alert Performance using Calibration every 12 hours

mg/dL	Insertion Site	Glucose FALSE Alert Rate					
		Threshold Only		Predictive Only		Threshold & Predictive	
		30 min	15 min	30 min	15 min	30 min	15 min
50	Abdomen	66.7% (2/3)	66.7% (2/3)	87.5% (7/8)	87.5% (7/8)	81.8% (9/11)	81.8% (9/11)
	Buttock	75.0% (3/4)	75.0% (3/4)	88.9% (8/9)	88.9% (8/9)	83.3% (10/12)	83.3% (10/12)
54	Abdomen	75.0% (3/4)	75.0% (3/4)	-	-	-	-
	Buttock	80.0% (4/5)	80.0% (4/5)	-	-	-	-
60*	Abdomen	75.0% (3/4)	75.0% (3/4)	91.7% (11/12)	91.7% (11/12)	87.5% (14/16)	87.5% (14/16)
	Buttock	40.0% (2/5)	40.0% (2/5)	75.0% (9/12)	83.3% (10/12)	64.7% (11/17)	70.6% (12/17)
70	Abdomen	55.6% (5/9)	55.6% (5/9)	71.4% (10/14)	85.7% (12/14)	63.6% (14/22)	72.7% (16/22)
	Buttock	40.0% (4/10)	40.0% (4/10)	63.2% (12/19)	73.7% (14/19)	59.3% (16/27)	66.7% (18/27)
80	Abdomen	66.7% (8/12)	66.7% (8/12)	68.4% (13/19)	84.2% (16/19)	67.7% (21/31)	77.4% (24/31)
	Buttock	38.9% (7/18)	38.9% (7/18)	53.8% (14/26)	61.5% (16/26)	48.8% (21/43)	53.5% (23/43)
90	Abdomen	45.0% (9/20)	45.0% (9/20)	53.8% (14/26)	69.2% (18/26)	52.3% (23/44)	61.4% (27/44)
	Buttock	29.2% (7/24)	29.2% (7/24)	41.7% (15/36)	55.6% (20/36)	37.5% (21/56)	46.4% (26/56)
180	Abdomen	21.6% (11/51)	21.6% (11/51)	33.8% (24/71)	33.8% (24/71)	29.5% (33/112)	29.5% (33/112)
	Buttock	16.7% (8/48)	18.8% (9/48)	35.7% (25/70)	37.1% (26/70)	29.4% (32/109)	31.2% (34/109)
220	Abdomen	12.5% (3/24)	12.5% (3/24)	40.0% (18/45)	42.2% (19/45)	31.8% (21/66)	33.3% (22/66)
	Buttock	25.0% (7/28)	25.0% (7/28)	49.0% (24/49)	51.0% (25/49)	41.7% (30/72)	43.1% (31/72)
250	Abdomen	18.8% (3/16)	18.8% (3/16)	46.9% (15/32)	53.1% (17/32)	37.0% (17/46)	41.3% (19/46)
	Buttock	26.7% (4/15)	26.7% (4/15)	58.8% (20/34)	64.7% (22/34)	50.0% (23/46)	54.3% (25/46)
300	Abdomen	22.2% (2/9)	22.2% (2/9)	55.6% (10/18)	55.6% (10/18)	44.4% (12/27)	44.4% (12/27)
	Buttock	42.9% (3/7)	42.9% (3/7)	68.8% (11/16)	68.8% (11/16)	61.9% (13/21)	61.9% (13/21)

Note: Given the small sample size of data available in the low range, the alert performance in the 50 mg/dL and 60 mg/dL should be interpreted with caution and may not reflect actual use performance.

*The default alert threshold is highlighted in gray.

Glucose Correct Detection Rate

Glucose Correct Detection Rate is the rate that the device alerted when it should have alerted. For example, the BG was below the hypoglycemic threshold, or above the hyperglycemic threshold, and the device sounded an alert.

Glucose detection rates are important because it is necessary that users be notified when their BG is low (or high) so that they can correct the low (or high) BG. A high glucose correct detection rate indicates that users can have confidence that they will be notified by the device if their BG is low or high.

For example, per the following table, when wearing the sensor in the abdomen, the threshold alert, the predictive alert, or both (threshold and predictive) notified the user 100%, 100%, or 100% of the time within 30 minutes (or 100%, 100%, or 100% within 15 minutes) when the user had BG less than 50 mg/dL.

Table 69. Glucose Correct Detection Alert Performance using Calibration every 12 hours

mg/dL	Insertion Site	Glucose Correct Detection Rate					
		Threshold Only		Predictive Only		Threshold & Predictive	
		30 min	15 min	30 min	15 min	30 min	15 min
50	Abdomen	100.0% (1/1)	100.0% (1/1)	100.0% (1/1)	100.0% (1/1)	100.0% (1/1)	100.0% (1/1)
	Buttock	100.0% (1/1)	100.0% (1/1)	100.0% (1/1)	100.0% (1/1)	100.0% (1/1)	100.0% (1/1)
54	Abdomen	100.0% (1/1)	100.0% (1/1)	-	-	-	-
	Buttock	100.0% (1/1)	100.0% (1/1)	-	-	-	-
60*	Abdomen	50.0% (1/2)	50.0% (1/2)	50.0% (1/2)	50.0% (1/2)	50.0% (1/2)	50.0% (1/2)
	Buttock	100.0% (3/3)	100.0% (3/3)	100.0% (3/3)	66.7% (2/3)	100.0% (3/3)	100.0% (3/3)
70	Abdomen	80.0% (4/5)	80.0% (4/5)	80.0% (4/5)	40.0% (2/5)	80.0% (4/5)	80.0% (4/5)
	Buttock	85.7% (6/7)	85.7% (6/7)	85.7% (6/7)	71.4% (5/7)	85.7% (6/7)	85.7% (6/7)
80	Abdomen	66.7% (4/6)	66.7% (4/6)	83.3% (5/6)	50.0% (3/6)	83.3% (5/6)	66.7% (4/6)
	Buttock	85.7% (12/14)	85.7% (12/14)	85.7% (12/14)	78.6% (11/14)	85.7% (12/14)	85.7% (12/14)
90	Abdomen	91.7% (11/12)	91.7% (11/12)	91.7% (11/12)	66.7% (8/12)	91.7% (11/12)	91.7% (11/12)
	Buttock	86.4% (19/22)	86.4% (19/22)	90.9% (20/22)	72.7% (16/22)	95.5% (21/22)	86.4% (19/22)
180	Abdomen	95.1% (39/41)	95.1% (39/41)	100.0% (41/41)	100.0% (41/41)	100.0% (41/41)	100.0% (41/41)
	Buttock	97.5% (39/40)	95.0% (38/40)	100.0% (40/40)	100.0% (40/40)	100.0% (40/40)	100.0% (40/40)
220	Abdomen	92.6% (25/27)	85.2% (23/27)	96.3% (26/27)	88.9% (24/27)	96.3% (26/27)	88.9% (24/27)
	Buttock	95.7% (22/23)	95.7% (22/23)	100.0% (23/23)	95.7% (22/23)	100.0% (23/23)	100.0% (23/23)
250	Abdomen	77.8% (14/18)	77.8% (14/18)	88.9% (16/18)	83.3% (15/18)	88.9% (16/18)	83.3% (15/18)
	Buttock	68.8% (11/16)	62.5% (10/16)	100.0% (16/16)	93.8% (15/16)	100.0% (16/16)	100.0% (16/16)
300	Abdomen	80.0% (8/10)	80.0% (8/10)	100.0% (10/10)	90.0% (9/10)	100.0% (10/10)	90.0% (9/10)
	Buttock	60.0% (3/5)	60.0% (3/5)	100.0% (5/5)	100.0% (5/5)	100.0% (5/5)	100.0% (5/5)

Note: Given the small sample size of data available in the low range, the alert performance in the 50 mg/dL and 60 mg/dL should be interpreted with caution and may not reflect actual use performance.

*The default alert threshold is highlighted in gray.

Glucose Missed Detection Rate

The Missed Detection Rate is the rate that the device did not alert when it should have. For example, the BG was below the hypoglycemic threshold, or above the hyperglycemic threshold, and the device did not sound a threshold or predictive alert.

Missed detection rates are important because it is necessary that users be notified when their BG is low (or high), so that they can correct the low (or high) BG. A low missed detection rate indicates that users can have confidence that they will be notified by the device if their BG is low or high.

For example, per the following table, when wearing the sensor in the abdomen, the threshold alert, predictive alert, or both alerts (threshold and predictive) did not sound

0%, 0%, or 0% of the time within 30 minutes (or 0%, 0%, or 0% within 15 minutes) when the user had BG less than 50 mg/dL.

Table 70. Glucose Missed Detection Alert Performance using Calibration every 12 hours

mg/dL	Insertion Site	Glucose Missed Detection Rate					
		Threshold Only		Predictive Only		Threshold & Predictive	
		30 min	15 min	30 min	15 min	30 min	15 min
50	Abdomen	0.0% (0/1)	0.0% (0/1)	0.0% (0/1)	0.0% (0/1)	0.0% (0/1)	0.0% (0/1)
	Buttock	0.0% (0/1)	0.0% (0/1)	0.0% (0/1)	0.0% (0/1)	0.0% (0/1)	0.0% (0/1)
54	Abdomen	0.0% (0/1)	0.0% (0/1)	-	-	-	-
	Buttock	0.0% (0/1)	0.0% (0/1)	-	-	-	-
60*	Abdomen	50.0% (1/2)	50.0% (1/2)	50.0% (1/2)	50.0% (1/2)	50.0% (1/2)	50.0% (1/2)
	Buttock	0.0% (0/3)	0.0% (0/3)	0.0% (0/3)	33.3% (1/3)	0.0% (0/3)	0.0% (0/3)
70	Abdomen	20.0% (1/5)	20.0% (1/5)	20.0% (1/5)	60.0% (3/5)	20.0% (1/5)	20.0% (1/5)
	Buttock	14.3% (1/7)	14.3% (1/7)	14.3% (1/7)	28.6% (2/7)	14.3% (1/7)	14.3% (1/7)
80	Abdomen	33.3% (2/6)	33.3% (2/6)	16.7% (1/6)	50.0% (3/6)	16.7% (1/6)	33.3% (2/6)
	Buttock	14.3% (2/14)	14.3% (2/14)	14.3% (2/14)	21.4% (3/14)	14.3% (2/14)	14.3% (2/14)
90	Abdomen	8.3% (1/12)	8.3% (1/12)	8.3% (1/12)	33.3% (4/12)	8.3% (1/12)	8.3% (1/12)
	Buttock	13.6% (3/22)	13.6% (3/22)	9.1% (2/22)	27.3% (6/22)	4.5% (1/22)	13.6% (3/22)
180	Abdomen	4.9% (2/41)	4.9% (2/41)	0.0% (0/41)	0.0% (0/41)	0.0% (0/41)	0.0% (0/41)
	Buttock	2.5% (1/40)	5.0% (2/40)	0.0% (0/40)	0.0% (0/40)	0.0% (0/40)	0.0% (0/40)
220	Abdomen	7.4% (2/27)	14.8% (4/27)	3.7% (1/27)	11.1% (3/27)	3.7% (1/27)	11.1% (3/27)
	Buttock	4.3% (1/23)	4.3% (1/23)	0.0% (0/23)	4.3% (1/23)	0.0% (0/23)	0.0% (0/23)
250	Abdomen	22.2% (4/18)	22.2% (4/18)	11.1% (2/18)	16.7% (3/18)	11.1% (2/18)	16.7% (3/18)
	Buttock	31.3% (5/16)	37.5% (6/16)	0.0% (0/16)	6.3% (1/16)	0.0% (0/16)	0.0% (0/16)
300	Abdomen	20.0% (2/10)	20.0% (2/10)	0.0% (0/10)	10.0% (1/10)	0.0% (0/10)	10.0% (1/10)
	Buttock	40.0% (2/5)	40.0% (2/5)	0.0% (0/5)	0.0% (0/5)	0.0% (0/5)	0.0% (0/5)

Note: Given the small sample size of data available in the low range, the alert performance in the 50 mg/dL and 60 mg/dL should be interpreted with caution and may not reflect actual use performance.

*The default alert threshold is highlighted in gray.



Glossary

active insulin	Active insulin is bolus insulin delivered by the insulin pump that continues to lower BG levels. Active insulin is not necessarily reflective of the pharmacokinetics and pharmacodynamics of rapid acting insulins.
active insulin time	A Bolus Wizard setting used to indicate length of time that bolus insulin is tracked as active insulin.
activity guard	An attachment that secures the reservoir during activity or when the insulin pump is worn by a child.
alarm	An audible beep or vibration with a message that requires immediate attention.
alarm history	A feature that stores information about recent alarms and alerts.
alert	An audible beep or vibration with a message to inform of a situation that may require attention.
alert before low	An alert that occurs when the low SG reading is being approached.
alert limits	The settings that determine when low and high SG alerts are triggered.
alert on low	An alert that occurs when the SG reading reaches or falls below the low limit.
auto basal	The automatically adjusted basal insulin delivered by the SmartGuard feature based on the current SG readings.
Auto correction	A correction bolus automatically delivered by the MiniMed 780G system to maximize time in range. Auto correction only occurs when using the SmartGuard feature.

auto suspend	A feature that suspends insulin delivery and triggers an alarm if no buttons are pressed for the specified period of time. Insulin delivery resumes when the alarm is cleared.
awake mode	A state in which the pump screen is on. The Home screen appears unless another screen is being used.
basal insulin	Insulin that is continuously delivered by the insulin pump to meet insulin needs between meals and during sleep.
basal pattern	A set of one or more basal rates that covers a 24-hour period.
basal rate	The setting for the amount of continuous basal insulin to be delivered per hour.
BG	The acronym for blood glucose. For more information, see blood glucose (BG) .
BG meter	A device that measures glucose levels in the blood.
BG targets	The high and low BG readings used for BG correction when using the Bolus Wizard feature.
Block mode	A feature that restricts the ability to change all settings. Certain functions can still be performed, such as suspend insulin delivery or clear alarms and alerts.
blood glucose (BG)	Glucose that is present in the blood, commonly measured by a BG meter.
bolus BG check reminder	A reminder for a BG check after programming a bolus. The reminder appears when the specified time period has passed.
bolus insulin	Insulin used to cover an expected rise in BG levels due to carbohydrates, or to lower a high BG reading down to the BG target range.
bolus speed	The delivery speed for bolus insulin.

Bolus Wizard feature	A feature that uses individual Bolus Wizard settings to calculate an estimated bolus amount based on the BG value and the entered carbs. These settings include carb ratio, insulin sensitivity factor, BG target range, and active insulin time.
calibrate	The process of using a blood glucose (BG) meter reading to help the sensor glucose (SG) readings more closely match the glucose measured in your blood.
calibration reminder	A reminder to calibrate the sensor when the next calibration is due.
cannula	Short, thin, and flexible tube placed in the tissue below the skin. Insulin is delivered through the cannula into the body.
carb ratio	The number of grams of carbohydrates covered by one unit of insulin. The carb ratio is used to calculate bolus amounts.
CDC	The acronym for the Centers for Disease Control.
CGM	The acronym for continuous glucose monitoring. For more information, see continuous glucose monitoring (CGM) .
continuous glucose monitoring (CGM)	A monitoring tool that uses a glucose sensor placed below the skin to continuously measure the amount of glucose in the interstitial fluid.
correction bolus	Insulin used to lower a high BG or SG reading down to a target value.
CT scan	The acronym for computed tomography scan.
daily history	Details of the events entered or actions performed using the insulin pump.
diabetic ketoacidosis	A serious condition that occurs when insulin levels are low, BG levels are elevated, and the body uses fat for energy. This process produces ketones, which upset the acid-base balance in the body, leading to a potentially life-threatening situation.

Dual Wave bolus	A type of bolus that provides a dose of insulin delivered as a combination of a normal bolus followed by a Square Wave bolus.
Easy bolus	A feature that delivers a normal bolus in preset increments using sound or vibrate confirmation.
EMC	The acronym for electromagnetic compatibility.
ESD	The acronym for electrostatic discharge.
FCC	The acronym for the Federal Communications Commission.
FDA	The acronym for the Food and Drug Administration.
food bolus	A dose of insulin given to cover an expected rise in glucose levels from carbohydrates.
GPS	The acronym for global positioning system.
high limit	The setting the insulin pump uses to determine when to alert for a high SG condition.
infusion set	Tubing that connects to the reservoir on one end, and has a needle or cannula on the other end, that is inserted into the body. Insulin travels from the insulin pump through the infusion set into the body.
infusion site	The location on the body where the infusion set is inserted.
insulin sensitivity factor	The amount that BG is reduced by one unit of insulin. The insulin sensitivity factor is used to calculate correction bolus amounts.
interstitial fluid	The fluid that surrounds the cells in the body.
IV	The acronym for intravenous.
lock	A feature that prevents accidental button presses.
low limit	The setting the insulin pump uses to determine when to alert for a low SG condition and suspend insulin delivery.
Manual bolus	A feature to manually enter and deliver a dose of insulin.

Manual mode	Manual mode refers to system functions that are used when the SmartGuard feature is not active.
Max basal rate	The maximum amount of basal insulin that can be delivered per hour.
Max bolus	The maximum bolus amount that can be delivered in one dose.
meter	A term for any BG meter.
missed meal bolus reminder	A reminder when a bolus is not delivered during the specified time period, which is often around meal times.
MRI	The acronym for magnetic resonance imaging.
NiMH	The acronym for nickel-metal hydride.
normal bolus	A type of bolus that provides an entire dose of insulin immediately.
notifications	All notifications are designed to get attention and convey different types of information. They include alarms, alerts, reminders, and messages.
occlusion	A blockage or crimp of the cannula or tubing that prevents proper insulin flow.
piston	The part of the insulin pump that engages the reservoir and moves insulin through the tubing.
power save mode	A state in which the insulin pump is fully functional, but the screen goes dark to save power.
preset bolus	A feature to set up and save a bolus for specific meals or snacks that are frequently consumed.
preset temp basal	A feature to set up and save temporary basal rates for repeated use.
reminder	A type of notification to help remember an action.
reservoir	The small container that is filled with insulin and inserted into the insulin pump.

Resume basal alert	An alert that occurs when the insulin pump has automatically resumed basal insulin delivery after a Suspend before low or Suspend on low event because the SG readings have met the necessary criteria. This alert always occurs if basal insulin delivery has resumed because the two-hour maximum suspend time has elapsed.
rewind	A feature that returns the piston to its start position to place a new reservoir into the insulin pump.
RF	The acronym for radio frequency.
rise alert	An alert that occurs if the SG reading is rising rapidly.
sensitivity	For more information, see insulin sensitivity factor .
sensor (glucose sensor)	The small part of the CGM system that is inserted just below the skin to measure glucose levels in the interstitial fluid.
sensor glucose (SG)	Glucose that is present in the interstitial fluid and is measured by a glucose sensor.
set change reminder	A reminder to change the infusion set.
SG	The acronym for sensor glucose. For more information, see sensor glucose (SG) .
Sleep mode	A state in which the insulin pump is fully functional, but the screen is dark. The insulin pump automatically enters Sleep mode when no buttons are pressed for about two minutes.
SmartGuard bolus feature	A feature that assists to calculate a recommended bolus amount based on optional carbohydrate intake and optional BG or SG measurement. One or both of the two optional values may be entered.
SmartGuard feature	An insulin delivery feature that automatically controls basal insulin delivery to regulate BG levels to a target SG value.
SN	The acronym for serial number.
Square Wave bolus	A bolus delivered evenly over the specified time period.

suspend	Suspend features include the Suspend before low feature and the Suspend on low feature.
Suspend before low	A feature that suspends insulin delivery when the sensor predicts the SG reading is approaching the low limit.
suspend delivery	A feature that stops all insulin delivery until it is resumed. Only the basal insulin restarts when delivery is resumed.
Suspend on low	A feature that suspends insulin delivery when the SG reading reaches or falls below the low limit.
TDD	The acronym for total daily dose.
temp basal rate (temporary basal rate)	A feature that temporarily increases or decreases the current basal rate for the specified duration of time.
transfer guard	The plastic piece that comes attached to the reservoir. It is used to connect the reservoir to the insulin vial while the reservoir fills with insulin.
transmitter	A device that connects to a glucose sensor. The transmitter collects data measured by the sensor and wirelessly sends this data to the insulin pump.



Index

A

accessories 59

acetaminophen 37

active insulin

about 104

clearing 213

viewing amount 77

Active Insulin cleared alert 299

Active Insulin reminder alert 300

active insulin reset to zero

icon 78

Active Insulin reset to zero 300

Active Insulin Time

about 104

changing 258

adjustments

bolus 197

Alarm History 224

alarms

about 236, 237

Active Insulin reset to zero 300

audio options 238

Auto Suspend 301

Battery failed 301

Battery not compatible 301

Bolus stopped 301

Critical pump error 301

Delivery limit exceeded 302

Fill Cannula? 303

Insert battery 303

Insulin flow blocked 304, 305

Loading incomplete 305

Manage Settings error 306

Max Fill reached 307

Medical device 316

No reservoir detected 307

notification light 238

Power error detected 307

Power loss 307

pump 299

Pump error 308

Pump restarted 309

red icon 238

Replace battery now 309

Rewind required 310

Stuck button 311

alert

Active Insulin reminder 300

Alert before high

about 154

description 311

setting up 162

- Alert before low
 - about 158
 - description 339
 - setting up 166
- Alert on high
 - about 154
 - setting up 162
- Alert on low
 - about 160
 - setting up 167
- alerts
 - about 236, 238
 - Active Insulin cleared 299
 - Alert before high 311
 - Alert before low 312
 - audio options 239
 - Basal delivery resumed 312, 313
 - BG not received 313
 - Bolus not delivered 301
 - Calibration not accepted 313
 - Change sensor 313, 314
 - Check connection 314
 - Check settings 301
 - Device not compatible 302
 - Device not found 302
 - Download slow 322
 - Enter BG now 314, 315, 320, 321
 - High SG 315
 - Lost sensor signal 315
 - Low battery Pump 305
 - Low battery transmitter 315
 - Low reservoir 306
 - No calibration occurred 316
 - notification light 239
 - overview 238
 - Possible signal interference 317
 - pump 299, 322
 - Replace battery 309
 - Reservoir estimate 309
 - Rise alert 317
 - Sensor expired 317
 - Sensor signal not found 317
 - Sensor updating 318
 - silencing 175
 - SmartGuard 319
 - SmartGuard exit 319
 - SmartGuard started 319
 - Suspend before low 318
 - Suspend on low 318
 - Transmitter battery depleted 318
 - yellow icon 239
- Alert silence
 - in SmartGuard feature 203
- Alert Silence
 - about 175
 - canceling 176
- areas, for inserting infusion set 129

- arrows
 - trend arrows 152
- audio
 - settings 82
 - silencing 175
- Auto Basal 183
- Auto Correction
 - about 183
 - setting up 185
- Auto suspend 214
- Auto Suspend alarm 301
- B**
- backlight
 - battery use 72
 - setting up 207
- basal
 - about 87
 - daily delivery amount 221
 - history 221
 - Home screen 76
 - Max basal rate 88
 - patterns 89
 - preset temp basal rate 243
 - rate 87
 - summary 219
 - Temp Basal 98

- Basal delivery resumed
 - alarm 313
 - alert 312, 313
 - message 312
- basal patterns
 - about 89
 - changing 248
 - copying 247
 - deleting 247
 - editing 247
 - setup 90
- Basal Patterns screen
 - about 95
- basal rate
 - about 87
- Basal screen
 - about 95
- battery
 - about 72
 - alarm 301, 303, 309
 - alert 305, 309
 - compartment location 71
 - disposal 296
 - icon 78
 - inserting 72
 - pump clip 296
 - removing 296
 - replacing 72
- Battery failed alarm 301

- Battery not compatible alarm 301
- BG
 - confirming 101
 - Entering a BG value in Manual mode 100
 - Entering a BG value in the SmartGuard feature 191
 - Home screen 76
 - Summary screen 222
- BG not received alert 313
- BG target
 - about 104
 - changing 257
- Block mode
 - about 208
 - icon 81
 - in SmartGuard 203
- blood glucose
 - confirming 101
- bolus
 - about 101
 - Bolus Wizard 101, 103
 - daily delivery amount 221
 - Dual Wave 263
 - Easy bolus 267
 - history 221, 222
 - increment 254
 - Manual bolus 102, 111
 - Max bolus setting 102
 - normal bolus 109, 111
 - options 101
 - preset 270
 - settings 254
 - shortcut 77
 - SmartGuard 193
 - speed 255
 - Square Wave 259
 - stopping 112, 274
 - summary 219, 221, 222
 - types 253
- Bolus BG Check reminder 233
- Bolus not delivered alert 301
- Bolus stopped alarm 301
- Bolus Wizard
 - about 101
 - Active Insulin Time 104
 - BG target 104
 - changing 256
 - Dual Wave 264
 - Insulin Sensitivity Factor 104
 - normal bolus 109
 - settings 103
 - Square Wave 260
 - turning off 109
- buttons, pump 70
- C**
 - calibrate
 - error 314

- calibration
 - guidelines 171, 172
 - icon 79
 - reminder 236
 - sensor 171
 - when to 171
- Calibration not accepted alert 313
- cannula
 - about 72
 - filling 130
 - stop filling 132
- cannula alarm 303
- carb ratio
 - about 104
 - changing 256
 - setting up 106
- CareLink software 142
- CareLink uploader not found. message 322
- Change sensor alert 313, 314
- Check connection alert 314
- Check settings alert 301
- cleaning
 - pump 289
 - transmitter 295
- clearing
 - active insulin 213
 - pump settings 212
- consumables
 - infusion set 57
 - reservoir 57
- continuous glucose monitoring (CGM)
 - calibrating sensor 171
 - high SG settings 153
 - home screen 152
 - low SG settings 154
 - pairing pump, transmitter 139
 - sensor feature, turning on or off 162
 - sensor glucose reading 173
 - sensor graph 173
 - settings 153
- conventions, user guide 30
- Critical pump error alarm 301
- CT scan 52
- D**
- Daily History 223
- date
 - changing 207
 - Startup Wizard 74
- delivery 82
- Delivery limit exceeded alarm 302
- Device Limit message 302
- Device not compatible alert 302
- Device not found alert 302
- display options 207

disposal, pump 292
Download slow alert 322
Dual Wave
 about 263
 Bolus Wizard 264
 example 254
 Manual bolus 265
Dual Wave bolus
 stopping 274
E
Easy bolus
 about 267
 delivering 269
 setting up 267
electromagnetic emissions
 about 342
electromagnetic immunity
 about 343
emergency kit 31
Enter BG
 for calibration 172
 in Manual mode 100
 in SmartGuard 191
Enter BG now alert 314, 315, 320,
321
F
Fill Cannula? alarm 303
food estimate 330

G
graph
 CGM 173
 history 226
 SmartGuard 190
H
High Limit
 about 154
 setting up 163
High SG alert
 about 154, 315
high SG settings
 about 153
 setting up 162
High Snooze 165
history
 Alarm History 224
 Daily History 223
 Graph 226
 Paired Sensors 224
 pump settings, viewing 214
 SG Review 225
 summary 219
 Time in Range 227
History & Graph 219
 introduction 219

- Home screen
 - CGM 152
 - Manual mode 76
 - SmartGuard 189
- hydroxycarbamide 37
- hydroxyurea 37
- I**
- icons
 - menu 81
 - SmartGuard graph 189
 - status 78
 - suspend 159
- infusion set
 - about 118
 - fill cannula alarm 303
 - fill tubing 126
 - inserting 129
 - overview 71
 - reservoir alarm 305
 - setting up 118
 - type 57
- Insert battery alarm 303
- inserting
 - infusion set 129
 - reservoir 126
 - sensor 169
- insulin
 - basal 87
 - basal patterns 89
 - bolus 101
 - flow blocked alarm 304, 305
 - icon 78
 - Max Fill reached alarm 307
 - setting up delivery 87
- insulin delivery
 - Block mode 208
 - resuming 95, 161, 168
 - stopping 95, 112, 274
 - suspending
 - 95, 156, 158, 214, 366
- Insulin flow blocked alarm 304, 305
- Insulin Sensitivity Factor
 - about 104
 - changing 256
 - setting up 107
- L**
- language
 - changing 215
 - setting up 74
- light, notification 238
- Loading incomplete alarm 305
- Lost sensor signal alert 315
- Low battery Pump alert 305
- Low battery transmitter alert 315
- Low limit
 - about 156
- low management mode
 - summary 223

- Low Reservoir
 - alert 234, 306
 - reminder 234
- Low SG alarm
 - about 156
- low SG settings
 - about 154
 - changing 167
 - setting up 165
- Low Snooze 168
- M**
- maintenance
 - cleaning the pump 289
 - pump disposal 292
 - removing the battery 295
 - storing the pump 290
 - unpairing the meter 292
 - unpairing the transmitter 294
- Manage Settings 211
- Manage Settings error alarm 306
- Manual bolus
 - about 102
 - Dual Wave 265
 - Easy bolus feature 269
 - normal bolus 111
 - Square Wave 261
- Max basal
 - about 88
 - alarm 302

- Max bolus
 - about 102
 - alarm 302
- Max Fill reached alarm 307
- meal bolus
 - in SmartGuard 198
 - reminder 233
- Medical device alarm 316
- medications
 - acetaminophen 37
 - hydroxycarbamide 37
 - hydroxyurea 37
 - paracetamol 37
- Medtronic Diabetes Updater app 143
- menu
 - accessing 81
 - Blood Glucose screen 82
 - History & Graph screen 82
 - icons 82
 - Insulin screen 82
 - map 82, 351
 - Paired Devices screen 82
 - Reservoir & Set screen 82
 - Settings screen 82
 - SmartGuard screen 82
 - Sound & Vibration screen 82
 - Status screen 82

- messages
 - about 236, 239
 - Basal delivery resumed 312
 - CareLink uploader not found. 322
 - CGM 311
 - Device Limit 302
 - overview 239
 - pump 299, 322
 - Resume bolus 310
 - Resume Dual bolus 310
 - Resume Square bolus 310
 - Sensor connected 317
 - Sensor warm-up started 318
- meter
 - pairing 137
 - unpairing 292
- Missed Meal Bolus reminder 233
- mobile device
 - uploading 142
- modes
 - Block 208
 - Manual 76
 - Sleep 70
- MRI 52
- N**
- No calibration occurred alert 316
- No reservoir detected alarm 307
- normal bolus
 - about 109
 - Bolus Wizard 109
 - delivery 109
 - example 254
 - Manual bolus 111
- notification light 239
- notifications
 - about 231, 236
 - light 238
- O**
- Occlusion detection
 - alarm 337
- options
 - basal patterns 89
 - bolus delivery 101
 - bolus speed 327
 - display 207
 - Manage Settings 211
 - Self Test 210
 - Sound & Vibration 82
 - Status screen 83
- P**
- pair device 139, 142
 - meter 137
 - mobile device 142
 - pairing transmitter 139
- Paired Sensors 224
- paracetamol 37

- patterns, basal
 - about 89
 - adding 246
 - changing 248
 - copying 247, 248
 - deleting 247
 - editing 247
 - setup 90
- performance data
 - seven years and older 357
- personal reminders 232
- Possible signal interference alert 317
- Power error detected alarm 307
- Power loss alarm 307
- preset bolus
 - about 270
 - changing 272
 - delivering 273
 - setting up 270
- preset temp basal rate
 - about 243
 - canceling 246
 - setting up 243
 - starting 245
- Preset Temp basal rate
 - editing 244
- pump
 - alarms 299
 - alerts 299
 - buttons 69
 - cleaning 289
 - connection status 79
 - disposal 292
 - messages 299
 - overview 71
 - pairing, meter 137
 - pairing, mobile device 142
 - pairing, transmitter 139
 - parts illustration 71
 - rewinding 118
 - storing 290
 - unpairing, meter 292
 - unpairing, transmitter 294
- pump clip
 - removing battery cap with 296
 - tightening battery cap with 73
- Pump error alarm 308
- Pump restarted alarm 309
- pump security 55
- pump settings
 - clearing 212
 - managing 211
 - restoring 212
 - saving 211
 - viewing history 214

R

rate

- basal 87
- Max basal 88
- preset temp basal 243
- temp basal 98

red light 239

reminders

- about 231
- Bolus BG Check 233
- calibration 236
- Low Reservoir 234
- Missed Meal Bolus 233
- Personal 232
- Set Change 235

Replace battery alert 309

Replace battery now alarm 309

reservoir

- about 118
- connecting 122
- diagram 71
- filling 122
- icon 78
- inserting 126
- Loading incomplete alarm 305
- Low Reservoir alert 306
- Max Fill reached alarm 307
- models 57

No reservoir detected

- alarm 307
- overview 72, 292
- plunger 122
- removing 118
- setting up 118
- transfer guard 122

Reservoir estimate alert 309

restoring pump settings 212

Resume basal alert 161

Resume bolus message 310

Resume Dual bolus message 310

Resume Square bolus message 310

rewinding 126

Rewind required alarm 310

Rise Alert

- about 154
- description 317
- setting up 163

Rise Limit

- about 154
- setting up 163

S

safety

- contraindications 35
- information 30
- insulin guidelines 56

- intended use 32
- risks 36
- warnings 40
- saving pump settings 211
- screen
 - Block mode 81, 203, 208, 209
 - Home screen 76
 - Language 74
 - Select Time Format 75
 - Summary 219, 223, 224, 225, 228
 - Time and Date 207
 - Welcome screen 74
- self test 210
- sensor
 - about 33
 - BG not received alert 313
 - calibrating 171, 172
 - calibration alert 313, 314, 315
 - calibration icon 79
 - expired alert 317
 - feature, turning on or off 162
 - Home screen 152
 - inserting 169
 - life icon 80
 - pairing the transmitter 139
 - removing 295
 - starting 170
 - Summary screen 222
 - sensor alerts
 - canceling silence 176
 - silencing 175, 176
 - Sensor connected message 317
 - Sensor expired alert 317
 - sensor glucose (SG)
 - graph 173
 - high SG settings 153
 - history 173
 - low SG settings 154
 - sensor graph
 - about 152
 - CGM 173
 - Sensor signal not found alert 317
 - Sensor updating alert 318
 - Sensor warm-up started message 318
 - Set Change reminder 235
 - settings
 - 24-hour period 91
 - bolus 254
 - Bolus Wizard 103
 - CGM 153
 - low SG 154
 - managing 211
 - startup 74
 - SG Review 225
 - shortcuts 77

- silencing alerts
 - about 175
- Sleep mode 70
- SmartGuard
 - about 181
 - alerts 319
 - Block mode in 203
 - bolus 193
 - bolus adjustments 197
 - Checklist 187
 - conditions to activate 186
 - entering a BG value 191
 - exiting 202
 - Home screen 189
 - introduction 181
 - messages 319
 - preparing 183
 - returning to 202
 - sensor graph 190
 - Setting Temp Target 199
 - setting up 185
 - staying in 200
 - suspend features 186
 - Temp Target 199
 - using 190
- SmartGuard exit alert 319
- SmartGuard started alert 319
- Sound & Vibration
 - adjusting 83
 - screen 82
- Square Wave
 - about 259
 - Bolus Wizard 260
 - example 254
 - Manual bolus 261
 - setting up 259
- Square Wave bolus
 - stopping 274
- starting
 - sensor 170
- Startup Wizard
 - about 74
- status icons
 - about 78
 - Block mode 81
 - CGM 152
 - Connection icon 79
 - insulin amount 78
 - sensor calibration 79
 - sensor life 80
 - time 76
- Status screen
 - about 83
 - pump 83

- sensor 84
 - shortcut 77
 - SmartGuard Checklist 83
- stopping
 - bolus 112, 274
 - insulin delivery 95
- storage mode 290
- Stuck button alarm 311
- Summary screen
 - about 219
 - BG 222
 - bolus 221, 222
 - Bolus Wizard 221
 - insulin delivery overview 221
 - low management mode 223
 - overview 220
 - sensor 222
 - SmartGuard 222
 - time in range 220
- Suspend before low
 - about 156, 366
 - alert 318
 - in SmartGuard 186
 - setting up 166
 - unavailable 159
- Suspended delivery
 - about
 - resuming 95
 - Suspended delivery, resuming
 - after a suspend event 161
 - manually 168
 - suspending insulin delivery
 - Auto suspend 214
 - in SmartGuard 186
 - manually 95
 - resuming automatically 161
 - resuming manually 168
 - Suspend before low 156, 366
 - Suspend on low 158
 - Suspend on low
 - about 158
 - alarm 318
 - in SmartGuard 186
 - setting up 166
 - unavailable 159
 - system overview 71
 - system security 55
- T**
- target
 - BG 104
 - SmartGuard 181
- TDD 221
- temp basal rate
 - about 98
 - starting 98
 - types 98

- Temp Target
 - canceling 200
 - setting up 199
- time
 - changing 207
 - Startup Wizard 207
- Time before high
 - about 154
 - setting up 163
- time in range
 - about 227
 - shortcuts 77
- transfer guard 44, 122
- transmitter
 - charging 140
 - communication 79
 - connecting 169
 - pairing 139
 - unpairing 294
- Transmitter battery depleted alert 318
- trend arrows 152
 - icons 80
- troubleshooting 279
 - pump issues 280
 - sensor issues 283
- tubing
 - filling 126
 - image 71
 - Max Fill reached alarm 307
- tubing connector 40, 44, 71, 122
- V**
- vibration settings 82
- viewing
 - basal delivery information 95
 - pump settings history 214
- W**
- wake the pump 70
- X**
- x-ray 52

Medtronic



Medtronic MiniMed

18000 Devonshire Street
Northridge, CA 91325
USA
1 800 646 4633
+1 818 576 5555
www.medtronicdiabetes.com

RF: M994838A001

R_x Only

© 2023 Medtronic
M010682C002_2
2023-02-21

REF

MMT-1884, MMT-1894



M010682C002

MiniMed™ 780G

SYSTEM USER GUIDE



MiniMed™ 780G
with the Guardian™ 4 Sensor

Includes technology developed by [dreamed](https://www.dreameddiabetes.com)
diabetes.ai

MiniMed™ 780G
with the Guardian™ 4 Sensor
System User Guide



Medtronic and Medtronic logo are trademarks of Medtronic. ^{™*} Third-party brands are trademarks of their respective owners. All other brands are trademarks of a Medtronic company. The following list includes trademarks or registered trademarks of a Medtronic entity in the United States or in other countries.

Bolus Wizard[™], CareLink[™], Dual Wave[™], Easy Bolus[™], Guardian[™], MiniMed[™], Mio[™], Quick-set[™], Silhouette[™], SmartGuard[™], Square Wave[™], Sure-T[™]

Contacts:**Africa:**

Medtronic South Africa and Southern Africa
Office Reception Tel: +27(0) 11 260 9300
Diabetes: 24/7 Helpline: 0800 633 7867
Sub-Sahara 24/7 Helpline: +27(0) 11 260 9490

Albania:

Net Electronics Albania
Tel: +355 697070121

Argentina:

Corpomedica S.A.
Tel: +(11) 4 814 1333
Medtronic Directo 24/7:
+0800 333 0752

Armenia:

Exiol LLC
Tel: +374 98 92 00 11
or +374 94 38 38 52

Australia:

Medtronic Australasia Pty. Ltd.
Tel: 1800 668 670

Bangladesh:

Sonargaon Healthcare Pvt Ltd.
Mobile: (+91)-9903995417
or (+880)-1714217131

Belarus:

Zarga Medica
Tel: +37517 336 97 00
+37529 613 08 08
+37517 215 02 89
Helpline: +74995830400

België/Belgique:

N.V. Medtronic Belgium S.A.
Tel: 0800-90805

Bosnia and Herzegovina:

"Novopharm" d.o.o. Sarajevo
Tel: +387 33 476 444
Helpline: 0800 222 33
Epsilon Research Intern. d.o.o.
Tel: +387 51 251 037
Helpline: 0800 222 33

Brasil:

Medtronic Comercial Ltda.
Tel: +(11) 2182-9200
Medtronic Directo 24/7:
+0800 773 9200

Bulgaria:

RSR EOOD
Tel: +359 888993083
Helpline: +359 884504344

Canada:

Medtronic Canada ULC
Tel: 1-800-284-4416 (toll free/sans-frais)

Česká republika:

Medtronic Czechia s.r.o.
Tel: +420 233 059 111
Non-stop helpLine (24/7):
+420 233 059 059
Zákaznický servis (8:00 - 17:00):
+420 233 059 950

Chile:

Medtronic Chile
Tel: +(9) 66 29 7126
Medtronic Directo 24/7:
+1 230 020 9750
Medtronic Directo 24/7 (From Santiago): +(2) 595 2942

China:

Medtronic (Shanghai) Management Co., Ltd.
Landline: +86 800-820-1981
Mobile Phone: +86 400-820-1981
Calling from outside China: +86 400-820-1981

Colombia:

Medtronic Latin America Inc. Sucursal Colombia
Tel: +(1) 742 7300
Medtronic Directo 24/7 (Landline):
+01 800 710 2170
Medtronic Directo 24/7 (Cellular):
+1 381 4902

Croatia:

Mediligo d.o.o.
Tel: +385 1 6454 295
Helpline: +385 1 4881144
Medtronic Adriatic d.o.o.
Helpline: +385 1 4881120

Danmark:

Medtronic Danmark A/S
Tel: +45 32 48 18 00

Deutschland:

Medtronic GmbH
Geschäftsbereich Diabetes
Telefon: +49 2159 8149-370
Telefax: +49 2159 8149-110
24-Stdn-Hotline: 0800 6464633

Eire:

Accu-Science LTD.
Tel: +353 45 433000

España:

Medtronic Ibérica S.A.
Tel: +34 91 625 05 42
Fax: +34 91 625 03 90
24 horas: +34 900 120 330

Estonia:

AB Medical Group Estonia Ltd
Tel: +372 6552310
Helpline: +372 5140694

Europe:

Medtronic Europe S.A. Europe, Middle East and Africa HQ
Tel: +41 (0) 21-802-7000

France:

Medtronic France S.A.S.
Tel: +33 (0) 1 55 38 17 00

Hellas:

Medtronic Hellas S.A.
Tel: +30 210677-9099

Hong Kong:

Medtronic Hong Kong Medical Ltd.
Tel: +852 2919-1300
To order supplies: +852 2919-1322
24-hour helpline: +852 2919-6441

India:

India Medtronic Pvt. Ltd.
Tel: (+91)-80-22112245 / 32972359
Mobile: (+91)-9611633007
Patient Care Helpline:
1800 209 6777

Indonesia:

Medtronic International Ltd.
Tel: +65 6436 5090
or +65 6436 5000

Israel:

Medtronic Trading Ltd.
Tel.: +972-9-9724400
Tel. (product support –
8:00-17:00): +972-9-9724489
Helpline (weekends & holidays):
1-800-611-888

Italia:

Medtronic Italia S.p.A.
Tel: +39 02 24137 261
Fax: +39 02 24138 210
Servizio assistenza tecnica:
N° verde: 800 60 11 22

Japan:

Medtronic Japan Co. Ltd.
24 Hr. Support Line: 0120-56-32-56
日本：日本メドトロニック株式会
社
24時間サポートライン：
0120-56-32-56

Kazakhstan:

TOO "Медтроник Казахстан"
Tel: +7 727 321 13 30 (Almaty)
Круглосуточная линия поддержки:
8 800 080 5001

Kosovo:

Yess Pharma
Tel: +377 44 999 900
Helpline: +37745888388

Latin America:

Medtronic, Inc.
Tel: 1(305) 500-9328
Fax: 1(786) 709-4244

Latvija:

RAL SIA
Tel: +371 67316372
Helpline (9am to 6pm):
+371 29611419

Lithuania:

Monameda UAB
Tel: +370 68405322
Helpline: +370 68494254

Macedonia:

Alkaloid Kons Dooel
Tel: +389 23204438

Magyarország:

Medtronic Hungária Kft.
Tel: +36 1 889 0688

Malaysia:

Medtronic International Ltd.
Tel: +603 7946 9000

México:

Medtronic Servicios S. de R. L. de C.V.
Tel (México DF): +(11) 029 058
Tel (Interior): +01 800 000 7867
Medtronic Directo 24/7 (from México
DF):
+(55) 36 869 787
Medtronic Directo 24/7:
+01 800 681 1845

Middle East and North Africa:

Regional Office
Tel: +961-1-370 670

Montenegro:

Glosarij d.o.o.
Tel: +382 20642495

Nederland, Luxembourg:

Medtronic B.V.
Tel: +31 (0) 45-566-8291
Gratis: 0800-3422338

New Zealand:

Medica Pacifica
Phone: 64 9 414 0318
Free Phone: 0800 106 100

Norge:

Medtronic Norge A/S
Tel: +47 67 10 32 00
Fax: +47 67 10 32 10

Österreich:

Medtronic Österreich GmbH
Tel: +43 (0) 1 240 44-0
24 – Stunden – Hotline: 0820 820 190

Philippines:

Medtronic International Ltd.
Tel: +65 6436 5090
or +65 6436 5000

Россия

ООО «Медтроник»
Tel: +7 495 580 73 77
Круглосуточная линия поддержки
8 800 200 76 36

Polska:

Medtronic Poland Sp. z o.o.
Tel: +48 22 465 6934

Portugal:

Medtronic Portugal Lda
Tel: +351 21 7245100
Fax: +351 21 7245199

Puerto Rico:

Medtronic Puerto Rico
Tel: 787-753-5270

Republic of Korea:

Medtronic Korea, Co., Ltd.
Tel: +82.2.3404.3600

Romania:

Medtronic Romania S.R.L
Regional Office
Tel: +40372188017
Helpline: +40 726677171

Schweiz:

Medtronic (Schweiz) AG
Tel: +41 (0)31 868 0160
24-Stunden-Hotline: 0800 633333
Fax Allgemein: +41 (0)318680199

Serbia:

Epsilon Research International d.o.o.
Tel: +381 113115554
Medtronic Serbia D.o.o.
Helpline: +381 112095900

Singapore:

Medtronic International Ltd.
Tel: +65 6436 5090
or +65 6436 5000

Slovenija:

Zaloker & Zaloker d.o.o.
Tel: +386 1 542 51 11
24-urna tehnična pomoč:
+386 51316560

Slovenská republika:

Medtronic Slovakia, s.r.o.
Tel: +421 26820 6942
HelpLine: +421 26820 6986

Sri Lanka:

Swiss Biogenics Ltd.
Mobile: (+91)-9003077499
or (+94)-777256760

Suomi:

Medtronic Finland Oy
Tel: +358 20 7281 200
Help line: +358 800 164 064

Sverige:

Medtronic AB
Tel: +46 8 568 585 20
Fax: +46 8 568 585 11

Taiwan:

Medtronic (Taiwan) Ltd.
Tel: 02-21836000
Toll free: +886-800-005285

Thailand:

Medtronic (Thailand) Ltd.
Tel: +662 232 7400

Türkiye:

Medtronic Medikal Teknoloji
Ticaret Ltd. Sirketi.
Tel: +90 216 4694330

USA:

Medtronic Diabetes Global
Headquarters
24-Hour Technical
Support: +1-800-646-4633
To order supplies: +1-800-843-6687

Ukraine:

ТОВ «Медтронік Україна»
Лінія цілодобової підтримки:
Тел.: 0 800 508 300













United Kingdom:









Medtronic Ltd.
Tel: +44 1923-205167

Vietnam:

Medtronic Vietnam
Tel: +84 283 926 2000

Icon table

	Bluetooth® wireless technology or Bluetooth® enabled
	Consult instructions for use
	Manufacturer
	Date of manufacture
	Do not resterilize
	Do not reuse
	Do not use if package is damaged
FCC ID	Complies with United States regulations for radio frequency devices
	Fragile, handle with care
IPX8	Protected against the effects of continuous immersion in water.
	Keep dry
	Batch code
	Medical device
	Magnetic Resonance (MR) Unsafe

	Non-pyrogenic
(1x)	One per container/package
	Open here
	Recyclable, contains recycled content
REF	Catalogue number
RF	Identification number for global radio frequency certification
R _x Only	Requires prescription in the USA
	Single patient, multi-use
	Single sterile barrier system
SN	Serial number
STERILE R	Sterilized using irradiation
	Storage humidity limits
	Storage temperature limits
	Type BF applied part
	Use-by date

	Do not dispose of this product in unsorted municipal waste stream
---	---

WARNING: Do not use the SmartGuard feature for people who require less than eight units or more than 250 units of total daily insulin per day. A total daily dose of at least eight units, but no more than 250 units, is required to use the SmartGuard feature.

Contents

■ Safety and indications

- 29 Important system information
- 30 Using this guide
- 30 Conventions
- 31 Emergency kit
- 32 User safety
- 32 Intended use
- 36 Risks and side effects
- 40 General warnings
- 40 Pump
- 44 Reservoir and infusion sets
- 47 Sensor and serter
- 49 Transmitter
- 50 Meter
- 52 Exposure to magnetic fields and radiation
- 53 General precautions
- 53 Waterproof capabilities
- 54 Electrostatic discharge
- 54 Extreme temperatures
- 55 Skin care products
- 55 Infusion sets and sites, sensor, transmitter, and meter

55	Adverse reactions
55	Security precautions
57	Insulin guidelines
57	Consumables
59	Other MiniMed 780G system devices
59	Accessories

■ System overview

63	What are the components of the MiniMed 780G system?
64	Modes
65	Manual mode without CGM
65	Manual mode with CGM
66	SmartGuard

■ Pump basics

70	Using the buttons
70	Sleep mode
71	Pump delivery system
71	Infusion set
72	Reservoir
72	Pump
72	Inserting the battery
74	Startup settings
76	Home screen in Manual mode
77	Shortcuts from the Home screen
78	Status icons
81	Menu screen
81	Menu map
82	Sound & Vibration screen
82	Status screen

■ Setting up insulin delivery

- 87 Setting up basal insulin
- 87 Basal rate
- 88 Max basal rate
- 89 Basal patterns
- 91 Settings covering a 24-hour period
- 95 Viewing basal delivery information
- 95 Suspending all insulin delivery and resuming basal insulin delivery
- 98 Temp basal rates
- 100 Entering a blood glucose (BG) meter reading
- 101 Setting up bolus delivery
- 101 About bolus deliveries
- 101 Bolus delivery options
- 102 Max bolus
- 103 Bolus Wizard feature
- 109 Normal bolus
- 112 Stopping a bolus delivery

■ Reservoir and infusion set

- 118 Setting up the reservoir and infusion set
- 118 Removing the reservoir and rewinding the pump
- 122 Filling the reservoir and connecting it to the infusion set tubing
- 126 Placing the reservoir into the pump and filling the tubing with insulin
- 129 Inserting the infusion set into the body
- 130 Filling the cannula
- 133 Disconnecting the infusion set
- 133 Reconnecting the infusion set

■ Paired devices

- 137 Setting up the Accu-Chek™* Guide Link meter

137	Pairing the pump and meter
139	Pairing the pump and transmitter
142	MiniMed Mobile app
142	Uploading device data to CareLink software
142	Sharing device data with the CareLink Connect app
143	Medtronic Diabetes Updater app
143	Downloading the pump software update
143	Preparing to install the pump software update
144	Installing the pump software update
146	Completing the pump software update

■ **Continuous glucose monitoring with Guardian 4 sensor**

149	CGM overview
150	What is blood glucose (BG) and sensor glucose (SG)?
152	Calibrating the sensor
152	Home screen with CGM in Manual mode
153	SG alert settings
153	High SG settings
154	Low SG settings
161	Setting up CGM
162	Turning the Sensor feature on or off
162	Setting up the High SG settings
165	Setting up the low SG settings
168	Manually resuming basal insulin delivery during a Suspend before low or Suspend on low event
169	Inserting the sensor
170	Connecting the transmitter to the sensor
170	Starting the sensor
171	Reconnecting the sensor
171	Using CGM
172	The sensor graph when using CGM

173 Silencing sensor alerts

■ SmartGuard

- 179 Introduction
- 181 Auto Basal
- 181 Auto Correction
- 181 Giving a bolus when the SmartGuard feature is active
- 181 Preparing to set up the SmartGuard feature
- 182 Setting up the SmartGuard feature
- 183 Conditions to activate the SmartGuard feature
- 184 Suspending manually while using the SmartGuard feature
- 184 Suspend before low and Suspend on low features while using the SmartGuard feature
- 184 SmartGuard Checklist
- 187 Home screen with the SmartGuard feature
- 188 Using the SmartGuard feature
- 188 The sensor graph with the SmartGuard feature
- 189 Entering a BG value in the SmartGuard feature
- 191 Delivering a bolus in the SmartGuard feature
- 196 Setting a temp target
- 197 Staying in the SmartGuard feature
- 199 Exiting the SmartGuard feature
- 199 Returning to the SmartGuard feature after an exit
- 200 Using Block mode with the SmartGuard feature
- 200 Alert silence feature

■ General settings

- 203 Time and date
- 203 Display options
- 204 Block mode
- 206 Self Test

207	Manage Settings
207	Saving the settings
208	Restoring the settings
208	Clearing the settings
209	Clearing the active insulin
210	Viewing the pump setting history
210	Auto suspend
211	Language

■ History and graph

215	Introduction
215	History & Graph menu
215	History
215	Summary screen
216	Understanding the Summary screen
219	Daily History screen
220	Alarm History screen
220	Paired Sensors screen
221	SG Review screen
222	Graph screen
223	Time in Range screen

■ Notifications and reminders

227	Notifications in the MiniMed Mobile app
227	Reminders
228	Personal reminders
229	Bolus BG Check reminder
229	Missed Meal Bolus reminder
230	Low Reservoir reminder
231	Set Change reminder
232	Calibration reminder

- 232 Alarms, alerts, and messages
- 233 Alarms
- 234 Alerts
- 235 Messages
- 235 Pump alarms, alerts, and messages

■ **Additional basal features**

- 239 Preset temp basal rates
- 241 Starting a preset temp basal delivery
- 242 Canceling a temp basal or preset temp basal
- 242 Additional basal patterns
- 242 Adding an additional basal pattern
- 243 Editing, copying, or deleting a basal pattern
- 244 Changing from one basal pattern to another

■ **Additional bolus features**

- 249 Bolus types
- 250 Bolus type example
- 250 Bolus settings
- 250 Bolus increment
- 251 Bolus speed
- 252 Changing the Bolus Wizard settings
- 252 Changing the carb ratio
- 252 Changing the insulin sensitivity factor
- 253 Changing the BG target
- 254 Changing the active insulin time
- 255 Square Wave bolus
- 255 Turning the Square Wave bolus feature on or off
- 256 Delivering a Square Wave bolus using the Bolus Wizard feature
- 257 Delivering a Square Wave bolus using the Manual bolus feature
- 259 Dual Wave bolus

- 259 Turning the Dual Wave bolus feature on or off
- 259 Delivering a Dual Wave bolus using the Bolus Wizard feature
- 261 Delivering a Dual Wave bolus using the Manual bolus feature
- 263 Easy bolus
- 263 Setting up the Easy bolus feature
- 265 Delivering a bolus using the Easy bolus feature
- 266 Preset bolus
- 266 Setting up and managing preset bolus deliveries
- 269 Delivering a preset bolus
- 270 Stopping a Square Wave or Dual Wave bolus delivery

■ Troubleshooting

- 275 Pump issues
- 279 Sensor issues

■ Maintenance

- 285 Pump maintenance
- 285 Cleaning the pump
- 286 Storing the pump
- 288 Pump disposal
- 288 Meter maintenance
- 288 Unpairing a meter from the pump
- 290 Deleting the pump from a meter
- 290 Transmitter and sensor maintenance
- 290 Unpairing the transmitter from the pump
- 291 Disconnecting the transmitter from the sensor
- 291 Removing the sensor
- 291 Cleaning the transmitter
- 291 Storing the transmitter
- 291 Removing the battery

■ **Appendix A: List of alarms, alerts, and messages**

- 295 Pump alarms, alerts, and messages
- 307 CGM (sensor) alarms, alerts, and messages
- 315 SmartGuard feature alerts and messages
- 318 CareLink software alert and message

■ **Appendix B: Product specifications**

- 323 Specifications and default settings
- 323 Alarm and alert escalation
- 324 Altitude range
- 324 Backlight
- 324 Basal delivery
- 325 BG meter reading
- 325 Bolus delivery
- 326 Bolus Wizard feature default settings
- 326 Bolus Wizard feature specifications
- 329 Carb ratios
- 329 Delivery accuracy
- 331 Easy bolus feature
- 331 Environmental conditions
- 331 Essential performance
- 332 Expected service life
- 332 Filling the infusion set and cannula
- 332 Infusion pressure
- 332 Insulin delivery default settings
- 334 Low Reservoir reminder
- 334 Max bolus
- 334 Normal bolus
- 334 Occlusion detection
- 335 Percent temp basal

335	Program safety checks
335	Pump dimensions
335	Pump memory
335	Pump weight
336	Sensor default settings
337	Sound frequency
338	IEC 60601-1
338	IEC 60601-1-2, Special EMC Precautions for Medical Electrical Equipment
339	IEC 60601-1
339	IEC 60601-1-10: PCLCS
340	Guidance and manufacturer's declaration
343	Wireless communication
343	FCC notice
345	Open Source Software disclosure
345	Icon glossary

■ Appendix C: Menu map

349	Menu map
-----	----------

■ Appendix D: Performance data

355	MiniMed 780G system device performance
356	The SmartGuard feature
365	The Suspend before low feature
367	Guardian 4 System Performance
367	Clinical study overview
368	Sensor accuracy
370	Agreement when CGM reads "Below 50 mg/dL" or "Above 400 mg/dL"
370	Concurrence of SG and YSI™* values
372	Trend accuracy
373	Accuracy over time
374	Precision

374	Sensor Life
374	Safety
375	Alert performance
375	Glucose TRUE Alert Rate
377	Glucose FALSE Alert Rate
379	Glucose Correct Detection Rate
380	Glucose Missed Detection Rate

■ **Glossary**

■ **Index**

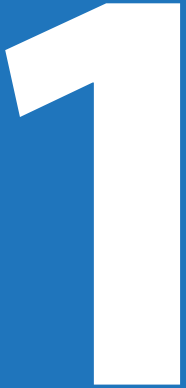

Safety and Indications

1

Safety and indications

This user guide describes the operation of the MiniMed 780G system with smart device connectivity and SmartGuard technology. SmartGuard technology adjusts insulin delivery based on sensor glucose (SG) values without the need to enter a blood glucose (BG) meter reading for confirmation. The MiniMed 780G insulin pump operates in Manual mode when the SmartGuard feature is not active. In Manual mode, always confirm SG readings with a BG meter before making treatment decisions.

Consult a healthcare professional before starting insulin pump therapy.

Important system information

Only use rapid-acting U-100 Humalog™* or U-100 NovoLog™* insulin with the MiniMed 780G system. For more information see *Insulin guidelines, page 57*.

The MiniMed 780G system uses the Guardian 4 sensor and Guardian 4 transmitter for continuous glucose monitoring. For more information see *Continuous glucose monitoring with Guardian 4 sensor, page 149*.

The Guardian 4 sensor does not require calibration. However, the system is designed to use every blood glucose (BG) meter reading either entered manually or received from a linked glucose meter to calibrate the sensor. For more information see *Calibrating the sensor, page 152*.

The Guardian 4 sensor is indicated for arm insertion only. For more information see *Inserting the sensor, page 169*.



CAUTION: The Guardian 4 sensor is indicated for arm use only. Do not use Guardian 4 sensor in the abdomen or other body sites including the buttocks, due to unknown or different performance that could result in hypoglycemia or hyperglycemia.



Only use MiniMed or Medtronic reservoirs and infusion sets that are specifically designed for use with the MiniMed 780G system. For more information on compatible reservoirs and infusion sets see *Consumables, page 57*.

Using this guide

Use the table of contents at the beginning of the user guide and the index at the end of the user guide to locate specific information.

Refer to the glossary for definitions of terms and acronyms used.

Conventions

Convention	Definition
Select	Press  to activate a screen item, accept a value, or initiate an action.
Select and hold	Press and hold  to perform an action.
Press	Press and release a button.
Press and hold	Press and hold a button.
Bold text	Indicates screen items and buttons, such as "Select Next to continue."
X	Indicates a value that might appear differently on the pump screen.
Note	Note: A note provides helpful information.
Caution	 CAUTION: A caution informs of a potential hazard which, if not avoided, might result in minor or moderate injury, or damage to the equipment.

Convention	Definition
WARNING	 WARNING: A warning informs of a potential safety hazard which, if not avoided, may result in serious injury or death. It may also describe potential serious adverse reactions.

For instructions about setting up devices on the MiniMed 780G system, such as a sensor or infusion set, refer to the user guide for the related device.

Emergency kit

Keep an emergency kit available at all times to confirm that necessary supplies are ready. Tell a family member or friend where to find the emergency kit.

When traveling, test blood glucose (BG) more frequently to accommodate for changes in activity levels and meal times.

Include the following items in the emergency kit:

- Rapid-acting glucose tablets
- BG monitoring supplies
- Urine or blood ketone monitoring supplies
- Extra infusion set and reservoir
- Extra new AA lithium or alkaline batteries, or fully charged NiMH batteries
- Insulin syringe and rapid-acting U-100 insulin (with dosage instructions from a healthcare professional)
- Adhesive dressing
- Glucagon



WARNING: Do not use the Bolus Wizard feature to calculate a bolus for a period of time after giving a manual injection of insulin by syringe or pen. Manual injections are not accounted for in the active insulin amount. Using the Bolus Wizard feature too soon after a manual injection may result in over-delivery of insulin and may cause hypoglycemia. Consult a healthcare professional for how long to wait after a manual injection before using the Bolus Wizard feature.



WARNING: Do not use the SmartGuard feature for a period of time after giving a manual injection of insulin by syringe or pen. Manual injections are not accounted for in the active insulin amount. Using the SmartGuard feature too soon after a manual injection may result in over-delivery of insulin and may cause hypoglycemia. Consult a healthcare professional for how long to wait after a manual injection before using the SmartGuard feature.

User safety



WARNING: Do not use the MiniMed 780G system until appropriate training has been received from a healthcare professional. Training is essential to ensure the safe use of the MiniMed 780G system.

Intended use

MiniMed 780G system

The MiniMed 780G system is intended for continuous delivery of basal insulin at selectable rates, and the administration of insulin boluses at selectable amounts for the management of type 1 diabetes mellitus in persons seven years of age and older requiring insulin. The system is also intended to continuously monitor glucose values in the fluid under the skin. The MiniMed 780G system includes SmartGuard technology, which can be programmed to automatically adjust insulin delivery based on continuous glucose monitoring (CGM) sensor glucose values and can suspend delivery

of insulin when the SG value falls below or is predicted to fall below predefined threshold values.

This MiniMed 780G system consists of the following devices:

- MiniMed 780G insulin pump
- Guardian 4 transmitter
- Guardian 4 sensor
- One-press serter
- Accu-Chek™* Guide Link blood glucose meter
- Accu-Chek™* Guide Test Strips

The system requires a prescription from a healthcare professional.



WARNING: Do not use the Suspend before low or Suspend on low features to prevent or treat low glucose. Always follow the instructions of a healthcare professional to treat low glucose. Using Suspend before low or Suspend on low features to prevent or treat low BG may result in prolonged hypoglycemia.

Guardian 4 sensor

The Guardian 4 sensor is intended for use with the MiniMed 780G system and the Guardian 4 transmitter to monitor glucose levels for the management of diabetes.

The sensor is intended for single use and requires a prescription. The Guardian 4 sensor is indicated for **up to** seven days of continuous use.

The Guardian 4 sensor is not intended to be used directly to make therapy adjustments while the MiniMed 780G is operating in manual mode. All therapy adjustments in manual mode should be based on measurements obtained using a blood glucose meter and not on values provided by the Guardian 4 sensor.

The Guardian 4 sensor has been studied and is approved for use in the systems, insertion sites, and ages listed in the following table.

System	Approved Age	Sensor Insertion Site
MiniMed 780G system	7 years and older	Arm

One-pressserter

Theserter is used as an aid for inserting the sensor. It is indicated for single-patient use and is not intended for multiple patient use.

Guardian 4 transmitter

The Guardian 4 transmitter is intended for use with the MiniMed 780G system and Guardian 4 sensor to monitor glucose levels for the management of diabetes.

Accu-Chek™* Guide Link Blood Glucose Monitoring System

The Accu-Chek™* Guide Link Blood Glucose Monitoring System is comprised of the Accu-Chek™* Guide Link meter and the Accu-Chek™* Guide test strips.

The Accu-Chek™* Guide Link Blood Glucose Monitoring System is intended to quantitatively measure glucose in fresh capillary whole blood from the fingertip, palm, and upper arm as an aid in monitoring the effectiveness of glucose control.

The Accu-Chek™* Guide Link Blood Glucose Monitoring System is intended for in vitro diagnostic single-patient use by people with diabetes.

The Accu-Chek™* Guide Link Blood Glucose Monitoring System is intended to be used by a single person and should not be shared.

This system is not for use in diagnosing or screening for diabetes mellitus and not for neonatal use.

Alternative site testing should be done only during steady-state times (when glucose is not changing rapidly).

The Accu-Chek™* Guide Link Blood Glucose Monitoring System is intended to be used to wirelessly transmit glucose values to the MiniMed 780G system and MiniMed 770G system with Bluetooth™* wireless technology through the use of Bluetooth™* low energy communication.

**WARNINGS:**

- Do not use Alternative Site Testing to calibrate a continuous glucose monitoring system.
- Do not use Alternative Site Testing to make insulin dosing calculations.

Contraindications

The MiniMed 780G system is contraindicated for use in persons under age seven.

Pump therapy is not recommended for people whose vision or hearing does not allow for the recognition of pump signals, alerts, or alarms.

Do not use theserter to insert sensors other than the Guardian 4 sensor. Medtronic cannot guarantee the safety or efficacy of this product if used with other sensors.

The reservoir is contraindicated for the infusion of blood or blood products.

Infusion sets are indicated for subcutaneous use only and not for intravenous (IV) Infusion.

Infusion sets are not indicated for the infusion of blood or blood products.

Insulin pump therapy is not recommended for persons who are unwilling or unable to perform BG meter readings.



WARNING: Do not use the SmartGuard feature for people who require less than eight units or more than 250 units of total daily insulin per day. A total daily dose of at least eight units, but no more than 250 units, is required to use the SmartGuard feature.

Pump therapy is not recommended for people who are unwilling or unable to maintain contact with their healthcare professional.

Intended target population

The intended target population for the MiniMed 780G insulin pump includes children and adolescents ages 7-17 years and adults ages 18 years and older who are responsive to insulin delivered subcutaneously.

Risks and side effects

Risks related to insulin administration and pump use

Risks related to insulin infusion and potential interruptions of insulin delivery include:

- Hypoglycemia
- Hyperglycemia
- Diabetic ketoacidosis
- Seizure
- Coma
- Death

Risks related to insulin pump infusion set

Risks related to insulin pump infusion set use include:

- Localized infection
- Skin irritation or redness
- Bruising
- Discomfort or pain
- Bleeding
- Irritation
- Rash
- Occlusions that may interrupt insulin delivery and lead to hyperglycemia and diabetic ketoacidosis

Follow the instructions in the provided user guides for the insertion and care of infusion sets. If an infusion site becomes irritated or inflamed, dispose of the infusion set in a sharps container, and select a different location to insert a new infusion set.

Risks related to sensor use

Risks related to sensor use include:

- Skin irritation or other reactions
- Bruising
- Discomfort
- Redness
- Bleeding
- Pain
- Rash
- Infection
- Raised bump
- Appearance of a small freckle-like dot where needle was inserted
- Fainting secondary to anxiety or fear of needle insertion
- Allergic reaction
- Soreness or tenderness
- Swelling at insertion site
- Sensor filament fracture, breakage, or damage
- Minimal blood splatter associated with sensor needle removal
- Residual redness associated with adhesive or tapes or both
- Scarring

Specific risks related to sensor use

Do not use continuous glucose monitoring if hydroxyurea, also known as hydroxycarbamide, is taken. Hydroxyurea is used to treat certain diseases, such as cancer and sickle cell anemia. Hydroxyurea use results in higher sensor glucose

readings compared to blood glucose readings. Taking hydroxyurea while using continuous glucose monitoring can result in hypoglycemia caused by over-delivery of insulin, inaccurate or missed alarms and alerts, delay or loss of sensor-enabled insulin suspension, and substantially higher sensor glucose readings in reports than actual blood glucose readings.

Always check the label of any medication being taken to confirm if hydroxyurea or hydroxycarbamide is an active ingredient. If hydroxyurea is taken, consult a healthcare professional. Turn the Sensor feature off to disable continuous glucose monitoring. For more information, see *Turning the Sensor feature on or off*, page 162. Use additional blood glucose meter readings to verify glucose levels.

Consult a healthcare professional if a medication that contains acetaminophen or paracetamol is taken while wearing the sensor. Medications that contain acetaminophen or paracetamol can falsely raise sensor glucose readings. The level of inaccuracy depends on the amount of acetaminophen or paracetamol active in the body and can differ for each person. Falsely elevated sensor readings can result in over-delivery of insulin, which can cause hypoglycemia. Medications that contain acetaminophen or paracetamol include, but are not limited to, cold medicines and fever reducers. Check the label of any medications being taken to see if acetaminophen or paracetamol is an active ingredient. Use additional blood glucose meter readings to confirm blood glucose levels.

While the SmartGuard feature is active, if acetaminophen or paracetamol is taken, program a temp target for up to eight hours, or the amount of time recommended by a healthcare provider. For more information, see *Setting a temp target*, page 196. Use blood glucose values instead of sensor glucose readings to calculate a meal bolus or correction bolus up to eight hours, or the duration recommended by a healthcare provider, after taking acetaminophen or paracetamol.

Do not use SG values to make treatment decisions, including delivering a bolus, while the pump is in Manual mode. When the SmartGuard feature is active and you are no longer in Manual mode, the pump uses an SG value, when available, to calculate a bolus amount. However, if your symptoms do not match the SG value, use a BG meter to confirm the SG value. Failure to confirm glucose levels when your symptoms do not match the SG value can result in the infusion of too much or too little insulin, which may cause hypoglycemia or hyperglycemia. For more information on using CGM, see

Continuous glucose monitoring with Guardian 4 sensor, page 149. For more information on using the SmartGuard feature, see *SmartGuard, page 179.*

For persons 7 years of age and older, the upper arm insertion site showed optimal performance in the clinical study. Do not insert the sensor into any other location.

Risks related to meter use

- For the most current risks, see the User's Manual that came with the device.
- A list of warnings for the meter are provided in the meter section, see *Meter, page 50.*



WARNINGS:

- Do not use Alternative Site Testing to calibrate a continuous glucose monitoring system.
- Do not use Alternative Site Testing to make insulin dosing calculations.

Risks related to serter use

General risks with serter use may include skin infection around the area where the serter is used.

Risks related to the MiniMed 780G system

- Hypoglycemia
- Hyperglycemia
- Diabetic ketoacidosis
- Seizure
- Coma
- Death

Removing the pump for temporary storage

If there is a need or desire to remove the pump, use the following guidelines:

- Write down the current basal rates and use the Save Settings feature. For more information, see *Saving the settings, page 207*.
- Remove the battery. For more information, see *Storing the pump, page 286*.
- If the pump is disconnected for less than one hour, an insulin adjustment may not be required. If the pump is disconnected for more than one hour, consult a healthcare professional to determine an alternate method of insulin delivery.

General warnings

Pump

- Do not use the pump in the presence of anesthetic mixtures that include oxidizing agents such as oxygen or nitrous oxide. Exposure to these conditions may damage the pump and result in serious injury.
- Always use the fingertip for blood samples when entering a BG meter reading into the pump while using the SmartGuard feature. Blood samples from other locations, such as the palm or forearm, have not been studied for use with the SmartGuard feature, and the accuracy of these samples is unknown.
- When the SmartGuard feature is active, SG readings are used to calculate basal insulin delivery and correction boluses. Do not use SG readings to make treatment decisions while the pump is in Manual mode. SG and BG values may differ. Sensor performance may occasionally vary from sensor to sensor and in different situations for a sensor, such as on the first day of use.

A BG meter reading is required in the following situations:

- Before a correction bolus is given in Manual mode.
- The SG reading is lower than expected.
- The SG reading is higher than expected.
- Suspected hypoglycemia or symptoms of hypoglycemia.
- Suspected hyperglycemia or symptoms of hyperglycemia.
- Suspected diabetic ketoacidosis or symptoms of diabetic ketoacidosis.

Do not use SG readings to make treatment decisions while the pump is in Manual mode.

- The low SG alert functionality is distinct from the automated insulin dosing function of the MiniMed 780G system. When using the SmartGuard feature, the MiniMed 780G system has been shown to be safe and effective for its intended use in this population. However, do not rely solely on the use of the Low SG alarm, or the use of “Alert on Low” and “Alert before Low” when those alerts are set at or below 60 mg/dL. At these BG levels, a low SG alarm or alert may not reflect the user’s true BG, and you may not be notified. Do not ignore symptoms of low glucose. Always confirm SG readings with a BG meter, and treat according to the recommendation of a healthcare professional. Solely relying on these SG alerts and readings for treatment decisions could result in missing severe hypoglycemia (low BG) events.
- Do not rely on the pump tones or vibrations to navigate the pump screens or menus. Relying on pump tones or vibrations may result in incorrect menu or setting selection. Always view the pump screen when selecting menus and entering information into the system.
- Only use rapid-acting U-100 insulin (Humalog™* and NovoLog™*) prescribed by a healthcare professional for use with an infusion pump. Use of any other drug or medication in the reservoir can cause serious injury.
- Confirm that the infusion set is disconnected from the body before rewinding the pump or filling the infusion set tubing. Never insert the reservoir into the pump while the tubing is connected to the body. Doing so may result in an accidental infusion of insulin, which may cause hypoglycemia.
- Do not insert the reservoir before rewinding the pump. Doing so may result in an accidental infusion of insulin, and may result in hypoglycemia.
- Do not use the MiniMed 780G insulin pump or additional system devices next to other electrical equipment, which may cause interference. This includes mobile communication devices such as cell phones that are not paired with the MiniMed 780G system, GPS navigation systems, anti-theft systems, radio-frequency identification (RFID) systems, and any electrical equipment that has an output transmitter power greater than 1 W. The recommended separation distance between the insulin pump and common RF emitters is 12 in (30 cm). For more information about recommended separation distance guidelines between

the insulin pump and common RF emitters, see *Guidance and manufacturer's declaration*, page 340. Other electrical equipment that may compromise normal system operation has been contraindicated. For more information, see *Exposure to magnetic fields and radiation*, page 52.

- Do not unscrew or retighten the tubing connector on the reservoir while the infusion set is connected to the body. Doing so may result in an accidental infusion of insulin, and may cause hypoglycemia.
- Do not use standard Luer sets with the MiniMed 780G system. Only use MiniMed or Medtronic reservoirs and infusion sets that are specifically designed for use with the MiniMed 780G system.
- Do not change or modify the MiniMed or Medtronic reservoir and infusion set. Modification of these components may cause serious injury, interfere with device operation, and void the warranty.
- Do not rely on preset pump alarms or reminders alone to check BG levels. Set additional reminders on other devices, such as a cell phone.
- Do not change or modify the internal RF transmitter or antenna. Doing so may interfere with the safe operation of the equipment.
- The MiniMed 780G system is approved for use with the Guardian 4 transmitter with Bluetooth™ wireless technology (MMT-7841). Use of a transmitter not approved for communication with the pump may cause damage to system components and may result in inaccurate SG readings.
- If other devices that employ radio frequencies are in use, such as cell phones that are not paired with the MiniMed 780G system, cordless phones, walkie-talkies, and wireless networks, they may prevent communication between the transmitter and the insulin pump. This interference does not cause any incorrect data to be sent and does not cause any harm to devices. Moving away from, or turning off, these other devices may enable communication. Contact 24-Hour Technical Support if RF interference continues.
- Special Precautions regarding Electromagnetic Compatibility (EMC): This body-worn device is intended to be operated within a residential, domestic, public or work environment, where common levels of radiated "E" (V/m) or "H" fields

(A/m) exist. Technologies that emit these fields include: cellular phones that are not paired with the MiniMed 780G system, wireless technology, electric can openers, microwaves, and induction ovens. The MiniMed 780G system generates, uses, and can radiate radio frequency energy and, if not installed and used in accordance with the provided instructions, may cause harmful interference to radio communications.

- Portable and mobile RF communications equipment can affect the operation of the MiniMed 780G system. If interference occurs, move away from the RF transmitter.
- The MiniMed 780G insulin pump can generate, use, and radiate radio frequency energy and, if not installed and used in accordance with the instructions, may cause harmful interference to radio communications. If the MiniMed 780G insulin pump does cause interference to radio or television reception, try to correct the interference by one or more of the following measures:
 - Decrease the distance between the transmitter and the insulin pump to 6 feet (1.8 meters) or less.
 - Decrease the distance between the meter and the insulin pump to 6 feet (1.8 meters) or less.
 - Increase the separation between the transmitter and the device that is receiving/emitting interference.
- The safety of the MiniMed 780G system has not been studied in persons with impaired kidney function. Persons with kidney disease should consult a healthcare professional to determine if the potential benefits of pump therapy outweigh the risks.
- Monitor for diabetic retinopathy. During the beginning of insulin pump therapy, rapid improvement in glucose control and reduction in A1c may result in worsening of existing diabetic retinopathy. Use of the MiniMed 780G system has been associated with rapid improvement in glucose control. Monitor for diabetic retinopathy with retinal eye examinations and if necessary adequate treatment must be performed by a healthcare professional before beginning a treatment with the MiniMed 780G insulin pump.

- The safety of the MiniMed 780G system has not been studied in pregnant women, persons with type 2 diabetes, or in persons using other anti-hyperglycemic therapies that do not include insulin. Persons in these situations should consult a healthcare professional to determine if the potential benefits of pump therapy outweigh the risks.
- The safety of using the Suspend before low and Suspend on low features in patients who have no pump experience is not known. The Suspend before low and Suspend on low features should not be used if insulin pump settings have not been previously established. Insulin pump settings include basal rates, insulin to carb ratio, and insulin sensitivity factors. Consult a healthcare professional before using the Suspend before low or Suspend on low features.
- If a serious incident related to the device occurs, immediately report the incident to a healthcare professional. Serious incidents may include death, temporary or permanent serious decline in health, or a serious public health threat. For healthcare professionals, immediately report any serious incident to the applicable competent authority.
- The user must have adequate vision and hearing in order to recognize all functions of the pump, including alerts, alarms, and reminders. Not recognizing an alert, alarm, or reminder could result in a hypoglycemic or hyperglycemic event.

Reservoir and infusion sets

See the user guides that came with the device for the most current warnings related to the reservoir and infusion set.

- If insulin, or any other liquid, gets inside the tubing connector, it can temporarily block the vents that allow the pump to properly fill the infusion set. This may result in the infusion of too little or too much insulin, and may result in hyperglycemia or hypoglycemia. If this occurs, start over with a new reservoir and infusion set.
- Do not reinsert the introducer needle into the infusion set. Reinsertion may cause tearing of the soft cannula, which may cause unpredictable insulin delivery, and may result in hypoglycemia or hyperglycemia.
- If a BG reading is unexpectedly high during the infusion of insulin or if an occlusion alarm occurs, check the infusion set for clogs and leaks.

If in doubt, change the infusion set in case the soft cannula is dislodged, crimped, or partially clogged. Consult a healthcare professional to create a plan for rapid insulin replacement in the event this occurs. Check BG to confirm that the appropriate amount of insulin has been administered.

- Do not reuse the infusion set. Reuse of the infusion set may damage the cannula or needle, and lead to infection, site irritation, and inaccurate insulin delivery.
- Dispose of the transfer guard safely in a sharps container.
- Do not fill the infusion set tubing or attempt to free a clogged line while the set is inserted into the body. Filling the infusion set tubing while it is connected to the body may cause an unintended infusion of insulin, and result in hypoglycemia.
- Keep the infusion set away from contact with disinfectants, perfumes, or deodorant. These products may affect the integrity of the infusion set, and result in inaccurate insulin delivery and cause hypoglycemia or hyperglycemia.
- Do not clean, reuse, or re-sterilize the infusion set and introducer needle. Reuse of the infusion set or introducer needle can lead to infection, insulin degradation, and inaccurate insulin delivery. Always dispose of the infusion set and introducer needle directly in a sharps container after use.
- Store infusion sets in a cool, dry place. Do not leave infusion sets in direct sunlight, inside a vehicle, or in other environments subject to excessive heating.
- Only use reservoir and infusion sets manufactured or distributed by Medtronic Diabetes. The pump has been tested to operate when used with compatible reservoirs and infusion sets. Medtronic Diabetes cannot guarantee appropriate operation if the pump is used with reservoirs or infusion sets offered by third parties. Medtronic Diabetes is not responsible for any injury or pump malfunction that may occur in association with the use of incompatible components.
- Always wash hands with soap and water before temporarily disconnecting the infusion set. Consult a healthcare professional for ways to compensate for missed insulin while the infusion set is disconnected to prevent hyperglycemia.
- Monitor BG levels when the infusion set is disconnected, and after the infusion set is reconnected to the body.

- Do not clean, reuse, or re-sterilize the reservoir or transfer guard after use. The reservoir and transfer guard are sterile, non-pyrogenic, and for single use only. Reusing the reservoir or transfer guard may lead to insulin degradation, infection, inaccurate insulin delivery, and may damage the pump.
- Always follow the instructions for insertion of the infusion set. Improper insertion of the infusion set or improper maintenance of the infusion site can result in infection and inaccurate insulin delivery.
- If using the infusion set for the first time, perform the first set-up in the presence of a healthcare professional.
- Before use, fill the infusion set tubing to remove all air from the set.
- Do not use the insulin, infusion set, and reservoir longer than the duration of use indicated. Check the corresponding user guide or labeling for more information. Replace the insulin, infusion set, and reservoir according to the shortest duration of use indicated. Using the insulin, infusion set, or reservoir longer than the indicated duration of use can increase the risk of set occlusions and cause problems with insulin absorption, which can lead to severe hyperglycemia and diabetic ketoacidosis.
- Do not change the infusion set just before bedtime without checking BG one to three hours after insertion.
- Confirm sterility by checking that the sterile paper and tamper-proof seal are not damaged.
- The infusion set is sterile and non-pyrogenic unless the package has been opened or damaged. Do not use if the package has been opened or damaged, or if the tubing connector needle is damaged. If the package has been opened or damaged, or if there is damage to the infusion set, start over with a new infusion set.
- Before insertion, clean the insertion site with isopropyl alcohol.
- Check frequently to confirm that the soft cannula remains firmly in place. If the soft cannula becomes dislodged or is improperly inserted, the full amount of insulin may not be delivered, which may result in hyperglycemia.

- When unwinding MiniMed Mio infusion set tubing, use caution as a hard pull of the tubing can result in damage to the infusion set and introducer needle. Confirm that the infusion set is properly in place when the tubing is fully released.
- If the infusion site becomes inflamed, replace the set and use a new site until the first site has healed. Replace the infusion set if the tape becomes loose or if the soft cannula becomes fully or partially dislodged from the skin.
- Check the infusion set to confirm that no air bubbles are present in the tubing. Air in the tubing may result in inaccurate insulin delivery, and result in hyperglycemia.
- Never point a loaded insertion device towards a body part where insertion is not desired.
- Remove the needle guard before inserting the infusion set.

Sensor andserter

For the most current warnings, see the user guide that came with the device.

- Do not attempt to connect a transmitter that is not compatible with the sensor. The sensor is designed to work with approved transmitters only. Connecting the sensor to a transmitter that is not approved for use with the sensor may damage the components.
- Consult a healthcare professional if a medication that contains acetaminophen or paracetamol is taken while wearing the sensor. Medications that contain acetaminophen or paracetamol can falsely raise sensor glucose readings. The level of inaccuracy depends on the amount of acetaminophen or paracetamol active in the body and can differ for each person. Falsely elevated sensor readings can result in over-delivery of insulin, which can cause hypoglycemia. Medications that contain acetaminophen or paracetamol include, but are not limited to, cold medicines and fever reducers. Check the label of any medications being taken to see if acetaminophen or paracetamol is an active ingredient. Use additional blood glucose meter readings to confirm blood glucose levels.

While the SmartGuard feature is active, if acetaminophen or paracetamol is taken, program a temp target for up to eight hours, or the amount of time recommended by a healthcare provider. For more information, see *Setting a temp target*, page 196. Use blood glucose values instead of sensor glucose readings to calculate a meal

bolus or correction bolus for up to eight hours, or the duration recommended by a healthcare provider, after taking acetaminophen or paracetamol.

- Always inspect the packaging for damage prior to use. Sensors are sterile and non-pyrogenic, unless the package has been opened or damaged. If the sensor packaging is open or damaged, discard the sensor directly into a sharps container. Use of a non-sterile sensor may result in infection at the insertion site.
- Instructions for using the One-pressserter (MMT-7512N) are different from other Medtronic insertion devices. Failure to follow directions, or using a differentserter, may result in improper insertion, pain, or injury.
- Confirm that the sensor is securely placed in theserter to avoid improper insertion, pain, or minor injury.
- Do not allow children to put small parts in their mouth. This product poses a choking hazard for young children.
- Healthcare professionals and caregivers:
 - Always wear gloves to insert the sensor. A retractable needle is attached to the sensor. Minimal bleeding may occur.
 - Cover the sensor with sterile gauze to remove the needle housing from the sensor.
- Place the needle housing directly into a sharps container after sensor insertion to prevent accidental needle stick injury.
- Watch for bleeding at the insertion site (under, around, or on top of the sensor). If bleeding occurs, do the following:
 1. Apply steady pressure, using sterile gauze or a clean cloth placed on top of the sensor, for up to three minutes. The use of unsterile gauze can cause site infection.
 2. If bleeding stops, connect the transmitter to the sensor. If bleeding does not stop, do not connect the transmitter to the sensor because blood can get into the transmitter connector, and may damage the device.
- If bleeding continues, causes excessive pain or discomfort, or blood is significantly visible in the plastic base of the sensor, do the following:

1. Remove the sensor and continue to apply steady pressure until the bleeding stops. Discard the sensor in a sharps container.
 2. Check the site for redness, bleeding, irritation, pain, tenderness, or inflammation. Treat based on instructions from a healthcare professional.
 3. Insert a new sensor in a different location.
- Wear gloves when inserting the sensor into someone other than yourself to avoid contact with patient blood. Minimal bleeding may occur. Contact with patient blood can cause infection.
 - Never point a loaded serter toward any body part where insertion is not desired. An accidental button-push may cause the needle to inject the sensor in an undesired location and cause minor injury.
 - The safety of sensor use in critically ill patients is not known. Sensor use in critically ill patients is not recommended.

Transmitter

See the user guide included with the device for the most current warnings related to transmitter use.

- Always refer to the sensor user guide for all precautions, warnings, and instructions related to the sensor. Not referring to the sensor user guide can result in serious injury or damage to the sensor.
- Do not allow children to put small parts in their mouth. This product may pose a choking hazard that can result in serious injury or death.
- Do not change or modify the device. Modifying the device can cause serious injury, interfere with the ability to operate the device, and void the warranty.
- Do not use the tester if it comes into contact with blood. Contact with blood may cause infection. If the tester comes into contact with blood, dispose directly into a sharps container.
- Bleeding may occur after inserting the sensor. Always make sure that the site is not bleeding before connecting the transmitter to the sensor. Blood can get into the transmitter connector and damage the device. Discard the device if damaged. If

bleeding occurs, apply steady pressure with a sterile gauze, pad, or clean cloth at the insertion site until bleeding stops. After bleeding stops, connect the transmitter to the sensor.

- Do not discard the transmitter in a medical waste container or expose it to extreme heat. The transmitter contains a battery that may ignite and result in serious injury.
- Do not use the transmitter next to other electrical equipment that may cause interference. This includes mobile communication devices such as cell phones, GPS navigation systems, and other devices that have an output transmitter power greater than 1 W. Other electrical equipment that may compromise normal system operation has been contraindicated.

Meter

For the most current warnings, see the User's Manual that came with the device.

Always use the fingertip for blood samples when entering a BG meter reading into the pump while using the SmartGuard feature. Blood samples from other locations, such as the palm or forearm, have not been studied for use with the SmartGuard feature, and the accuracy of these samples is unknown.

Limitations

- Do not use the meter at high hematocrit levels above 65% or low hematocrit levels below 10%.
- Not for use in diagnosis or screening of diabetes mellitus.
- Not for neonatal use.
- Abnormally high concentrations of ascorbic acid (vitamin C) resulting in blood concentrations in excess of 5 mg/dL may cause inaccurate test results. If you are not sure please check with your doctor.
- Do not use the meter system to measure blood glucose in people who are experiencing cardiovascular collapse (severe shock) or decreased peripheral blood flow.
- Do not use this system during xylose absorption test.

- Not for use on critically ill patients, patients in shock, dehydrated patients, or hyperosmolar patients.
- This system has not been tested at altitudes higher than 10,150 feet.



CAUTION: Every BG reading provided to the pump is used to calibrate the sensor. Do not use Alternative Site Testing to calibrate a continuous glucose monitoring system. Do not use Alternative Site Testing to make insulin dosing calculations.

Potential Biohazard

- During normal testing, any blood glucose meter or lancing device may come in contact with blood. All parts of the kit are considered biohazardous and can potentially transmit infectious diseases from bloodborne pathogens, even after you have performed cleaning and disinfecting.^{1,2}
- The meter and lancing device should never be used by more than one person. Do not share the meter and lancing device with anyone, including family members, due to the risk of infection from bloodborne pathogens.^{1,2} Do not use on multiple patients!
- Cleaning and disinfecting the meter and lancing device destroys most, but not necessarily all, bloodborne pathogens.³

¹ FDA Public Health Notification: "Use of Fingerstick Devices on More than One Person Poses Risk for Transmitting Bloodborne Pathogens: Initial Communication: Update 11/29/2010." <http://wayback.archive-it.org/7993/20161022010458/http://www.fda.gov/MedicalDevices/Safety/AlertsandNotices/ucm224025.htm>. Accessed January 17, 2018.

² CDC Clinical Reminder: "Use of Fingerstick Devices on More than One Person Poses Risk for Transmitting Bloodborne Pathogens (2010)." <http://www.cdc.gov/injectionsafety/Fingerstick-DevicesBGM.html>. Accessed January 17, 2018.

³ Centers for Disease Control and Prevention (CDC): "Guideline for Disinfection and Sterilization in healthcare Facilities, 2008." Update: May 2019. William A. Rutala, Ph.D., M.P.H.,

- If the meter is being operated by a second person who is providing testing assistance to the user, the meter and lancing device should be cleaned and disinfected prior to use by the second person.
- Disinfect the meter and lancing device before allowing anyone else to handle them. Do not allow anyone else to test with the meter or lancing device.
- It is important to keep the meter and lancing device clean and disinfected. For instructions on how to clean and disinfect the meter and lancing device, see the chapter Meter and Lancing Device Cleaning and Disinfecting.
- Wash hands and dry thoroughly before and after handling the meter, lancing device, or test strips.

Exposure to magnetic fields and radiation

- Do not expose the pump, transmitter, or sensor to MRI equipment, diathermy devices, or other devices that generate strong magnetic fields (for example, x-ray, CT scan, or other types of radiation). Strong magnetic fields can cause the system to malfunction, and result in serious injury. If the pump is exposed to a strong magnetic field, discontinue use and contact 24-Hour Technical Support for further assistance.

Magnetic fields, and direct contact with magnets, may affect the accurate functioning of the system which may lead to health risks such as hypoglycemia or hyperglycemia.

- Remove the pump, sensor, transmitter, and meter before entering a room with x-ray, MRI, diathermy, or CT scan equipment. The magnetic fields and radiation in the immediate vicinity of this equipment can make the devices nonfunctional or damage the part of the pump that regulates insulin delivery, possibly resulting in over-delivery and severe hypoglycemia.

and David J. Weber, M.D., M.P.H., and the Healthcare Infection Control Practices Advisory Committee (HICPAC).

<https://www.cdc.gov/infectioncontrol/pdf/guidelines/disinfection-guidelines-H.pdf>.

Accessed September 23, 2019.

- Do not expose the pump to a magnet, such as pump cases that have a magnetic clasp. Exposure to a magnet may interfere with the motor inside the pump. Damage to the motor can cause the device to malfunction, and result in serious injury.
- Do not send the pump or transmitter through an x-ray scanning machine. The radiation can damage the pump components that regulate insulin delivery, and may result in over-delivery of insulin and hypoglycemia.
All system components, including the pump, transmitter, and sensor, must be removed prior to being screened with a full-body scanner. To avoid system removal, request an alternative screening method, if necessary.
- Carry the Medical emergency card provided with the device when traveling. The Medical emergency card provides critical information about airport security systems and pump use on an airplane. Not following the guidance on the Medical emergency card may result in serious injury.

General precautions

Pump alarms do not notify the patient of leaks in the infusion set or degradation of insulin. If BG is out of range, check the pump and the infusion set to confirm that the necessary amount of insulin is being delivered.

Check for adverse reactions where the pump comes into contact with skin. These reactions include redness, swelling, irritation, sensitization, rash, and other allergic reactions. Do not allow the pump to come into contact with skin wounds, as the pump materials have only been evaluated for safe contact with intact skin.



Note: If you drop your pump, be sure to monitor your glucose levels for the next four hours.

Waterproof capabilities

- The pump is waterproof at the time of manufacture and when the reservoir and tubing are properly inserted. It is protected against the effects of being underwater to a depth of up to 12 feet (3.6 meters) for up to 24 hours.

- If the pump is dropped, hit against a hard object, or otherwise damaged, the waterproof characteristics of the outer casing of the pump may be compromised. If the pump is dropped or might be damaged, carefully inspect it to confirm that there are no cracks before exposing the pump to water.
- This waterproof capability rating applies only to the pump.
- If water may have entered the pump or other pump malfunction is observed, check BG and treat high BG as necessary using an alternative source of insulin. Contact 24-Hour Technical Support for further assistance, and consult a healthcare professional about high or low BG levels or with any other questions about care.

Electrostatic discharge

- Very high levels of ESD can result in a reset of the pump's software and a pump error alarm. After clearing the alarm, confirm that the pump is set to the correct date and time, and that all other settings are programmed to the desired values. Following a pump reset, the SmartGuard feature will be unavailable for five hours to allow active insulin to be updated.
- For more information on pump alarms, see *Pump alarms, alerts, and messages*, page 295. Contact 24-Hour Technical Support with any problems entering pump settings.

Extreme temperatures

Exposure to extreme temperatures can damage the device. Avoid the following conditions:

- Pump storage temperature above 122 °F (50 °C) or below –4 °F (–20 °C).
- Pump operating temperature above 98.6 °F (37 °C) or below 41 °F (5 °C). Insulin solutions freeze near 32 °F (0 °C) and degrade at temperatures higher than 98.6 °F (37 °C). In cold weather, wear the pump close to the body and cover it with warm clothing. In a warm environment, take measures to keep the pump and insulin cool.
- Do not steam, sterilize, autoclave, or otherwise heat the pump.

Skin care products

Some skin care products, such as lotion, sunscreen, and insect repellents, can damage the plastic in the pump case. After using skin care products, wash hands prior to handling the pump. If a skin care product comes into contact with the pump, wipe it off as soon as possible with a damp cloth and mild soap. For instructions on cleaning the pump, see *Cleaning the pump*, page 285.

Infusion sets and sites, sensor, transmitter, and meter

Refer to the corresponding device user guide for all warnings, precautions, and instructions relating to the device. Failure to reference the corresponding device user guide can result in minor injury, or damage to the device.

Adverse reactions

Refer to the sensor user guide for adverse reactions related to sensor use. Failure to reference the sensor user guide may result in minor injury, or damage to the sensor.

Security precautions

The MiniMed 780G insulin pump system is designed with security features to help keep the system and the data secure. These security features in the insulin pump system are set in the factory and ready to use when the insulin pump is received. For example, when the pump communicates with other devices in the system, such as the BG meter, transmitter, or compatible mobile device, the data that it sends and receives is encrypted and protected by cyclic redundancy checks. This helps prevent other people from being able to see system data, or to interfere with insulin pump therapy.

To help keep the system secure, follow these instructions:

- Do not leave the insulin pump or the paired devices unattended.
- Do not share the pump, transmitter, or BG meter serial number.
- Do not connect the pump to any third-party devices not authorized by Medtronic.
- Do not use any software not authorized by Medtronic to control the system.
- Be attentive to pump notifications, alarms, and alerts because they may indicate that someone else is trying to connect to or interfere with the device.
- Disconnect the Blue Adapter from the computer whenever it is not being used.

- Use good cyber security practices; use anti-virus software and keep computer software up to date.
- Refer to the MiniMed Mobile App User Guide for information on how to keep the compatible mobile device safe to use with the Medtronic devices.

The pump only communicates with paired devices. The short time that it takes to pair the pump with other devices is a sensitive time for security. During this time, it is possible for an unintended device to pair with the pump. While Medtronic has designed security features into the system to prevent this, to keep the system safe during pairing always follow these instructions:

- Pair the transmitter, BG meter, or the compatible mobile device with the pump away from other people and devices.
- When the transmitter successfully pairs with the pump, the green LED on the transmitter stops blinking. If the green LED on the transmitter continues to blink for several minutes or more after it is successfully paired, it may have been paired with an unintended device. See *Unpairing the transmitter from the pump, page 290* to delete the transmitter from the pump and then follow the steps to pair it again.
- After pairing the BG meter or the compatible mobile device with the pump, make sure that the BG meter or compatible mobile device indicates that pairing was successful.

Consult a healthcare professional if there are symptoms of severe hypoglycemia or diabetic ketoacidosis, or suspect that the insulin pump settings, or insulin delivery changed unexpectedly.

If there is a concern that someone else is trying to connect to or interfere with the device, stop using it and contact 24-Hour Technical Support immediately.

Insulin guidelines



WARNING: Do not insert an insulin-filled reservoir into the pump, or connect an insulin-filled infusion set into the body, when training with the system. Doing so may result in the unintentional infusion of insulin, which may result in hypoglycemia. Start insulin therapy only when directed by a healthcare professional.

The MiniMed 780G system has been studied with, and is intended for use with, the following rapid-acting U-100 insulins:

- U-100 NovoLog™*
- U-100 Humalog™*

The use of any other insulin in the MiniMed 780G system has not been tested and is contraindicated for use with this device.



WARNING: Only use rapid-acting U-100 insulin (Humalog™* and NovoLog™*), as prescribed by a healthcare professional, in the MiniMed 780G system. Use of the incorrect type of insulin, or insulin with a greater or lesser concentration may result in over-delivery or under-delivery of insulin, which may result in hypoglycemia or hyperglycemia. Consult a healthcare professional with any questions about the type of insulin that is compatible with the pump.

Consumables

The pump uses disposable, single-use MiniMed and Medtronic reservoirs and infusion sets for insulin delivery.



WARNING: Only use reservoir and infusion sets manufactured or distributed by Medtronic Diabetes. The pump has undergone extensive testing to confirm appropriate operation when used with compatible reservoirs and infusion sets manufactured or distributed by Medtronic Diabetes. Medtronic Diabetes cannot guarantee appropriate operation if the pump is used with reservoirs or infusion sets offered by third parties and therefore Medtronic Diabetes is not responsible for any injury or malfunctioning of the pump that may occur in association with such use.

- **Reservoirs**—If using a Medtronic Extended infusion set, use the Medtronic Extended reservoir MMT-342, 3.0 mL (300-unit). Otherwise, use the MiniMed reservoir MMT-332A, 3.0 mL (300-unit).
- **Infusion sets**—Contact a healthcare professional for help in choosing a Medtronic Diabetes infusion set. Change the infusion set per the duration of use in the infusion set user guide.

The following table lists the compatible infusion sets. The MMT numbers may change if other compatible infusion sets become available.



Note: Some MMT numbers also include “A” versions, such as MMT-396, MMT-396A, and MMT-396AT, that are compatible with the pump system.

Type	MMT number
MiniMed Quick-set infusion set	MMT-386, MMT-387, MMT-394, MMT-396, MMT-397, MMT-398, MMT-399
MiniMed Silhouette infusion set	MMT-368, MMT-377, MMT-378, MMT-381, MMT-382, MMT-383, MMT-384
MiniMed Sure-T infusion set	MMT-862, MMT-864, MMT-866, MMT-874, MMT-876, MMT-884, MMT-886
MiniMed Mio infusion set	MMT-921, MMT-923, MMT-925, MMT-941, MMT-943, MMT-945, MMT-965, MMT-975

Type	MMT number
MiniMed Mio Advance infusion set	MMT 213A, MMT-242, MMT-243A, MMT-244A
Medtronic Extended infusion set	MMT-430A, MMT-431A, MMT-432A, MMT-433A, MMT-440A, MMT-441A, MMT-442A, MMT-443A

Other MiniMed 780G system devices

- **Accu-Chek™* Guide Link meter**–The meter sends BG meter readings to the pump.
- **Guardian 4 transmitter (MMT-7841)**–The transmitter pairs with the pump, collects data measured by the sensor, and wirelessly sends this data to monitoring devices. This device is required for CGM.
- **Guardian 4 sensor (MMT-7040)**–The sensor is a disposable, single-use device inserted just below the skin to measure glucose levels in interstitial fluid. This device is required for CGM. The Guardian 4 glucose sensor is the only sensor compatible with the Guardian 4 transmitter.

Accessories

The following accessories may be used with the MiniMed 780G system.

- **Pump clip**–The pump clip attaches to a belt and can be used to open the battery compartment.
- **Activity guard**–The activity guard helps to prevent the reservoir from being rotated or removed from the pump during physical activities.
- **Blue Adapter**–The Blue Adapter uploads system data to CareLink software through a USB port on a computer. Refer to the CareLink software user guide for setup and operation of the Blue Adapter.
- **MiniMed Mobile app (MMT-6101 for Android™* or MMT-6102 for iOS™*)**–The app provides a secondary display of insulin pump data and CGM, and uploads system data to CareLink software. The app can be installed on multiple mobile devices, but only one device can be paired with the pump at a time.

- **CareLink Connect app (MMT-6111 for Android™* or MMT-6112 for iOS™*)**—The app can be downloaded onto compatible mobile devices from the app store. Refer to the app user guide for setup and operation within the app. This optional app is available to care partners to view patient therapy data and to be notified of selected patient alerts. This app does not replace the real-time display of insulin pump or CGM data on the primary display device. All therapy decisions should be based on the primary display device. Refer to the local Medtronic Diabetes website for information about supported devices and operating systems.
- **Medtronic Diabetes Updater app (MMT-6121 for Android™* or MMT-6122 for iOS™*)**—The app can be paired with the pump to update the MiniMed 780G insulin pump software when a pump software update is available. Refer to the local Medtronic Diabetes website for information about supported devices and operating systems.

2



System overview

2

System overview

In this chapter, you will learn about the components of the system and some important concepts and terminology that you will need to understand when using the system.

What are the components of the MiniMed 780G system?

The following items are the main system components:

- **MiniMed 780G pump**—The pump delivers insulin into your body through the infusion set, based on the settings provided by your healthcare professional.
- **Infusion sets**—An infusion set connects to both the pump and your body. It carries the insulin as it is pushed out of the pump and delivers it.
- **Reservoirs**—The reservoir is filled with insulin and placed in the pump so that insulin can be delivered into your body through the infusion set.
- **Sensors and transmitter**—The sensor measures glucose in the fluid under your skin. The transmitter communicates with the pump through a wireless connection. The sensor and transmitter make up the continuous glucose monitoring (CGM) system.
- **Accu-Chek Guide Link meter**—Use this meter to measure the glucose in your blood. The meter sends this blood glucose (BG) information to your pump through a wireless connection.

The following diagram shows what the pump, meter, and sensor and transmitter look like and how you may wear them on your body. A diagram later in chapter 3 will show you more details about the infusion set and reservoir.

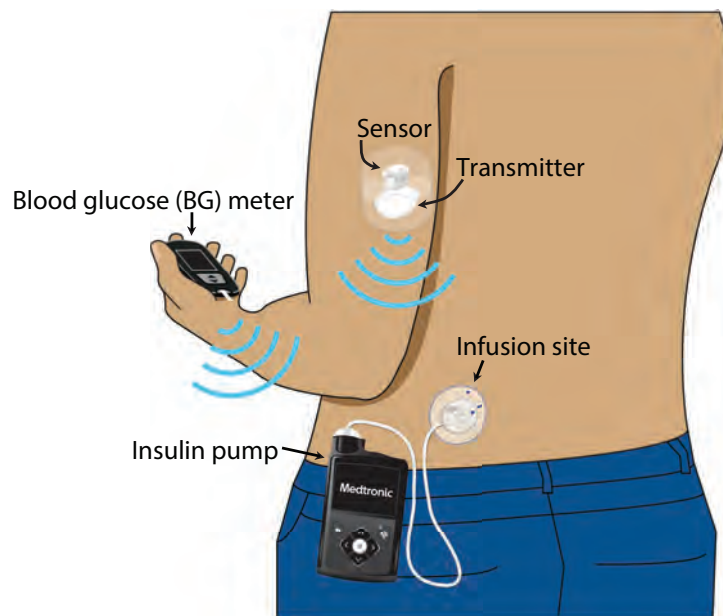

Modes

Your pump operates in two different modes: Manual mode and SmartGuard mode.

When you first use your MiniMed 780G insulin pump, it is in Manual mode. Manual mode refers to a group of features that requires your input to deliver boluses for meals and to correct glucose levels. You may use Manual mode with or without CGM. When using CGM in Manual mode, you can see sensor glucose trends, receive low and high sensor glucose alerts, and suspend insulin delivery according to your settings.

After several days of use in Manual mode, and at the direction of your healthcare provider, you can turn the SmartGuard mode on. When in SmartGuard, the pump automatically adjusts and delivers basal insulin and can also deliver automatic correction boluses to regulate glucose levels to a target SG value. You will still need to enter carbs that you eat to deliver a food bolus.

The following tables show the main features of Manual mode and the SmartGuard mode. There are details on each of these topics later in this guide.

Manual mode without CGM

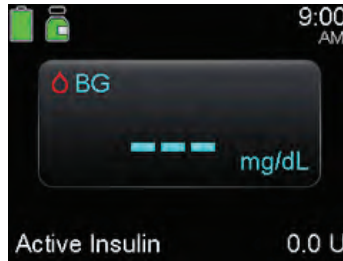

Bolus delivery options	Basal delivery features	Suspend options
<ul style="list-style-type: none"> Bolus Wizard calculates a bolus based on your settings <ul style="list-style-type: none"> A blood glucose (BG) meter reading is needed for a correction bolus A carb entry is needed for a food bolus Manual bolus 	<ul style="list-style-type: none"> Programmed basal delivery settings A Temp basal rate can be used to temporarily increase or decrease basal insulin delivery 	<ul style="list-style-type: none"> Manual suspend

Manual mode with CGM



Bolus delivery options	Basal delivery features	Suspend options
<ul style="list-style-type: none"> Same as Manual mode without CGM 	<ul style="list-style-type: none"> Same as Manual mode without CGM 	<ul style="list-style-type: none"> Manual suspend Suspend before low Suspend on low

SmartGuard



Bolus delivery options	Basal delivery features	Suspend options
<ul style="list-style-type: none"> SmartGuard bolus feature delivers bolus insulin based on sensor glucose (SG) values and carb entries A blood glucose (BG) meter reading may be required when a sensor glucose (SG) value does not appear on the Bolus screen The bolus amount cannot be adjusted The pump may automatically deliver an Auto Correction bolus to maximize the time in range. 	<ul style="list-style-type: none"> The pump automatically delivers basal insulin based on recent insulin delivery needs, Sensor glucose (SG) values, and your glucose target A Temp target can be set when less insulin is needed, such as for exercise 	<ul style="list-style-type: none"> Manual suspend

3



Pump basics

3

Pump basics

This chapter provides information about the basic features, buttons, and screens of the MiniMed 780G insulin pump.







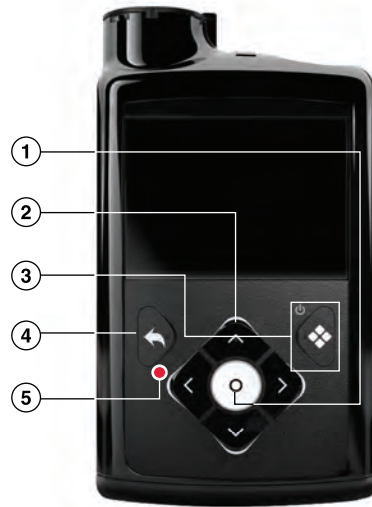





CAUTION: Do not use sharp objects to press the pump buttons. The use of sharp objects can damage the pump.

Using the buttons



The following table describes the notification light and how to use the pump buttons.

Item	Description
①	Press  to go to the Menu screen from the Home screen and to select a highlighted menu option.
②	Press  or  to scroll up or down, select an item on a screen, select the icons on the Menu screen, or to increase or decrease the value of a setting. Press  or  to move left or right on certain screens, or to select the icons on the Menu screen.
③	Press  to access the Graph screen. Press and hold  to put the pump in Sleep mode.
④	Press  to go back to the previous screen. Press and hold  to return to the Home screen.
⑤	The notification light  flashes when the pump has an alarm or alert. The notification light is not visible unless it flashes.

Sleep mode

The pump enters Sleep mode after two minutes to conserve battery power. Sleep mode does not affect insulin delivery. Press any button to wake up the pump. Press and hold  for two seconds to manually enter Sleep mode.

Pump delivery system

The following diagram shows the parts of the pump delivery system, including the infusion set*, reservoir, and pump.

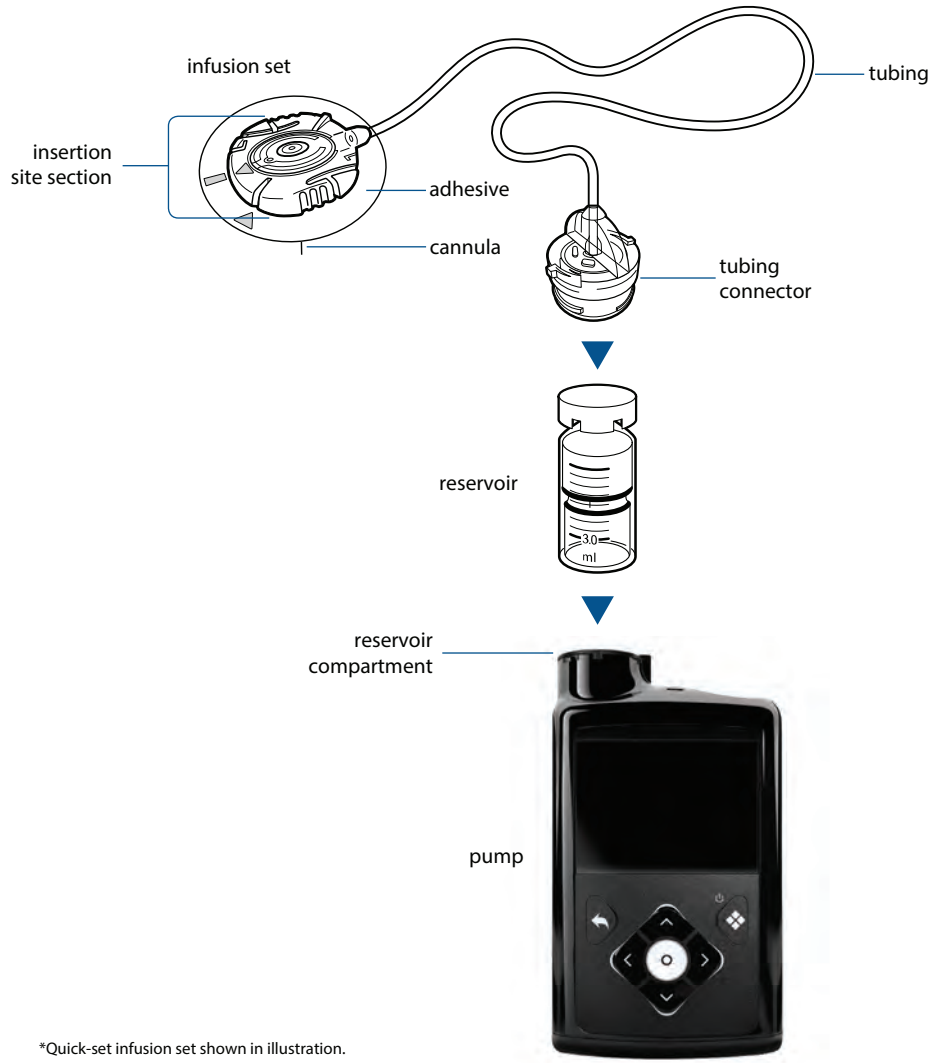

*Quick-set infusion set shown in illustration.

Infusion set

The infusion set consists of the following components:

- The tubing carries insulin from the reservoir into the body.
- The tubing connector attaches to the reservoir.
- The insertion piece attaches to the body.
- The cannula is a small, flexible tube inserted into the body. Some infusion sets use a small needle instead of a cannula.
- The adhesive holds the infusion set in place.

Change the infusion set according to the user guide provided with the infusion set.

Reservoir

The reservoir stores insulin for delivery and is inserted into the pump reservoir compartment.

Pump

Underneath the reservoir compartment, a piston pushes up on the bottom of the reservoir to move insulin into the tubing, through the cannula, and into the body.

The pump delivers small doses of insulin, as low as 0.025 units. The piston inside the pump must be rewound each time a newly filled reservoir is inserted into the reservoir compartment.

Inserting the battery

The pump requires one new AA (1.5 V) battery. For best results, use a new AA lithium (FR6) battery. The pump also accepts an AA alkaline (LR6) or a fully charged AA NiMH (HR6) nickel-metal hydride rechargeable battery.



CAUTION: Do not use a carbon zinc battery in the pump. Carbon zinc batteries are not compatible with the pump and can cause the pump to report inaccurate battery levels.



Note: Do not use cold batteries because the battery life may incorrectly appear low. Allow cold batteries to reach room temperature before they are inserted into the pump.

The battery cap is located in the pump box with the accessories.

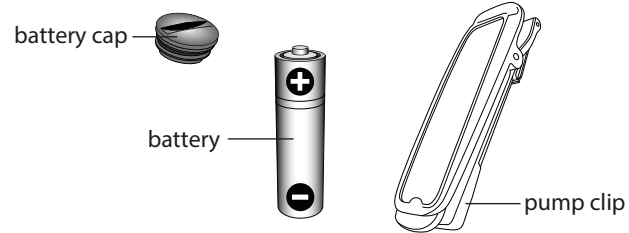

To insert the battery:

1. Insert a new or fully charged AA battery. Make sure to insert the negative end (-) first.

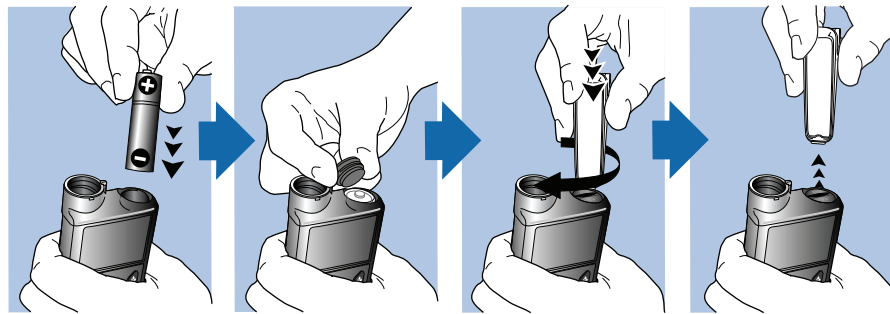

2. Place the battery cap onto the pump. Use the bottom edge of the pump clip or a coin to tighten the cap.



CAUTION: Do not overtighten or undertighten the battery cap. A battery cap that is too tight can cause damage to the pump case. A battery cap that is too loose can prevent detection of the new battery. Turn the battery cap clockwise until the cap slot is aligned horizontally with the pump case, as shown in the following example.

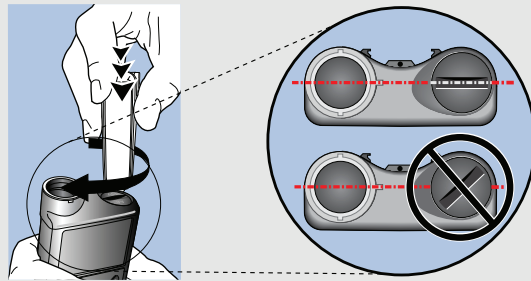

The first time a battery is inserted into the pump, the Startup Wizard begins. Any other time a battery is inserted into the pump, the Home screen appears and the pump resumes basal delivery.

Startup settings

The Startup Wizard appears after a battery is inserted for the first time. Use the Startup Wizard to set the language, time format, current time and date, and to rewind the pump. To re-enter these settings later, see *Pump issues*, page 275.

To use the Startup Wizard:

1. On the Select Language screen, select a language, and then press .



The Select Time Format screen appears.

2. Select a time format, and then press .

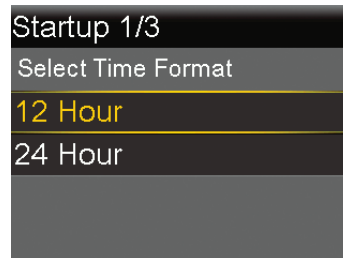

3. Enter the current time, and then select **Next**.



The Enter Date screen appears.

4. Enter the current date, and then select **Next**.



A "Rewinding" message appears. The piston returns to its start position in the reservoir compartment. This may take several seconds.



When rewinding is complete, a message appears to confirm the startup is complete.

5. Select **OK** to go to the Home screen.

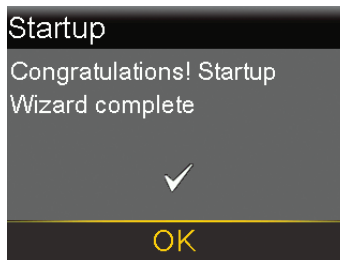

Home screen in Manual mode

The Home screen appears after the battery is changed, when the pump wakes from Sleep mode, and when another screen is not actively being used.



Note: This example shows the Home screen in Manual mode when the Sensor feature is turned off. For information about the Home screen when the Sensor feature is turned on, see *Home screen with CGM in Manual mode, page 152*. For information about the Home screen with the SmartGuard feature, see *Home screen with the SmartGuard feature, page 187*.



The following items appear on the Home screen:

Item	Description
Status icons	The status icons show a quick status of the pump system. For more information, see <i>Status icons</i> , page 78.
Current time	For details on setting the time, see <i>Time and date</i> , page 203.
BG readings	The current blood glucose (BG) meter reading is shown. The BG is either entered manually or received from a paired Accu-Chek™* Guide Link meter.
Active insulin	Active insulin is bolus insulin delivered by the insulin pump that continues to lower BG levels. Active insulin is not necessarily reflective of the pharmacokinetics and pharmacodynamics of rapid acting insulins. For more details on active insulin, see the description of Active Insulin Time in <i>Bolus Wizard settings</i> , page 103.











Shortcuts from the Home screen

The following table describes shortcuts that can be used to quickly access certain pump functions. These shortcuts only work on the Home screen.

Shortcut	Description
^	Press this button to access the Status screen.
>	Press this button to access the Time in Range screen when the Sensor feature is turned on.
✓	Press this button to access the Bolus screen. The Bolus screen that appears varies depending on the bolus feature that is currently active.







Status icons

The status icons provide the current status of the pump system. For information on viewing detailed status screens, see *Status screen, page 82*.

Icon name	Description
Active Insulin reset to zero	After the Active Insulin reset to zero alarm occurs,  appears on the Home screen and Bolus screens until the time shown in the alarm. For more information, see <i>Pump issues, page 275</i> .
Battery	The color and fill level of the icon indicate the charge level of the pump battery. As the battery is used, the icon changes from solid green in the following order:  <ul style="list-style-type: none"> The battery is full. The battery is low. The battery can be used for less than 30 minutes and needs to be replaced.
Reservoir	The reservoir icon shows the fill status of the MiniMed or Medtronic 3.0 mL (300-unit) reservoir. <ul style="list-style-type: none"> Approximately 85%–100% of the insulin remains in the reservoir. Approximately 71%–84% of the insulin remains in the reservoir. Approximately 57%–70% of the insulin remains in the reservoir. Approximately 43%–56% of the insulin remains in the reservoir. Approximately 29%–42% of insulin remains in the reservoir. Approximately 15%–28% of the insulin remains in the reservoir.

Icon name	Description
	<ul style="list-style-type: none"> • Approximately 1%–14% of the insulin remains in the reservoir. • The amount of insulin remaining in the reservoir is unknown.
Connection	<p>The connection icon shows the following information:</p> <ul style="list-style-type: none"> • The Sensor feature is on and communicating. • The Sensor feature is on, but the sensor is not communicating with the pump.
Temporary network connection	<p> The temporary network connection icon shows when the pump is temporarily connected to a remote upload device.</p>
Sensor status	<p>The sensor status icon shows whether the sensor is warming up, is monitoring sensor glucose (SG) values, a BG is required, or the sensor status is unavailable. The icon appears only when the Sensor feature is turned on.</p> <ul style="list-style-type: none"> • A solid green icon with a circle around it means the sensor is working and no action is required. • A red icon means a BG reading is required. • A question mark icon with a solid blue circle around it means that sensor information is unavailable. • An icon with three white dots on a black background means the pump is waiting for the sensor status to update.
Sensor life	<p>The number on the sensor life icon indicates the number of days that remain in the life of the sensor. The icon appears on the Status screen and only when the Sensor feature is turned on. After a new sensor is inserted, the icon is solid green. When one day remains in the life of the sensor, the icon turns red. When the sensor expires, the icon turns solid black with an X.</p>



Icon name	Description
	<p>If the number of days that remain in the life of the sensor is not yet available, such as when the sensor is warming up, the sensor life icon appears with three dots. </p> <p>If the number of days that remain in the life of the sensor is unknown, the sensor life icon appears with a question mark. </p>
Block mode	The Block mode icon  shows that the pump is locked. For more information about Block mode, see <i>Block mode</i> , page 204.
Suspend by sensor	<p>When the current low alert time segment has either the Suspend before low or Suspend on low feature turned on, the Suspend by sensor icon appears on the Home screen.</p> <p></p> <p>When Suspend before low or Suspend on low feature suspends insulin delivery, the icon flashes.</p> <p></p> <p>If the Suspend before low or Suspend on low feature is turned on but unavailable, the icon has a red X.</p> <p></p> <p>This can be due to a recent suspend by sensor event or when no SG values are available.</p> <p>For more information, see <i>The Suspend before low feature</i>, page 156 and <i>The Suspend on low feature</i>, page 158.</p>
Alert silence	The Alert silence icon  indicates that the Alert Silence feature is turned on and some alerts will not make a sound or vibration. Sensor alerts can be silenced for a specific duration using the Alert silence feature. For more information, see <i>Silencing sensor alerts</i> , page 173.











Note: Status icons provide limited information. For example, the reservoir icon may indicate the reservoir is low on insulin. The Status screen shows more detailed information about how many units are left. For more information about the status screens, see *Status screen*, page 82.

Menu screen

Use the menu to go to screens that show various features and functions of the system. Press  from the Home screen to go to the menu. The selected menu option appears in color. All other menu options appear in black and gray.



Use the menu to go to the following screens:

Menu selection	Menu icon	Description
Insulin		Deliver a bolus, set up and deliver basal insulin, suspend insulin delivery, and stop bolus during bolus delivery.
History & Graph		View history, SG review, graph, and time in range.
SmartGuard		Set up the SmartGuard feature.
Sound & Vibration		Set sound, vibrate, and volume options for notifications.
Reservoir & Set		Set up a new reservoir and infusion set, and fill a cannula.
Blood Glucose		Enter a BG value.
Status		View the status of the pump and other system features.
Paired Devices		Pair devices or CareLink software.
Settings		Set up device settings, delivery settings, and alert settings.











Menu map

Refer to *Menu map*, page 349 to see the menu map diagrams.

Sound & Vibration screen

The sound and vibration options are set on the Sound & Vibration screen. Sensor alerts can also be temporarily silenced. For information about silencing alerts, see *Silencing sensor alerts, page 173*. A status icon on the Home screen indicates when alerts are silenced. For more information, see *Status icons, page 78*.

To adjust the sound and vibration settings:

1. From the Home screen, press , and then select .
2. Adjust the volume:
 - a. Select **Volume**.
 - b. Press .
 - c. Press , , , or , and then press .
3. Select **Sound**, and then press  to turn the sound on or off.
4. Select **Vibration**, and then press  to turn the vibration on or off.

Status screen

The Status screen provides access to information about the pump and information about the sensor, if applicable. The Status screen also provides the option to suspend all insulin delivery or resume basal insulin delivery.

Use the Status screen to access the following screens or options:

Screen or option	Description
Stop Bolus	This option appears when a bolus delivery is in progress. Select Stop Bolus to stop the active bolus.
Suspend All Delivery or Resume Basal	This option indicates whether insulin delivery is currently suspended. Select Suspend All Delivery to suspend insulin delivery. Select Resume Basal to resume basal insulin delivery. For more information see <i>Suspending all insulin delivery and resuming basal insulin delivery, page 95</i> .

Screen or option	Description
SmartGuard Checklist screen	This screen shows a list of the required conditions before the pump can use the SmartGuard feature. For more information, see <i>SmartGuard Checklist</i> , page 184.
Pump status screen	This screen shows a detailed view of the pump status, the reservoir status, infusion set status, battery status, pump serial number, pump name, model number, and other pump details.
Sensor status screen	This screen appears when the Sensor feature is turned on. The Sensor status screen includes sensor life, transmitter battery life, and shows the serial number and version number of the transmitter.

To view the status screens:

1. From the Home screen, press , and then select .

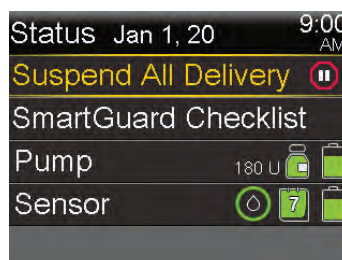

2. Press  or  to select a status screen, and then press .

4



Setting up insulin delivery

4

Setting up insulin delivery

This chapter explains how to use different types of insulin delivery.

Setting up basal insulin

Basal insulin is the “background” insulin that the body needs throughout the day and night to maintain target blood glucose (BG) meter readings when food is not eaten. Basal insulin accounts for approximately one half of daily insulin requirements. The MiniMed 780G insulin pump simulates a pancreas by delivering insulin continuously over 24 hours.



WARNING: The pump is intended to be used with a basal pattern. The basal pattern must be manually entered and saved into the pump. The pump will operate with a basal rate of 0.0 U/hr until a basal pattern is entered and saved. There is no reminder message to program basal rates. Consult a healthcare professional to determine what basal pattern is needed. For more information about basal patterns, see *Basal patterns, page 89*.

Basal rate



Basal rate is the specific amount of basal insulin that the pump continuously delivers each hour. While some people use one basal rate all day, others require different rates at different times of the day.

Basal rates are set in one or more basal patterns. Each basal pattern covers 24 hours. For specific information about basal patterns, see *Basal patterns, page 89*.

Max basal rate

The Max basal rate is the maximum amount of basal insulin that the pump can deliver per hour. Set the Max basal rate as indicated by a healthcare professional. It is not possible to set a basal rate, a temp basal rate, or a preset temp basal rate that would exceed the Max basal rate limit. After the basal patterns or preset temp basal rates are set, the Max basal rate cannot be lower than any of the existing basal rates. The Max basal rate can be set from 0 to 35 units per hour.

To set the Max basal rate:

1. From the Home screen, press , and then select .
2. Select **Delivery Settings** > **Max Basal/Bolus**.

The Max Basal/Bolus screen appears.



3. Select **Max Basal**.

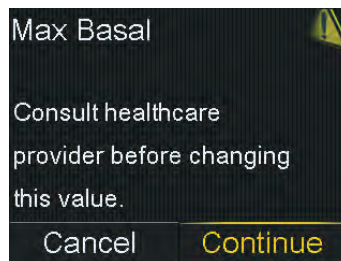

4. To continue to the Max Basal Rate screen, select **Continue**.
5. Select **Max Basal**, and then set the maximum number of basal insulin units per hour.



6. Select **Save**.

Basal patterns

The basal pattern determines the amount of basal insulin delivered throughout the day and night. A basal pattern is made up of one to 48 basal rates that are set to cover a full 24-hour period. Because basal insulin needs can vary, up to eight basal patterns can be set.

The following example represents one basal pattern with three basal rates set for three different time periods.

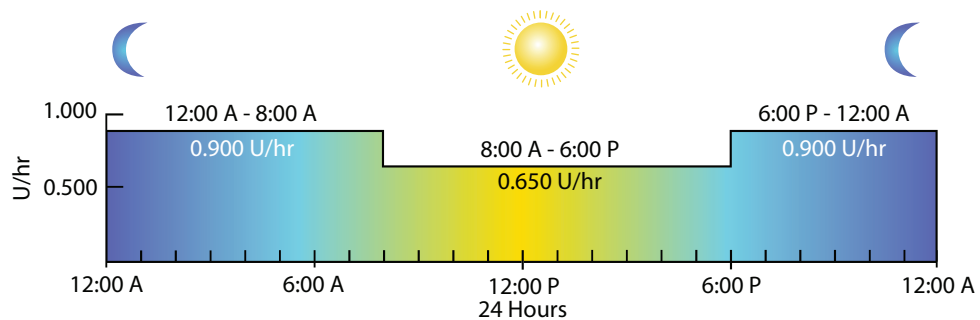

Consult a healthcare professional to determine the basal pattern. The basal pattern must be manually entered into the pump. There will be no reminder message to program basal rates.





WARNING: Confirm a basal pattern is entered. If a basal pattern is needed but not entered and saved, this could result in an under-delivery of basal insulin. Under-delivery of insulin can potentially cause severe hyperglycemia, which may lead to diabetic ketoacidosis.

Setting up a basal pattern

This procedure shows how to set up a basal pattern for the first time. To add an additional basal pattern, see *Adding an additional basal pattern*, page 242.

To set up a basal pattern:

1. From the Home screen, press , and then select .
2. Select **Delivery Settings** > **Basal Pattern Setup**.



3. Select **Basal 1**.
4. Select **Options**, and then select **Edit**.



5. For one basal rate, the End time does not need to change. Press  on the 12:00 A.



Note: For instructions on setting up multiple basal rates over a 24-hour period, see *Settings covering a 24-hour period, page 91*.

6. Enter the unit value for the time period.
7. Select **Review**.

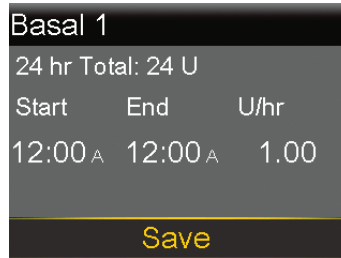

Review the basal pattern. Press to return to the previous screen to make changes.



Note: If is pressed and **Save** is not selected, the changes are not saved.

8. Select **Save**.

Settings covering a 24-hour period

Some pump functions allow settings to change over a 24-hour period. Basal rates are one of those settings.

Setting up multiple values over a 24-hour period applies to the following settings:

- Basal patterns
See *Setting up a basal pattern, page 90*
- High SG settings
See *Setting up the High SG settings, page 162*
- Low SG settings
See *Setting up the low SG settings, page 165*
- Carb ratios, insulin sensitivities, and BG targets in the Bolus Wizard feature

See *Setting up the Bolus Wizard feature*, page 105

The following screen is an example of a basal pattern with different rates of basal insulin for specific times of the day.

Edit Basal 1		
Start	End	U/hr
12:00 _A	8:00 _A	0.900
8:00 _A	6:00 _P	0.650
6:00 _P	12:00 _A	0.900
Review		

To set up values over a 24-hour period:

1. On the appropriate settings screen, select the End time and enter the end time for the first time period. In this example, the first desired time period is 8 hours. The start time always begins at 12:00 A. To set an 8-hour period, enter an end time of 8:00 A.

Edit Basal 1		
Start	End	U/hr
12:00 _A	12:00 _A	0.025
Review		

2. Enter the unit value for the first time period.

Edit Basal 1		
Start	End	U/hr
12:00 _A	8:00 _A	0.900
Review		

3. Press .

The start time for the next time period appears.

Edit Basal 1		
Start	End	U/hr
12:00 _A	8:00 _A	0.900
8:00 _A	8:30 _A	---
Review		

4. Enter the end time for the next time period.

Edit Basal 1		
Start	End	U/hr
12:00 _A	8:00 _A	0.900
8:00 _A	6:00 _P	---
Review		

5. Enter the unit value for the next time period.

Edit Basal 1		
Start	End	U/hr
12:00 _A	8:00 _A	0.900
8:00 _A	6:00 _P	0.650
Review		

6. Press .

The start time for the next time period appears.

Edit Basal 1		
Start	End	U/hr
12:00 _A	8:00 _A	0.900
8:00 _A	6:00 _P	0.650
6:00 _P	12:00 _A	---
Review		

- Repeat steps 3-5 for every desired time period until the end time of 12:00 A is reached. This completes the 24-hour duration.

Edit Basal 1		
Start	End	U/hr
12:00 _A	8:00 _A	0.900
8:00 _A	6:00 _P	0.650
6:00 _P	12:00 _A	0.900
Review		

- Select **Review**.

Edit Basal 1		
Start	End	U/hr
00:00	08:00	0.900
08:00	18:00	0.650
18:00	24:00	0.900
Review		

Review the basal pattern. Press  to return to the previous screen to make changes.





Note: If  is pressed and **Save** is not selected, the changes are not saved.

- Select **Save**.



Viewing basal delivery information

To view the current basal rate:

1. From the Home screen, press , and then select .
2. Select **Basal**.
3. Select **Basal**.

The current basal rate appears at the top of the screen.

To view basal patterns:

1. From the Home screen, press , and then select .
2. Select **Basal**.
3. Select **Basal Patterns**.

The Basal Patterns screen shows a list of configured basal patterns and the 24-hour insulin total for each basal pattern. A check mark appears next to the active basal pattern.

4. To view details for a basal pattern, select the basal pattern.

For more information about basal patterns, see *Basal patterns*, page 89.

Suspending all insulin delivery and resuming basal insulin delivery

Use this feature to suspend all active basal and bolus insulin deliveries. A reminder that insulin is not being delivered occurs every 15 minutes while this feature is active. The pump beeps, vibrates, or both every 15 minutes as a reminder that insulin is not being delivered.



Note: The first reminder occurs 15 minutes after the pump display times out. The pump beeps, vibrates, or both 15 minutes after the pump display times out. If a button is pressed to wake up the pump, the pump beeps, vibrates, or both 15 minutes after the pump display times out again. To adjust the timeout setting, see *Display options*, page 203.

To continue basal insulin delivery, use the Resume Basal feature. The pump starts the programmed basal pattern but does not start any previously programmed bolus deliveries.



Note: To stop a bolus delivery without stopping the basal delivery, see *Stopping a bolus delivery*, page 112.



WARNING: If insulin delivery is suspended during a bolus, check the pump daily history to determine the amount of insulin that was delivered before resuming insulin delivery. Bolus delivery and fill cannula do not restart when insulin delivery is resumed. If needed, program a new bolus or fill the cannula. Failure to resume basal insulin delivery can result in hyperglycemia and diabetic ketoacidosis.



WARNING: Do not rely solely on the sound or vibration notifications when using the sound or vibrate options. These notifications may not occur as expected if the speaker or vibrator in the pump malfunctions. A missed notification may result in the delivery of too much or too little insulin. This is most common when using the Easy bolus feature or when the pump is in manual suspend. Contact 24-Hour Technical Support with any concerns.

To suspend all insulin delivery:

1. From the Home screen, press , and then select .

2. Select **Suspend All Delivery**.

A confirmation message appears.



3. Select **Yes** to suspend all insulin delivery.

The pump functions are limited until insulin delivery is resumed.

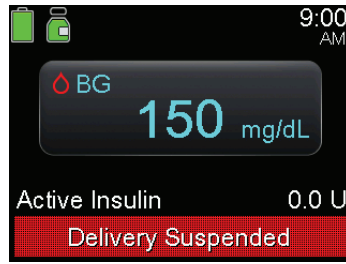
The Delivery Suspended banner appears on the Home screen while insulin is suspended.



To resume basal insulin delivery:

1. While insulin delivery is suspended, from the Home screen press , and then select .
2. Select **Resume Basal**.
A confirmation message appears.

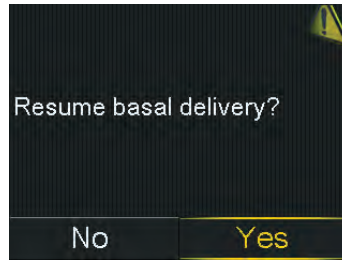

3. To resume basal insulin delivery, select **Yes**.
If a temp basal was active when the pump was suspended, it resumes, provided the time is still within the duration set.



Note: If a bolus delivery that was in progress before delivery was suspended is needed, check the Daily History screen for the actual bolus units delivered and the intended bolus amount. Then set up a new bolus amount as needed. For details about using the Daily History screen, see *Daily History screen, page 219*.

Temp basal rates

The temp basal feature helps set and start a temporary basal rate that can be used immediately to manage BG for short-term activities or conditions.



Preset temp basal rates can be set for recurring short term situations. For more information on Preset temp basal rates, see *Preset temp basal rates, page 239*. The duration of the temp basal rate can range from 30 minutes to 24 hours. After the temp basal rate delivery is completed or canceled, the programmed basal pattern resumes. The temp basal rates and preset temp basal rates can be defined using either a percentage of the current basal pattern or by setting a specific rate, as described in the following table:

Temp basal rate type	Description
Percent	Percent delivers a percentage of the basal rates programmed in the active basal pattern for the duration of the temp basal rate. The temp basal amount is rounded down to the next 0.025 units if the basal rate is set at less than 1 unit per hour, or to the next 0.05 units if the basal rate is set at more than 1 unit per hour. Temp basal rates can be set to deliver from 0% to 200% of the scheduled basal rate. The percentage used is based on the largest basal rate scheduled during the temp basal rate duration and is limited by the Max basal rate.
Rate	Rate delivers a fixed basal insulin rate in units per hour for the duration of the temp basal rate. The amount set is limited by the Max basal rate.

Starting a temp basal rate

When a temp basal rate starts, basal delivery changes to the temp basal rate for the set duration. When the duration completes, the basal insulin automatically returns to the active basal pattern.

To start a temp basal rate:

1. From the Home screen, press , and then select .
2. Select **Basal > Temp Basal**.
3. Set the **Duration**.

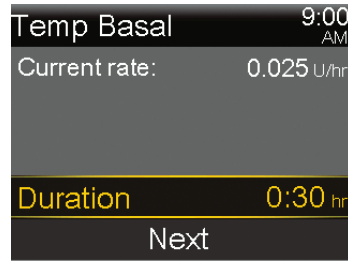

4. Select **Next**.
5. Select **Type** to select Rate or Percent.

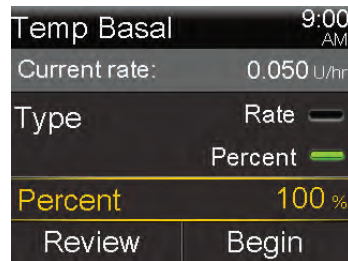

6. Depending on the type selected, do one of the following:
 - Enter a percentage.
 - Enter a basal rate.

Select **Review** to review the temp basal setting.

7. Select **Begin** to start the temp basal rate.

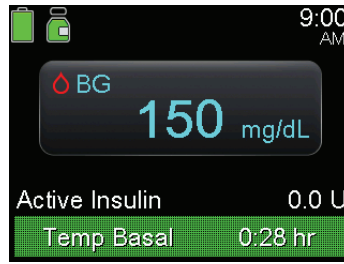

The Temp Basal banner appears on the Home screen during delivery.





Entering a blood glucose (BG) meter reading

The system may request a blood glucose (BG) meter reading to continue use. Additionally, a blood glucose (BG) meter reading can be entered at any time, if desired. The BG screen allows manual entry of a blood glucose (BG) meter reading. Previously entered manual or meter BG readings do not appear on the BG screen. A blood glucose (BG) meter reading received from a linked meter appears in a separate BG Meter screen that requires confirmation.

To manually enter blood glucose (BG) meter readings:

1. From the Home screen, press , and then select .
2. Enter a blood glucose (BG) meter reading. Do not enter a sensor glucose (SG) value in place of a blood glucose (BG) meter reading. A blood glucose (BG) meter reading must always come from a blood glucose meter. The entered glucose value is used to calibrate the sensor.
3. Select **Save**.



Note: A blood glucose (BG) meter reading can be entered on the Bolus Wizard screen or on the Bolus screen while using the SmartGuard feature. To enter a blood glucose (BG) meter reading on the Bolus Wizard screen, select **BG**. To enter a blood glucose (BG) meter reading on the Bolus screen while using the SmartGuard feature, press , and then press .

To confirm a blood glucose (BG) meter reading from a blood glucose meter:

When the BG Meter screen with the message Confirm BG? shows, select **Yes** to confirm the blood glucose (BG) meter reading.

The BG received message shows.

Setting up bolus delivery

A bolus is given for two reasons: to cover food that contains carbohydrates or to correct glucose levels that are above the target range.

About bolus deliveries

A bolus can be delivered using either the Manual bolus feature or the Bolus Wizard feature. Multiple types of bolus deliveries are also available, including normal bolus, Square Wave bolus, and Dual Wave bolus. The bolus type depends on individual insulin needs. Discuss these options with a healthcare professional to determine what is best. For details about the different types of bolus deliveries available, see *Bolus types*, page 249.



Note: Do not use a blood glucose (BG) meter reading if more than 12 minutes have passed since the last BG meter reading was taken. That BG meter reading and the calculated bolus amount may no longer be accurate.

Bolus delivery options

The following table describes how to deliver a bolus using the Bolus Wizard feature or Manual bolus feature. These bolus options are only available in Manual mode.

Delivery method	Description
Bolus Wizard feature	Enter the BG meter value or the amount of carbs expected from a meal, or both. Then the Bolus Wizard feature calculates an estimated bolus amount based on the individual settings. For details about using the Bolus Wizard feature, see <i>Bolus Wizard feature</i> , page 103.

Delivery method	Description
Manual bolus feature	Calculate and manually enter the bolus amount. For details about using the Manual bolus feature, see <i>Delivering a normal bolus using the Manual bolus feature, page 111.</i>

Max bolus



The Max bolus setting limits the amount of insulin that can be programmed by the user for a single bolus in Manual mode or SmartGuard. The pump prevents single bolus insulin deliveries that exceed the Max bolus amount. The Max bolus can be set from 0 to 25 units. Set the Max bolus as indicated by a healthcare professional.

If the Max bolus is set up after the preset bolus deliveries are set, the Max bolus cannot be set lower than any of the existing preset bolus amounts.

The Max bolus setting applies to boluses programmed by the user in Manual mode and SmartGuard.

When the SmartGuard feature is active, SmartGuard determines the limits for each auto correction bolus or auto basal delivery.

To set the Max bolus:

1. From the Home screen, press , and then select .
2. Select **Delivery Settings > Max Basal/Bolus**.

The Max Basal/Bolus screen appears.



Max Basal/Bolus	
Max Basal	2.00 U/hr
Max Bolus	10.0 U

3. Select **Max Bolus**.

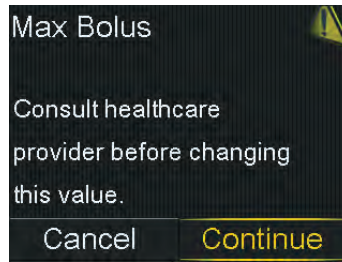

4. To continue to the Max Bolus screen, select **Continue**.
5. Select **Max Bolus**, and then set the maximum number of insulin units the pump can deliver in one bolus.

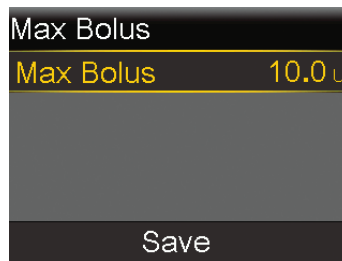

6. Select **Save**.

Bolus Wizard feature

The Bolus Wizard feature uses Bolus Wizard settings to calculate an estimated bolus amount based on the BG readings and carbs that are entered.

After the Bolus Wizard feature is set up, use a normal bolus to deliver a food bolus, a correction bolus, or a food plus correction bolus. For more information, see *Delivering a normal bolus with the Bolus Wizard feature*, page 109.

The Bolus Wizard feature can also be used to deliver a Dual Wave bolus or a Square Wave bolus. For more information, see *Bolus types*, page 249.

Bolus Wizard settings

To use the Bolus Wizard feature, consult a healthcare professional to determine the personal settings that should be used. The carb ratio, insulin sensitivity factor, BG target, and the active insulin time are needed to complete the setup. Always consult a

healthcare professional before changes are made to the Bolus Wizard settings. The setup procedure begins on *Setting up the Bolus Wizard feature, page 105*.



Setting	Description
Carb Ratio	The carb ratio setting is used for food bolus calculations. The number of carb grams that are covered by 1 unit of insulin.
Insulin Sensitivity Factor	The insulin sensitivity factor setting is used to calculate correction bolus amounts. The insulin sensitivity factor is the amount that BG is reduced by 1 unit of insulin.
BG Target	The Bolus Wizard feature calculates the estimated bolus based on the BG target range. The high and low values set are the values to which the BG is corrected. To use a single target value rather than a range, set the same value for the high and low value of the BG target. If the BG reading is above the high target value, a correction dose is calculated. If the BG reading is below the low target value, a negative correction is calculated and subtracted from the food bolus.
Active Insulin Time	Active insulin is the bolus insulin that has been delivered by the pump and is still working to lower glucose levels. In the Bolus Wizard and SmartGuard Bolus feature, the Active Insulin Time setting is used to calculate a correction bolus by subtracting the estimated active insulin from each bolus. In SmartGuard, auto correction boluses are delivered up to every 5 minutes. A shorter Active Insulin Time setting may result in more insulin being delivered in correction boluses. A healthcare professional provides the personalized active insulin time based on historic glycemic control data for the individual user. When using SmartGuard, the recommended initial setting is an Active Insulin Time of 2-3 hours. The Active Insulin Time setting in the MiniMed 780G system

Setting	Description
	is not necessarily reflective of the physiological insulin metabolism. Adjustments are not based on the pharmacokinetics and pharmacodynamics of the rapid-acting insulin. Please see <i>Table 8, page 363</i> and <i>Table 9, page 364</i> in <i>Performance data, page 355</i> for the effect of Active Insulin Time on glycemic outcomes. The current active insulin amount appears on the Home screen and includes only the bolus insulin received.

Setting up the Bolus Wizard feature

To use the Bolus Wizard feature to calculate a bolus, first turn on the Bolus Wizard feature and enter the Bolus Wizard settings. There are four settings needed to set up the Bolus Wizard. Each setting is shown using 1/4, 2/4, 3/4, and 4/4 on the screens.

To set up the Bolus Wizard feature:

1. From the Home screen, press , and then select .
2. Select **Delivery Settings > Bolus Wizard Setup**.

The Bolus Wizard Setup screen appears.

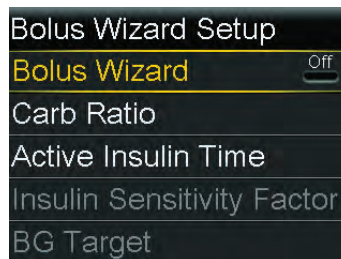

3. Select **Bolus Wizard** to turn on the feature.

If this is the first time the Bolus Wizard feature has been turned on, the following screen appears.

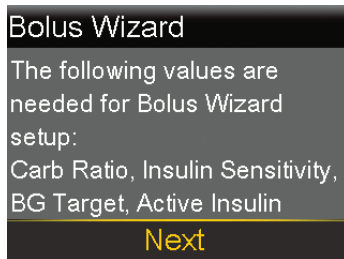

4. Confirm the values needed are ready to be entered, then select **Next**.
The Carb Ratio 1/4 screen appears.

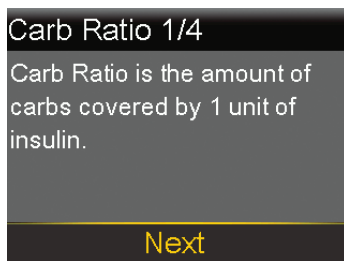

5. Select **Next**.
The Edit Carb Ratio 1/4 screen appears.

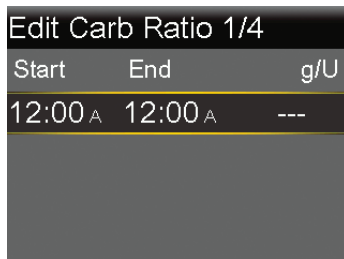

6. To enter one carb ratio, enter the g/U, and then press .



Note: For instructions on setting up more than one carb ratio over a 24-hour period, see *Settings covering a 24-hour period*, page 91.

7. Select **Next**.



Note: If the values are outside of the value range, a message asks to confirm the settings.

The Sensitivity 2/4 screen appears.

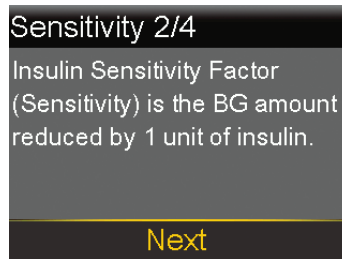

8. Select **Next**.

The Edit Sensitivity 2/4 screen appears.

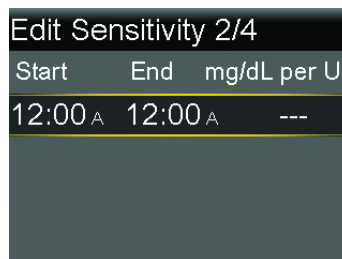

9. For one sensitivity factor, enter the mg/dL per U, and then press



Note: For instructions on setting up more than one sensitivity factor over a 24-hour period, see *Settings covering a 24-hour period, page 91*.

10. Select **Next**.

The BG Target 3/4 screen appears.

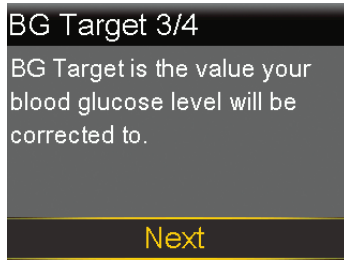

11. Select **Next**.

The Edit BG Target 3/4 screen appears.



12. For one BG target range, enter the Lo and Hi target, and then press .



Note: For instructions on setting up more than one BG target range over a 24-hour period, see *Settings covering a 24-hour period*, page 91.

13. Select **Next**.

The Active Insulin Time 4/4 screen appears.

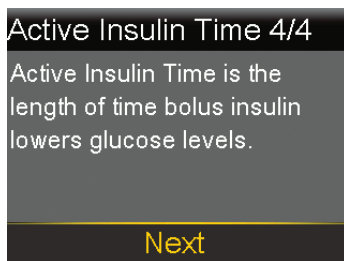

14. Select **Next**.

The Active Insulin Time 4/4 screen appears.

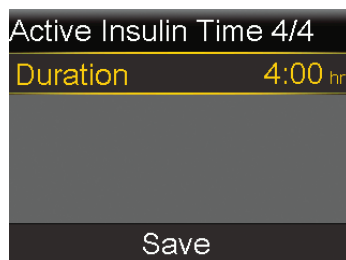



15. Enter the **Duration** of the active insulin time, and then press .
16. Select **Save**.

The Bolus Wizard feature setup is now complete.

Turning the Bolus Wizard feature off

The Bolus Wizard feature can be turned off at any time. The Bolus Wizard settings remain in the pump. When the Bolus Wizard feature is turned off, the Bolus Wizard menu selection does not appear on the Bolus screen, and the insulin sensitivity factor or BG target settings can not be edited on the Bolus Wizard Setup screen.

To turn the Bolus Wizard feature off:

1. From the Home screen, press , and then select .
2. Select **Delivery Settings > Bolus Wizard Setup**.
3. Select **Bolus Wizard** to turn the feature off.

Normal bolus

A normal bolus provides a single immediate dose of insulin. Use a normal bolus to cover food intake or to correct a high BG meter reading.



Note: The pump can deliver a normal bolus while a Square Wave bolus or the Square portion of a Dual Wave bolus is being delivered.

Delivering a normal bolus with the Bolus Wizard feature

The Bolus Wizard screen shows the most recent BG reading, if available. The table indicates the different ways that the Bolus Wizard screen shows the BG reading.

Bolus Wizard screen

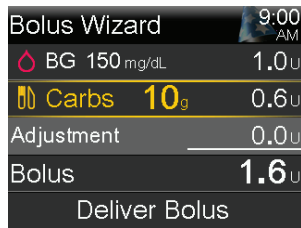

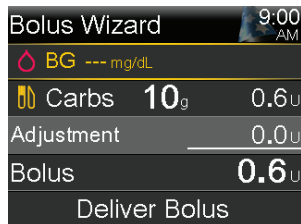

Glucose reading information

The  icon indicates that a recent blood glucose (BG) meter reading is used by the Bolus Wizard feature to calculate a correction bolus. DO NOT enter a sensor glucose (SG) value in place of a blood glucose (BG) meter reading.



The BG appears as dashes when no BG is available for the Bolus Wizard feature to calculate a correction bolus.

To deliver a normal bolus using the Bolus Wizard feature:

1. From the Home screen, press , and then select .
2. Select **Bolus > Bolus Wizard**.

The Bolus Wizard screen appears.

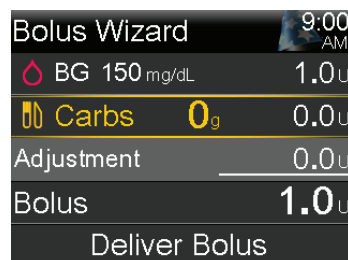

3. For a correction bolus or a food bolus with a correction, use a blood glucose (BG) meter for a blood glucose (BG) meter reading. Do not enter a sensor glucose (SG) value in place of a blood glucose (BG) meter reading. A blood glucose (BG) meter reading must always come from a blood glucose meter. The entered glucose value is used to calibrate the sensor.



Note: A blood glucose (BG) meter reading can be entered on the Bolus Wizard screen. On the Bolus Wizard screen, select **BG**.

- For a food bolus, select **Carbs** to enter the carb count of the meal. For a correction bolus where no food was eaten, leave the carbs value at 0.

The calculated bolus appears in the Bolus field.

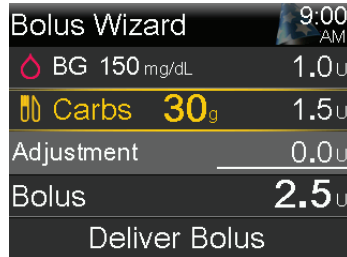

- If a change to the bolus amount is needed, select **Bolus** and modify the bolus amount.

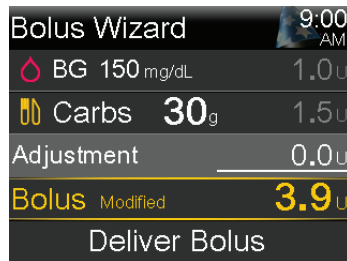



- Select **Deliver Bolus** to start the bolus.

The pump beeps or vibrates and a message appears when the bolus starts. The Home screen shows the bolus amount as it is being delivered. The pump beeps or vibrates when bolus delivery is complete.

Delivering a normal bolus using the Manual bolus feature

The following procedure describes how to deliver a normal bolus using the Manual bolus feature.

To deliver a normal bolus using the Manual bolus feature:

- From the Home screen, press , and then select .
- Do one of the following:

- Select **Bolus** if the Bolus Wizard feature is turned off.
- Select **Bolus > Manual Bolus** if the Bolus Wizard feature is turned on.

The Manual Bolus screen appears.

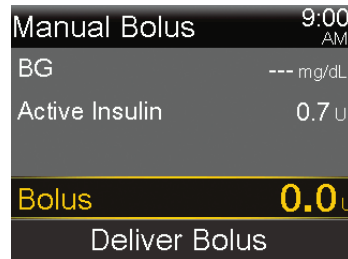



3. Select **Bolus** to set the bolus delivery amount in units.
4. Select **Deliver Bolus** to start the bolus.



Stopping a bolus delivery

These procedures describe how to stop a bolus.





WARNING: Always press , select , and then select **Stop Bolus** to stop bolus insulin delivery. Do not use the Suspend All Delivery feature to stop bolus insulin. The Suspend All Delivery feature stops both basal insulin and bolus insulin delivery. Failure to resume basal insulin delivery could result in too little insulin, which may cause high BG.



Note: To stop all insulin delivery, use the Suspend All Delivery feature (press , select , and then select **Suspend All Delivery**). For more information on using the Suspend All Delivery feature, see *Suspending all insulin delivery and resuming basal insulin delivery*, page 95.

To stop a bolus delivery:

1. While the pump delivers a bolus, press  and then select .
The Insulin menu appears.

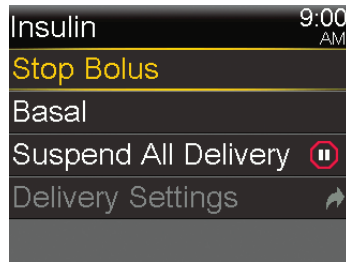

2. Select **Stop Bolus**.

A message appears confirming if bolus delivery should be stopped.

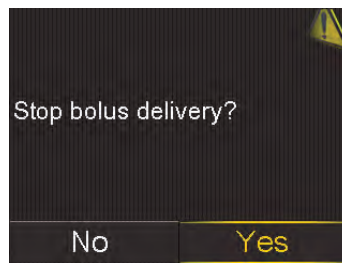

3. Select **Yes** to confirm.

The Bolus Stopped screen appears and shows the amount of bolus delivered, and the original bolus amount set up.



4. Select **Done**.



Note: The delivered amount can be viewed in the insulin delivery history screen after the procedure is closed. For more information, see *Daily History screen, page 219*.

5



Reservoir and infusion set

5

Reservoir and infusion set

The pump has options to change the reservoir and infusion set, reservoir only, or infusion set only. This chapter provides information about setting up the reservoir and infusion set with the Reservoir & Set option.

If the reservoir runs out of insulin and the infusion set has not been used for the duration of use indicated for the infusion set, the New Reservoir Only option may be used to change the reservoir. If only the infusion set needs to be changed, the New Set Only option may be used to change the infusion set.

Refer to the infusion set user guide for the duration of use indicated for the infusion set. Refer to the reservoir user guide for the duration of use indicated for the reservoir.

Do not begin the steps to replace the reservoir and infusion set until training has been received.



WARNING: Always confirm that the infusion set tubing is disconnected from the body before doing the following steps:

- placing the reservoir into the pump
- rewinding the pump
- loading the reservoir
- filling the infusion set tubing

Failing to disconnect the infusion set tubing from the body may result in an accidental infusion of insulin, and may cause hypoglycemia.

Setting up the reservoir and infusion set

Confirm that the time and date on the pump are correct before insulin is used with the pump for the first time. For information about how to change the time and date on the pump, see *Time and date*, page 203. Consult a healthcare professional to determine the appropriate pump settings before insulin is used with the pump.

The following items are needed:

- MiniMed 780G insulin pump
- vial of rapid-acting U-100 insulin
- MiniMed or Medtronic reservoir
- MiniMed or Medtronic infusion set and its user guide



WARNING: Do not use the pump to deliver insulin for the first time until the active insulin has been cleared. If the pump has been used for training with bolus delivery before insulin is used, the active insulin value may be inaccurate. This may result in inaccurate insulin delivery, and serious injury. For details, see *Clearing the active insulin*, page 209.



Note: Different infusion sets may have different instructions for insertion into the body. All the procedures in the sections within this chapter must be followed in order to change the reservoir and infusion set.

Removing the reservoir and rewinding the pump

If this is the first time a reservoir is inserted into the pump, proceed to the pump rewind instructions. For more information about the reservoir see the reservoir user guide.



WARNING: Always confirm that the infusion set is disconnected from the body before rewinding the pump or filling the infusion set tubing. Never insert the reservoir into the pump while the tubing is connected to the body. Doing so may result in an unintentional infusion of insulin, and may cause hypoglycemia.

When the pump rewinds, the piston in the reservoir compartment returns to its starting position and allows a new reservoir to be placed into the pump.

The piston is located in the reservoir compartment of the pump. It engages the reservoir and pushes insulin through the tubing.

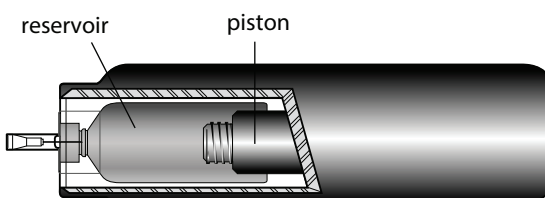

Start here:

1. Wash hands with soap and water. On the pump, press  to go to the Menu screen.

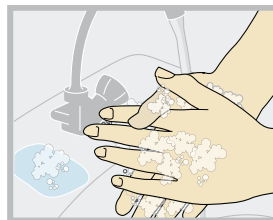

2. Select , and then select **New Reservoir & Set**.



3. Remove the infusion set by loosening the adhesive and pulling the set away from the body. Select **Next**.

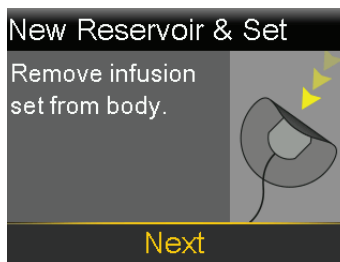

Note: For instructions on how to remove the infusion set from the body refer to the user guide that came with the infusion set.

4. If the optional activity guard is attached to the reservoir compartment on the pump, remove it now.
5. Remove the used reservoir from the pump.

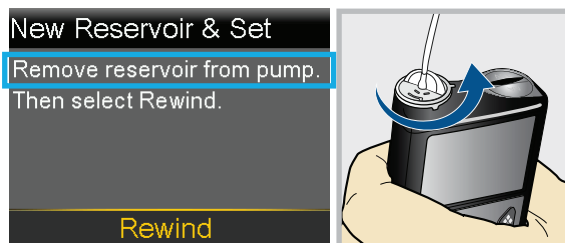

6. Dispose of the used reservoir and infusion set per the disposal information in the corresponding user guide.
7. Select **Rewind**.

Do not connect the infusion set to the body.

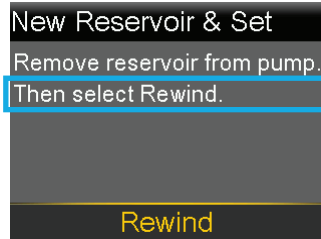

WARNING: Always confirm that the infusion set is disconnected from the body before rewinding the pump. Failing to disconnect the infusion set from the body may result in an accidental infusion of insulin, and may cause hypoglycemia.



8. Follow the next steps to fill the new reservoir with insulin and to connect the infusion set tubing.

Do not select **Next**.

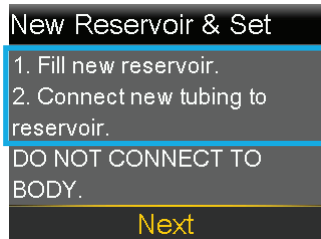

Filling the reservoir and connecting it to the infusion set tubing



WARNING: Always allow the insulin to reach room temperature before use. Cold insulin may cause air bubbles in the reservoir and tubing, which may result in inaccurate insulin delivery.

The following procedures must be performed in the order presented.

To fill the reservoir and connect it to the infusion set tubing:

1. Remove the reservoir from the package. Make sure the insulin vial is at room temperature to reduce the risk of air bubbles.

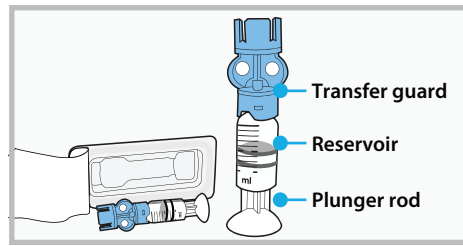

2. Pull the plunger down based on the planned insulin fill amount for the duration of use indicated for the reservoir.

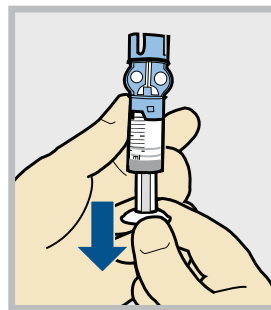

3. Wipe the top of the vial with alcohol. Place the vial on a sturdy flat surface. Firmly press the transfer guard onto the vial.

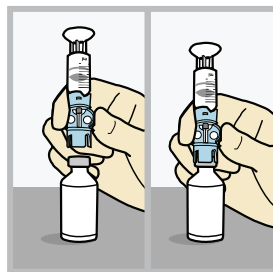

4. Push and hold the plunger down.

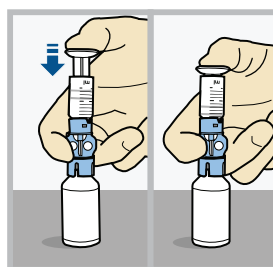

WARNING: Do not use the reservoir or infusion set if insulin or any liquid gets on the top of the reservoir or inside the tubing connector, as shown in the image. Insulin or any liquid may temporarily block the vents. This may result in the delivery of too little or too much insulin, which may cause hyperglycemia or hypoglycemia. If insulin or any liquid gets on the top of the reservoir or inside the tubing connector, start over with a new reservoir and infusion set.

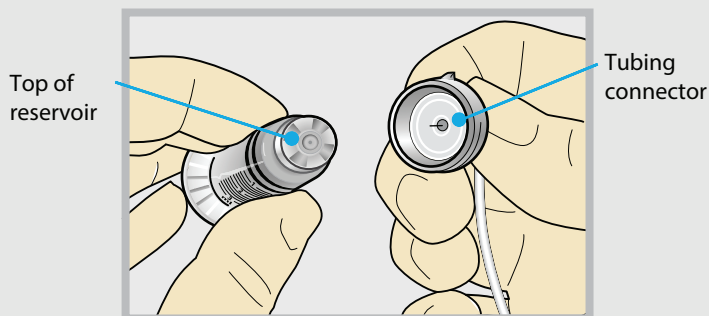

5. Keeping a thumb on the plunger, flip the vial over so the vial is on top. Release the thumb and pull the plunger down to fill the reservoir with insulin.

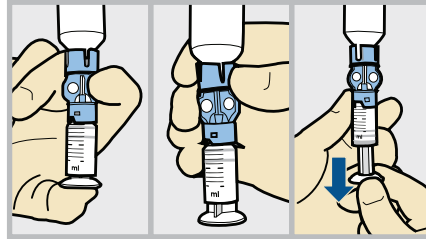

6. Tap the reservoir to move air bubbles to top of reservoir. Push the plunger up to move air into vial.

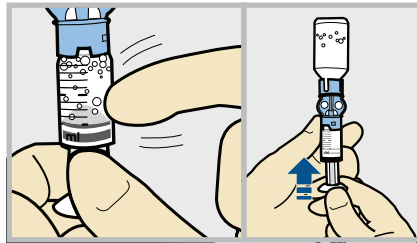

7. Pull the plunger back down to allow the reservoir to fill with the amount of insulin needed for the duration of use indicated for the reservoir.

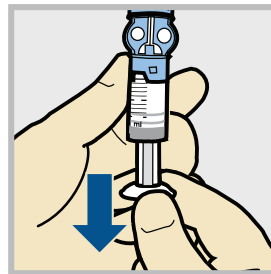

8. To avoid getting insulin on the top of the reservoir, **flip the vial over again so the reservoir is on top**. Hold the transfer guard and turn the reservoir counter-clockwise and remove the reservoir from the transfer guard.

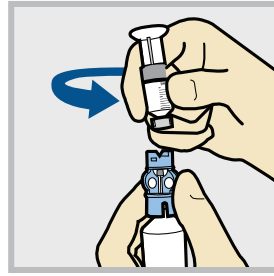

9. Follow the instructions in the infusion set user guide to access the infusion set tubing.
10. Gently push the tubing connector onto the reservoir. Turn the connector clockwise until it is locked into place.

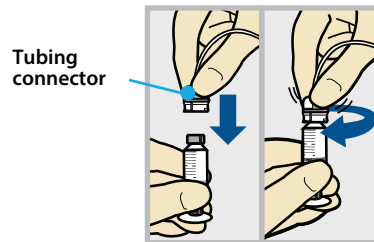

11. Tap the reservoir to move any air bubbles to the top. Push the plunger slightly to move the bubbles into the tubing.

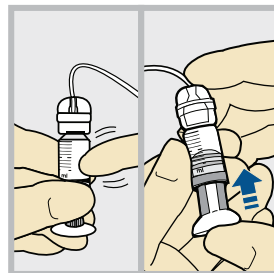

12. Twist the plunger counter-clockwise to loosen it and to remove it.

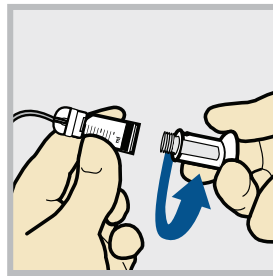



Placing the reservoir into the pump and filling the tubing with insulin



WARNING: Always rewind the pump before placing a new reservoir. Failing to rewind the pump may result in an unintentional infusion of insulin, which may cause hypoglycemia.

To place the reservoir into the pump and fill the tubing with insulin:



Note: The backlight may have turned off. Press any button to turn the screen back on. Press  to go to the Menu screen, and then select .

1. Select **Next**.

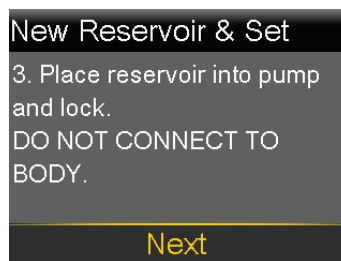

2. Place the reservoir into the pump.
Do not connect the infusion set to the body.

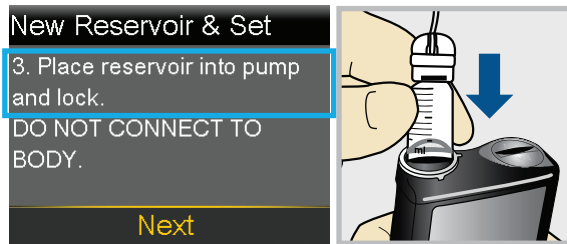

WARNING: Always confirm that the infusion set is disconnected from the body before placing the reservoir into the pump. Failing to disconnect the infusion set from the body may result in an accidental infusion of insulin, and may cause hypoglycemia.

- Turn the reservoir clockwise until the reservoir locks into place, and select **Next**.

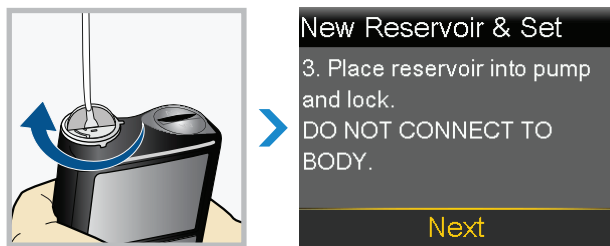

- Select **Load** and hold  until the checkmark appears on the screen.

Do not connect the infusion set to the body.



- When the checkmark appears, select **Next**.



WARNING: Always confirm that the infusion set is disconnected from the body before loading the reservoir and filling the tubing. Failing to disconnect the infusion set from the body may result in an accidental infusion of insulin, and may cause hypoglycemia.

6. Select **Fill** and keep holding  until there are no air bubbles visible in the tubing, and there are drops at the end of the tubing.

Do not connect the infusion set to the body.

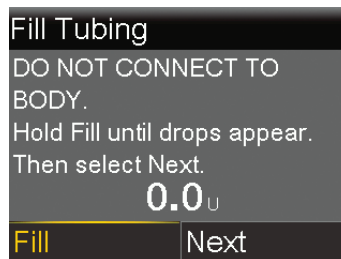

WARNING: Always check the tubing for air bubbles. Continue to press Fill until no bubbles remain in the tubing. Air bubbles may result in inaccurate insulin delivery.

7. After drops appear, press  and select **Next**.



Note: The location of the infusion set needle may be different depending on the type of infusion set being used.

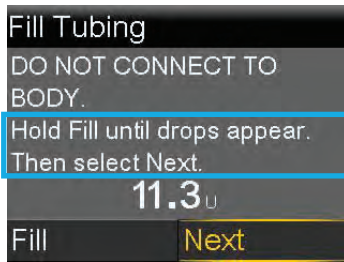

8. Follow the steps in the infusion set user guide to insert the infusion set into the body before proceeding with the steps on the pump screen.

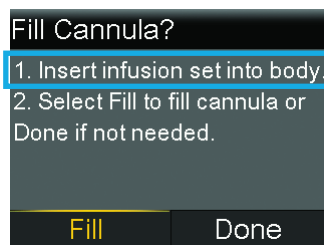

Note: If an infusion set with a steel cannula is used, the cannula does not need to be filled, and **Done** may be selected.

Inserting the infusion set into the body

Always refer to the infusion set user guide and the senter user guide, if needed, for instructions about how to insert an infusion set into the body.



WARNING: Do not remove the reservoir from the pump while the infusion set is connected to the body. Doing so may result in the delivery of too little or too much insulin, which may cause hyperglycemia or hypoglycemia.

Choose an insertion site from the shaded areas shown here. Wipe the site with alcohol or other antiseptic.

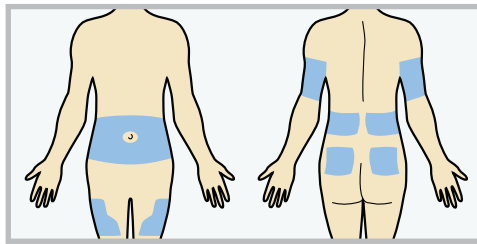

CAUTION: Do not use the same infusion set insertion site for an extended period of time. This may cause the site to become overused. Rotate the infusion set insertion sites regularly.



CAUTION: Always change the infusion set as indicated by the infusion set user guide. Using the same infusion set for an extended period of time beyond its product labeling can cause infusion set occlusion or site infection.

After the infusion set is inserted into the body follow the steps in the following section to fill the cannula.

Filling the cannula

Filling the soft cannula with insulin is required after the infusion set is inserted into the body and the introducer needle is pulled out. The insulin amount required to fill the cannula depends on the type of infusion set used. Refer to the user guide that came with the infusion set for more information.



Note: The Fill Cannula action is not required during a reservoir only change. If performing a reservoir only change, select **Done** on the **Fill Cannula?** screen.



WARNING: Never leave the pump on the Fill Cannula? screen. Insulin delivery is suspended while on the Fill Cannula? screen. Always finish filling the cannula or return to the Home screen, to avoid continued insulin delivery suspension. Prolonged suspension of insulin delivery may cause hyperglycemia.

To fill the cannula:

1. After the infusion set is inserted into the body, select **Fill**.

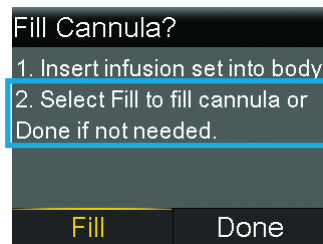

Note: Always verify that the amount shown in the **Fill amount** field is correct. The pump will remember the fill amount last used. Change the **Fill amount** if needed.

- If the Fill amount is correct, press \checkmark to select **Fill Now** and then press \odot .
- If the Fill amount is incorrect, press \odot . Change to the correct amount and press \odot . Then select **Fill Now**.

2. Select **Fill amount** and enter the amount per the infusion set user guide. After entering the cannula size, press \odot .



3. Select **Fill Now**.

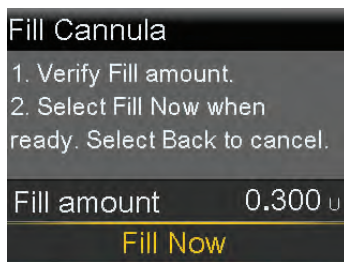

The Home screen displays the insulin amount as insulin fills the cannula.

The reservoir and infusion set change is now complete.

Always check blood glucose (BG) using a blood glucose meter one to three hours after changing the infusion set or reservoir.

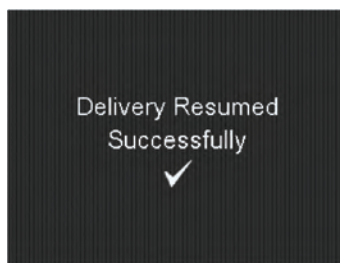

Note: Use the following procedure only when it is necessary to stop filling the cannula.

To stop filling the cannula:

1. Select **Stop Filling** to stop filling the cannula.

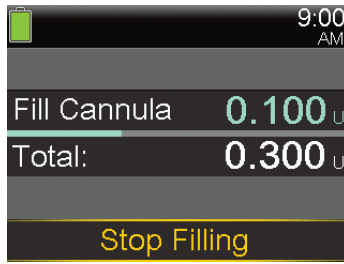

2. Select **Yes**.

The Fill Stopped screen appears.

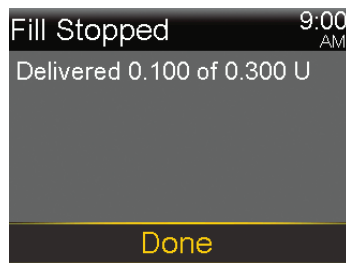

3. Select **Done**.

Disconnecting the infusion set

Refer to the infusion set user guide for instructions on how to disconnect the infusion set.

Reconnecting the infusion set

Refer to the infusion set user guide for instructions on how to reconnect the infusion set.

6



Paired devices

6

Paired devices

This chapter explains how to pair the MiniMed 780G insulin pump with compatible devices.

Setting up the Accu-Chek™* Guide Link meter

The MiniMed 780G insulin pump with smart device connectivity can pair only with an Accu-Chek™* Guide Link meter to automatically receive blood glucose (BG) meter readings. If the Accu-Chek™* Guide Link meter is not paired with the pump, enter BG readings manually. The pump beeps, vibrates, or simultaneously beeps and vibrates when the pump receives a BG reading. Confirm the BG reading and deliver a bolus, if necessary. If a BG reading is not confirmed within 12 minutes, the BG will not be stored. If the BG reading is outside the range of 70 mg/dL to 250 mg/dL, an alert appears. Follow instructions from a healthcare professional to treat low BG or high BG.

To pair the pump and meter, use the following items:

- MiniMed 780G insulin pump with smart device connectivity
- Accu-Chek™* Guide Link meter

Pairing the pump and meter

The MiniMed 780G insulin pump with smart device connectivity can pair with up to four Accu-Chek™* Guide Link meters.

To prepare the meter to pair with the pump:

1. Press the **OK** button on the meter to turn on the meter.

2. Select **Settings**.

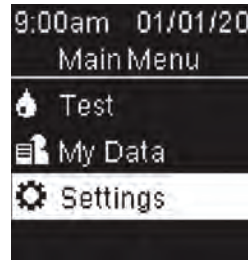

3. Select **Wireless**.

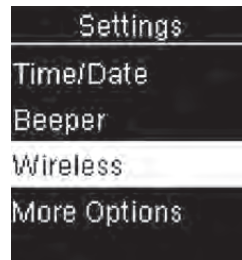

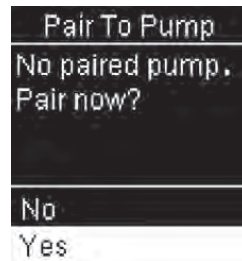

4. Select **Yes** if the confirmation screen appears on the meter screen. Or, if the confirmation screen does not appear, select **Pairing**.



The meter serial number appears on the meter screen. The meter is now ready to pair with the pump.

To prepare the pump to pair with the meter:

1. From the Home screen, press , and then select .
2. Select **Pair New Device**.

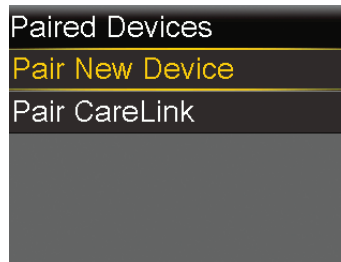

The Searching... screen appears. After the pump is done searching, the Select Device screen appears.

3. Select the meter that matches the serial number that displays on the meter screen.

If the correct serial number does not appear, select **Search Again**.

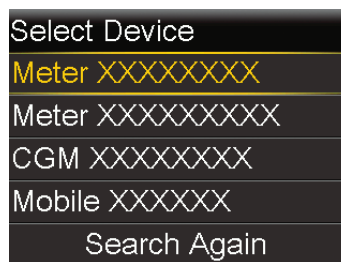

If the connection is successful, a "Pairing successful!" message appears on the pump. A "Paired with pump" message with the serial number of the pump appears on the meter screen. If a Device not found alert appears, see *Pump alarms, alerts, and messages, page 295* for more information.

Pairing the pump and transmitter



The pump and transmitter must be paired to use the sensor. When paired, the pump and transmitter communicate with each other through a wireless connection. Only one transmitter can be paired with the pump. If a transmitter is already paired with the pump, delete the transmitter, and then continue. For instructions on how to delete a transmitter from the pump, see *Unpairing the transmitter from the pump, page 290*.

To pair the pump and transmitter:

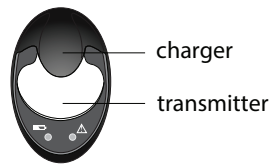
1. Attach the transmitter to the charger. Fully charge the transmitter. Keep the transmitter attached to the charger.



Note: Both lights on the charger are off when the transmitter is fully charged. For more information, see the transmitter user guide.

2. From the Home screen, press , and then select .
3. Place the transmitter (still attached to the charger) next to the pump.

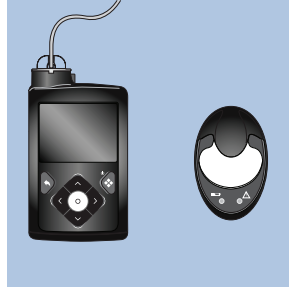

4. Select **Pair New Device** and immediately remove the transmitter from the charger.

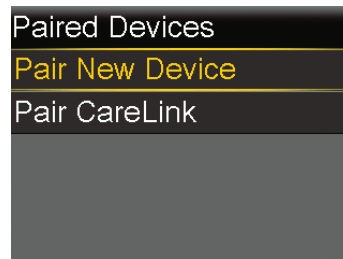

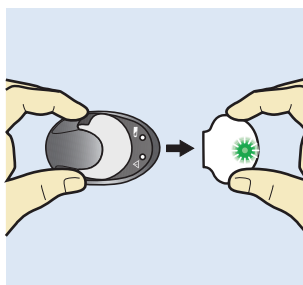

The following events happen when the search process starts:

- On the pump, the Searching... screen appears.
- On the transmitter, the light flashes 10 times and turns off.



Note: The search process can take up to 20 seconds.

The Select Device screen appears with a list of available devices.

5. Select the CGM device that matches the serial number indicated on the back of the transmitter.

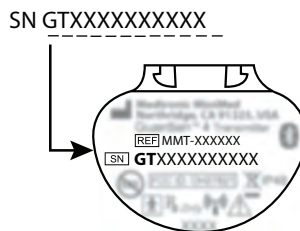

If the correct serial number does not appear, select **Search Again**.

If the connection is successful, a “Pairing successful!” message appears on the pump. When the transmitter is communicating with the pump, the Sensor feature is turned on and  appears on the Home screen. For information on using the sensor with the transmitter, see *Connecting the transmitter to the sensor, page 170*. If a Device not found alert appears, see *Pump alarms, alerts, and messages, page 295* for more information.



MiniMed Mobile app

The MiniMed Mobile app is an optional accessory that is compatible with the MiniMed 780G system. The app provides a secondary display that allows the user to view CGM and pump data. A compatible smartphone is required for the app to function. The app is available for both iOS™* and Android™* platforms. Consult the MiniMed Mobile app user guide for installation instructions.

Uploading device data to CareLink software

Upload system data to CareLink software with the MiniMed Mobile app or the Blue Adapter. Follow the instructions found on the CareLink software to upload system data with the Blue Adapter. Refer to the MiniMed Mobile app user guide for instructions to upload MiniMed 780G system data to CareLink software with the app.

To prepare the pump to upload to CareLink software:

1. From the Home screen, press , and then select .
2. Select **Pair CareLink**.

Follow instructions on the CareLink uploader to complete steps.

Sharing device data with the CareLink Connect app

The CareLink Connect app works with CareLink software. Through the CareLink Connect app, care partners can see information sent from a connected MiniMed Mobile app. A compatible smartphone is required for the app to function. The app is available for both iOS™* and Android™* platforms.

For more information about sharing data with the CareLink Connect app, see the MiniMed Mobile app user guide and the CareLink Connect app user guide.

Medtronic Diabetes Updater app

After an eligibility message for a pump software update is received, use the Medtronic Diabetes Updater app to perform the pump software update. The app provides instructions for each step of the process. Follow the instructions provided on the app screens to perform the update.



CAUTION: A stable internet connection is required throughout the entire update process. Avoid the use of unsecure Wi-Fi™* networks or public Wi-Fi™* hotspots.

Downloading the pump software update

After logging in and confirming the update is available, follow the instructions on the Updater app to download the pump software update. The Software is Ready screen appears on the Updater app when the download is complete.

Preparing to install the pump software update

To prepare to install the pump software update:



Note: After installation is complete, the SmartGuard feature requires a 5-hour warm-up period before it is active.

- Ensure glucose is within target before starting the update.
- Clear active alerts or alarms.
- If the pump is Suspended on low or Suspended before low, wait until insulin delivery resumes and BG recovers before starting the update.
- If a bolus delivery is in progress, wait until the bolus delivery completes before installing the pump software update.
- If the battery is low, the pump software update will not install. If the battery icon is not green, replace the battery before installing the pump software update.
- Insulin is not delivered and sensor glucose (SG) values are not shown for up to 20 minutes during the pump software installation. Manual injections are not

accounted for in the active insulin amount. If an injection is needed during the software update, consult a healthcare professional for how long to wait after a manual injection before using the Bolus Wizard feature. Refer to *Emergency kit*, page 31 for necessary supplies to use for backup insulin delivery if needed.

Installing the pump software update

1. When instructed by the Updater app, go to the Home screen on the pump. On the pump, a screen appears when the pump is ready for the software update.
2. Select **Continue**.

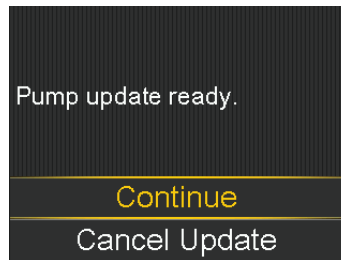

3. Select **Suspend Delivery** to suspend bolus and basal insulin delivery.

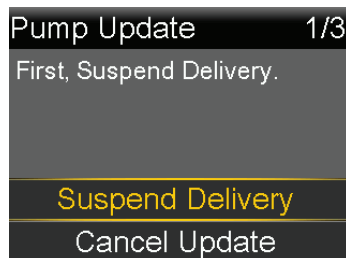

4. Disconnect the infusion set from the body, and then select **Confirm**.

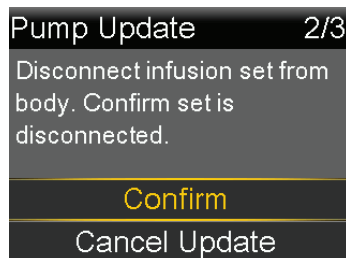

5. Select **Start Update**.

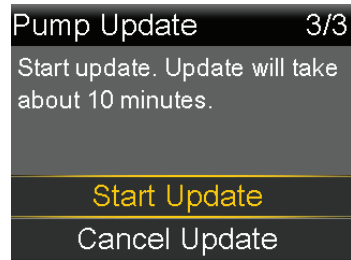

While the pump updates, a screen shows the progress.

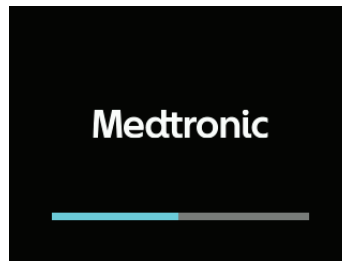

6. Select **Continue**.

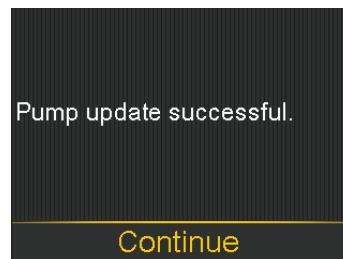

7. Reconnect the infusion set to the body.
8. Select **Yes** to resume basal insulin delivery.

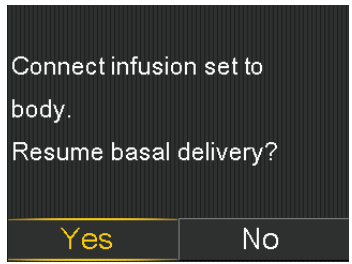

Note: The previous version of the software is retained if the update is not successful.

Completing the pump software update

Follow the instructions on the Updater app to complete the pump software update.

Continuous glucose monitoring with Guardian 4 sensor



7

Continuous glucose monitoring with Guardian 4 sensor

This chapter explains how to enter sensor settings and set up continuous glucose monitoring (CGM). CGM requires these items:

- MiniMed 780G insulin pump
- Sensor glucose (SG) settings provided by a healthcare professional
- Guardian 4 sensor
- Guardian 4 transmitter

CGM overview

CGM is an SG monitoring tool that uses a glucose sensor to continuously measure the amount of glucose in interstitial fluid. CGM helps manage blood glucose in these ways:

- It tracks and displays SG readings throughout the day and night.
- It shows the effects that diet, exercise, and medication can have on glucose levels.
- It provides additional tools, such as alerts, to help prevent high and low glucose levels.
- It measures glucose in the interstitial fluid, while a meter measures glucose in the blood. SG readings and meter readings may not be the same.



WARNING: Do not use SG values to make treatment decisions, including delivering a bolus, while the pump is in Manual mode. When the SmartGuard feature is active and you are no longer in Manual mode, the pump uses an SG value, when available, to calculate a bolus amount. However, if your symptoms do not match the SG value, use a BG meter to confirm the SG value. Failure to confirm glucose levels when your symptoms do not match the SG value can result in the infusion of too much or too little insulin, which may cause hypoglycemia or hyperglycemia. For more information on using the SmartGuard feature, see *SmartGuard*, page 179.

The sensor does not require calibration for use with the system. However, every blood glucose (BG) meter reading either entered manually or received from a paired meter is used to calibrate the sensor.

What is blood glucose (BG) and sensor glucose (SG)?

Blood glucose and sensor glucose are measured in different places. It is important to understand the differences between the two, as there are times when the system requires you to enter a blood glucose and there are other times when the system will use a sensor glucose.

Glucose travels between the blood and interstitial fluid. The glucose meter measures glucose levels in your blood. The glucose sensor measures glucose in the interstitial fluid. Blood glucose (BG) meter readings and sensor glucose (SG) readings will be close but will rarely exactly match. This difference is normal and should be expected.

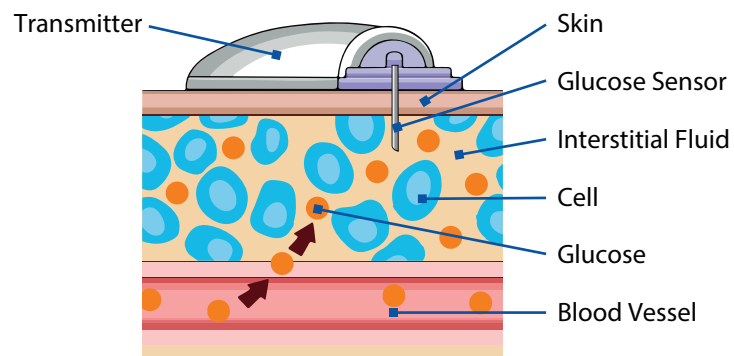

IMPORTANT: When a glucose value is entered into the pump, it must be from a blood glucose (BG) meter.

The system automatically uses the entered glucose value to calibrate the sensor, unless the system gives you the option to calibrate the sensor.

The following table shows when to use a blood glucose (BG) meter reading:

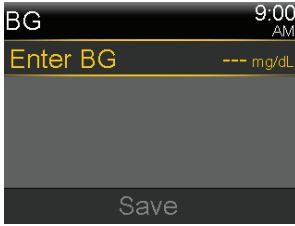
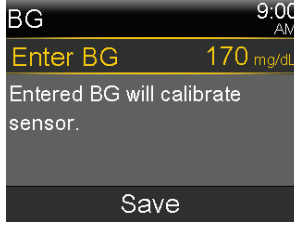
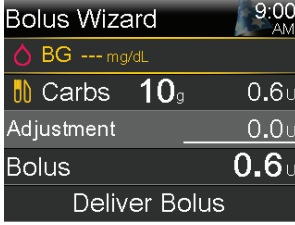
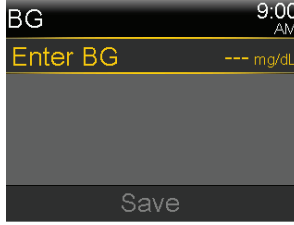
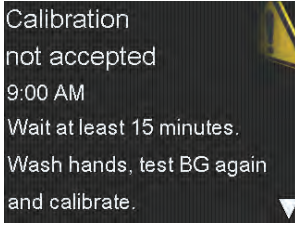
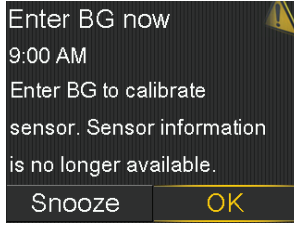
When to use a BG	Examples	
Anytime glucose is entered into the pump, it needs to be a blood glucose (BG) meter reading, not a sensor glucose (SG) value.	Enter BG screen without CGM 	Enter BG screen with CGM 
Anytime you deliver a bolus in Manual Mode and you want to use a glucose for a correction.	Bolus Wizard 	BG 
Anytime the system requests a blood glucose (BG) meter reading.	Calibration not accepted 	Enter BG now 

 **Note:** See when to use a blood glucose (BG) meter reading when SmartGuard is active in *Entering a BG value in the SmartGuard feature*, page 189.

Calibrating the sensor

Calibration is the process of using a blood glucose (BG) meter reading to help the sensor glucose (SG) readings more closely match the glucose measured in your blood.

When you are using the MiniMed 780G system with the Guardian 4 CGM, you do not need to calibrate. However, the system is designed to use every blood glucose (BG) meter reading either entered manually or received from glucose meter to calibrate the sensor.

Home screen with CGM in Manual mode

When the Sensor feature is active, the Home screen displays a real-time graph that shows SG information.



Note: To see the Home screen while the SmartGuard feature is active, see *Home screen with the SmartGuard feature, page 187*.

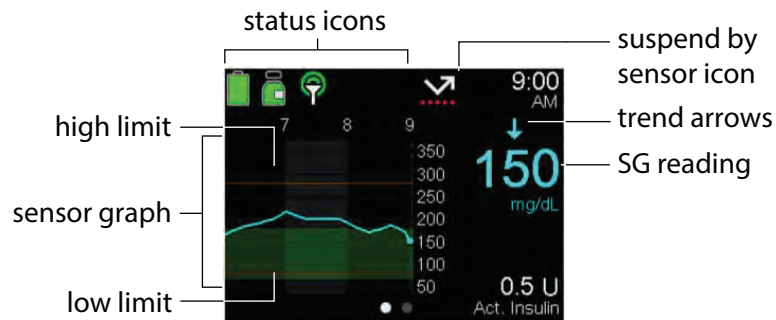

For more information about the icons that appear on the Home screen with CGM in Manual mode, see *Status icons, page 78*.

Trend arrows

The trend graph indicates how sensor glucose (SG) may have recently changed. The trend arrows indicate the rate at which the most recent SG readings are rising or falling. SG readings may trend up or down during certain activities, such as eating, giving a bolus, or when exercising. These icons appear only when the sensor feature is turned on.

- **↑** or **↓**: SG has been rising or falling at a rate of 20 to 40 mg/dL over the last 20 minutes, or 1 to 2 mg/dL per minute.
- **↑↑** or **↓↓**: SG has been rising or falling at a rate of 40 to 60 mg/dL over the last 20 minutes, or 2 to 3 mg/dL per minute.
- **↑↑↑** or **↓↓↓**: SG has been rising or falling at a rate of more than 60 mg/dL over the last 20 minutes, or more than 3 mg/dL per minute.

SG alert settings

An SG alert occurs when an SG reading changes at a particular rate, reaches a specified high or low limit, or before a high or low limit is reached. The pump can also be set to suspend insulin delivery before or when a low limit is reached.

High SG settings

High SG settings provide alerts under the following conditions:

- When SG rises rapidly (Rise Alert).
- When SG approaches the high limit (Alert before high).
- When SG reaches the high limit (Alert on high).

The following graph shows the types of high SG settings.



High SG alert settings

High glucose setting	Description
High limit	The high limit is used as a basis for some high SG settings. The high limit can be set from 100 to 400 mg/dL, for up to eight different time segments.
Alert before high	This setting provides an alert when SG is predicted to reach the high limit, raising awareness of potential high SG.
Time before high	This setting determines how long an Alert before high occurs before the high limit may be reached. It can be set between 5 and 30 minutes.
Alert on high	This setting provides an alert when SG reaches or exceeds the high limit.
High SG alert	This setting provides an alert when SG is at 250 mg/dL or higher for 3 hours. This is a fixed setting and cannot be changed.
Rise Alert	<p>This setting provides an alert when glucose is rising rapidly, such as after a meal or if a bolus is missed. Set the rise rates to match the trend arrows, as shown below, or to a custom rise rate.</p> <ul style="list-style-type: none"> • ↑ - SG is rising at a rate of 1 mg/dL per minute or more. • ↑↑ - SG is rising at a rate of 2 mg/dL per minute or more. • ↑↑↑ - SG is rising at a rate of 3 mg/dL per minute or more. • Custom - SG is rising at a custom rate, set from 1.0 mg/dL to 5.0 mg/dL per minute.
Rise Limit	This setting determines when a Rise Alert occurs.

To set up high SG settings, turn the sensor on and then see *Setting up the High SG settings, page 162*.

Low SG settings

Low SG settings alert or suspend insulin delivery when SG either approaches or reaches the low limit.



Note: The MiniMed Mobile app may be used to view the sensor graph on a mobile device. Always read and acknowledge all alarms and alerts on the pump. If the pump simultaneously generates more than one alarm or alert, only one of the alarms or alerts appears on the mobile device.

The following graph shows the available low SG settings.

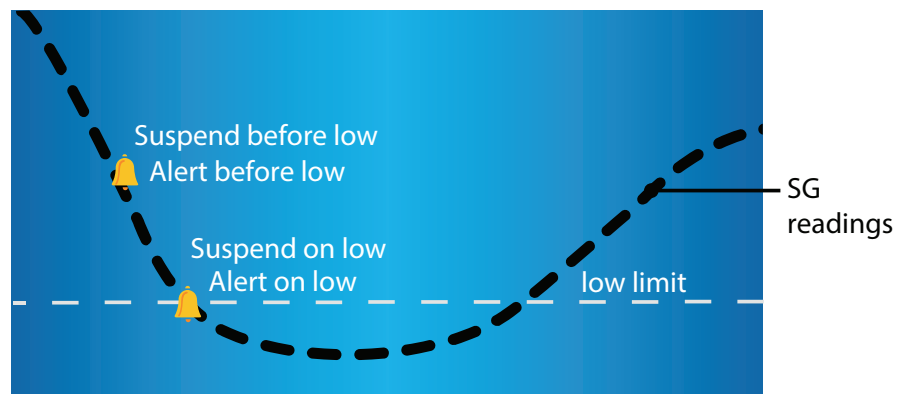

 Low SG alert and suspend settings



WARNING: The Suspend before low and Suspend on low features are not intended to treat low BG. Suspending insulin delivery when SG is low may not bring BG back to the target range for several hours, which may cause hypoglycemia. Confirm SG readings using a BG meter and consult a healthcare professional.

For information about how to program low SG settings in Manual mode, see *Setting up the low SG settings*, page 165. The sensor must be turned on before low SG settings can be programmed.

Low limit

The low limit is used as a basis for optional low SG alerts and Suspend by sensor features. The low limit can be set from 50 mg/dL to 90 mg/dL, for up to eight different time segments.

The Low SG alarm appears when SG readings fall below 64 mg/dL. This threshold may be higher than other sensors. Glucose detection and alert rates are less reliable below this threshold. This is a fixed setting and cannot be changed. When the alarm appears, it shows the SG reading next to the Low SG alarm. For more details, please see *Alert performance, page 375*.

The Suspend before low feature

The Suspend before low feature stops insulin delivery when SG is approaching the low limit. This feature can help minimize the amount of time spent with low glucose.



WARNING: Do not use the Suspend before low feature without first reading the information in this user guide and receiving training from a healthcare professional. The Suspend before low feature temporarily suspends insulin delivery for a maximum of two hours. Under some conditions of use, the pump can suspend insulin delivery again, resulting in under-delivery. Prolonged under-delivery of insulin may increase the risk of hyperglycemia and diabetic ketoacidosis. Always be aware of symptoms. If symptoms don't match SG readings, confirm SG with a BG meter reading.

The Suspend before low feature is turned off by default. Consult a healthcare professional before the Suspend before low feature is used.

If the Suspend before low feature is turned on, Alert on low is automatically turned on. Enabling Alert before low is optional.

- If Alert before low is off, a Suspend before low alert occurs, but the pump does not beep or vibrate when insulin delivery is suspended.
- The Suspend before low and Suspend on low features cannot be on at the same time. When either feature is on, the Resume basal alert can be activated.

Suspend before low conditions

When a Suspend before low event occurs, insulin delivery is suspended. A Suspend before low event occurs if both of the following conditions are met:

- SG reading is at the low limit or is within 70 mg/dL above the low limit.
- SG is predicted to reach or fall below a level that is 20 mg/dL above the low limit within approximately 30 minutes.

The following image is an example of what can happen during a Suspend before low event.

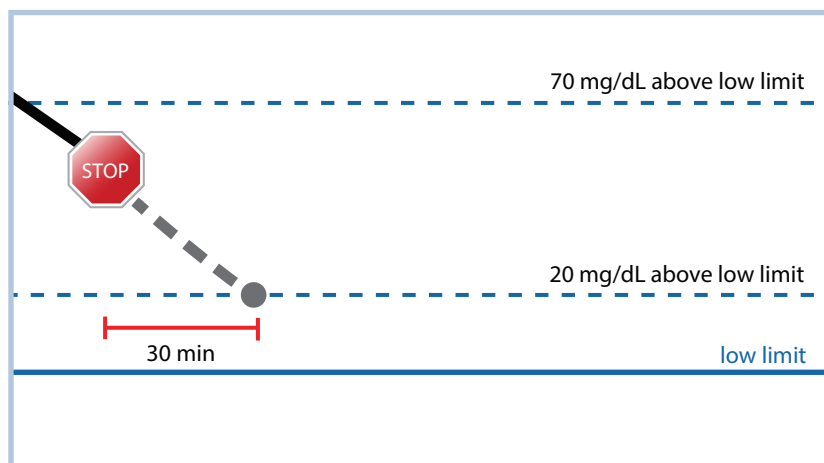

Responding to a Suspend before low event

When the Suspend before low feature suspends insulin delivery, the icon flashes. If SG reaches the low limit, an Alert on low occurs.

When a Suspend before low event occurs, insulin delivery can be suspended for a minimum of 30 minutes or up to a maximum of two hours. Basal insulin delivery can be manually resumed at any time. For details, see *Manually resuming basal insulin delivery during a Suspend before low or Suspend on low event*, page 168. After 30 minutes, basal insulin delivery resumes if both of the following conditions are met:

- SG is at least 20 mg/dL above the low limit.
- SG is predicted to be more than 40 mg/dL above the low limit within 30 minutes.

If the Suspend before low alert is not cleared within two hours, the pump resumes insulin delivery and displays a Basal delivery resumed alert.

Alert before low

Alert before low provides an alert when SG is predicted to reach the low limit, and increases awareness of potential low SG.

The Alert before low feature works as follows:

- If Alert before low is on, and both suspend features are off, Alert before low occurs 30 minutes before the low limit is reached.
- If the Suspend on low feature is on and Alert before low is on, Alert before low occurs 30 minutes before the low limit is reached.
- If the Suspend before low feature is on and Alert before low is on, a Suspend before low alert occurs when insulin delivery is suspended. For details, see *The Suspend before low feature, page 156*.

The Suspend on low feature

The Suspend on low feature stops insulin delivery when SG readings reach or fall below the low limit. When a Suspend on low event occurs, insulin delivery is suspended. This feature is for situations when a person cannot respond to a low glucose condition and can help minimize the amount of time spent with low glucose.



WARNING: Do not use the Suspend on low feature without first reading the information in this user guide and receiving training from a healthcare professional. The Suspend on low feature temporarily suspends insulin delivery for a maximum of two hours. Under some conditions of use, the pump can suspend insulin delivery again, resulting in under-delivery. Prolonged suspension of insulin delivery may increase the risk of serious hyperglycemia, ketosis, and ketoacidosis.

The Suspend on low feature is off by default. Consult a healthcare professional for guidance before the Suspend on low feature is used.

When the Suspend on low feature is on, Alert on low is activated automatically. For more information, see *Alert on low*, page 160.

The following image is an example of what can happen during a Suspend on low event.

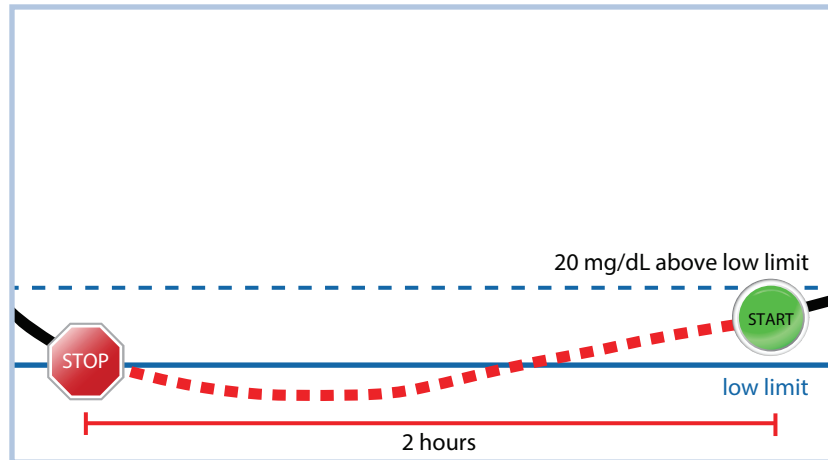

Responding to a Suspend on low event

When the Suspend on low feature suspends insulin delivery, the icon flashes.

When a Suspend on low event occurs, a pump alarm occurs and insulin delivery remains suspended for a minimum of 30 minutes, up to a maximum of two hours. Insulin delivery can be resumed manually at any time. For details, see *Manually resuming basal insulin delivery during a Suspend before low or Suspend on low event*, page 168. After 30 minutes, basal insulin delivery resumes under the following conditions:

- SG is at least 20 mg/dL above the low limit.
- SG is predicted to be more than 40 mg/dL above the low limit within 30 minutes.

If the Suspend on low alarm is not cleared within two hours, the pump resumes insulin delivery and displays an emergency message.

When the Suspend before low or Suspend on low features are unavailable

After a Suspend before low or Suspend on low event, both features are not active for a period of time to help prevent prolonged suspension of insulin delivery. Insulin delivery is suspended for a maximum of two hours. Insulin delivery can be manually suspended

at any time. For details, see *Suspending all insulin delivery and resuming basal insulin delivery*, page 95.

When the Suspend before low and the Suspend on low features are unavailable, the suspend by sensor icon on the Home screen appears with a red X .

Response to Suspend before low or Suspend on low events	Duration that the Suspend before low or Suspend on low feature is unavailable
The alert is cleared within two hours and the pump stays suspended for the maximum two-hour suspend time.	The feature is unavailable for 30 minutes after basal insulin delivery resumes.
The alert is cleared within two hours and insulin delivery automatically resumes due to rising SG levels.	The feature is unavailable for 30 minutes after basal insulin delivery resumes.
The alert is cleared within two hours and basal insulin delivery is manually resumed.	The feature is unavailable for 30 minutes after basal insulin delivery resumes.
The alert is not cleared within 2 hours.	Basal insulin delivery automatically resumes and the feature is available.
The alert is cleared within 30 minutes after basal insulin delivery is automatically resumed.	The feature is unavailable for the remaining time left in the 30 minutes after basal insulin delivery resumed.
The alert is cleared between 30 minutes and four hours after basal insulin delivery is resumed.	The feature is available.
The alert is not cleared.	The feature is unavailable for four hours after basal delivery automatically resumes.

Alert on low

The Suspend before low and the Suspend on low features automatically activate Alert on low. When Alert on low is on, the pump displays an alert when SG reaches or falls below the low limit. If insulin delivery is suspended and the alert is not cleared, an emergency message appears.

Automatically resuming basal insulin delivery after a Suspend before low or Suspend on low event

If insulin delivery is suspended by either the Suspend before low or the Suspend on low feature, basal insulin delivery automatically resumes under one of the following conditions:

- If insulin delivery is suspended for a minimum of 30 minutes and SG readings are at least 20 mg/dL above the low limit and expected to be more than 40 mg/dL above the low limit within 30 minutes
- After a maximum of two hours

Resume basal alert

The Resume basal alert indicates when basal insulin is resumed automatically. When basal insulin delivery resumes and the Resume basal alert is off, a message appears indicating that basal insulin delivery has resumed.

If basal insulin delivery resumes after the maximum suspend time of two hours, an alert appears even if the Resume basal alert is off.

To set up the Resume basal alert, see *Setting up the low SG settings*, page 165.

Setting up CGM





WARNING: Do not use SG values to make treatment decisions, including delivering a bolus, while the pump is in Manual mode. When the SmartGuard feature is active and you are no longer in Manual mode, the pump uses an SG value, when available, to calculate a bolus amount. However, if your symptoms do not match the SG value, use a BG meter to confirm the SG value. Failure to confirm glucose levels when your symptoms do not match the SG value can result in the infusion of too much or too little insulin, which may cause hypoglycemia or hyperglycemia. For more information on using the SmartGuard feature, see *SmartGuard*, page 179.

Turning the Sensor feature on or off

The Sensor feature must be on before SG alerts can be set up and SG levels can be monitored.

The Sensor feature may be turned off at any time. When the transmitter is disconnected from the sensor, turn off the Sensor feature to avoid a sensor alert. The Sensor feature must be turned on again before settings can be changed.



To turn the Sensor feature on or off:

1. From the Home screen, press , and then select .
2. Select **Device Settings** > **Sensor**.
3. Select **Sensor** to turn the feature on or off.

Setting up the High SG settings

For details about high SG settings, see *High SG settings, page 153*.

To set up the high SG settings:

1. From the Home screen, press , and then select .
2. Select **Alert Settings** > **High Alert**.

The High Setup screen appears.

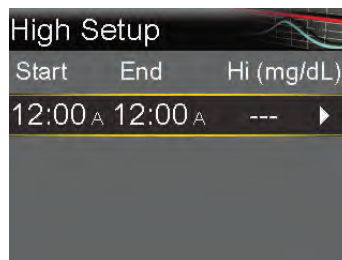

3. Select the time segment. The end time flashes.
The start time of the first time segment is always 12:00 A. Up to eight time segments can be set, each with a different high limit. All the time segments must add up to a 24-hour period.
4. Set the End time.

5. Set the high limit, from 100 mg/dL to 400 mg/dL, in increments of 5 mg/dL.
6. Select the arrow to the right of the End time to select the high alerts for the time segment.

A screen appears and shows the high alerts for the selected time segment.



7. Set the following alerts, as desired:
 - a. Select **Alert before high** to receive an alert before the high limit is reached.
 - b. Set the **Time before high** option between 5 to 30 minutes to receive an alert before the high limit is reached.
 - c. Select **Alert on high** to receive an alert when the high limit is reached.
 - d. Select **Rise Alert** to receive an alert when SG is rising quickly.
8. If Rise Alert is on, perform the following steps to set up the Rise Limit. Otherwise, proceed to step 9.
 - a. Scroll down and select **Rise Limit**.
The Rise Limit screen appears.

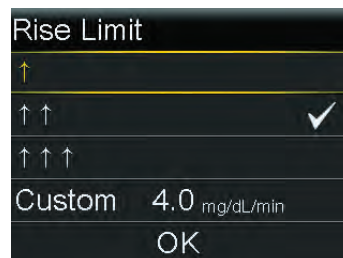

- b. Select one, two, or three arrows for the rise rate, or enter a custom rate.

Arrow selection	Minimum rate that SG is rising when an alert occurs.
↑	SG is rising at a rate of 1 mg/dL per minute or more.
↑↑	SG is rising at a rate of 2 mg/dL per minute or more.
↑↑↑	SG is rising at a rate of 3 mg/dL per minute or more.



Note: These arrows appear on the Home screen to indicate the rate at which SG is rising.



- c. To enter a custom rate, select **Custom**, enter the Rise Limit on the Custom Limit screen, and then select **OK**.
- d. Select **OK** again to confirm the Rise Limit settings.
9. Select **Next**.
10. If necessary, enter the remaining time segments to complete the 24-hour period.



Note: For instructions on setting up more than one high limit over a 24-hour period, see *Settings covering a 24-hour period*, page 91.

11. Select **Review**.
12. Review the high SG settings and select **Save**.

To change the high SG settings:



- From the Home screen, press , and then select .
- Select **Alert Settings > High Alert**.
The High Setup screen appears.

3. Select **Edit**.
4. Select and adjust the time segment.
5. Select any alert setting to make adjustments, or to turn the setting on or off.
6. Select **Next**.
7. Select **Review**.
8. Review the high SG settings and select **Save**.

High Snooze

The High Snooze feature sets the amount of time before a high alert repeats. The pump shows the high alert again if the high alert condition still exists after the specified snooze time.



To set the High Snooze:

1. From the Home screen, press , and then select .
2. Select **Alert Settings > Snooze High & Low**.
The Snooze screen appears.
3. Select **High Snooze** and enter a time in 5-minute increments from 5 minutes to 3 hours.
4. Select **Save**.

Setting up the low SG settings

For information about the low SG settings, see *Low SG settings, page 154*.

To set up the low SG settings:

1. From the Home screen, press , and then select .
2. Select **Alert Settings > Low Alert**.
The Low Setup screen appears.

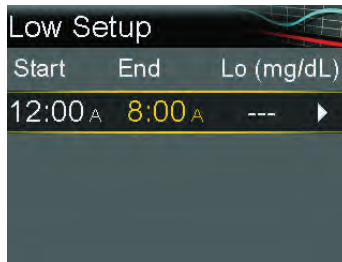

3. Select the time segment. The end time flashes.
The start time of the first time segment is always 12:00 A. Up to eight time segments can be set, each with a different low limit. All the time segments must add up to a 24-hour period.
4. Set the End time.
5. Set the low limit, from 50 mg/dL to 90 mg/dL, in increments of 5 mg/dL.
6. Select the arrow to the right of the End time to select the low SG settings for the time segment.

A screen appears and shows the available settings for the selected time period.

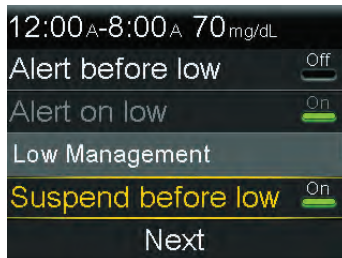

7. Set the following alerts, as desired:
 - a. Select **Suspend before low** to set the pump to suspend insulin delivery before the low limit is reached.
 - b. Select **Alert before low** to receive an alert before the low limit is reached.
 - c. Select **Suspend on low** to set the pump to suspend insulin delivery when SG reaches or falls below the low limit.

- d. Select **Alert on low** to receive an alert when SG reaches or falls below the low limit.
- e. Select **Resume basal alert** to receive an alert when basal insulin delivery resumes during a suspend event. When this alert is off, the Basal delivery resumed message still appears.



Note: The Suspend before low and the Suspend on low features cannot both be on during the same time segment.



- 8. Select **Next**.
- 9. If necessary, enter the remaining time segments to complete the 24-hour period.



Note: For instructions on setting up more than one low limit over a 24-hour period, see *Settings covering a 24-hour period*, page 91.

- 10. Select **Review**.
- 11. Review the low SG settings, and select **Save**.



To change the low SG settings:

- 1. From the Home screen, press , and then select .
- 2. Select **Alert Settings > Low Alert**.
The Low Setup screen appears.
- 3. Select **Edit**.
- 4. Select and adjust the time segment.
- 5. Select any alert setting to make adjustments, or to turn the setting on or off.
- 6. Select **Next**.
- 7. Select **Review**.
- 8. Review the low SG settings, and select **Save**.

Low Snooze

The Low Snooze feature sets the amount of time before a low alert repeats. The pump shows the low alert again if the low alert condition still exists after the specified snooze time.

To set the Low Snooze:

1. From the Home screen, press , and then select .
2. Select **Alert Settings** > **Snooze High & Low**.
The Snooze screen appears.
3. Select **Low Snooze** and enter a time in 5-minute increments from 5 minutes to 1 hour.
4. Select **Save**.

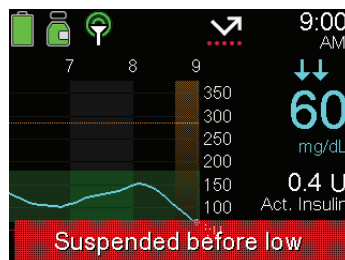

Manually resuming basal insulin delivery during a Suspend before low or Suspend on low event

When the pump suspends insulin due to a Suspend before low or Suspend on low event, the Home screen shows which feature is active.



Basal insulin delivery automatically resumes when certain conditions are met. Basal delivery can be manually resumed at any time.

To manually resume basal delivery:

1. From the Home screen, press , and then select .
2. Select **Resume Basal**.
3. Select **Yes** to resume basal insulin delivery.

Inserting the sensor

Choose an insertion site that has an adequate amount of subcutaneous fat. The Guardian 4 sensor has been studied and is approved for use in the following sensor insertion sites by persons of the following ages:

Refer to the sensor user guide for instructions on how to insert the sensor.

Approved Age	Sensor Insertion Site
7 years and older	Arm



CAUTION: The Guardian 4 sensor is indicated for arm use only. Do not use Guardian 4 sensor in the abdomen or other body sites including the buttocks, due to unknown or different performance that could result in hypoglycemia or hyperglycemia.

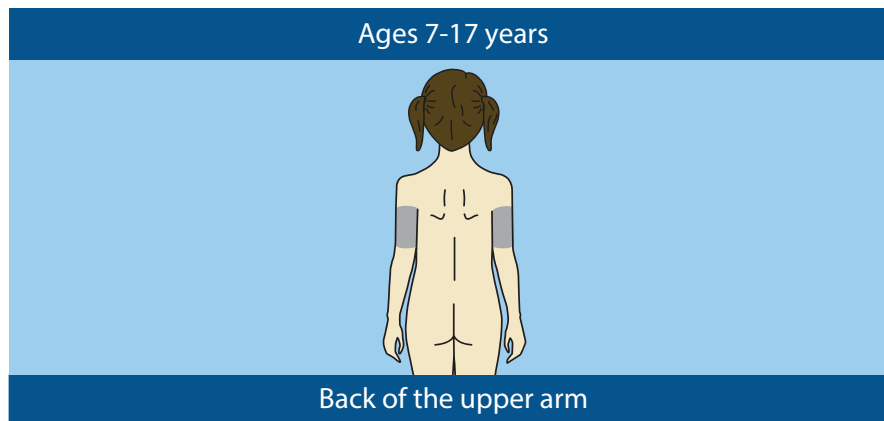

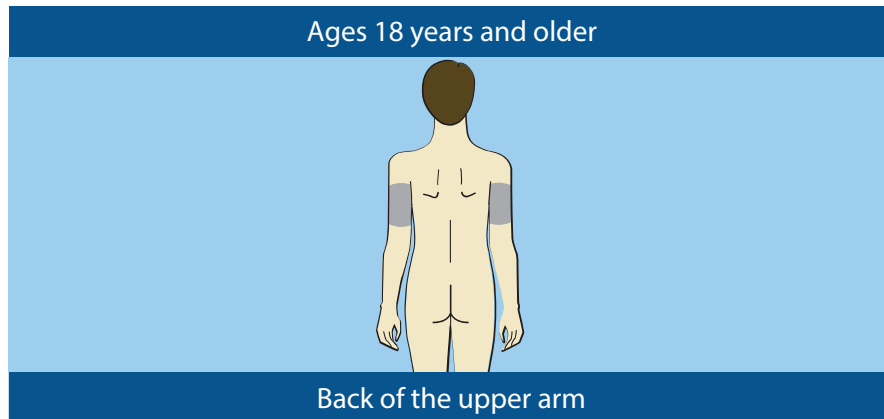

Note: Assistance will likely be needed for sensor insertion into the back of the upper arm. Some users find it difficult to insert the sensor into their arm by themselves.

Connecting the transmitter to the sensor

Refer to the transmitter user guide for instructions on how to connect the transmitter to the sensor.

Starting the sensor

After the sensor is inserted and paired with the transmitter, the pump will display a Start New Sensor screen.

To start a new sensor:

1. Select **Start New Sensor** when it appears on the pump screen.

The "Sensor warm up X:XX hr" message appears.

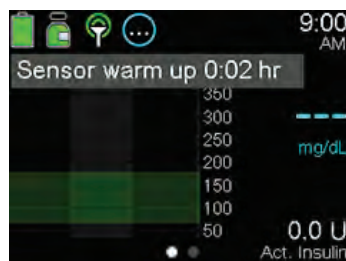



Note: It may take up to five minutes for the “Sensor warm up X:XX hr” message to appear. The warm up period lasts two hours.

2. Select **OK**.

The “Sensor warm up X:XX hr” message appears on the Home screen until the sensor warm up is complete.

After the warm up is complete, the pump begins receiving SG readings.

Reconnecting the sensor

If the transmitter is removed from a sensor while the sensor is inserted in the body, the pump detects when the transmitter is reconnected to the sensor and a “Sensor connected” message appears.

To reconnect a sensor:

1. Select **Reconnect Sensor**.

The “Sensor warm up X:XX hr” message appears.



Note: It may take up to five minutes for the “Sensor warm up X:XX hr” message to appear. The warm up period lasts two hours.

2. Select **OK**.

The “Sensor warm up X:XX hr” message appears on the Home screen until the sensor warm up is complete.

After the warm up is complete, the pump begins receiving SG readings.

Using CGM

CGM can help identify SG trends and provide notifications when SG falls or rises rapidly. Use the following information to interpret historical SG readings and to silence sensor alerts, when necessary.



WARNING: Do not use SG values to make treatment decisions, including delivering a bolus, while the pump is in Manual mode. When the SmartGuard feature is active and you are no longer in Manual mode, the pump uses an SG value, when available, to calculate a bolus amount. However, if your symptoms do not match the SG value, use a BG meter to confirm the SG value. Failure to confirm glucose levels when your symptoms do not match the SG value can result in the infusion of too much or too little insulin, which may cause hypoglycemia or hyperglycemia. For more information on using the SmartGuard feature, see *SmartGuard*, page 179.

The sensor graph when using CGM

The sensor graph provides current SG reading information that is transmitted to the pump. If the MiniMed Mobile app is in use, the sensor graph can be viewed on a mobile device.

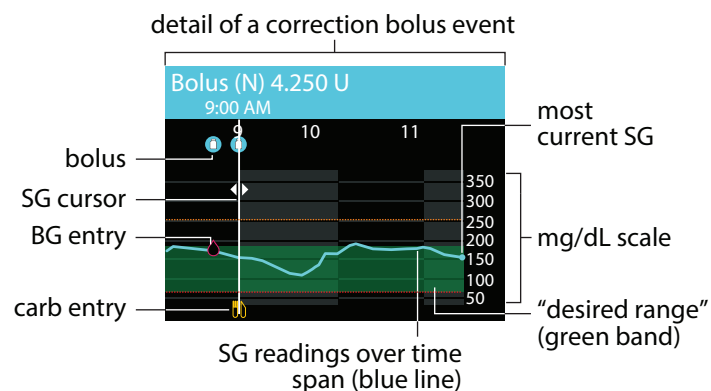

The sensor graph includes the following information:





- The most recent SG reading.
- Historical SG readings for the last 3-hour, 6-hour, 12-hour, or 24-hour periods.
- High and low SG limits.
- Carb entries.

- Boluses delivered during the time period displayed on the graph.
- Suspend events caused by Suspend before low or Suspend on low.
- BG entries.

There are several reasons why an SG reading may not appear on the graph:

- A recently inserted sensor is still warming up.
- A recently reconnected sensor is not ready.
- An error condition or a sensor-related alert is occurring. For a list of sensor alerts, see *CGM (sensor) alarms, alerts, and messages, page 307*.

To view the sensor graph:

1. From the Home screen, press the  button.
A full-screen view of the 3-hour graph appears.
2. Press  to navigate to the 6-hour, 12-hour, and 24-hour graphs.
3. Press  to view SG readings and event details.
4. To exit the full-screen view, press , or press the  button again.

Silencing sensor alerts

The Alert silence feature silences certain sensor alerts for a set period of time. When using this option, the Alert silence icon  appears on the Home screen. The system still displays any alerts that occur, but there is no sound or vibration if they are silenced. This information can be reviewed in the Alarm History screen.



The Alert silence feature does not silence:

- **High SG alert**—When your sensor glucose (SG) value is above 250 mg/dL for more than three hours
- **Low SG alarm**—When your sensor glucose (SG) value falls below 64 mg/dL
- **SmartGuard exit alert**—When the pump exits the SmartGuard feature

The following table describes the sensor alerts that are silenced with each option.

Option	Silences these alerts
High Alerts Only	Alert on high, Alert before high, and Rise Alert
High & Low Alerts	Alert on high, Alert before high, Rise alert, Alert on low, Alert before low, Suspend before low, and Resume basal alert Note: Alert on low cannot be silenced if the Suspend before low or Suspend on low features are turned on.
All Sensor Alerts	All of the alerts listed previously for High & Low Alerts, as well as the following: <ul style="list-style-type: none"> • All calibration alerts, reminders, or error messages that may result from entering a BG reading • All alerts related to sensor insertion, including alerts about sensor warm-up, changing the sensor, sensor expiration, sensor updating, and connection issues. • All alerts related to the transmitter, including transmitter battery alerts and connection issues

To silence sensor alerts:

1. From the Home screen, press , and then select .
2. Select **Silence Sensor Alerts**.





3. Select **High Alerts Only**, **High & Low Alerts**, or **All Sensor Alerts**. Refer to the previous table for details about the alerts silenced with each selection.



Note: Silencing **All Sensor Alerts**, prevents the sound and vibration of most alerts related to SG readings, the sensor, and the transmitter. The Low SG alarm, for when SG has fallen below 64 mg/dL, the SmartGuard exit alert, and the High SG alert cannot be silenced.

4. Set the **Duration**. The duration can be set in 15-minute increments from 30 minutes to 24 hours.
5. Select **Begin**.

To cancel Alert Silence:

1. From the Home screen, press , and then select .
2. Select **Alert Silence**.

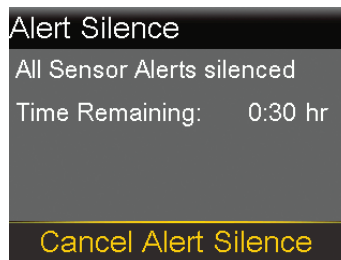

3. Select **Cancel Alert Silence**.



8



SmartGuard

8

SmartGuard

This chapter provides information about how to set up and start using the SmartGuard feature. The SmartGuard feature uses sensor glucose (SG) values provided by the Guardian 4 transmitter and Guardian 4 sensor to automatically adjust insulin delivery.

Introduction

The SmartGuard feature uses meal information, sensor glucose (SG), and SmartGuard target values to control basal insulin delivery. It also can automatically deliver a correction bolus to help correct a high SG reading. The MiniMed 780G insulin pump requires a minimum of eight units and a maximum of 250 units per day to operate using the SmartGuard feature.



Note: The Auto correction feature uses SG values to determine bolus insulin doses. Auto correction boluses are delivered without user acknowledgment. The accuracy of SG values can be lower than the accuracy of blood glucose (BG) meter readings, which are checked with a blood glucose meter.

The SmartGuard feature is designed to maximize the amount of time that glucose levels stay in the range of 70 mg/dL to 180 mg/dL. The following table describes features that the system uses to maximize time in range.

Feature name	Description
SmartGuard target: 100 mg/dL, 110 mg/dL, or 120 mg/dL	Consult a healthcare provider to determine which SmartGuard target to use to maximize time in range. The default setting is 100 mg/dL.
Auto Basal	When using the SmartGuard feature, basal insulin is automatically delivered based on SG readings and recent insulin delivery needs.
Target for Auto correc- tion bolus based on SG: 120 mg/dL	The MiniMed 780G system may deliver a bolus automatically, as frequently as every five minutes, if the SmartGuard feature determines that a correction bolus is necessary. The default setting for Auto correction is set to On.
Temp Target: 150 mg/dL	A temp target can be set for events such as exercise or other times when less insulin is needed. If a temp target is used for exercise, consider starting it one to two hours before beginning the exercise. Auto correction boluses are not delivered while a temp target is active.



Note: When using the SmartGuard feature, meal boluses are still required.

The SmartGuard feature requires accurate sensor measurements and carb information to deliver insulin for meals. This insulin therapy requires the use of the Bolus feature to deliver boluses to cover meals.

When using the SmartGuard feature:

- If an Enter BG alert occurs, enter a BG meter reading.
- Do not enter an SG reading when the system requests a BG reading.
- Bolus amount cannot be adjusted when delivering a bolus in the SmartGuard feature. If SG readings do not match with symptoms, enter a BG value from a BG meter reading.

Auto Basal

When the SmartGuard feature is active, the basal insulin dose is calculated using SG values from the sensor. The automatic delivery of insulin is called Auto Basal.

Auto Correction

The pump may deliver a bolus automatically when the SmartGuard feature determines it is needed for correction, to maximize the time in range, between 70 mg/dL and 180 mg/dL. Because this is an automated bolus, no action is required. The Home screen shows when an Auto Correction bolus occurs.

Giving a bolus when the SmartGuard feature is active

A meal bolus can be delivered while using the SmartGuard feature. For more information, see *Delivering a bolus in the SmartGuard feature*, page 191.



WARNING: Always confirm an SG value that does not match your symptoms. When the SmartGuard feature is active and you are no longer in Manual mode, the pump uses an available SG value to calculate a bolus amount. However, if your symptoms do not match, the SG value can result in the infusion of too much or too little insulin, which may cause hypoglycemia or hyperglycemia.

Preparing to set up the SmartGuard feature

The SmartGuard feature requires a 48-hour warm-up period before activation. This warm-up period begins at midnight after the pump starts delivering insulin and it does not require sensor use. During the warm-up period, the pump collects and processes data for use by the SmartGuard feature.



Note: A basal pattern must be programmed for use during the warm-up period and for instances when the pump is in manual mode. During the warm-up period the pump should also be used to give boluses.

To prepare the pump for the SmartGuard feature:

1. Cancel any active Temp Basal rates. See *Canceling a temp basal or preset temp basal*, page 242.
2. Confirm that insulin delivery is not suspended. See *Suspending all insulin delivery and resuming basal insulin delivery*, page 95.
3. Set the carb ratio. See *Changing the carb ratio*, page 252.
4. Review the high and low limit settings. High and low limit settings apply when in Manual mode and when using the SmartGuard feature. See *SG alert settings*, page 153 for details.
5. Enter a new BG reading.





WARNING: If the pump has been used in the last 14 days to practice button pressing, or if insulin that was programmed into the pump was not the user's actual insulin delivery, clear active insulin and the total daily doses tracked by the SmartGuard feature before using the SmartGuard feature. Failure to do so may result in the delivery of too little or too much insulin, which can cause hyperglycemia or hypoglycemia. The SmartGuard feature uses the recent delivery history on the pump to determine the insulin delivery amount.

Consult with your healthcare professional about using the Clear Active Insulin feature in the Manage Settings menu to clear both active insulin and the total daily dose for the SmartGuard feature.

Setting up the SmartGuard feature

The SmartGuard feature requires 48-hours of insulin delivery before the feature can be used. This warm up period begins at the first midnight after delivery has started. For more information, see *Preparing to set up the SmartGuard feature*, page 181.

To set up the SmartGuard feature:

1. From the Home screen, press , and then select .
2. Select **SmartGuard** to turn the feature on or off.



Note: Certain additional requirements must be met before the SmartGuard feature activates. For more information, see *SmartGuard Checklist, page 184*.

3. Select **SmartGuard Settings** and enter the following information:
 - Select the SmartGuard target: 100 mg/dL, 110 mg/dL, or 120 mg/dL.
 - Confirm that **Auto Correction** is on to activate automatic correction boluses.



Note: The Auto correction feature is turned on by default. When this setting is on, the pump automatically delivers correction boluses to help correct a high SG reading. For information, see *Delivering a bolus in the SmartGuard feature, page 191*.

4. Select **Save**.

Conditions to activate the SmartGuard feature

If the pump is turned off for more than two weeks and is turned back on, the pump requires 48 hours before the SmartGuard feature activates.

If the pump has been off for two weeks or less and is turned back on, a five-hour warm-up period is required before the SmartGuard feature activates.

If the SmartGuard feature is on but not active, the SmartGuard Checklist screen indicates the requirements needed to activate the SmartGuard feature. See *SmartGuard Checklist, page 184*.

The system requires five hours for the SmartGuard active insulin amount to update. This update time begins under the following conditions:

- The pump is turned on for the first time.
- A complete pump reset caused by a loss of power or a software error.
- When the insulin is resumed after being manually suspended for four hours or longer.

SmartGuard active insulin information is valid until one of the conditions listed above occurs, which restarts the five-hour update time. The SmartGuard feature is unavailable during this time.

Suspending manually while using the SmartGuard feature



For information about manually suspending insulin delivery, see *Suspending all insulin delivery and resuming basal insulin delivery*, page 95.

Suspend before low and Suspend on low features while using the SmartGuard feature

When the SmartGuard feature is active, the Suspend before low and the Suspend on low features are unavailable and automatically turn off. If the SmartGuard feature is not active, the Suspend before low and the Suspend on low features return to the state they were in before using the SmartGuard feature. For information about turning on the Suspend before low or the Suspend on low feature, see *Low SG settings*, page 154.

SmartGuard Checklist







The SmartGuard Checklist screen indicates the requirements necessary to start or continue using the SmartGuard feature. For more information, see *Staying in the SmartGuard feature*, page 197.



The following table shows what to do when the wait icon  or the question icon  appear by items on the SmartGuard Checklist screen.

SmartGuard Checklist

- ① Enter BG ?
- ② SmartGuard turned off ?
- ③ Sensor not ready ..
- ④ Bolus in progress ?
- ⑤ Delivery suspended ?
- ⑥ Carb ratio not set ?
- ⑦ Temp Basal rate ?
- ⑧ SmartGuard updating ..
- ⑨ SmartGuard warming up ..

Line	Item	Instructions
①	Calibration required ?	Enter a new BG meter reading.
	Enter BG ?	Enter a new BG meter reading.
	Wait to calibrate ..	The system requires a BG reading and will ask when it is ready.
②	SmartGuard turned off ?	Turn on the SmartGuard feature.

Line	Item	Instructions
3	Sensor not ready 	<ul style="list-style-type: none"> Confirm the pump shows a sensor serial number on the Paired Devices screen. Example: CGM XXXXXXXX Make sure the pump is paired with a sensor. For more information, see <i>Pairing the pump and transmitter</i>, page 139. Check the Home screen. If  displays, move the pump and sensor closer together. It may take 15 minutes to find the sensor signal. If after 30 minutes the pump and sensor are still not communicating, a Lost sensor signal alert appears. Check that the sensor is still inserted in the skin. Move the pump closer to the sensor. If SG is outside of the 50 to 400 mg/dL range, the SmartGuard feature is unavailable.
	Sensor off 	Turn on the Sensor feature in Settings > Device Settings.
	No paired CGM 	Pair the pump and sensor. For more information, see <i>Pairing the pump and transmitter</i> , page 139.
4	Bolus in progress 	Wait until the bolus is complete or stop the bolus before the SmartGuard feature can be used.
5	Delivery suspended 	If insulin delivery is suspended, the SmartGuard feature cannot be used. Treat low BG as instructed by a healthcare professional.
6	Carb ratio not set 	Enter a carb ratio in the Bolus Wizard feature or in the Bolus Wizard Setup screen.

Line	Item	Instructions
7	Temp Basal rate 	Stop the temp basal rate delivery before the SmartGuard feature can be used or wait until the temp basal rate delivery is complete.
8	SmartGuard updating 	If SmartGuard active insulin is updating, it will take up to five hours to complete. Wait for the update time to end before the SmartGuard feature can activate.
9	SmartGuard warming up 	Wait for the SmartGuard feature to gather insulin delivery history and determine the basal rate.

To view the SmartGuard Checklist:

1. From the Home screen, press , and then select .
2. Select **SmartGuard Checklist**.

Home screen with the SmartGuard feature

When the pump is using the SmartGuard feature, the Home screen displays a shield with the current SG level.



Note: When the SmartGuard feature first activates, the value in the shield shows the entered BG reading until the first SG reading is received from the sensor.



Using the SmartGuard feature

The sensor graph with the SmartGuard feature

The sensor graph with the SmartGuard feature shows historical SG readings provided by the sensor.

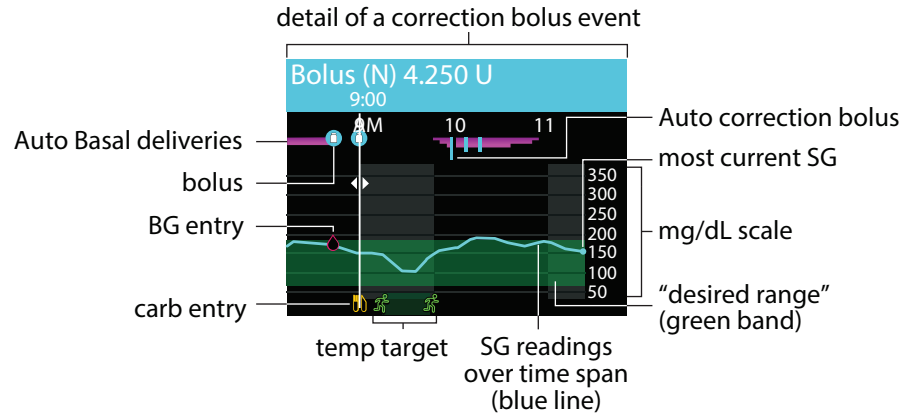





The SmartGuard feature sensor graph includes the following information:

- When a location on the graph is selected, specific details of the SG or event appear, such as a correction bolus.
- Historical SG readings are displayed for the last 3-hour, 6-hour, 12-hour, or 24-hour periods. They appear as a blue line across the screen.
- Boluses are shown as white vials inside blue circles.
- Carb entries are shown as yellow knife and fork symbols. These represent any bolus amounts that include a carb entry.
- BG entries appear as red drop symbols.
- Magenta bands across the top represent Auto Basal deliveries provided by the SmartGuard feature.
- Blue vertical bars at the top represent Auto correction boluses delivered by the SmartGuard feature.

- A time change event appears as a white clock symbol.
- Temp target is shown as green runners.

To view the sensor graph:

1. From the Home screen, press the  button to display the SG graph.
A full-screen view of the 3-hour graph appears.
2. Press  to navigate to the 6-hour, 12-hour, and 24-hour graphs.
3. Press  to view SG readings and event details.
4. To exit the sensor graph, press  or press the  button again.

Entering a BG value in the SmartGuard feature

The pump may require a BG value to continue using the SmartGuard feature.

There are two ways to enter a BG value when using the SmartGuard feature. Manually enter a BG value or enter a BG value using the compatible Accu-Chek™* Guide Link meter. For more information on manually entering a BG, see *Entering a blood glucose (BG) meter reading*, page 100.

The following table shows when to use a blood glucose (BG) meter reading:

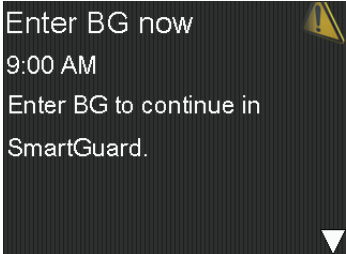
When to use a blood glucose (BG) meter reading	Examples
Anytime the system requests a blood glucose (BG) meter reading.	

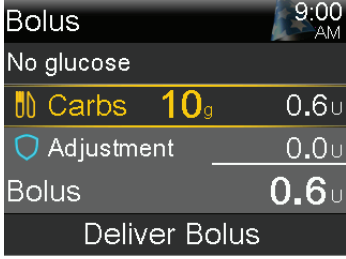
When to use a blood glucose (BG) meter reading	Examples
	 <p>The screenshot shows a mobile application interface with a black background. At the top right, the time is 9:00 AM. In the center, a large white shield contains the number '150' and 'mg/dL' below it. To the left of the shield, it says 'Exit in 0:30 hr'. To the right, it says '0.6 U Act. Insulin'. At the bottom, there is a blue button labeled 'Enter BG'.</p>
<p>Anytime you deliver a bolus in SmartGuard when a sensor glucose (SG) value is not displayed on the bolus screen and you want to use a glucose for a correction.</p>	 <p>The screenshot shows a 'Bolus' screen with a black background. At the top right, the time is 9:00 AM. Below the title, it says 'No glucose'. There are three rows of input fields: 'Carbs 10g' with '0.6U' to its right, 'Adjustment' with '0.0U' to its right, and 'Bolus' with '0.6U' to its right. At the bottom, there is a button labeled 'Deliver Bolus'.</p>
<p>When using a medication that impacts glucose levels.</p>	
<p>When your sensor glucose (SG) values are different than the symptoms you are experiencing.</p>	
<p>The most recent sensor glucose (SG) reading is unavailable. Sensor glucose (SG) readings are unavailable in the following conditions:</p> <ul style="list-style-type: none"> • A new sensor is started. • A Sensor Updating notification appears. • The sensor requires a new blood glucose (BG) meter reading to be entered because the system was unable to use the blood glucose (BG) meter reading that was entered to calibrate the sensor. All blood glucose (BG) meter readings that are entered are used to calibrate the sensor. 	
<p>There is doubt that sensor glucose (SG) values are correct.</p>	



WARNING: Consult a healthcare professional before using sensor glucose values to make treatment decisions if a medication that contains acetaminophen or paracetamol is taken while wearing the sensor. Medications that contain acetaminophen or paracetamol can falsely raise sensor glucose readings. The level of inaccuracy depends on the amount of acetaminophen or paracetamol active in the body and can differ for each person. Falsely elevated sensor readings can result in over-delivery of insulin, which can cause hypoglycemia. Medications that contain acetaminophen or paracetamol include, but are not limited to, cold medicines and fever reducers. Check the label of any medications being taken to see if acetaminophen or paracetamol is an active ingredient. Use additional blood glucose meter readings to confirm blood glucose levels.

If acetaminophen or paracetamol is taken, stop the use of the medication before using sensor glucose readings to make treatment decisions. Use additional blood glucose meter readings to confirm blood glucose levels. If acetaminophen or paracetamol is taken while the SmartGuard feature is active, program a temp target for up to eight hours, or the amount of time recommended by a healthcare provider. For more information, see *Setting a temp target, page 196*. Use blood glucose values instead of sensor glucose readings to calculate a meal bolus or correction bolus up to eight hours, or the duration recommended by a healthcare provider, after taking acetaminophen or paracetamol.

Delivering a bolus in the SmartGuard feature



WARNING: Always confirm an SG value that does not match your symptoms. When the SmartGuard feature is active and you are no longer in Manual mode, the pump uses an available SG value to calculate a bolus amount. However, if your symptoms do not match, the SG value can result in the infusion of too much or too little insulin, which may cause hypoglycemia or hyperglycemia.



WARNING: Do not use the SmartGuard feature for a period of time after giving a manual injection of insulin by syringe or pen. Manual injections are not accounted for in the active insulin amount. Using the SmartGuard feature after a manual injection may result in over-delivery of insulin. Too much insulin may cause hypoglycemia. Consult a healthcare professional for how long to wait after a manual injection before resuming the SmartGuard feature.



WARNING: SG readings are used to calculate meal boluses or correction boluses when delivering a bolus in the SmartGuard feature. SG is not the same as BG. Sensor performance may occasionally vary from sensor to sensor and in different situations for a sensor, such as on the first day of use.

When SG readings are used for meal boluses and for correction boluses, there is a risk of both hypoglycemia and hyperglycemia. If an SG reading is much lower than a BG reading would be at that time, there is a risk of hyperglycemia, because the amount of insulin delivered could be smaller. If an SG reading is much higher than a BG and there are symptoms of feeling low, but the SG reading is not low, and if there are symptoms of a severe hypoglycemic event, a severe hyperglycemic event, or diabetic ketoacidosis, a BG meter reading is needed.



This can also occur when SG readings are used when the Auto correction feature is turned on. For example, when an SG reading is much higher than a BG reading at that time, there is a risk of hypoglycemia, because the amount of insulin delivered could be larger.

If there are symptoms of feeling low, but the SG reading is not low, and if there are symptoms of a severe hyperglycemic event or diabetic ketoacidosis, a BG meter reading is needed.

A current BG or SG reading is used to determine the bolus amount. A carb amount can be entered for a food bolus.

If the BG or SG is under 120 mg/dL, or if the bolus is zero after the pump accounts for active insulin, or if the SmartGuard feature estimates current basal delivery is sufficient, no correction is recommended.

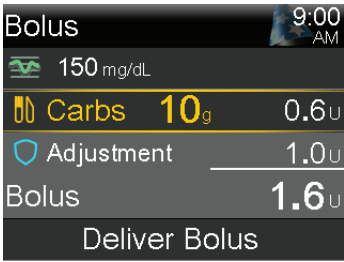
The following table describes how glucose readings are shown on the SmartGuard bolus screen.

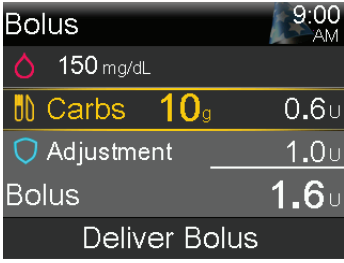
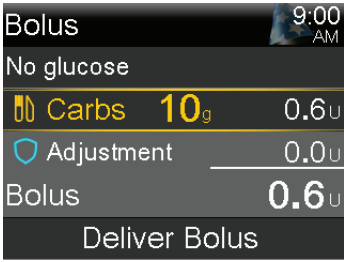

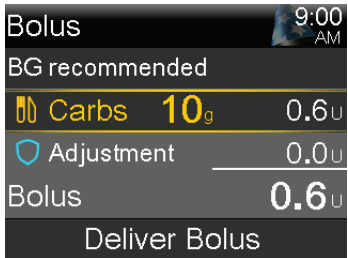
Bolus screen	Glucose reading information
	<p>The  icon indicates there is no recent blood glucose (BG) meter reading available, but a sensor glucose (SG) value is available.</p> <p>A blood glucose (BG) meter reading can be entered to calculate a correction bolus. The correction bolus is included in the Adjustment.</p>
	<p>A blood glucose (BG) meter reading is available to calculate a correction bolus. The correction bolus is included in the Adjustment.</p>
	<p>There are no blood glucose (BG) meter readings or sensor glucose (SG) values available.</p> <p>You can enter a carb amount for a food bolus or a blood glucose (BG) meter reading for a correction bolus.</p>

Bolus screen	Glucose reading information
 <p>The screenshot shows a dark-themed interface with the following text: 'Bolus' at the top right with a clock icon and '9:00 AM'. Below it is 'BG recommended'. The main line shows 'Carbs 10g' with a fork and knife icon and '0.6 U'. Below that is 'Adjustment' with a shield icon and '0.0 U'. The final line shows 'Bolus 0.6 U' and a 'Deliver Bolus' button at the bottom.</p>	<p>The BG recommended message indicates that neither a blood glucose (BG) meter reading nor a sensor glucose (SG) reading is available to calculate a correction bolus.</p> <p>Note: If a sensor glucose (SG) value shows on the Home screen, but does not show on the Bolus screen, the system determined that the sensor glucose (SG) value is not optimal to use to calculate a correction bolus. Enter a blood glucose (BG) meter reading if a correction bolus is desired.</p>

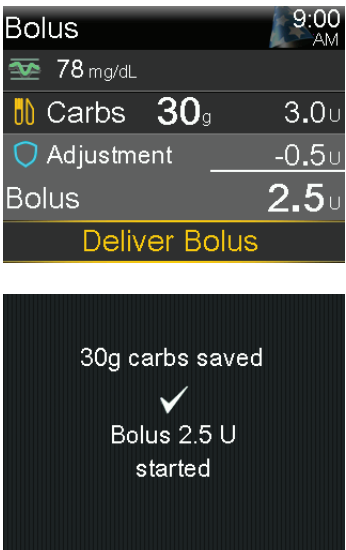

Bolus adjustments in the SmartGuard feature

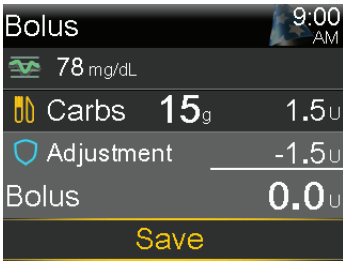
The SmartGuard feature calculates a bolus based on the current BG or SG reading and carbs, and may make an additional adjustment to the bolus.

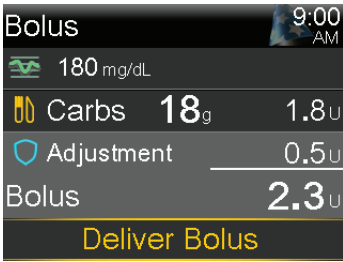
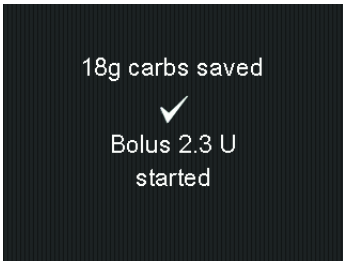
Bolus adjustment	Example screens
<p>The bolus amount is adjusted down if the SmartGuard feature predicts a risk of hypoglycemia after the meal.</p> <p>Carbs are saved for use in future bolus adjustment calculations.</p>	 <p>The first screenshot shows a 'Bolus' screen with a green arrow icon and '78 mg/dL'. It lists 'Carbs 30g' with '3.0 U', an 'Adjustment' of '-0.5 U', and a resulting 'Bolus 2.5 U'. A 'Deliver Bolus' button is at the bottom. The second screenshot is a confirmation message: '30g carbs saved' with a checkmark icon, followed by 'Bolus 2.5 U started'.</p>

Bolus adjustment	Example screens
<p>If the bolus amount is adjusted down to 0.0 for the bolus, no bolus is delivered.</p> <p>Carbs are saved for use in future bolus adjustment calculations.</p>	 
<p>The bolus amount is adjusted up if a correction bolus is calculated based on high glucose and low active insulin.</p> <p>Carbs are saved for use in future bolus adjustment calculations.</p>	 

To deliver a bolus with the SmartGuard feature:

1. From the Home screen, press , and then select .
2. Select **Bolus**.
3. Enter a carb amount, if desired.

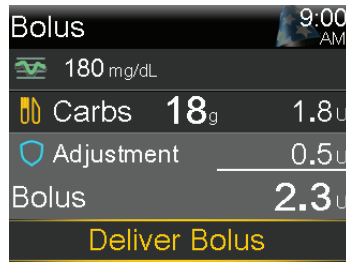

The screen indicates the amount of the calculated bolus.

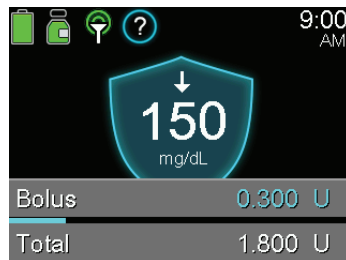

4. Select **Deliver Bolus**.

A screen appears briefly to indicate the bolus delivery has started. The Home screen appears and shows the progress of the bolus delivery.



Note: To stop a bolus, press  from the Home screen, select , and then select **Stop Bolus**. Select **Yes** to confirm.



Setting a temp target

A temporary target (temp target) of 150 mg/dL can be set for events such as exercise or other times when less insulin is needed. Consult a healthcare professional before using a temp target.



Note: The Auto correction feature is not active during an active temp target. It resumes after the temp target completes.

To set a temp target:

1. From the Home screen, press , and then select .
2. Select **Temp Target** to turn the feature on or off.

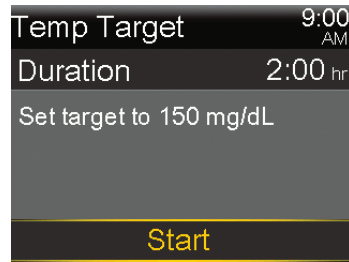

- Set the duration, from 30 minutes to 24 hours, in 30-minute increments.
- Select **Start**.

The screen shows a Temp Target Started message, and then changes to the Home screen, where a banner shows the remaining temp target time.



To cancel a temp target:

- From the Home screen, press , and then select .

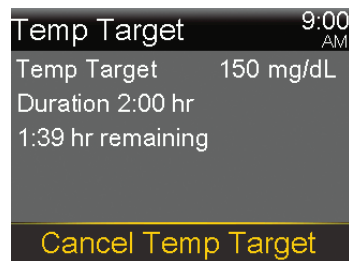

- Select **Cancel Temp Target**.

Staying in the SmartGuard feature

When the pump requires an action to stay in the SmartGuard feature, it delivers insulin at a fixed basal rate for up to a maximum of four hours.

The message “Exit in X:XX hr” appears on the Home screen, showing the time remaining before the pump enters Manual mode. The basal rate delivered during this time is based on insulin delivery history and represents a delivery rate that minimizes the risk of hypoglycemia in situations when SG values are temporarily unavailable. The pump provides a notification of any required actions.

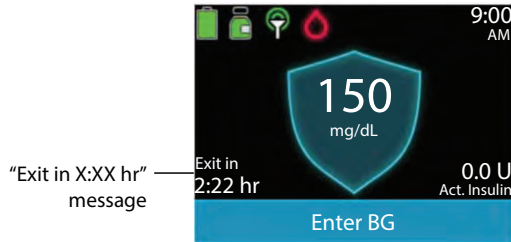

The pump resumes using SG readings for basal insulin delivery when certain conditions are met. The following table describes these conditions and the notification and required action to resume using SG readings for basal insulin delivery.

Condition	Notification and action
The SmartGuard feature has reached the time limit for minimum delivery. The minimum delivery time is three to six hours, depending on the reason.	A SmartGuard min delivery alert appears. Enter a BG.
The SmartGuard feature has been delivering basal insulin at its maximum limit for seven hours.	A SmartGuard max delivery alert appears. Check the SmartGuard Checklist to determine the required steps. Enter a BG.
SG readings may be lower than actual glucose values.	An Enter BG alert appears. Enter a BG.
No SG data has been received for more than five minutes.	<ul style="list-style-type: none"> If SG data is not available, three dashes appear on the screen in place of the SG data. If the loss of SG data is intermittent, no action is required.

Condition	Notification and action
	<ul style="list-style-type: none"> If an action is required, an alert appears such as a Lost sensor signal alert or the Enter BG now alert. Follow the instructions on the screen.



Note: To stay in the SmartGuard feature when changing the sensor, be sure the sensor warmup completes within four hours of the last available SG reading.

Exiting the SmartGuard feature

The SmartGuard feature may stop functioning under the following conditions:

- The SmartGuard feature is turned off.
- The pump is delivering basal insulin based on insulin delivery history, and not SG readings, for four hours. See *Staying in the SmartGuard feature*, page 197.
- All insulin delivery has been manually suspended and has not resumed for four hours.
- The Sensor feature is turned off or the transmitter is disconnected.

The SmartGuard feature can be turned off at any time. For more information, see *Setting up the SmartGuard feature*, page 182.

Returning to the SmartGuard feature after an exit

The pump indicates any required actions on the Home screen, after an exit from the SmartGuard feature. In the example below, a BG entry is needed. Once the BG is entered, the pump resumes using the SmartGuard feature.



While in Manual mode, resume using the SmartGuard feature by meeting all requirements in the SmartGuard Checklist. For more information, see *SmartGuard Checklist, page 184*.

The SmartGuard feature can be resumed under the following conditions:

- The SmartGuard feature is turned on.
- The sensor is providing SG readings.
- A bolus is not in progress.
- A temp basal rate is not in progress.
- The 48-hour warm-up is complete.
- The SmartGuard feature is not in a five-hour warm-up period.
- A new BG reading is entered.

If any of these conditions are not met, the SmartGuard feature cannot restart.

Using Block mode with the SmartGuard feature

Block mode lets caregivers lock the pump to restrict access to critical pump features. While the pump is locked, Auto Basal delivery is active, and Auto correction boluses can occur if the feature is turned on. BG readings received from the Accu-Chek™* Guide Link meter can be confirmed. For more information on Block mode, see *Block mode, page 204*.

Alert silence feature

The Alert silence feature silences certain sensor alerts for a set period of time. For more information, see *Silencing sensor alerts, page 173*.

9



General settings

9



General settings

This chapter provides information about common tasks for various settings.

Time and date

Confirm that the time and date are always set correctly on the MiniMed 780G insulin pump. Incorrect time and date settings can affect basal insulin delivery and the accuracy of pump history. Change the time or the date to match the time zone or daylight saving time. After the time and date are changed, the pump adjusts all settings automatically.



To change the time and the date:

1. From the Home screen, press , and then select .
2. Select **Device Settings > Time & Date**.
3. Select and change the **Time**, **Time Format**, or **Date** as necessary. If a 12-hour clock is being used, specify AM or PM.
4. Select **Save**.

Display options

The brightness of the pump screen can be controlled from the Display Options screen. The duration the backlight is on can also be adjusted.

To adjust the display options:

1. From the Home screen, press , and then select .
2. Select **Device Settings** > **Display**.
3. Select **Brightness** to adjust the brightness of the screen. A level from 1 to 5 can be set, or select **Auto** for the screen to automatically adjust to the current environment.
4. Select **Backlight** to adjust the timeout for the backlight on the pump screen. Select 15 seconds, 30 seconds, 1 minute, or 3 minutes.
5. Select **Save**.



Note: The brightness and backlight can affect the life of the battery. Use a lower brightness level setting, and set the backlight timeout to 15 or 30 seconds to help the battery last longer.



CAUTION: Inactivity can cause the pump screen to go dark. If **Save** is not selected after settings are entered, the pump loses the unsaved changes two minutes after the screen goes dark from inactivity.

Block mode

Block mode lets caregivers lock the pump to restrict access to critical pump features. While the pump is in Block mode, the pump automatically locks two minutes after the screen goes dark from inactivity.



WARNING: Always monitor the pump while it is locked. The pump can still be manually suspended while locked using the shortcut to the Status screen, which could result in hyperglycemia and ketoacidosis.

The following are examples of functions that are blocked while the pump is locked:



- Access the Menu screen.
- Deliver a bolus

- Start a new basal pattern
- Start a new temp basal delivery
- Change settings

The following are examples of important functions that remain available while the pump is locked:

- Previous bolus and basal deliveries continue normally
- Stop a bolus delivery using the shortcut to the Status screen
- Suspend and resume insulin delivery using the shortcut to the Status screen
- Receive sensor glucose (SG) values and blood glucose (BG) meter readings
- Clear alarms and alerts

To turn Block mode on or off:

1. From the Home screen, press , and then select .
2. Select **Device Settings** > **Block Mode**.
3. Select **Block Mode** to turn the feature on or off.
4. Select **Save**.

The pump is in Block mode, but it is not yet locked.

To lock the pump:

Press and hold  to manually enter Sleep mode.

The pump locks when it goes to sleep. While the pump is locked,  appears on the Home screen.

To unlock the pump:

1. Press any button to wake up the pump.
2. Press .

The Screen locked message appears.

3. Press and hold .



Note: When the pump goes to sleep it will lock again.

Self Test

The **Self Test** option can be used for maintenance or to confirm the pump is operating properly. Self test is additional to the routine tests that run independently while the pump operates.





Note: Insulin delivery is suspended for up to two minutes while the pump runs a self test.

The **Self Test** option includes the following tests. Observe the pump during these tests.

Test	Description
Display	The display turns on for up to 45 seconds.
Notification light	The notification light turns on for three seconds, and then it turns off.
Vibration	Two vibration tones are generated.
Tone	An alert tone, an Easy bolus step tone, and an alarm tone are generated.

To run the self test:

1. From the Home screen, press , and then select .
2. Select **Device Settings > Self Test**.

A message confirms self test is in progress.

Self test takes up to two minutes to complete. During that time, the display briefly turns white, the notification light blinks, the pump vibrates and then beeps.

If self test does not detect a problem, the Device Settings screen appears. If a problem is detected, a message appears with more information.

If an error message appears or the pump does not perform as indicated during the test, contact 24-Hour Technical Support.

Manage Settings

The Manage Settings screen includes the following options:





- **Save Settings**
- **Restore Settings**
- **Clear All Settings**
- **Clear Active Insulin**
- **Settings History**

For information on how to use these options, see the procedures in this section.

Saving the settings

The Save Settings option saves a record of the settings to restore the settings at a later date, if necessary.

To save the current settings:

1. From the Home screen, press , and then select .
2. Select **Device Settings** > **Manage Settings**.
3. Simultaneously press and hold  and  until the Manage Settings screen appears.
4. Select **Save Settings**.





If these are the first settings saved, a message confirms that the settings are saved.

If the settings have been saved previously, a screen asks to replace the previous settings with the current settings. Select **Yes** to accept. Select **No** to cancel.

Restoring the settings

The **Restore Settings** option replaces the current pump settings with the last settings that were saved. The **Restore Settings** option is available only if settings were previously saved.

To restore the previous settings:

1. From the Home screen, press , and then select .
2. Select **Device Settings** > **Manage Settings**.
3. Simultaneously press and hold  and  until the Manage Settings screen appears.
4. Select **Restore Settings**.
A screen asks to confirm.
5. Select **Yes** to accept. Select **No** to cancel.

Clearing the settings



The **Clear All Settings** option erases the current settings and returns them to the factory defaults. After the settings are cleared, the Startup Wizard appears and pump settings can be re-entered. The settings must be entered to continue using the pump.



The Clear All Settings option does not delete paired devices, such as the sensor or meter.



CAUTION: Do not clear the pump settings unless directed by a healthcare professional. If pump settings are cleared they must be re-programmed as directed by a healthcare professional.

To clear all settings:

1. Disconnect the pump from the body.
2. From the Home screen, press , and then select .
3. Select **Device Settings** > **Manage Settings**.

4. Simultaneously press and hold  and  until the Manage Settings screen appears.
5. Select **Clear All Settings**.
A screen asks to confirm.
6. Select **Yes** to continue. Select **No** to cancel.
After the settings are cleared, the Startup Wizard appears. For more details on entering the startup settings, see *Startup settings*, page 74.





Clearing the active insulin

Use the **Clear Active Insulin** option to use the pump with insulin for the first time. This option clears the TDD and any active insulin values that the pump has tracked.

After the existing insulin values are cleared, it sets the active insulin value to zero. If bolus delivery was practiced with the pump prior to using the pump with insulin, the active insulin must be cleared. Clearing active insulin confirms that the Bolus Wizard feature has an accurate active insulin amount for bolus calculations.

Active insulin can be cleared only once. After the active insulin is cleared, this option is no longer available.

To clear the active insulin:

1. From the Home screen, press , and then select .
2. Select **Device Settings > Manage Settings**.
3. Simultaneously press and hold  and  until the Manage Settings screen appears.
The Manage Settings screen appears. If the active insulin has never been cleared, the **Clear Active Insulin** option appears.

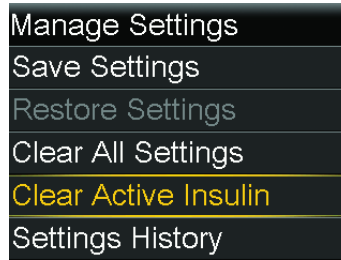





Note: If the **Clear Active Insulin** option does not appear on the Manage Settings screen, the active insulin has already been cleared.

4. Select **Clear Active Insulin**.
A screen asks to confirm.
5. To clear the active insulin, select **Clear**. If the active insulin should not be cleared, select **Cancel**.
A message confirms that the active insulin is cleared.

Viewing the pump setting history

The **Settings History** option shows a history of activities performed through the Manage Settings screen, such as when pump settings were saved, restored, or cleared.

To view the pump setting history:



1. From the Home screen, press , and then select .
2. Select **Device Settings** > **Manage Settings**.
3. Simultaneously press and hold  and  until the Manage Settings screen appears.
4. Select **Settings History**.

Auto suspend

Auto suspend is a safety feature that stops all insulin delivery and sounds an alarm if a button is not pressed within a specified period of time. Consult a healthcare professional about how to best use this feature.

Auto suspend continues to work if the SmartGuard feature is active.



To set up auto suspend:

1. From the Home screen, press , and then select .
2. Select **Device Settings** > **Auto Suspend**.
3. Select **Alarm**.
4. Select **Time** and enter the number of hours.
5. Select **Save**.

Language

The language that the pump uses to show information can be updated after the startup.

To change the language:

1. From the Home screen, press , and then select .
A checkmark indicates which language is active.
2. Select **Device Settings** > **Language**.
3. Select a language.
A screen asks to confirm.
4. Select **Yes** to accept. Select **No** to cancel.

10

History and graph

10

History and graph

This chapter provides information about how to read historical data in the MiniMed 780G system.

Introduction

The History screens provide details about personal therapy history in the MiniMed 780G insulin pump. The SG Review and Graph screens are available if the Sensor feature is turned on. The Time in Range screen shows the percent of time glucose levels are between 70 mg/dL and 180 mg/dL.

History & Graph menu



The History & Graph menu provides information about insulin delivery, blood glucose (BG) meter readings, sensor glucose (SG) values, paired sensors, and any alarms and alerts received.

History

Summary screen

The Summary screen displays information about past insulin deliveries, SG readings, and meter readings. Historical details can be viewed for a single day or for multiple days.

To view the Summary screen:

1. From the Home screen, press , and then select .
2. Select **History** > **Summary**.

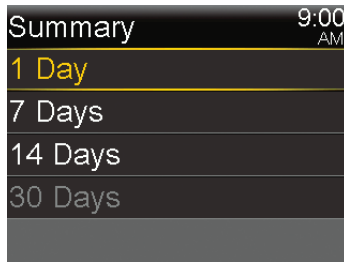

3. Select the desired time period for the Summary screen.

The Summary screen appears and displays information for the number of days selected.



4. Scroll down to view the entire screen. In the **1 Day** view, use the < and > buttons on the pump to view the history of a specific day.

Understanding the Summary screen

The Summary screen separates information into the following categories:

- Time in range information
- Insulin delivery overview
- Bolus Wizard
- Bolus in the SmartGuard feature
- BG
- Sensor
- Low management mode

Summary screen: Time in SmartGuard and Time in range information

The following table describes the Time in SmartGuard, Time in Target Range, Time below range, and Time above range portions of the Summary screen.

Name	Description
Time in SmartGuard	number of hours / percent of time in the SmartGuard feature
Time in Target Range	number of hours / percent of time in target range (70 mg/dL to 180 mg/dL)
Time below range	number of hours / percent of time below target range (below 70 mg/dL)
Time above range	number of hours / percent of time above target range (above 180 mg/dL)

Summary screen: insulin delivery overview

If **1 Day** view is selected, the values are shown for that day. If multiple days are selected, the values shown are an average of the values for the selected number of days.

Name	Description
TDD	Total daily dose of insulin units.
Basal	<ul style="list-style-type: none"> Insulin units devoted to basal delivery. Percentage of insulin devoted to basal delivery.
Bolus	<ul style="list-style-type: none"> Insulin units devoted to bolus delivery. Percentage of insulin devoted to bolus delivery.
Total Carbs	Daily carbohydrate amount, in grams.

Summary screen: Bolus Wizard

If **1 Day** view is selected, the values are shown for that day. If multiple days are selected, the values shown are an average of the values for the selected number of days.

Name	Description
Carb bolus	<ul style="list-style-type: none"> Total insulin units delivered using the Bolus Wizard feature with food amount or with food and glucose correction. Number of times the Bolus Wizard feature delivered a food bolus or a food plus correction bolus.

Name	Description
Glucose correction only	<ul style="list-style-type: none"> Total insulin units delivered using the Bolus Wizard feature or a bolus with BG correction amount only. Number of times the Bolus Wizard feature delivered a correction bolus.

Summary screen: SmartGuard

If **1 Day** view is selected, the values are shown for that day. If multiple days are selected, the values shown are an average of the values for the selected number of days.

Name	Description
Auto Correction	Total insulin units delivered by the Auto correction feature.
Bolus	<ul style="list-style-type: none"> Total insulin units delivered using the SmartGuard bolus feature. Number of times the SmartGuard bolus feature was used.

Summary screen: BG

The pump is only compatible with the Accu-Chek™* Guide Link meter.

Name	Description
BG	Total number of BG meter readings, including readings from an Accu-Chek™* Guide Link meter and BG meter readings entered manually.
Average BG	Average BG meter readings.
BG Std. Dev.	Standard deviation of BG meter readings.
Low BG	Lowest BG meter reading.
High BG	Highest BG meter reading.

Summary screen: sensor

The sensor portion appears if a sensor has been used at least once.

Name	Description
SG Average	Average SG reading.

Name	Description
SG Std. Dev.	Standard deviation of the SG readings.

Summary screen: low management mode

For information about the Suspend before low and Suspend on low features, see *Low SG settings, page 154*.



Name	Description
Suspend before low	The average number of Suspend before low events per day.
Suspend on low	The average number of Suspend on low events per day.
Time suspended by sensor	The average duration (amount of time) suspended as a result of Suspend before low or Suspend on low events per day.

Daily History screen

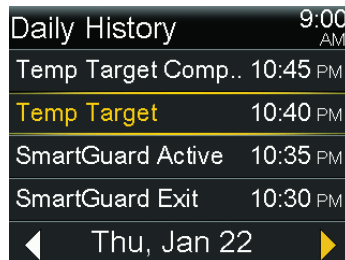
Actions performed on the pump can be viewed on the Daily History screen for the selected day. The list shown on the screen provides further details and shows the most recent action first.



To view the Daily History screen:



1. From the Home screen, press , and then select .
2. Select **History** > **Daily History**.
A list of dates appears.

3. Select a specific date. A list appears with any pump actions or events entered on the specified day.
4. Select any item in the list to open the Detail screen and view more information about the selected action or event.

Alarm History screen

Select a specific day to view the history of alarms and alerts that occurred on the selected day. The list provides further details and shows the most recent alarm or alert first.

To view the Alarm History screen:



1. From the Home screen, press , and then select .
2. Select **History > Alarm History**.
A list of dates appears.
3. Select a specific date. A list appears showing any alarms or alerts that occurred on the specified day.
4. Select any alarm or alert in the list to open the Detail screen and view more information about the selected alarm or alert.

Paired Sensors screen

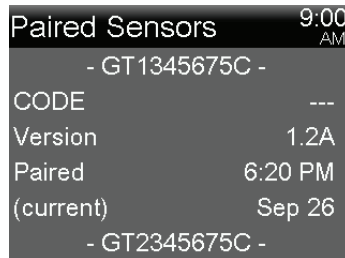
The Paired Sensors screen displays the serial number, date, and time of the current transmitter paired to the pump. The screen also provides a history of the transmitters that were paired with and unpaired from the pump. The code is not applicable for the MiniMed 780G insulin pump with the Guardian 4 sensor.



To view the Paired Sensors screen:

1. From the Home screen, press , and then select .
2. Select **History > Paired Sensors**.
A list of transmitters appears.
3. Scroll down to view the entire screen.

SG Review screen

Pair the pump with a sensor to view a graph of SG history based on high and low limits entered. Information can be viewed for one day or refer to an average of SG data over multiple days.

High and low limits set in the SG Review screen are only used to view SG data. These limits are not the same as the high and low glucose limits used for SG alerts. Changing the limits in the SG Review screen will not affect the high and low glucose limits used for the SG alerts.

To review the SG history:

1. From the Home screen, press , and then select .
2. Select **Sensor Glucose Review**.

The SG Review screen appears. The high and low limits that appear are either the values entered for the last SG Review, or the default values of 180 mg/dL for the high limit and 70 mg/dL for the low limit.

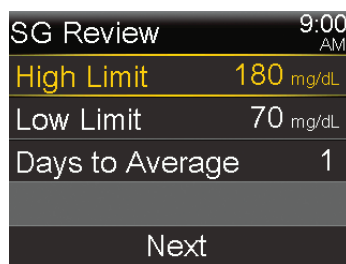

3. Enter the High Limit and Low Limit for the SG data review.

There must be a minimum of 20 mg/dL difference between the High Limit and the Low Limit.

4. Enter the number of days of SG history to average, and select **Next**.

If only one day is entered, the graph shows details about when the SG was above, below, or within the specified limits. Use the arrow keys to see the data for specific dates. Press ∇ to see information about the time that SG was above, within, or below range. A message appears and states there is no data available if no data was saved.

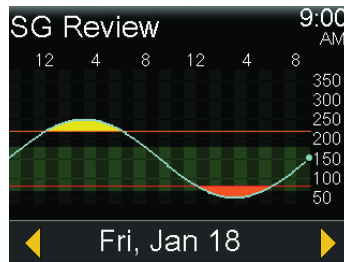

If multiple days are entered, the pie chart shows the average percentage of time that the SG was above, below, or within the specific limits over an average of multiple days. A message appears and states there is no data available if no data was saved.

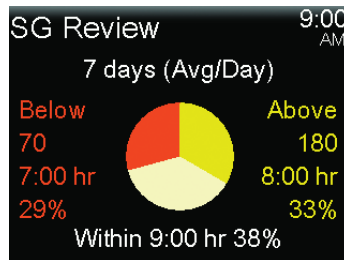

Graph screen

The graph shows information about the SG readings and trends, BG entries, auto correction bolus deliveries, and bolus entries. The below screen is an example of the graph screen using the SmartGuard feature.

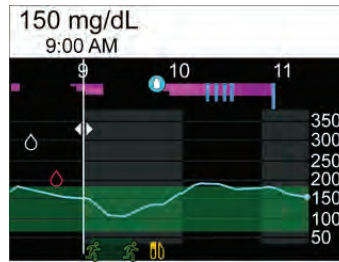

To view the Graph screen:

- Press , or select **Graph** on the History & Graph screen.



Time in Range screen

Time in range is the percentage of time SG is between 70 mg/dL and 180 mg/dL. These values cannot be changed. Use the Time in Range screen to see how much time is spent below, above, and within range in the last 24 hours.

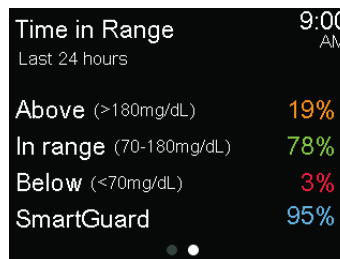
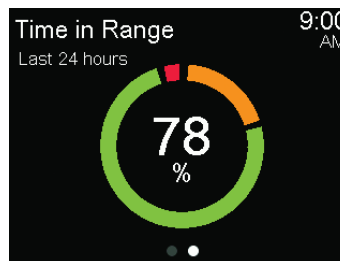
When using CGM, the following information can be viewed:



To view the Time in Range screen:

1. From the Home screen, press , and then select .
2. Select **Time in Range**.

11



Notifications and reminders

11

Notifications and reminders

This chapter describes how to use reminders. It also covers the general behavior of the most common and the most serious notifications and how to resolve them.

Notifications in the MiniMed Mobile app

If the MiniMed Mobile app is used, alarms, alerts, and messages can be viewed on the paired mobile device. For information about how to set the notification preferences in the app, see the MiniMed Mobile app user guide. For a table that describes the meaning, consequences, reasons, and resolutions for the most common or serious notifications, see *Pump alarms, alerts, and messages, page 295*.



WARNING: Do not rely on the MiniMed Mobile app to view all alerts. Alerts will not appear on the MiniMed Mobile app during reservoir set up. Some alerts may only appear on the pump. In some cases, alerts could be sent to the MiniMed Mobile app after they appear on the pump. Relying on the MiniMed Mobile app for all alerts could result in an alert being missed, which may lead to hypoglycemia or hyperglycemia.



Reminders

There are several specific reminders that prompt a specific action. Personal reminders can be used for any purpose.

Personal reminders

Up to six personal reminders can be set, along with the specific reminders for blood glucose (BG) meter readings and medication.

To create a new Personal reminder:



1. From the Home screen, press , and then select .
2. Select **Alert Settings > Reminders > Personal**.
3. Select **Add New**.

The Select Name screen shows the available reminders.

4. Select a reminder.
An edit screen appears for the selected reminder.
5. Enter the time the reminder should occur.
6. Select **Save**.

The Personal reminder occurs at the specified time each day unless it is edited or deleted.



To edit, rename, or delete an existing Personal reminder:

1. From the Home screen, press , and then select .
2. Select **Alert Settings > Reminders > Personal**.
3. Select a reminder.
4. Do any of the following:
 - Select **Reminder** to turn the reminder on or off.
 - Select **Edit** to change the time of the reminder.
 - Select **Rename** to assign a different name to the reminder. When the Select Name screen appears, select any available name from the list.
 - Select **Delete** to delete the reminder.

Bolus BG Check reminder

The Bolus BG Check reminder notifies when BG needs to be checked after a bolus delivery. After a bolus is started, the BG Check screen appears and the timer must be set for the reminder. The timer counts down from the time the bolus was started.

To turn on or turn off Bolus BG Check reminders:

1. From the Home screen, press , and then select .
2. Select **Alert Settings** > **Reminders** > **Bolus BG Check**.
3. To turn the reminder on or off, select **Reminder**.
4. Select **Save**.

To use a Bolus BG Check reminder if a bolus is being delivered:

1. If the Bolus BG Check reminder is on, the BG Check screen appears each time a bolus is started.

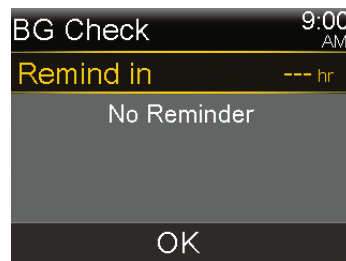



2. Enter a time between 30 minutes and 5 hours and select **OK**. If no reminder is necessary after the bolus delivery, select the dashes without adding a time, and select **OK**.



Missed Meal Bolus reminder

Missed Meal Bolus reminders can be set up around typical meal times. Up to 8 reminders can be set.

To create a new Missed Meal Bolus reminder:

1. From the Home screen, press , and then select .
2. Select **Alert Settings** > **Reminders** > **Missed Meal Bolus**.
3. Select **Add New**.
4. Select **Start Time** and enter a time.
5. Select **End Time** and enter a time.
6. Select **Save**.

To turn on or off, edit, or delete existing Missed Meal Bolus reminders:

1. From the Home screen, press , and then select .
2. Select **Alert Settings** > **Reminders** > **Missed Meal Bolus**.
3. Select a reminder.
4. Change any of the following:
 - Select **Reminder** to turn this reminder on or off.
 - Select **Edit** to change the time of this reminder.
 - Select **Delete** to delete this reminder.

Low Reservoir reminder

Set a Low Reservoir reminder to occur when the insulin level in the reservoir reaches a specified number of units and again when half of those units have been used.





Note: The number of units that remain in the reservoir can be found on the Pump status screen. For more information, see *Status screen*, page 82.



WARNING: Always check the amount of insulin left in the reservoir when the Low reservoir alert occurs. Confirm that the MiniMed 780G insulin pump has sufficient insulin. The insulin level in the reservoir can reach a low level during a bolus delivery or fill cannula delivery. If this occurs, the Low reservoir alert displays. If the pump does not have sufficient insulin, under-delivery of insulin can occur, which may cause hyperglycemia.



To set up the Low Reservoir reminder:

1. From the Home screen, press , and then select .
2. Select **Alert Settings** > **Reminders** > **Low Reservoir**.
3. Select **Units** to enter the number of units. Set a value from 5 to 50 units.
4. Select **Save**.

Set Change reminder

The Set Change reminder tracks the time between infusion set changes and provides a reminder to change the infusion set.

To turn on or off, or edit the Set Change reminder:

1. From the Home screen, press , and then select .
2. Select **Alert Settings** > **Reminders** > **Set Change**.
3. Select **Reminder** to turn the reminder on or off.
4. Select **Time** and choose the number of days needed for the reminder.
5. Select **Save**.





WARNING: When changing the Set Change reminder, do not set a duration greater than what is indicated on the infusion set labeling. If the infusion set is labeled for three days then the reminder must only be set to two or three days.

Calibration reminder

This feature appears on the pump screen but cannot be selected. This feature is not applicable when using the Guardian 4 sensor. When using the Guardian 4 sensor, there will be no reminders if the Calibration reminder is turned on.

Alarms, alerts, and messages

The pump has a sophisticated safety network. If this safety network detects anything unusual, it communicates this information in the form of notifications. Notifications include alarms, alerts, and messages. When more than one notification is received, and there are multiple messages to view, a small white flap appears on the notification icon in the upper-right corner of the screen . When the first notification is cleared, the next notification becomes visible. A white triangle in the lower right corner means that  must be pressed to continue.



Note: The notification light flashes when the pump has an alarm or alert.



Note: Promptly address all notifications and confirmations that appear on the pump screen. The notification will remain on the pump screen until it is cleared. When responding to a message, there may be times when another message appears.



WARNING: When a Critical pump error alarm occurs, the following screen appears and the pump siren goes off:



Immediately disconnect the pump and discontinue use. Contact 24-Hour Technical Support.

Insulin delivery is still required when the pump is removed. Consult a healthcare professional to determine an alternate method of insulin delivery while the pump is removed.

Alarms

An alarm warns of a condition that requires immediate attention. Stopped insulin delivery and low glucose levels are the most common reasons for alarms.

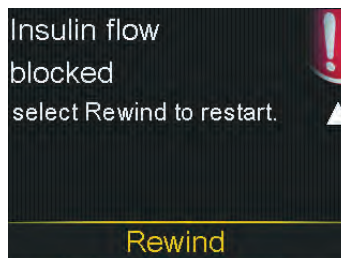
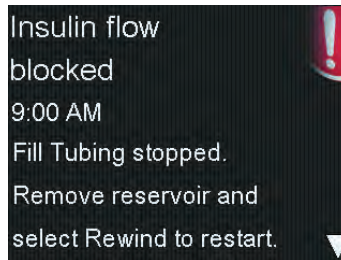



WARNING: Always address alarms immediately when they occur. Ignoring an alarm can result in hyperglycemia or hypoglycemia.

When an alarm occurs:

Display: The pump displays a notification with a red icon and instructions.

Notification light: The red notification light blinks twice, followed by a pause, in a continuous repeating pattern.

Audio: Depending on the sound and vibration settings, the pump emits a series of alarm tones and vibrations.

The underlying problem that triggered the alarm must be resolved. In most cases, press  and then make a selection to clear the alarm. Sometimes the underlying problem is not resolved when the alarm is cleared. The alarm repeats until the underlying problem is fixed. If the alarm condition is not resolved after 10 minutes, the alarm tone escalates to a loud emergency siren.

Alerts

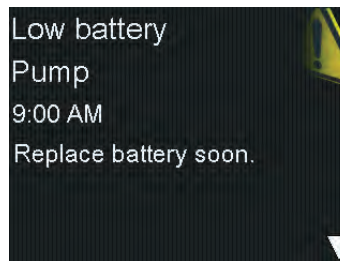

Alerts indicate that a situation may require attention. When an alert occurs, check the pump screen to see if any action is required.

When an alert occurs:

Display: The pump displays a notification with a yellow icon and instructions.

Notification light: The red notification light on the pump blinks once, followed by a pause, then blinks once again in a continuous repeating pattern.

Audio: Depending on the sound and vibration settings, the pump generates a series of tones and vibrations.

To clear an alert, press  and then make a selection. The pump beeps every 5 minutes or every 15 minutes, depending on the alert, until the alert is resolved. Some alerts will also escalate to a loud emergency siren after 10 minutes.



Note: If an alert occurs when the pump is on a screen other than the Home screen, the alert message may only appear after the pump returns to the Home screen.

Messages

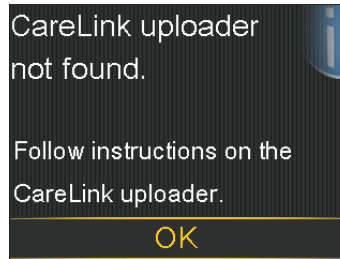

A message is a notification that shows the status of the pump or displays when a decision needs to be made.

When a message occurs:

Display: The pump displays a notification with a blue icon and instructions. Some messages show a yellow icon.

Notification light: The red notification light on the pump does not blink.

Audio: Depending on the sound and vibration settings, the pump emits a tone, a one-pulse-only vibration, or it emits a tone and a one-pulse-only vibration. To clear a message, press  and then make a selection.

Pump alarms, alerts, and messages

For a table that describes the meaning, consequences, reasons, and resolutions for the most common or serious notifications, see *Pump alarms, alerts, and messages*, page 295.



12



Additional basal features

12



Additional basal features

This chapter provides information about setting up additional features for basal insulin delivery.

Preset temp basal rates

Set up preset temp basal rates for reoccurring short-term situations. Up to four preset temp basal rates can be set up for specific situations. There are also four additional preset temp rates available for use in other circumstances (Temp 1 through Temp 4).

To set up a preset temp basal rate:

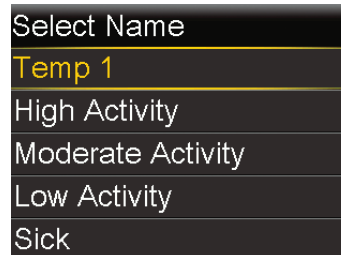

1. From the Home screen, press , and then select .
2. Select **Delivery Settings** > **Preset Temp Setup**.
3. Select **Add New**.



4. Select a name for the preset temp basal rate.
5. Select **Type** to select Percent or Rate, and then enter the percentage or the rate in units per hour.

6. Set the **Duration** for the preset temp basal rate to be active.
7. Select **Save**.

To edit, rename, or delete a preset temp basal rate:

1. From the Home screen, press , and then select .
2. Select **Delivery Settings > Preset Temp Setup**.

The Preset Temp Setup screen appears and shows the settings for any existing preset temp basal rate.



3. Select a preset temp basal rate.

A screen appears that shows the preset temp basal rate information.

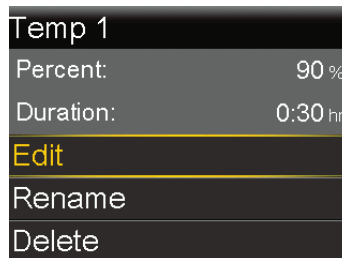

4. Do any of the following:
 - Select **Edit** to adjust the type (Percent or Rate), the percent or rate amount, and the duration.
 - Select **Rename** to assign a different name to the preset temp basal rate. When the Select Name screen appears, select any available name from the list.
 - Select **Delete** to delete the preset temp basal rate.

Starting a preset temp basal delivery

Follow the steps to use the preset temp basal rate for basal insulin delivery. If a preset temp basal rate has not yet been set up, see *Preset temp basal rates, page 239*. After the preset temp basal delivery is completed or canceled, basal insulin delivery resumes using the programmed basal rate.

To start a preset temp basal delivery:

1. From the Home screen, press , and then select .
2. Select **Basal > Preset Temp**.

The Preset Temp screen appears and shows the preset temp basal rates set up, along with their percentage or rate amounts.

Preset Temp	9:00 AM
Current rate:	0.025 U/hr
Temp 1	0.100 U/hr
High Activity	25 %
Moderate...	50 %



Note: If a percentage preset temp basal rate is set up so that it could exceed the current Max basal limit, that rate is grayed out in the list and cannot be selected.

3. Select a preset temp basal rate to start.
4. Select **Begin**.



The Temp Basal banner appears on the Home screen during delivery.



Canceling a temp basal or preset temp basal

A temp basal rate or preset temp basal rate can be canceled at any time. After it is canceled, the scheduled basal pattern automatically resumes.

To cancel a temp basal rate:

1. From the Home screen, press , and then select .
2. Select **Cancel Temp Basal**.
The Temp Basal screen appears.



3. Select **Cancel Temp Basal**.

Additional basal patterns



Adding an additional basal pattern

This procedure shows how to add a new basal pattern after at least one basal pattern has been set. If this is the first time a basal pattern is being set, see *Setting up a basal pattern*, page 90.

The following basal patterns can be set up:



- Basal 1
- Basal 2
- Workday
- Day Off
- Sick Day

To add an additional basal pattern:

1. From the Home screen, press , and then select .
2. Select **Basal > Basal Pattern Setup**.
The Basal Pattern Setup screen appears.
3. To add a new basal pattern, select **Add New**.
The Select Name screen appears.
4. Select a name for the basal pattern.
5. Set the basal rate.
6. Select **Review**.
7. Select **Save**.

Editing, copying, or deleting a basal pattern

To edit, copy, or delete a basal pattern:

1. From the Home screen, press , and then select .
2. Select **Delivery Settings > Basal Pattern Setup**.
The Basal Pattern Setup screen appears



3. Select a basal pattern.
4. Select **Options**.
5. Do any of the following:
 - Select **Edit** to adjust the end time or rate values.
 - Select **Copy** to copy the basal rate information from the selected basal pattern to a new basal pattern. When the Select Name screen appears, select any available name from the list.
 - Select **Delete** to delete the selected basal pattern. The active basal pattern cannot be deleted.

Changing from one basal pattern to another

If more than one basal pattern has been set, the basal pattern can be changed. The MiniMed 780G insulin pump delivers basal insulin according to the selected basal pattern.

To change to a different basal pattern:

1. From the Home screen, press , and then select .
2. Select **Basal > Basal Patterns**.

The Basal Patterns screen appears. A check mark displays next to the active basal pattern.

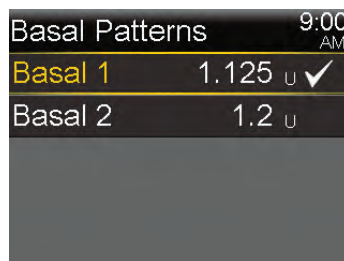

3. Select a basal pattern.

Basal 2		9:00 AM
24 hr Total: 1.2 U		
Start	End	Rate (U/hr)
12:00 _A	12:00 _A	0.050
Begin		

4. Select **Begin**.



13



Additional bolus features

13

Additional bolus features

This chapter provides information about additional features for bolus delivery. Square Wave, Dual Wave, Easy, Manual, and Preset bolus are only available in Manual mode. Since these bolus types are only available in Manual mode, remember that you must enter a blood glucose (BG) meter reading when setting up the bolus delivery. Do not use a sensor glucose (SG) value when delivering a bolus in Manual mode.

Bolus types

The following table provides general information about the available bolus types.

Bolus type	Description	Purpose
Normal	Normal bolus provides a single immediate dose of insulin.	This is the typical bolus type used to cover food intake or to correct a high blood glucose (BG) meter reading. For details about delivering a normal bolus, see <i>Normal bolus, page 109</i> .
Square Wave bolus	Square Wave bolus delivers a single bolus evenly over an extended period of time from 30 minutes up to 8 hours.	A Square Wave bolus can be used for the following reasons: <ul style="list-style-type: none"> • A delayed food digestion due to gastroparesis or meals high in fat. • Snacking over an extended period of time. • A normal bolus drops the BG too rapidly.

Bolus type	Description	Purpose
		For details about using the Square Wave bolus feature, see <i>Square Wave bolus</i> , page 255.
Dual Wave bolus	Dual Wave bolus delivers a combination of an immediate normal bolus followed by a Square Wave bolus.	<p>A Dual Wave bolus can be used for the following reasons:</p> <ul style="list-style-type: none"> • When meals are high in carbs and fat, which may delay digestion. • When a meal bolus is combined with a correction bolus for an elevated BG. <p>For details about using a Dual Wave bolus, see <i>Dual Wave bolus</i>, page 259.</p>

Bolus type example

The following example shows how the different bolus types work.

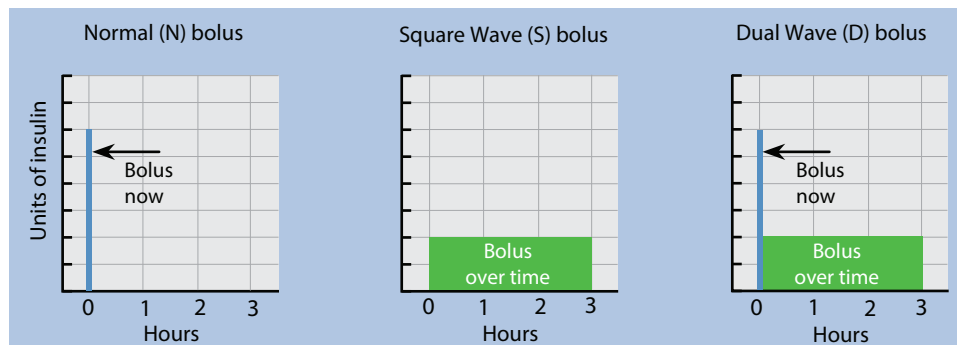

Bolus settings



Additional settings are required to use the Bolus Wizard feature. These are described in the section, *Bolus delivery options*, page 101.

Bolus increment

The Bolus increment is the number of units that are increased or decreased with each button press for the bolus delivery amount in the Bolus Wizard, Manual Bolus, and

Preset Bolus screens. Depending on the typical bolus amount, the increment can be set to 0.1 units, 0.05 units, or 0.025 units.

To set the bolus increment:

1. From the Home screen, press , and then select .
2. Select **Delivery Settings** > **Bolus Increment**.
3. Select **Increment** to set the desired increment value.

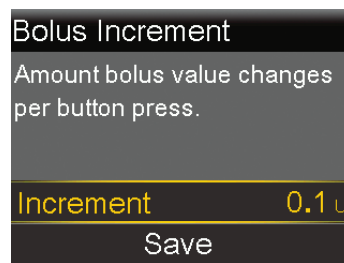



4. Select **Save**.

Bolus speed

The bolus speed sets the rate at which the pump delivers bolus insulin. Set a standard rate (1.5 units per minute), or a quick rate (15 units per minute).

To set the bolus speed:

1. From the Home screen, press , and then select .
2. Select **Delivery Settings** > **Bolus Speed**.
3. Select **Standard** or **Quick**.



4. Select **Save**.



Changing the Bolus Wizard settings

This section shows how to make changes to personal settings after the initial Bolus Wizard feature setup. Consult a healthcare professional before changes are made to the personal settings.

Changing the carb ratio

The carb ratio can be set whether or not the Bolus Wizard feature is turned on.

To change the carb ratio:

1. From the Home screen, press , and then select .
2. Select **Delivery Settings > Bolus Wizard Setup > Carb Ratio**.
3. Select **Edit**.
4. Select the carb ratio. For one carb ratio, enter the g/U, and then press .

For more than one carb ratio, enter one carb ratio at a time to complete the full 24 hours, which ends at 12:00 A.







Note: For instructions on setting up more than one carb ratio over a 24-hour period, see *Settings covering a 24-hour period*, page 91.



5. Select **Save**.

Changing the insulin sensitivity factor

The insulin sensitivity factor can be set only if the Bolus Wizard feature is turned on.

To change the insulin sensitivity factor:

1. From the Home screen, press , and then select .
2. Select **Delivery Settings** > **Bolus Wizard Setup** > **Insulin Sensitivity Factor**.
3. Select **Edit**.
4. Select the insulin sensitivity factor. For one insulin sensitivity factor, press  and  to enter the mg/dL per U, and then press .

For more than one insulin sensitivity factor, press  or  to enter one insulin sensitivity factor at a time to complete the full 24 hours, which ends at 12:00 A.





Note: For instructions on setting up more than one insulin sensitivity factor over a 24-hour period, see *Settings covering a 24-hour period, page 91*.

5. Select **Save**.

Changing the BG target

The BG target can be from 60 to 250 mg/dL. The BG target can be set only if the Bolus Wizard feature is turned on.

To change the BG target:

1. From the Home screen, press , and then select .
2. Select **Delivery Settings** > **Bolus Wizard Setup** > **BG Target**.
3. Select **Edit**.
4. Select the BG target. For one BG target, enter the low BG limit and the high BG limit, and then press .

For more than one BG target, enter one BG target at a time to complete the full 24 hours, which ends at 12:00 A.



Note: For instructions on setting up more than one BG target over a 24-hour period, see *Settings covering a 24-hour period*, page 91.



5. Select **Save**.

Changing the active insulin time

Active insulin is the bolus insulin that has been delivered by the pump and is still working to lower glucose levels. In the Bolus Wizard and SmartGuard Bolus feature, the Active Insulin Time setting is used to calculate a correction bolus by subtracting the estimated active insulin from each bolus. In SmartGuard, auto correction boluses are delivered up to every 5 minutes. A shorter Active Insulin Time setting may result in more insulin being delivered in correction boluses.

A healthcare professional provides the personalized active insulin time based on historic glycemic control data for the individual user. When using SmartGuard, the recommended initial setting is an Active Insulin Time of 2-3 hours. The Active Insulin Time setting in the MiniMed 780G system is not necessarily reflective of the physiological insulin metabolism. Adjustments are not based on the pharmacokinetics and pharmacodynamics of the rapid-acting insulin. Please see *Table 8, page 363* and *Table 9, page 364* in *Performance data, page 355* for the effect of Active Insulin Time on glycemic outcomes. The current active insulin amount appears on the Home screen and includes only the bolus insulin received.

To change the active insulin time:

1. From the Home screen, press , and then select .
2. Select **Delivery Settings > Bolus Wizard Setup > Active Insulin Time**.
3. Select **Duration**, and adjust the active insulin time in hours, using 15-minute increments.

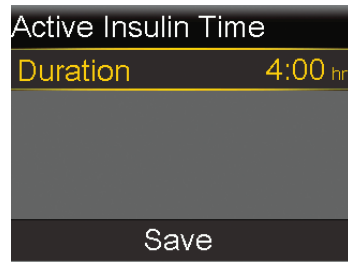

4. Select **Save**.

Square Wave bolus

A Square Wave bolus delivers a bolus evenly over a period of time from 30 minutes up to 8 hours.

When using the Bolus Wizard feature, a Square Wave bolus is available only when giving a food bolus without a correction for an elevated BG. A Square Wave bolus is not available for a correction bolus alone or a correction bolus with food bolus. A normal bolus can be delivered while a Square Wave bolus is being delivered, as needed.

A Square Wave bolus can be useful in the following situations:



- Delayed food digestion due to gastroparesis or meals high in fat.
- When snacking over an extended period of time.
- A normal bolus drops BG too rapidly.

Since the Square Wave bolus extends delivery over a period of time, the insulin is more likely to be available as needed.

Turning the Square Wave bolus feature on or off

A Square Wave bolus can be set up and delivered only after the Square Wave bolus feature is turned on.

To turn the Square Wave bolus feature on or off:



1. From the Home screen, press , and then select .
2. Select **Delivery Settings > Dual/Square Wave**.

3. Select **Square Wave** to turn the feature on or off.
4. Select **Save**.

Delivering a Square Wave bolus using the Bolus Wizard feature

The Bolus Wizard feature only delivers a Square Wave bolus if the Square Wave bolus feature is turned on and a carb value is entered. If a BG reading causes the Bolus Wizard feature to calculate that a correction bolus is necessary, then a Square Wave bolus cannot be delivered.

To deliver a Square Wave bolus using the Bolus Wizard feature:

1. From the Home screen, press , and then select .
2. Select **Bolus > Bolus Wizard**.

The Bolus Wizard screen appears.



3. For a food bolus, select **Carbs** to enter the carb count of the meal.
4. The calculated bolus appears in the Bolus field. To modify the bolus amount, select **Bolus**.
5. Select **Next** to review the bolus information.

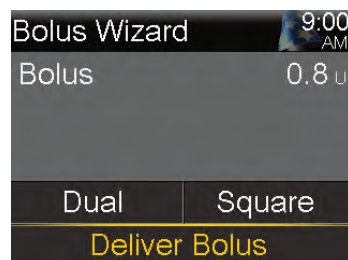

6. Select **Square**.
7. Select **Duration** to adjust the time period when the Square Wave bolus needs to be delivered.



8. Select **Deliver Bolus** to start the bolus.

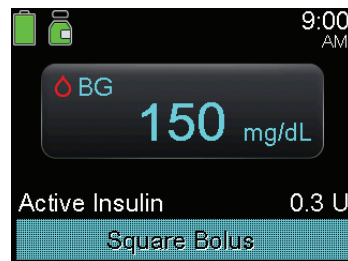



Note: To stop bolus delivery or to see details on the insulin that has been delivered, see *Stopping a Square Wave or Dual Wave bolus delivery*, page 270.

Delivering a Square Wave bolus using the Manual bolus feature

The Square Wave bolus option is available in the Manual Bolus screen only after the Square Wave feature is turned on.

To deliver a Square Wave bolus using the Manual bolus feature:

1. From the Home screen, press , and then select .
2. Do one of the following:

- Select **Bolus** if the Bolus Wizard feature is turned off.
- Select **Bolus > Manual Bolus** if the Bolus Wizard feature is turned on.

The Manual Bolus screen appears.

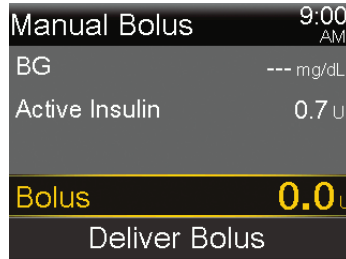

3. Set the bolus delivery amount in units, and then select **Next**.

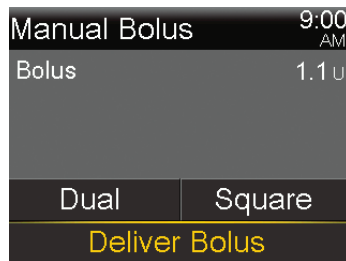

4. Select **Square**.
5. Select **Duration** to adjust the time period when the Square Wave bolus is to be delivered.
6. Select **Deliver Bolus** to start the bolus.

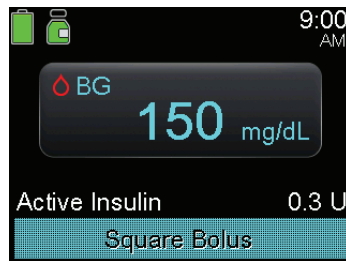



Note: To stop bolus delivery or to see details on the insulin that has been delivered, see *Stopping a Square Wave or Dual Wave bolus delivery*, page 270.

Dual Wave bolus

The Dual Wave bolus feature meets both immediate and extended insulin needs by delivering a combination of an immediate normal bolus followed by a Square Wave bolus. A normal bolus can be delivered while the Square portion of a Dual Wave bolus is being delivered, as needed.



A Dual Wave bolus can be useful in these situations:

- When an elevated BG needs to be corrected before a meal, and a delayed bolus is needed for food that is absorbed slowly.
- When eating meals with mixed nutrients, such as carbs, fats and proteins, that are absorbed at different rates.

Turning the Dual Wave bolus feature on or off

A Dual Wave bolus can be delivered only after the Dual Wave bolus feature is turned on.



To turn the Dual Wave feature on or off:

1. From the Home screen, press , and then select .
2. Select **Delivery Settings** > **Dual/Square Wave**.
3. Select **Dual Wave** to turn the feature on or off.
4. Select **Save**.

Delivering a Dual Wave bolus using the Bolus Wizard feature

A Dual Wave bolus with the Bolus Wizard feature can be delivered only after the Dual Wave bolus feature is turned on.

To deliver a Dual Wave bolus with the Bolus Wizard feature:

1. For a correction bolus or a food bolus with a correction, use a BG meter to check BG. For a food bolus only, go to step 2.
2. From the Home screen, press , and then select .
3. Select **Bolus** > **Bolus Wizard**.

The Bolus Wizard screen appears.



Note: For more information on how to manually enter the BG meter reading, see *Entering a blood glucose (BG) meter reading*, page 100.

4. For a food bolus, select **Carbs** to enter the carb count of the meal. For a correction bolus where no food was eaten, leave the carbs value as 0.

The calculated bolus appears in the Bolus field.

5. To modify the bolus amount, select **Bolus**.
6. Select **Next** to review the bolus information.

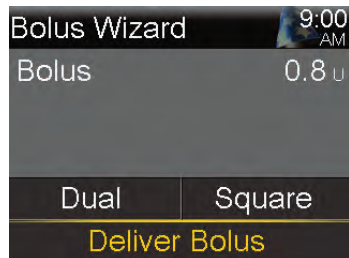

7. Select **Dual**.

The Bolus Wizard screen appears.

- To change the amounts, select the area of the screen with the Now % and Square % values and adjust the **Now** % amount.

When adjusting the Now amount, the Square amount adjusts automatically.

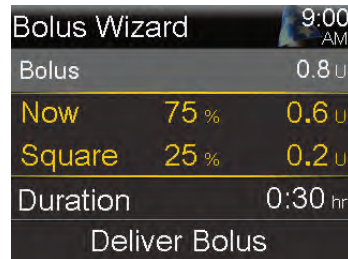

- Adjust the **Duration** of the square portion of the bolus to be delivered.
- Select **Deliver Bolus** to start the bolus.

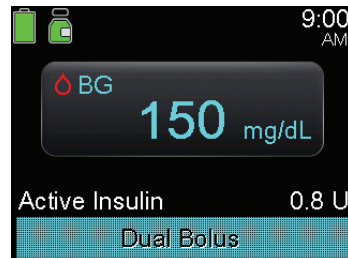

Note: To stop bolus delivery or to see details on the insulin that has been delivered, see *Stopping a Square Wave or Dual Wave bolus delivery*, page 270.

Delivering a Dual Wave bolus using the Manual bolus feature

The Dual Wave bolus option is available in the Manual Bolus screen only after the Dual Wave feature is turned on.

To deliver a Dual Wave bolus using the Manual bolus feature:

- From the Home screen, press , and then select .

2. Do one of the following:
 - Select **Bolus** if the Bolus Wizard feature is turned off.
 - Select **Bolus > Manual Bolus** if the Bolus Wizard feature is turned on.

The Manual Bolus screen appears.

3. Set the bolus delivery amount in units, and then select **Next**.

The Manual Bolus screen appears, with the option to select the bolus type.

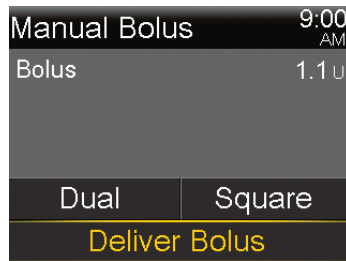

4. Select **Dual**.
The Manual Bolus screen appears.
5. To change the amounts, select the area of the screen with the Now % and Square % values and adjust the **Now** % value. When the Now amount is adjusted, the Square amount adjusts automatically.

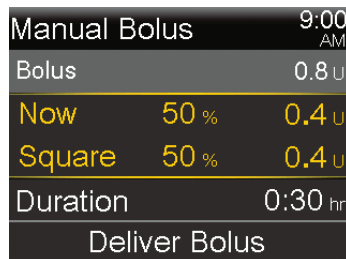

6. Select **Duration** to adjust the time period when the Square Wave bolus is to be delivered.
7. Select **Deliver Bolus** to start the bolus.

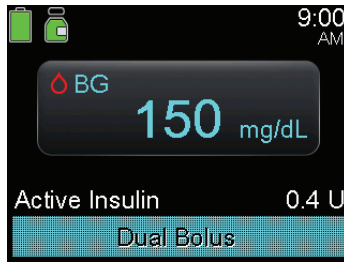

Note: To stop bolus delivery or to see details on the insulin that has been delivered, see *Stopping a Square Wave or Dual Wave bolus delivery*, page 270.

Easy bolus

The Easy bolus feature can be used to deliver a normal bolus using only the \wedge button. The Easy bolus feature only works when the pump is in Sleep mode.

When the \wedge button is pressed while the Easy bolus feature is used, the bolus amount increases by a certain amount. This amount, or step size, can be set from 0.1 to 2.0 units of insulin. The pump makes a tone or vibration each time the \wedge button is pressed to help keep count of the steps.





Note: The step size cannot be greater than the Max bolus amount. The maximum number of steps is 20 for each bolus delivery.

Setting up the Easy bolus feature

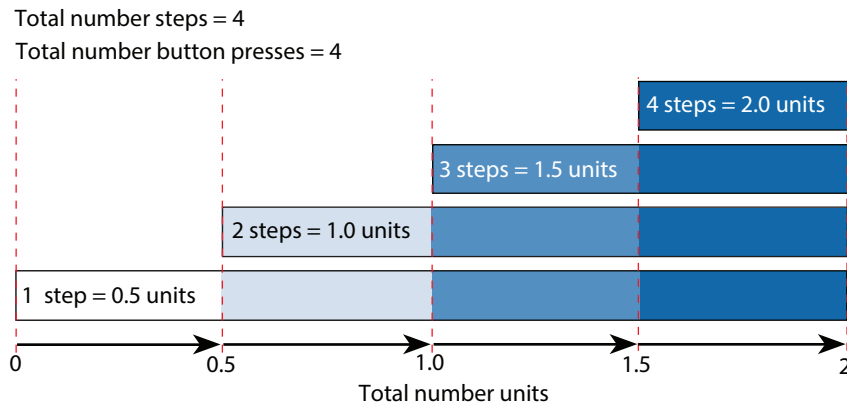
The following graph provides an example of setting up a bolus of 2.0 units of insulin using a step size of 0.5 units.



To set up the Easy bolus feature:

1. From the Home screen, press , and then select .
2. Select **Device Settings** > **Easy Bolus**.
3. Select **Easy Bolus** to turn on the feature.
4. Set the **Step Size** amount in units.

Select a step size to a number that makes it easy to calculate the total bolus amount.



5. Select **Save**.

Delivering a bolus using the Easy bolus feature



WARNING: Never rely on beeps or vibrations alone while using the Easy bolus feature. Always confirm the insulin delivery by looking at the pump screen. When using the Sound & Vibration options, it is possible that a sound or vibration notification may not occur as expected if the speaker or vibrator in the pump malfunctions. Relying on beeps or vibrations while using the Easy bolus feature may result in over-delivery of insulin.

To deliver a bolus using the Easy bolus feature:

1. While the pump is in Sleep mode, press and hold \wedge for one second or until the pump beeps or vibrates. The bolus can now be set up.



Note: If the pump does not respond when \wedge is pressed, it may not be in Sleep mode, even if the screen is dark. For more information, see *Sleep mode*, page 70.

2. Press \wedge the number of times needed to set the bolus amount. Count the tones or vibrations for each button press to confirm the total bolus amount.



Note: If \wedge is pressed too many times and the bolus amount is too high, press \vee to cancel the Easy bolus delivery and start at step 1 to set up a new bolus.

3. When the needed bolus amount is reached, press and hold \wedge to confirm the amount.
4. Press and hold \wedge for one second, or until the pump beeps or vibrates, to deliver the bolus.

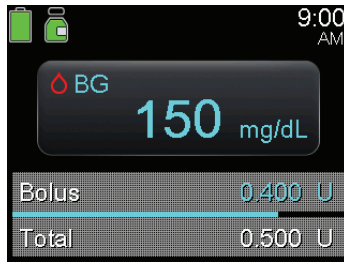

Note: If the \wedge button is not pressed within 10 seconds after the bolus amount is confirmed, the bolus is canceled and a message appears that the bolus was not delivered.

Preset bolus

The Preset Bolus feature allows frequently used bolus deliveries to be set up in advance. There are four preset bolus names that can be used to match a bolus to a meal that has a known carb content. Four additional preset bolus names can be set for other circumstances. These are numbered from Bolus 1 to Bolus 4.



Note: To set up a Preset bolus as a Dual Wave bolus or Square Wave bolus, the Dual Wave bolus feature or Square Wave bolus feature must be turned on.

Setting up and managing preset bolus deliveries

To set up preset bolus amounts:

1. From the Home screen, press \odot , and then select ⚙ .
2. Select **Delivery Settings** > **Preset Bolus Setup**.



3. Select **Add New**.

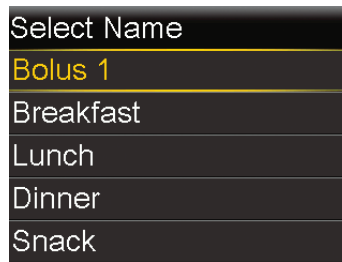

4. Select a preset bolus.
An edit screen appears.

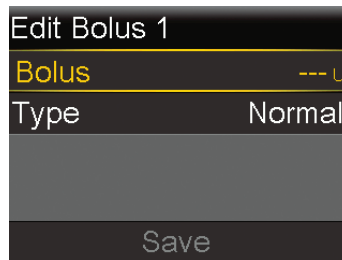

5. Select **Bolus** to set the bolus amount.
6. Select **Type** to set this as a normal bolus, Square Wave bolus, or Dual Wave bolus.



Note: Square Wave and Dual Wave can be selected in the **Type** field only if the Square Wave bolus and Dual Wave bolus features are turned on.

If the type is set to Square or Dual, do the following:

- For a Square Wave bolus, set the **Duration** of time for the bolus delivery.
- For a Dual Wave bolus, adjust the **Now** % amount. When the **Now** amount is adjusted, the **Square** amount adjusts automatically. Then set the **Duration** of time for the Square portion of the bolus.



Note: If the Dual Wave bolus feature or Square Wave bolus feature is turned off, the existing Preset Bolus settings are still available for use.

7. Select **Save**.



Editing, renaming, or deleting a preset bolus

Dual Wave Preset Boluses and Square Wave Preset Boluses can only be edited when the Dual Wave Bolus and Square Wave Bolus features are turned on.



Note: A preset bolus cannot be edited, renamed, or deleted during preset bolus delivery.

To edit, rename, or delete a preset bolus:



1. From the Home screen, press , and then select .
2. Select **Delivery Settings > Preset Bolus Setup**.
3. Select a preset bolus.
4. Select **Options**.
5. Do any of the following:
 - Select **Edit** to adjust the bolus value and type, if applicable. If changing to a Square Wave bolus, enter the duration. If changing to a Dual Wave bolus, enter the Now and Square values and the Duration.

- Select **Rename** to assign a different name to this preset bolus. When the Select Name screen appears, select any available name from the list.
- Select **Delete** to delete this preset bolus.

Delivering a preset bolus

A preset bolus must be set before the Preset Bolus feature can be used. For more information, see *Setting up and managing preset bolus deliveries*, page 266.

To deliver a preset bolus:

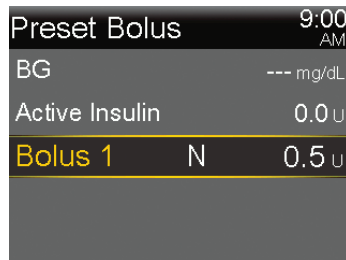

1. From the Home screen, press , and then select .
2. Select **Bolus > Preset Bolus**.
3. Select the preset bolus to be delivered.

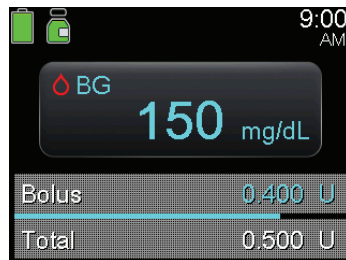

4. Review the bolus amount, and then select **Deliver Bolus** to start the bolus.



Stopping a Square Wave or Dual Wave bolus delivery

This section describes how to stop a bolus in progress. It does not stop basal insulin delivery. To stop all insulin delivery, use the Suspend All Delivery feature (press , select , and select **Suspend All Delivery**).

This section describes how to stop the following bolus deliveries:

- A Dual Wave bolus during the Now portion delivery
- A Square Wave bolus delivery or a Dual Wave bolus during the Square portion delivery

To stop a normal bolus delivery see *Stopping a bolus delivery*, page 112.



Note: When delivering a normal bolus and a Square Wave bolus at the same time, or a normal bolus and the Square portion of a Dual Wave bolus at the same time, both boluses are stopped.

To stop a Dual Wave bolus delivery during the Now portion:

1. While the pump is delivering the Now portion of a Dual Wave bolus, press  from the Home screen.

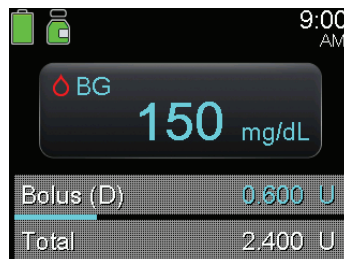

2. Select .
3. Select **Stop Bolus**, then select **Yes** to confirm.

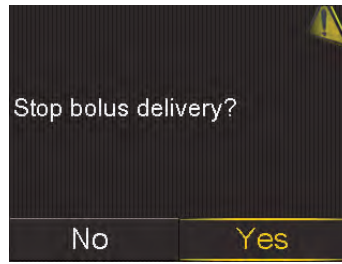

The Bolus Stopped screen appears and shows the amount of bolus delivered, and bolus amount that was originally set up.





Note: When a Dual Wave bolus is stopped during the Now portion, the Now portion is stopped and the Square portion is canceled.



4. Select **Done**.

To stop a Square Wave bolus delivery or the Square portion of a Dual Wave bolus delivery:

1. While the pump is delivering a Square Wave bolus delivery or the Square portion of a Dual Wave bolus delivery, press  from the Home screen.
2. Select  and then select **Bolus**.
3. Select **Stop Bolus**, then select **Yes** to confirm.

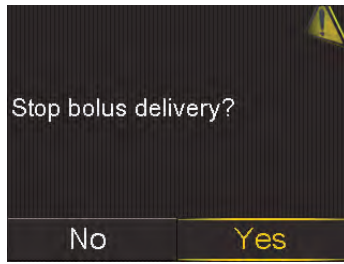

The Bolus Stopped screen appears and shows the amount of bolus delivered, and the bolus amount that was originally set up.

4. Select **Done**.



14

Troubleshooting

14

Troubleshooting

This chapter provides information about common MiniMed 780G insulin pump and sensor issues, as well as possible resolutions.

For a list of alarms, alerts, and messages, see *List of alarms, alerts, and messages*, page 295.

Pump issues



WARNING: When a Critical pump error alarm occurs, the following screen appears and the pump siren goes off:



Immediately disconnect the pump and discontinue use. Contact 24-Hour Technical Support.

Insulin delivery is still required when the pump is removed. Consult a healthcare professional to determine an alternate method of insulin delivery while the pump is removed.

The following table provides troubleshooting information for the insulin pump:

Issue	Resolution
<p> appears on the Home screen or Bolus screens after an Active Insulin reset to zero alarm occurs.</p>	<p>Select OK to clear the alarm.</p> <p>Contact 24-Hour Technical Support for assistance with the following steps:</p> <ol style="list-style-type: none"> 1. Check the Daily History screen or the sensor graph for the recent bolus amounts, and when they were delivered, before giving any bolus. 2. Consult a healthcare professional for how long to wait after active insulin has been reset to zero before relying on the active insulin calculation of the Bolus Wizard feature. The active insulin tracked prior to the Active Insulin reset to zero alarm is not included in new Bolus Wizard calculations. 3. Check blood glucose (BG) using a blood glucose meter and treat as needed.



WARNING: Do not rely on active insulin tracked in the pump when giving any bolus after active insulin has been reset to zero. Relying on the active insulin shown on the pump screen can result in the infusion of too much insulin, which can cause hypoglycemia.

<p>The pump buttons are stuck during airplane travel.</p>	<p>During atmospheric pressure changes, the pump buttons may not work for up to 45 minutes. For example, during airplane travel, pump buttons may get stuck and the pump will alarm. This is rare. If this occurs, either wait for the problem to correct itself, or confirm the AA battery connection:</p> <ol style="list-style-type: none"> 1. Remove the battery cap. 2. Place the battery cap back onto the pump.
---	--

Issue	Resolution
	<p>The pump will check the AA battery power, and may require a new AA battery.</p> <p>3. If prompted, insert a new AA battery. For more information about changing the battery, see <i>Removing the battery</i>, page 291.</p> <p>If these steps do not correct the problem, contact 24-Hour Technical Support for assistance.</p>
<p>The pump was dropped or there are concerns that the pump may be damaged.</p>	<div data-bbox="630 667 706 739" style="float: left; margin-right: 10px;"> </div> <p>CAUTION: Always inspect the pump for cracks before exposing the pump to water, especially if the pump was dropped or damaged. Water leakage can cause the pump to malfunction and result in injury.</p> <ol style="list-style-type: none"> 1. Disconnect the pump from body. Confirm all infusion set and reservoir connections are secure. 2. Disconnect the pump from body. Check the infusion set, including the tubing connector and tubing, for cracks or damage. 3. Check the display, button area, and pump case for cracks or damage. 4. Confirm the information on the Status screen, and the settings for the basal rates and the pump are correct. 5. Confirm the settings for the basal rates and the pump are correct. 6. Perform a self test. For more information, see <i>Self Test</i>, page 206. 7. If necessary, contact 24-Hour Technical Support and check BG. <p>For health-related questions or concerns, consult a healthcare professional.</p>

Issue	Resolution
The pump display times out too quickly.	In order to conserve battery, the pump display times out after 15 seconds. To increase the time, see <i>Display options, page 203</i> .
The pump displays a Check Settings alarm.	The pump has reset to factory settings. Review any settings that were not already set in the Startup Wizard and re-enter them, if necessary.
The pump settings have been cleared and need to be re-entered.	<p>Do not clear pump settings unless directed to do so by a healthcare professional. Certain pump errors may cause the pump to reset to factory default values, which clears the current pump settings. To restore saved pump settings, see <i>Restoring the settings, page 208</i>.</p> <p>Consult a healthcare professional to determine the necessary settings. Have the settings that need to be entered into the pump ready before starting the procedure below.</p> <p>Use the following procedure to re-enter personalized pump settings using the Startup Wizard:</p> <ol style="list-style-type: none"> 1. After the pump resets, the Startup Wizard appears. Select a language, and then press ⊙. 2. Select a time format, and then press ⊙. 3. Enter the current time, and then select Next. 4. Enter the current date, and then select Next. 5. Select the carb unit, and then press ⊙. 6. When the Active Insulin Time screen appears, select Next. For more information, see <i>Bolus Wizard settings, page 103</i>. 7. Enter the Duration, and then select Next. 8. Enter the basal rates for the new basal pattern, and then select Next. For more information, see <i>Setting up a basal pattern, page 90</i>. 9. Review the basal pattern information, and then select Next.

Issue	Resolution
	<ol style="list-style-type: none"> On the Startup screen, a message displays to ask to set up Bolus Wizard now. Do one of the following: <ul style="list-style-type: none"> Select Yes to enter the Bolus Wizard settings. For more information, see <i>Bolus Wizard settings, page 103</i>. Select No to skip the Bolus Wizard setup.

Sensor issues

Issue	Resolution
The pump has lost connection with the sensor.	<p>After 30 minutes without a signal, the Lost sensor signal alert appears. Follow the steps on the pump screen or the steps below to try to resolve the issue.</p> <p>Note: If alerts are silenced and a sensor alert occurs, the alert still appears on the screen.</p> <ol style="list-style-type: none"> Move the pump closer to the transmitter, and then select OK. It can take up to 15 minutes for the pump to find the sensor signal. If the pump still cannot find the sensor signal, the Possible signal interference alert appears. Move away from electronic devices that may cause interference, and then select OK. Wait 15 minutes for the pump to locate the sensor signal. If a signal is not found, the Check connection alert appears. Confirm that the connection between the transmitter and sensor is secure, and then select OK. The “Check sensor insertion” message appears. Do one of the following: <ul style="list-style-type: none"> If the sensor connection is secure, select Yes. Contact 24-Hour Technical Support if the pump cannot find the sensor signal within 15 minutes

Issue	Resolution
	<p>or if the “Sensor signal not found- See User guide” alert appears on the sensor glucose (SG) graph.</p> <ul style="list-style-type: none"> If the sensor is not securely connected to the transmitter, select No. A Change sensor alert appears. Select OK and change the sensor.
<p>A calibration is not accepted.</p>	<p>The sensor does not require calibration for use with the system. However, every BG reading provided to the pump is used to calibrate the sensor.</p> <p>A Calibration not accepted alert occurs in one of the following situations:</p> <ul style="list-style-type: none"> The system cannot use the entered BG meter reading. Only a BG value between 50 mg/dL and 400 mg/dL can be used to calibrate the sensor. Wait at least 15 minutes, wash hands, and try again. The entered BG meter reading differs too greatly from the most recent sensor glucose (SG) value. Check the accuracy of the BG meter reading and try again. The transmitter cannot receive the calibration BG meter readings from the pump due to a failed sensor signal. Troubleshoot the failed sensor signal.
<p>The suspend by sensor icon appears with a red X. </p>	<p>The suspend by sensor icon appears with a red X when the Suspend before low or the Suspend on low feature is unavailable. This can occur in the following situations:</p> <ul style="list-style-type: none"> A suspend event recently occurred. For information about the availability of the suspend functionality, see <i>The Suspend before low feature, page 156</i> or <i>The Suspend on low feature, page 158</i>. Sensor glucose (SG) readings are unavailable. <p>SG readings may be unavailable in the following situations:</p>

Issue	Resolution
	<ul style="list-style-type: none"><li data-bbox="613 327 1013 352">• A BG meter reading is required.<li data-bbox="613 386 1344 457">• The pump has lost communication with the sensor. Restore pump communication with the sensor.<li data-bbox="613 491 1360 562">• The sensor is updating. Clear the alert and wait up to 3 hours for the SG readings to resume.
	<p data-bbox="602 575 1360 646">If necessary, insert a new sensor. If the issue continues after a new sensor is inserted, contact 24-Hour Technical Support.</p>



15

Maintenance

15

Maintenance

This chapter provides information about maintaining the components of the MiniMed 780G system.

Pump maintenance

Cleaning the pump

Prepare the following supplies to clean the pump:

- four small, clean, soft cloths
- mixture of water and mild detergent
- clean water
- 70% alcohol
- clean cotton swabs
- clean cotton balls



CAUTION: Never use organic solvents, such as lighter fluid, nail polish remover, or paint thinner to clean the MiniMed 780G insulin pump. Never use lubricants with the pump. When the pump is being cleaned, be sure to keep the reservoir compartment dry and away from moisture. If organic solvents are used to clean the pump, they can cause the pump to malfunction and result in minor injury.

To clean the pump:

1. Dampen a cloth with water mixed with a mild detergent.
2. Use the cloth to wipe the outside of the pump while keeping the inside of the reservoir compartment dry.
3. Dampen a clean cloth with water and wipe to remove any detergent residue.
4. Dry with a clean cloth.
5. Wipe the pump with a 70% alcohol wipe.
6. Use a dry, clean cotton swab to remove any battery residue from the battery cap.
7. Use a dry, clean cotton swab to remove any battery residue from the battery compartment housing.

Storing the pump

The pump can be stored when it is not in use.



WARNING: After the pump is stored, do not rely on active insulin tracked in the pump when making new Bolus Wizard calculations. Storage mode clears active insulin. Inaccurate Bolus Wizard calculations may result in inaccurate insulin delivery and serious injury.

To place the pump in storage mode:

1. Remove the AA battery from the pump. For details, see *Removing the battery*, page 291.



Note: When the battery is removed, the pump issues an Insert Battery alarm for 10 minutes or until the pump is in storage mode.

2. Press and hold  until the screen turns off.



CAUTION: Never expose the pump to temperatures below -4 °F (-20 °C) or above 122 °F (50 °C). Storing the pump in temperatures outside of this range can damage the pump.

To use the pump after it has been stored:

1. Insert a new AA battery into the pump. For details, see *Inserting the battery*, page 72.

A Pump Error alarm appears.

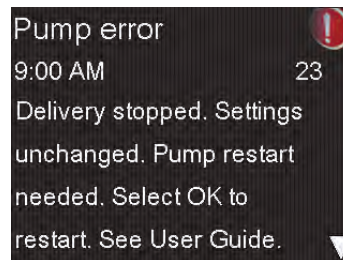

2. Select **OK**.

The pump displays a Power Loss alarm.

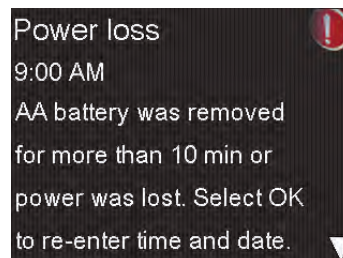

3. Select **OK**.

The Time & Date screen appears.

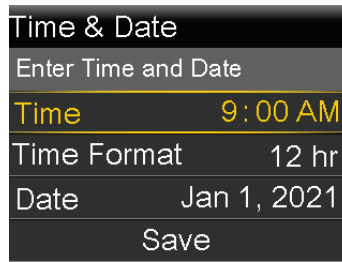

4. Enter the current **Time**, **Time Format**, and **Date**.

5. Select **Save**.

The pump displays an Active Insulin Cleared alert.

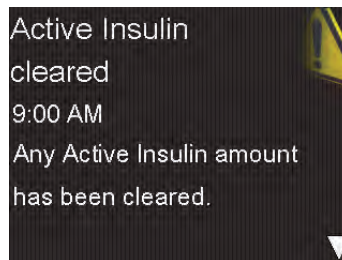

6. Select **OK**.

Confirm that all the settings, such as basal rate, are set as desired. Use the Restore Settings option to reapply the last saved settings, if needed. For more information, see *Restoring the settings*, page 208.

7. Repeat the pairing process for the transmitter and meter. For transmitter details, see *Pairing the pump and transmitter*, page 139. For meter details, see *Pairing the pump and meter*, page 137.

Pump disposal



Always follow local laws and regulations for the disposal of medical devices.

Meter maintenance

Unpairing a meter from the pump

Follow this procedure to unpair the Accu-Chek™* Guide Link meter from the pump.

To unpair the meter from the pump:

1. From the Home screen, press , and then select .
The Paired Devices screen appears.

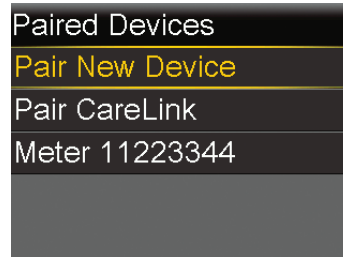

2. Select the serial number of the meter to unpair the device. The Accu-Chek™TM Guide Link meter serial number is located on the back of the meter.
The Device Info screen appears.



3. Select **Unpair**.
The Unpair Device? screen appears.

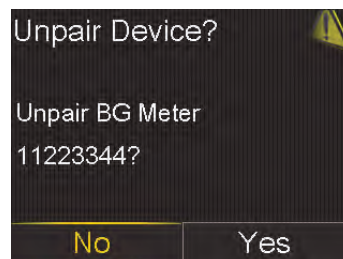

4. Select **Yes** to confirm. Select **No** to cancel.

Deleting the pump from a meter

For steps to delete the pump from a meter, see the Accu-Chek™* Guide Link User's Manual.

Transmitter and sensor maintenance

Unpairing the transmitter from the pump

Follow this procedure to unpair the transmitter from the pump, including when the transmitter needs to be replaced.

To unpair the transmitter from the pump:

1. From the Home screen, press , and then select .

The Paired Devices screen appears.

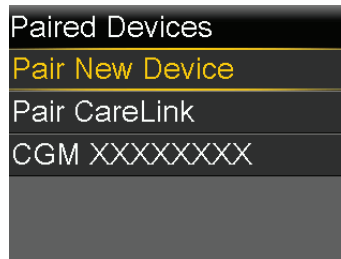

2. Select CGM with the correct serial number.

The Device Info screen appears.

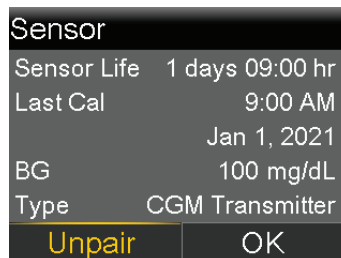

3. Select **Unpair**.

The Unpair Device? screen appears.

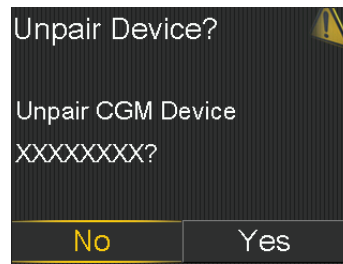

4. Select **Yes** to confirm. Select **No** to cancel.

When the transmitter is unpaired from the pump, a No Paired CGM banner appears on the Home screen.

Disconnecting the transmitter from the sensor

Refer to the transmitter user guide for instructions on how to disconnect the transmitter from the sensor.

Removing the sensor

Refer to the sensor user guide for instructions on how to remove the sensor.

Cleaning the transmitter

Refer to the transmitter user guide for instructions on how to clean the transmitter.

Storing the transmitter

Refer to the transmitter user guide for instructions on how to store the transmitter.

Removing the battery



CAUTION: Do not remove the battery unless a new battery needs to be inserted or to store the pump. The pump cannot deliver insulin while the battery is removed. After an old battery is removed, make sure to replace it with a new battery within 10 minutes to clear the Insert battery alarm and avoid a Power loss alarm. If power loss occurs, the time and date settings must be re-entered.

To remove the battery:

1. Before a battery is removed from the pump, clear any active alarms or alerts.
2. Use the pump clip or a coin to loosen and remove the battery cap.
3. Remove the battery.

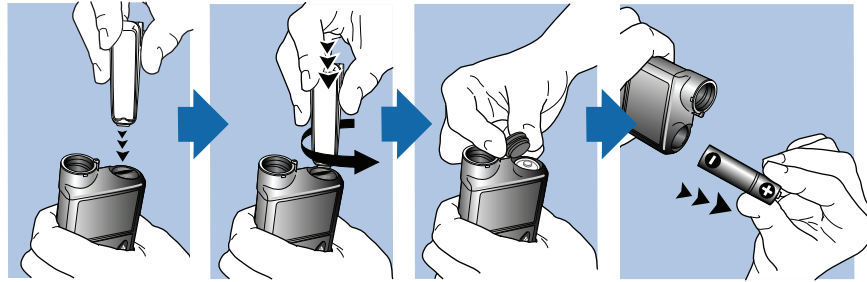

4. Dispose of old batteries in an appropriate container and in accordance with local laws for battery disposal.
5. After a battery is removed, wait until the Insert Battery screen appears before inserting a new battery.

If a battery is removed to place the pump in storage, see *Storing the pump*, page 286 for more information.

Appendix A: List of alarms, alerts, and messages



Appendix A: List of alarms, alerts, and messages

This appendix provides information about alarms, alerts, and messages that can occur in the MiniMed 780G system.

Pump alarms, alerts, and messages

The following table lists the most common or serious alarms, alerts, and messages related to the MiniMed 780G insulin pump. The table also explains the meaning, consequences, and the reasons why these notifications appear, and provides steps for problem resolution.



Note: Use the MiniMed Mobile app to view the sensor graph on a mobile device. Always read and acknowledge all alarms and alerts on the pump. If the pump simultaneously generates more than one alarm or alert, only one of the alarms or alerts appears on the mobile device.

Title and text	Type	Explanation	Next steps
<p>Active Insulin cleared</p> <p>Any Active Insulin amount has been cleared.</p>	Alert	The pump shows the active insulin amount at 0 units. The pump shows this alert when the active insulin is cleared from the Clear Active Insulin option on the Manage Settings screen or if the pump has been shut down and is powered back on.	<ul style="list-style-type: none"> Select OK to clear the alert. The active insulin tracked prior to pump restart is not included in new Bolus Wizard calculations. Consult a health-care professional for how long to wait after active insulin is cleared before relying on the

Title and text	Type	Explanation	Next steps
			<p>active insulin calculation of the Bolus Wizard feature.</p> <ul style="list-style-type: none"> • Check Daily History for the last bolus amount and when it was delivered.
<p>Active Insulin reset to zero ? Call local Medtronic support for assistance. See User Guide for phone numbers. Pump Active Insulin may be incorrect until XX:XX AM/PM due to a pump error. Monitor glucose.</p>	Alarm	The pump shows the active insulin amount at 0 units. This occurs when a pump error clears active insulin in the pump. After the Active Insulin reset to zero alarm occurs, ? appears on the Home screen and Bolus screens until the time shown in the alarm.	<p>Select OK to clear the alarm. Contact 24-Hour Technical Support for assistance.</p>
<p>Active Insulin Reminder ? Call local Medtronic support for assistance if needed. See User Guide for phone numbers. Pump Active Insulin was reset to zero at XX:XX AM/PM. Active insulin may be incorrect until XX:XX AM/PM. Monitor glucose.</p>	Message	The Active Insulin Reminder message occurs when the Bolus Wizard screen or the Manual Bolus screen is accessed before the time shown in the message. After the Active Insulin reset to zero alarm occurs, ? appears on the Home screen and Bolus screens until the time shown in the Active Insulin reset to zero alarm or the Active Insulin Reminder message.	<p>Select OK to clear the message. Contact 24-Hour Technical Support for assistance with the following steps.</p> <ul style="list-style-type: none"> • Check the Daily History screen or the sensor graph for the recent bolus amounts, and when they were delivered, before giving any bolus. • Consult a healthcare professional for how long to wait after active insulin has been reset to zero before relying on the active insulin calculation of the Bolus Wizard feature. The active insulin tracked prior to the Active Insulin reset to zero alarm is not included in new Bolus Wizard calculations. • Check blood glucose (BG) using a blood glucose meter and treat as needed.

Title and text	Type	Explanation	Next steps
<p>Auto Suspend Insulin delivery suspended. No buttons pressed within time set in Auto Suspend.</p>	Alarm	Insulin delivery is currently suspended by Auto Suspend. The Auto Suspend feature automatically suspends insulin delivery and triggers an alarm after no buttons are pressed for a specified period of time. Insulin delivery is suspended until the alarm is cleared and basal insulin delivery resumed.	<ul style="list-style-type: none"> Select Resume Basal to clear the alarm and resume basal insulin delivery. Check BG and treat as needed.
<p>Battery failed Insert a new AA battery.</p>	Alarm	The battery in the pump is low on power.	<ul style="list-style-type: none"> Select OK to clear the alarm. Remove the old battery and insert a new AA battery.
<p>Battery not compatible. See User Guide.</p>	Alarm	The inserted battery is not compatible with the pump.	<ul style="list-style-type: none"> Remove the incompatible battery to clear the alarm. Insert a new AA battery.
<p>Bolus not delivered Bolus entry timed out before delivery. If bolus intended, enter values again.</p>	Alert	A bolus value was entered, but a bolus was not delivered within 30 seconds.	<ul style="list-style-type: none"> Select OK to clear the alert. If a bolus delivery was intended, check BG, re-enter bolus values and redeliver the bolus.
<p>Bolus stopped Cannot resume bolus or cannula fill. XX.XXX of YY.YYY U delivered. ZZ.ZZZ U not delivered. If needed, enter values again.</p>	Alarm	The battery power was exhausted while a bolus delivery or Fill Cannula procedure was in progress or the Resume bolus? message appeared and was not cleared.	<ul style="list-style-type: none"> Note the amount of insulin not delivered. Replace the AA battery. Select OK to clear the alarm. Deliver the remaining bolus amount if needed.
<p>Check settings Startup Wizard settings complete. Check and set up your other settings.</p>	Alert	Some settings have been cleared or reverted to factory default values.	<ul style="list-style-type: none"> Select OK to clear the alert. Review any settings that have not already been set in Startup Wizard and re-enter the values if necessary.
<p>Critical pump error Delivery stopped. Pump not working properly. Stop using</p>	Alarm	The pump has encountered an error that cannot be resolved. For example, the pump may have a mechanical problem.	The pump is not able to deliver insulin. Disconnect the infusion set and stop using the pump.

Title and text	Type	Explanation	Next steps
pump. Remove infusion set from body. Consider other insulin treatment. See User Guide.			<ul style="list-style-type: none"> Consider another form of insulin delivery. Check BG, and treat as necessary. Write down the error code that appears on the alarm screen. Contact 24-Hour Technical Support for assistance with the pump.
Delivery limit exceeded Delivery stopped. Check BG. See User Guide for more information.	Alarm	The pump has suspended insulin delivery because the hourly delivery limit was reached. This limit is based on the maximum bolus and maximum basal setting. If this alarm occurs during a bolus, the bolus is canceled before it can complete.	<ul style="list-style-type: none"> Check BG. Select Resume Basal. Check Bolus History and re-evaluate insulin needs. Continue to monitor BG.
Device Limit You must delete an existing device (device type) before you can pair a new one (device type).	Message	The pump is already paired with the maximum number of devices for this type. The following list describes the maximum number of each device type to pair with the pump: <ul style="list-style-type: none"> Meter—four Accu-Chek™^{TMX} Guide Link meters CGM—one Guardian 4 transmitter Mobile Device—one compatible mobile device 	<ul style="list-style-type: none"> Select OK to clear the message. Go to the Paired Devices screen and select the device to unpair from the list of devices. Select Unpair, and then select Yes to confirm or No to cancel. Pair the pump and the desired device.
Device not compatible Device cannot be used with this pump.	Alert	The pump cannot pair with the selected device.	<ul style="list-style-type: none"> Select OK to clear the alert. Contact 24-Hour Technical Support for assistance.
Device not found Make sure device is in range and in pairing mode.	Alert	The pump did not pair with the device.	<ul style="list-style-type: none"> Select OK to clear the alert. Confirm that the device is not already paired with a pump.

Title and text	Type	Explanation	Next steps
			<ul style="list-style-type: none"> • Confirm that the device is ready to pair with the pump. • Make sure the pump is away from any electronic devices that might cause interference, such as cellular phones that are not paired with the MiniMed 780G system and other wireless devices. • Move the device closer to the pump. • Try to pair the pump with the device again.
<p>Fill Cannula? Select Fill to fill cannula or select Done if not needed.</p>	Alarm	The Fill Cannula? screen has been active for 15 minutes.	<ul style="list-style-type: none"> • To fill the cannula, select Fill. • If the cannula does not need to be filled, select Done to skip this process.
<p>High BG XXX mg/dL Check infusion set. Check ketones. Consider insulin injection. Monitor BG. Confirm BG?</p>	Alert	The BG meter reading is above 250 mg/dL. This alert appears in Manual mode. For High BG XXX mg/dL while the SmartGuard feature is on, see <i>SmartGuard feature alerts and messages, page 315</i> .	<ul style="list-style-type: none"> • Select No to prevent the remote BG from being used by the pump. Select Yes to confirm the BG reading. • Check BG and treat as necessary.
<p>Insert battery Delivery stopped. Insert a new battery now.</p>	Alarm	The battery was removed from the pump. If a bolus was in progress when the battery was removed, a Resume bolus? message appears and a tone sounds when a new battery is inserted. The message indicates how much of the bolus was delivered.	<ul style="list-style-type: none"> • Insert a new AA battery. • The alarm clears when a new battery is inserted. • The pump powers off after 10 minutes unless a new battery is inserted.

Title and text	Type	Explanation	Next steps
<p>Insulin flow blocked</p> <p>Check BG. Consider testing ketones.</p> <p>Check reservoir and infusion set.</p>	Alarm	The pump has detected that the basal or bolus insulin flow was blocked.	<ul style="list-style-type: none"> • Check BG and ketones. Administer an insulin injection if necessary. • Remove the infusion set and reservoir. • Select Reservoir & Set to start the process with a new infusion set and reservoir. <p>If the alarm occurs during a bolus delivery:</p> <ul style="list-style-type: none"> • Check the Daily History screen for the amount of bolus already delivered before the pump alarmed. • Consider delivering remaining bolus, if the bolus insulin was not included in an insulin injection.



WARNING: Do not use the SmartGuard feature for a period of time, determined by a healthcare professional, after giving a manual injection of insulin by syringe or pen. Manual injections are not accounted for in the active insulin amount. Therefore, the SmartGuard feature could deliver too much insulin. Too much insulin may cause hypoglycemia. Consult a healthcare professional for how long to wait after a manual injection of insulin before resuming the SmartGuard feature.

<p>Insulin flow blocked</p> <p>Check BG. Consider testing ketones. Estimated 0 U insulin in reservoir. Change reservoir and infusion set.</p>	Alarm	The pump has detected that the insulin flow is blocked and there is no insulin in the reservoir.	<ul style="list-style-type: none"> • Check BG and ketones. Administer an insulin injection if necessary. • Remove the infusion set and reservoir. • Select Reservoir & Set to start the process with a new infusion set and reservoir. <p>If the alarm occurs during a bolus delivery:</p> <ul style="list-style-type: none"> • Check the Daily History screen for the amount of bo-
--	-------	--	---

Title and text	Type	Explanation	Next steps
			<p>lus already delivered before the pump alarmed.</p> <ul style="list-style-type: none"> Consider delivering remaining bolus, if the bolus insulin was not included in an insulin injection.
<p>Insulin flow blocked Fill Cannula stopped. Remove infusion set from body. Change reservoir and infusion set.</p>	Alarm	The pump has detected that the insulin flow is blocked while filling the cannula.	<ul style="list-style-type: none"> Check BG and ketones. Administer an insulin injection if necessary. Remove the infusion set and reservoir. Select Reservoir & Set to start the process with a new infusion set and reservoir.
<p>Insulin flow blocked Fill Tubing stopped. Remove reservoir and select Rewind to restart.</p>	Alarm	The pump has detected that the insulin flow is blocked while filling the tubing. Possible connection issue between the tubing and reservoir.	<ul style="list-style-type: none"> Remove the reservoir and select Reservoir & Set to restart the fill tubing process. Disconnect the tubing from the reservoir. Confirm that the tubing is not crimped or bent. Continue to follow the steps displayed on the pump using the same infusion set and reservoir. If this alarm occurs again, replace the infusion set.
<p>Loading incomplete Remove reservoir and select Rewind to restart loading.</p>	Alarm	⬅️ was pressed after loading began.	<ul style="list-style-type: none"> Remove the reservoir to start again. Select Rewind and follow the on-screen instructions.
<p>Low battery Pump Replace battery soon.</p>	Alert	The battery in the pump is low on power. Remaining battery life is 10 hours or fewer.	<ul style="list-style-type: none"> Select OK to clear the alert. Replace the AA battery as soon as possible. Otherwise, insulin delivery stops, and the

Title and text	Type	Explanation	Next steps
<p>Low BG XX mg/dL Treat Low BG. Do not bolus until BG is normal. Monitor BG. Confirm BG?</p>	Alert	The BG meter reading is below 70 mg/dL.	<p>Replace battery now alarm occurs.</p> <ul style="list-style-type: none"> If the pump is delivering a bolus or filling the cannula, wait until delivery is complete to replace battery. <ul style="list-style-type: none"> Select No to prevent the remote BG reading from being used by the pump. Select Yes to confirm the BG reading. Check BG and treat as necessary.
<p>Low reservoir XX units remaining. Change reservoir.</p>	Alert	The reservoir is low on insulin, according to the number of units set in the Low Reservoir reminder.	<ul style="list-style-type: none"> Select OK to clear the alert. Change the reservoir soon. If the reservoir is not changed after this alert is received, a second Low reservoir alert appears when the insulin level reaches half of the original alert amount.
<p>Manage settings error Delivery stopped. Backup settings cleared from Manage Settings. Current settings are working properly. Select OK to restart. See User Guide.</p>	Alarm	A pump error occurred and the pump needs to be restarted. The backup settings have been lost, but the current settings are unchanged.	<ul style="list-style-type: none"> Select OK to restart the pump. The current settings are unchanged. Only the backup settings are lost. When the pump restarts, follow instructions on the pump display. If the pump was delivering a bolus or filling the cannula, check Daily History and evaluate if insulin is needed.

Title and text	Type	Explanation	Next steps
Max Fill reached 3X.X U. Did you see drops at the end of tubing?	Alarm	The number of units expected to fill the tubing has been exceeded. By now, insulin should be visible at the end of the tubing.	<ul style="list-style-type: none"> If there are drops of insulin at the end of the tubing, select Yes. If there are no drops of insulin at the end of the tubing, select No. Follow instructions displayed on the pump.
Max Fill reached 4X.X U. Remove reservoir and select Rewind to restart New Reservoir procedure.	Alarm	The number of units expected to fill the tubing has been exceeded. By now, insulin should be visible at the end of the tubing.	<ul style="list-style-type: none"> Remove the reservoir. Check if there is still insulin in the reservoir. If there is insulin in the reservoir the same reservoir can be used. Select Rewind to restart the new reservoir procedure.
No reservoir detected Rewind before loading reservoir.	Alarm	There is no reservoir in the pump or the reservoir is not properly locked into place.	<ul style="list-style-type: none"> Select Rewind. Confirm that the reservoir is filled with insulin. When prompted, confirm that the reservoir is inserted and properly locked into place.
Power error detected Delivery stopped. Record your settings by uploading to CareLink or write your settings on paper. See User Guide.	Alarm	The internal power source in the pump is unable to charge. The pump is operating on the AA battery only.	<ul style="list-style-type: none"> Select OK to clear the alarm. Check BG and treat as necessary. Record the pump settings as soon as possible because the AA battery may not last long. Contact 24-Hour Technical Support for assistance with the pump.
Power loss AA battery was removed for more than 10 min or power was lost. Select OK to re-enter time and date.	Alarm	The battery has been out of the pump for more than ten minutes and the pump has lost power. The date and time must be reset.	<ul style="list-style-type: none"> Select OK to go to the Time & Date screen. Enter the current time, time format, and date.

Title and text	Type	Explanation	Next steps
<p>Pump error Delivery stopped. Current settings cleared. Pump restart needed. Select OK to restart and then re-enter your settings. See User Guide.</p>	Alarm	The pump encountered an error and will restart. The pump settings will return to factory default values.	<ul style="list-style-type: none"> • Select OK to restart the pump. • When the pump restarts, follow instructions on the pump display. • After the pump restarts, check settings and re-enter values as needed. • If the backup settings were recently saved in Manage Settings, use Restore Settings. • If the pump was delivering a bolus or filling the cannula, check Daily History and re-evaluate if insulin is needed. • If this alarm recurs frequently, write down the error code on the alarm screen (it can also be found in the Alarm History) and contact 24-Hour Technical Support for assistance.
<p>Pump error Delivery stopped. Settings unchanged. Pump restart needed. Select OK to restart. See User Guide.</p>	Alarm	A pump error has occurred, the pump needs to be restarted.	<ul style="list-style-type: none"> • Select OK to restart the pump. • If the pump was delivering a bolus or filling the cannula, check Daily History and re-evaluate if insulin is needed. • If this alarm recurs frequently, write down the error code on the alarm screen (it can also be found in the Alarm History) and contact 24-Hour Technical Support for assistance.
<p>Pump error Delivery stopped. Settings unchanged. Select OK to continue. See User Guide.</p>	Alarm	The pump encountered an error but a restart is not necessary. The issue is resolved. The settings are not changed.	<ul style="list-style-type: none"> • Select OK to resume basal insulin delivery. • If the pump was delivering a bolus or filling the cannula, check Daily History and

Title and text	Type	Explanation	Next steps
			<p>re-evaluate if insulin is needed.</p> <ul style="list-style-type: none"> If this alarm recurs frequently, write down the error code on the alarm screen (it can also be found in the Alarm History) and contact 24-Hour Technical Support for assistance.
<p>Pump restarted Delivery stopped. Settings unchanged. Select OK to continue. See User Guide.</p>	Alarm	The pump has encountered a problem and has restarted. The settings have not been changed.	<ul style="list-style-type: none"> Select OK to continue. If the pump was delivering a bolus or filling the cannula, check Daily History and re-evaluate if insulin is needed. If this alarm recurs frequently, write down the error code on the alarm screen (it can also be found in the Alarm History) and contact 24-Hour Technical Support for assistance.
<p>Replace battery Battery life less than 30 minutes. To ensure insulin delivery, replace battery now.</p>	Alert	Battery power is low and will be exhausted within 30 minutes.	<ul style="list-style-type: none"> Select OK to clear the alert. Replace the AA battery.
<p>Replace battery now Delivery stopped. Battery must be replaced to resume delivery.</p>	Alarm	Insulin delivery has stopped due to low power. The battery was not replaced after the Low battery Pump alert.	Replace the battery immediately to resume insulin delivery.
<p>Reservoir estimate at 0 U To ensure insulin delivery, change reservoir.</p>	Alert	The reservoir level is estimated at 0 U.	<ul style="list-style-type: none"> Select OK to clear the alert. Change the reservoir.

Title and text	Type	Explanation	Next steps
Resume bolus? XXX of YYY U delivered. Resume delivery of ZZZ U?	Message	A normal bolus delivery has been interrupted because the pump battery was removed. If it is within ten minutes since this interruption, the bolus can be resumed.	<ul style="list-style-type: none"> • Check the message to see how much of the bolus was delivered. • To cancel the remaining bolus delivery, select Cancel. • To resume the bolus delivery, select Resume.
Resume Dual bolus? XX of YYU delivered. Resume delivery of ZZ U for XX:XX hr?	Message	The Square portion of Dual Bolus delivery has been interrupted. If it is within ten minutes since this interruption, the bolus can be resumed.	<ul style="list-style-type: none"> • Check the message to see how much of the Dual Wave bolus was delivered. • To cancel the remaining bolus delivery, select Cancel. • To resume the bolus delivery, select Resume.
Resume Dual bolus? XX of YYU delivered. Resume delivery of ZZ U now, and AA U Square for XX:XX hr?	Message	The Now portion of a Dual Wave bolus delivery has been interrupted because the pump battery was removed. If it is within ten minutes since this interruption, the bolus can be resumed.	<ul style="list-style-type: none"> • Check the message to see how much of the Dual Wave bolus was delivered. • To cancel the remaining bolus delivery, select Cancel. • To resume the bolus delivery, select Resume.
Resume Square bolus? XX of YY U delivered for XX:XX hr. Resume delivery of ZZ U for XX:XX hr?	Message	The Square Wave bolus delivery was interrupted. If it is within ten minutes since this interruption, the bolus can be resumed.	<ul style="list-style-type: none"> • Check the message to see how much of the Square Wave bolus was delivered. • To cancel the remaining bolus delivery, select Cancel. • To resume the bolus delivery, select Resume.
Rewind required Delivery stopped. Rewind was required due to pump error. Select OK to continue. See User Guide.	Alarm	The pump encountered an error.	<ul style="list-style-type: none"> • Select OK to clear the alarm after the pump has completed rewinding. • Select Reservoir & Set from the Menu screen to start the new reservoir process with a new infusion set and reservoir. For details, see <i>Setting up</i>

Title and text	Type	Explanation	Next steps
			<p><i>the reservoir and infusion set, page 118.</i></p> <ul style="list-style-type: none"> If this alarm recurs frequently, contact 24-Hour Technical Support for assistance.
<p>Stuck button Button pressed for more than 3 minutes.</p>	Alarm	The pump has detected that a button has been pressed for an unusually long time.	<ul style="list-style-type: none"> Select OK to clear the alarm. If this alarm occurs again, contact 24-Hour Technical Support for assistance with the pump. <p>If the alarm cannot be cleared</p> <ul style="list-style-type: none"> See <i>Pump issues, page 275.</i> Consider another form of insulin, because the pump is not delivering insulin. Check BG and treat as necessary. Contact 24-Hour Technical Support for assistance with the pump.

CGM (sensor) alarms, alerts, and messages

The following table lists the most common or serious alarms, alerts, and messages related to sensor glucose (SG) values, as well as the status of the transmitter and sensor. The table also explains the meaning, consequences, and the reasons why these notifications appear, and provides steps for problem resolution.

Title and text	Type	Explanation	Next steps
<p>Alert before high Sensor glucose approaching High Limit. Check BG.</p>	Alert	The SG reading is approaching the specified high limit.	<ul style="list-style-type: none"> Select OK to clear the alert. Check BG. Follow instructions from a healthcare professional and continue to monitor BG.

Title and text	Type	Explanation	Next steps
Alert before low Sensor glucose approaching Low Limit. Check BG.	Alert	The SG reading is approaching the specified low limit.	<ul style="list-style-type: none"> • Select OK to clear the alert. • Check BG. • Follow instructions from a healthcare professional and continue to monitor BG.
Alert on high XXX mg/dL High sensor glucose. Check BG.	Alert	The SG reading is at or above the specified high limit.	<ul style="list-style-type: none"> • Select OK to clear the alert. • Check BG. • Follow instructions from a healthcare professional and continue to monitor BG.
Alert on low XX mg/dL Low sensor glucose. Check BG.	Alert	The SG reading is at or below the specified low limit.	<ul style="list-style-type: none"> • Select OK to clear the alert. • Check BG. • Follow instructions from a healthcare professional and continue to monitor BG.
Alert on low XX mg/dL Low sensor glucose. Insulin delivery suspended since XX:XX AM/PM. Check BG.	Alarm	The SG reading is at or below the specified low limit, and the pump has suspended insulin delivery due to a Suspend before low or Suspend on low.	<ul style="list-style-type: none"> • Select OK to clear the alarm. • Check BG. • Follow instructions from a healthcare professional and continue to monitor BG.
Basal delivery resumed Basal delivery resumed at XX:XX AM/PM after suspend by sensor. Check BG.	Message	The pump is resuming basal insulin delivery after a Suspend before low or Suspend on low event occurred.	<ul style="list-style-type: none"> • Select OK to clear the message. • Check BG. • Follow instructions from a healthcare professional and continue to monitor BG.
Basal delivery resumed Low settings change caused basal to be resumed at XX:XX AM/PM. Check BG.	Alert	The pump is resuming basal insulin delivery after a Suspend before low or a Suspend on low event occurred, because the Suspend before low or the Suspend on low feature was turned off.	<ul style="list-style-type: none"> • Select OK to clear the alert. • Check BG. • Follow instructions from a healthcare professional and continue to monitor BG.

Title and text	Type	Explanation	Next steps
<p>Basal delivery resumed</p> <p>Maximum 2 hour suspend time reached. Check BG.</p>	Alert	The pump is resuming basal insulin delivery two hours after a Suspend before low or Suspend on low event occurred.	<ul style="list-style-type: none"> Select OK to clear the alert. Check BG. Follow instructions from a healthcare professional and continue to monitor BG.
<p>Basal delivery resumed</p> <p>Maximum 2 hour suspend time reached. SG is still under Low limit. Check BG.</p>	Alarm	The pump is resuming basal insulin delivery two hours after a Suspend before low or Suspend on low event occurred.	<ul style="list-style-type: none"> The pump has resumed basal insulin delivery; however, the SG reading is still at or below the low limit. Select OK to clear the alarm. Check BG. Follow instructions from a healthcare professional and continue to monitor BG.
<p>BG not received</p> <p>Place pump close to transmitter. Select OK to resend BG to transmitter.</p>	Alert	The transmitter was unable to receive the BG meter reading from the pump.	<ul style="list-style-type: none"> Move the pump and transmitter closer together. Select OK to clear the alert, and then enter a new BG meter reading.
<p>Calibration not accepted</p> <p>Sensor information is unavailable for up to 2 hours. Entered BGs may not calibrate the sensor but can still be used for therapy.</p>	Alert	The system was unable to use the BG meter readings entered to calibrate the sensor. This alert occurs on the first day only.	<ul style="list-style-type: none"> Wash and dry hands thoroughly. Select OK to clear the alert. Consider waiting up to two hours, and then enter a new BG meter reading. Contact 24-Hour Technical Support for assistance, if needed.
<p>Calibration not accepted</p> <p>Wait at least 15 minutes. Wash hands, test BG again and calibrate.</p>	Alert	The system was unable to use the BG meter readings entered to calibrate the sensor.	<ul style="list-style-type: none"> Wash and dry hands thoroughly. Select OK to clear the alert. After 15 minutes, enter a new BG meter reading. If a Calibration not accepted alert is received on the second calibration after 15 minutes, a Change sensor alert occurs. Contact 24-Hour Technical Support for assistance, if needed.

Title and text	Type	Explanation	Next steps
Change sensor Insert new sensor and Start New Sensor.	Alert	No was selected in the Check sensor insertion message, indicating that the sensor is not fully inserted.	<ul style="list-style-type: none"> Select OK to clear the alert. Change the sensor. For details, see the sensor user guide. After the sensor is changed, refer to <i>Starting the sensor, page 170</i>.
Change sensor Second calibration not accepted. Insert new sensor.	Alert	A Calibration not accepted alert occurs if the entered BG meter reading differs too greatly from the most recent SG reading. This alert occurs when two Calibration not accepted alerts are received in a row.	<ul style="list-style-type: none"> Select OK to clear the alert. Change the sensor. For details, see the sensor user guide.
Change sensor Sensor not working properly. Insert new sensor.	Alert	This alert occurs when the transmitter diagnoses a problem with the sensor that cannot be resolved.	<ul style="list-style-type: none"> Select OK to clear the alert. Change the sensor. For details, see the sensor user guide.
Check connection Ensure transmitter and sensor connection is secure, then select OK.	Alert	The pump fails to detect the transmitter and is unable to receive sensor signal.	<ul style="list-style-type: none"> Select OK to clear the alert. If the sensor is fully inserted, select Yes. If the sensor is not fully inserted, select No. If the sensor was not fully inserted, insert a new sensor. See <i>Pump issues, page 275</i> for additional assistance, if needed.
Enter BG now Enter BG to calibrate sensor. Sensor information is no longer available	Alert	A BG meter reading is required to calibrate the sensor. SG readings cannot be received until the sensor is calibrated.	<ul style="list-style-type: none"> Select OK to clear the alert. If no BG meter reading is entered within 30 minutes, the Enter BG now alert occurs again. Select Snooze, enter the desired snooze time, and select OK. If no BG meter reading is entered before the

Title and text	Type	Explanation	Next steps
			<p>Snooze time has ended, the Enter BG now alert occurs again.</p> <ul style="list-style-type: none"> Enter a BG meter reading to calibrate the sensor.
<p>High SG Glucose was 250 mg/dL or higher for more than 3 hours. Check infusion set. Check ketones. Monitor glucose.</p>	Alert	SG was 250 mg/dL or higher for three hours.	<ul style="list-style-type: none"> Select OK to clear the alert. Check BG and treat as necessary.
<p>Lost sensor signal Move Pump closer to transmitter. May take 15 minutes to find signal.</p>	Alert	A transmitter signal has not been received for 30 minutes during or after sensor initialization.	<ul style="list-style-type: none"> Move the pump closer to the transmitter. It can take up to 15 minutes for the pump to establish communication with the transmitter. Select OK to clear the alert.
<p>Low battery transmitter Recharge transmitter within 24 hours.</p>	Alert	The battery in the transmitter needs to be recharged within 24 hours.	<ul style="list-style-type: none"> Select OK to clear the alert. Recharge the transmitter as soon as possible.
<p>Low SG XX mg/dL SG is under 64 mg/dL. Check BG and treat.</p>	Alarm	The SG reading has fallen below 64 mg/dL. This alarm is factory set and cannot be changed or turned off. This alarm cannot be silenced and is always active, whether the pump is using the SmartGuard feature or Manual mode.	<ul style="list-style-type: none"> Select OK to clear the alarm. Check BG and treat as necessary.

Note: This alarm does not suspend insulin delivery.

Note: XX represents the current SG reading that appears on the pump. This alarm remains until the alarm is cleared, even if glucose values reach or rise above 64 mg/dL.

Title and text	Type	Explanation	Next steps
 <p>WARNING: For MiniMed 780G Users Ages 7-13: Do not rely solely on the use of a low sensor glucose (SG) value for “Alert on Low” or “Alert before Low” or the “Low SG” alarm. A low sensor glucose alert may not reflect the user’s true blood glucose at these levels, or may not alert. Do not ignore symptoms of low glucose. Always confirm sensor glucose readings with a blood glucose meter, and treat according to the recommendations of a healthcare professional. Solely relying on these sensor glucose alerts and readings for treatment decisions could result in missing severe hypoglycemia (low blood glucose) events.</p>			
<p>Medical device CALL FOR EMERGENCY ASSISTANCE. I have diabetes.</p>	Alarm	The pump is suspended due to low SG and there has been no response to the alarm within 10 minutes.	<ul style="list-style-type: none"> • Select Dismiss. • Immediately call for emergency assistance.
<p>No calibration occurred Confirm sensor signal. Calibrate by XX:XX AM/PM.</p>	Alert	The transmitter was unable to receive the calibration BG meter readings from the pump.	<ul style="list-style-type: none"> • Select OK to clear the alert. • Check the status icons on the Home screen to confirm that the pump has a signal from the sensor. If there is no sensor signal, see <i>Sensor issues</i>, page 279. • For SG readings to be monitored without interruption, enter or confirm a BG meter reading by the time displayed on the pump screen.
<p>No calibration occurred Confirm sensor signal. Check BG again to calibrate sensor.</p>	Alert	The transmitter was unable to receive the required calibration BG meter readings from the pump. Calibration is required by the system for SG readings to resume. “Calibration required” appears on the sensor graph.	<ul style="list-style-type: none"> • Select OK to clear the alert. • Take another BG meter reading and calibrate again.
<p>Possible signal interference Move away from electronic devices. May</p>	Alert	There may be interference from another electronic device that is affecting the communication between	<ul style="list-style-type: none"> • Move away from other electronic devices. It can take up to 15 minutes for the pump to start communicating with the transmitter. • Select OK to clear the alert.

Title and text	Type	Explanation	Next steps
take 15 minutes to find signal.		the pump and the transmitter.	
Rise Alert Sensor glucose rising rapidly.	Alert	The SG reading has been rising as fast or faster than the preset Rise Alert limit.	<ul style="list-style-type: none"> • Select OK to clear the alert. • Check BG using a meter. • Follow instructions from a healthcare professional.
Sensor connected If new sensor, select Start New. If not, select Reconnect.	Message	The transmitter has detected that a sensor is connected. The pump needs to know if this is a new sensor or if an old sensor has been reconnected.	<ul style="list-style-type: none"> • If a new sensor has been connected, select Start New Sensor. • If a sensor that was already being used has been reconnected, select Reconnect Sensor. • In either case, a “Sensor warm up X:XX hr” message appears for two hours. After the warm up, the pump starts receiving SG readings.
Sensor connected Start new sensor.	Message	The pump has detected that this is a new sensor, which needs to be started and warmed-up.	<ul style="list-style-type: none"> • Select Start New Sensor. • The alert closes and a “Warm-up” message appears on the sensor graph with a progress bar.
Sensor expired Insert new sensor.	Alert	The sensor has reached the end of its useful life.	<ul style="list-style-type: none"> • Change the sensor. For details, see the sensor user guide. • Select OK to clear the alert.
Sensor signal not found See User Guide.	Alert	After multiple attempts, the pump failed to detect the transmitter and is unable to receive sensor signal.	<ul style="list-style-type: none"> • Select OK to clear the alert. • If the pump still cannot find the sensor signal, contact 24-Hour Technical Support for assistance.
Sensor updating Updating can take up to 30 more minutes. Monitor BG. Entered BGs will not calibrate the sensor, but can still be used for therapy.	Alert	The SG reading is unavailable due to a temporary situation.	<ul style="list-style-type: none"> • Select OK to clear the alert. • Follow the instructions on the pump screen. The sensor does not need to be changed.

Title and text	Type	Explanation	Next steps
Sensor updating Updating can take up to 1 hour. Monitor BG. Entered BGs will not calibrate the sensor, but can still be used for therapy.	Alert	The SG reading is unavailable due to a temporary situation.	<ul style="list-style-type: none"> • Select OK to clear the alert. • Follow the instructions on the pump screen. The sensor does not need to be changed.
Sensor updating Updating can take up to 90 more minutes. Monitor BG. Entered BGs will not calibrate the sensor, but can still be used for therapy.	Alert	The SG reading is unavailable due to a temporary situation.	<ul style="list-style-type: none"> • Select OK to clear the alert. • Follow the instructions on the pump screen. The sensor does not need to be changed.
Sensor updating Updating can take 90 more minutes. Monitor BG. Entered BGs will not calibrate the sensor, but can still be used for therapy.	Alert	The SG reading is unavailable due to a temporary situation.	<ul style="list-style-type: none"> • Select OK to clear the alert. • Follow the instructions on the pump screen. The sensor does not need to be changed.
Sensor updating Updating can take up to 2 hours. Monitor BG. Entered BGs will not calibrate the sensor, but can still be used for therapy.	Alert	The SG reading is unavailable due to a temporary situation.	<ul style="list-style-type: none"> • Select OK to clear the alert. • Follow the instructions on the pump screen. The sensor does not need to be changed.
Sensor updating Updating can take 2 hours. Monitor BG. Entered BGs will not calibrate the sensor, but can still be used for therapy.	Alert	The SG reading is unavailable due to a temporary situation.	<ul style="list-style-type: none"> • Select OK to clear the alert. • Follow the instructions on the pump screen. The sensor does not need to be changed.
Suspend before low Delivery stopped. Sensor glucose approaching Low Limit. Check BG.	Alert	The SG reading is falling. Insulin delivery is suspended according to the Suspend before low setting and the SG is approach-	<ul style="list-style-type: none"> • Select OK to clear the alert. • Check BG. If necessary, treat BG as directed by a healthcare professional.

Title and text	Type	Explanation	Next steps
		ing the specified low limit. The Suspend before low feature is not available with the SmartGuard feature.	
Suspend on low Delivery stopped. Sensor glucose XX mg/dL. Check BG.	Alarm	The SG reading is at or below the specified low limit. The Suspend on low feature is not available with the SmartGuard feature.	<ul style="list-style-type: none"> Select OK to clear the alarm. Check BG. If necessary, treat BG as directed by a healthcare professional.
Transmitter battery depleted Recharge transmitter now.	Alert	The battery in the transmitter needs to be recharged. SG readings cannot be recorded or transmitted until the transmitter is recharged.	<ul style="list-style-type: none"> Select OK to clear the alert. Recharge the transmitter.

SmartGuard feature alerts and messages

The following table lists the most common or serious alerts and messages related to the SmartGuard feature. The table also explains the meaning, consequences, and the reasons why these notifications appear, and provides any necessary steps for problem resolution.

Title and text	Type	Explanation	Next steps
SmartGuard started Current action canceled.	Alert	An operation that is not allowed while transitioning to the SmartGuard feature has been selected.	<ul style="list-style-type: none"> Select OK to clear the alert. Allow the pump to complete its transition to the SmartGuard feature.
SmartGuard exit Basal xxxx started. Would you like to review the SmartGuard Checklist?	Alert	The pump has exited the SmartGuard feature because: <ul style="list-style-type: none"> the sensor has been turned off the pump has been delivering 	<ul style="list-style-type: none"> Select No to clear the alert. Select Yes to view the SmartGuard Checklist. Enter a BG meter reading. Follow instructions from a healthcare professional and continue to monitor BG.

Title and text	Type	Explanation	Next steps
		<p>basal insulin based on insulin delivery history, and not SG readings for the maximum of four hours.</p> <p>This alert cannot be silenced, and is always active whenever the system is using the SmartGuard feature.</p>	<p>For details, see <i>Exiting the SmartGuard feature, page 199</i> and <i>Returning to the SmartGuard feature after an exit, page 199</i>.</p>
<p>SmartGuard exit Insulin delivery is still suspended.</p>	Alert	<p>The pump has exited the SmartGuard feature because:</p> <ul style="list-style-type: none"> • the sensor has been turned off • a suspend event message has not been cleared within four hours • the pump has been delivering basal insulin based on insulin delivery history, and not SG readings for the maximum of four hours. <p>This alert cannot be silenced, and is always active whenever the system is using the SmartGuard feature.</p>	<ul style="list-style-type: none"> • Enter a BG meter reading. • Manually resume basal insulin delivery, when appropriate. • Follow instructions from a healthcare professional and continue to monitor BG. <p>For details, see <i>Exiting the SmartGuard feature, page 199</i> and <i>Returning to the SmartGuard feature after an exit, page 199</i>.</p>

Title and text	Type	Explanation	Next steps
Enter BG now SmartGuard has been at maximum delivery rate for 7 hours. Enter BG to continue in SmartGuard.	Alert	SmartGuard has been delivering at the maximum SmartGuard basal delivery rate for seven hours. This rate is determined automatically by the system.	<ul style="list-style-type: none"> Select OK to clear the alert. Enter a BG meter reading to return to Auto Basal. Follow instructions from a healthcare professional and continue to monitor BG.
Enter BG now SmartGuard has been at maximum delivery rate for 7 hours. Enter BG to continue in SmartGuard. This event occurred while pump was suspended, and action is required to resume delivery.	Alert	The pump is suspended and the SmartGuard feature has been unable to lower the SG reading. SG is predicted to remain above the SmartGuard target.	<ul style="list-style-type: none"> Select OK to clear the alert. Enter a BG meter reading. Follow instructions from a healthcare professional and continue to monitor BG.
Notes:			
<ul style="list-style-type: none"> The title of the alert appears the same as the previous SmartGuard max delivery alert in the table. If the pump is suspended, there will be no delivery. However, the alert may still occur. 			
Enter BG now SmartGuard has reached the time limit for minimum delivery rate. Enter BG to continue in SmartGuard.	Alert	The SmartGuard feature has reached the time limit for minimum delivery. The minimum delivery time is three to six hours, depending on the reason for the minimum delivery rate.	<ul style="list-style-type: none"> Select OK to clear the alert. Enter a BG meter reading to return to Auto Basal. Follow instructions from a healthcare professional and continue to monitor BG.
Enter BG now SmartGuard has reached the time limit for minimum delivery rate. Enter BG to continue in SmartGuard. This event occurred while pump was suspended, and action is required to resume delivery.	Alert	SmartGuard has reached the time limit for minimum delivery. The minimum delivery time is three to six hours, depending on the reason for the minimum delivery rate.	<ul style="list-style-type: none"> Select OK to clear the alert. Enter a BG meter reading. Follow instructions from a healthcare professional and continue to monitor BG.

Title and text	Type	Explanation	Next steps
Notes:			
<ul style="list-style-type: none"> The title of the alert appears the same as the previous SmartGuard min delivery alert in the table. If the pump is suspended, there will be no delivery. However, the alert may still occur. 			
Enter BG now Enter BG to continue in SmartGuard.	Alert	The SmartGuard feature requires a BG reading to check the reliability of the sensor.	<ul style="list-style-type: none"> Select OK to clear the alert. Enter a BG meter reading to return to Auto Basal, or to enter the SmartGuard feature from Manual mode.
High BG XXX mg/dL Check infusion set. Check ketones. Monitor BG. Confirm BG?	Alert	The BG meter reading is above 250 mg/dL. This alert applies only to the SmartGuard feature. There is a similar alert for Manual mode when the SmartGuard feature is off. See <i>SmartGuard</i> , page 179.	<ul style="list-style-type: none"> Select No to prevent the remote BG from being used by the pump. Select Yes to confirm the BG reading.

CareLink software alert and message

The following table lists the most common or serious alerts and messages related to CareLink software. The table also explains the meaning, consequences, and the reasons why these notifications appear, and provides steps for problem resolution. If an alarm, alert, or message occurs that is not listed, select **OK** to clear the notification and contact 24-Hour Technical Support.

Title and text	Type	Explanation	Next steps
CareLink uploader not found. Follow instructions on the CareLink uploader.	Message	The pump cannot find the CareLink uploader because the wrong pump code was entered, or the search timed out before the pump found the uploader.	<ul style="list-style-type: none"> Select OK to clear the message. Follow the instructions on the CareLink uploader. For details, see <i>Uploading device data to CareLink software</i>, page 142.

Title and text	Type	Explanation	Next steps
<p>Download slow Insulin delivery not affected. CareLink download may take longer than usual. Select OK to continue. See User Guide.</p>	Alert	<p>The download of pump data is taking longer than expected. Data will not be affected.</p>	<ul style="list-style-type: none"> • Select OK to clear the alert. • Wait for the data to finish downloading. • If problem still persists or if there is no progress in download, call 24-Hour Technical Support for assistance.

Appendix B: Product specifications



Appendix B: Product specifications

This appendix provides detailed product specifications.

Specifications and default settings

Alarm and alert escalation

The following alerts may escalate to a siren if not cleared:

- Alert before high
- Alert before low
- Alert on high
- Alert on low
- Basal delivery resumed
- BG not received
- Calibration not accepted
- Change sensor
- Enter BG now
- Lost sensor signal
- No calibration occurred
- Possible signal interference
- High SG
- Rise Alert
- Sensor expired
- Sensor signal not found
- Low SG XX mg/dL (XX is a value below 64 mg/dL)
- Sensor updating
- Warm up not started

The MiniMed 780G insulin pump may generate a siren if the alert is not cleared within ten minutes. Before ten minutes, the pump beeps, vibrates, or both, depending on the sound and vibration settings.

Minutes	Sound	Vibration	Sound and vibration
0-5	Beep	Vibrate	Beep and vibrate
6-9	Beep and vibrate	Sound and vibrate	Beep and vibrate
10	Siren and vibrate	Siren and vibrate	Siren and vibrate



Note: The Medical device alarm plays a siren when this screen appears.

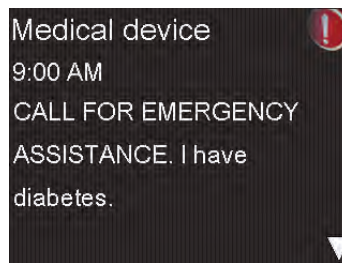

Altitude range

- Operating range: 10.2 psiA (70.33 kPa) to 15.4 psiA (106.18 kPa)
- Storage range: 7.2 psiA (49.64 kPa) to 15.4 psiA (106.18 kPa)

Backlight

Type	LED (Light-emitting Diode)
Time out	15 seconds (default), 30 seconds, one minute, three minutes
Time out when battery is low	15 seconds (default), 30 seconds

Basal delivery

Delivery rate range	0 to 35 units per hour or the Max Basal Rate amount, whichever is lower.
Max Basal Rate default	2 units per hour

Basal patterns	Maximum of 8 patterns. Each pattern covers a 24-hour period and can have up to 48 rates. Rates are set in 30-minute increments.
Basal pattern names	Fixed names: Basal 1, Basal 2, Basal 3, Basal 4, Basal 5, Workday, Day Off, Sick Day
Increments	<ul style="list-style-type: none"> • 0.025 units per hour for basal amounts in the range 0 to 0.975 units • 0.05 units per hour for basal amounts in the range 1 to 9.95 units • 0.1 units per hour for basal amounts of 10 to 35 units

BG meter reading

The BG meter reading refers to the most recent blood glucose (BG) meter reading received from the blood glucose meter. When an Accu-Chek™* Guide Link meter is used, the reading appears on the Home screen when the Sensor feature is off. The reading also appears in the Bolus Wizard screen when a bolus is programmed.

Expiration	12 minutes
Range	20 to 600 mg/dL

Bolus delivery

Bolus Speed options	<ul style="list-style-type: none"> • Standard: 1.5 units/minute • Quick: 15 units/minute
Bolus programming increments	<ul style="list-style-type: none"> • 0.025 units • 0.05 units • 0.1 units
Fluid delivered/stroke	<ul style="list-style-type: none"> • 0.25 μL (microliter) for 0.025 unit pump stroke • 0.5 μL for 0.05 unit pump stroke • 2.0 μL for 0.2 unit pump stroke

Bolus Wizard feature default settings



Note: When using the SmartGuard feature, the Bolus Wizard feature is called the Bolus feature.

Item	Default	Limits	Maximum available segments	Increments
Carb units	grams	-	8	-
Insulin to carb ratio	None	1–200 g/U	8	0.1 g/U for 1–9.9 g/U; 1 g/U for ratios of 10 g/U to 200 g/U
Insulin Sensitivity Factor*	None	5–400 mg/dL	8	1 mg/dL
BG Target*	None	60–250 mg/dL	8	1 mg/dL
Active Insulin Time	4 hours	2 to 8 hours	1	15 minutes

*Applies to Manual mode only.

Bolus Wizard feature specifications

The Bolus Wizard feature uses four formulas to estimate a bolus, depending on the current BG reading. The following formulas apply only when the carb units are in grams.

1. If the current BG reading is higher than the High BG Target, the Bolus Wizard feature subtracts active insulin from the BG correction estimate, then adds this value to the food estimate to get the total bolus estimate. However, if the result of subtracting the active insulin amount from the BG correction estimate is a negative number (less than zero), the total bolus estimate is based only on the food estimate.

$$\text{total bolus estimate} = \frac{\text{(food estimate)}}{B} + \frac{\text{(correction estimate)}}{E} - \text{active insulin}$$

where: A = food (grams)
 B = carb ratio
 C = current BG
 D = High BG Target
 E = insulin sensitivity

Food estimate:

Carb grams ÷ Carb ratio = Units of insulin

Correction estimate:

(Current BG - High BG Target) ÷ Insulin sensitivity - Active insulin = Units of insulin

Total bolus estimate:

Food estimate + Correction estimate = Units of insulin

- If the current BG is less than the Low BG Target, the Bolus Wizard feature adds the BG correction estimate to the food estimate to get the total bolus estimate.

$$\text{total bolus estimate} = \frac{\text{(food estimate)}}{B} + \frac{\text{(correction estimate)}}{E}$$

where: A = food (grams)
 B = carb ratio
 C = current BG
 D = Low BG Target
 E = insulin sensitivity

Food estimate:

Carb grams ÷ Carb ratio = Units of insulin

Correction estimate:

(Current BG - Low BG Target) ÷ Insulin sensitivity = Units of insulin

Total bolus estimate:

Food estimate + Correction estimate = Units of insulin

3. If the current BG reading is within the High or Low BG Target, the total bolus estimate is based only on the food estimate.

$$\text{total bolus estimate} = \frac{\text{(food estimate)} \times \text{food (grams)}}{\text{carb ratio}}$$

Food estimate:

Carb grams ÷ Carb ratio = Units of insulin



Note: When the current BG reading is below the Low BG Target, an active insulin amount is not considered in the Bolus Wizard feature calculations.

Total bolus estimate = Food estimate

4. If no BG reading is entered, the total bolus estimate is based only on the food estimate.

The following list includes additional conditions to consider when using the Bolus Wizard feature.

- If a Dual Wave bolus amount is less than the estimate due to the Max bolus limit or a change that is made, the Square portion of the bolus is reduced first.
- Active insulin is the bolus insulin that has been delivered by the pump and is still working to lower glucose levels. In the Bolus Wizard and SmartGuard Bolus feature, the Active Insulin Time setting is used to calculate a correction bolus by subtracting the estimated active insulin from each bolus. This is shown as Active Insulin, or Act. Insulin, on the Home screen, Bolus screen, Manual Bolus screen, Preset Bolus screen, and Daily History screen. This prevents over-infusion of insulin and reduces the risk of hypoglycemia.

- The Bolus Wizard feature may use the current BG reading, carb units, and active insulin to calculate the estimated bolus.
- The Active Insulin Curve graph shows how the Active Insulin Time setting affects the active insulin amount that is subtracted from correction boluses over time. The percentage of insulin remaining changes at varying rates depending on the Active Insulin Time setting.

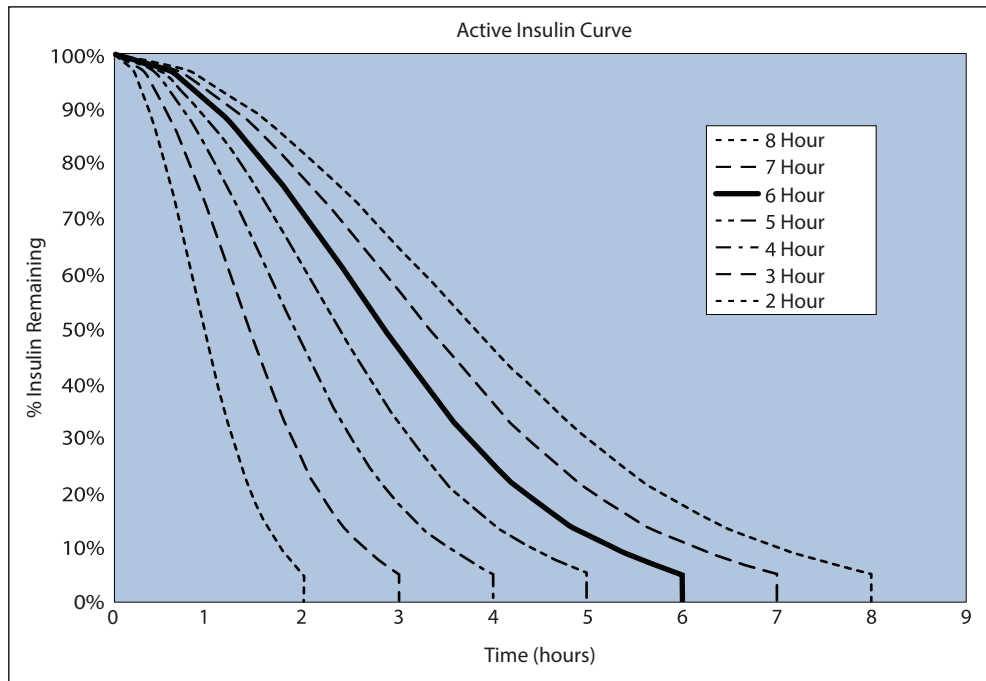

Graph adapted from Mudaliar and colleagues, Diabetes Care, Volume 22, Number 9, Sept. 1999, page 1501.

Carb ratios

Maximum ratio settings	Range
8	1 to 200 g/U

Delivery accuracy

- For a basal rate of 1.0 U/hr, the delivery accuracy is $\pm 5\%$.
For a basal rate of 0.025 U/hr, the delivery accuracy is $\pm 10\%$.

Delivery accuracy for bolus volumes < 0.1 unit is $\pm 20\%$ and delivery accuracy for bolus volumes ≥ 0.1 unit is $\pm 5\%$.

- All normal boluses are delivered within 16 minutes, 41 seconds ± 3 seconds at Standard rate (25 units, at 1.5 units per minute), and within 1 minute, 41 seconds ± 3 seconds at Quick rate (25 units, at 15 units per minute).
- During delivery, the maximum infusion pressure generated and the occlusion threshold pressure using a 3.0-mL reservoir is 13.15 psi (90.67 kPa). The average resulting bolus volume generated upon clearing the occlusion is 0.0112 mL (equivalent to 1.12 units of U-100 insulin).
- The following image is a representative delivery accuracy curve. The Trumpet Curve represents the maximum percentage change from the expected insulin dosage for a given time interval, known as the observation window, during the infusion of insulin. The upper curve corresponds to positive changes, and the lower curve corresponds to negative changes.

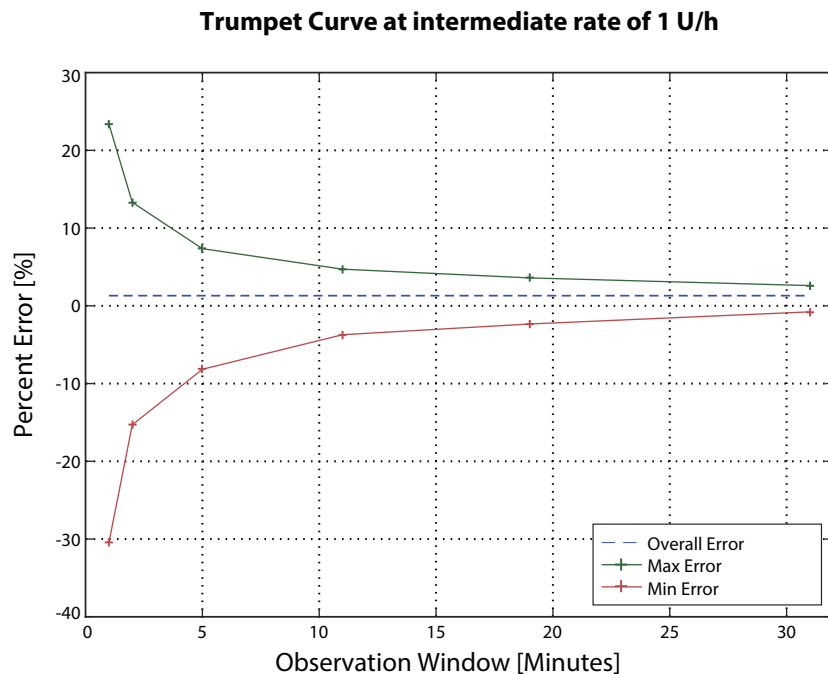

Easy bolus feature

Use the Easy bolus feature to set up and deliver a normal bolus when the pump is in Sleep mode. This is done using \wedge and with the help of sound and vibration cues.

Sound mode range	0 to 20 increments or Max bolus limit, whichever comes first
Vibrate mode range	0 to 20 increments or Max bolus limit, whichever comes first
Default step size	0.1 unit
Adjustable step size	0.1 to 2 units per increment up to Max bolus limit

Environmental conditions

The MiniMed 780G system is designed to withstand most conditions encountered in daily life. For more details about environmental conditions, such as exposure to magnetic fields and radiation, waterproof capabilities, and extreme temperatures, see *User safety, page 32*.

- Pump storage and transport temperature range without a AA battery is from -4 °F (-20 °C) to 122 °F (50 °C).
- Pump operating temperature range is from 41 °F (5 °C) to 98.6 °F (37 °C).
- Operating air pressure range is from 10.2 psi (700 hPa) to 15.4 psi (1060 hPa).
- Storage and transport air pressure range is from 7.2 psi (496.4 hPa) to 15.4 psi (1060 hPa).
- Relative humidity (RH) range during operation is from 20% to 90%.
- RH range during storage and transport is from 5% to 95%.

Essential performance

The pump will maintain the following functionalities to avoid under-infusion and over-infusion:

- Delivery accuracy
- Occlusion detection
- Empty reservoir detection

- Detection of power loss
- Pump therapy status–UI component: LCD
- Notification annunciation and display–UI components: piezo-electric speaker, LCD–applies to all features above

Expected service life

The overall expected service life for the MiniMed 780G insulin pump is four years when used in accordance with this guide.

If there are concerns that the insulin pump may be damaged, contact 24-Hour Technical Support.

For additional information, see *Pump issues, page 275*.

For health-related questions or concerns, consult a healthcare professional.

Filling the infusion set and cannula

- The cannula can be filled from 0.025 units to 5.1 units, in increments of 0.025 units.
- The standard fill rate is 1.5 units per minute.
The quick fill rate is 15 units per minute.
- When filling the tubing, a warning occurs at 30 units. A second warning occurs at 40 units indicating that the pump must be rewound.
- Insulin used to fill the infusion set is recorded in the Daily History. This insulin is NOT included in the Total Daily Delivery (TDD) totals on the Summary screen.

Infusion pressure

The maximum infusion pressure and occlusion pressure during the fill tubing process are 25 psi (172.4 kPa).

Insulin delivery default settings

Bolus settings

Item	Default setting	Limits	Increments
Bolus Wizard feature:	Off	-	-

Item	Default setting	Limits	Increments
Easy bolus feature:	Off	-	-
Easy bolus step size:	0.1 U	0.1 U to 2 U	-
Bolus increment:	0.10 U	0.025 U 0.05 U 0.10 U	-
Dual/Square bolus:	Off	-	-
Max bolus:	10 U	0 to 25 U (per single bolus)	-
Bolus BG Check Reminder:	Off	0:30 to 5:00	0:30

Basal settings

Item	Default setting	Limits	Increments
Max Basal Rate	2 U/hr	0–35 U/hr	0.025 U for 0.025–0.975 U/hr 0.05 U for 1.00–9.95 U/hr 0.1 U for rates of 10.0 U/hr or more
Basal Rate	0.000 U/hr	0.000 U/hr to Max basal rate setting	0.025 U for 0.025–0.975 U/hr 0.05 U for 1.00–9.95 U/hr 0.1 U for rates of 10.0 U/hr or more
Temp Basal Type	Percent	Percent, Rate	N/A
Temp Basal Percent	100%	0–200%	5%
Temp Basal Rate	Current basal rate	0.0 U/hr to Max Basal Rate	0.025 U for 0.025–0.975 U/hr

Item	Default setting	Limits	Increments
			0.05 U for 1.00–9.95 U/hr 0.1 U for rates of 10.0 U/hr or more

Low Reservoir reminder

The values are based on amount shown, not actual amount.

Alert range	Increment	Default value
The first reminder occurs at 5 to 50 units. The second reminder occurs at half of the remaining specified amount. The second reminder is automatic and cannot be changed.	1 unit	20 units

Max bolus

Range	0 to 25 units
Default	10 units

Normal bolus

Range is 0.025 to 25 units of insulin, and limited by the Max bolus setting.

Occlusion detection

When occlusion is detected, the Insulin flow blocked alarm occurs. The occlusion alarm is triggered by an average of 2.23 units of missed insulin (standard bolus) or 1.97 units of missed insulin (quick bolus). This table shows occlusion detection for four different situations when using U-100 insulin.

Rate	Minimum time before alarm	Average time before alarm	Maximum time before alarm
bolus delivery (10 units at standard speed)	71 seconds	95 seconds	136 seconds
bolus delivery (10 units at quick speed)	9 seconds	10 seconds	14 seconds

Rate	Minimum time before alarm	Average time before alarm	Maximum time before alarm
basal delivery (1.0 U/hr)	2.00 hours	2.50 hours	3.80 hours
basal delivery (0.025 U/hr)	123.38 hours	142.03 hours	178.33 hours



Note: Certain factors, such as ambient temperature changes or the presence of air in the infusion set or the reservoir, can delay an occlusion alarm.

Percent temp basal

The default value is 100 percent of basal programming. For example, if six units of basal insulin are delivered per day, the default temp basal amount will be six units per day.

Range	0 to 200%
Default	100% of basal programming
Increment	5%

Program safety checks

A single fault condition causes the pump to suspend insulin delivery. Maximum infusion with a single fault condition is 0.2 units.

Pump dimensions

The pump dimensions in inches are no greater than 3.81 length x 2.18 width x 1.01 depth.

The pump dimensions in centimeters are no greater than 9.68 length x 5.36 width x 2.49 depth.

Pump memory

User settings and pump history are stored in pump memory. The pump keeps at least 35 days of history.

Pump weight

The mass of the insulin pump without battery and consumables is less than 106 grams.

Sensor default settings

High sensor settings			
Item	Default setting	Limits	Increments
High SG alert limit	250 mg/dL	100 to 400 mg/dL	5 mg/dL
High SG fixed alert	On (cannot be turned off)	250 mg/dL for 3 hours	-
Alert before high	Off	-	-
Alert on high	Off	-	-
Time before high	15 minutes	5 to 30 minutes	5 minutes
Rise Alert	Off	-	-
Rise Limit	Two up arrows	<ul style="list-style-type: none"> • 1 up arrow (1 mg/dL/min) • 2 up arrows (2 mg/dL/min) • 3 up arrows (3 mg/dL/min) • Custom limit (1.0 to 5.0 mg/dL/min) 	
High Snooze	1 hour	5 minutes to 3 hours	5 minutes
Low sensor settings			
Item	Default setting	Limits	Increments
Low SG alert limit	60 mg/dL	50 to 90 mg/dL	5 mg/dL
Low SG alarm	On (cannot be turned off)	64 mg/dL	-
Suspend before low	Off	-	-
Suspend on low	Off	-	-

Low sensor settings			
Item	Default setting	Limits	Increments
Alert before low	Off	-	-
Alert on low	Off	-	-
Low Snooze	20 minutes	5 minutes to 1 hour	5 minutes
Resume basal alert	Off	-	-

The SmartGuard feature settings			
Item	Default setting	Limits	Increments
SmartGuard	Off	-	-
Target	100 mg/dL	100 to 120 mg/dL	10 mg/dL
Auto Correction	On	120 mg/dL	-
Temp Target	Off	150 mg/dL	-
Temp Target Duration	2 hours	30 minutes to 24 hours	30 minutes

Sound frequency

The following table lists audible tones that the pump emits, and their corresponding frequencies:

Tone name	Frequency
Alarm	1655 Hz followed by 3310 Hz
Alternate Alarm	1850 Hz
Siren (escalated alarm)	1655 Hz, followed by 3310 Hz
Alert	934 Hz
High SG	1312 Hz, followed by 1410 Hz, 1500 Hz, 1619 Hz, 1722 Hz
Low SG	1722 Hz, 1619 Hz, 1500 Hz, 1410 Hz, 1312 Hz
Lost SG	1485 Hz, followed by 1395 Hz, 1320 Hz, 1395 Hz

Tone name	Frequency
Message tone	1655 Hz
Suspend message tone	2100 Hz, followed by 1800 Hz and 2100 Hz
Reminder tone	934 Hz
Fill tubing tone	1850 Hz
Bolus delivery cancellation tone	1485 Hz, followed by 1655 Hz and 1485 Hz
Loading complete tone	934 Hz
Reservoir loading in progress tone	1850 Hz
Easy bolus activation	1045 Hz
Easy bolus step 1 increment	1175 Hz
Easy bolus step 2 increment	1320 Hz
Easy bolus step 3 increment	1395 Hz
Easy bolus step 4 increment	1570 Hz
Easy bolus step 5 increment	1760 Hz

IEC 60601-1

IEC 60601-1-2, Special EMC Precautions for Medical Electrical Equipment

1. Special Precautions regarding Electromagnetic Compatibility (EMC): This body worn device is intended to be operated within a reasonable residential, domestic, public or work environment, where common levels of radiated "E" (V/m) or "H" fields (A/m) exist; such as cellular phones that are not paired with the MiniMed 780G system, Wi-Fi™* networks, Bluetooth™* wireless technology, electric can openers, microwave and induction ovens. This device generates, uses, and can radiate radio frequency energy and, if not installed and used in accordance with the provided instructions, may cause harmful interference to radio communications.
2. Portable and mobile RF communications equipment can affect Medical Electrical Equipment as well. If RF interference from a mobile or stationary RF transmitter is encountered, move away from the RF transmitter that is causing the interference.

IEC 60601-1

The MiniMed 780G system should not be used adjacent to other electrical equipment. If adjacent use becomes necessary, the MiniMed 780G system should be observed to confirm normal system operation.

IEC 60601-1-10: PCLCS

The MiniMed 780G is a Physiological Closed-Loop Controlled system (PCLCS).

Auto Mode manages basal delivery using a closed loop control algorithm based on a Proportional Integral Derivative controller with insulin feedback (PID-IFB). The PID-IFB monitors the Rate Of Change (ROC) of sensor glucose (SG) and calculates the insulin volume using the Insulin On Board (IOB) and the reported Carbs. The closed loop controller uses continual feedback of SG values to calculate the insulin delivery rate for basal insulin control. The control algorithm is part of the pump application code. SG values are received by the pump via RF from the CGM sensor. This theory of operation is described in the following block diagram.

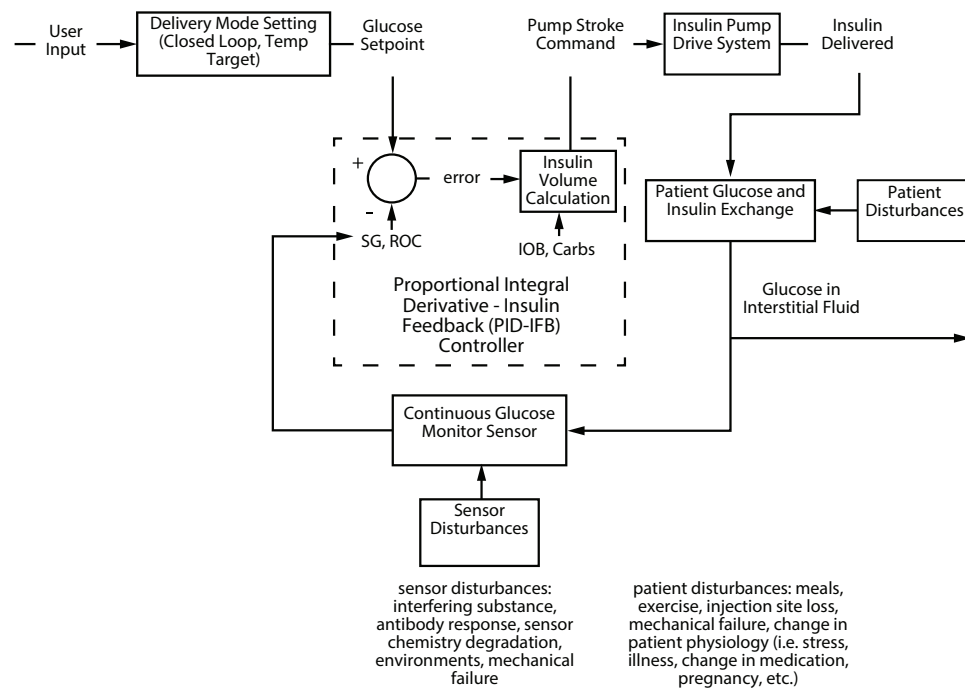

Guidance and manufacturer's declaration

Guidance and Manufacturer's Declaration - Electromagnetic Emissions		
The MiniMed 780G insulin pump is intended for use in the electromagnetic environment specified below. Make sure that the MiniMed 780G insulin pump is used in such an environment.		
Emissions Test	Compliance	Electromagnetic Environment - Guidance
RF emissions Test: 47 CFR Part 15, Subpart C Section 15.247/FCC Part 15 Subpart B Section 15.109	<ul style="list-style-type: none"> • 6 dB and 99% Bandwidths: Complies • Maximum Output Power: Complies • TX Spurious Emissions: Complies • Power Spectral Density: Complies • Radiated Emissions at Band Edge: Complies 	The MiniMed 780G insulin pump must emit electromagnetic energy in order to perform its intended function. Nearby electronic equipment may be affected.
Harmonic emissions IEC 61000-3-2	Not applicable	
Voltage fluctuations/flicker emissions IEC 61000-3-3	Not applicable	
RF emissions CISPR 11 (2009)+A1	Complies Group 1 Class B	The MiniMed 780G insulin pump is suitable for use in aircraft and in all establishments, including domestic and those directly connected to the public low-voltage power supply network that supplies buildings used for domestic purposes.
RTCA DO 160G (2010) 20.5 and 21.5	Complies	

Guidance and Manufacturer's Declaration - Electromagnetic Immunity			
The MiniMed 780G insulin pump is intended for use in the electromagnetic environment specified below. Make sure that the MiniMed 780G insulin pump is used in such an environment.			
Immunity Test	IEC 60601-1-2 Test Level	Compliance Level	Electromagnetic Environment - Guidance
Electrostatic discharge (ESD) IEC 61000-4-2, 60601-1-2	±8 kV contact ±2, 4, 8, 15 kV air	±8 kV contact ±2, 4, 8, 15 kV air	For use in a typical domestic, commercial, or hospital environment.
Conducted disturbances induced by RF fields	3 V _{RMS} 150 kHz to 80 MHz 6 V _{RMS} ISM bands between 150 kHz to 80 MHz	Not applicable	Requirement does not apply to this battery powered device.
Electrical fast transient/burst IEC 61000-4-4	±2 kV 100 kHz repetition frequency	Not applicable	Requirement does not apply to this battery powered device.
Surge IEC 61000-4-5	Line to Line: ±0.5 kV, ±1 kV Line to Ground: ±0.5 kV, ±1 kV, ±2 kV	Not applicable	Requirement does not apply to this battery powered device.
Voltage dips, short interruptions, and voltage variations on power supply lines IEC 61000-4-11	0% U _T ; 0.5 cycle (at 0°, 45°, 90°, 135°, 180°, 225°, 270°, and 315°) 0% U _T ; 1 cycle (at 0°) 70% for 25/30 cycles (at 0°)	Not applicable	Requirement does not apply to this battery powered device.

Guidance and Manufacturer's Declaration - Electromagnetic Immunity			
	0% for 250/300 cycles		
Power frequency (50/60 Hz) electromagnetic field IEC 61000-4-8, IEC 60601-1-2	30 A/m (continuous field at 60 seconds)	30 A/m 400 A/m per IEC 60601-2-24	Power frequency magnetic fields should be at levels characteristic of a typical location in a typical commercial or hospital environment.
Proximity fields from RF wireless communications equipment IEC 61000-4-3	IEC 60601-1-2	IEC 60601-1-2	For use in a typical domestic, commercial, or hospital environment.
Note: U_T is the a.c. mains voltage prior to application of the test level.			

Guidance and Manufacturer's Declaration - Electromagnetic Immunity			
The MiniMed 780G insulin pump is intended for use in the electromagnetic environment specified below. The customer or user of the MiniMed 780G insulin pump should assure that it is used in such an electromagnetic environment.			
Immunity Test	IEC 60601-1-2 Test Level	Compliance Level	Electromagnetic Environment Guidance
Radiated RF IEC 61000-4-3 IEC 60601-1-2 EN 301 489-17	10 V/m 80 MHz to 2.7 GHz 80% AM at 1 kHz	10 V/m 80 MHz to 2.7 GHz 80% AM at 1 kHz	Portable and mobile RF communications equipment should be used no closer to any part of the MiniMed 780G insulin pump, including cables, than the recommended separation distance of 12 in (30 cm). Field strengths from fixed RF transmitters, as determined by an electromagnetic site survey, should be less than

Guidance and Manufacturer's Declaration - Electromagnetic Immunity			
			<p>the compliance level in each frequency range.</p> <p>Interference may occur in the vicinity of equipment marked with the following symbol:</p> 

Wireless communication

The MiniMed 780G insulin pump communicates using smart device connectivity.

Operating frequency/Modulation type(s)	2.4 GHz band, GFSK
Effective radiated power (ERP)	1.48 mW (1.69 dBm)
Effective isotropic radiated power (EIRP)	2.42 mW (3.83 dBm)

FCC notice

This device complies with the United States Federal Communications Commission (FCC) and international standards for electromagnetic compatibility. This device complies with Part 15 of the FCC Rules. Operation is subject to the following two conditions: (1) This device may not cause harmful interference, and (2) this device must accept any interference received, including interference that may cause undesired operation. These standards are designed to provide reasonable protection against excessive radio frequency interference, and to prevent undesirable operation of the devices from unwanted electromagnetic interference.



Note: This equipment has been tested and found to comply with the limits for a Class B digital device, pursuant to Part 15 of the FCC rules. These limits are designed to provide reasonable protection against harmful interference in a residential installation. This equipment generates, uses, and can radiate radio frequency energy and, if not installed and used in accordance with the instructions, may cause harmful interference to radio communications. However, there is no guarantee that interference will not occur in a particular installation. If this equipment does cause harmful interference to radio or television reception, which can be determined by turning the equipment off and on, the user is encouraged to try to correct the interference by one or more of the following measures:

- Reorient or relocate the receiving antenna.
- Increase the separation between the equipment and receiver.
- Decrease the distance between the transmitter and the insulin pump to 6 feet (1.8 meters) or less.
- Decrease the distance between the meter and the insulin pump to 6 feet (1.8 meters) or less.
- Increase the separation between the transmitter and the device that is receiving/emitting interference.

IMPORTANT: Do not change or modify the internal RF transmitter or antenna unless expressly approved by Medtronic Diabetes. Doing so could interfere with your ability to operate the equipment.



Note: Harmful interference is defined by the FCC as follows. Any emission, radiation or induction that endangers the functioning of a radio navigation service or of other safety services or seriously degrades, obstructs or repeatedly interrupts a radio communications service operating in accordance with FCC rules.

Open Source Software disclosure

This document identifies the Open Source Software that may be separately called, executed, linked, affiliated, or otherwise utilized by this product.

Such Open Source Software is licensed to users subject to the terms and conditions of the separate software license agreement for such Open Source Software.

Use of the Open Source Software shall be governed entirely by the terms and conditions of such license.

The source and object code, and applicable license for any Open Source Software can be obtained at the following site(s):

- LZ4-compression library (v1.9.1): <http://www.lz4.org>
- SWIG (v3.0.12): <http://www.swig.org>
- FNV-1 hash algorithm (v5.1): <http://www.isthe.com/chongo/tech/comp/fnv/> and <http://www.isthe.com/chongo/src/fnv/fnv64.c>
- CRC32 algorithm:
<https://opensource.apple.com/source/xnu/xnu-792.13.8/bsd/libkern/crc32.c>

Icon glossary

For a definition of the symbols displayed on the device and package labels, please see <http://www.medtronicdiabetes.com/symbol-definitions>.



Appendix C: Menu map

Menu map

The following diagrams provide a map to the screens and features that are available from the Menu screen.

<div style="background-color: #4CAF50; color: white; padding: 5px; display: flex; justify-content: space-between; align-items: center;"> 1 </div> <p>Insulin</p> <p>Bolus/Stop Bolus*</p> <ul style="list-style-type: none"> • Bolus Wizard • Manual Bolus • Preset Bolus* • Delivery Settings ➔ <p>Basal/Cancel Temp Basal*</p> <ul style="list-style-type: none"> • Temp Basal • Preset Temp* • Basal Patterns • Basal Pattern Setup ➔ <p>Suspend All Delivery/Resume Basal*</p> <p>Delivery Settings ➔</p>	<div style="background-color: #4CAF50; color: white; padding: 5px; display: flex; justify-content: space-between; align-items: center;"> 2 </div> <p>History & Graph</p> <p>History</p> <ul style="list-style-type: none"> • Summary • Daily History • Alarm History • Paired Sensors <p>Sensor Glucose Review</p> <ul style="list-style-type: none"> • High Limit • Low Limit • Days to Average <p>Graph</p> <p>Time in Range</p>	<div style="background-color: #2196F3; color: white; padding: 5px; display: flex; justify-content: space-between; align-items: center;"> 3 </div> <p>SmartGuard</p> <p>SmartGuard Checklist</p> <p>Temp Target/Cancel Temp Target*</p> <p>SmartGuard Settings</p> <ul style="list-style-type: none"> • Target • Auto Correction <p>SmartGuard (On and Off)</p> <div style="background-color: #9C27B0; color: white; padding: 5px; display: flex; justify-content: space-between; align-items: center; margin-top: 10px;"> 4 </div> <p>Sound & Vibration</p> <p>Silence Sensor Alerts</p> <p>Volume</p> <p>Sound</p> <p>Vibration</p> <p>Alert Settings ➔</p> <div style="background-color: #F44336; color: white; padding: 5px; display: flex; justify-content: space-between; align-items: center; margin-top: 10px;"> 5 </div> <p>Blood Glucose</p> <p>BG</p>
<p>* indicates an item that is shown when applicable. For example, Stop Bolus is shown when a bolus is being delivered. Preset Bolus is shown when the Preset Bolus feature is set up.</p> <p>The ➔ icon indicates a shortcut to the screen.</p>		

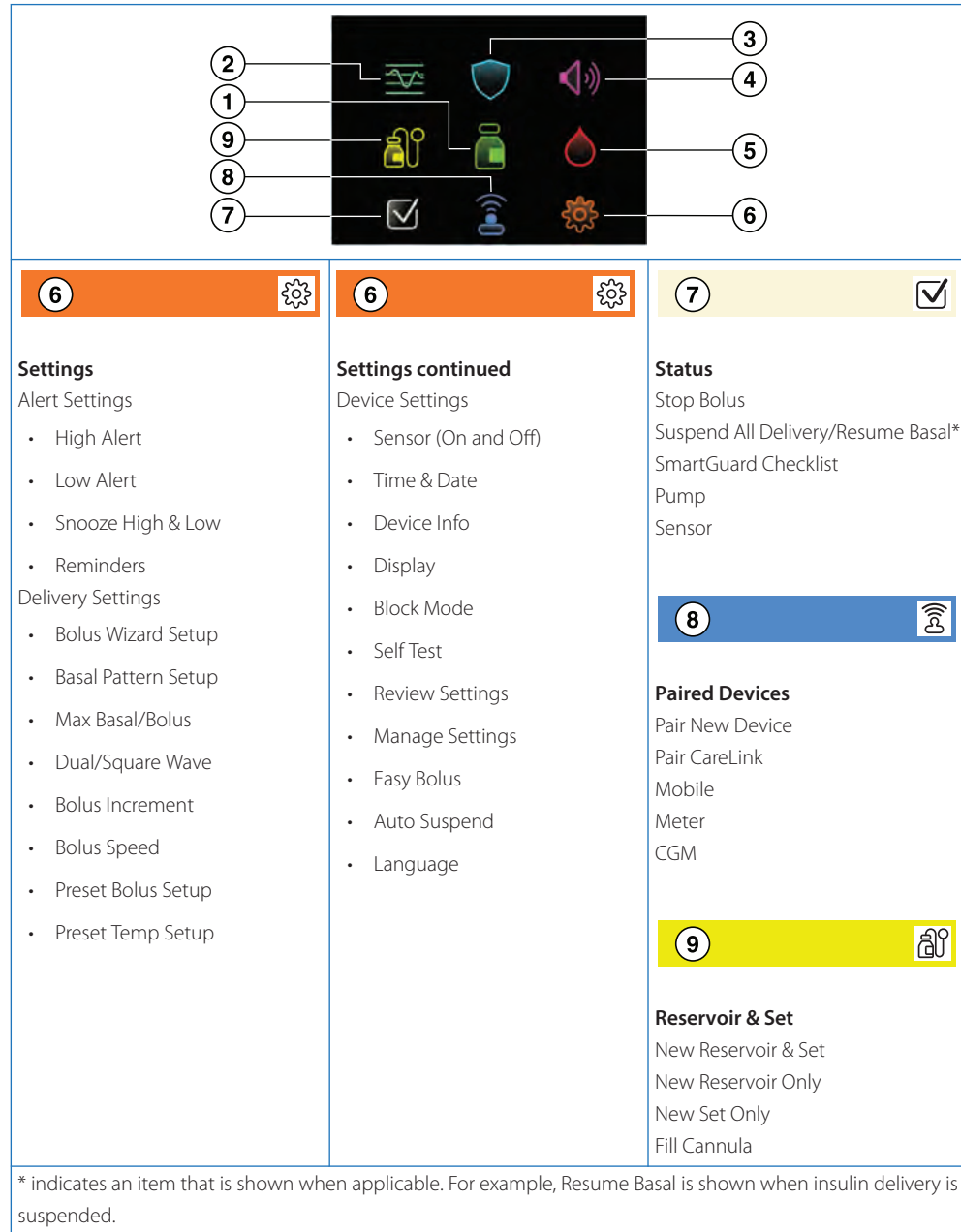

Appendix D: Performance data



Appendix D: Performance data

MiniMed 780G system device performance

The MiniMed 780G system adjusts insulin delivery based on sensor glucose (SG) values from CGM, while alleviating the complexity of trying to maintain glucose levels around meals. Clinical studies have shown that integrated insulin pump and CGM systems may provide better diabetes management, compared with multiple daily injections, or with a pump alone. Studies suggest that pump therapy, when regulated by sensor information, can improve HbA1C levels significantly without increasing the risk of hypoglycemia.^{4,5,6}

The MiniMed 780G system continues to use the SmartGuard feature, which automatically adjusts basal insulin dosage every five minutes, delivering more or less insulin when it predicts that SG values are trending too high or too low. In addition, the system offers the following new features:

1. **Adjustable glycemic target settings.** With the help of a healthcare provider, patients can program the device to one of three setpoints to target their ideal SG

⁴ Bergenstal RM, Tamborlane WV, Ahmann A, et al. Effectiveness of sensor-augmented insulin-pump therapy in type 1 diabetes [STAR3 Study]. *N Engl J Med.* 2010;363:311–320.

⁵ Battelino T, Conget I, Olsen B, et al. The use and efficacy of continuous glucose monitoring in type 1 diabetes treated with insulin pump therapy [SWITCH study]. *Diabetologia.* 2012 Dec;55(12):3155-62. doi: 10.1007/s00125-012-2708-9. Epub 2012 Sept 11.

⁶ Bergenstal RM, Klonoff DC, Bode BW, et al. Threshold-based insulin-pump interruption for reduction of hypoglycemia [ASPIRE in-home study]. *N Engl J Med.* 2013;369(3):224-232.

value (100, 110, or 120 mg/dL). The device uses the programmed setpoint as a reference to adjust the rate of insulin delivered.

2. **Automatic correction boluses.** Mealtimes can be stressful and require that patients calculate boluses prior to and after meals to avoid hyperglycemia. The SmartGuard feature also includes an Auto correction feature that can calculate and deliver correction boluses every five minutes if the patient underestimates the amount of carbs in a meal or if they accidentally forget to deliver a meal bolus prior to eating.

The MiniMed 780G system includes some features that were introduced in prior Medtronic insulin pumps, referred to as the Suspend on low and Suspend before low features. These features temporarily stop insulin delivery when SG values reach a preset low target (Suspend on low) or are predicted to reach the preset low target within 15 or 30 minutes (Suspend before low). Insulin delivery also resumes when SG values return to a safe range. These optional features are available when the pump is in Manual mode and function as a backup for the SmartGuard feature.

The SmartGuard feature

Clinical study overview

The SmartGuard feature (that controls insulin dosing in the MiniMed 780G system) was studied with subjects who wore the MiniMed 670G Version 4.0 pump with the Guardian Sensor (3) at home for three months. This clinical study evaluated the safety of the system and did not include a control group. The study included subjects from different clinics around the US who were between 7 and 75 years old. Subjects had to have been diagnosed with type 1 diabetes mellitus for at least one year for subjects aged 7 to 13 years, and at least two years for subjects aged 14 to 75 years. All subjects in the study had to have used pump therapy for at least 6 months prior to screening and had an HbA1C value of less than 10.0% at the time of screening.

This study started with a run-in (baseline) period, during which the MiniMed 670G Version 4.0 system was used in Manual mode, or with the SmartGuard feature turned ON and the Auto correction feature turned OFF. The run-in period included 299

⁷ Medtronic Inc., Clinical Study Report: CIP321 Data Analysis for Subjects 7-17 Years Old and 18-75 Years Old, D00340772/B. May 2021.

subjects, and 275 of these subjects completed the study period. The system was tested for 37,705 patient days. The mean percent SG values in specific glucose ranges for the MiniMed 780G system with the Guardian Sensor (3) are provided in *Table 3*.

The MiniMed 780G system is compatible with the Guardian 4 Sensor, but the clinical study tested similar earlier-generation devices. The study included a continued access phase whereby subjects transitioned from the MiniMed 670G 4.0 system to the MiniMed 780G system with Guardian 4 transmitter and Guardian 4 Sensor. The only data reported herein for the MiniMed 780G system with Guardian 4 transmitter and Guardian 4 sensor is provided in *Table 4*. The devices tested are considered clinically equivalent,^{8,9,10} therefore, the study results are comparable for the MiniMed 780G system. The key differences were:

MiniMed 670G Version 4.0 insulin pump – the study used this pump to evaluate the SmartGuard feature. This pump is similar to the MiniMed 780G insulin pump, except that it did not yet have the latest Bluetooth capability, the new user interface, the new 110 mg/dL setpoint, the new standard low glucose alert threshold, and the new SG range.

Guardian Sensor (3) – the study used this CGM to evaluate the SmartGuard feature. This CGM is similar to the Guardian 4 CGM except that it did not yet have the latest sensor algorithm (which does not require fingerstick calibration), the new low glucose standard alert threshold, and the new SG range.

⁸ Medtronic Inc., Engineering Report: Performance Evaluation Based on Data Collected During the CIP324 Study Using the C Algorithm, D00355118/A. Jan 2021.

⁹ Medtronic Inc., Engineering Report: Comparison between Zeus and C Algorithms in the CIP324 Study, D00408700/A. Feb 2021.

¹⁰ Medtronic Inc., Engineering Report: Evaluation of GST5G (Zeus) for Closed Loop (CL) Systems Use and Comparison of Insulin Delivery between AHCL with Sensor Data from GST3C and GST5G, D00409589/A. Feb 2021.



CAUTION: Since the clinical study supporting approval of MiniMed 780G did not include a control group, in general, conclusions regarding effectiveness cannot be drawn from the US pivotal clinical study.

Safety

Table 1 lists the device-related adverse events reported during the different phases of the clinical trial. No device-related serious adverse events, no diabetic ketoacidosis, and one episode of severe hypoglycemia (which was not device-related) were reported during the study.

Table 1. Device-related adverse events

Event	Age 7-17 Years (N = 179)			Age 18-75 Years (N = 150)		
	Prior to run-in	Run-in period	Study period	Prior to run-in	Run-in period	Study period
Bleeding at sensor site	0	0	2	0	0	0
Bleeding from infusion site	0	0	0	0	0	1
Bruise on upper arm	0	0	1	1	0	0
Discomfort with sensor insertion	0	1	0	0	0	0
Erythema abdomen from old sensor site	0	0	0	0	1	0
Gastroenteritis ^a	0	0	1	0	0	0
Hyperglycemia	0	2	2	0	0	0
Infusion set failure	0	0	2	0	0	0
Pump site infection	0	0	1	0	0	0
Rash or contact dermatitis (sensor/tape related)	0	3	1	0	2	2
Severe hypoglycemia	0	7	15	0	1	2
Skin irritation with excoriation	0	0	1	0	0	0

^a This event was described as gastroenteritis combined with hyperglycemia and was classified as possibly device-related due to the concurrent hyperglycemia.

SmartGuard Use

During the study period, subjects used the system with the SmartGuard feature and the Auto correction feature turned ON. Table 2 presents percentage of time that subjects spent using the sensor and the percentage of time spent using the SmartGuard (Auto mode) feature with the Auto correction feature turned ON. This information shows that the SmartGuard feature was ON greater than 90% of the time.

Table 2. Sensor and Auto Mode Usage (Percentage of Time)

Category	Age 7-17 Years (N = 160)	Age 18-75 Years (N = 128)
Time spent using sensor	88.0%	91.2%
Time spent not using sensor	12.0%	8.8%
Time spent in Auto mode	93.5%	95.2%
Time spent in Manual mode	6.5%	4.8%

SmartGuard Performance

Table 3 shows the mean percentage of daily SG values in specific glucose ranges during the run-in and study periods by all subjects using the MiniMed 780G system with Guardian Sensor (3). *Table 4* shows the mean percentage of daily SG values in specific glucose ranges during day 1 of the study period and overall, by all subjects using the MiniMed 780G system with Guardian 4 Sensor. An international group of diabetes experts and the American Diabetes Association (ADA) consider patients in good control when patients are in the target glucose range of 70–180 mg/dL for more than 70% of the day.¹¹ The data in *Table 3* show that using the SmartGuard feature with the Auto correction feature kept SG values in range and reduced time above range that may have been caused by underestimation of meal carbohydrate amounts. Specifically, adult subjects spent more time in range (70–180 mg/dL) and less time in hypoglycemia (<70 mg/dL) and hyperglycemia (>180 mg/dL) during the study period compared with the run-in period. Pediatric subjects spent more time in range (70–180 mg/dL) and less time in hyperglycemia (>180 mg/dL) without increasing time in hypoglycemia (<70 mg/dL) during the study period compared with the run-in period.

Table 3. Mean Percent of SG values in Specific Glucose Ranges (Mean ± SD) with MiniMed 780G/GS3*

Glucose Range (mg/dL)	Age 7-17 Years (N = 160)			Age 18-75 Years (N = 128)		
	Run-in period	Study period (Day 1)	Study period (Overall)	Run-in period	Study period (Day 1)	Study period (Overall)
<50	0.4 ± 0.5	0.5 ± 0.6	0.4 ± 0.4	0.5 ± 0.7	0.4 ± 0.6	0.3 ± 0.4
<54	0.7 ± 0.7	0.7 ± 0.7	0.6 ± 0.5	0.8 ± 1.1	0.7 ± 0.8	0.5 ± 0.6

¹¹ Battelino T, Danne T, Bergenstal RM, et al. Clinical Targets for Continuous Glucose Monitoring Data Interpretation: Recommendations From the International Consensus on Time in Range. *Diabetes Care*. 2019 Aug; 42(8): 1593-1603. doi: 10.2337/ dci19-0028. Epub 2019 Jun 8.

Table 3. Mean Percent of SG values in Specific Glucose Ranges (Mean ± SD) with MiniMed 780G/GS3* (continued)

Glucose Range (mg/dL)	Age 7-17 Years (N = 160)			Age 18-75 Years (N = 128)		
	Run-in period	Study period (Day 1)	Study period (Overall)	Run-in period	Study period (Day 1)	Study period (Overall)
<60	1.2 ± 1.1	1.3 ± 1.1	1.2 ± 0.8	1.4 ± 1.7	1.2 ± 1.2	1.0 ± 0.9
<70	2.7 ± 2.0	3.0 ± 1.8	2.7 ± 1.6	3.4 ± 3.0	2.8 ± 2.2	2.3 ± 1.7
70-180	59.4 ± 11.8	67.9 ± 8.4	70.3 ± 6.5	70.5 ± 9.8	73.5 ± 8.8	75.0 ± 7.2
>180	38.0 ± 12.4	29.2 ± 8.4	27.0 ± 6.7	26.2 ± 10.2	23.7 ± 9.0	22.6 ± 7.4
>250	12.1 ± 7.5	8.5 ± 4.9	7.1 ± 3.8	5.5 ± 4.1	5.1 ± 4.2	4.4 ± 3.0
>350	1.3 ± 1.6	0.8 ± 1.0	0.7 ± 0.8	0.4 ± 0.6	0.4 ± 0.7	0.3 ± 0.4

*The data was collected with patients who wore the MiniMed 670G Version 4.0 pump with the Guardian Sensor (3).

Similarly, the data in *Table 4* show that using the SmartGuard feature with the Auto correction feature kept SG values in range and reduced time above range that may have been caused by underestimation of meal carbohydrate amounts. Specifically, adult subjects spent more time in range (70–180 mg/dL) and less time in hypoglycemia (<70 mg/dL) and hyperglycemia (>180 mg/dL) during the overall study period compared with Day 1 of the study period. Pediatric subjects spent more time in range (70–180 mg/dL) and less time in hyperglycemia (>180 mg/dL) without increasing time in hypoglycemia (<70 mg/dL) during the overall study period compared with Day 1 of the study period.

Table 4. Mean Percent of SG values in Specific Glucose Ranges (Mean ± SD) with MiniMed 780G/G4S*

Glucose Range (mg/dL)	Age 7-17 Years (N = 109)		Age 18-75 Years (N = 67)	
	Study Period (Day 1)	Study Period (Overall)	Study Period (Day 1)	Study Period (Overall)
<50	0.0 ± 0.0	0.0 ± 0.0	0.0 ± 0.0	0.0 ± 0.0
<54	0.5 ± 0.6	0.4 ± 0.4	0.4 ± 0.4	0.3 ± 0.3
<60	1.0 ± 0.9	0.8 ± 0.7	0.7 ± 0.7	0.5 ± 0.5
<70	2.3 ± 1.6	2.2 ± 1.4	1.9 ± 1.4	1.6 ± 1.1
70-180	67.3 ± 9.8	71.5 ± 7.8	72.6 ± 10.8	76.6 ± 9.0
>180	30.4 ± 10.0	26.3 ± 8.1	25.5 ± 11.0	21.8 ± 9.3
>250	9.2 ± 6.3	6.9 ± 4.5	5.7 ± 5.5	4.2 ± 3.8
>350	1.2 ± 2.0	0.7 ± 1.1	0.4 ± 1.0	0.3 ± 0.5

*The data was collected during the continued access phase whereby subjects transitioned from the MiniMed 670G 4.0 system to the MiniMed 780G system with Guardian 4 transmitter and Guardian 4 Sensor.

During the run-in and study periods, subjects performed meal challenges involving eating a meal without giving a meal bolus. These challenges were intended to evaluate how subjects' glucose would respond when a meal dose is sometimes missed. Missed meal boluses when using the SmartGuard feature with the Auto correction feature at

the 100 mg/dL and 120 mg/dL SG setpoints were compared to missed meal boluses when using Manual mode. *Table 5* shows the mean SG values up to two hours before, and 1 to 3 hours after, a regular-sized dinner with a missed meal bolus during the run-in and study periods.

This data shows that using the SmartGuard feature with the Auto correction feature reduced mean SG after meals when meal boluses were missed.

Table 5. Change in Mean SG values before and after a Regular-Sized Dinner with Missed Meal Bolus

Category	Age 7-17 Years (N = 94)			Age 18-75 Years (N = 70)		
	Run-in period	Study period		Run-In Period	Study period	
		Setpoint 100 mg/dL	Setpoint 120 mg/dL		Setpoint 100 mg/dL	Setpoint 120 mg/dL
Mean SG before meal (mg/dL), Mean \pm SD	140.6 \pm 48.0	152.9 \pm 50.5	151.5 \pm 43.6	132.9 \pm 42.3	138.0 \pm 51.5	139.8 \pm 38.7
Mean SG 2 Hours after meal (mg/dL), Mean \pm SD	255.6 \pm 65.0	204.7 \pm 53.8	202.6 \pm 51.4	210.5 \pm 53.3	198.8 \pm 53.3	203.1 \pm 41.6
Change in Mean SG before and after the meal (mg/dL), Mean \pm SD	115.0 \pm 81.6	51.8 \pm 62.3	51.0 \pm 71.3	77.6 \pm 68.5	60.8 \pm 75.0	63.4 \pm 60.7

During the study period, subjects exercised on 3 consecutive days while using the SmartGuard feature with the Auto correction feature at the 100 mg/dL and 120 mg/dL setpoints, and with the Temp Target feature turned ON. Temp Target allows the user to temporarily change the SG setpoint to 150 mg/dL. When Temp Target is enabled, the SmartGuard feature reverts to the previous SG setpoint after the user-set time at the 150 mg/dL setpoint elapses. *Table 6* shows the mean SG values up to two hours before, and 1 to 3 hours after, exercise during the study period only. This data shows that the SmartGuard feature with the Auto correction feature kept subject glucose levels stable during and after exercise.

Table 6. Change in Mean SG values During Exercise

Category	Age 7-17 Years (N = 131)		Age 18-75 Years (N = 115)	
	Setpoint 100 mg/dL	Setpoint 120 mg/dL	Setpoint 100 mg/dL	Setpoint 120 mg/dL
Mean SG before exercise (mg/dL), Mean \pm SD	154.6 \pm 30.0	156.4 \pm 34.8	141.6 \pm 30.3	154.0 \pm 30.9
Mean SG 2 Hours after exercise (mg/dL), Mean \pm SD	149.9 \pm 31.7	151.2 \pm 33.4	134.1 \pm 26.8	141.7 \pm 31.4
Change in Mean SG before and after the exercise (mg/dL), Mean \pm SD	-4.7 \pm 42.1	-5.2 \pm 42.0	-7.5 \pm 36.0	-12.3 \pm 43.1

Figure 1 below shows the percentage of subjects that had an HbA1C that was less than 7% during the run-in (baseline) and study periods. The ADA considers a HbA1C target of less than 7% appropriate for non-pregnant adults and many children.^{12,13} Figure 1 shows that a greater percentage of subjects had an HbA1C that was less than 7% at the end of the study than at baseline.

Figure 1. Percentage of Patients with less than 7% HbA1C

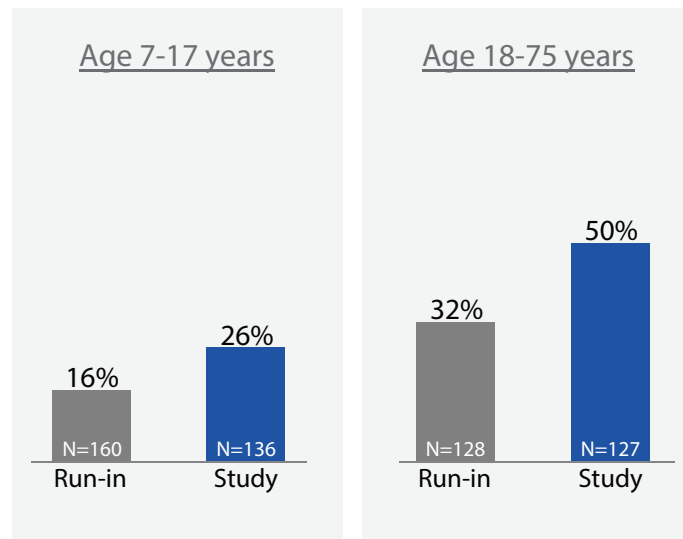

Table 7 shows changes in mean HbA1C, total daily dose of insulin (TDD), and weight, from baseline to the end of the study. Subjects mean HbA1C decreased, and TDD and weight increased slightly. This data helps explain how using the SmartGuard feature with the Auto correction feature might affect a patient's HbA1C, TDD, and weight.

¹² American Diabetes Association. 6. Glycemic Targets: Standards of Medical Care in Diabetes-2020. *Diabetes Care* 2020 Jan; 43 (Supplement 1): S66-S76.
<https://doi.org/10.2337/dc20-S006>

¹³ American Diabetes Association. 13. Children and Adolescents: Standards of Medical Care in Diabetes-2020. *Diabetes Care*. 2020 Jan; 43 (Supplement 1): S163-S182.
<https://doi.org/10.2337/dc20-S013>

Table 7. Changes in Mean HbA1C, TDD, and Weight

Category	Age 7-17 Years		Age 18-75 Years	
	Baseline	End of Study	Baseline	End of Study
HbA1C (%), Mean \pm SD (Median) [N]	7.9 \pm 0.9 (7.9) [160]	7.4 \pm 0.7 (7.3) [136]	7.4 \pm 0.8 (7.5) [128]	6.9 \pm 0.5 (7.0) [127]
TDD (U), Mean \pm SD (Median) [N]	42.3 \pm 19.5 (40.5) [160]	44.9 \pm 20.5 (43.2) [160]	53.7 \pm 27.3 (49.6) [128]	55.4 \pm 30.1 (48.8) [128]
Weight (kg), Mean \pm SD (Median) [N]	45.8 \pm 14.8 (43.1) [160]	48.5 \pm 15.0 (47.4) [136]	83.3 \pm 18.5 (80.2) [128]	84.1 \pm 19.1 (81.2) [121]

The two tables below show the results when subjects pumps were programmed to setpoints of 100 mg/dL (*Table 8*) and 120 mg/dL (*Table 9*), while also programmed to different active insulin times according to the subject's needs. These results show that subjects spent more time in range from programming the setpoint to 100 mg/dL and the active insulin time (AIT) to 2-3 hours.

Table 8 shows that subjects with the AIT set at 2-3 hours and the 100 mg/dL target setpoint spent more time in range (70-180 mg/dL) than subjects with AIT set at any other AIT setting.



Note: The AIT setting in the MiniMed 780G system is not necessarily reflective of the physiologic insulin metabolism. Adjustments are not based on the pharmacokinetics and pharmacodynamics of the rapid-acting insulin.

Table 8. Glycemic Control Outcomes by Active Insulin Time, Setpoint 100 mg/dL^a

Category	Age 7-17 Years			Age 18-75 Years		
	AIT 120-180 minutes	AIT 195-240 minutes	AIT >240 minutes	AIT 120-180 minutes	AIT 195-240 minutes	AIT >240 minutes
Number of Subjects	107	52	2	74	54	4
Overall Average SG (mg/dL)	148.0 \pm 11.8 (147.5)	153.1 \pm 12.7 (151.2)	155.4 \pm 9.1 (155.4)	141.4 \pm 11.2 (141.0)	145.3 \pm 10.4 (144.3)	145.1 \pm 17.3 (150.8)
Overall SD SG (mg/dL)	56.7 \pm 8.9 (56.1)	61.4 \pm 8.7 (60.5)	61.6 \pm 8.8 (61.6)	48.8 \pm 7.9 (48.6)	51.8 \pm 8.1 (50.8)	53.9 \pm 7.8 (54.4)
Overall CV SG (%)	38.2 \pm 4.3 (37.4)	40.0 \pm 4.2 (39.6)	39.5 \pm 3.3 (39.5)	34.4 \pm 4.2 (34.3)	35.6 \pm 4.6 (35.3)	37.1 \pm 1.9 (36.3)
SG < 54 mg/dL (%)	0.7 \pm 0.7 (0.5)	0.8 \pm 0.8 (0.7)	0.3 \pm 0.2 (0.3)	0.7 \pm 0.8 (0.4)	0.6 \pm 0.8 (0.3)	1.4 \pm 1.1 (0.9)
SG < 70 mg/dL (%)	3.1 \pm 2.0 (2.5)	3.5 \pm 2.3 (3.0)	2.3 \pm 0.5 (2.3)	2.9 \pm 2.2 (2.4)	2.7 \pm 2.2 (2.1)	4.8 \pm 3.2 (3.7)
70-180 mg/dL (%)	71.9 \pm 6.9 (72.0)	67.8 \pm 6.8 (68.6)	68.0 \pm 6.5 (68.0)	77.4 \pm 7.4 (77.5)	74.8 \pm 6.9 (75.7)	70.6 \pm 7.9 (70.2)
SG > 180 mg/dL (%)	25.0 \pm 7.1 (24.8)	28.7 \pm 7.5 (27.8)	29.8 \pm 6.0 (29.8)	19.7 \pm 7.5 (19.2)	22.5 \pm 6.9 (21.8)	24.6 \pm 10.1 (26.6)
SG > 250 mg/dL (%)	6.3 \pm 3.9 (5.5)	8.3 \pm 4.3 (7.3)	8.6 \pm 4.0 (8.6)	3.5 \pm 2.8 (3.0)	4.5 \pm 3.0 (4.0)	5.2 \pm 3.5 (5.8)

^a Values are presented by Mean \pm SD (Median) except for number of subjects.

Table 9 shows that subjects with the AIT set at 2-3 hours and the 120 mg/dL target setpoint spent more time in range (70-180 mg/dL) than subjects with the AIT set at any other AIT setting.

Table 9. Glycemic Control Outcomes by Active Insulin Time, Setpoint 120 mg/dL^a

Category	Age 7-17			Age 18-75		
	AIT 120-180 minutes	AIT 195-240 minutes	AIT>240 minutes	AIT 120-180 minutes	AIT 195-240 minutes	AIT>240 minutes
Number of Subjects	122	53	2	76	63	2
Overall Average SG (mg/dL)	153.8 ± 10.3 (153.6)	158.8 ± 11.7 (160.0)	166.9 ± 11.7 (166.9)	148.9 ± 10.8 (148.9)	153.5 ± 10.8 (153.0)	160.8 ± 16.3 (160.8)
Overall SD SG (mg/dL)	55.4 ± 9.0 (54.2)	58.5 ± 8.3 (58.9)	66.2 ± 3.3 (66.2)	47.5 ± 8.0 (46.7)	49.8 ± 8.6 (51.1)	57.0 ± 8.4 (57.0)
Overall CV SG (%)	35.9 ± 4.6 (36.1)	36.8 ± 4.0 (36.6)	39.7 ± 0.8 (39.7)	31.8 ± 4.0 (31.5)	32.4 ± 4.4 (33.1)	35.3 ± 1.6 (35.3)
SG < 54 mg/dL (%)	0.6 ± 0.6 (0.4)	0.6 ± 0.5 (0.4)	0.7 ± 0.7 (0.7)	0.4 ± 0.5 (0.3)	0.4 ± 0.5 (0.2)	0.3 ± 0.3 (0.3)
SG < 70 mg/dL (%)	2.3 ± 1.6 (1.9)	2.2 ± 1.3 (2.0)	2.7 ± 2.0 (2.7)	2.0 ± 1.7 (1.6)	1.7 ± 1.3 (1.5)	1.4 ± 0.4 (1.4)
70-180 mg/dL (%)	71.1 ± 6.6 (70.9)	67.4 ± 7.6 (66.7)	60.6 ± 4.9 (60.6)	75.8 ± 7.2 (75.9)	72.5 ± 8.0 (72.4)	68.1 ± 10.7 (68.1)
SG > 180 mg/dL (%)	26.6 ± 6.8 (26.9)	30.4 ± 7.8 (31.0)	36.7 ± 7.0 (36.7)	22.2 ± 7.6 (21.6)	25.8 ± 8.2 (25.3)	30.5 ± 10.3 (30.5)
SG > 250 mg/dL (%)	6.7 ± 3.8 (5.8)	8.4 ± 4.1 (9.0)	13.2 ± 4.6 (13.2)	4.0 ± 3.0 (3.2)	5.1 ± 3.4 (4.6)	8.3 ± 4.8 (8.3)

^a Values are presented by Mean ± SD (Median) except for number of subjects.

Figure 2 below shows the percentage of subjects that spent more than 70% of time in range (70-180 mg/dL), which is considered good glucose control by diabetes experts and the ADA, during the run-in (baseline) and study periods. The system offers three SG target setpoint options that allow users to customize insulin delivery. For the study period, percentages are shown for subjects that used the SmartGuard feature with the Auto correction feature at the 100 mg/dL and the 120 mg/dL setpoint.

The greatest percentage of subjects spent more than 70% of time in range when using the SmartGuard feature with the Auto correction feature at the 100 mg/dL setpoint compared to use with the 120 mg/dL setpoint or Manual mode. The data shows that using the SmartGuard feature with the Auto correction feature ON at any of the setpoints resulted in subjects spending more than 70% of time in range (70-180 mg/dL) than during run-in. This data also shows that more subjects using the SmartGuard feature with the Auto correction feature at the 100 mg/dL setpoint spent more time in range than at the 120 mg/dL setpoint.

Figure 2. Percentage of Subjects who Spent More than 70% of Time in Range (70-180 mg/dL)

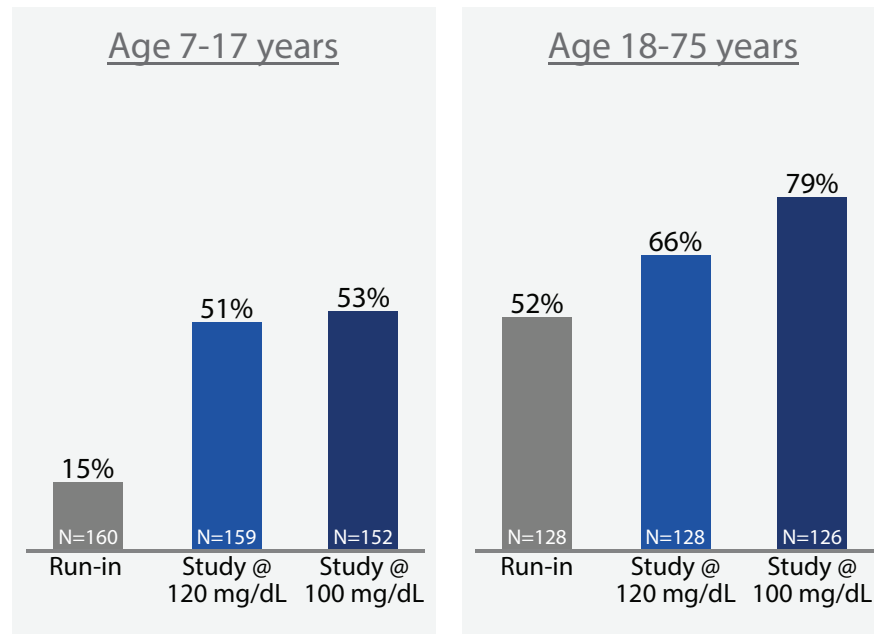

The clinical study suggested that the system was safe, and subjects showed improvements in HbA1C and TIR. However, the study had the following limitation:

It did not compare subjects who were using the Auto correction feature to those who were not on a system (control group). Instead, the study compared how subjects did before using the Auto correction feature (run in period -2 weeks) against results while using the Auto correction feature (study period -3 months).

Due to this limitation, the results of the study should be interpreted with caution and you should understand that your individual results may vary.

The Suspend before low feature

Clinical study overview (Ages 14-75 Years)

The Suspend before low feature was evaluated for safety in a multi-center, single-arm, in-clinic study of the MiniMed 640G System.¹⁴ This feature is the same in the

MiniMed 780G system. Study subjects included persons aged 14 to 75 years diagnosed with type 1 diabetes mellitus who were on pump therapy at the time of screening.

A total of 71 subjects were subjected to hypoglycemic induction, followed by an observation period. For hypoglycemic induction, the target was set to 65 mg/dL, using the rate of change basal increase algorithm. The Suspend before low feature was activated with the Low Limit setting for the Suspend before low feature ON set to 65 mg/dL, and the subject was observed with frequent sample testing (FST, or frequent blood sampling for glucose measurements) for a maximum of 19 hours. The observation period included the suspension period, the insulin resumption period, and if applicable, an insulin resuspension after basal insulin delivery resumed.

Feature performance and safety

Of the 71 subjects with induced hypoglycemia, 69 inductions were successful, 27 subjects experienced a hypoglycemic event and 42 subjects did not. At 120 minutes after the start of the pump suspension events, the mean reference glucose value (measured using a Yellow Springs Instrument [YSI™*]) was 102 ± 34.6 mg/dL.

Five adverse events were reported during the study. Four adverse events were neither device nor procedure related. One adverse event was procedure related.

Data from this in-clinic study demonstrated that the Suspend before low feature is safe to use. Study success criteria, as defined in the protocol, were met (i.e. there were no device related serious adverse events, no diabetic ketoacidosis events related to the Suspend before low feature, and no unanticipated adverse device effects).

Clinical study overview (Ages 7-13 Years)

The Suspend before low feature was also evaluated in a study of the MiniMed 670G system that included subjects 7-13 years, diagnosed with type 1 diabetes mellitus.¹⁵ This feature is the same in the MiniMed 780G system.

¹⁴ Buckingham BA, Bailey TS, Christiansen M, et al. Evaluation of a Predictive Low-Glucose Management System In-Clinic. *Diabetes Technology and Therapeutics*. 2017;19(5):288-292.

¹⁵ Buckingham BA, Bailey TS, Christiansen M, et al. Evaluation of a Predictive Low-Glucose Management System In-Clinic. *Diabetes Technology and Therapeutics*. 2017;19(5):288-292

A total of 105 study subjects were observed overnight after exercise/activity while using the system with the Suspend before low feature activated. The Low Limit setting for the Suspend before low feature turned ON was set to 65 mg/dL and the subjects were observed with FST for a maximum of 12 hours.

Feature performance and safety

In 79.7% of cases, after activation of the Suspend before low feature, the threshold of \leq 65 mg/dL was avoided. Mean glucose levels up to six hours after the suspend feature was activated remained below the starting glucose levels.

Data from this in-clinic evaluation demonstrated that the Suspend before low feature is safe to use in a pediatric population.

Guardian 4 System Performance



Note: You should review the information in this section with your healthcare professional to understand the performance of the Guardian 4 system.

Clinical study overview

The performance of the Guardian 4 system was evaluated using data collected during a multi-center prospective clinical study.¹⁶ The study included participants 7 to 80 years old. Within the 7 to 80 years age range, the study enrolled a total of 308 subjects previously diagnosed with type 1 or 2 diabetes and 267 of these subjects completed the study. Subjects ages 18 and older were instructed to wear a total of three sensors and transmitters in the abdomen and arm. Subjects ages 7 to 17 years old were instructed to wear a total of three sensors and transmitters in the arm and buttock. For all subjects, the transmitters were used to record raw sensor signals during the study and there was no real-time calculation of sensor glucose values.

Frequent sample testing (FST) was performed on four occasions for subjects 14 years and older and on two occasions for subjects 7 to 13 years old.

¹⁶ Medtronic Inc., Performance Evaluation of an Advanced Algorithm with CGM in Adults, Adolescents and Pediatrics 10838519DOC. September 2019.

Reference blood (plasma) glucose values were obtained with a Yellow Springs Instrument (YSI™*) Glucose Analyzer every 5-15 minutes for subjects 7 years and older. During each FST, subjects with an established insulin sensitivity ratio and insulin carbohydrate ratio underwent a hypoglycemic challenge and a hyperglycemic challenge.

Data collected during the study was post-processed after the study using the Guardian 4 system sensor algorithm to convert the raw sensor information to sensor glucose values every five minutes. For the accuracy information presented in the following sections, YSI™* reference values were paired with the closest sensor glucose reading within five minutes of the time of the reference value measurement.

Sensor accuracy

Sensor accuracy was calculated for sensors compared to a YSI™* reference for subjects 7 years and older, in the arm insertion site. The upper arm insertion site showed optimal performance in the clinical study. Do not insert the sensor into any other location.

Table 10. Overall Accuracy Compared to YSI™*

Patient Population	Insertion Site	Number of Subjects	Number of paired SG-YSI™*	Percent of SG within 20/20% of YSI™*	Mean Absolute Relative Difference (%)
Adults (18+)	Arm	153	20612	88.3 (88.0)	10.6
Pediatrics (7-17)	Arm	107	7702	85.6 (85.0)	11.6

*CGM readings are within 50-400 mg/dL, inclusive, which are slightly truncated from GS3 (40-400 mg/dL).

For 20% agreement, 20 mg/dL used when YSI™ <70 mg/dL.

In *Table 11* through *Table 12*, the agreement of the SG values to paired YSI™* values was assessed by calculating the percentage of SG values that were within 15%, 20%, and 40% of the paired YSI™* values. For SG readings less than 70 mg/dL, the absolute difference in mg/dL between the SG and paired YSI™* values was calculated.

Table 11. Overall accuracy of SG-YSI™* paired points within SG ranges; Adults, Arm

CGM Glucose Range (mg/dL)	Number of Subjects	Number of paired CGM-YSI™*	Percent within 15 mg/dL YSI™*	Percent within 20 mg/dL YSI™*	Percent within 40 mg/dL YSI™*	Percent within 15% YSI™*	Percent within 20% YSI™*	Percent within 40% YSI™*	Bias (mg/dL)	MARD (%)
A) < 54 mg/dL	46	252	77.4	87.7	98.0				-9.3	14.9

Table 11. Overall accuracy of SG-YSI™* paired points within SG ranges; Adults, Arm (continued)

CGM Glucose Range (mg/dL)	Number of Subjects	Number of paired CGM-YSI™*	Percent within 15 mg/dL YSI™*	Percent within 20 mg/dL YSI™*	Percent within 40 mg/dL YSI™*	Percent within 15% YSI™*	Percent within 20% YSI™*	Percent within 40% YSI™*	Bias (mg/dL)	MARD (%)
B) 54-69 mg/dL	99	2204	91.0	95.9	99.7				-2.3	10.2
C) 70-180 mg/dL	153	12893				72.7	84.1	98.6	-4.9	11.3
D) 181-250 mg/dL	146	3857				81.6	91.1	99.7	-11.4	9.3
E) > 250 mg/dL	97	1406				86.5	94.5	99.9	-7.3	8.2

* For reference range < 70 mg/dL, agreement was based on 15/20/30/40 mg/dL. CGM readings are within 50-400 mg/dL, inclusive.

Table 12. Overall accuracy of SG-YSI™* paired points within SG ranges; Pediatrics, Arm

CGM Glucose Range (mg/dL)	Number of Subjects	Number of paired CGM-YSI™*	Percent within 15 mg/dL YSI™*	Percent within 20 mg/dL YSI™*	Percent within 40 mg/dL YSI™*	Percent within 15% YSI™*	Percent within 20% YSI™*	Percent within 40% YSI™*	Bias (mg/dL)	MARD (%)
A) < 54 mg/dL	28	103	62.1	78.6	98.1				-13.0	19.4
B) 54-69 mg/dL	53	562	79.2	89.1	98.9				-6.3	12.9
C) 70-180 mg/dL	106	3967				64.6	79.2	98.4	-9.6	13.1
D) 181-250 mg/dL	103	1992				78.6	90.2	99.9	-14.1	9.9
E) > 250 mg/dL	77	1078				86.9	94.4	100.0	-8.0	8.3

* For reference range < 70 mg/dL, agreement was based on 15/20/30/40 mg/dL. CGM readings are within 50-400 mg/dL, inclusive.

* Includes pediatric subjects 7-17 years of age.

Agreement when CGM reads “Below 50 mg/dL” or “Above 400 mg/dL”

The real-time CGM systems display glucose values between 50 mg/dL and 400 mg/dL. It displays “Below 50 mg/dL” when the SG value detected is below 50 mg/dL. It displays “Above 400 mg/dL” when the SG value detected is above 400 mg/dL. *Table 13* and *Table 14* illustrate the number and percentage of the paired YSI™* values in different blood glucose levels when the CGM system displays “Below 50 mg/dL” (LOW) or “Above 400 mg/dL” (HIGH).

Table 13. The number and percentage of YSI™* values collected when CGM displays “Below 50 mg/dL” (LOW)

CGM Display	Population	Insertion Site	CGM-YSI™* pairs	YSI™* (mg/dL)					Total
				<55	<60	<70	<80	≥80	
LOW	Adult	Arm	Cumulative, n	128	263	445	481	9	490
			Cumulative %	26%	54%	91%	98%	2%	
	Pediatrics	Arm	Cumulative, n	51	87	168	194	6	200
			Cumulative %	26%	44%	84%	97%	3%	

*Includes pediatric subjects 7-17 years of age.

Table 14. The number and percentage of YSI™* values collected when CGM displays “Above 400 mg/dL” (HIGH)

CGM Display	Population	Insertion Site	CGM-YSI™* pairs	YSI™* (mg/dL)					Total
				>340	>320	>280	>240	≤240	
HIGH	Adult	Arm	Cumulative, n	20	21	21	21	0	21
			Cumulative %	95%	100%	100%	100%	0%	
	Pediatrics	Arm	Cumulative, n	32	32	32	32	0	32
			Cumulative %	100%	100%	100%	100%	0%	

*Includes pediatric subjects 7-17 years of age.

Concurrence of SG and YSI™* values

Table 15 through *Table 16* show, for each SG range, the percentage of concurring data points where the paired YSI™* values were in different blood glucose ranges.

Table 15. Overall concurrence of YSI™* values and SG readings using SG ranges; Adults, Arm

Percent of matched pairs in each SMBG glucose range for each SG range (mg/dL)												
SG ranges (mg/dL)	Number of paired SG-YSI™*	YSI™* glucose ranges (mg/dL)										
		<50	≥50–60	>60–80	>80–120	>120–160	>160–200	>200–250	>250–300	>300–350	>350–400	>400
A) <50	490	6.7% (33/490)	47.6% (233/490)	43.9% (215/490)	1.8% (9/490)	0.0% (0/490)	0.0% (0/490)	0.0% (0/490)	0.0% (0/490)	0.0% (0/490)	0.0% (0/490)	0.0% (0/490)
B) ≥50–60	1036	7.0% (73/1036)	38.4% (398/1036)	50.8% (526/1036)	3.5% (36/1036)	0.1% (1/1036)	0.2% (2/1036)	0.0% (0/1036)	0.0% (0/1036)	0.0% (0/1036)	0.0% (0/1036)	0.0% (0/1036)
C) >60–80	2899	0.5% (15/2899)	17.8% (517/2899)	69.7% (2022/2899)	11.6% (335/2899)	0.2% (6/2899)	0.1% (4/2899)	0.0% (0/2899)	0.0% (0/2899)	0.0% (0/2899)	0.0% (0/2899)	0.0% (0/2899)
D) >80–120	4334	0.0% (2/4334)	0.7% (31/4334)	12.7% (552/4334)	63.0% (2730/4334)	22.5% (973/4334)	1.0% (43/4334)	0.1% (3/4334)	0.0% (0/4334)	0.0% (0/4334)	0.0% (0/4334)	0.0% (0/4334)
E) >120–160	5123	0.0% (0/5123)	0.0% (0/5123)	0.1% (6/5123)	11.8% (604/5123)	63.8% (3271/5123)	22.0% (1129/5123)	2.0% (105/5123)	0.2% (8/5123)	0.0% (0/5123)	0.0% (0/5123)	0.0% (0/5123)
F) >160–200	3337	0.0% (0/3337)	0.0% (0/3337)	0.0% (0/3337)	0.3% (10/3337)	13.4% (447/3337)	57.5% (1920/3337)	25.7% (856/3337)	2.8% (95/3337)	0.3% (9/3337)	0.0% (0/3337)	0.0% (0/3337)
G) >200–250	2477	0.0% (0/2477)	0.0% (0/2477)	0.0% (0/2477)	0.0% (0/2477)	0.3% (7/2477)	11.7% (291/2477)	61.1% (1514/2477)	23.8% (589/2477)	3.0% (74/2477)	0.1% (2/2477)	0.0% (0/2477)
H) >250–300	895	0.0% (0/895)	0.0% (0/895)	0.0% (0/895)	0.0% (0/895)	0.0% (0/895)	0.0% (0/895)	13.7% (123/895)	56.3% (504/895)	27.7% (248/895)	2.2% (20/895)	0.0% (0/895)
I) >300–350	390	0.0% (0/390)	0.0% (0/390)	0.0% (0/390)	0.0% (0/390)	0.0% (0/390)	0.0% (0/390)	1.0% (4/390)	25.4% (99/390)	55.4% (216/390)	16.7% (65/390)	1.5% (6/390)
J) >350–400	121	0.0% (0/121)	0.0% (0/121)	0.0% (0/121)	0.0% (0/121)	0.0% (0/121)	0.0% (0/121)	0.0% (0/121)	1.7% (2/121)	36.4% (44/121)	51.2% (62/121)	10.7% (13/121)
K) >400	21	0.0% (0/21)	0.0% (0/21)	0.0% (0/21)	0.0% (0/21)	0.0% (0/21)	0.0% (0/21)	0.0% (0/21)	0.0% (0/21)	4.8% (1/21)	52.4% (11/21)	42.9% (9/21)

Table 16. Overall concurrence of YSI™* values and SG readings using SG ranges; Pediatrics, Arm

Percent of matched pairs in each YSI™* glucose range for each SG range (mg/dL)												
SG Ranges (mg/dL)	Number of paired SG-YSI™*	YSI™* glucose ranges (mg/dL)										
		<50	≥50-60	>60-80	>80-120	>120-160	>160-200	>200-250	>250-300	>300-350	>350-400	>400
A) <50	200	11.5% (23/200)	32.5% (65/200)	53.0% (106/200)	2.5% (5/200)	0.5% (1/200)	0.0% (0/200)	0.0% (0/200)	0.0% (0/200)	0.0% (0/200)	0.0% (0/200)	0.0% (0/200)
B) ≥50-60	346	4.0% (14/346)	26.0% (90/346)	64.2% (222/346)	5.2% (18/346)	0.6% (2/346)	0.0% (0/346)	0.0% (0/346)	0.0% (0/346)	0.0% (0/346)	0.0% (0/346)	0.0% (0/346)
C) >60-80	692	0.7% (5/692)	13.4% (93/692)	61.6% (426/692)	23.6% (163/692)	0.7% (5/692)	0.0% (0/692)	0.0% (0/692)	0.0% (0/692)	0.0% (0/692)	0.0% (0/692)	0.0% (0/692)
D) >80-120	1348	0.1% (1/1348)	1.2% (16/1348)	12.5% (168/1348)	57.0% (768/1348)	27.8% (375/1348)	1.4% (19/1348)	0.1% (1/1348)	0.0% (0/1348)	0.0% (0/1348)	0.0% (0/1348)	0.0% (0/1348)
E) >120-160	1529	0.0% (0/1529)	0.0% (0/1529)	0.1% (1/1529)	7.5% (114/1529)	58.3% (891/1529)	30.0% (458/1529)	3.4% (52/1529)	0.8% (12/1529)	0.1% (1/1529)	0.0% (0/1529)	0.0% (0/1529)
F) >160-200	1439	0.0% (0/1439)	0.0% (0/1439)	0.0% (0/1439)	0.1% (1/1439)	9.0% (129/1439)	51.4% (739/1439)	35.9% (516/1439)	3.3% (48/1439)	0.3% (5/1439)	0.0% (0/1439)	0.0% (0/1439)
G) >200-250	1270	0.0% (0/1270)	0.0% (0/1270)	0.0% (0/1270)	0.0% (0/1270)	0.2% (3/1270)	9.9% (126/1270)	59.4% (754/1270)	28.7% (364/1270)	1.8% (23/1270)	0.0% (0/1270)	0.0% (0/1270)
H) >250-300	695	0.0% (0/695)	0.0% (0/695)	0.0% (0/695)	0.0% (0/695)	0.0% (0/695)	0.1% (1/695)	13.1% (91/695)	58.6% (407/695)	25.8% (179/695)	2.4% (17/695)	0.0% (0/695)
I) >300-350	296	0.0% (0/296)	0.0% (0/296)	0.0% (0/296)	0.0% (0/296)	0.0% (0/296)	0.0% (0/296)	1.0% (3/296)	18.9% (56/296)	61.1% (181/296)	18.9% (56/296)	0.0% (0/296)
J) >350-400	87	0.0% (0/87)	0.0% (0/87)	0.0% (0/87)	0.0% (0/87)	0.0% (0/87)	0.0% (0/87)	0.0% (0/87)	5.7% (5/87)	24.1% (21/87)	60.9% (53/87)	9.2% (8/87)
K) >400	32	0.0% (0/32)	0.0% (0/32)	0.0% (0/32)	0.0% (0/32)	0.0% (0/32)	0.0% (0/32)	0.0% (0/32)	0.0% (0/32)	0.0% (0/32)	31.3% (10/32)	68.8% (22/32)

* Includes pediatric subjects 7-17 years of age.

Trend accuracy

Table 17. Trend accuracy compared to YSI™ over time; Adults, Arm

SG Rate Ranges (mg/dL/min)	No. of Paired SG-YSI™	YSI™ (mg/dL/min)					
		<-2	[-2,-1]	[-1, 0]	[0, 1]	(1, 2]	>2
<-2	179	53.6% (96/179)	38.0% (68/179)	7.3% (13/179)	1.1% (2/179)	0.0% (0/179)	0.0% (0/179)
[-2,-1]	1036	5.2% (54/1036)	49.9% (517/1036)	42.3% (438/1036)	2.5% (26/1036)	0.1% (1/1036)	0.0% (0/1036)

Table 17. Trend accuracy compared to YSI™ over time; Adults, Arm (continued)

SG Rate Ranges (mg/dL/min)	YSI™ (mg/dL/min)						
	No. of Paired SG-YSI™	<-2	[-2,-1]	[-1, 0]	[0, 1]	(1, 2]	>2
[-1, 0]	10059	0.2% (17/10059)	4.0% (401/10059)	79.1% (7958/10059)	16.3% (1640/10059)	0.4% (37/10059)	0.1% (6/10059)
[0, 1]	7342	0.0% (3/7342)	0.5% (38/7342)	22.6% (1656/7342)	69.9% (5129/7342)	6.6% (487/7342)	0.4% (29/7342)
(1, 2]	1513	0.0% (0/1513)	0.3% (5/1513)	2.0% (31/1513)	29.5% (446/1513)	58.6% (886/1513)	9.6% (145/1513)
>2	461	0.0% (0/461)	0.0% (0/461)	0.4% (2/461)	4.3% (20/461)	37.5% (173/461)	57.7% (266/461)

CGM readings are within 50-400 mg/dL, inclusive.

Table 18. Trend accuracy compared to YSI™* over time; Pediatrics, Arm

SG Rate Ranges (mg/dL/min)	YSI™* (mg/dL/min)						
	No. of Paired SG-YSI™*	<-2	[-2,-1]	[-1, 0]	[0, 1]	(1, 2]	>2
<-2	196	50.5% (99/196)	41.3% (81/196)	7.1% (14/196)	1.0% (2/196)	0.0% (0/196)	0.0% (0/196)
[-2,-1]	742	6.2% (46/742)	53.6% (398/742)	36.7% (272/742)	2.7% (20/742)	0.7% (5/742)	0.1% (1/742)
[-1, 0]	3103	0.3% (9/3103)	6.5% (201/3103)	76.2% (2363/3103)	15.8% (490/3103)	1.0% (31/3103)	0.3% (9/3103)
[0, 1]	2450	0.0% (0/2450)	0.9% (23/2450)	21.1% (517/2450)	68.6% (1680/2450)	8.9% (218/2450)	0.4% (11/2450)
(1, 2]	851	0.0% (0/851)	0.1% (1/851)	3.1% (26/851)	32.2% (274/851)	55.9% (476/851)	8.7% (74/851)
>2	354	0.0% (0/354)	0.0% (0/354)	0.3% (1/354)	4.2% (15/354)	28.0% (99/354)	67.5% (239/354)

CGM readings are within 50-400 mg/dL, inclusive.

* Includes pediatric subjects 7-17 years of age.

Accuracy over time

Table 19. Sensor Accuracy Compared to YSI™* Over Time; Adults, Arm

Wear Period	Number of paired SG-YSI™*	Percent of SG within 15/15% of YSI™* (%)	Percent of SG within 20/20% of YSI™* (%)	Percent of SG within 40/40% of YSI™* (%)	Mean Absolute Relative Difference (%)
Beginning	5678	65.8	78.3	98.3	13.9
Early Middle	5504	80.9	91	99.7	10.0
Late Middle	5142	81	91.5	99.7	9.7
End	4288	87.5	94.4	99.7	8.3

CGM readings are within 50-400 mg/dL, inclusive.

* For reference range < 70 mg/dL, agreement was based on 15/20/40 mg/dL.

Table 20. Sensor Accuracy Compared to YSI™* Over Time; Pediatrics, Arm

Wear Period	Number of paired SG-YSI™*	Percent of SG within 15/15% of YSI™* (%)	Percent of SG within 20/20% of YSI™* (%)	Percent of SG within 40/40% of YSI™* (%)	Mean Absolute Relative Difference (%)
Beginning	3127	68.5	84.7	99.5	12.8
Early Middle	2546	74.4	85.5	98.9	11.5
Late Middle	1145	74.8	84.3	99.8	10.9
End	884	81.7	91	99.8	9.1

* Includes pediatric subjects 7-17 years of age. CGM readings are within 50-400 mg/dL, inclusive.

* For reference range < 70 mg/dL, agreement was based on 15/20/40 mg/dL.

Precision

Precision of the System was evaluated by comparing the results from two separate sensors worn in the location on the same subject at the same time.

	Number of paired points	Percent Absolute Relative Difference (PARD)	Coefficient of variation (%CV)
7-17 YO Arm	10386	9.48	6.5
18+ YO Arm	23549	9.08	6.5

Sensor Life

Adults (18-75 Years)

77.8% of sensors worn in the arm functioned more than six days and up to the full seven days of wear (144 to 168 hours). The median functional sensor life for sensors worn in the arm insertion site over the course of the study was 167.9 hours, with a mean functional life of 147.9 hours.

Pediatrics (7-17 Years)

61.7% of sensors worn in the arm functioned more than six days and up to the full seven days of wear (144 to 168 hours). The median functional sensor life for sensors worn in the arm insertion site over the course of the study was 163.7 hours, with a mean functional life of 138.9 hours.

Safety

There were no device-related or procedure-related serious adverse events, or unanticipated adverse device effects after seven days of use.

Alert performance

CGM enables a device to display SG readings, glucose trend arrows, glucose trend graphs, and SG alerts, for example, High and Low Sensor Glucose alerts, High and Low Predicted alerts, and Rise and Fall alerts for rate-of-change.

The high and low SG alerts (**Threshold alerts**) let the user know when the SG is at or above the high limit or at or below the low limit. Using only a high or low Threshold alert may reduce the number of false alerts, but does not provide a warning before reaching a high or low limit. The default alert thresholds are highlighted in gray below.

Predictive alerts notify users that their SG level may soon reach a high or low limit setting. Users may select how early they would like to be notified before their SG level reaches a high or low limit. The earliest warning is 60 minutes before reaching a high or low limit, but users can reduce the amount of warning down to 10 minutes. Users receive a Predictive alert when their SG level is predicted to reach their high or low limit in the Time Before High or Time Before Low setting they select. In general, the earlier the warning, the more time a user has to react to a potential high or low, but this also increases the potential for false alerts.

A predictive alert is simply an estimation of a future SG level compared to the high or low limit setting. If the predicted future SG value is above the high limit or below the low limit, then a predictive alert is sounded even though the current SG level has not crossed the high or low limit. The predicted SG level is calculated using the current SG level, the derivative of current and previous SG readings (the trend or slope of the SG readings) and the Time Before High or Time Before Low duration the user selects.

The device always alerts the user with a Low SG alarm when the CGM reads that the user is below 64 mg/dL, regardless of the high/low threshold and/or predictive alerts that the user sets.

Glucose TRUE Alert Rate

The glucose true alert rate is the rate at which the blood glucose (BG) confirmed that the CGM alert was triggered correctly. For example:

- **True Threshold Hypoglycemic alert rate** is a measure of how often the CGM read that the user was below the low threshold and the user's BG was actually below that low threshold.

- **True Threshold Hyperglycemic alert rate** is a measure of how often the CGM read that the user was above the high threshold and the user's BG was actually above that high threshold.
- **True Predictive Hypoglycemic alert rate** is a measure of how often the CGM predicted that the user would reach below the low threshold and the user's BG was actually below that low threshold within 15 or 30 minutes.
- **True Predictive Hyperglycemic alert rate** is a measure of how often the CGM predicted that the user would reach above the high threshold and the user's BG was actually above that high threshold within 15 or 30 minutes.

The true alert rate is important because it is necessary that users be notified when their blood glucose is low (or high) so that they can correct the low (or high) blood glucose. A high true alert rate indicates that when the CGM says that their glucose values are, or will reach a specified threshold, the user's blood glucose is likely to be at or approaching that threshold.

For example, per the following table, the low glucose alerts would have correctly indicated that the user was below (i.e. threshold only), or predicted to reach below the threshold (i.e. predictive only) or both (predictive and threshold) 85.9%, 64.1%, or 72.4% of the time within 30 minutes (or 85.9%, 60.3% or 70.1% of the time within 15 minutes) when the user had BG values lower than 70 mg/dL for a sensor inserted in the arm.

Table 21. Glucose TRUE Alert Performance, Adults

Glucose TRUE Alert Rate							
mg/dL	Insertion Site	Threshold Only		Predictive Only		Threshold and Predictive	
		30 min	15 min	30 min	15 min	30 min	15 min
50	Arm	27.3%	25.8%	28.3%	19.9%	28.0%	21.6%
60*	Arm	73.3%	71.9%	57.4%	53.0%	63.2%	59.9%
64	Arm	83.0%	82.4%	-	-	-	-
70	Arm	85.9%	85.9%	64.1%	60.3%	72.4%	70.1%
80	Arm	81.9%	80.8%	62.2%	58.9%	70.0%	67.6%
90	Arm	77.7%	77.4%	59.8%	57.0%	66.9%	65.1%
180	Arm	87.6%	87.2%	66.4%	64.0%	74.3%	72.7%
220	Arm	86.8%	86.8%	64.2%	62.1%	72.2%	70.9%
250	Arm	87.9%	87.0%	67.3%	62.0%	74.5%	70.8%
300	Arm	88.9%	88.9%	69.5%	65.5%	76.1%	73.5%

*The default alert threshold is highlighted in gray.

Table 22. Glucose TRUE Alert Performance, Pediatrics (7-17 Years of Age)

Glucose TRUE Alert Rate							
mg/dL	Insertion Site	Threshold Only		Predictive Only		Threshold and Predictive	
		30 min	15 min	30 min	15 min	30 min	15 min
50	Arm	23.8%	23.8%	13.3%	9.2%	16.4%	13.6%
60*	Arm	52.8%	52.8%	34.3%	32.9%	40.6%	39.6%
64	Arm	59.2%	59.2%	-	-	-	-
70	Arm	63.0%	63.0%	44.6%	40.8%	51.1%	48.6%
80	Arm	69.1%	69.1%	50.0%	44.5%	57.1%	53.6%
90	Arm	74.4%	72.2%	56.3%	51.7%	63.6%	60.0%
180	Arm	92.2%	92.2%	82.7%	78.3%	86.8%	84.3%
220	Arm	91.3%	90.2%	77.3%	74.0%	83.0%	80.5%
250	Arm	88.4%	88.4%	70.7%	68.4%	77.4%	75.9%
300	Arm	85.2%	85.2%	60.5%	59.9%	68.9%	68.5%

* The default alert threshold is highlighted in gray.

* Includes pediatric subjects 7-17 years of age.

Glucose FALSE Alert Rate

The glucose false alert rate is the rate at which the BG did not confirm that the CGM alert was triggered correctly. For example:

- **False Threshold Hypoglycemic alert rate** is a measure of how often the CGM read that the user was below the low threshold, but the user's BG was actually above that low threshold.
- **False Threshold Hyperglycemic alert rate** is a measure of how often the CGM read that the user was above the high threshold, but the user's BG was actually below that high threshold.
- **False Predictive Hypoglycemic alert rate** is a measure of how often the CGM predicted that the user would be below the low threshold, but the user's BG was actually above that low threshold within 15 or 30 minutes.
- **False Predictive Hyperglycemic alert rate** is a measure of how often the CGM predicted that the user would be above the high threshold, but the user's BG was actually below the high threshold within 15 or 30 minutes.

The false alert rate is important because it is necessary that users be correctly notified when their glucose is low or high so that they can correct the low or high glucose. A low false alert rate indicates that when the CGM says that their glucose values are, or will

reach a specified threshold, the user’s glucose is likely to be at or approaching that threshold.

For example, per the following table, the high glucose threshold alerts would have incorrectly indicated that the user was above (i.e. threshold only), or predicted to reach above the threshold (i.e. predictive only), or both (threshold and predictive) for adult 12.4%, 33.6% or 25.7% of the time within 30 minutes (or 12.8%, 36.0%, or 27.3% of the time within 15 minutes) when the user had BG less than 180 mg/dL for a sensor inserted in the arm.

Table 23. Glucose FALSE Alert Performance, Adults

Glucose FALSE Alert Rate							
mg/dL	Insertion Site	Threshold Only		Predictive Only		Threshold and Predictive	
		30 min	15 min	30 min	15 min	30 min	15 min
50	Arm	72.7%	74.2%	71.7%	80.1%	72.0%	78.4%
60*	Arm	26.7%	28.1%	42.6%	47.0%	36.8%	40.1%
64	Arm	17.0%	17.6%	-	-	-	-
70	Arm	14.1%	14.1%	35.9%	39.7%	27.6%	29.9%
80	Arm	18.1%	19.2%	37.8%	41.1%	30.0%	32.4%
90	Arm	22.3%	22.6%	40.2%	43.0%	33.1%	34.9%
180	Arm	12.4%	12.8%	33.6%	36.0%	25.7%	27.3%
220	Arm	13.2%	13.2%	35.8%	37.9%	27.8%	29.1%
250	Arm	12.1%	13.0%	32.7%	38.0%	25.5%	29.2%
300	Arm	11.1%	11.1%	30.5%	34.5%	23.9%	26.5%

*The default alert threshold is highlighted in gray.

Table 24. Glucose FALSE Alert Performance, Pediatrics (7-17 Years of Age)

Glucose FALSE Alert Rate							
mg/dL	Insertion Site	Threshold Only		Predictive Only		Threshold and Predictive	
		30 min	15 min	30 min	15 min	30 min	15 min
50	Arm	76.2%	76.2%	86.7%	90.8%	83.6%	86.4%
60*	Arm	47.2%	47.2%	65.7%	67.1%	59.4%	60.4%
64	Arm	40.8%	40.8%	-	-	-	-
70	Arm	37.0%	37.0%	55.4%	59.2%	48.9%	51.4%
80	Arm	30.9%	30.9%	50.0%	55.5%	42.9%	46.4%
90	Arm	25.6%	27.8%	43.7%	48.3%	36.4%	40.0%
180	Arm	7.8%	7.8%	17.3%	21.7%	13.2%	15.7%
220	Arm	8.7%	9.8%	22.7%	26.0%	17.0%	19.5%
250	Arm	11.6%	11.6%	29.3%	31.6%	22.6%	24.1%
300	Arm	14.8%	14.8%	39.5%	40.1%	31.1%	31.5%

* The default alert threshold is highlighted in gray.

* Includes pediatric subjects 7-17 years of age.

Glucose Correct Detection Rate

Glucose Correct Detection Rate is the rate that the device alerted when it should have alerted. For example, the BG was below the hypoglycemic threshold, or above the hyperglycemic threshold, and the device sounded an alert.

The correct detection rates are important because it is necessary that users be notified when their glucose is low or high so that they can correct the low or high glucose. A high glucose correct detection rate indicates that users can have confidence that they will be notified by the device if their glucose is low or high.

For example, per the following table, the threshold alert, the predictive alert, or both (threshold and predictive) for adults notified the user 83.0%, 94.2% or 94.4% of the time within 30 minutes (or 81.8%, 90.4% or 91.3% within 15 minutes) when the user had BG less than 180 mg/dL in a sensor inserted in the arm.

Table 25. Glucose CORRECT DETECTION Alert Performance, Adults

Glucose CORRECT DETECTION Alert Rate							
mg/dL	Insertion Site	Threshold Only		Predictive Only		Threshold and Predictive	
		30 min	15 min	30 min	15 min	30 min	15 min
50	Arm	37.5%	35.4%	89.6%	72.9%	89.6%	79.2%
60*	Arm	65.1%	64.0%	86.0%	83.7%	86.6%	84.3%
64	Arm	75.5%	75.0%	-	-	-	-
70	Arm	87.3%	86.8%	94.8%	93.4%	95.3%	94.3%
80	Arm	84.2%	83.1%	91.4%	86.8%	91.4%	88.7%
90	Arm	87.3%	86.3%	93.3%	90.2%	93.7%	91.7%
180	Arm	83.0%	81.8%	94.2%	90.4%	94.4%	91.3%
220	Arm	79.4%	78.3%	92.4%	90.6%	92.7%	90.9%
250	Arm	72.5%	71.1%	88.3%	85.3%	88.3%	86.1%
300	Arm	62.3%	60.1%	83.3%	80.4%	83.3%	80.4%

*The default alert threshold is highlighted in gray.

Table 26. Glucose CORRECT DETECTION Alert Performance, Pediatrics (7-17 Years of Age)

Glucose CORRECT DETECTION Rate							
mg/dL	Insertion Site	Threshold Only		Predictive Only		Threshold and Predictive	
		30 min	15 min	30 min	15 min	30 min	15 min
50	Arm	66.7%	66.7%	86.7%	60.0%	86.7%	73.3%
60*	Arm	64.6%	64.6%	80.0%	75.4%	80.0%	76.9%
64	Arm	74.6%	74.6%	-	-	-	-

Table 26. Glucose CORRECT DETECTION Alert Performance, Pediatrics (7-17 Years of Age) (continued)

Glucose CORRECT DETECTION Rate							
mg/dL	Insertion Site	Threshold Only		Predictive Only		Threshold and Predictive	
		30 min	15 min	30 min	15 min	30 min	15 min
70	Arm	83.3%	81.0%	92.9%	86.9%	92.9%	91.7%
80	Arm	86.6%	85.7%	97.3%	89.3%	97.3%	92.9%
90	Arm	89.9%	87.9%	97.3%	89.9%	98.0%	93.3%
180	Arm	90.3%	89.0%	96.2%	91.3%	96.9%	94.1%
220	Arm	88.0%	84.9%	95.9%	92.1%	96.2%	94.5%
250	Arm	77.1%	74.8%	91.6%	85.0%	91.6%	87.4%
300	Arm	72.2%	72.2%	93.8%	88.7%	93.8%	89.7%

* The default alert threshold is highlighted in gray.

* Includes pediatric subjects 7-17 years of age.

Glucose Missed Detection Rate

The Missed Detection Rate is the rate that the device did not alert when it should have. For example, the BG was below the hypoglycemic threshold, or above the hyperglycemic threshold, and the device did not sound a threshold or predictive alert.

Missed detection rates are important because it is necessary that users be notified when their glucose is low or high, so that they can correct the low or high glucose. A low missed detection rate indicates that users can have confidence that they will be notified by the device if their glucose is low or high.

For example, per the following table, the threshold alert, predictive alert, or both alerts (threshold and predictive) for adults did not sound 12.7%, 5.2% or 4.7% of the time within 30 minutes (or 13.2%, 6.6% or 5.7% within 15 minutes) when the user had BG less than 70 mg/dL in a sensor inserted in the arm.

Table 27. Glucose MISSED Detection Performance, Adults

Glucose Missed Detection Rate							
mg/dL	Insertion Site	Threshold Only		Predictive Only		Threshold and Predictive	
		30 min	15 min	30 min	15 min	30 min	15 min
50	Arm	62.5%	64.6%	10.4%	27.1%	10.4%	20.8%
60*	Arm	34.9%	36.0%	14.0%	16.3%	13.4%	15.7%
64	Arm	24.5%	25.0%	-	-	-	-
70	Arm	12.7%	13.2%	5.2%	6.6%	4.7%	5.7%
80	Arm	15.8%	16.9%	8.6%	13.2%	8.6%	11.3%
90	Arm	12.7%	13.7%	6.7%	9.8%	6.3%	8.3%

Table 27. Glucose MISSED Detection Performance, Adults (continued)

Glucose Missed Detection Rate							
mg/dL	Insertion Site	Threshold Only		Predictive Only		Threshold and Predictive	
		30 min	15 min	30 min	15 min	30 min	15 min
180	Arm	17.0%	18.2%	5.8%	9.6%	5.6%	8.7%
220	Arm	20.6%	21.7%	7.6%	9.4%	7.3%	9.1%
250	Arm	27.5%	28.9%	11.7%	14.7%	11.7%	13.9%
300	Arm	37.7%	39.9%	16.7%	19.6%	16.7%	19.6%

*The default alert threshold is highlighted in gray.

Table 28. Glucose MISSED Detection Performance, Pediatrics (7-17 Years of Age)

Glucose MISSED Detection Rate							
mg/dL	Insertion Site	Threshold Only		Predictive Only		Threshold and Predictive	
		30 min	15 min	30 min	15 min	30 min	15 min
50	Arm	33.3%	33.3%	13.3%	40.0%	13.3%	26.7%
60*	Arm	35.4%	35.4%	20.0%	24.6%	20.0%	23.1%
64	Arm	25.4%	25.4%	-	-	-	-
70	Arm	16.7%	19.0%	7.1%	13.1%	7.1%	8.3%
80	Arm	13.4%	14.3%	2.7%	10.7%	2.7%	7.1%
90	Arm	10.1%	12.1%	2.7%	10.1%	2.0%	6.7%
180	Arm	9.7%	11.0%	3.8%	8.7%	3.1%	5.9%
220	Arm	12.0%	15.1%	4.1%	7.9%	3.8%	5.5%
250	Arm	22.9%	25.2%	8.4%	15.0%	8.4%	12.6%
300	Arm	27.8%	27.8%	6.2%	11.3%	6.2%	10.3%

* The default alert threshold is highlighted in gray.

* Includes pediatric subjects 7-17 years of age.



Glossary

active insulin	Active insulin is bolus insulin delivered by the insulin pump that continues to lower BG levels. Active insulin is not necessarily reflective of the pharmacokinetics and pharmacodynamics of rapid acting insulins.
active insulin time	A Bolus Wizard setting used to indicate length of time that bolus insulin is tracked as active insulin.
activity guard	An attachment that secures the reservoir during activity or when the insulin pump is worn by a child.
alarm	An audible beep or vibration with a message that requires immediate attention.
alarm history	A feature that stores information about recent alarms and alerts.
alert	An audible beep or vibration with a message to inform of a situation that may require attention.
alert before low	An alert that occurs when the low SG reading is being approached.
alert limits	The settings that determine when low and high SG alerts are triggered.
alert on low	An alert that occurs when the SG reading reaches or falls below the low limit.
auto basal	The automatically adjusted basal insulin delivered by the SmartGuard feature based on the current SG readings.
Auto correction	A correction bolus automatically delivered by the MiniMed 780G system to maximize time in range. Auto correction only occurs when using the SmartGuard feature.

auto suspend	A feature that suspends insulin delivery and triggers an alarm if no buttons are pressed for the specified period of time. Insulin delivery resumes when the alarm is cleared.
awake mode	A state in which the pump screen is on. The Home screen appears unless another screen is being used.
basal insulin	Insulin that is continuously delivered by the insulin pump to meet insulin needs between meals and during sleep.
basal pattern	A set of one or more basal rates that covers a 24-hour period.
basal rate	The setting for the amount of continuous basal insulin to be delivered per hour.
BG	The acronym for blood glucose. For more information, see blood glucose (BG) .
BG meter	A device that measures glucose levels in the blood.
BG targets	The high and low BG readings used for BG correction when using the Bolus Wizard feature.
Block mode	A feature that restricts the ability to change all settings. Certain functions can still be performed, such as suspend insulin delivery or clear alarms and alerts.
blood glucose (BG)	Glucose that is present in the blood, commonly measured by a BG meter.
bolus BG check reminder	A reminder for a BG check after programming a bolus. The reminder appears when the specified time period has passed.
bolus insulin	Insulin used to cover an expected rise in BG levels due to carbohydrates, or to lower a high BG reading down to the BG target range.
bolus speed	The delivery speed for bolus insulin.

Bolus Wizard feature	A feature that uses individual Bolus Wizard settings to calculate an estimated bolus amount based on the BG value and the entered carbs. These settings include carb ratio, insulin sensitivity factor, BG target range, and active insulin time.
calibrate	The process of using a blood glucose (BG) meter reading to help the sensor glucose (SG) readings more closely match the glucose measured in your blood.
calibration reminder	A reminder to calibrate the sensor when the next calibration is due. This feature is not applicable when using the Guardian 4 sensor.
cannula	Short, thin, and flexible tube placed in the tissue below the skin. Insulin is delivered through the cannula into the body.
carb ratio	The number of grams of carbohydrates covered by one unit of insulin. The carb ratio is used to calculate bolus amounts.
CDC	The acronym for the Centers for Disease Control.
CGM	The acronym for continuous glucose monitoring. For more information, see continuous glucose monitoring (CGM) .
continuous glucose monitoring (CGM)	A monitoring tool that uses a glucose sensor placed below the skin to continuously measure the amount of glucose in the interstitial fluid.
correction bolus	Insulin used to lower a high BG or SG reading down to a target value.
CT scan	The acronym for computed tomography scan.
daily history	Details of the events entered or actions performed using the insulin pump.
diabetic ketoacidosis	A serious condition that occurs when insulin levels are low, BG levels are elevated, and the body uses fat for energy. This process produces ketones, which upset the acid-base balance in the body, leading to a potentially life-threatening situation.

Dual Wave bolus	A type of bolus that provides a dose of insulin delivered as a combination of a normal bolus followed by a Square Wave bolus.
Easy bolus	A feature that delivers a normal bolus in preset increments using sound or vibrate confirmation.
EMC	The acronym for electromagnetic compatibility.
ESD	The acronym for electrostatic discharge.
FCC	The acronym for the Federal Communications Commission.
FDA	The acronym for the Food and Drug Administration.
food bolus	A dose of insulin given to cover an expected rise in glucose levels from carbohydrates.
GPS	The acronym for global positioning system.
high limit	The setting the insulin pump uses to determine when to alert for a high SG condition.
infusion set	Tubing that connects to the reservoir on one end, and has a needle or cannula on the other end, that is inserted into the body. Insulin travels from the insulin pump through the infusion set into the body.
infusion site	The location on the body where the infusion set is inserted.
insulin sensitivity factor	The amount that BG is reduced by one unit of insulin. The insulin sensitivity factor is used to calculate correction bolus amounts.
interstitial fluid	The fluid that surrounds the cells in the body.
IV	The acronym for intravenous.
lock	A feature that prevents accidental button presses.
low limit	The setting the insulin pump uses to determine when to alert for a low SG condition and suspend insulin delivery.
Manual bolus	A feature to manually enter and deliver a dose of insulin.

Manual mode	Manual mode refers to system functions that are used when the SmartGuard feature is not active.
Max basal rate	The maximum amount of basal insulin that can be delivered per hour.
Max bolus	The maximum bolus amount that can be delivered in one dose.
meter	A term for any BG meter.
missed meal bolus reminder	A reminder when a bolus is not delivered during the specified time period, which is often around meal times.
MRI	The acronym for magnetic resonance imaging.
NiMH	The acronym for nickel-metal hydride.
normal bolus	A type of bolus that provides an entire dose of insulin immediately.
notifications	All notifications are designed to get attention and convey different types of information. They include alarms, alerts, reminders, and messages.
occlusion	A blockage or crimp of the cannula or tubing that prevents proper insulin flow.
piston	The part of the insulin pump that engages the reservoir and moves insulin through the tubing.
power save mode	A state in which the insulin pump is fully functional, but the screen goes dark to save power.
preset bolus	A feature to set up and save a bolus for specific meals or snacks that are frequently consumed.
preset temp basal	A feature to set up and save temporary basal rates for repeated use.
reminder	A type of notification to help remember an action.
reservoir	The small container that is filled with insulin and inserted into the insulin pump.

Resume basal alert	An alert that occurs when the insulin pump has automatically resumed basal insulin delivery after a Suspend before low or Suspend on low event because the SG readings have met the necessary criteria. This alert always occurs if basal insulin delivery has resumed because the two-hour maximum suspend time has elapsed.
rewind	A feature that returns the piston to its start position to place a new reservoir into the insulin pump.
RF	The acronym for radio frequency.
rise alert	An alert that occurs if the SG reading is rising rapidly.
sensitivity	For more information, see insulin sensitivity factor .
sensor (glucose sensor)	The small part of the CGM system that is inserted just below the skin to measure glucose levels in the interstitial fluid.
sensor glucose (SG)	Glucose that is present in the interstitial fluid and is measured by a glucose sensor.
set change reminder	A reminder to change the infusion set.
SG	The acronym for sensor glucose. For more information, see sensor glucose (SG) .
Sleep mode	A state in which the insulin pump is fully functional, but the screen is dark. The insulin pump automatically enters Sleep mode when no buttons are pressed for about two minutes.
SmartGuard bolus feature	A feature that assists to calculate a recommended bolus amount based on optional carbohydrate intake and optional BG or SG measurement. One or both of the two optional values may be entered.
SmartGuard feature	An insulin delivery feature that automatically controls basal insulin delivery to regulate BG levels to a target SG value.
SN	The acronym for serial number.
Square Wave bolus	A bolus delivered evenly over the specified time period.

suspend	Suspend features include the Suspend before low feature and the Suspend on low feature.
Suspend before low	A feature that suspends insulin delivery when the sensor predicts the SG reading is approaching the low limit.
suspend delivery	A feature that stops all insulin delivery until it is resumed. Only the basal insulin restarts when delivery is resumed.
Suspend on low	A feature that suspends insulin delivery when the SG reading reaches or falls below the low limit.
TDD	The acronym for total daily dose.
temp basal rate (temporary basal rate)	A feature that temporarily increases or decreases the current basal rate for the specified duration of time.
transfer guard	The plastic piece that comes attached to the reservoir. It is used to connect the reservoir to the insulin vial while the reservoir fills with insulin.
transmitter	A device that connects to a glucose sensor. The transmitter collects data measured by the sensor and wirelessly sends this data to the insulin pump.



Index

A

accessories 59

acetaminophen 37

active insulin

about 104

clearing 209

viewing amount 77

Active Insulin cleared alert 295

Active Insulin reminder alert 296

active insulin reset to zero

icon 78

Active Insulin reset to zero 296

Active Insulin Time

about 104

changing 254

adjustments

bolus 194

Alarm History 220

alarms

about 232, 233

Active Insulin reset to zero 296

audio options 234

Auto Suspend 297

Battery failed 297

Battery not compatible 297

Bolus stopped 297

Critical pump error 297

Delivery limit exceeded 298

Fill Cannula? 299

Insert battery 299

Insulin flow blocked 300, 301

Loading incomplete 301

Manage Settings error 302

Max Fill reached 303

Medical device 312

No reservoir detected 303

notification light 234

Power error detected 303

Power loss 303

pump 295

Pump error 304

Pump restarted 305

red icon 234

Replace battery now 305

Rewind required 306

Stuck button 307

alert

Active Insulin reminder 296

Alert before high

about 154

description 307

setting up 162

- Alert before low
 - about 158
 - description 337
 - setting up 166
- Alert on high
 - about 154
 - setting up 162
- Alert on low
 - about 160
 - setting up 167
- alerts
 - about 232, 234
 - Active Insulin cleared 295
 - Alert before high 307
 - Alert before low 308
 - audio options 235
 - Basal delivery resumed 308, 309
 - BG not received 309
 - Bolus not delivered 297
 - Calibration not accepted 309
 - Change sensor 310
 - Check connection 310
 - Check settings 297
 - Device not compatible 298
 - Device not found 298
 - Download slow 319
 - Enter BG now 310, 317, 318
 - High SG 311
 - Lost sensor signal 311
 - Low battery Pump 301
 - Low battery transmitter 311
 - Low reservoir 302
 - No calibration occurred 312
 - notification light 234
 - overview 234
 - Possible signal interference 312
 - pump 295, 318
 - Replace battery 305
 - Reservoir estimate 305
 - Rise alert 313
 - Sensor expired 313
 - Sensor signal not found 313
 - Sensor updating 313, 314
 - silencing 173
 - SmartGuard 315
 - SmartGuard exit 315, 316
 - SmartGuard started 315
 - Suspend before low 314
 - Suspend on low 315
 - Transmitter battery depleted 315
 - yellow icon 234
- Alert silence
 - in SmartGuard feature 200
- Alert Silence
 - about 173
 - canceling 175
- areas, for inserting infusion set 129

- arrows
 - trend arrows 152
- audio
 - settings 82
 - silencing 173
- Auto Basal 181
- Auto Correction
 - about 181
 - setting up 183
- Auto suspend 210
- Auto Suspend alarm 297
- B**
- backlight
 - battery use 72
 - setting up 203
- basal
 - about 87
 - daily delivery amount 217
 - history 217
 - Home screen 76
 - Max basal rate 88
 - patterns 89
 - preset temp basal rate 239
 - rate 87
 - summary 215
 - Temp Basal 98

- Basal delivery resumed
 - alarm 309
 - alert 308, 309
 - message 308
- basal patterns
 - about 89
 - changing 244
 - copying 243
 - deleting 243
 - editing 243
 - setup 90
- Basal Patterns screen
 - about 95
- basal rate
 - about 87
- Basal screen
 - about 95
- battery
 - about 72
 - alarm 297, 299, 305
 - alert 301, 305
 - compartment location 71
 - disposal 292
 - icon 78
 - inserting 72
 - pump clip 292
 - removing 292
 - replacing 72
- Battery failed alarm 297

- Battery not compatible alarm 297
- BG
 - confirming 101
 - Entering a BG value in Manual mode 100
 - Entering a BG value in the SmartGuard feature 189
 - Home screen 76
 - Summary screen 218
- BG not received alert 309
- BG target
 - about 104
 - changing 253
- Block mode
 - about 204
 - icon 80
 - in SmartGuard 200
- blood glucose
 - confirming 101
- bolus
 - about 101
 - Bolus Wizard 101, 103
 - daily delivery amount 217
 - Dual Wave 259
 - Easy bolus 263
 - history 217, 218
 - increment 250
 - Manual bolus 102, 111
 - Max bolus setting 102
 - normal bolus 109, 111
 - options 101
 - preset 266
 - settings 250
 - shortcut 77
 - SmartGuard 191
 - speed 251
 - Square Wave 255
 - stopping 112, 270
 - summary 215, 217, 218
 - types 249
- Bolus BG Check reminder 229
- Bolus not delivered alert 297
- Bolus stopped alarm 297
- Bolus Wizard
 - about 101
 - Active Insulin Time 104
 - BG target 104
 - changing 252
 - Dual Wave 260
 - Insulin Sensitivity Factor 104
 - normal bolus 109
 - settings 103
 - Square Wave 256
 - turning off 109
- buttons, pump 70
- C**
 - calibrate
 - error 310

- calibration
 - reminder 232
- Calibration not accepted alert 309
- cannula
 - about 72
 - filling 130
 - stop filling 132
- cannula alarm 299
- carb ratio
 - about 104
 - changing 252
 - setting up 106
- CareLink software 142
- CareLink uploader not found. message 318
- Change sensor alert 310
- Check connection alert 310
- Check settings alert 297
- cleaning
 - pump 285
 - transmitter 291
- clearing
 - active insulin 209
 - pump settings 208
- consumables
 - infusion set 57
 - reservoir 57
- continuous glucose monitoring (CGM)
 - high SG settings 153
 - home screen 152
 - low SG settings 154
 - pairing pump, transmitter 139
 - sensor feature, turning on or off 162
 - sensor glucose reading 172
 - sensor graph 172
 - settings 153
- conventions, user guide 30
- Critical pump error alarm 297
- CT scan 52
- D**
- Daily History 219
- date
 - changing 203
 - Startup Wizard 74
- delivery 81
- Delivery limit exceeded alarm 298
- Device Limit message 298
- Device not compatible alert 298
- Device not found alert 298
- display options 203
- disposal, pump 288
- Download slow alert 319

- Dual Wave
 - about 259
 - Bolus Wizard 260
 - example 250
 - Manual bolus 261
- Dual Wave bolus
 - stopping 270
- E**
- Easy bolus
 - about 263
 - delivering 265
 - setting up 263
- electromagnetic emissions
 - about 340
- electromagnetic immunity
 - about 341
- emergency kit 31
- Enter BG
 - in Manual mode 100
 - in SmartGuard 189
- Enter BG now alert 310, 317, 318

- F**
- Fill Cannula? alarm 299
- food estimate 328

- G**
- graph
 - CGM 172
 - history 222
 - SmartGuard 188

- H**
- High Limit
 - about 154
 - setting up 163
- High SG alert
 - about 154, 311
- high SG settings
 - about 153
 - setting up 162
- High Snooze 165
- history
 - Alarm History 220
 - Daily History 219
 - Graph 222
 - Paired Sensors 220
 - pump settings, viewing 210
 - SG Review 221
 - summary 215
 - Time in Range 223
- History & Graph 215
 - introduction 215
- Home screen
 - CGM 152
 - Manual mode 76
 - SmartGuard 187
- hydroxycarbamide 37
- hydroxyurea 37

I

icons

- menu 81
- SmartGuard graph 187
- status 78
- suspend 159

infusion set

- about 118
- fill cannula alarm 299
- fill tubing 126
- inserting 129
- overview 71
- reservoir alarm 301
- setting up 118
- type 57

Insert battery alarm 299

inserting

- infusion set 129
- reservoir 126
- sensor 169

insulin

- basal 87
- basal patterns 89
- bolus 101
- flow blocked alarm 300, 301
- icon 78
- Max Fill reached alarm 303
- setting up delivery 87

insulin delivery

- Block mode 204
- resuming 95, 161, 168
- stopping 95, 112, 270
- suspending
95, 156, 158, 210, 365

Insulin flow blocked alarm 300, 301

Insulin Sensitivity Factor

- about 104
- changing 252
- setting up 107

L

language

- changing 211
- setting up 74

light, notification 234

Loading incomplete alarm 301

Lost sensor signal alert 311

Low battery Pump alert 301

Low battery transmitter alert 311

Low limit

- about 156

low management mode

- summary 219

Low Reservoir

- alert 230, 302
- reminder 230

Low SG alarm

- about 156

- low SG settings
 - about 154
 - changing 167
 - setting up 165

- Low Snooze 168

M

- maintenance
 - cleaning the pump 285
 - pump disposal 288
 - removing the battery 291
 - storing the pump 286
 - unpairing the meter 288
 - unpairing the transmitter 290

- Manage Settings 207

- Manage Settings error alarm 302

- Manual bolus
 - about 102
 - Dual Wave 261
 - Easy bolus feature 265
 - normal bolus 111
 - Square Wave 257

- Max basal
 - about 88
 - alarm 298

- Max bolus
 - about 102
 - alarm 298

- Max Fill reached alarm 303

- meal bolus
 - in SmartGuard 195
 - reminder 229

- Medical device alarm 312

- medications
 - acetaminophen 37
 - hydroxycarbamide 37
 - hydroxyurea 37
 - paracetamol 37

- Medtronic Diabetes Updater app 143

- menu
 - accessing 81
 - Blood Glucose screen 81
 - History & Graph screen 81
 - icons 81
 - Insulin screen 81
 - map 81, 349
 - Paired Devices screen 81
 - Reservoir & Set screen 81
 - Settings screen 81
 - SmartGuard screen 81
 - Sound & Vibration screen 82
 - Status screen 81

- messages
 - about 232, 235
 - Basal delivery resumed 308
 - CareLink uploader not found. 318

- CGM 307
- Device Limit 298
- overview 235
- pump 295, 318
- Resume bolus 306
- Resume Dual bolus 306
- Resume Square bolus 306
- Sensor connected 313
- meter
 - pairing 137
 - unpairing 288
- Missed Meal Bolus reminder 229
- mobile device
 - uploading 142
- modes
 - Block 204
 - Manual 76
 - Sleep 70
- MRI 52
- N**
- No calibration occurred alert 312
- No reservoir detected alarm 303
- normal bolus
 - about 109
 - Bolus Wizard 109
 - delivery 109
 - example 250
 - Manual bolus 111
- notification light 234

- notifications
 - about 227, 232
 - light 234
- O**
- Occlusion detection
 - alarm 335
- options
 - basal patterns 89
 - bolus delivery 101
 - bolus speed 325
 - display 203
 - Manage Settings 207
 - Self Test 206
 - Sound & Vibration 82
 - Status screen 82

- P**
- pair device 139, 142
 - meter 137
 - mobile device 142
 - pairing transmitter 139
- Paired Sensors 220
- paracetamol 37
- patterns, basal
 - about 89
 - adding 242
 - changing 244
 - copying 243, 244

- deleting 243
 - editing 243
 - setup 90
- performance data
 - seven years and older 355
- personal reminders 228
- Possible signal interference alert 312
- Power error detected alarm 303
- Power loss alarm 303
- preset bolus
 - about 266
 - changing 268
 - delivering 269
 - setting up 266
- preset temp basal rate
 - about 239
 - canceling 242
 - setting up 239
 - starting 241
- Preset Temp basal rate
 - editing 240
- pump
 - alarms 295
 - alerts 295
 - buttons 69
 - cleaning 285
 - connection status 79
 - disposal 288
 - messages 295
 - overview 71
 - pairing, meter 137
 - pairing, mobile device 142
 - pairing, transmitter 139
 - parts illustration 71
 - rewinding 118
 - storing 286
 - unpairing, meter 288
 - unpairing, transmitter 290
- pump clip
 - removing battery cap with 292
 - tightening battery cap with 73
- Pump error alarm 304
- Pump restarted alarm 305
- pump security 55
- pump settings
 - clearing 208
 - managing 207
 - restoring 208
 - saving 207
 - viewing history 210

R

- rate
 - basal 87
 - Max basal 88
 - preset temp basal 239
 - temp basal 98
- red light 234

- reminders
 - about 227
 - Bolus BG Check 229
 - calibration 232
 - Low Reservoir 230
 - Missed Meal Bolus 229
 - Personal 228
 - Set Change 231
- Replace battery alert 305
- Replace battery now alarm 305
- reservoir
 - about 118
 - connecting 122
 - diagram 71
 - filling 122
 - icon 78
 - inserting 126
 - Loading incomplete alarm 301
 - Low Reservoir alert 302
 - Max Fill reached alarm 303
 - models 57
 - No reservoir detected
 - alarm 303
 - overview 72,288
 - plunger 122
 - removing 118
 - setting up 118
 - transfer guard 122
- Reservoir estimate alert 305
- restoring pump settings 208
- Resume basal alert 161
- Resume bolus message 306
- Resume Dual bolus message 306
- Resume Square bolus message 306
- rewinding 126
- Rewind required alarm 306
- Rise Alert
 - about 154
 - description 313
 - setting up 163
- Rise Limit
 - about 154
 - setting up 163
- S**
- safety
 - contraindications 35
 - information 30
 - insulin guidelines 57
 - intended use 32
 - risks 36
 - warnings 40
- saving pump settings 207
- screen
 - Block mode 80,200,204,205
 - Home screen 76
 - Language 74
 - Select Time Format 75

- Summary 215, 219, 220, 221, 224
- Time and Date 203
- Welcome screen 74
- self test 206
- sensor
 - about 33
 - BG not received alert 309
 - calibration alert 309, 310
 - communication 79
 - expired alert 313
 - feature, turning on or off 162
 - Home screen 152
 - inserting 169
 - life icon 79
 - pairing the transmitter 139
 - removing 291
 - starting 170
 - Summary screen 218
- sensor alerts
 - canceling silence 175
 - silencing 173, 175
- Sensor connected message 313
- Sensor expired alert 313
- sensor glucose (SG)
 - graph 172
 - high SG settings 153
 - history 172
 - low SG settings 154
- sensor graph
 - about 152
 - CGM 172
- sensor performance
 - precision 374
- Sensor signal not found alert 313
- Sensor updating alert 313, 314
- Set Change reminder 231
- settings
 - 24-hour period 91
 - bolus 250
 - Bolus Wizard 103
 - CGM 153
 - low SG 154
 - managing 207
 - startup 74
- SG Review 221
- shortcuts 77
- silencing alerts
 - about 173
- Sleep mode 70
- SmartGuard
 - about 179
 - alerts 315
 - Block mode in 200
 - bolus 191
 - bolus adjustments 194
 - Checklist 184
 - conditions to activate 183

- entering a BG value 189
- exiting 199
- Home screen 187
- introduction 179
- messages 315
- preparing 181
- returning to 199
- sensor graph 188
- Setting Temp Target 196
- setting up 182
- staying in 197
- suspend features 184
- Temp Target 196
- using 188
- SmartGuard exit alert 315, 316
- SmartGuard started alert 315
- Sound & Vibration
 - adjusting 82
 - screen 82
- Square Wave
 - about 255
 - Bolus Wizard 256
 - example 250
 - Manual bolus 257
 - setting up 255
- Square Wave bolus
 - stopping 270
- starting
 - sensor 170
- Startup Wizard
 - about 74
- status icons
 - about 78
 - Block mode 80
 - CGM 152
 - Connection icon 79
 - insulin amount 78
 - sensor life 79
 - time 76
- Status screen
 - about 82
 - pump 83
 - sensor 83
 - shortcut 77
 - SmartGuard Checklist 83
- stopping
 - bolus 112, 270
 - insulin delivery 95
- storage mode 286
- Stuck button alarm 307
- Summary screen
 - about 215
 - BG 218
 - bolus 217, 218
 - Bolus Wizard 217
 - insulin delivery overview 217
 - low management mode 219
 - overview 216

- sensor 218
 - SmartGuard 218
 - time in range 216
- Suspend before low
 - about 156, 365
 - alert 314
 - in SmartGuard 184
 - setting up 166
 - unavailable 159
- Suspended delivery
 - about
 - resuming 96
- Suspended delivery, resuming
 - after a suspend event 161
 - manually 168
- suspending insulin delivery
 - Auto suspend 210
 - in SmartGuard 184
 - manually 95
 - resuming automatically 161
 - resuming manually 168
 - Suspend before low 156, 365
 - Suspend on low 158
- Suspend on low
 - about 158
 - alarm 315
 - in SmartGuard 184
 - setting up 166
 - unavailable 159
- system overview 71
- system security 55
- T**
- target
 - BG 104
 - SmartGuard 180
- TDD 217
- temp basal rate
 - about 98
 - starting 98
 - types 98
- Temp Target
 - canceling 197
 - setting up 196
- time
 - changing 203
 - Startup Wizard 203
- Time before high
 - about 154
 - setting up 163
- time in range
 - about 223
 - shortcuts 77
- transfer guard 44, 122
- transmitter
 - charging 140
 - connecting 170
 - pairing 139
 - unpairing 290

Transmitter battery depleted
alert 315

trend arrows 152

troubleshooting 275

- pump issues 275
- sensor issues 279

tubing

- filling 126
- image 71
- Max Fill reached alarm 303

tubing connector 40, 44, 71, 122

V

vibration settings 82

viewing

- basal delivery information 95

- pump settings history 210

W

wake the pump 70

X

x-ray 52

Medtronic



Medtronic MiniMed

18000 Devonshire Street

Northridge, CA 91325

USA

1 800 646 4633

+1 818 576 5555

www.medtronicdiabetes.com

RF: M994838A001

R_x Only

© 2023 Medtronic
M036461C001 2
2023-02-24

REF

MMT-1884, MMT-1894



M036461C001

MiniMed™ 780G

MINIMED™ QUICK-SET™ INFUSION SET AND RESERVOIR, AND GUARDIAN™ SENSOR (3) QUICK REFERENCE GUIDE



Medtronic

Medtronic and Medtronic logo are trademarks of Medtronic. ^{TM*} Third-party brands are trademarks of their respective owners. All other brands are trademarks of a Medtronic company. The following list includes trademarks or registered trademarks of a Medtronic entity in the United States or in other countries.

MiniMedTM, Quick-setTM

Contents

- **Changing the MiniMed™ Quick-set™ Infusion Set and Reservoir 7**
The MiniMed Quick-set infusion set and the reservoir can be used for up to three days. In most cases, the infusion set and reservoir should be changed at the same time.
- **Disconnecting and Reconnecting the MiniMed Quick-set Infusion Set 23**
- **Changing the MiniMed Reservoir Only 27**
The MiniMed reservoir can be used for up to three days. If the reservoir runs out of insulin and the infusion set has not been used for three full days, the New Reservoir Only option may be used to change the reservoir. The infusion set must still be replaced within three days of use.
- **Changing the MiniMed Quick-set Infusion Set Only 39**
The MiniMed Quick-set infusion set can be used for up to three days. If only the infusion set needs to be changed before three full days of use, the New Set Only option may be used to change the infusion set. The reservoir must still be replaced within three days of use.
- **Inserting the Guardian™ Sensor (3) with One-press Serter 53**

WARNING: The following warning applies to changing the reservoir and infusion set, changing the reservoir only, and changing the infusion set only.

Always confirm that the infusion set tubing is disconnected from the body before doing the following steps:

- placing the reservoir into the pump
- rewinding the pump
- loading the reservoir
- filling the infusion set tubing

Failing to disconnect the infusion set tubing from the body may result in an accidental infusion of insulin, and may cause hypoglycemia.

Changing the MiniMed™ Quick-set™ Infusion Set and Reservoir



The MiniMed Quick-set infusion set and the reservoir can be used for up to three days. In most cases, the infusion set and reservoir should be changed at the same time.

Note: The MiniMed Quick-set infusion set and reservoir can be used for up to three days. To avoid wasting insulin, fill the reservoir with enough insulin to last until the next infusion set change.

START HERE

Follow these steps to change the infusion set and reservoir.

1



Wash hands with soap and water. On the pump, press  to go to the menu screen.

2

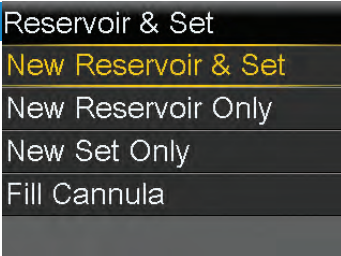

Select , and then select **New Reservoir & Set**.

3

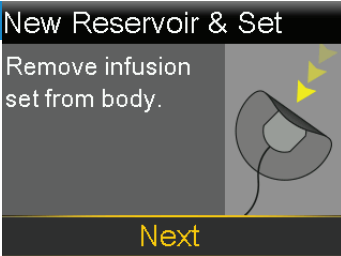

Remove the infusion set by loosening the adhesive and pulling the set away from the body. Select **Next**.

4

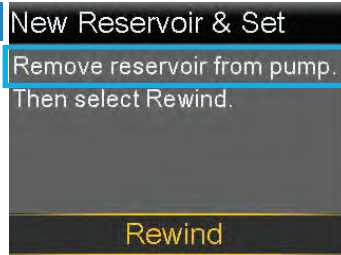

Remove the used reservoir from the pump.

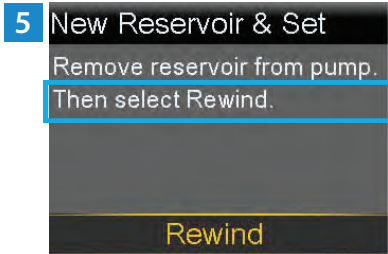

Select **Rewind**.
Do not connect the infusion set to the body.

WARNING: Always confirm that the infusion set is disconnected from the body before rewinding the pump. Failing to disconnect the infusion set from the body may result in an accidental infusion of insulin, and may cause hypoglycemia.

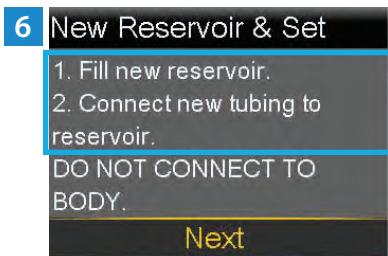

Follow the next steps to fill the new reservoir with insulin and to connect the new infusion set tubing.
Do not select **Next**.

FILL THE RESERVOIR

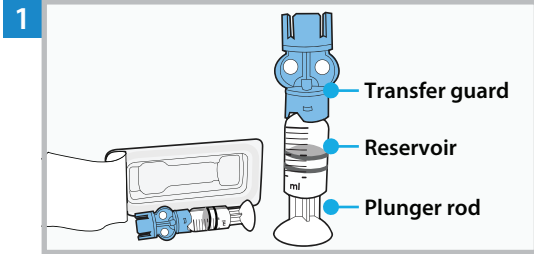

Remove the reservoir from the package. Make sure the insulin vial is at room temperature to reduce the risk of air bubbles.

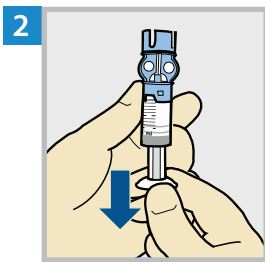

Pull the plunger down based on the planned 2-3 day insulin fill amount.

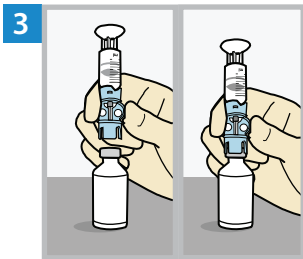

Wipe the top of the vial with alcohol. Place the vial on a sturdy, flat surface. Firmly press the transfer guard onto the vial.

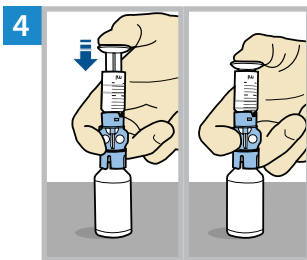

Push and hold the plunger down.

WARNING: Do not use the reservoir or infusion set if insulin or any liquid gets on the top of the reservoir or inside the tubing connector, as shown in the image. Insulin or any liquid can temporarily block the vents. This may result in the delivery of too little or too much insulin, which can cause hyperglycemia or hypoglycemia. If insulin or any liquid gets on the top of the reservoir or inside the tubing connector, start over with a new reservoir and infusion set.

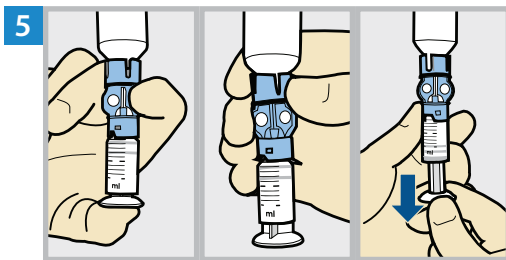
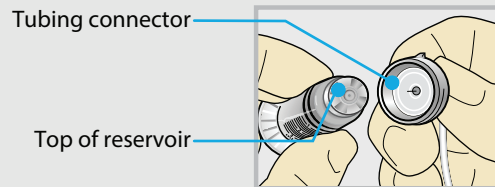

Keeping a thumb on the plunger, flip the vial over so the vial is on top. Release the thumb and pull the plunger down to fill the reservoir with insulin.

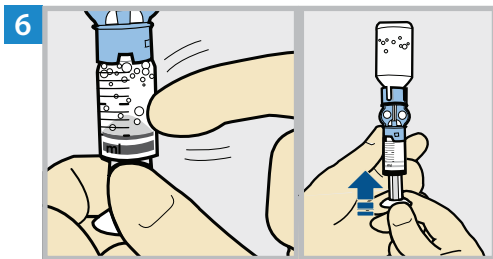

Tap the reservoir to move air bubbles to the top of the reservoir. Push the plunger up to move air into the vial.

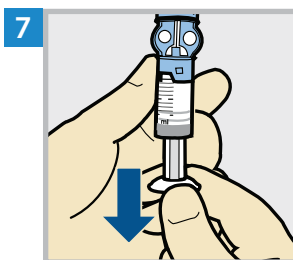

Pull the plunger back down to allow the reservoir to fill with the amount of insulin needed for 2-3 days.

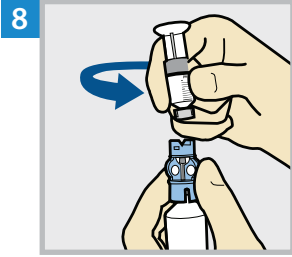

To avoid getting insulin on the top of the reservoir, **flip the vial over again so the reservoir is on top.** Hold the transfer guard and turn the reservoir counter-clockwise and remove the reservoir from the transfer guard.

CONNECT THE INFUSION SET TO THE FILLED RESERVOIR

1 MiniMed™ Quick-set™ Infusion Set

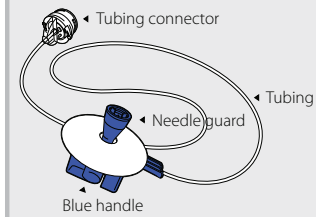

Remove the infusion set tubing from the package. Remove the paper that holds the tubing together and unwind the tubing.

2

Tubing connector

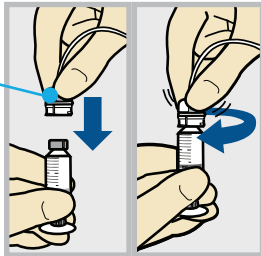

Gently push the tubing connector onto the reservoir. Turn the connector clockwise until it is locked into place.

3

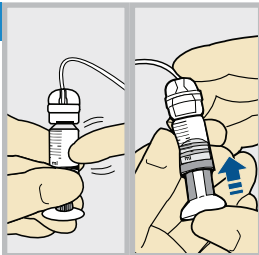

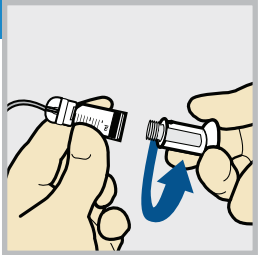

Tap the reservoir to move any air bubbles to the top. Push the plunger slightly to move the bubbles into the tubing.

4



Twist the plunger counter-clockwise to loosen it and to remove it.

PLACE THE RESERVOIR INTO THE PUMP

Note: The backlight may have turned off. Press any button to turn the screen back on. Press  to go to the menu screen, and then select .

1 New Reservoir & Set

1. Fill new reservoir.
2. Connect new tubing to reservoir.
DO NOT CONNECT TO BODY.

Next

Select **Next**.

2 New Reservoir & Set

3. Place reservoir into pump and lock.
DO NOT CONNECT TO BODY.

Next

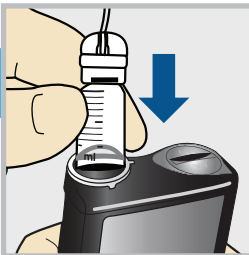

Place the reservoir into the pump.
Do not connect the infusion set to the body.

WARNING: Always confirm that the infusion set is disconnected from the body before placing the reservoir into the pump. Failing to disconnect the infusion set from the body may result in an accidental infusion of insulin, and may cause hypoglycemia.

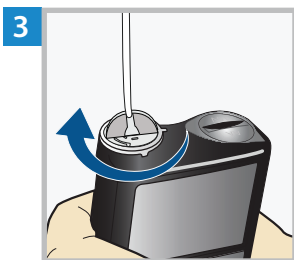

New Reservoir & Set

3. Place reservoir into pump and lock.
DO NOT CONNECT TO BODY.

Next

Turn the reservoir clockwise until the reservoir locks into place, and select **Next**.

LOAD THE RESERVOIR AND FILL THE TUBING

1 Load Reservoir
 Select Load and hold until complete.
 DO NOT CONNECT TO BODY.



Select **Load** and hold  until the checkmark appears on the screen. **Do not** connect the infusion set to the body.

2 Load Reservoir
 Complete
 DO NOT CONNECT TO BODY.

When the checkmark appears, select **Next**.

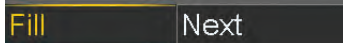
WARNING: Always confirm that the infusion set is disconnected from the body before loading the reservoir and filling the tubing. Failing to disconnect the infusion set from the body may result in an accidental infusion of insulin, and may cause hypoglycemia.

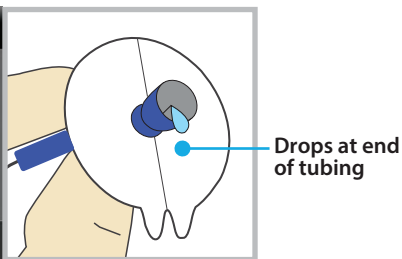
3 Fill Tubing
 DO NOT CONNECT TO BODY.
 Hold Fill until drops appear.
 Then select Next.
 0.0 U



Select **Fill** and keep holding  until there are no air bubbles visible in the tubing, and there are drops at the end of the tubing.

Do not connect the infusion set to the body.

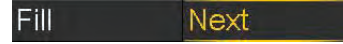
4 Fill Tubing
 DO NOT CONNECT TO BODY.
 Hold Fill until drops appear.
 Then select Next.
 11.3 U

After drops appear, press  and select **Next**.

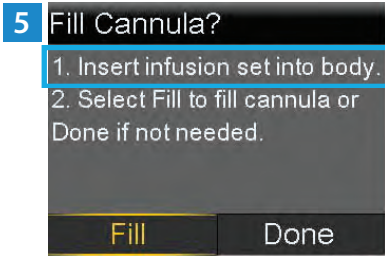

Follow the next steps to insert the infusion set before filling the cannula.

INSERT THE INFUSION SET

1 MiniMed™ Quick-serter™ Insertion Device

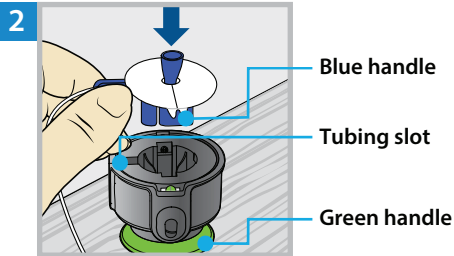
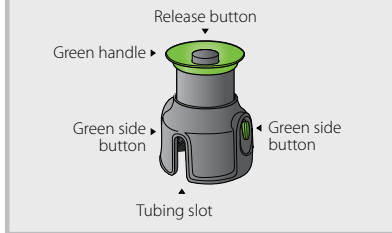

Place the MiniMed Quick-serter insertion device onto a sturdy, flat surface with the green handle facing down. Line up the blue handle of the infusion set with the tubing slot and place the blue handle in the Quick-serter.

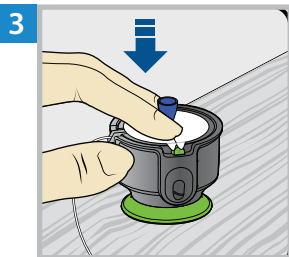

Use two fingers to seat the infusion set inside the serter securely and gently push the set down.



Holding the needle guard, peel the paper from the adhesive on both sides of the needle guard.

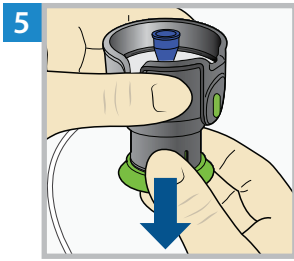

5 Pull the green handle down until there is a click.

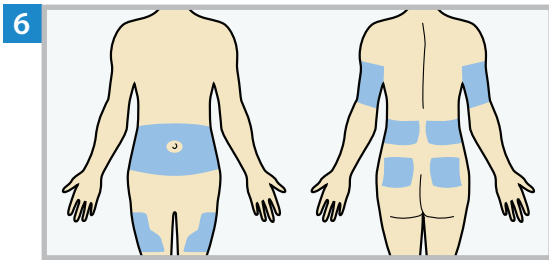

6 Choose an insertion site from the shaded areas shown here. Wipe the site with alcohol or other antiseptic.

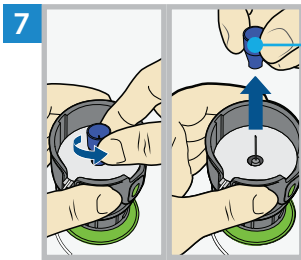

Needle guard

7 Turn the needle guard to loosen it and pull to remove it.

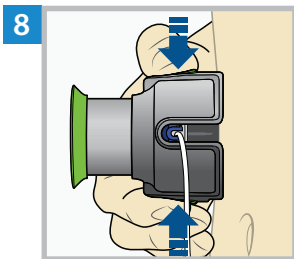

8 Hold the inserter against the cleaned insertion site. Place fingers on the two green side buttons, and press the buttons at the same time. Keep the inserter against the cleaned insertion site.

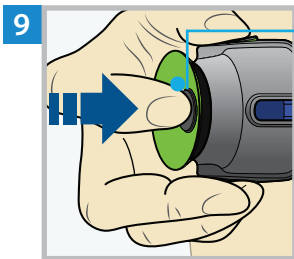

Release button

9 Press down the release button to release the infusion set from the inserter.

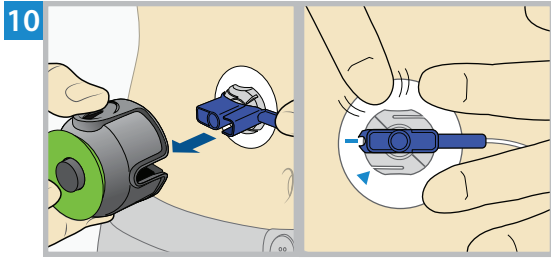

Pull the inserter away from the body. Press the adhesive against the skin all the way around the site.

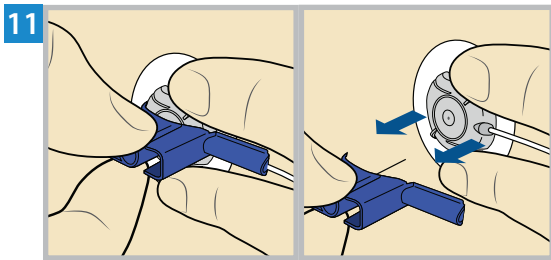

Holding the infusion set, pull the blue handle straight out to remove the needle.

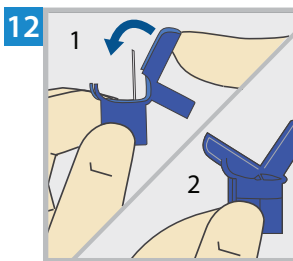

Fold the blue handle over the needle until it locks. Dispose of the blue handle in an appropriate sharps container and in accordance with local laws.

Note: Remove the transfer guard from the vial and dispose of the transfer guard in an appropriate sharps container and in accordance with local laws.

FILL THE CANNULA

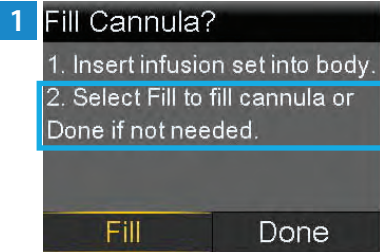

After the infusion set is inserted into the body, select **Fill**.

Note: Always verify that the amount shown in the **Fill amount** field is correct. The pump will remember the fill amount last used. Change the **Fill amount** if needed.



Select **Fill amount** and enter:

- 0.300 U if using the 6 mm cannula
- 0.500 U if using the 9 mm cannula

After entering the cannula fill amount, press .

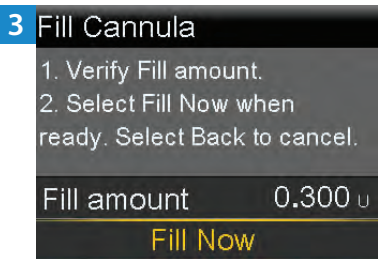

Select **Fill Now**.

The Home screen displays the insulin amount as insulin fills the cannula.

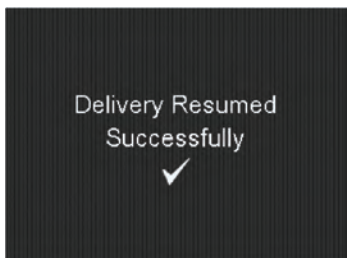

The reservoir and infusion set change is now complete.

Always check blood glucose one to three hours after changing the infusion set or reservoir.

Disconnecting and Reconnecting the MiniMed Quick-set Infusion Set

DISCONNECT THE INFUSION SET

Follow these steps to disconnect the infusion set. Do not remove the adhesive with the cannula housing from the body.

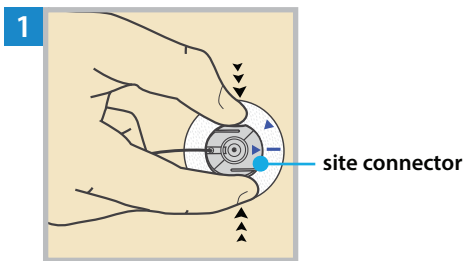

Press the sides of the site connector.

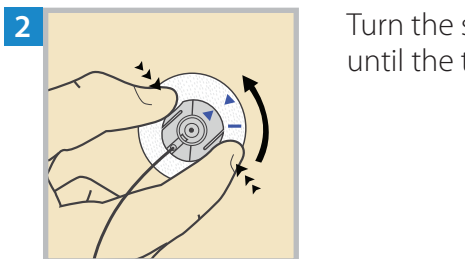

Turn the site connector counterclockwise while pressing the sides until the two arrows are aligned.

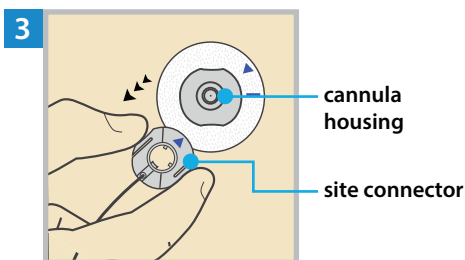

Lift up the site connector to remove it from the cannula housing.

RECONNECT THE INFUSION SET

Follow these steps to reconnect the infusion set.

1

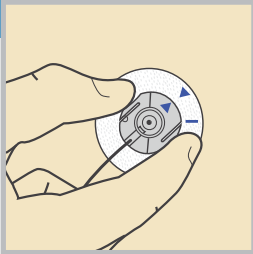

Place the site connector over the cannula housing. Align the blue arrows.

2

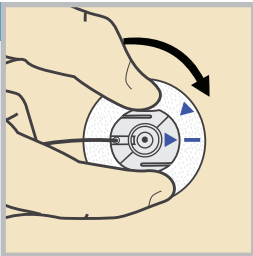

Turn the site connector clockwise without pressing the sides until it locks. The site connector is locked when the arrow on the connector lines up with the blue line on the adhesive.

Changing the MiniMed Reservoir Only



The MiniMed reservoir can be used for up to three days. If the reservoir runs out of insulin and the infusion set has not been used for three full days, the New Reservoir Only option may be used to change the reservoir. The infusion set must still be replaced within three days of use.

Note: The MiniMed Quick-set infusion set and reservoir can be used for up to three days. To avoid wasting insulin, fill the reservoir with enough insulin to last until the next infusion set change.

START HERE

Follow these steps to change the reservoir and keep the current infusion set.

1



Wash hands with soap and water. On the pump, press  to go to the menu screen.

2



Select , and then select **New Reservoir Only**.

3

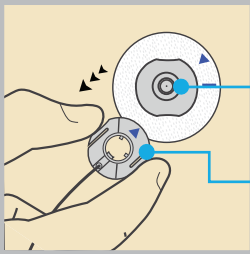
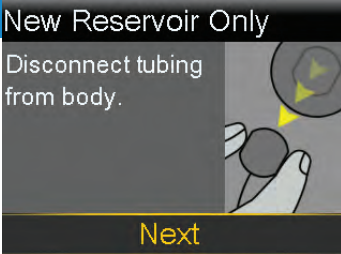

cannula housing
site connector

Disconnect the tubing from the cannula housing. Do not remove the cannula housing from the body. Select **Next**.

4

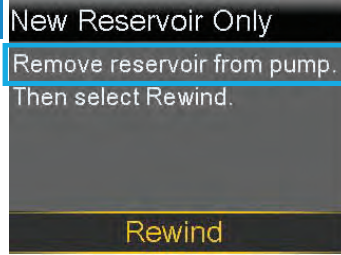

Remove the used reservoir from the pump.

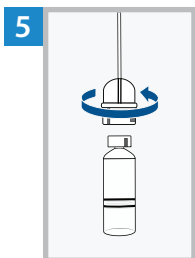

5 Disconnect the infusion set tubing connector from the used reservoir. Place the tubing on a clean surface. Do not throw the tubing away.

Note: Dispose of the used reservoir in an appropriate container and in accordance with local laws.

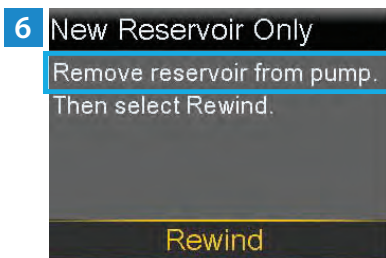

Select **Rewind**.

Do not connect the infusion set to the body.

WARNING: Always confirm that the infusion set is disconnected from the body before rewinding the pump. Failing to disconnect the infusion set from the body may result in an accidental infusion of insulin, and may cause hypoglycemia.

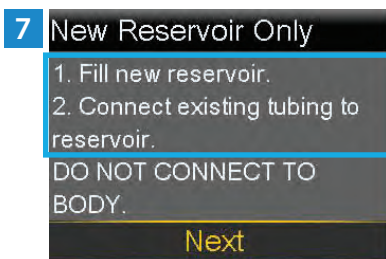

7 Follow the next steps to fill the new reservoir with insulin and to connect the infusion set tubing to the reservoir. Do not select **Next**.

FILL THE RESERVOIR

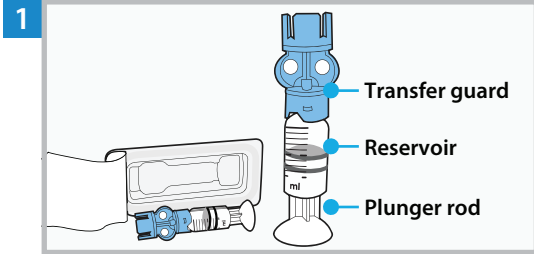

Remove the reservoir from the package. Make sure the insulin vial is at room temperature to reduce the risk of air bubbles.

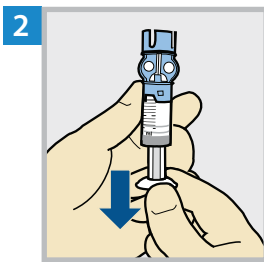

Pull the plunger down based on the planned 2-3 day insulin fill amount.

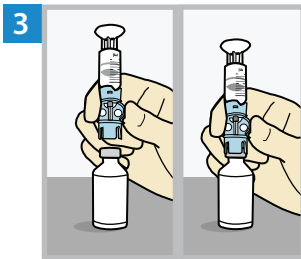

Wipe the top of the vial with alcohol. Place the vial on a sturdy, flat surface. Firmly press the transfer guard onto the vial.

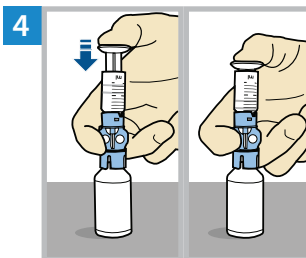

Push and hold the plunger down.

WARNING: Do not use the reservoir or infusion set if insulin or any liquid gets on the top of the reservoir or inside the tubing connector, as shown in the image. Insulin or any liquid can temporarily block the vents. This may result in the delivery of too little or too much insulin, which can cause hyperglycemia or hypoglycemia. If insulin or any liquid gets on the top of the reservoir or inside the tubing connector, start over with a new reservoir and infusion set.

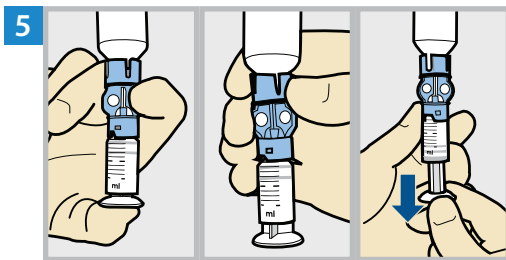
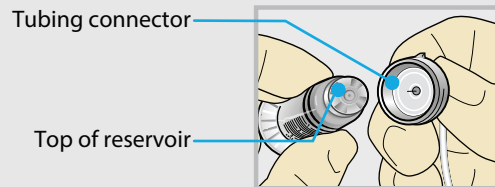

Keeping a thumb on the plunger, flip the vial over so the vial is on top. Release the thumb and pull the plunger down to fill the reservoir with insulin.

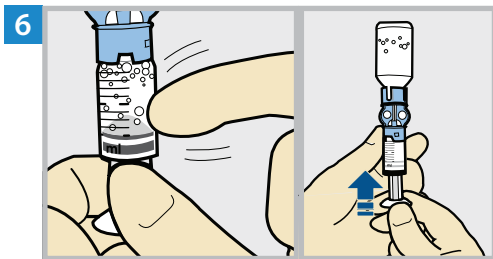

Tap the reservoir to move air bubbles to the top of the reservoir. Push the plunger up to move air into the vial.

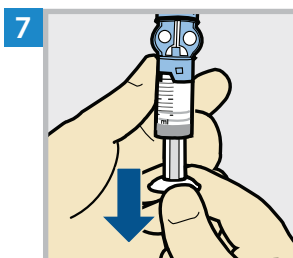

Pull the plunger back down to allow the reservoir to fill with the amount of insulin needed for 2-3 days.

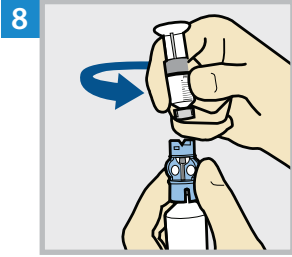

To avoid getting insulin on the top of the reservoir, **flip the vial over again so the reservoir is on top.** Hold the transfer guard and turn the reservoir counter-clockwise and remove the reservoir from the transfer guard.

CONNECT THE INFUSION SET TO THE RESERVOIR

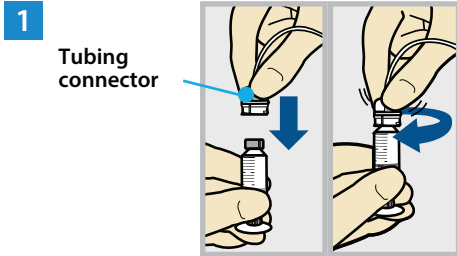

Gently push the tubing connector onto the reservoir.
Turn the connector clockwise until it is locked into place.

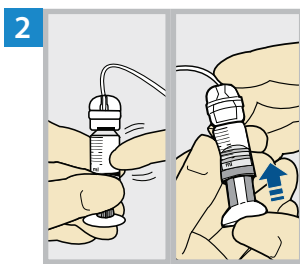

Tap the reservoir to move any air bubbles to the top. Push the plunger slightly to move the bubbles into the tubing.

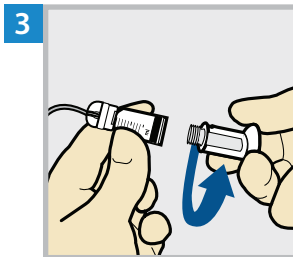

Twist the plunger counter-clockwise to loosen it and to remove it.

PLACE THE RESERVOIR INTO THE PUMP

1 New Reservoir Only

1. Fill new reservoir.
2. Connect existing tubing to reservoir.
DO NOT CONNECT TO BODY.

Next

Select **Next**.

2 New Reservoir Only

3. Place reservoir into pump and lock.
DO NOT CONNECT TO BODY.

Next

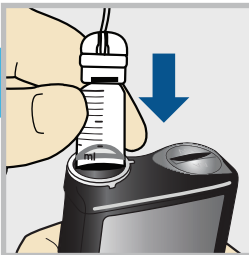

Place the reservoir into the pump.
Do not connect the infusion set to the body.

WARNING: Always confirm that the infusion set is disconnected from the body before placing the reservoir into the pump. Failing to disconnect the infusion set from the body may result in an accidental infusion of insulin, and may cause hypoglycemia.

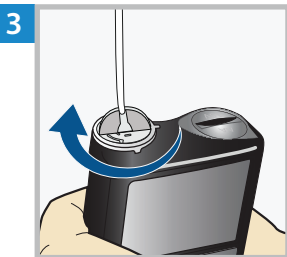

New Reservoir Only

3. Place reservoir into pump and lock.
DO NOT CONNECT TO BODY.

Next

Turn the reservoir clockwise until the reservoir locks into place, and select **Next**.

LOAD THE RESERVOIR AND FILL THE TUBING

1 Load Reservoir

Select Load and hold until complete.
DO NOT CONNECT TO BODY.



Load Next

Select **Load** and hold  until the checkmark appears on the screen. **Do not** connect the infusion set to the body.

2 Load Reservoir

Complete
DO NOT CONNECT TO BODY.



Load Next

When the checkmark appears, select **Next**.

WARNING: Always confirm that the infusion set is disconnected from the body before loading the reservoir and filling the tubing. Failing to disconnect the infusion set from the body may result in an accidental infusion of insulin, and may cause hypoglycemia.

3 Fill Tubing

DO NOT CONNECT TO BODY.
Hold Fill until drops appear.
Then select Next.

0.0 U

Fill Next

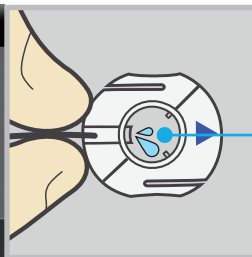

Drops at end of tubing

Select **Fill** and keep holding  until there are no air bubbles visible in the tubing, and there are drops at the end of the tubing.

Do not connect the infusion set to the body.

4 Fill Tubing

DO NOT CONNECT TO BODY.
Hold Fill until drops appear.
Then select Next.

11.3 U

Fill Next

After drops appear, press  and select **Next**.

RECONNECT THE TUBING TO THE INFUSION SITE

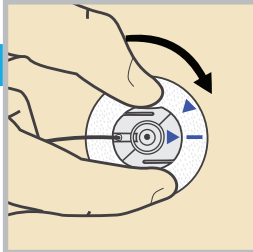
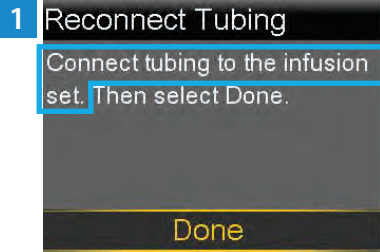

Place the site connector over the cannula housing. Align the blue arrows. Turn the site connector clockwise without pressing the sides until it locks. The site connector is locked when the arrow on the connector lines up with the blue line on the adhesive.

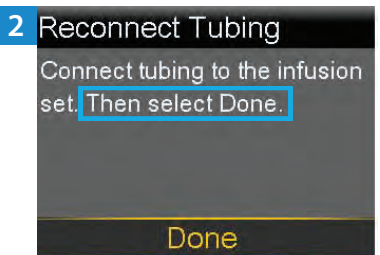

It is not necessary to fill the cannula because the infusion set was not changed. Select **Done**.



The reservoir change is now complete.

Always check blood glucose one to three hours after changing the reservoir.

Note: Remove the transfer guard from the vial and dispose of the transfer guard in an appropriate sharps container and in accordance with local laws.

Changing the MiniMed Quick-set Infusion Set Only

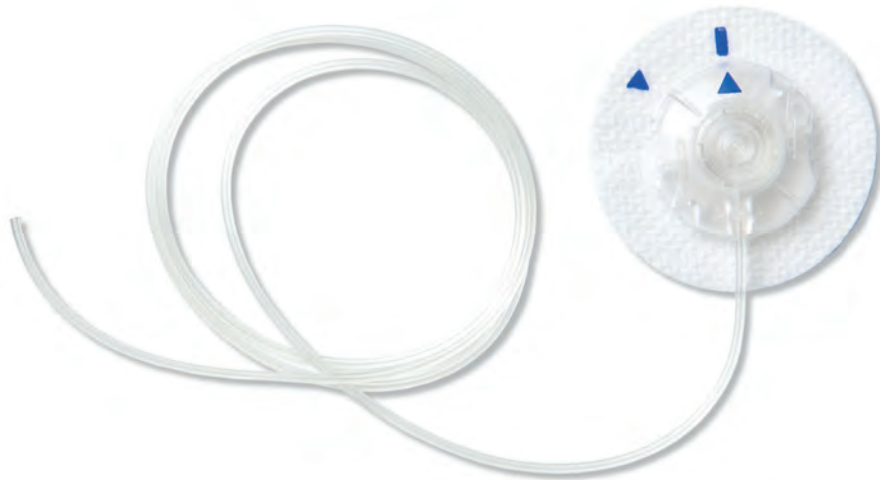

The MiniMed Quick-set infusion set can be used for up to three days. If only the infusion set needs to be changed before three full days of use, the New Set Only option may be used to change the infusion set. The reservoir must still be replaced within three days of use.

START HERE

Follow these steps to change the infusion set and to keep the current reservoir.

1



Wash hands with soap and water. On the pump, press  to go to the menu screen.

2

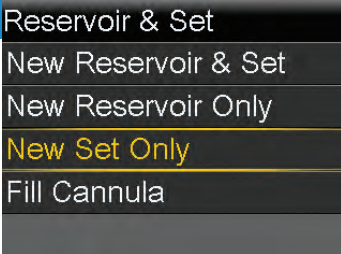

Select , and then select **New Set Only**.

3

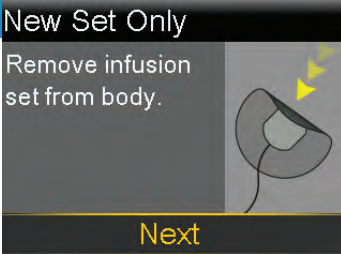

Remove the entire infusion set by loosening the adhesive and pulling the set away from the body. Select **Next**.

4

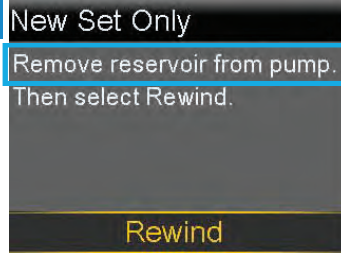

Remove the reservoir from the pump.

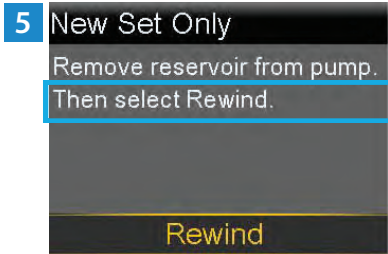

Select **Rewind**.
Do not connect the infusion set to the body.

WARNING: Always confirm that the infusion set is disconnected from the body before rewinding the pump. Failing to disconnect the infusion set from the body may result in an accidental infusion of insulin, and may cause hypoglycemia.



DISCONNECT THE INFUSION SET FROM THE RESERVOIR

1 New Set Only

1. Disconnect existing tubing from the reservoir.
2. Connect new tubing to existing reservoir.

Next

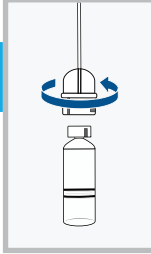

Disconnect the tubing connector of the used infusion set tubing from the reservoir. Place the reservoir on a clean surface. Do not throw the reservoir away.

Note: Dispose of all parts of the infusion set, including the tubing, in an appropriate sharps container and in accordance with local laws.

CONNECT THE INFUSION SET TO THE RESERVOIR

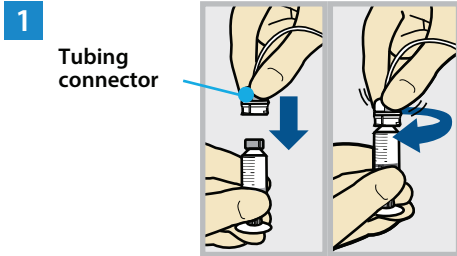

Gently push the tubing connector onto the reservoir.
Turn the connector clockwise until it is locked into place.

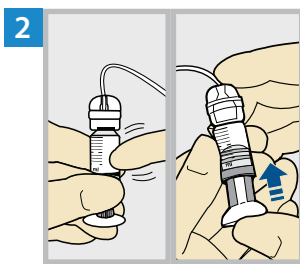

Tap the reservoir to move any air bubbles to the top. Push the plunger slightly to move the bubbles into the tubing.

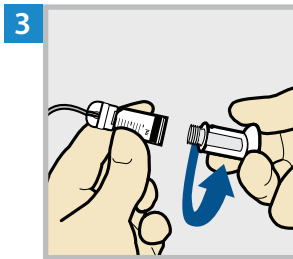

Twist the plunger counter-clockwise to loosen it and to remove it.

PLACE THE RESERVOIR INTO THE PUMP

1 New Set Only

1. Disconnect existing tubing from the reservoir.
2. Connect new tubing to existing reservoir.

Next

Select **Next**.

2 New Set Only

3. Place reservoir into pump and lock.

DO NOT CONNECT TO BODY.

Next

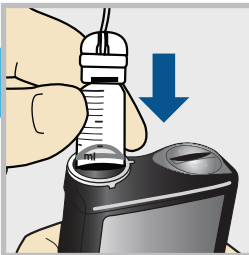

Place the reservoir into the pump. **Do not** connect the infusion set to the body.

WARNING: Always confirm that the infusion set is disconnected from the body before placing the reservoir into the pump. Failing to disconnect the infusion set from the body may result in an accidental infusion of insulin, and may cause hypoglycemia.

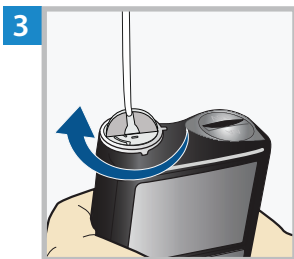

New Set Only

3. Place reservoir into pump and lock.

DO NOT CONNECT TO BODY.

Next

Turn the reservoir clockwise until the reservoir locks into place, and select **Next**.

LOAD THE RESERVOIR AND FILL THE TUBING

1 Load Reservoir
 Select Load and hold until complete.
 DO NOT CONNECT TO BODY.



Load Next

Select **Load** and hold  until the checkmark appears on the screen. **Do not** connect the infusion set to the body.

2 Load Reservoir
 Complete
 DO NOT CONNECT TO BODY.



Load Next

When the checkmark appears, select **Next**.

WARNING: Always confirm that the infusion set is disconnected from the body before loading the reservoir and filling the tubing. Failing to disconnect the infusion set from the body may result in an accidental infusion of insulin, and may cause hypoglycemia.

3 Fill Tubing
 DO NOT CONNECT TO BODY.
 Hold Fill until drops appear.
 Then select Next.

0.0 U

Fill Next

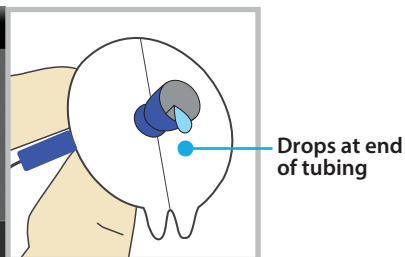

Select **Fill** and keep holding  until there are no air bubbles visible in the tubing, and there are drops at the end of the tubing.

Do not connect the infusion set to the body.

4 Fill Tubing
 DO NOT CONNECT TO BODY.
 Hold Fill until drops appear.
 Then select Next.

11.3 U

Fill Next

After drops appear, press  and select **Next**.

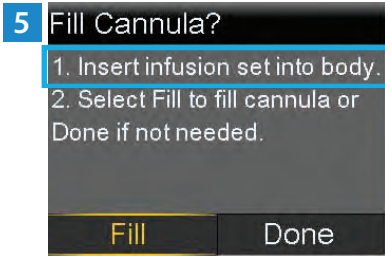

Follow the next steps to insert the infusion set before filling the cannula.

INSERT THE INFUSION SET

1 MiniMed™ Quick-serter™ Insertion Device

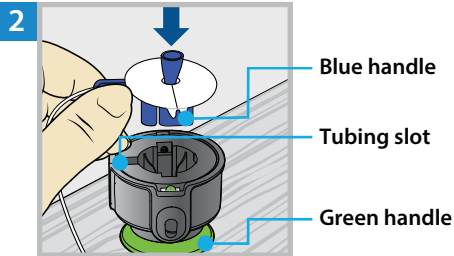
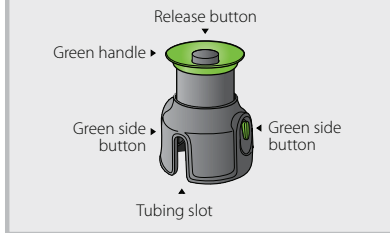

Place the MiniMed Quick-serter insertion device onto a sturdy, flat surface with the green handle facing down. Line up the blue handle of the infusion set with the tubing slot and place the blue handle in the Quick-serter.

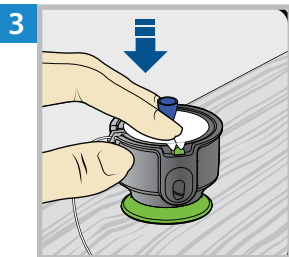

Use two fingers to seat the infusion set inside the serter securely and gently push the set down.



Holding the needle guard, peel the paper from the adhesive on both sides of the needle guard.

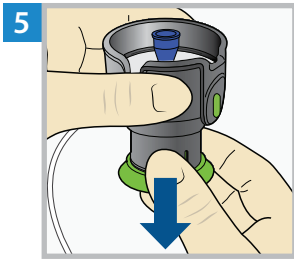

5 Pull the green handle down until there is a click.

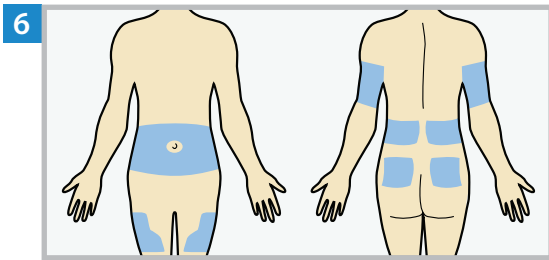

6 Choose an insertion site from the shaded areas shown here. Wipe the site with alcohol or other antiseptic.

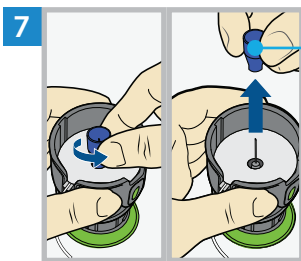

Needle guard

7 Turn the needle guard to loosen it and pull to remove it.

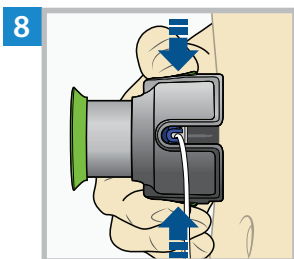

8 Hold the serter against the cleaned insertion site. Place fingers on the two green side buttons, and press the buttons at the same time. Keep the serter against the cleaned insertion site.

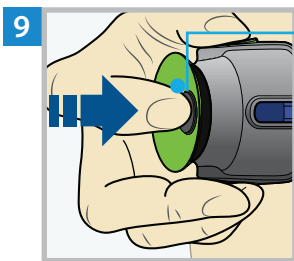

Release button

9 Press down the release button to release the infusion set from the serter.

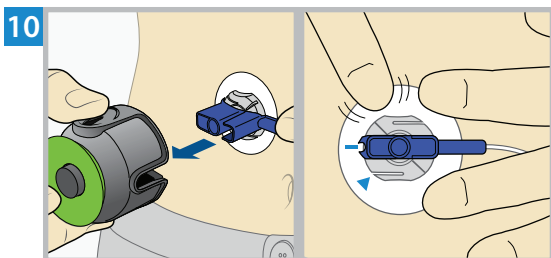

10 Pull the inserter away from the body. Press the adhesive against the skin all the way around the site.

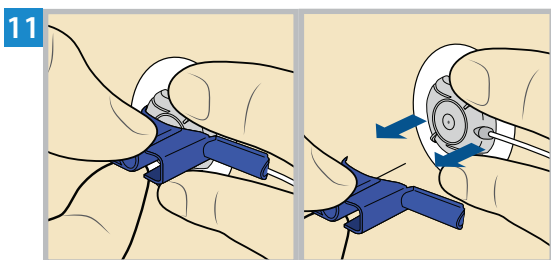

11 Holding the infusion set, pull the blue handle straight out to remove the needle.

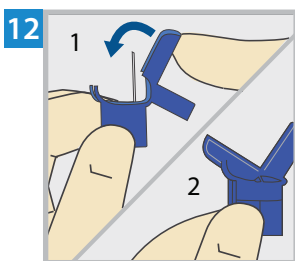

12 Fold the blue handle over the needle until it locks. Dispose of the blue handle in an appropriate sharps container and in accordance with local laws.

Note: Remove the transfer guard from the vial and dispose of the transfer guard in an appropriate sharps container and in accordance with local laws.

FILL THE CANNULA

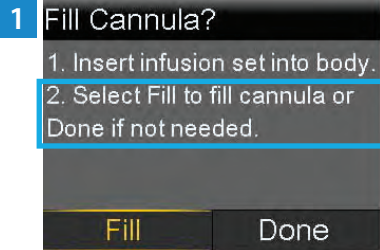

After the infusion set is inserted into the body, select **Fill**.

Note: Always verify that the amount shown in the Fill amount field is correct. The pump will remember the fill amount last used. Change the Fill amount if needed.

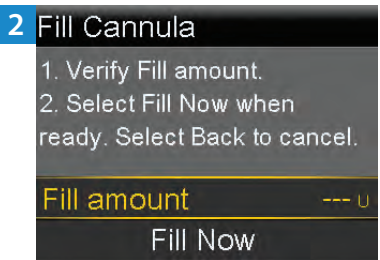

Select Fill amount and enter:

- 0.300 U if using the 6 mm cannula
- 0.500 U if using the 9 mm cannula

After entering the cannula fill amount, press .

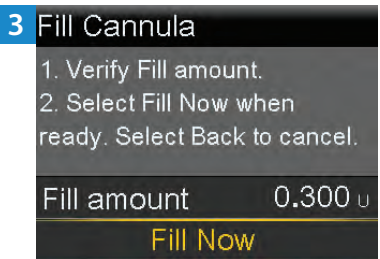

Select **Fill Now**.

The Home screen displays the insulin amount as insulin fills the cannula.

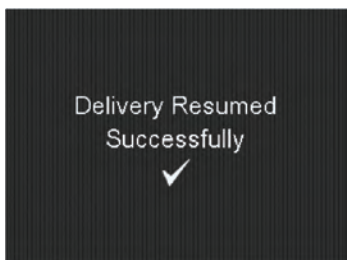

The infusion set change is now complete.

Always check blood glucose one to three hours after changing the infusion set.

Inserting the Guardian™ Sensor (3) with One-press Serter



INSERT THE SENSOR

Choose an insertion site that has an adequate amount of subcutaneous fat. The Guardian Sensor (3) has been studied and is approved for use only in the following sensor insertion sites for the corresponding specified ages.

Approved Age	Sensor Insertion Site
7-13	Abdomen and Buttocks
14 and older	Abdomen and Arm

Ages 7-13 years

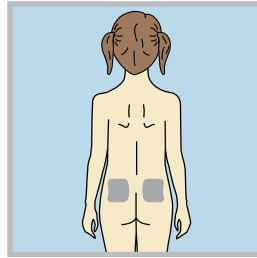

Upper buttocks

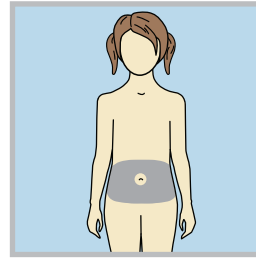

Abdomen



Insertion on back of the upper arm for ages 7-13 years has not been evaluated for accuracy

Ages 14 years and older

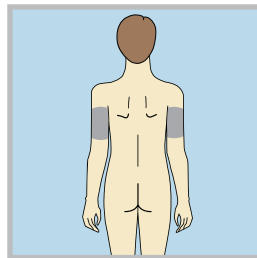

Back of the upper arm

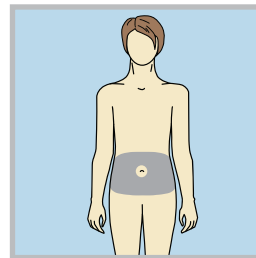

Abdomen



Insertion on upper buttocks for ages 14 years and older has not been evaluated for accuracy.

Note: Assistance will likely be needed for sensor insertion into the back of the upper arm and into the buttocks. Some users find it difficult to insert the sensor into their arm and buttocks by themselves.

INSERT A NEW SENSOR

Wash hands with soap and water and clean the insertion site with alcohol.

1



Open the sensor package. Pull the corner of the paper covering to open the sensor package.

2a

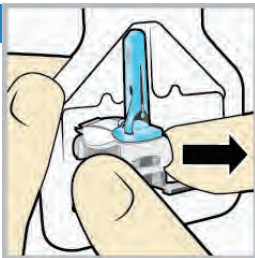

Hold the sensor by the plastic pedestal. Remove the sensor with attached pedestal from the packaging by holding the pedestal only. Place the sensor with the pedestal on a clean, flat surface (such as a table).

2b



Correct



Incorrect

Tuck the adhesive tab. Make sure that the sensor's adhesive tab is tucked under the sensor connector and snaps.

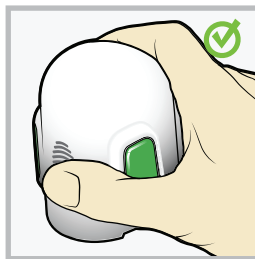

Correct

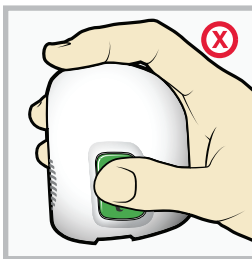

Incorrect

Note: Refer to the illustrations for correct and incorrect ways to hold the serter for loading.

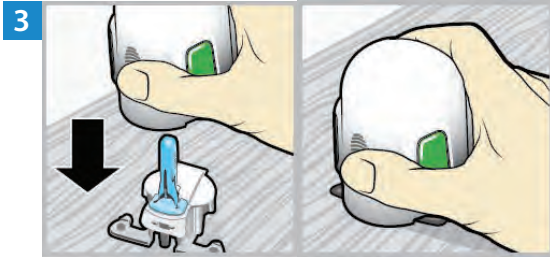

Load the sensor into the serter. Grip the serter exactly as shown **with a thumb on the thumb print on the serter. Do not hold the side buttons.** Push the serter down onto the pedestal until the base of the serter sits flat on the table.

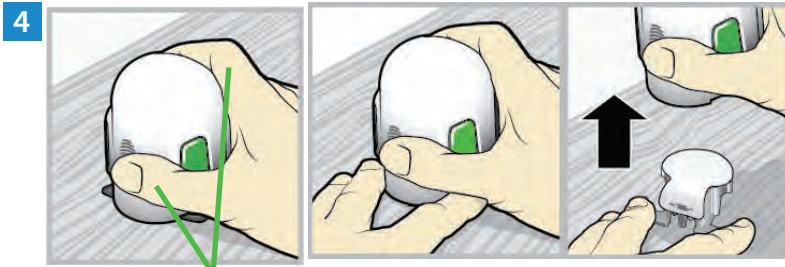

Fingers are NOT holding the side buttons.

Detach the serter from the pedestal. To detach the serter from the pedestal, grip the serter as shown with a thumb on the thumb print on the serter. With the other hand, place two fingers on the pedestal arms, and slowly pull the serter straight up.

Note: Make sure that the pedestal is firmly on the table before pulling the serter away.

CAUTION: Do not detach the pedestal from the serter in mid-air as this may damage the sensor.

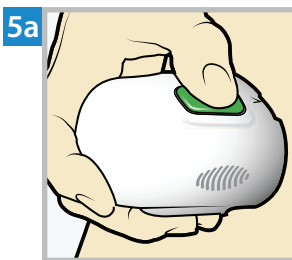

Place the serter on the body. Hold the serter steadily against the cleaned insertion site without pushing the serter too deeply into the skin.

Note: Failing to hold the serter securely flat against the body may allow the serter to spring back after pressing buttons and result in improper insertion of the sensor.

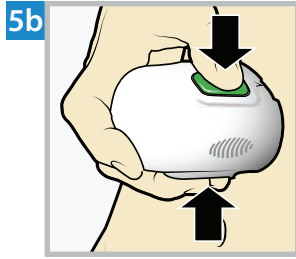

5b **Insert the sensor.** Press the **bump** on both buttons and release them at the same time.

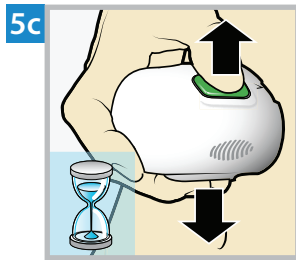

5c **Hold the serter against the body.** Continue holding the serter against the body for at least five seconds to allow the adhesive to stick to the skin.

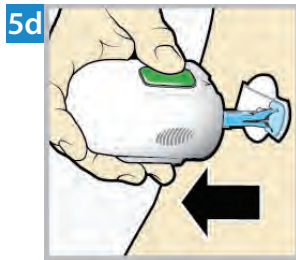

5d **Remove the serter from body.** Slowly pull the serter away from the skin, making sure the buttons are not pressed.

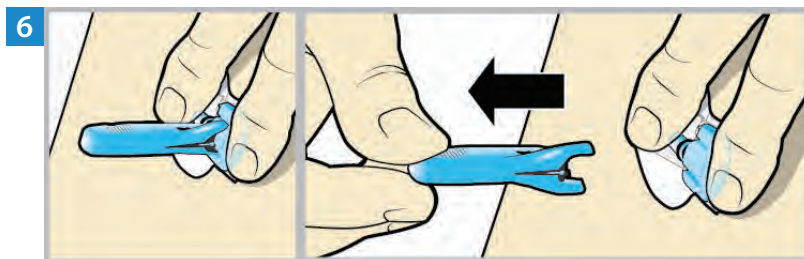

6 **Remove the needle housing.** Gently hold the base of the sensor against the skin with one hand. With the other hand, hold the needle housing **at the top** and slowly pull it straight away from the sensor. Dispose of the needle housing in a sharps container.

Note: An optional, liquid adhesive, such as Skin Tac™, may be used on the skin. Apply the adhesive and allow the skin to dry before removing the adhesive pad liner.

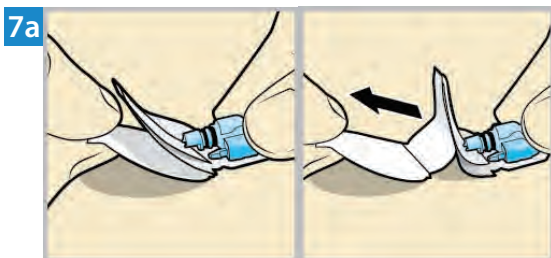

Remove the adhesive pad liner. Hold the sensor in place and gently remove the liner from under the adhesive pad.

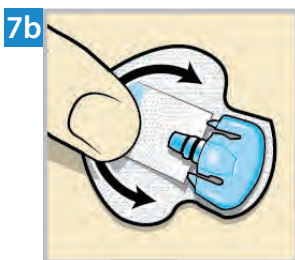

Press the entire adhesive pad to the skin. Firmly press the adhesive pad against the skin and smooth the entire adhesive pad so it sticks to the skin.

Note: The sensor adhesive is sensitive to pressure. Continue applying pressure on the adhesive to ensure that the sensor remains inserted in the skin for 7 days of wear.

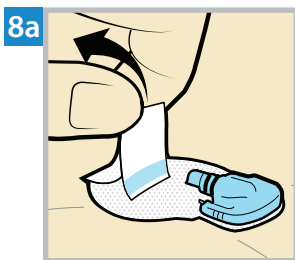

Untuck the adhesive tab. Untuck the adhesive tab from under the sensor connector.

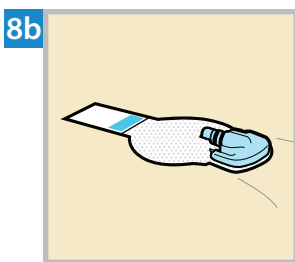

Straighten the adhesive tab. Straighten the adhesive tab so it lies flat against the skin, but do not remove the adhesive liner yet.

TAPE THE SENSOR

1

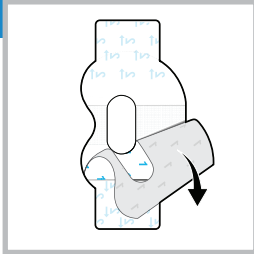

Remove the liner marked 1.

2

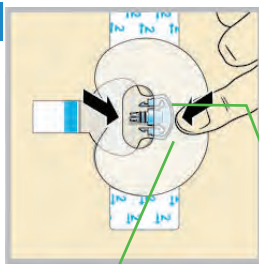

Wide part of tape covers half of sensor base.

Both sensor and skin are taped.

Apply the tape as shown and press down firmly.

3

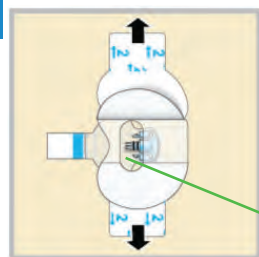

Connector and snaps in hole of tape.

Remove the liner marked 2 from each side.

4

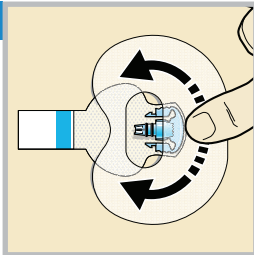

Smooth the tape.

CONNECT THE TRANSMITTER

1

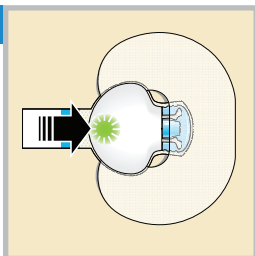

Connect the transmitter to the sensor.

Note: Wait for the green light on the transmitter to flash. If the green light does not flash, refer to Troubleshooting section of the transmitter user guide.

2

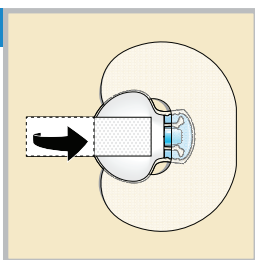

Cover the transmitter with the adhesive tab.

Note: Do not pull the tab too tightly.

3

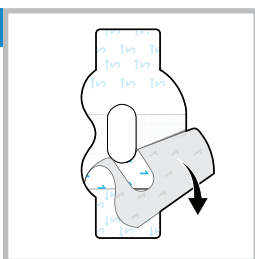

To apply the 2nd tape, remove the liner marked 1.

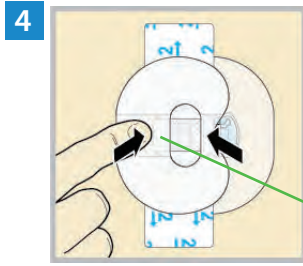

Wide part of tape covers end of transmitter and skin.

Rotate the 2nd tape and place the tape over the transmitter. Press down firmly.

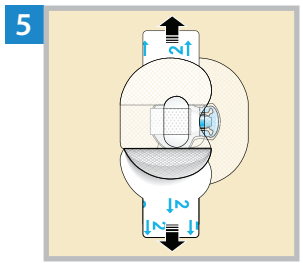

Remove the liner marked 2 from each side.

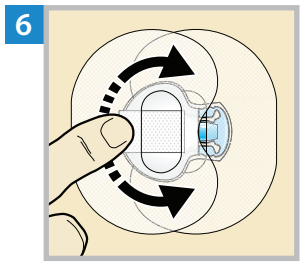

Smooth the tape.

Note: Check the site regularly. Apply additional off-the-shelf tape if the sensor and the transmitter are not secure.

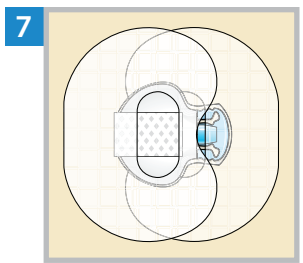

This image is an example of the tape applied correctly.

START THE SENSOR

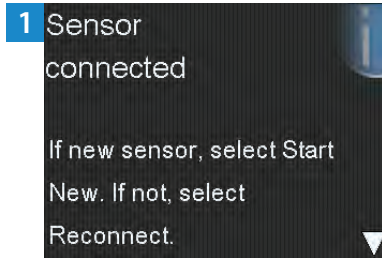

After **Sensor connected** message appears, press ∇ . The message typically takes less than a minute to appear, but may take up to 5 minutes.

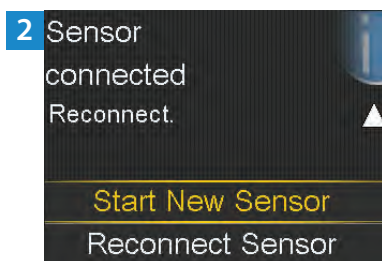

Select **Start New Sensor**.

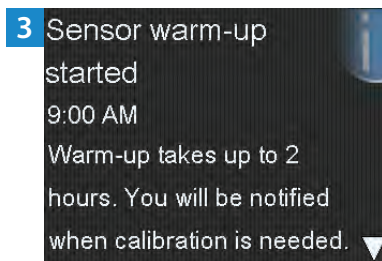

The **Sensor warm-up started** message will appear. Press ∇ and then \odot to clear the message.

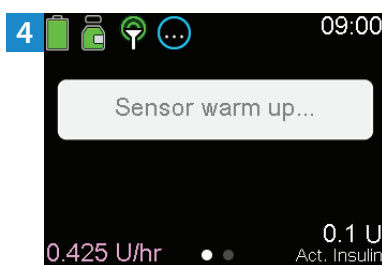

Sensor warm up... will appear on the Home screen until the sensor is ready for the first calibration.

Medtronic



Medtronic MiniMed

18000 Devonshire Street

Northridge, CA 91325

USA

1 800 646 4633

+1 818 576 5555

www.medtronicdiabetes.com



(01)00763000577940(10)NA

© 2023 Medtronic
M810340A015_3
2023-02-23



M810340A015

R_x Only

MINIMED™ QUICK-SET™ INFUSION SET AND RESERVOIR, AND GUARDIAN™ 4 SENSOR QUICK REFERENCE GUIDE



Medtronic

Medtronic and Medtronic logo are trademarks of Medtronic. ^{TM*} Third-party brands are trademarks of their respective owners. All other brands are trademarks of a Medtronic company. The following list includes trademarks or registered trademarks of a Medtronic entity in the United States or in other countries.

MiniMedTM, Quick-setTM

Contents

- **Changing the MiniMed™ Quick-set™ Infusion Set and Reservoir 7**
The MiniMed Quick-set infusion set and the reservoir can be used for up to three days. In most cases, the infusion set and reservoir should be changed at the same time.
- **Disconnecting and Reconnecting the MiniMed Quick-set Infusion Set 23**
- **Changing the MiniMed Reservoir Only 27**
The MiniMed reservoir can be used for up to three days. If the reservoir runs out of insulin and the infusion set has not been used for three full days, the New Reservoir Only option may be used to change the reservoir. The infusion set must still be replaced within three days of use.
- **Changing the MiniMed Quick-set Infusion Set Only 39**
The MiniMed Quick-set infusion set can be used for up to three days. If only the infusion set needs to be changed before three full days of use, the New Set Only option may be used to change the infusion set. The reservoir must still be replaced within three days of use.
- **Inserting the Guardian™ 4 Sensor with One-press Serter 53**

WARNING: The following warning applies to changing the reservoir and infusion set, changing the reservoir only, and changing the infusion set only.

Always confirm that the infusion set tubing is disconnected from the body before doing the following steps:

- placing the reservoir into the pump
- rewinding the pump
- loading the reservoir
- filling the infusion set tubing

Failing to disconnect the infusion set tubing from the body may result in an accidental infusion of insulin, and may cause hypoglycemia.

Changing the MiniMed™ Quick-set™ Infusion Set and Reservoir



The MiniMed Quick-set infusion set and the reservoir can be used for up to three days. In most cases, the infusion set and reservoir should be changed at the same time.

Note: The MiniMed Quick-set infusion set and reservoir can be used for up to three days. To avoid wasting insulin, fill the reservoir with enough insulin to last until the next infusion set change.

START HERE

Follow these steps to change the infusion set and reservoir.

1



Wash hands with soap and water. On the pump, press  to go to the menu screen.

2



Select , and then select **New Reservoir & Set**.

3

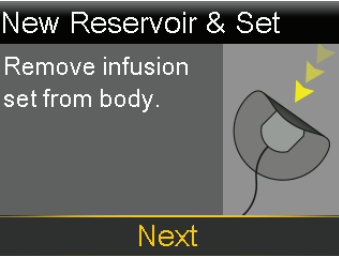

Remove the infusion set by loosening the adhesive and pulling the set away from the body. Select **Next**.

4

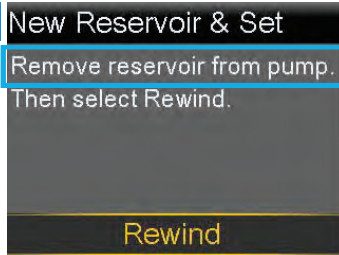

Remove the used reservoir from the pump.

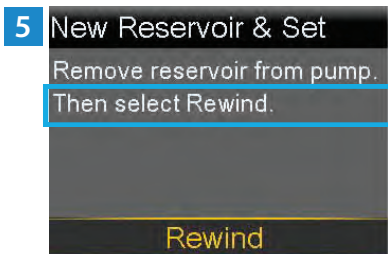

Select **Rewind**.
Do not connect the infusion set to the body.

WARNING: Always confirm that the infusion set is disconnected from the body before rewinding the pump. Failing to disconnect the infusion set from the body may result in an accidental infusion of insulin, and may cause hypoglycemia.

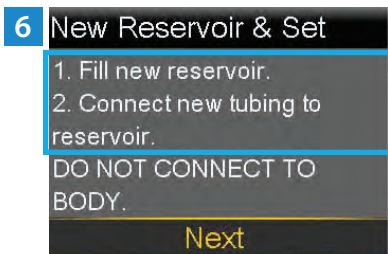

Follow the next steps to fill the new reservoir with insulin and to connect the new infusion set tubing.
Do not select **Next**.

FILL THE RESERVOIR

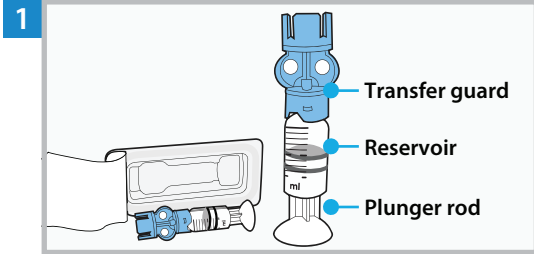

Remove the reservoir from the package. Make sure the insulin vial is at room temperature to reduce the risk of air bubbles.

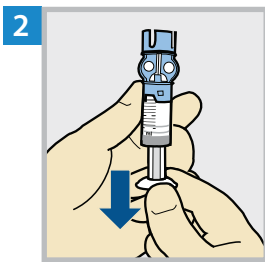

Pull the plunger down based on the planned 2-3 day insulin fill amount.

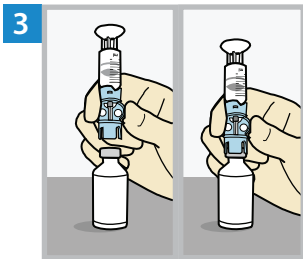

Wipe the top of the vial with alcohol. Place the vial on a sturdy, flat surface. Firmly press the transfer guard onto the vial.

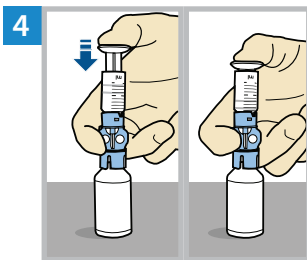

Push and hold the plunger down.

WARNING: Do not use the reservoir or infusion set if insulin or any liquid gets on the top of the reservoir or inside the tubing connector, as shown in the image. Insulin or any liquid can temporarily block the vents. This may result in the delivery of too little or too much insulin, which can cause hyperglycemia or hypoglycemia. If insulin or any liquid gets on the top of the reservoir or inside the tubing connector, start over with a new reservoir and infusion set.

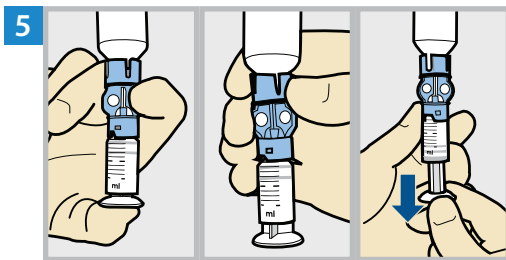
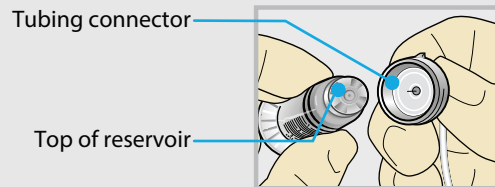

Keeping a thumb on the plunger, flip the vial over so the vial is on top. Release the thumb and pull the plunger down to fill the reservoir with insulin.

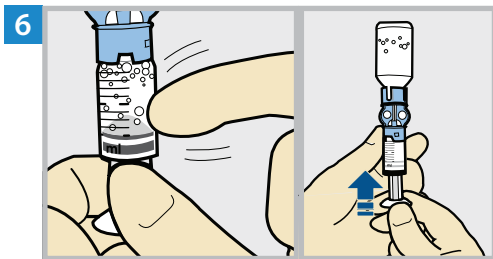

Tap the reservoir to move air bubbles to the top of the reservoir. Push the plunger up to move air into the vial.

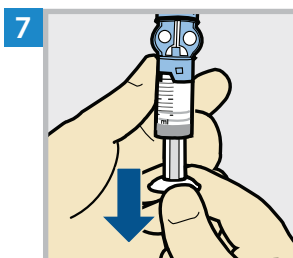

Pull the plunger back down to allow the reservoir to fill with the amount of insulin needed for 2-3 days.

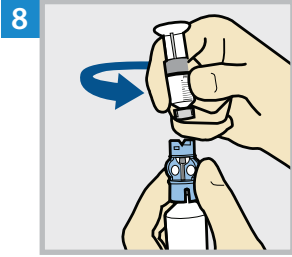

To avoid getting insulin on the top of the reservoir, **flip the vial over again so the reservoir is on top.** Hold the transfer guard and turn the reservoir counter-clockwise and remove the reservoir from the transfer guard.

CONNECT THE INFUSION SET TO THE FILLED RESERVOIR

1 MiniMed™ Quick-set™ Infusion Set

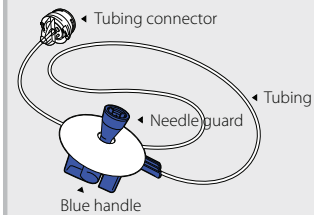

Remove the infusion set tubing from the package. Remove the paper that holds the tubing together and unwind the tubing.

2

Tubing connector

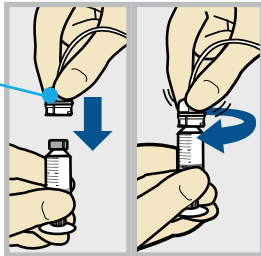

Gently push the tubing connector onto the reservoir. Turn the connector clockwise until it is locked into place.

3

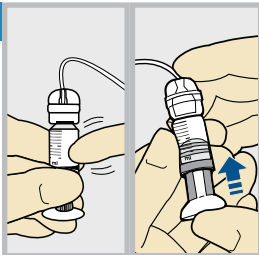

Tap the reservoir to move any air bubbles to the top. Push the plunger slightly to move the bubbles into the tubing.

4

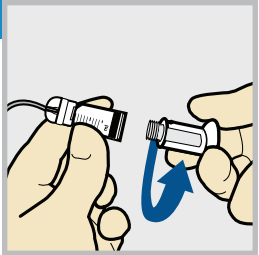

Twist the plunger counter-clockwise to loosen it and to remove it.

PLACE THE RESERVOIR INTO THE PUMP

Note: The backlight may have turned off. Press any button to turn the screen back on. Press  to go to the menu screen, and then select .

1 New Reservoir & Set

1. Fill new reservoir.
2. Connect new tubing to reservoir.
DO NOT CONNECT TO BODY.

Next

Select **Next**.

2 New Reservoir & Set

3. Place reservoir into pump and lock.
DO NOT CONNECT TO BODY.

Next

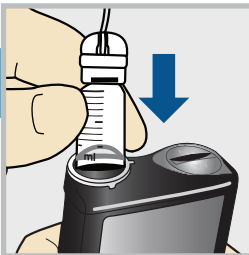

Place the reservoir into the pump.
Do not connect the infusion set to the body.

WARNING: Always confirm that the infusion set is disconnected from the body before placing the reservoir into the pump. Failing to disconnect the infusion set from the body may result in an accidental infusion of insulin, and may cause hypoglycemia.

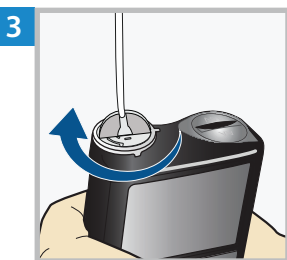

New Reservoir & Set

3. Place reservoir into pump and lock.
DO NOT CONNECT TO BODY.

Next

Turn the reservoir clockwise until the reservoir locks into place, and select **Next**.

LOAD THE RESERVOIR AND FILL THE TUBING

1 Load Reservoir
 Select Load and hold until complete.
 DO NOT CONNECT TO BODY.

 Load Next

Select **Load** and hold  until the checkmark appears on the screen. **Do not** connect the infusion set to the body.

2 Load Reservoir
 Complete
 DO NOT CONNECT TO BODY.

 Load Next

When the checkmark appears, select **Next**.

WARNING: Always confirm that the infusion set is disconnected from the body before loading the reservoir and filling the tubing. Failing to disconnect the infusion set from the body may result in an accidental infusion of insulin, and may cause hypoglycemia.

3 Fill Tubing
 DO NOT CONNECT TO BODY.
 Hold Fill until drops appear.
 Then select Next.
 0.0 U
 Fill Next

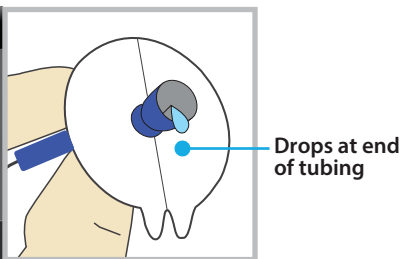

Select **Fill** and keep holding  until there are no air bubbles visible in the tubing, and there are drops at the end of the tubing.
Do not connect the infusion set to the body.

4 Fill Tubing
 DO NOT CONNECT TO BODY.
 Hold Fill until drops appear.
 Then select Next.
 11.3 U
 Fill Next

After drops appear, press  and select **Next**.

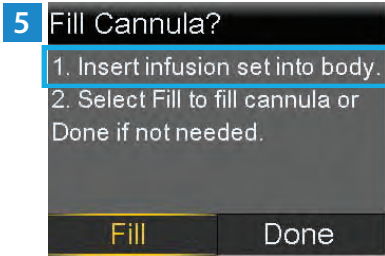

Follow the next steps to insert the infusion set before filling the cannula.

INSERT THE INFUSION SET

1 MiniMed™ Quick-serter™ Insertion Device

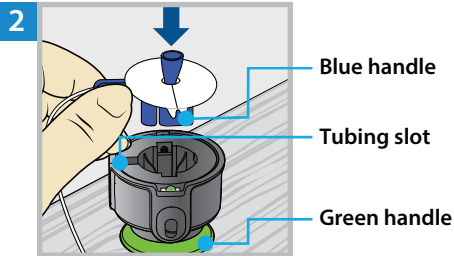
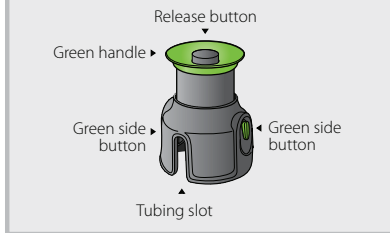

Place the MiniMed Quick-serter insertion device onto a sturdy, flat surface with the green handle facing down. Line up the blue handle of the infusion set with the tubing slot and place the blue handle in the Quick-serter.

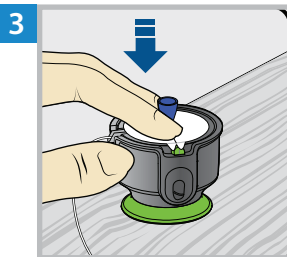

Use two fingers to seat the infusion set inside the serter securely and gently push the set down.



Holding the needle guard, peel the paper from the adhesive on both sides of the needle guard.

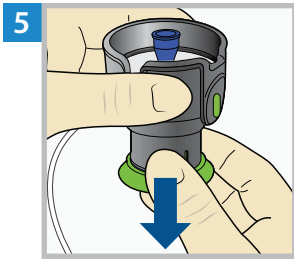

5 Pull the green handle down until there is a click.

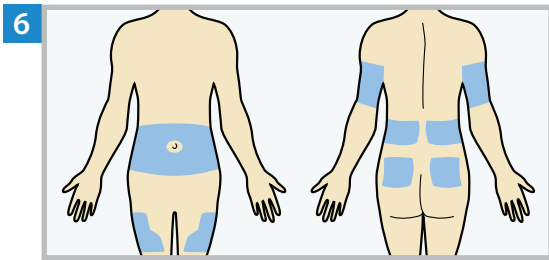

6 Choose an insertion site from the shaded areas shown here. Wipe the site with alcohol or other antiseptic.

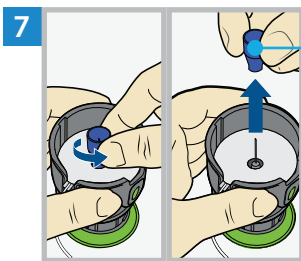

Needle guard

7 Turn the needle guard to loosen it and pull to remove it.

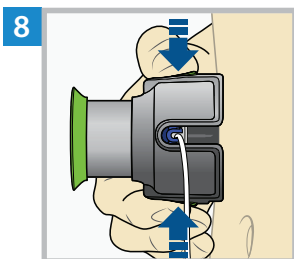

8 Hold the inserter against the cleaned insertion site. Place fingers on the two green side buttons, and press the buttons at the same time. Keep the inserter against the cleaned insertion site.

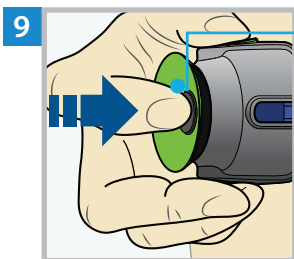

Release button

9 Press down the release button to release the infusion set from the inserter.

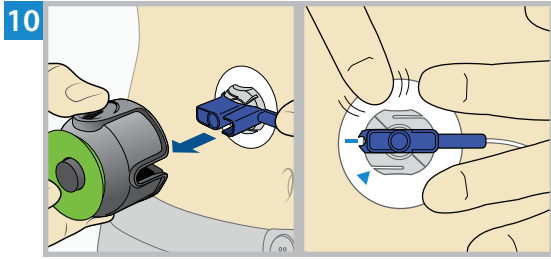

Pull the inserter away from the body. Press the adhesive against the skin all the way around the site.

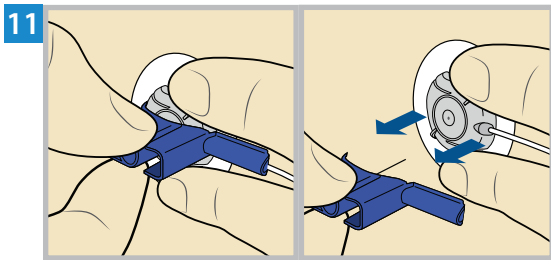

Holding the infusion set, pull the blue handle straight out to remove the needle.

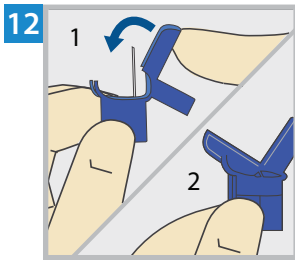

Fold the blue handle over the needle until it locks. Dispose of the blue handle in an appropriate sharps container and in accordance with local laws.

Note: Remove the transfer guard from the vial and dispose of the transfer guard in an appropriate sharps container and in accordance with local laws.

FILL THE CANNULA

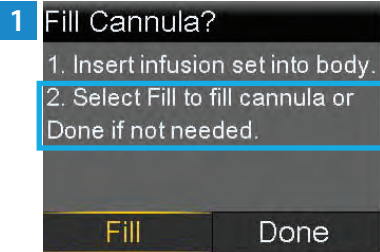

After the infusion set is inserted into the body, select **Fill**.

Note: Always verify that the amount shown in the **Fill amount** field is correct. The pump will remember the fill amount last used. Change the **Fill amount** if needed.



Select **Fill amount** and enter:

- 0.300 U if using the 6 mm cannula
- 0.500 U if using the 9 mm cannula

After entering the cannula fill amount, press .

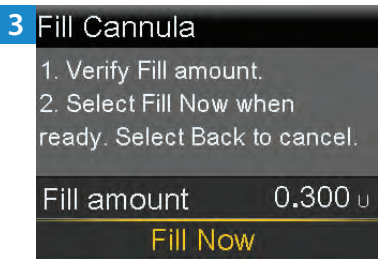

Select **Fill Now**.

The Home screen displays the insulin amount as insulin fills the cannula.

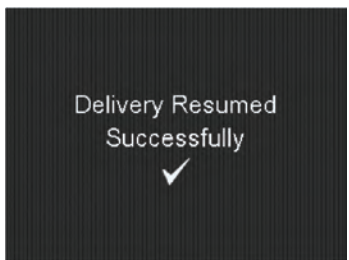

The reservoir and infusion set change is now complete.

Always check blood glucose one to three hours after changing the infusion set or reservoir.

Disconnecting and Reconnecting the MiniMed Quick-set Infusion Set

DISCONNECT THE INFUSION SET

Follow these steps to disconnect the infusion set. Do not remove the adhesive with the cannula housing from the body.

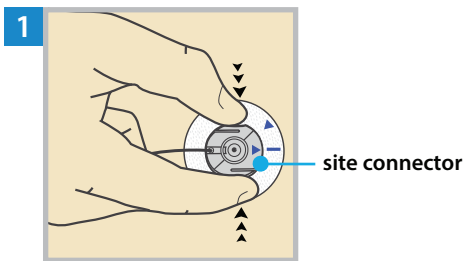

Press the sides of the site connector.

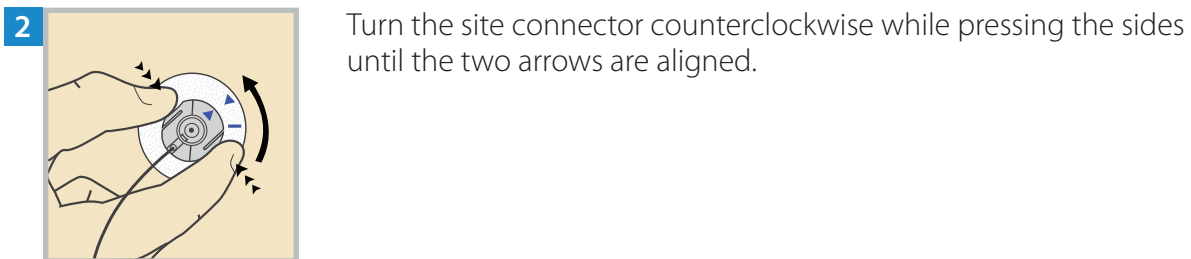

Turn the site connector counterclockwise while pressing the sides until the two arrows are aligned.

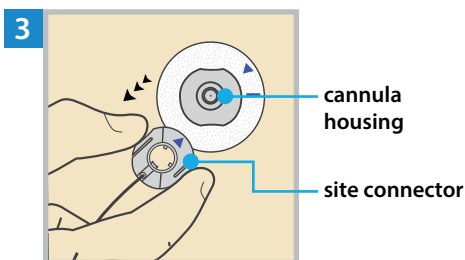

Lift up the site connector to remove it from the cannula housing.

RECONNECT THE INFUSION SET

Follow these steps to reconnect the infusion set.

1

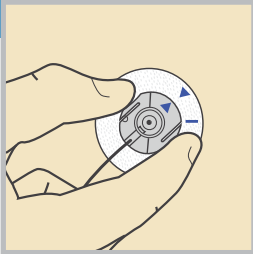

Place the site connector over the cannula housing. Align the blue arrows.

2

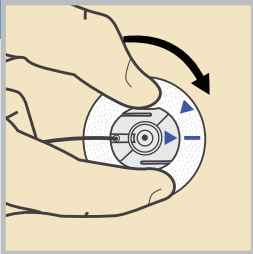

Turn the site connector clockwise without pressing the sides until it locks. The site connector is locked when the arrow on the connector lines up with the blue line on the adhesive.

Changing the MiniMed Reservoir Only



The MiniMed reservoir can be used for up to three days. If the reservoir runs out of insulin and the infusion set has not been used for three full days, the New Reservoir Only option may be used to change the reservoir. The infusion set must still be replaced within three days of use.

Note: The MiniMed Quick-set infusion set and reservoir can be used for up to three days. To avoid wasting insulin, fill the reservoir with enough insulin to last until the next infusion set change.

START HERE

Follow these steps to change the reservoir and keep the current infusion set.

1



Wash hands with soap and water. On the pump, press  to go to the menu screen.

2



Select , and then select **New Reservoir Only**.

3

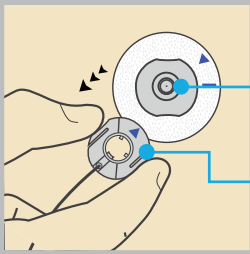
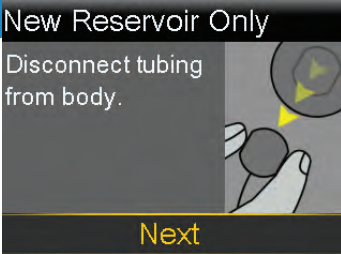

cannula housing
site connector

Disconnect the tubing from the cannula housing. Do not remove the cannula housing from the body. Select **Next**.

4

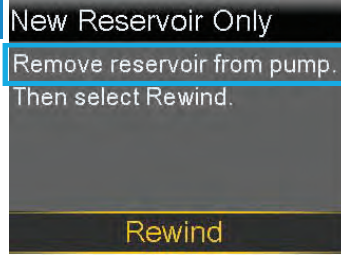

Remove the used reservoir from the pump.

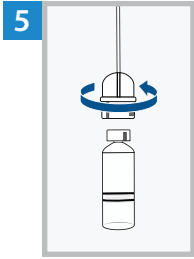

5 Disconnect the infusion set tubing connector from the used reservoir. Place the tubing on a clean surface. Do not throw the tubing away.

Note: Dispose of the used reservoir in an appropriate container and in accordance with local laws.

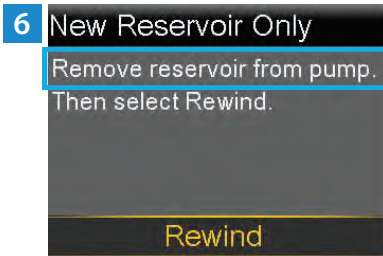

Select **Rewind**.

Do not connect the infusion set to the body.

WARNING: Always confirm that the infusion set is disconnected from the body before rewinding the pump. Failing to disconnect the infusion set from the body may result in an accidental infusion of insulin, and may cause hypoglycemia.

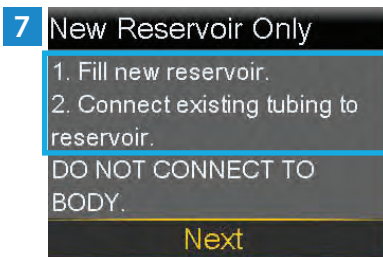

Follow the next steps to fill the new reservoir with insulin and to connect the infusion set tubing to the reservoir.

Do not select **Next**.

FILL THE RESERVOIR

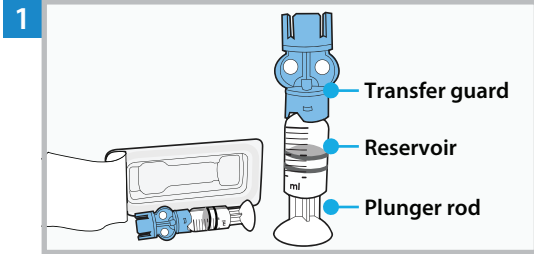

Remove the reservoir from the package. Make sure the insulin vial is at room temperature to reduce the risk of air bubbles.

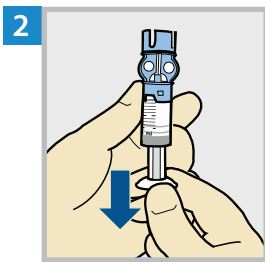

Pull the plunger down based on the planned 2-3 day insulin fill amount.

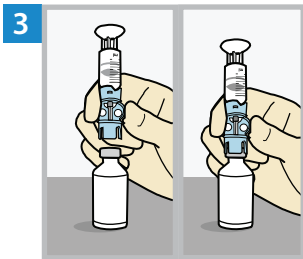

Wipe the top of the vial with alcohol. Place the vial on a sturdy, flat surface. Firmly press the transfer guard onto the vial.

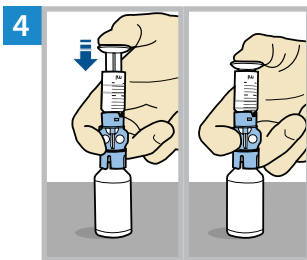

Push and hold the plunger down.

WARNING: Do not use the reservoir or infusion set if insulin or any liquid gets on the top of the reservoir or inside the tubing connector, as shown in the image. Insulin or any liquid can temporarily block the vents. This may result in the delivery of too little or too much insulin, which can cause hyperglycemia or hypoglycemia. If insulin or any liquid gets on the top of the reservoir or inside the tubing connector, start over with a new reservoir and infusion set.

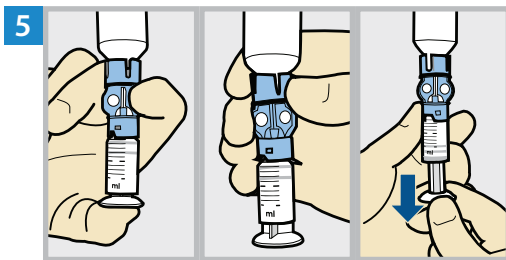
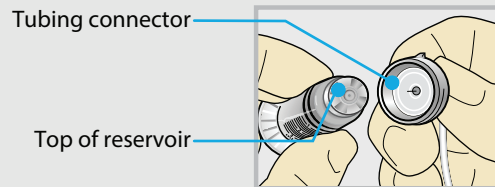

Keeping a thumb on the plunger, flip the vial over so the vial is on top. Release the thumb and pull the plunger down to fill the reservoir with insulin.

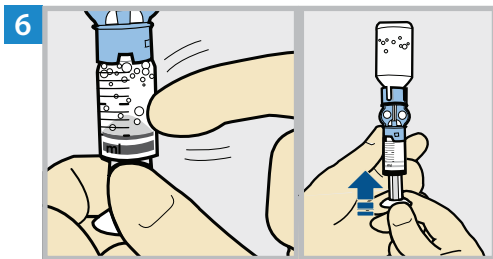

Tap the reservoir to move air bubbles to the top of the reservoir. Push the plunger up to move air into the vial.

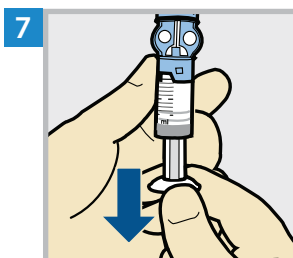

Pull the plunger back down to allow the reservoir to fill with the amount of insulin needed for 2-3 days.

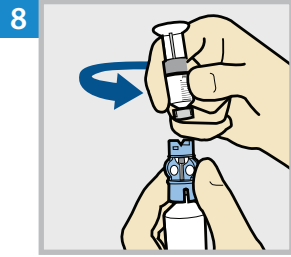

To avoid getting insulin on the top of the reservoir, **flip the vial over again so the reservoir is on top.** Hold the transfer guard and turn the reservoir counter-clockwise and remove the reservoir from the transfer guard.

CONNECT THE INFUSION SET TO THE RESERVOIR

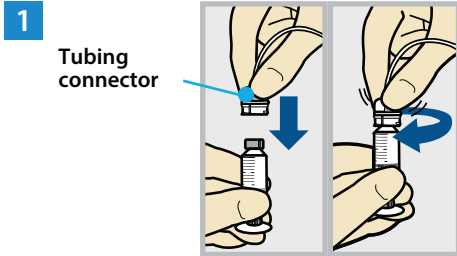

Gently push the tubing connector onto the reservoir.
Turn the connector clockwise until it is locked into place.

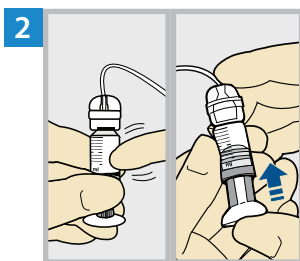

Tap the reservoir to move any air bubbles to the top. Push the plunger slightly to move the bubbles into the tubing.

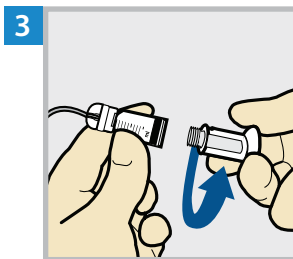

Twist the plunger counter-clockwise to loosen it and to remove it.

PLACE THE RESERVOIR INTO THE PUMP

1 New Reservoir Only

1. Fill new reservoir.
2. Connect existing tubing to reservoir.
DO NOT CONNECT TO BODY.

Next

Select **Next**.

2 New Reservoir Only

3. Place reservoir into pump and lock.
DO NOT CONNECT TO BODY.

Next

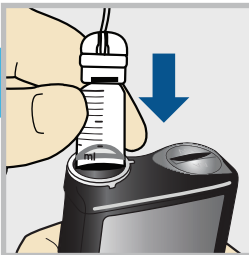

Place the reservoir into the pump. **Do not** connect the infusion set to the body.

WARNING: Always confirm that the infusion set is disconnected from the body before placing the reservoir into the pump. Failing to disconnect the infusion set from the body may result in an accidental infusion of insulin, and may cause hypoglycemia.

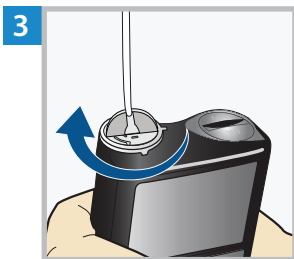

New Reservoir Only

3. Place reservoir into pump and lock.
DO NOT CONNECT TO BODY.

Next

Turn the reservoir clockwise until the reservoir locks into place, and select **Next**.

LOAD THE RESERVOIR AND FILL THE TUBING

1 Load Reservoir

Select Load and hold until complete.
DO NOT CONNECT TO BODY.



Load Next

Select **Load** and hold  until the checkmark appears on the screen. **Do not** connect the infusion set to the body.

2 Load Reservoir

Complete
DO NOT CONNECT TO BODY.



Load Next

When the checkmark appears, select **Next**.

WARNING: Always confirm that the infusion set is disconnected from the body before loading the reservoir and filling the tubing. Failing to disconnect the infusion set from the body may result in an accidental infusion of insulin, and may cause hypoglycemia.

3 Fill Tubing

DO NOT CONNECT TO BODY.
Hold Fill until drops appear.
Then select Next.

0.0 U

Fill Next

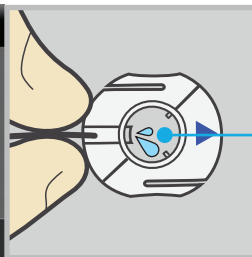

Drops at end of tubing

Select **Fill** and keep holding  until there are no air bubbles visible in the tubing, and there are drops at the end of the tubing.

Do not connect the infusion set to the body.

4 Fill Tubing

DO NOT CONNECT TO BODY.
Hold Fill until drops appear.
Then select Next.

11.3 U

Fill Next

After drops appear, press  and select **Next**.

RECONNECT THE TUBING TO THE INFUSION SITE

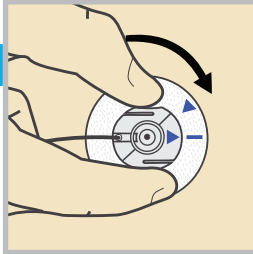
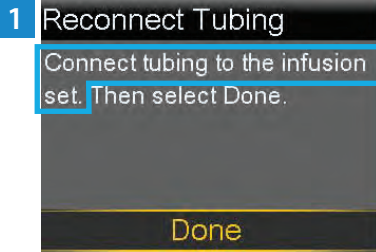

Place the site connector over the cannula housing. Align the blue arrows. Turn the site connector clockwise without pressing the sides until it locks. The site connector is locked when the arrow on the connector lines up with the blue line on the adhesive.

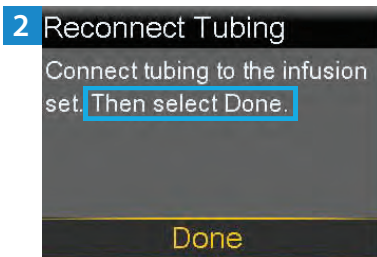

It is not necessary to fill the cannula because the infusion set was not changed. Select **Done**.



The reservoir change is now complete.

Always check blood glucose one to three hours after changing the reservoir.

Note: Remove the transfer guard from the vial and dispose of the transfer guard in an appropriate sharps container and in accordance with local laws.

Changing the MiniMed Quick-set Infusion Set Only

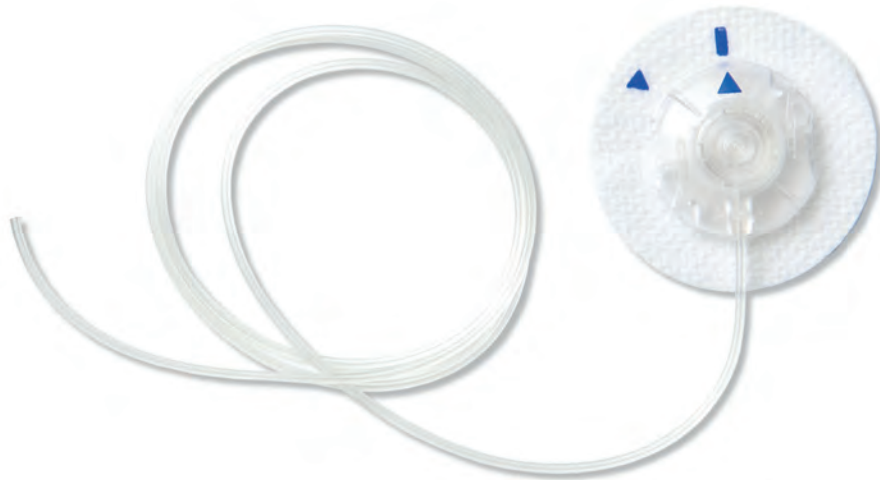

The MiniMed Quick-set infusion set can be used for up to three days. If only the infusion set needs to be changed before three full days of use, the New Set Only option may be used to change the infusion set. The reservoir must still be replaced within three days of use.

START HERE

Follow these steps to change the infusion set and to keep the current reservoir.

1



Wash hands with soap and water. On the pump, press  to go to the menu screen.

2

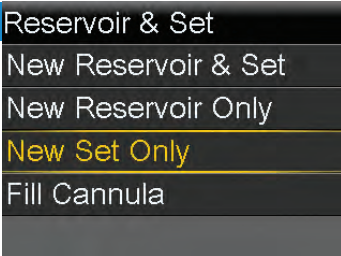

Select , and then select **New Set Only**.

3

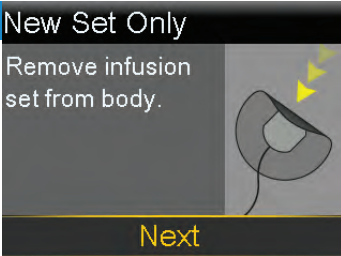

Remove the entire infusion set by loosening the adhesive and pulling the set away from the body. Select **Next**.

4

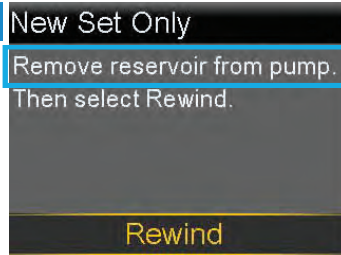

Remove the reservoir from the pump.

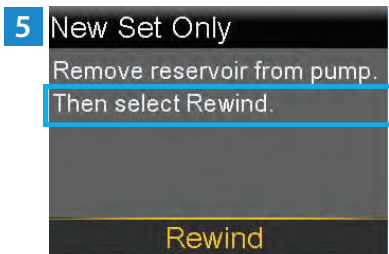

Select **Rewind**.
Do not connect the infusion set to the body.

WARNING: Always confirm that the infusion set is disconnected from the body before rewinding the pump. Failing to disconnect the infusion set from the body may result in an accidental infusion of insulin, and may cause hypoglycemia.



DISCONNECT THE INFUSION SET FROM THE RESERVOIR

1 New Set Only

1. Disconnect existing tubing from the reservoir.
2. Connect new tubing to existing reservoir.

Next

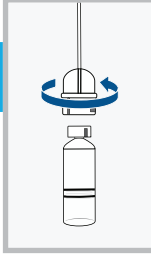

Disconnect the tubing connector of the used infusion set tubing from the reservoir. Place the reservoir on a clean surface. Do not throw the reservoir away.

Note: Dispose of all parts of the infusion set, including the tubing, in an appropriate sharps container and in accordance with local laws.

CONNECT THE INFUSION SET TO THE RESERVOIR

1 New Set Only

1. Disconnect existing tubing from the reservoir.
2. Connect new tubing to existing reservoir.

Next

Follow these steps to connect the infusion set to the reservoir.

2 MiniMed™ Quick-set™ Infusion Set

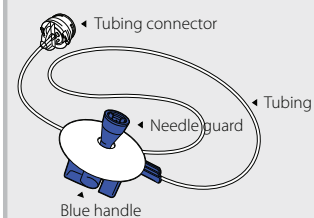

Remove the infusion set tubing from the package. Remove the paper that holds the tubing together and unwind the tubing.

3

Tubing connector

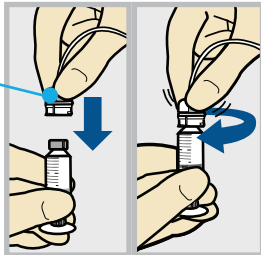

Gently push the tubing connector onto the reservoir. Turn the connector clockwise until it is locked into place.

WARNING: Do not use the reservoir or infusion set if insulin or any liquid gets on the top of the reservoir or inside the tubing connector, as shown in the image. Insulin or any liquid can temporarily block the vents. This may result in the delivery of too little or too much insulin, which can cause hyperglycemia or hypoglycemia. If insulin or any liquid gets on the top of the reservoir or inside the tubing connector, start over with a new reservoir and infusion set.

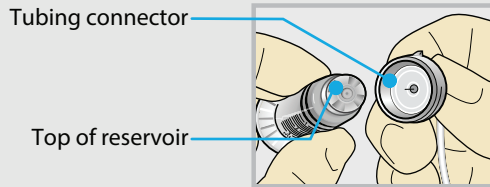

PLACE THE RESERVOIR INTO THE PUMP

1 New Set Only

1. Disconnect existing tubing from the reservoir.
2. Connect new tubing to existing reservoir.

Next

Select **Next**.

2 New Set Only

3. Place reservoir into pump and lock.

DO NOT CONNECT TO BODY.

Next

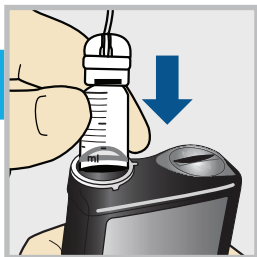

Place the reservoir into the pump.
Do not connect the infusion set to the body.

WARNING: Always confirm that the infusion set is disconnected from the body before placing the reservoir into the pump. Failing to disconnect the infusion set from the body may result in an accidental infusion of insulin, and may cause hypoglycemia.

3

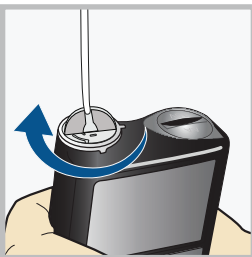

New Set Only

3. Place reservoir into pump and lock.
- DO NOT CONNECT TO BODY.

Next

Turn the reservoir clockwise until the reservoir locks into place, and select **Next**.

LOAD THE RESERVOIR AND FILL THE TUBING

1 Load Reservoir
 Select Load and hold until complete.
 DO NOT CONNECT TO BODY.



Select **Load** and hold  until the checkmark appears on the screen. **Do not** connect the infusion set to the body.

2 Load Reservoir
 Complete
 DO NOT CONNECT TO BODY.

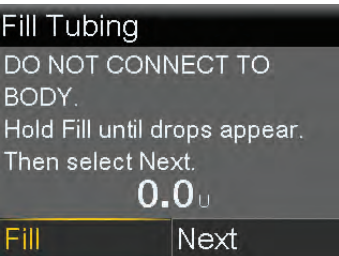

When the checkmark appears, select **Next**.

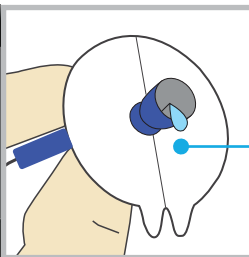
WARNING: Always confirm that the infusion set is disconnected from the body before loading the reservoir and filling the tubing. Failing to disconnect the infusion set from the body may result in an accidental infusion of insulin, and may cause hypoglycemia.

3 Fill Tubing
 DO NOT CONNECT TO BODY.
 Hold Fill until drops appear.
 Then select Next.
 0.0_U



Drops at end of tubing

Select **Fill** and keep holding  until there are no air bubbles visible in the tubing, and there are drops at the end of the tubing.

Do not connect the infusion set to the body.

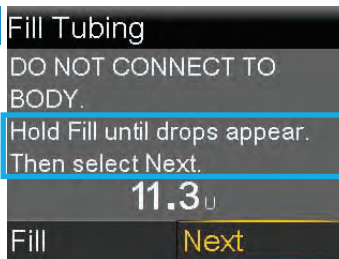
4 Fill Tubing
 DO NOT CONNECT TO BODY.
 Hold Fill until drops appear.
 Then select Next.
 11.3_U

After drops appear, press  and select **Next**.

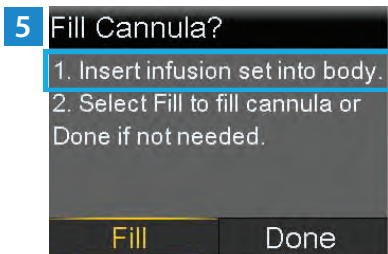

Follow the next steps to insert the infusion set before filling the cannula.

INSERT THE INFUSION SET

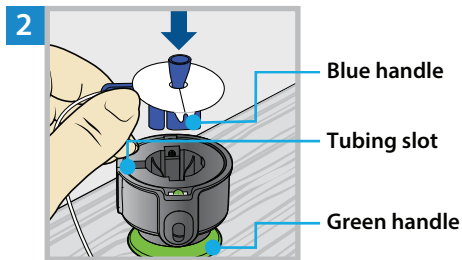
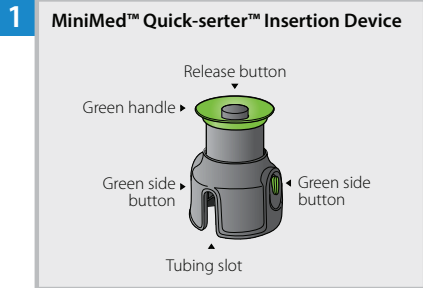

Place the MiniMed Quick-serter insertion device onto a sturdy, flat surface with the green handle facing down. Line up the blue handle of the infusion set with the tubing slot and place the blue handle in the Quick-serter.

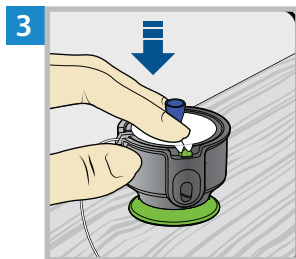

Use two fingers to seat the infusion set inside the serter securely and gently push the set down.



Holding the needle guard, peel the paper from the adhesive on both sides of the needle guard.

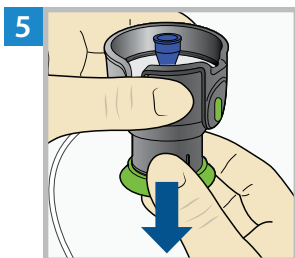

5 Pull the green handle down until there is a click.

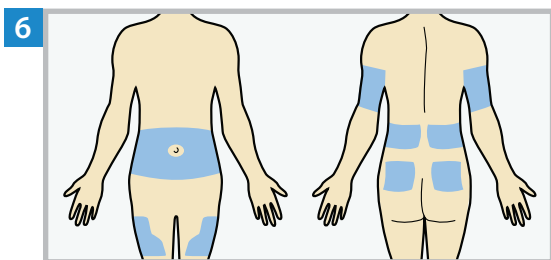

6 Choose an insertion site from the shaded areas shown here. Wipe the site with alcohol or other antiseptic.

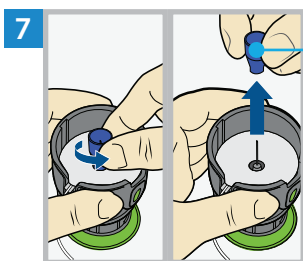

Needle guard

7 Turn the needle guard to loosen it and pull to remove it.

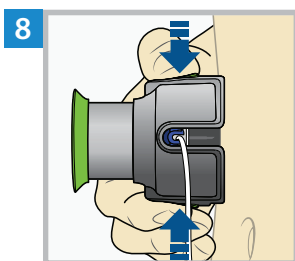

8 Hold the serter against the cleaned insertion site. Place fingers on the two green side buttons, and press the buttons at the same time. Keep the serter against the cleaned insertion site.

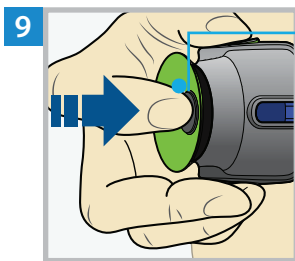

Release button

9 Press down the release button to release the infusion set from the serter.

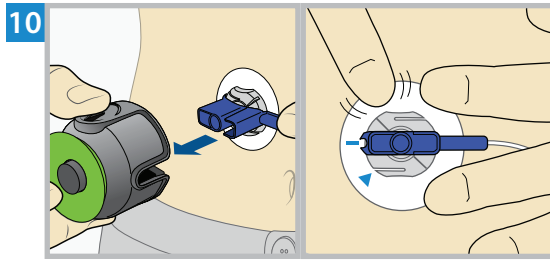

Pull the inserter away from the body. Press the adhesive against the skin all the way around the site.

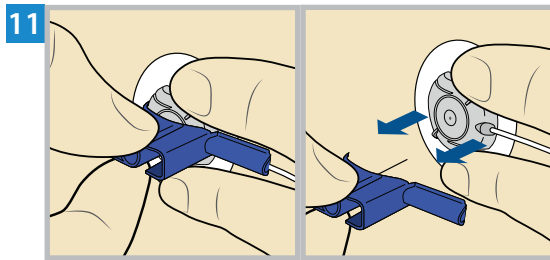

Holding the infusion set, pull the blue handle straight out to remove the needle.

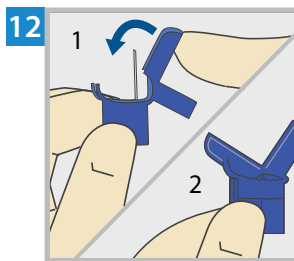

Fold the blue handle over the needle until it locks. Dispose of the blue handle in an appropriate sharps container and in accordance with local laws.

Note: Remove the transfer guard from the vial and dispose of the transfer guard in an appropriate sharps container and in accordance with local laws.

FILL THE CANNULA

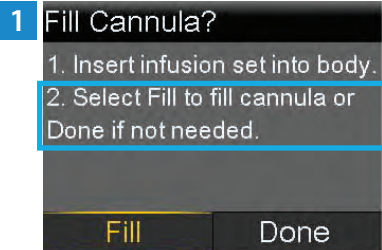

After the infusion set is inserted into the body, select **Fill**.

Note: Always verify that the amount shown in the Fill amount field is correct. The pump will remember the fill amount last used. Change the Fill amount if needed.



Select Fill amount and enter:

- 0.300 U if using the 6 mm cannula
- 0.500 U if using the 9 mm cannula

After entering the cannula fill amount, press .

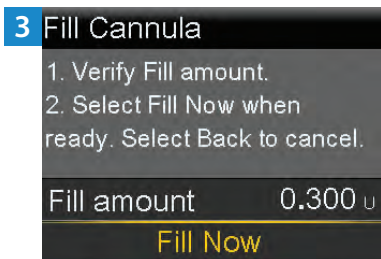

Select **Fill Now**.

The Home screen displays the insulin amount as insulin fills the cannula.

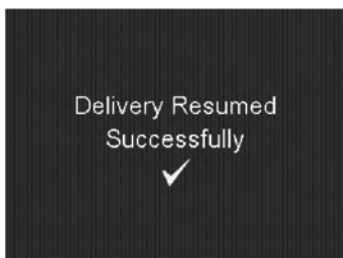

The infusion set change is now complete.

Always check blood glucose one to three hours after changing the infusion set.

Inserting the Guardian™ 4 Sensor with One-press Serter



INSERT THE SENSOR

Choose an insertion site that has an adequate amount of subcutaneous fat. The Guardian 4 sensor has been studied and is approved for use in the following sensor insertion sites by persons of the following ages:

Approved Age	Sensor Insertion Site
7 and older	Arm

CAUTION: The Guardian 4 sensor is indicated for arm use only. Do not use Guardian 4 sensor in the abdomen or other body sites including the buttocks, due to unknown or different performance that could result in hypoglycemia or hyperglycemia.

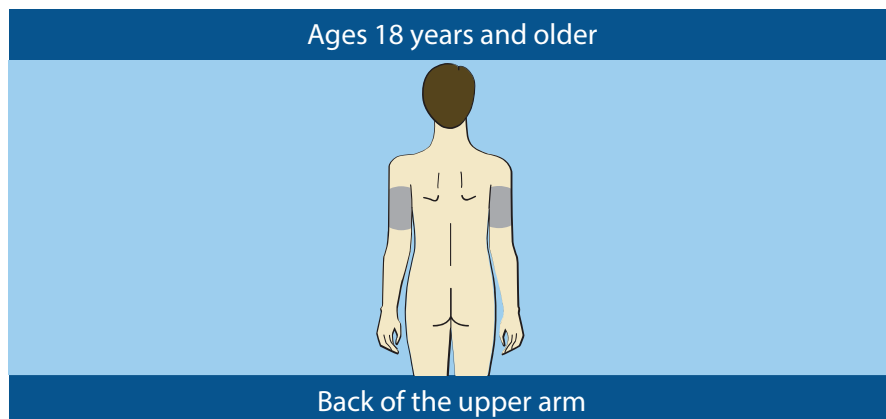
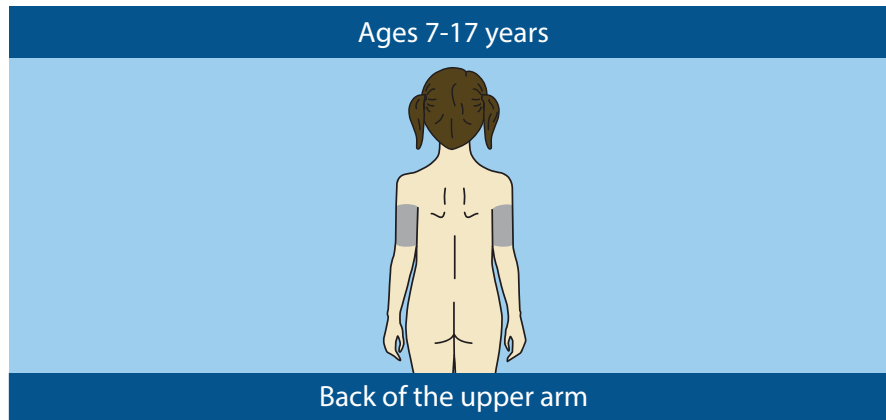

Note: Assistance will likely be needed for sensor insertion into the back of the upper arm. Some users find it difficult to insert the sensor into their arm by themselves.

INSERT A NEW SENSOR

Wash hands with soap and water and clean the insertion site with alcohol.



1 **Open the sensor package.** Pull the corner of the paper covering to open the sensor package.

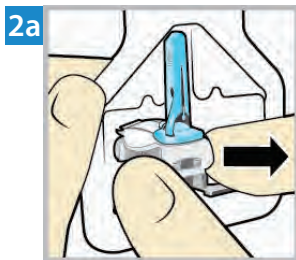

2a **Hold the sensor by the plastic pedestal.** Remove the sensor with attached pedestal from the packaging by holding the pedestal only. Place the sensor with the pedestal on a clean, flat surface (such as a table).



Correct



Incorrect

Tuck the adhesive tab. Make sure that the sensor's adhesive tab is tucked under the sensor connector and snaps.

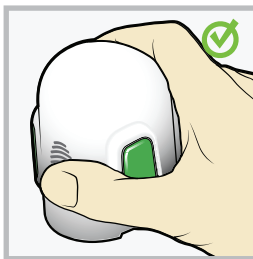

Correct

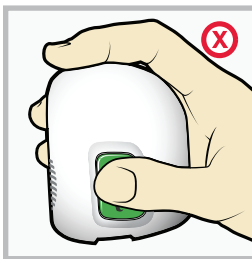

Incorrect

Note: Refer to the illustrations for correct and incorrect ways to hold the serter for loading.

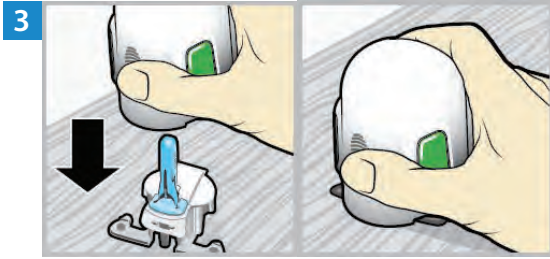

3 **Load the sensor into the serter.** Grip the serter exactly as shown **with a thumb on the thumb print on the serter. Do not hold the side buttons.** Push the serter down onto the pedestal until the base of the serter sits flat on the table.

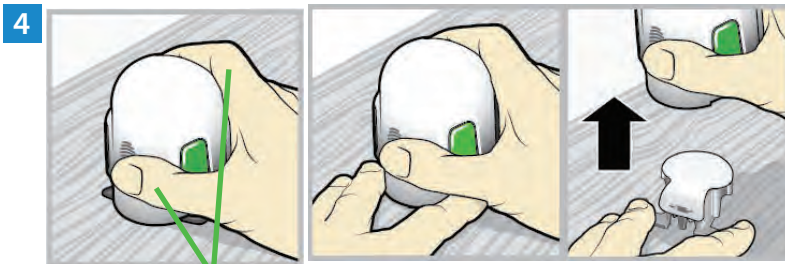

Fingers are NOT holding the side buttons.

4 **Detach the serter from the pedestal.** To detach the serter from the pedestal, grip the serter as shown with a thumb on the thumb print on the serter. With the other hand, place two fingers on the pedestal arms, and slowly pull the serter straight up.

Note: Make sure that the pedestal is firmly on the table before pulling the serter away.

CAUTION: Do not detach the pedestal from the serter in mid-air as this may damage the sensor.



5a **Place the serter on the body.** Hold the serter steadily against the cleaned insertion site without pushing the serter too deeply into the skin.

Note: Failing to hold the serter securely flat against the body may allow the serter to spring back after pressing buttons and result in improper insertion of the sensor.

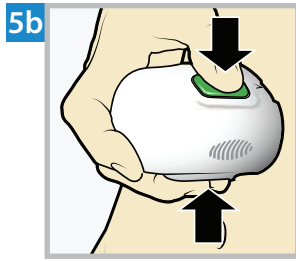

5b **Insert the sensor.** Press the **bump** on both buttons and release them at the same time.

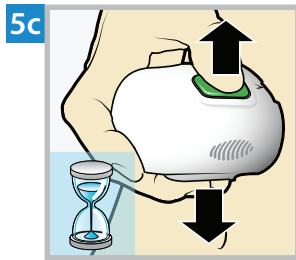

5c **Hold the serter against the body.** Continue holding the serter against the body for at least five seconds to allow the adhesive to stick to the skin.

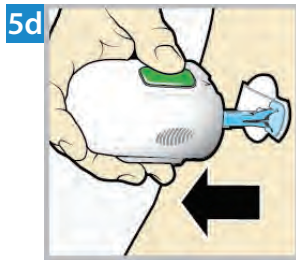

5d **Remove the serter from body.** Slowly pull the serter away from the skin, making sure the buttons are not pressed.

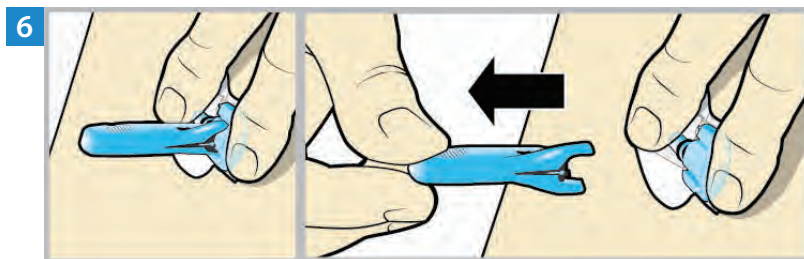

6 **Remove the needle housing.** Gently hold the base of the sensor against the skin with one hand. With the other hand, hold the needle housing **at the top** and slowly pull it straight away from the sensor. Dispose of the needle housing in a sharps container.

Note: An optional, liquid adhesive, such as Skin Tac™, may be used on the skin. Apply the adhesive and allow the skin to dry before removing the adhesive pad liner.

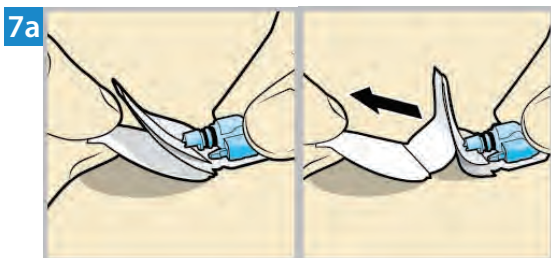

Remove the adhesive pad liner. Hold the sensor in place and gently remove the liner from under the adhesive pad.

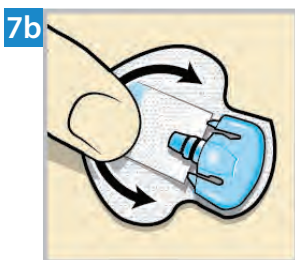

Press the entire adhesive pad to the skin. Firmly press the adhesive pad against the skin and smooth the entire adhesive pad so it sticks to the skin.

Note: The sensor adhesive is sensitive to pressure. Continue applying pressure on the adhesive to ensure that the sensor remains inserted in the skin for 7 days of wear.

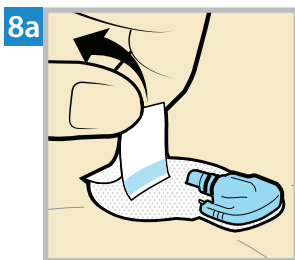

Untuck the adhesive tab. Untuck the adhesive tab from under the sensor connector.

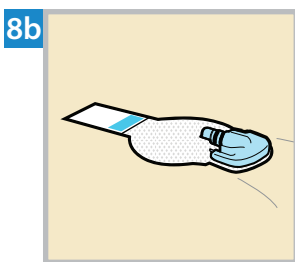

Straighten the adhesive tab. Straighten the adhesive tab so it lies flat against the skin, but do not remove the adhesive liner yet.

TAPE THE SENSOR

1

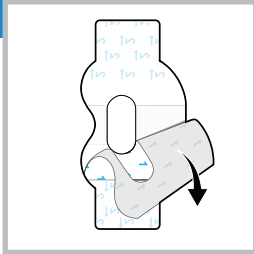

Remove the liner marked 1.

2

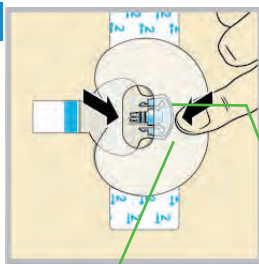

Wide part of tape covers half of sensor base.

Both sensor and skin are taped.

Apply the tape as shown and press down firmly.

3

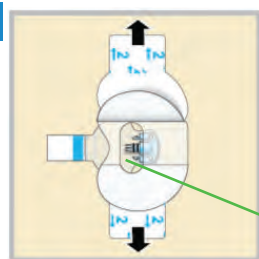

Connector and snaps in hole of tape.

Remove the liner marked 2 from each side.

4

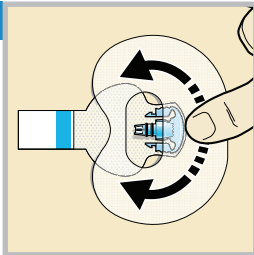

Smooth the tape.

CONNECT THE TRANSMITTER

1

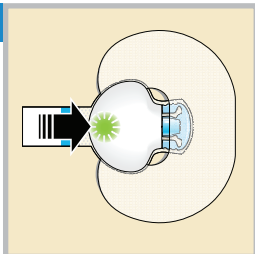

Connect the transmitter to the sensor.

Note: Wait for the green light on the transmitter to flash. If the green light does not flash, refer to Troubleshooting section of the transmitter user guide.

2

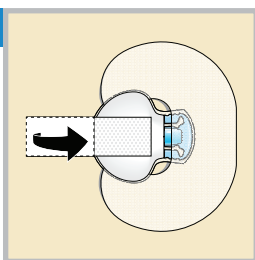

Cover the transmitter with the adhesive tab.

Note: Do not pull the tab too tightly.

3

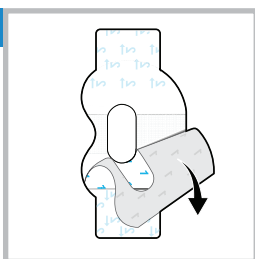

To apply the 2nd tape, remove the liner marked 1.

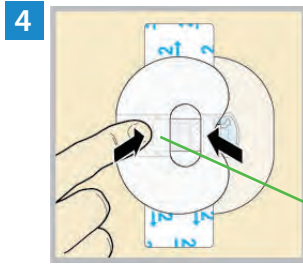

Wide part of tape covers end of transmitter and skin.

Rotate the 2nd tape and place the tape over the transmitter. Press down firmly.

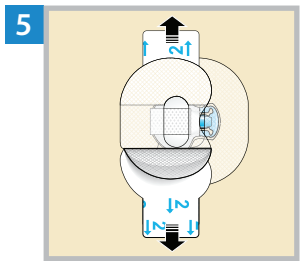

Remove the liner marked 2 from each side.

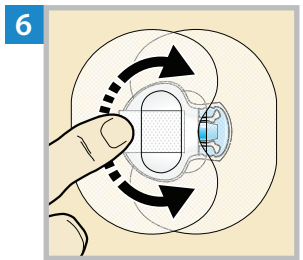

Smooth the tape.

Note: Check the site regularly. Apply additional off-the-shelf tape if the sensor and the transmitter are not secure.

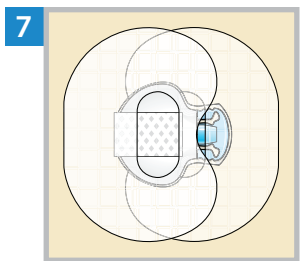

This image is an example of the tape applied correctly.

START THE SENSOR

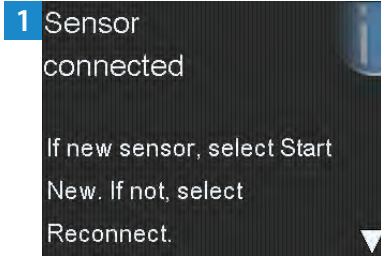

After **Sensor connected** message appears, press ▼. The message typically takes less than a minute to appear, but may take up to 5 minutes.

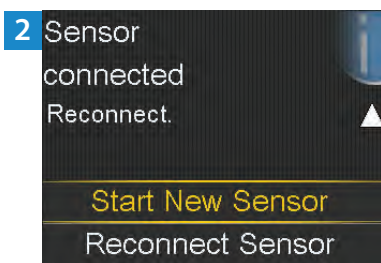

Select **Start New Sensor**.

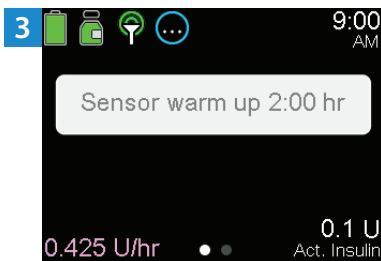

Sensor warm up X:XX hr will appear on the Home screen. After the warm up is complete, the pump begins receiving SG readings.

Medtronic



Medtronic MiniMed

18000 Devonshire Street

Northridge, CA 91325

USA

1 800 646 4633

+1 818 576 5555

www.medtronicdiabetes.com



(01)00763000741075(10)NA

© 2023 Medtronic
M037228C001_2
2023-02-23



M037228C001

R_x Only

Guardian™ 4

Sensor User Guide



Introduction

The Guardian 4 sensor is part of the Continuous Glucose Monitoring (CGM) system. The sensor converts small amounts of glucose from the interstitial fluid under the skin into an electronic signal. The system then uses these signals to provide sensor glucose values.



Sensor assembly

Indications for use

The Guardian 4 sensor (MMT-7040) is intended to monitor glucose levels for the management of diabetes for persons ages seven years and older. It is indicated for use as an adjunctive device to complement, not replace, information obtained from the standard blood glucose monitoring devices. The sensor is intended for single use and requires a prescription. The Guardian 4 sensor is indicated for **up to** seven days of continuous use. Refer to the system user guide for treatment decisions.

Contraindications

Refer to the system guide for contraindications associated with Guardian 4 sensor use.

User safety

Warnings

Read this entire user guide before attempting to insert the Guardian 4 sensor. The one-pressserter (MMT-7512) is the onlyserter approved for use with the sensor. Failure to follow directions, or the use of a different insertion device, may result in improper insertion, pain, or injury.

Do not attempt to connect a transmitter or recorder that is not compatible with the sensor. The sensor is designed to work with approved transmitters only. Connecting the sensor to a transmitter or recorder that is not approved for use with the sensor may damage the components. Refer to the system user guide for a list of compatible products.

Do not use continuous glucose monitoring if hydroxyurea, also known as hydroxycarbamide, is taken. Hydroxyurea is used to treat certain diseases, such as cancer and sickle cell anemia. Hydroxyurea use results in higher sensor glucose readings compared to blood glucose readings. Taking hydroxyurea while using continuous glucose monitoring can result in substantially

higher sensor glucose readings in reports than actual blood glucose readings. For pump users, taking hydroxyurea while using continuous glucose monitoring can result in hypoglycemia caused by over-delivery of insulin.

Always check the label of any medication being taken to confirm if hydroxyurea or hydroxycarbamide is an active ingredient. If hydroxyurea is taken, consult a healthcare professional. Use additional blood glucose meter readings to verify glucose levels.

Taking medications that contain acetaminophen or paracetamol, including, but not limited to fever reducers and cold medicine, while wearing the sensor, may falsely raise sensor glucose readings. The level of inaccuracy depends on the amount of acetaminophen or paracetamol active in the body and may be different for each person. Always check the label of any medications to confirm whether acetaminophen or paracetamol is an active ingredient.

Do not expose the sensor to MRI equipment, diathermy devices, or other devices that generate strong magnetic fields. The performance of the sensor has not been evaluated under those conditions and may be unsafe. If the sensor is exposed to a strong magnetic field, discontinue use and contact 24-hour Technical support for further assistance.

Always inspect the packaging for damage prior to use. Sensors are sterile and non-pyrogenic, unless the package has been opened or damaged. If the sensor packaging is open or damaged, discard the sensor directly into a sharps container. Use of a non-sterile sensor may result in infection at the insertion site.

Do not allow children to put small parts in their mouth. This product poses a choking hazard for young children.

Do not use the Guardian 4 sensor if you are pregnant or critically ill. Since the sensor has not been studied in these populations, the impact of medications common to these conditions on sensor performance is unknown and the sensor may be inaccurate in these populations.

Healthcare professionals and caregivers:

- Always wear gloves to insert the sensor. A retractable needle is attached to the sensor. Minimal bleeding may occur.
- Cover the sensor with sterile gauze to remove the needle housing from the sensor.

Place the needle housing directly into a sharps container after sensor insertion to prevent accidental needlestick injury.

Watch for bleeding at the insertion site (under, around, or on top of the sensor).

If bleeding occurs, do the following:

1. Apply steady pressure, using sterile gauze or a clean cloth placed on top of the sensor, for up to three minutes. The use of unsterile gauze may cause site infection.
2. If bleeding stops, connect the transmitter (or recorder) to the sensor.

If bleeding does not stop, do not connect the transmitter to the sensor because blood may get into the transmitter connector, and may damage the device.

If bleeding continues, causes excessive pain or discomfort, or is significantly visible in the plastic base of the sensor, do the following:

1. Remove the sensor and continue to apply steady pressure until the bleeding stops. Discard the sensor in a sharps container.
2. Check the site for redness, bleeding, irritation, pain, tenderness, or inflammation. Treat based on instructions from a healthcare professional.
3. Insert a new sensor in a different location.

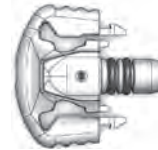

Plastic base

For questions or concerns related to sensor use, contact 24-Hour Technical Support for assistance.

For medical questions or concerns, contact a healthcare professional.

Precautions

Wash hands with soap and water before inserting the Guardian 4 sensor to help prevent site infection.

Do not insert the sensor through tape. Inserting the sensor through tape may cause improper sensor insertion and function.

Only use alcohol to prepare the insertion site. Using alcohol to prepare the insertion site makes sure that residue is not left on the skin.

Rotate the sensor insertion site so that sites do not become overused.

Do not clean, resterilize, or try to extract the needle from the needle housing. An accidental needlestick or puncture may occur.

Do not reuse sensors. Reuse of a sensor may cause damage to the sensor surface and lead to inaccurate glucose values, site irritation, or infection.

Risks and side effects

Risks related to sensor use include

- Skin irritation or other reactions
- Bruising
- Discomfort
- Redness
- Bleeding
- Pain
- Rash
- Infection
- Raised bump
- Appearance of a small “freckle-like” dot where the sensor was inserted
- Allergic reaction
- Fainting secondary to anxiety or fear of needle insertion
- Soreness or tenderness
- Swelling at insertion site
- Sensor fracture, breakage or damage
- Minimal blood splatter associated with sensor needle removal
- Residual redness associated with adhesive or tapes or both
- Scarring

Reagents



The Guardian 4 sensor contains two biological reagents: glucose oxidase, and human serum albumin (HSA). Glucose oxidase is derived from *Aspergillus niger* and manufactured to meet industry requirements for the extraction and purification of enzymes for use in diagnostic, immunodiagnostic, and biotechnical applications.

The HSA used on the sensor consists of purified and dried albumin fraction V derived from pasteurized human serum, which is cross-linked via glutaraldehyde. Approximately 3 µg of glucose oxidase and approximately 10 µg of HSA are used to manufacture each sensor. HSA is approved for IV infusion in humans at quantities much larger than in the sensor.

Removing the sensor

To change the Guardian 4 sensor, disconnect the transmitter from the sensor as described in the Guardian 4 transmitter user guide. Gently pull the sensor from the body to remove it. Discard the sensor in a sharps container.

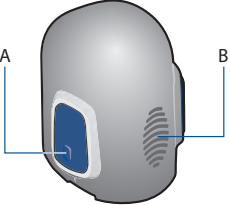
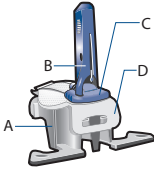
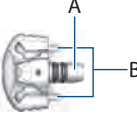
Components

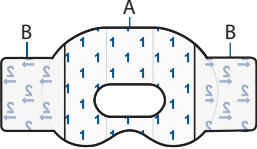
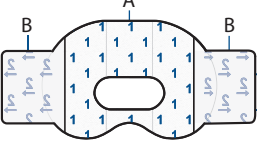
	<p>One-pressserter A. bump on both buttons B. thumbprint marking</p>
	<p>Glucose sensor assembly A. pedestal B. needle housing C. sensor D. clear liner</p>
	<p>Sensor base A. sensor connector B. sensor snaps</p>
	<p>Transmitter</p>
	<p>First piece of oval tape A. liner 1 B. liner 2</p>
	<p>Second piece of oval tape A. liner 1 B. liner 2</p>

Where to insert the sensor

Choose an insertion site for the applicable age group and make sure that the site has an adequate amount of subcutaneous fat.

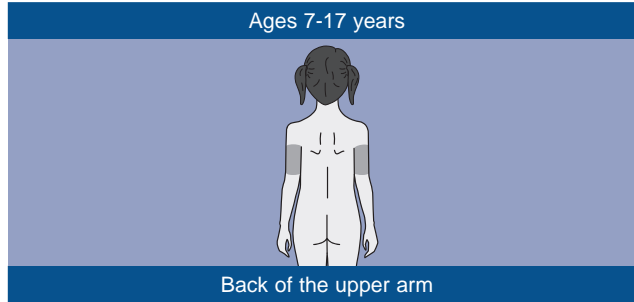

Caution: Guardian 4 sensor is indicated for arm use only. Do not use Guardian 4 sensor in other sites, including the abdomen or buttocks, due to a difference in performance that could result in hypoglycemia or hyperglycemia

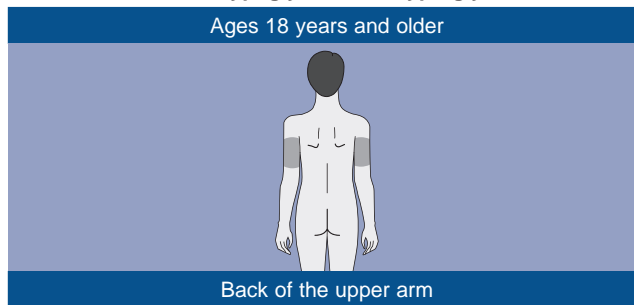

Note:

- Assistance will likely be needed for sensor insertion into the back of the upper arm. Some users find it difficult to insert the sensor into their arm by themselves.

For best sensor glucose performance, and to prevent accidental sensor removal:

- Do not insert the sensor into muscle, tough skin, or scar tissue.
- Avoid areas that are constrained by clothing or accessories.
- Avoid areas subjected to vigorous movement during exercise.

Inserting the sensor

WARNING: Always wear gloves when inserting the sensor into another person to avoid contact with patient blood. Minimal bleeding may occur. Contact with patient blood may cause infection.



1. Wash hands thoroughly with soap and water.

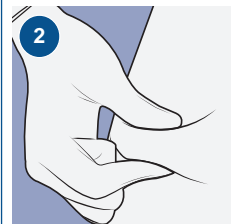

2. Choose an insertion site that has a sufficient amount of fat.

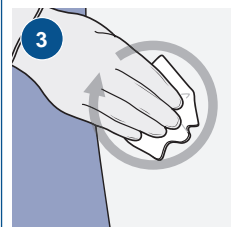

3. Clean the insertion site with alcohol. Let the area air dry.

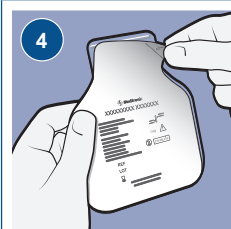

4. Open the sensor package.

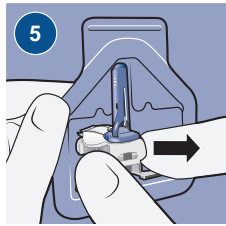
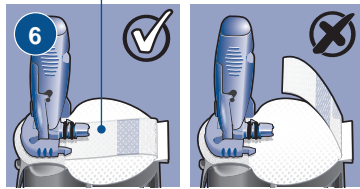
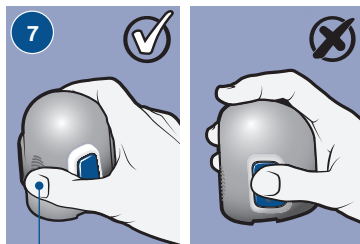
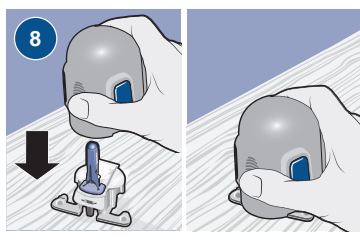
	<p>5. Hold the pedestal and remove the glucose sensor assembly from the package. Place the pedestal on a clean, flat surface such as a table.</p>
<p>tucked tab</p>  <p>Correct Incorrect</p>	<p>6. Confirm that the adhesive tab of the sensor is tucked under the sensor connector and sensor snaps.</p>
 <p>Correct Incorrect</p> <p>thumb on thumbprint marking</p>	<p>7. Using either hand, place a thumb on the thumbprint marking to hold the serter. Fingers must not touch the serter buttons.</p>
	<p>8. Push the serter down onto the pedestal until the base of the serter sits flat on the table and there is a click.</p>

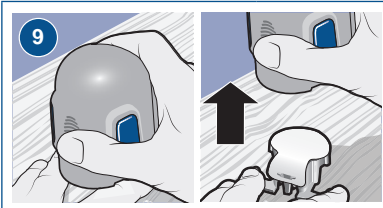
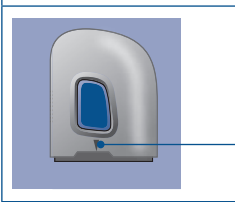
	<p>9. With either hand, place two fingers on the base of the pedestal. With the other hand, grip the serter and pull the serter upwards.</p>
	<p>Note: The arrow on the side of the serter aligns with the needle inside the serter.</p> <p>arrow</p>

WARNING: Never point a loaded serter toward any body part where insertion is not desired. An accidental button-push may cause the needle to inject the sensor in an undesired location, causing minor injury.

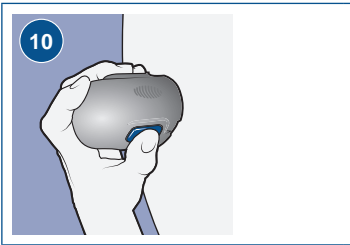
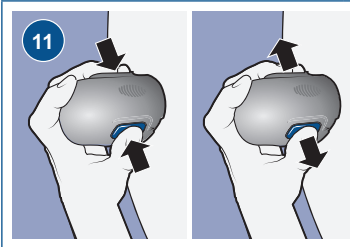
	<p>10. Place the serter on top of the prepared insertion site.</p>
	<p>11. Press and release both serter buttons at the same time. Continue to hold the serter on top of the insertion site for five seconds or more to let the adhesive stick to the skin.</p>

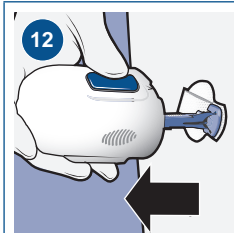

12. Lift the inserter away from the insertion site. Fingers must not press the buttons while lifting the inserter.

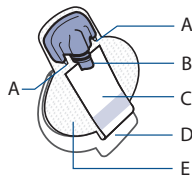

Sensor base

- A. sensor snaps
- B. sensor connector
- C. adhesive tab
- D. adhesive liner
- E. adhesive pad

If the sensor is inserted without assistance, complete step 13a. If a healthcare professional or caregiver assisted with sensor insertion, complete step 13b.

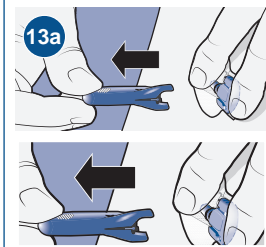

Patient:

13. a. Hold the sensor base against the skin at the sensor connector and at the opposite end of the sensor base. Hold the needle housing at the top and pull away from the sensor.

OR

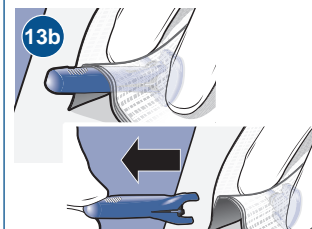

Healthcare professional or caregiver:

13. b. Wrap sterile gauze around the sensor. Hold the sensor base against the skin at the sensor connector and the opposite end of the sensor base. Hold the needle housing at the top and pull away from the sensor.

WARNING: Always watch for bleeding at the insertion site. If bleeding occurs under, around, or on top of the sensor, apply steady pressure using sterile gauze or a clean cloth placed on top of the sensor for up to three minutes. The use of unsterile gauze may cause an infection. If bleeding does not stop, remove the sensor and apply steady pressure until the bleeding stops.

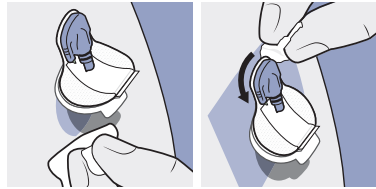

Note: After insertion, use of adhesive products, such as Skin Tac™, in addition to the oval tape is optional. If optional adhesive products are used, apply them to the skin under the adhesive pad prior to removing the liner. Adhesive products may also be applied to the adhesive pad or the skin around the sensor base. Allow the product to dry before continuing.



14. Remove the adhesive liner from under the adhesive pad. Pull the liner away from the sensor, staying close to the skin. Do not pull on the sensor when you remove the liner.

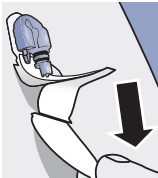



Note: Do not remove the adhesive liner from the rectangular adhesive tab. This tab will be used to secure the transmitter in a later step.

Note: If the sensor base moves, hold the sensor base down.



15. Firmly press the adhesive pad against the insertion site to confirm that the sensor base remains on the skin.

	<p>16. Untuck the adhesive tape from under the sensor connector.</p>
	<p>17. Straighten the sensor adhesive tab so that it lies flat against the skin.</p>

Applying oval tape

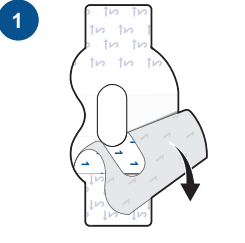
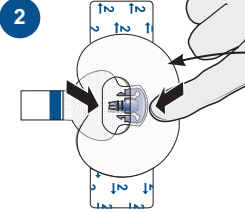
	<p>1. Remove the liner marked 1.</p>
	<p>2. Apply the tape as shown and press down firmly.</p> <p>wide part of tape covers half of sensor base</p>

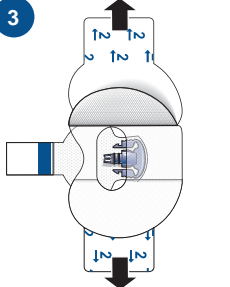
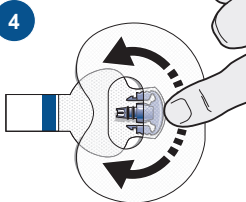
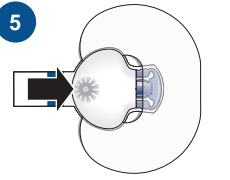
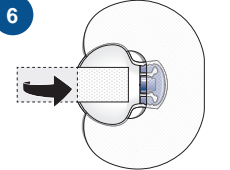
	<p>3. Remove liners marked 2 from each side.</p>
	<p>4. Smooth the tape.</p>
	<p>5. Connect the transmitter to the sensor.</p> <p>Note: Wait for the green light on the transmitter to flash. If the green light does not flash, refer to the Troubleshooting section of the Guardian 4 transmitter user guide.</p>
	<p>6. Cover the transmitter with the adhesive tab.</p> <p>Note: Do not pull the tab too tightly.</p>

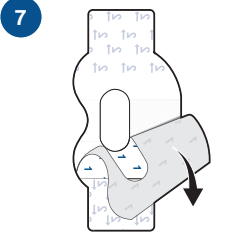
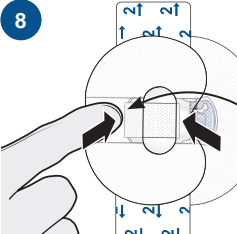
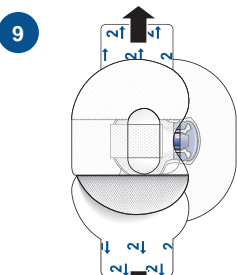
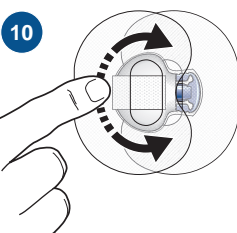
	<p>7. To apply a second tape, remove liner marked 1.</p>
	<p>8. Apply the second tape in the opposite direction to the first tape and place it on the transmitter. Press down firmly.</p> <p>wide part of tape covers end of transmitter and skin</p>
	<p>9. Remove liners marked 2 from each side.</p>
	<p>10. Smooth the tape.</p>

Note: For details on how to enter sensor settings into a compatible display device, refer to the system user guide.

Maintenance

Storage

CAUTION: Do not freeze the sensor, or store it in direct sunlight, extreme temperatures, or humidity. These conditions may damage the sensor.

Only store sensors at room temperature between 36 °F to 80 °F (2 °C to 27 °C). Discard sensor after the "Use-by date" indicated on the label, if the package is damaged, or if the seal is broken.

Disposal

Dispose of the Guardian 4 sensor into a sharps container.

Assistance





Department	Telephone Number
24-Hour Technical Support (calls within the United States)	+1 800 646 4633
24-Hour Technical Support (calls outside the United States)	+1 818 576 5555
Website	www.medtronicdiabetes.com

Technical specifications

Approximate dimensions
1.50 x 2.60 x 2.00 inches (3.80 x 6.70 x 5.20 centimeters)
Approximate weight
0.09 ounces (2.80 grams)

Sensor life of use

The Guardian 4 sensor can be used one time and has a maximum life of **up to** 170 hours (seven days). The 170-hour life span of the sensor begins when the sensor is connected to the transmitter.

Icon table	
	Use-by date
	Medical device
	Do not re-use
	Caution: consult instructions for use for important warnings or precautions not found on the label.
(1x)	One sensor per container/package
(5x)	Five sensors per container/package

	Two tapes per package
	Ten tapes per package
	Consult instructions for use
	Catalogue or model number
	Batch code
	Sterilized using irradiation
	Do not use if package is damaged
	Single sterile barrier system
	Storage temperature limit
	Open here
	Manufacturer
	Date of manufacture
	Do not resterilize
	Fragile, handle with care
	Keep dry
	Recyclable, contains recycled content.
	Authorized representative in the European Community.
	Conformité Européenne (European Conformity). This symbol means that the device fully complies with applicable European Union Acts.
	Magnetic Resonance (MR) unsafe
	Non-pyrogenic
	Requires prescription in the USA

Icon glossary

For definitions of the symbols on the device and package labels, see www.medtronicdiabetes.com/symbols-glossary.

©2023 Medtronic. All rights reserved. Medtronic, Medtronic logo, and Engineering the extraordinary are trademarks of Medtronic.™™ Third-party brands are trademarks of their respective owners. All other brands are trademarks of a Medtronic company.

Medtronic



Medtronic MiniMed
18000 Devonshire Street
Northridge, CA 91325
USA
1 800 646 4633
+1 818 576 5555
www.medtronicdiabetes.com

M021376C001_2

R_x Only

REF MMT-7040

2023-02-22

GUARDIAN™ LINK (3)

TRANSMITTER



Medtronic

Contacts:

Africa: Medtronic South Africa and Southern Africa
Office Reception Tel: +27(0) 11 260 9300
Diabetes: 24/7 Helpline: 0800 633 7867
Sub-Sahara 24/7 Helpline: +27(0) 11 260 9490

Albania: Net Electronics Albania
Tel: +355 697070121

Argentina: Corpomedica S.A.
Tel: +(11) 4 814 1333
Medtronic Directo 24/7:
+0800 333 0752

Armenia: Exiol LLC
Tel: +374 98 92 00 11
or +374 94 38 38 52

Australia: Medtronic Australasia Pty. Ltd.
Tel: 1800 668 670

Bangladesh: Sonargaon Healthcare Pvt Ltd.
Mobile: (+91)-9903995417
or (+880)-1714217131

Belarus: Zarga Medica
Tel: +37517 336 97 00
+37529 613 08 08
+37517 215 02 89
Helpline: +74995830400

België/Belgique: N.V. Medtronic Belgium S.A.
Tel: 0800-90805

Bosnia and Herzegovina: "Novopharm" d.o.o.
Sarajevo
Tel: +387 33 476 444
Helpline: 0800 222 33
Epsilon Research Intern. d.o.o.
Tel: +387 51 251 037
Helpline: 0800 222 33

Brasil: Medtronic Comercial Ltda.
Tel: +(11) 2182-9200
Medtronic Directo 24/7:
+0800 773 9200

Bulgaria: RSR EOOD
Tel: +359 888993083
Helpline: +359 884504344

Canada: Medtronic Canada ULC
Tel: 1-800-284-4416 (toll free/sans-frais)

Chile: Medtronic Chile
Tel: +(9) 66 29 7126
Medtronic Directo 24/7:
+1 230 020 9750
Medtronic Directo 24/7 (From Santiago):
+(2) 595 2942

China: Medtronic (Shanghai) Management Co., Ltd.
Landline: +86 800-820-1981
Mobile Phone: +86 400-820-1981
Calling from outside China: +86 400-820-1981

Colombia: Medtronic Latin America Inc. Sucursal Colombia
Tel: +(1) 742 7300
Medtronic Directo 24/7 (Landline):
+01 800 710 2170
Medtronic Directo 24/7 (Cellular):
+1 381 4902

Croatia: Mediligo d.o.o.
Tel: +385 1 6454 295
Helpline: +385 1 4881144
Medtronic Adriatic d.o.o.
Helpline: +385 1 4881120

Danmark: Medtronic Danmark A/S
Tel: +45 32 48 18 00

Deutschland: Medtronic GmbH
Geschäftsbereich Diabetes
Telefon: +49 2159 8149-370
Telefax: +49 2159 8149-110
24-Std-Hotline: 0800 6464633

Eire: Accu-Science LTD.
Tel: +353 45 433000

España: Medtronic Ibérica S.A.
Tel: +34 91 625 05 42
Fax: +34 91 625 03 90
24 horas: +34 900 120 330

Estonia: AB Medical Group Estonia Ltd
Tel: +372 6552310
Helpline: +372 5140694

Europe: Medtronic Europe S.A. Europe, Middle East and Africa HQ
Tel: +41 (0) 21-802-7000

France: Medtronic France S.A.S.
Tel: +33 (0) 1 55 38 17 00

Hellas: Medtronic Hellas S.A.
Tel: +30 210677-9099

Hong Kong: Medtronic Hong Kong Medical Ltd.
Tel: +852 2919-1300
To order supplies:
+852 2919-1322
24-hour helpline: +852 2919-6441

India: India Medtronic Pvt. Ltd.
Tel: (+91)-80-22112245 / 32972359
Mobile: (+91)-9611633007
Patient Care Helpline:
1800 209 6777

Indonesia: Medtronic International Ltd.
Tel: +65 6436 5090
or +65 6436 5000

Israel: Medtronic Trading Ltd.
Tel.: +972-9-9724400
Tel. (product support –
8:00-17:00): +972-9-9724489
Helpline (weekends & holidays):
1-800-611-888

Italia: Medtronic Italia S.p.A.
Tel: +39 02 24137 261
Fax: +39 02 24138 210
Servizio assistenza tecnica:
N° verde: 800 60 11 22

Japan: Medtronic Japan Co. Ltd.
Medtronic Japan
24hr. Support Line: 0120-56-32-56
日本：日本メドトロニック株式会社
24時間サポートライン：0120-56-32-56

Kazakhstan: Medtronic BV in Kazakhstan
Tel: +7 727 311 05 80 (Almaty)
Tel: +7 717 224 48 11 (Astana)
Круглосуточная линия поддержки:
8 800 080 5001

Kosovo: Yess Pharma
Tel: +377 44 999 900
Helpline: +37745888388

Latin America: Medtronic, Inc.
Tel: 1(305) 500-9328
Fax: 1(786) 709-4244

Latvija: RAL SIA
Tel: +371 67316372
Helpline (9am to 6pm):
+371 29611419

Lithuania: Monameda UAB
Tel: +370 68405322
Helpline: +370 68494254

Macedonia: Alkaloid Kons Dooel
Tel: +389 23204438

Magyarország: Medtronic Hungária Kft.
Tel: +36 1 889 0688

Malaysia: Medtronic International Ltd.
Tel: +603 7946 9000

Middle East and North Africa: Regional Office
Tel: +961-1-370 670

Montenegro: Glosarij d.o.o.
Tel: +382 20642495

México: Medtronic Servicios S. de R. L. de C.V.
Tel (México DF): +(11) 029 058
Tel (Interior): +01 800 000 7867
Medtronic Directo 24/7 (from México DF):
+(55) 36 869 787
Medtronic Directo 24/7:
+01 800 681 1845

Nederland, Luxembourg: Medtronic B.V.
Tel: +31 (0) 45-566-8291
Gratis: 0800-3422338

New Zealand: Medica Pacifica
Phone: 64 9 414 0318
Free Phone: 0800 106 100

Norge: Medtronic Norge A/S
Tel: +47 67 10 32 00
Fax: +47 67 10 32 10

Philippines: Medtronic International Ltd.
Tel: +65 6436 5090
or +65 6436 5000

Россия: ООО «Медтроник»
Tel: +7 495 580 73 77
Круглосуточная линия поддержки:
8 800 200 76 36

Polska: Medtronic Poland Sp. z o.o.
Tel: +48 22 465 6934

Portugal: Medtronic Portugal Lda
Tel: +351 21 7245100
Fax: +351 21 7245199

Puerto Rico: Medtronic Puerto Rico
Tel: 787-753-5270

Republic of Korea: Medtronic Korea, Co., Ltd.
Tel: +82.2.3404.3600

Romania: Medtronic Romania S.R.L
Tel: +40372188017
Helpline: +40 726677171

Schweiz: Medtronic (Schweiz) AG
Tel: +41 (0)31 868 0160
24-Stunden-Hotline: 0800 633333
Fax Allgemein: +41 (0)318680199

Serbia: Epsilon Research International d.o.o.
Tel: +381 113115554
Medtronic Serbia D.o.o
Helpline: +381 112095900

Singapore: Medtronic International Ltd.
Tel: +65 6436 5090
or +65 6436 5000

Slovenija: Zaloker & Zaloker d.o.o.
Tel: +386 1 542 51 11
24-urna tehnična pomoč:
+386 51316560

Slovenská republika: Medtronic Slovakia, s.r.o.
Tel: +421 26820 6942
HelpLine: +421 26820 6986

Sri Lanka: Swiss Biogenics Ltd.
Mobile: (+91)-9003077499
or (+94)-777256760

Suomi: Medtronic Finland Oy
Tel: +358 20 7281 200
Help line: +358 400 100 313

Sverige: Medtronic AB
Tel: +46 8 568 585 20
Fax: +46 8 568 585 11

Taiwan: Medtronic (Taiwan) Ltd.
Tel: 02-21836000
Toll free: +886-800-005285

Thailand: Medtronic (Thailand) Ltd.
Tel: +662 232 7400

Türkiye: Medtronic Medikal Teknoloji
Ticaret Ltd. Sirketi.
Tel: +90 216 4694330

USA: Medtronic Diabetes Global Headquarters
24-Hour Technical Support: +1-800-646-4633
To order supplies: +1-800-843-6687

Ukraine: ТОВ «Медтронік Україна»
Лінія цілодобової підтримки:
Тел.: 0 800 508 300

United Kingdom: Medtronic Ltd.
Tel: +44 1923-205167

Österreich: Medtronic Österreich GmbH
Tel: +43 (0) 1 240 44-0
24 – Stunden – Hotline: 0820 820 190

Česká republika: Medtronic Czechia s.r.o.
Tel: +420 233 059 111
Non-stop helpLine (24/7):
+420 233 059 059
Zákaznický servis (8:00 - 17:00):
+420 233 059 950

The Guardian™ Link (3) transmitter with Bluetooth™* wireless technology is a component of the continuous glucose monitoring (CGM) system for a MiniMed™ insulin pump with smart device connectivity. The transmitter is compatible only with the Guardian™ Sensor (3) glucose sensor. The transmitter collects data from the sensor. The transmitter then wirelessly sends the data to the insulin pump.

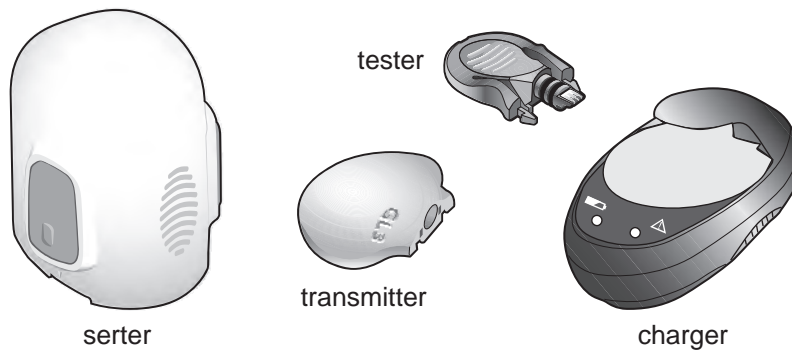

Guardian™ Link (3) transmitter kit components

A complete transmitter kit includes the following components:

- Guardian™ Link (3) transmitter (MMT-7911)
- Two testers (MMT-7736L)
- Charger (MMT-7715)
- One-press serter (MMT-7512)

Indications for use

The Guardian™ Link (3) transmitter (MMT-7911) is intended for use with MiniMed™ 770G and 780G Systems. The transmitter powers the glucose sensor, collects and calculates sensor data, and sends the data to a compatible MiniMed™ insulin pump system with smart device connectivity for the management of diabetes mellitus. The transmitter is intended for single-patient, multi-use.

Contraindications

None known.

Warnings

- Do not use the transmitter adjacent to other electrical equipment that may cause interference with the normal system operation. Other electrical equipment that may compromise normal system operation has been contraindicated. For more information on electrical equipment that may compromise normal system operation, see *Exposure to magnetic fields and radiation, on page 2*.
- Always refer to the sensor user guide for all precautions, warnings, and instructions relating to the sensor. Not referring to the sensor user guide can result in serious injury or damage to the sensor.
- Do not allow children to put small parts in their mouth. This product poses a choking hazard for young children.
- Do not change or modify the device unless expressly approved by Medtronic Diabetes. Modifying the device can cause serious injury, interfere with your ability to operate the device, and void your warranty.
- Do not use the tester if it comes in contact with blood. Touching blood can cause infection. Dispose of the tester according to the local regulations for medical waste disposal, or contact your healthcare professional for disposal information.
- Bleeding may occur after inserting the sensor. Always make sure that the site is not bleeding before connecting the transmitter to the sensor. Blood can get into the transmitter connector and damage the device. Discard the device if damaged. If bleeding occurs, apply steady pressure with a sterile gauze or clean cloth at the insertion site until bleeding stops. After bleeding stops, connect the transmitter to the sensor.
- Contact 24-Hour Technical Support if you experience any adverse reactions associated with the transmitter or sensor. Adverse reactions can cause serious injury.
- Do not discard the transmitter in a medical waste container or expose it to extreme heat. The transmitter contains a battery that may ignite and result in serious injury.

Exposure to magnetic fields and radiation

- Do not expose your transmitter to Magnetic Resonance Imaging (MRI) equipment, diathermy devices, or other devices that generate strong magnetic fields (for example, x-ray, CT scan, or other types of radiation). Exposure to a strong magnetic field has not been evaluated and can cause the device to malfunction, result in serious injury, or be unsafe. If your transmitter is exposed to a strong magnetic field, discontinue use and contact 24-Hour Technical Support for further assistance.

- Always remove your sensor and transmitter before entering a room that has x-ray, MRI, diathermy, or CT scan equipment. Exposure to a strong magnetic field has not been evaluated and can cause the device to malfunction, result in serious injury, or be unsafe. If your sensor or transmitter is exposed to a strong magnetic field, discontinue use and contact 24-Hour Technical Support for further assistance.
- Always carry the Medical emergency card provided with your device when you are traveling. The Medical emergency card provides critical information about airport security systems and using your transmitter safely on an airplane that can help you and others. Not following the guidance on the Medical emergency card could result in serious injury.

Precautions

- Do not attempt to use the Guardian™ Link (3) transmitter (MMT-7911) with a MiniMed™ insulin pump without smart device connectivity. Only a MiniMed™ insulin pump with smart device connectivity can communicate with the Guardian™ Link (3) transmitter (MMT-7911).
- Only use the Guardian™ Sensor (3) glucose sensor (MMT-7020) with the transmitter. Do not use any other sensor. Other sensors are not intended for use with the transmitter and will damage the transmitter and the sensor.
- Only use the green colored tester (MMT-7736L) with the transmitter. Pockets on the transmitter are visible when connected to the tester. Do not use any other test plug. Other test plugs are not intended for use with the transmitter and will damage the transmitter and the tester.

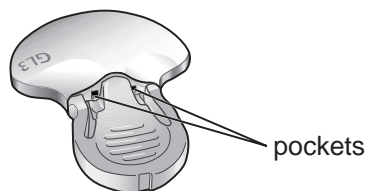

- Always use the tester when cleaning the transmitter. Do not use any other test plug with the transmitter. Use of another test plug can allow water to get into the transmitter or can prevent proper cleaning. Water can damage the transmitter.
- Do not twist the tester or sensor while attached to the transmitter. Twisting the tester or sensor will damage the transmitter.
- Do not allow the tester to come in contact with any liquid when not connected to the transmitter. A wet tester can damage the transmitter.

- Do not allow the transmitter to come in contact with any liquid when not connected to a sensor or to the tester. Moisture will damage the transmitter and a wet transmitter can damage the sensor.
- Do not clean the O-rings on the tester with any substances. Cleaning the O-rings can damage the tester.

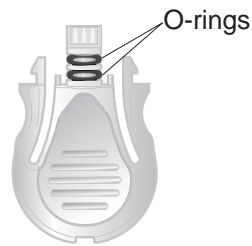

Radio Frequency (RF) communication

This device complies with the United States Federal Communications Commission (FCC) and international standards for electromagnetic compatibility. This device complies with Part 15 of the FCC Rules. Operation is subject to two conditions: (1) This device may not cause harmful interference, and (2) this device must accept any interference received, including interference that may cause undesired operation.

This device has been tested and found to comply with the limits for a Class B digital device, pursuant to Part 15 of the FCC rules. These limits are designed to provide reasonable protection against harmful interference in a residential installation. This device generates, uses, and can radiate radio frequency energy and, if not installed and used in accordance with the instructions, may cause harmful interference to radio communications. However, even when installed and used in accordance with the instructions, no particular installation can guarantee that harmful interference will not occur. If this device does cause harmful interference to radio or television reception, which can be determined by turning the device off and on, the user is encouraged to try to correct the interference by one or more of the following measures:

- Reorient or relocate the receiving antenna.
- Increase the separation between the device and the receiver.
- Decrease the distance between the transmitter and the insulin pump to 6 feet (1.8 meters) or less.
- Increase the separation between the transmitter and the equipment that is receiving or emitting interference.

Note: Harmful interference is defined by the FCC as follows. Any emission, radiation or induction that endangers the functioning of a radio navigation service or of other safety services or seriously degrades, obstructs or repeatedly interrupts a radio communications service operating in accordance with FCC rules.

Changes or modifications made to this equipment not expressly approved by Medtronic Diabetes could void the user's authority to operate the equipment.

IEC 60601-1-2:2014, 4th Edition; Special EMC Precautions for Medical Electrical Equipment

- 1 Special Precautions regarding Electromagnetic Compatibility (EMC): This body worn device is intended to be operated within a reasonable residential, domestic, public or work environment where common levels of radiated "E" (V/m) or "H" fields (A/m) exist, such as cellular phones, Wi-Fi™*, Bluetooth™* wireless technology, electric can openers, microwave and induction ovens. This device generates, uses, and can radiate radio frequency energy and, if not installed and used in accordance with the provided instructions, may cause harmful interference to radio communications.
- 2 Portable and mobile RF communications equipment can affect medical electrical equipment. If you encounter RF interference from a mobile or stationary RF transmitter, move away from the RF transmitter that is causing the interference.
- 3 Be careful when you use your transmitter closer than 12 in (30 cm) to portable radio frequency (RF) equipment or electrical equipment. If you must use your transmitter next to portable RF equipment or electrical equipment, observe the transmitter to verify correct system operation. Degradation of the performance of the transmitter could result.

Assistance

Medtronic MiniMed provides 24-Hour Technical Support for assistance. When calling the HelpLine, please have the serial number of your device available. The serial number and 24-Hour Technical Support phone number are listed on the back of your device.

Please contact 24-Hour Technical Support if you need a copy of a MiniMed™ system user guide.

Department	Telephone number
24-Hour Technical Support (calls within the United States)	800 646 4633

Department	Telephone number
24-Hour Technical Support (calls outside the United States)	+1 818 576 5555
Website	www.medtronicdiabetes.com

Preparing your transmitter

The transmitter contains a non-replaceable, rechargeable battery that you can recharge as needed with the charger. The transmitter needs to be charged before you use it. The charger has a green light that shows the charging status and a red light that communicates any problems during charging. If you see a red light, see *Troubleshooting, on page 15*. The charger needs one AAA alkaline battery.

Note: *If the battery is installed incorrectly or is low, the charger will not work. Repeat the battery installation steps using a new battery.*

Installing a battery in the charger

To install a battery in the charger:

- 1 Push the battery cover in and slide it off (as shown in the image in step 3).
- 2 Insert a new AAA alkaline battery. Make sure the + and - symbols on the battery align with these same symbols shown on the charger.
- 3 Slide the cover back on the charger until it clicks into place.

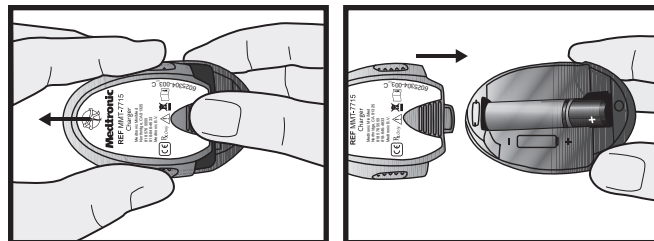

Charging the transmitter

CAUTION: Always charge the transmitter before inserting your sensor. A depleted transmitter does not function. A fully charged transmitter works at least seven days without recharging. A depleted transmitter can take up to two hours to recharge.

CAUTION: Do not store the transmitter on the charger for more than 60 days. Disconnect and reconnect to the charger to re-charge before use. If the transmitter is left on the charger for more than 60 days, the transmitter battery will be permanently damaged.

To charge the transmitter:

- 1 Push the transmitter and the charger together to connect the transmitter to the charger.
- 2 Within 10 seconds after the transmitter is connected, a green light on the charger will flash for one to two seconds as the charger powers on. For the rest of the charging time, the green light on the charger will continue to flash in a pattern of four flashes with a pause between the four flashes.
- 3 When charging is complete, the green light on the charger will stay on, without flashing, for 15 to 20 seconds and then turn off.
- 4 After the green charger light turns off, disconnect the transmitter from the charger. The green light on the transmitter starts to flash.

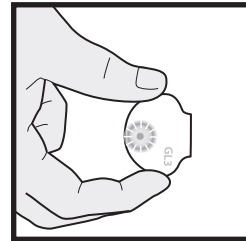
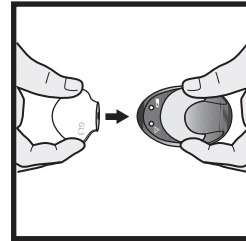

Pairing your transmitter

Always refer to the system user guide for instructions on how to pair your transmitter with your pump. The pump and the transmitter must be paired before data from the sensor can be sent to the pump. The pump and the transmitter are only required to be paired once. There is no need to pair the pump with the transmitter again when you insert a new sensor.

Inserting the sensor

Always refer to your sensor user guide for instructions on how to insert the sensor.

Connecting the transmitter to the sensor

Before proceeding, have your MiniMed™ insulin pump system user guide available.

To connect the transmitter to the sensor:

- 1 After the sensor is inserted, consult your sensor user guide for details on how to apply the required tape before connecting the transmitter.
- 2 Hold the rounded end of the inserted sensor to prevent it from moving during connection.
- 3 Hold the transmitter as shown. Line up the two notches on the transmitter with the side arms of the sensor. The flat side of the transmitter should face the skin.
- 4 Slide the transmitter onto the sensor connector until the sensor arms snap into the notches on the transmitter. If the transmitter is properly connected, and if the sensor has had enough time to become hydrated with the interstitial fluid, the green light on the transmitter will flash 6 times.

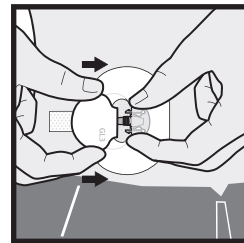

Note: If the transmitter does not flash, see *Troubleshooting*, on page 15.

- 5 When the transmitter light flashes green after connecting to the sensor, use your pump to start the sensor. For more instructions, see your system user guide.
- 6 Attach the adhesive tab of the sensor to the transmitter.
- 7 After the transmitter is connected, consult your sensor user guide for details on how to apply the required tape.
- 8 Follow the instructions that appear on the pump screen or in your system user guide.

Disconnecting the transmitter from the sensor

Before proceeding, have your MiniMed™ insulin pump system user guide available.

To disconnect the transmitter from the sensor:

- 1 Carefully remove any tape from the transmitter and sensor.
- 2 Remove the adhesive tab from the top of the transmitter.
- 3 Hold the transmitter as shown, and pinch the flexible side arms of the sensor between your thumb and forefinger.
- 4 Gently pull the transmitter away from the sensor.
- 5 Follow the instructions that appear on the pump or in your system user guide.

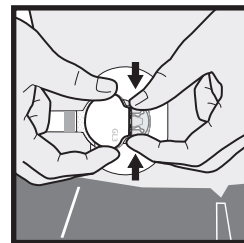

Removing the sensor

Always refer to the sensor user guide for instructions on how to remove the sensor.

Reconnecting the transmitter to a sensor that is already inserted

You can reconnect your transmitter to the sensor you are currently using. Simply connect your transmitter to the sensor that is already inserted. When the pump detects the transmitter, confirm that you want to Reconnect Sensor. It may take a few seconds to establish a connection when reconnecting a sensor. Reattach the adhesive tab of the sensor to the transmitter and reapply any required tape. When you reconnect a sensor, the sensor will go through another warm-up period before you can calibrate it.

Tester

The tester is used to test the transmitter to make sure it is working. The tester is also used as a required component to create a waterproof seal when cleaning the transmitter. Properly connecting the tester to the transmitter ensures that fluids do not come in contact with the connector pins inside the transmitter. Fluids can cause connector pins to corrode and affect the performance of the transmitter.

Do not twist the tester while it is attached to the transmitter. This will damage the transmitter.

The tester can be used for one year. If you continue to use the tester for more than one year, the connector pins inside the transmitter could be damaged, because the tester cannot continue to provide a waterproof seal. For instructions on how to check the connector pins, see *Inspecting the transmitter connector pins*, on page 10.

CAUTION: Only use the green colored tester (MMT-7736L) with the transmitter. Pockets on the transmitter are visible when connected to the tester. Do not use any other test plug. Other test plugs are not intended for use with the transmitter and will damage the transmitter and the tester.

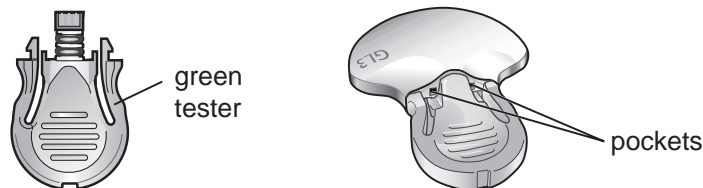

Inspecting the transmitter connector pins

This image is an example of how the connector pins should look.

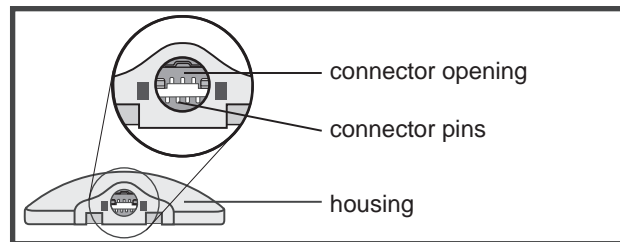

Look inside the connector opening of the transmitter to make sure that the connector pins are not damaged or corroded. If the connector pins are damaged or corroded, the transmitter cannot communicate with the charger or the pump. Contact 24-Hour Technical Support. It may be time to replace your transmitter.

Also look for moisture inside the connector opening. If you see any moisture, allow the transmitter to dry for at least one hour. Moisture inside the connector opening could cause the transmitter to not work properly and could cause corrosion and damage over time.

Connecting the tester for testing or cleaning

Before proceeding, have your MiniMed™ insulin pump system user guide available.

To connect the tester:

- 1 Hold the transmitter and the tester as shown. Line up the flat side of the tester with the flat side of the transmitter.
- 2 Push the tester into the transmitter until the flexible side arms of the tester click into the notches on both sides of the transmitter. When properly connected, the green light on the transmitter flashes 6 times.
- 3 To test the transmitter, check the sensor icon on the pump to ensure that the transmitter is sending a signal (see your system user guide).
- 4 To clean the transmitter, see *Cleaning the transmitter, on page 11*.
- 5 After testing or cleaning, disconnect the tester from the transmitter.

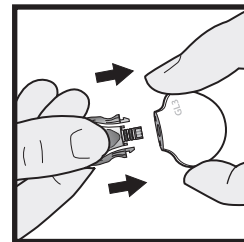

Disconnecting the tester

To disconnect the tester:

- 1 Hold the transmitter body as shown and pinch the side arms of the tester.
- 2 With the tester arms pinched, gently pull the transmitter away from the tester.

Note: To save transmitter battery life, do NOT leave the tester connected after cleaning or testing.

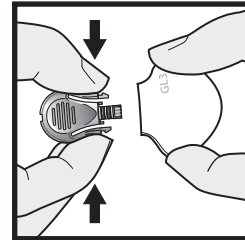

Cleaning the transmitter

The transmitter is a single-patient use device and not intended for multi-patient use.

WARNING: Do not discard the transmitter in a medical waste container or expose it to extreme heat. The transmitter contains a battery that may ignite and result in serious injury.

Note: The tester is a required component for cleaning the transmitter. For details, see *Tester*, on page 9.

CAUTION: Do not use automated washer-disinfector to clean or disinfect the device. Using automated washer-disinfector to clean or disinfect the device will cause damage to the transmitter.

Always clean the transmitter after each use.

To clean the transmitter, you need the following materials:

- mild liquid soap
- soft-bristled toddler toothbrush
- container
- clean, lint-free dry cloths

Use life

The transmitter can be cleaned up to 122 times or for one year, whichever comes first. Discard the transmitter at this point. If you continue to use the transmitter beyond 122 times or one year, the cleaning process may damage the device. Contact Medtronic to order a new transmitter.

WARNING: Do not use the device if you see any cracking, flaking, or damage to the housing. Cracking, flaking, or damage to the housing are signs of deterioration. Deterioration of the housing can affect the ability to properly clean the transmitter and result in serious injury. Call 24-Hour Technical Support and discard the device according to local regulations for battery disposal (non-incineration), or contact your healthcare professional for disposal information.

To clean the transmitter:

- 1 Wash your hands thoroughly.
- 2 Attach the tester to the transmitter to create a waterproof seal.

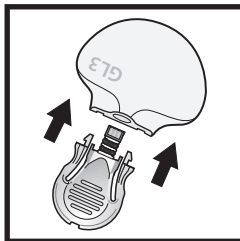

- 3 If there is adhesive residue on the transmitter, see *Removing adhesive residue*, on page 14.
- 4 Rinse the transmitter under room temperature tap water for at least one minute, and until visibly clean. Make sure all hard-to-reach areas are rinsed completely.

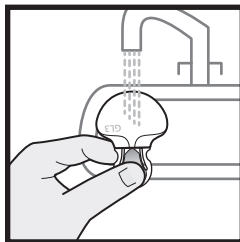

- 5 Prepare a mild liquid soap solution using 1 teaspoon (5 milliliters) of mild liquid soap per 1 gallon (3.8 liters) of room temperature tap water.

- 6 With the tester still attached, submerge the transmitter in the mild liquid soap solution and soak for one minute.

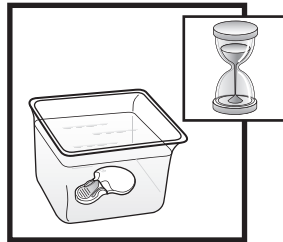

- 7 Holding the tester, brush the entire surface of the transmitter using a soft-bristled toddler toothbrush. Make sure to brush all hard-to-reach areas until visibly clean.



- 8 Rinse the transmitter under running room temperature tap water for at least one minute, and until all visible liquid soap is gone.

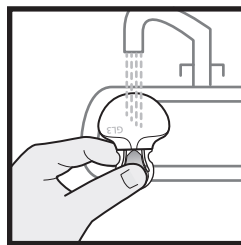

9 Dry the transmitter and tester with a clean, dry cloth.

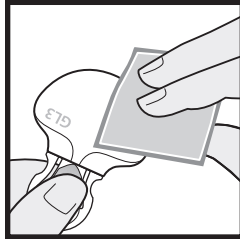

10 Place the transmitter and tester on a clean, dry cloth and air dry them completely.

11 Disconnect the tester from the transmitter by gently squeezing the arms of the tester.

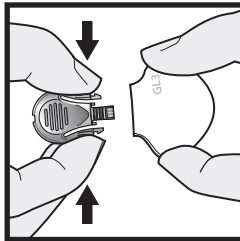

Removing adhesive residue

You may need to perform this procedure if there is adhesive residue present on the transmitter. If you visually inspect the transmitter and see adhesive residue on it, follow these instructions.

To remove adhesive residue, you need cotton swabs and a medical adhesive remover such as Detachol™*, which is a mineral spirit.

Note: *During testing, Medtronic MiniMed used Detachol™* to remove the adhesive residue from the transmitter.*

To remove adhesive residue:

- 1 Make sure the tester is attached to the transmitter.
- 2 Soak a cotton swab in the medical adhesive remover.

- 3 Hold the tester and gently rub the adhesive remover on the transmitter until the residue is removed.

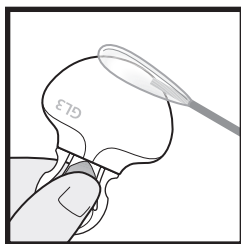

- 4 Continue with the cleaning procedure. See *Cleaning the transmitter*, on page 11 for details.

Bathing and swimming

After the transmitter and sensor are connected, they form a waterproof seal to a depth of 8 feet (2.4 meters) for up to 30 minutes. You can shower and swim without removing them.

Cleaning the charger

This procedure is for general cleaning as required, based on physical appearance.

CAUTION: Do not immerse the charger in water or any other cleaning agent. The charger is not waterproof. Water can damage the charger and cause the device to malfunction.

WARNING: Dispose the charger according to the local regulations for battery disposal, or contact your healthcare professional for disposal information. The charger may ignite upon incineration.

To clean the charger:

- 1 Wash your hands thoroughly.
- 2 Use a damp cloth with mild cleaning solution, such as a dishwashing detergent, to clean any dirt or foreign material from the outside of the charger. Never use organic solvents, such as paint thinner or acetone, to clean the charger.
- 3 Place the charger on a clean, dry cloth and air dry for two to three minutes.

Troubleshooting

The following table contains troubleshooting information for the transmitter, charger, and tester. For more information about troubleshooting, see your system user guide.

Problem	Likely Cause(s)	Resolution
You connected the transmitter to the charger and no lights came on.	<p>The transmitter connector pins are damaged or corroded.</p> <p>Your charger battery has no power or no battery is inserted.</p>	<ol style="list-style-type: none"> 1 Check the transmitter connector pins for damage or corrosion. For more information about your connector pins, see <i>Inspecting the transmitter connector pins</i>, on page 10. If the pins are damaged or corroded, contact 24-Hour Technical Support. It may be time to replace your transmitter. 2 If there is no damage to the connector pins, replace the battery in the charger. For instructions on replacing your charger battery, see <i>Installing a battery in the charger</i>, on page 6.
During charging, the flashing green light on the charger turns off and you see a longer flashing red light on the charger.	Your charger battery is low on power.	Replace the battery in the charger. For instructions on replacing your charger battery, see <i>Installing a battery in the charger</i> , on page 6.
During charging, the flashing green light on the charger turns off and you see a series of quick flashing red lights on the charger for two seconds at a time.	Your transmitter is low on power.	<ol style="list-style-type: none"> 1 Charge the transmitter continuously for one hour. If flashing does not stop, proceed to step 2. 2 Charge the transmitter continuously for eight hours. If flashing does not stop, call 24-Hour Technical Support. It may be time to replace your transmitter.
During charging, a mix of quick and long flashing red lights appear on the charger.	Your charger <i>and</i> your transmitter are low on power.	<ol style="list-style-type: none"> 1 Replace the battery in the charger. For instructions on replacing your charger battery, see <i>Installing a battery in the charger</i>, on page 6. 2 Charge the transmitter continuously for one hour. If the quick flashing red lights do not stop, proceed to step 3. 3 Charge the transmitter continuously for eight hours. If flashing does not stop, call 24-Hour Technical Support. It may be time to replace your transmitter.

Problem	Likely Cause(s)	Resolution
The green light on the transmitter does not flash when you connect it to the sensor.	<p>Your transmitter is not fully connected.</p> <p>Your transmitter is low on power.</p> <p>Your sensor is not properly inserted into your body.</p>	<ol style="list-style-type: none"> 1 Disconnect the transmitter from the sensor. 2 Wait for five seconds and reconnect them. If the green light still does not flash, proceed to step 3. 3 Fully charge the transmitter and connect it to the tester. If the green light still does not flash, see troubleshooting on “The green light on the transmitter does not flash when you connect it to the tester”. If the green light flashes, proceed to step 4. 4 Disconnect the transmitter from the tester, wait at least five seconds, and connect the transmitter to the sensor. If the green light still does not flash, proceed to step 5. 5 The sensor may not be properly inserted into your body. Remove the sensor from your body and insert a new sensor.
The green light on the transmitter does not flash when you connect it to the tester.	<p>Your transmitter is not fully connected.</p> <p>Your transmitter is low on power.</p>	<ol style="list-style-type: none"> 1 Check the connection between the transmitter and the tester. If the green light still does not flash, proceed to step 2. 2 Fully charge the transmitter. 3 Test the transmitter with the tester again. If you still do not see the green light flash, call 24-Hour Technical Support. It may be time to replace your transmitter.
Your transmitter battery does not last for seven days.	<p>Your transmitter is not fully charged when you connect it to the sensor.</p> <p>The transmitter and pump frequently lose wireless connection.</p>	<ol style="list-style-type: none"> 1 Fully charge the transmitter before connecting it to the sensor. If the transmitter battery still does not last for the duration of one sensor use, proceed to step 2. 2 Move away from any equipment that can cause RF interference. For more information on RF interference, see <i>Radio Frequency (RF) communication</i>, on page 4. 3 Make sure your pump and your transmitter are located on the same side of your body to minimize any RF interference. If your fully charged transmitter battery continues to lose power before a full seven days, call 24-Hour Technical Support. It may be time to replace your transmitter.

Problem	Likely Cause(s)	Resolution
Your transmitter has lost connection with your pump.	Your pump is out of range. There is RF interference from other devices.	<ol style="list-style-type: none"> 1 Move away from any equipment that can cause RF interference. For more information on RF interference, see <i>Radio Frequency (RF) communication, on page 4</i>. If your transmitter is still not communicating with your pump, proceed to step 2. 2 Make sure your pump and your transmitter are located on the same side of your body to minimize any RF interference. If your transmitter is still not communicating with your pump, call 24-Hour Technical Support for assistance.
<p>Note: An alarm or alert occurs and a message appears when your transmitter has lost connection with your pump for 30 minutes.</p>		

Storage

Store the transmitter, charger, and tester in a clean, dry location at room temperature. If the transmitter is not in use, you must charge the transmitter at least once every 60 days.

CAUTION: Do not store the transmitter on the charger. If the transmitter is left on the charger for more than 60 days, the battery will be permanently damaged.

Disposal

Do not dispose the transmitter in unsorted municipal waste stream. Discard the transmitter according to local regulations for battery disposal, or contact your healthcare professional for disposal information.

Specifications

Biocompatibility	Transmitter: Complies with EN ISO 10993-1
Applied parts	Transmitter Sensor

Operating conditions	<p>Transmitter temperature: 32°F to 113°F (0°C to 45°C)</p> <p>Caution: When operating the transmitter on a tester in air temperatures greater than 106°F (41°C), the temperature of the transmitter may exceed 109°F (43°C).</p> <p>Transmitter relative humidity: 10% to 95% with no condensation</p> <p>Transmitter pressure: 8.4 psi to 15.4 psi (57.60 kPa to 106.17 kPa)</p> <p>Charger temperature: 50°F to 104°F (10°C to 40°C)</p> <p>Charger relative humidity: 30% to 75% with no condensation</p>
Storage conditions	<p>Transmitter temperature: -4°F to 131°F (-20°C to 55°C)</p> <p>Transmitter relative humidity: up to 95% with no condensation</p> <p>Transmitter pressure: 8.4 psi to 15.4 psi (57.6 kPa to 106 kPa)</p> <p>Charger temperature: 14°F to 122°F (-10°C to 50°C)</p> <p>Charger relative humidity: 10% to 95% with no condensation</p>
Battery life	<p>Transmitter: Seven days of continuous glucose monitoring immediately following a full charge.</p> <p>Charger: The charger uses one new AAA battery to charge the transmitter.</p>
Transmitter frequency	2.4 GHz band, Bluetooth™* wireless technology (version 4.0)
Effective radiated power (ERP)	0.06 mW (-12.05 dBm)
Effective isotropic radiated power (EIRP)	0.1 mW (-9.9 dBm)
Operating range	Up to 6 feet (1.8 meters) in free-air
Transmitter expected service life	The transmitter expected service life is one year depending on patient usage.

Transmitter wireless communication

Quality of service

The transmitter and insulin pump connect via smart device connectivity. The transmitter sends glucose data and system-related alerts to the pump. The pump verifies the integrity of received data after wireless transmission.

Data security

The transmitter is designed to only accept radio frequency (RF) communications from recognized and linked devices. You must pair your pump with the transmitter before the pump will accept information from the transmitter.

The MiniMed™ insulin pumps and system components (meters and transmitters) ensure data security via proprietary means and data integrity using error checking processes, such as cyclic redundancy checks.

Traveling by air

Your transmitter is safe for use on commercial airlines. If questioned by airline personnel about the use of your device, please show them your Medical emergency card.

Guidance and manufacturer's declaration

Guidance and Manufacturer's Declaration - Electromagnetic Emissions		
Emissions Test	Compliance	Electromagnetic Environment - Guidance
RF emissions CISPR 11	CISPR 11 Group 1, Class B	<p>The transmitter uses RF energy only for system communications. Therefore, its RF emissions are very low and are not likely to cause any interference in nearby electronic equipment.</p> <p>Note: <i>The preceding statement is required by IEC 60601-1-2 for Group 1, Class B devices. Since the transmitter is battery powered, its emissions will not be affected by the establishment power supply and there is no evidence of any issues associated with the use of the system in domestic establishments.</i></p>
Harmonic emissions IEC 61000-3-2	Not applicable	
Voltage fluctuations/flicker emissions IEC 61000-3-3	Not applicable	

Guidance and Manufacturer's Declaration - Electromagnetic Immunity			
Immunity Test	IEC 60601-1-2:2014 Test Level	Max foreseeable use condition per IEC 60601-1-2:2014	Electromagnetic Environment Guidance
Electrostatic discharge (ESD) IEC 61000-4-2	±8 kV contact ±2 kV, ±4 kV, ±8 kV, ±15 kV air	±8 kV contact ±2 kV, ±4 kV, ±8 kV, ±15 kV air	For use in a typical domestic, commercial, or hospital environment.
Conducted disturbances induced by RF fields	3 Vrms 150 kHz to 80 MHz 6 Vrms ISM bands between 150 kHz to 80 MHz	Not applicable	Requirement does not apply to this battery powered device.
Electrical fast transient/burst IEC 61000-4-4	±2 kV 100 kHz repetition frequency	Not applicable	Requirement does not apply to this battery powered device.

Guidance and Manufacturer's Declaration - Electromagnetic Immunity			
Immunity Test	IEC 60601-1-2:2014 Test Level	Max foreseeable use condition per IEC 60601-1-2:2014	Electromagnetic Environment Guidance
Surge IEC 61000-4-5	Line to Line: ± 0.5 kV, ± 1 kV Line to Ground: ± 0.5 kV, ± 1 kV, ± 2 kV	Not applicable	Requirement does not apply to this battery powered device.
Note: U_T is the a.c. mains voltage prior to application of the test level.			
Voltage dips, short interruptions, and voltage variations on power supply lines IEC 61000-4-11	0% U_T ; 0.5 cycles (at 0°, 45°, 90°, 135°, 180°, 225°, 270°, and 315°) 0% U_T ; 1 cycle (at 0°) 70% for 25/30 cycles (at 0°) 0% for 250/300 cycles	Not applicable	Requirement does not apply to this battery powered device.
Power frequency (50/60 Hz) magnetic field IEC 61000-4-8	30 A/m	30 A/m	For use in a typical domestic, commercial, or hospital environment.
Proximity fields from RF wireless communications equipment IEC 61000-4-3	IEC 60601-1-2:2014, Table 9	IEC 60601-1-2:2014, Table 9	For use in a typical domestic, commercial, or hospital environment.
Note: U_T is the a.c. mains voltage prior to application of the test level.			

Guidance and Manufacturer's Declaration - Electromagnetic Immunity			
Immunity Test	IEC 60601-1-2:2014 Test Level	Max foreseeable use condition per IEC 60601-1-2:2014	Electromagnetic Environment Guidance
Radiated RF IEC 61000-4-3	10 V/m 80 MHz to 2.7 GHz 80% AM at 1 kHz	10 V/m 80 MHz to 6 GHz 80% AM at 1 kHz	<p>Portable and mobile RF communications equipment should be used no closer to any part of the transmitter than the recommended separation distance of 12 in (30 cm).</p> <p>Field strengths from fixed RF transmitters, as determined by an electromagnetic site survey, should be less than the compliance level in each frequency range.</p> <p>Interference may occur in the vicinity of equipment marked with the following symbol:</p> 
<p>Note: These guidelines may not apply in all situations. Electromagnetic propagation is affected by absorption, and reflection from structures, objects and people.</p>			

Warranty

Medtronic MiniMed, Inc. (or such other legal entity as may be referred to as manufacturer on the labeling of this device "Medtronic MiniMed") warrants the Medtronic transmitter to the purchaser of the product against defects in material and workmanship for a period of one (1) year and the charger for up to one (1) year from the date of purchase.

During the warranty period, Medtronic MiniMed will replace or repair, at its discretion, any defective transmitter or charger, subject to the conditions and exclusions stated herein. This warranty applies only to new devices. In the event a transmitter or charger is replaced, the warranty period will not be extended past its original expiration date.

This warranty is valid only if the Medtronic transmitter or charger is used in accordance with the manufacturer's instructions. Without limitation, this warranty will not apply:

- If damage results from changes or modifications made to the transmitter or charger by the user, or third persons, after the date of purchase.

- If damage results from service or repairs performed by any person or entity other than the manufacturer.
- If damage results from a *Force Majeure* or other event beyond the control of the manufacturer.
- If damage results from negligence or improper use, including but not limited to: improper storage, submersion in water, physical abuse, (such as dropping).
- If damage results from use of the device in a manner other than according to the manufacturer's product labeling, instructions for use, or regulatory notifications.

This warranty shall be personal to the original purchaser. Any sale, rental or other transfer or use of the product covered by this warranty to or by a user other than the original purchaser shall cause this warranty to immediately terminate. This warranty does not apply to Glucose Sensors and other accessories.

The remedies provided for in this warranty are the exclusive remedies available for any breach hereof. Neither Medtronic MiniMed nor its suppliers or distributors shall be liable for any incidental, consequential, or special damage of any nature or kind caused by or arising out of a defect in the product.

All other conditions and warranties, other than mandatory statutory warranties, expressed or implied, are excluded, including the warranties of merchantability and fitness for a particular purpose.

This warranty gives the purchaser specific legal rights, and the purchaser may also have other rights that vary under local law. This warranty does not affect the purchaser's statutory rights.

Open Source Software (OSS) disclosure

This document identifies the Open Source Software that may be separately called, executed, linked, affiliated, or otherwise utilized by this product.

Such Open Source Software is licensed to users subject to the terms and conditions of the separate software license agreement for such Open Source Software.

Use of the Open Source Software by you shall be governed entirely by the terms and conditions of such license.

The source/object code and applicable license for the Open Source Software can be obtained at the following site: <http://www.ouah.org/ogay/hmac/>.

Icon glossary

For definition of the symbols displayed on the device and package labels, please see www.medtronicdiabetes.com/symbol-definitions.

© 2021 Medtronic MiniMed, Inc. All rights reserved.

Medtronic, Medtronic logo and Further, Together are trademarks of Medtronic. ™* Third-party brands are trademarks of their respective owners. All other brands are trademarks of a Medtronic company.

Bluetooth™*

Detachol™*

Wi-Fi™*

Medtronic



Medtronic MiniMed
18000 Devonshire Street
Northridge, CA 91325 USA
1800 646 4633
+1 818 576 5555
www.medtronicdiabetes.com

REF MMT-7911, MMT-7736L, MMT-7715,
MMT-7512

R_x Only

M022413C001_1

GUARDIAN™ 4 TRANSMITTER



Medtronic

Medtronic and Medtronic logo are trademarks of Medtronic. [™] Third-party brands are trademarks of their respective owners. All other brands are trademarks of a Medtronic company. The following list includes trademarks or registered trademarks of a Medtronic entity in the United States or in other countries.

MiniMed[™]

Contacts:**Africa:**

Medtronic South Africa and Southern Africa
Office Reception Tel: +27(0) 11 260 9300
Diabetes: 24/7 Helpline: 0800 633 7867
Sub-Sahara 24/7 Helpline: +27(0) 11 260 9490

Albania:

Net Electronics Albania
Tel: +355 697070121

Argentina:

Corpomedica S.A.
Tel: +(11) 4 814 1333
Medtronic Directo 24/7:
+0800 333 0752

Armenia:

Exiol LLC
Tel: +374 98 92 00 11
or +374 94 38 38 52

Australia:

Medtronic Australasia Pty. Ltd.
Tel: 1800 668 670

Bangladesh:

Sonargaon Healthcare Pvt Ltd.
Mobile: (+91)-9903995417
or (+880)-1714217131

Belarus:

Zarga Medica
Tel: +37517 336 97 00
+37529 613 08 08
+37517 215 02 89
Helpline: +74995830400

België/Belgique:

N.V. Medtronic Belgium S.A.
Tel: 0800-90805

Bosnia and Herzegovina:

"Novopharm" d.o.o. Sarajevo
Tel: +387 33 476 444
Helpline: 0800 222 33
Epsilon Research Intern. d.o.o.
Tel: +387 51 251 037
Helpline: 0800 222 33

Brasil:

Medtronic Comercial Ltda.
Tel: +(11) 2182-9200
Medtronic Directo 24/7:
+0800 773 9200

Bulgaria:

RSR EOOD
Tel: +359 888993083
Helpline: +359 884504344

Canada:

Medtronic Canada ULC
Tel: 1-800-284-4416 (toll free/sans-frais)

Česká republika:

Medtronic Czechia s.r.o.
Tel: +420 233 059 111
Non-stop helpLine (24/7):
+420 233 059 059
Zákaznický servis (8:00 - 17:00):
+420 233 059 950

Chile:

Medtronic Chile
Tel: +(9) 66 29 7126
Medtronic Directo 24/7:
+1 230 020 9750
Medtronic Directo 24/7 (From Santiago): +(2) 595 2942

China:

Medtronic (Shanghai) Management Co., Ltd.
Landline: +86 800-820-1981
Mobile Phone: +86 400-820-1981
Calling from outside China: +86 400-820-1981

Colombia:

Medtronic Latin America Inc. Sucursal Colombia
Tel: +(1) 742 7300
Medtronic Directo 24/7 (Landline):
+01 800 710 2170
Medtronic Directo 24/7 (Cellular):
+1 381 4902

Croatia:

Mediligo d.o.o.
Tel: +385 1 6454 295
Helpline: +385 1 4881144
Medtronic Adriatic d.o.o.
Helpline: +385 1 4881120

Danmark:

Medtronic Danmark A/S
Tel: +45 32 48 18 00

Deutschland:

Medtronic GmbH
Geschäftsbereich Diabetes
Telefon: +49 2159 8149-370
Telefax: +49 2159 8149-110
24-Std-Hotline: 0800 6464633

Eire:

Accu-Science LTD.
Tel: +353 45 433000

España:

Medtronic Ibérica S.A.
Tel: +34 91 625 05 42
Fax: +34 91 625 03 90
24 horas: +34 900 120 330

Estonia:

AB Medical Group Estonia Ltd
Tel: +372 6552310
Helpline: +372 5140694

Europe:

Medtronic Europe S.A. Europe, Middle East and Africa HQ
Tel: +41 (0) 21-802-7000

France:

Medtronic France S.A.S.
Tel: +33 (0) 1 55 38 17 00

Hellas:

Medtronic Hellas S.A.
Tel: +30 210677-9099

Hong Kong:

Medtronic Hong Kong Medical Ltd.
Tel: +852 2919-1300
To order supplies: +852 2919-1322
24-hour helpline: +852 2919-6441

India:

India Medtronic Pvt. Ltd.
Tel: (+91)-80-22112245 / 32972359
Mobile: (+91)-9611633007
Patient Care Helpline:
1800 209 6777

Indonesia:

Medtronic International Ltd.
Tel: +65 6436 5090
or +65 6436 5000

Israel:

Medtronic Trading Ltd.
Tel.: +972-9-9724400
Tel. (product support –
8:00-17:00): +972-9-9724489
Helpline (weekends & holidays):
1-800-611-888

Italia:

Medtronic Italia S.p.A.
Tel: +39 02 24137 261
Fax: +39 02 24138 210
Servizio assistenza tecnica:
N° verde: 800 60 11 22

Japan:

Medtronic Japan Co. Ltd.
24 Hr. Support Line: 0120-56-32-56
日本：日本メドトロニック株式会社
24時間サポートライン：
0120-56-32-56

Kazakhstan:

TOO "Медтроник Казахстан"
Tel: +7 727 321 13 30 (Almaty)
Круглосуточная линия поддержки:
8 800 080 5001

Kosovo:

Yess Pharma
Tel: +377 44 999 900
Helpline: +37745888388

Latin America:

Medtronic, Inc.
Tel: 1(305) 500-9328
Fax: 1(786) 709-4244

Latvija:

RAL SIA
Tel: +371 67316372
Helpline (9am to 6pm):
+371 29611419

Lithuania:

Monameda UAB
Tel: +370 68405322
Helpline: +370 68494254

Macedonia:

Alkaloid Kons Dooel
Tel: +389 23204438

Magyarország:

Medtronic Hungária Kft.
Tel: +36 1 889 0688

Malaysia:

Medtronic International Ltd.
Tel: +603 7946 9000

México:

Medtronic Servicios S. de R. L. de C.V.
Tel (México DF): +(11) 029 058
Tel (Interior): +01 800 000 7867
Medtronic Directo 24/7 (from México
DF):
+(55) 36 869 787
Medtronic Directo 24/7:
+01 800 681 1845

Middle East and North Africa:

Regional Office
Tel: +961-1-370 670

Montenegro:

Glosarij d.o.o.
Tel: +382 20642495

Nederland, Luxembourg:

Medtronic B.V.
Tel: +31 (0) 45-566-8291
Gratis: 0800-3422338

New Zealand:

Medica Pacifica
Phone: 64 9 414 0318
Free Phone: 0800 106 100

Norge:

Medtronic Norge A/S
Tel: +47 67 10 32 00
Fax: +47 67 10 32 10

Österreich:

Medtronic Österreich GmbH
Tel: +43 (0) 1 240 44-0
24 – Stunden – Hotline: 0820 820 190

Philippines:

Medtronic International Ltd.
Tel: +65 6436 5090
or +65 6436 5000

Россия

ООО «Медтроник»
Tel: +7 495 580 73 77
Круглосуточная линия поддержки
8 800 200 76 36

Polska:

Medtronic Poland Sp. z o.o.
Tel: +48 22 465 6934

Portugal:

Medtronic Portugal Lda
Tel: +351 21 7245100
Fax: +351 21 7245199

Puerto Rico:

Medtronic Puerto Rico
Tel: 787-753-5270

Republic of Korea:

Medtronic Korea, Co., Ltd.
Tel: +82.2.3404.3600

Romania:

Medtronic Romania S.R.L.
Tel: +40372188017
Helpline: +40 726677171

Schweiz:

Medtronic (Schweiz) AG
Tel: +41 (0)31 868 0160
24-Stunden-Hotline: 0800 633333
Fax Allgemein: +41 (0)318680199

Serbia:

Epsilon Research International d.o.o.
Tel: +381 113115554
Medtronic Serbia D.o.o
Helpline: +381 112095900

Singapore:

Medtronic International Ltd.
Tel: +65 6436 5090
or +65 6436 5000

Slovenija:

Zaloker & Zaloker d.o.o.
Tel: +386 1 542 51 11
24-urna tehnična pomoč:
+386 51316560

Slovenská republika:

Medtronic Slovakia, s.r.o.
Tel: +421 26820 6942
HelpLine: +421 26820 6986

Sri Lanka:

Swiss Biogenics Ltd.
Mobile: (+91)-9003077499
or (+94)-777256760

Suomi:

Medtronic Finland Oy
Tel: +358 20 7281 200
Help line: +358 800 164 064

Sverige:

Medtronic AB
Tel: +46 8 568 585 20
Fax: +46 8 568 585 11

Taiwan:

Medtronic (Taiwan) Ltd.
Tel: 02-21836000
Toll free: +886-800-005285

Thailand:

Medtronic (Thailand) Ltd.
Tel: +662 232 7400

Türkiye:

Medtronic Medikal Teknoloji
Ticaret Ltd. Sirketi.
Tel: +90 216 4694330

USA:

Medtronic Diabetes Global
Headquarters
24-Hour Technical
Support: +1-800-646-4633
To order supplies: +1-800-843-6687

Ukraine:

ТОВ «Медтронік Україна»
Лінія цілодобової підтримки:
Тел.: 0 800 508 300















United Kingdom:









Medtronic Ltd.
Tel: +44 1923-205167

Vietnam:

Medtronic Vietnam
Tel: +84 283 926 2000

Icon Table

	Serial number
	Catalogue number
	Medical device
	One per container/package
	Date of manufacture
	Manufacturer
	Storage temperature limits
	Non-ionizing electromagnetic radiation
	Configuration or unique version identifier
	Type BF applied part
	Transmitter: Protected against the effects of continuous immersion in water (2.4 meters (8 feet) immersion for 30 minutes).
	Storage humidity limits
	Fragile, handle with care
	Keep dry

	Recyclable, contains recycled content
	Do not dispose of this product in unsorted municipal waste stream
	Magnetic Resonance (MR) Unsafe
	Recharge-by date
	Bluetooth® wireless technology or Bluetooth® enabled
	Requires prescription in the USA
	Conformité Européenne (European Conformity). This symbol means that the device fully complies with applicable European Union Acts.
	Consult instructions for use
	Caution: consult instructions for use for important warnings or precautions not found on the label

Guardian 4

Introduction

The Guardian 4 transmitter (MMT-7841) with Bluetooth® wireless technology is a component of the continuous glucose monitoring (CGM) system. The transmitter collects and calculates sensor data and sends the data to a compatible display device.

Indications for use

The Guardian 4 transmitter (MMT-7841) is intended to monitor glucose levels for the management of diabetes.

Contraindications

No contraindications are associated with Guardian 4 transmitter use.

User Safety

Warnings

- Always refer to the Guardian 4 Sensor User Guide for all precautions, warnings, and instructions related to the sensor. Not referring to the Guardian 4 Sensor User Guide can result in serious injury or damage to the sensor.
- Do not allow children to put small parts in their mouth. This product may pose a choking hazard that can result in serious injury or death.
- Do not use the Guardian 4 transmitter if you are pregnant or critically ill. Since the transmitter has not been studied in these populations, the impact of medications common to these conditions on transmitter performance is unknown and the transmitter may be inaccurate in these populations.
- Do not change or modify the device unless expressly approved by Medtronic Diabetes. Modifying the device can cause serious injury, interfere with the ability to operate the device, and void the warranty.
- Do not expose the transmitter to Magnetic Resonance Imaging (MRI) equipment, diathermy devices, or other devices that generate strong magnetic fields (for example x-ray, CT scan or other types of radiation). Exposure to a strong magnetic field has not been evaluated and can cause the device to malfunction, result in serious injury, or be unsafe. If the transmitter is exposed to a strong magnetic field, discontinue use and contact 24-Hour Technical Support for further assistance.
- Do not use the tester if it comes in contact with blood. Touching blood can cause infection.
- Bleeding may occur after inserting the sensor. Always make sure that the site is not bleeding before connecting the transmitter to the sensor. Blood can get into the transmitter connector and

damage the device. Discard the device if damaged. If bleeding occurs, apply steady pressure with a sterile gauze, pad, or clean cloth at the insertion site until bleeding stops. After bleeding stops, connect the transmitter to the sensor.

- Do not discard the transmitter in a medical waste container or expose it to extreme heat. The transmitter contains a battery that may ignite and result in serious injury.
- For questions or concerns related to product use, contact 24-Hour Technical Support for assistance.
- For medical questions or concerns, contact a healthcare provider.

Precautions

- Do not use the transmitter adjacent to other electrical equipment that may cause interference with the normal system operation.
- Only use the Guardian 4 sensor (MMT-7040) with the transmitter. Do not use any other sensor. Other sensors are not intended for use with the transmitter and will damage the transmitter and the sensor.
- Only use the green colored tester (MMT-7736L) with the transmitter. Pockets on the transmitter are visible when connected to the tester. Do not use any other test plug. Other test plugs are not intended for use with the transmitter and will damage the transmitter and the tester.

Figure 1. Transmitter pockets

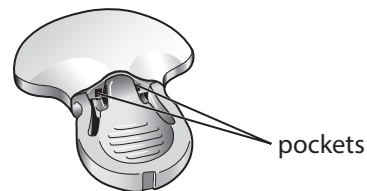

-
- Always use the tester when cleaning the transmitter. Do not use any other test plug with the transmitter. Use of another test plug can allow water to get into the transmitter or can prevent proper cleaning. Water can damage the transmitter.
 - Do not twist the tester or sensor while attached to the transmitter. Twisting the tester or sensor will damage the transmitter.
 - Do not allow the tester to come in contact with any liquid when not connected to the transmitter. A wet tester can damage the transmitter.

- Do not allow the transmitter to come in contact with any liquid when not connected to a sensor or to the tester. Moisture will damage the transmitter and a wet transmitter can damage the sensor.
- Do not clean the O-rings on the tester with any substances. Cleaning the O-rings can damage the tester.

Figure 2. O-rings

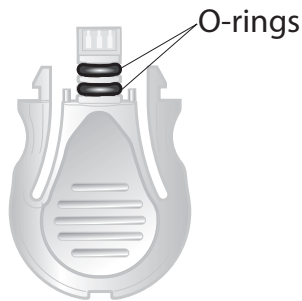

Radio Frequency (RF) communication

This device complies with the United States Federal Communications Commission (FCC) and international standards for electromagnetic compatibility. This device complies with Part 15 of the FCC Rules. Operation is subject to two conditions: (1) This device may not cause harmful interference, and (2) this device must accept any interference received, including interference that may cause undesired operation.

This device has been tested and found to comply with the limits for a Class B digital device, pursuant to Part 15 of the FCC rules. These limits are designed to provide reasonable protection against harmful interference in a residential installation. This device generates, uses, and can radiate radio frequency energy and, if not installed and used in accordance with the instructions, may cause harmful interference to radio communications. However, there is no guarantee that interference will not occur in a particular installation. If this device does cause harmful interference to radio or television reception, which can be determined by turning the device off and on, the user is encouraged to try to correct the interference by one or more of the following measures:

- Reorient or relocate the receiving antenna.
- Increase the separation between the equipment and the receiver.
- Decrease the distance between the transmitter and the insulin pump to 6 feet (1.8 meters) or less.
- Increase the separation between the transmitter and the equipment that is receiving or emitting interference.

Note: Harmful interference is defined by the FCC as follows. Any emission, radiation or induction that endangers the functioning of a radio navigation service or of other safety services or seriously degrades, obstructs or repeatedly interrupts a radio communications service operating in accordance with FCC rules.

Changes or modifications made to this equipment not expressly approved by Medtronic MiniMed could void the user's authority to operate the equipment.

IEC 60601-1-2 Special EMC Precautions for Medical Electrical Equipment

1. Special Precautions regarding Electromagnetic Compatibility (EMC): This body worn device is intended to be operated within a reasonable residential, domestic, public or work environment where common levels of radiated "E" (V/m) or "H" fields (A/m) exist, such as cellular phones, Wi-Fi™*, Bluetooth® wireless technology, electric can openers, microwave and induction ovens. This device generates, uses, and can radiate radio frequency energy and, if not installed and used in accordance with the provided instructions, may cause harmful interference to radio communications.
2. Portable and mobile RF communications equipment can affect medical electrical equipment. If you encounter RF interference from a mobile or stationary RF transmitter, move away from the RF transmitter that is causing the interference.
3. Be careful when using the transmitter closer than 30 cm (12 in) to portable radio frequency (RF) equipment or electrical equipment. If the transmitter must be used next to portable RF equipment or electrical equipment, observe the transmitter to verify correct system operation. Degradation of the performance of the transmitter could result.
4. The essential performance (EP) of the transmitter is to measure and transmit to a monitoring device the sensing device's signal value(s) within the transmitter's accuracy requirements under the specified use conditions outlined in the system user guide and for the duration of the expected service life. If the transmitter experiences electromagnetic disturbances, either no or incorrect data may be transmitted. In such situations, refer to the operation, maintenance, and troubleshooting instructions within the applicable user guides. You may also use the tester to test if the transmitter is operating properly. If the transmitter is damaged or if it cannot communicate with the display device, contact 24-Hour Technical Support for assistance.

Assistance

Medtronic provides a 24-Hour Technical Support line for assistance.

Department	Telephone number
24-Hour Technical Support (calls within the	800 646 4633

Department	Telephone number
United States)	
24-Hour Technical Support (calls outside the United States)	+1 818 576 5555
Website	www.medtronicdiabetes.com

Using the transmitter

Components needed

- Guardian 4 transmitter (MMT-7841)
- Tester (MMT-7736L)
- Charger (MMT-7715)

Figure 3. Components



Preparing the transmitter

The transmitter contains a non-replaceable, rechargeable battery that can recharge as needed with the charger. The transmitter needs to be charged before use. The charger has a green light that shows the charging status and a red light that communicates any problems during charging. If there is a red light, see *Troubleshooting, page 24*. The charger requires one AAA alkaline battery.

Note: If the battery is installed incorrectly or is low, the charger will not work. Repeat the battery installation steps using a new battery.

Installing a battery in the charger

To install a battery in the charger:

1. Push the battery cover in and slide it off (as shown in image A in step 3).
2. Insert a new AAA alkaline battery. Make sure the + and - symbols on the battery align with these same symbols shown on the charger.
3. Slide the cover back on the charger until it clicks into place (as shown in image B in step 3).

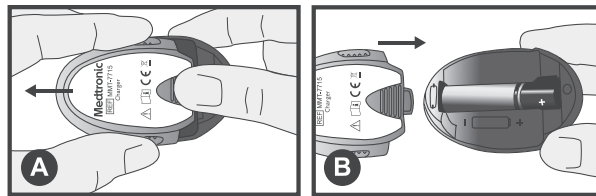

Charging the transmitter

CAUTION: Always charge the transmitter before inserting the sensor. A depleted transmitter does not function. A fully charged transmitter works at least seven days without recharging. A depleted transmitter can take up to two hours to recharge.

CAUTION: Do not store the transmitter on the charger for more than 60 days. Disconnect and reconnect to the charger to re-charge again before use. If the transmitter is left on the charger for more than 60 days, the transmitter battery will be permanently damaged.

To charge the transmitter:

1. Push the transmitter and the charger together to connect the transmitter to the charger.

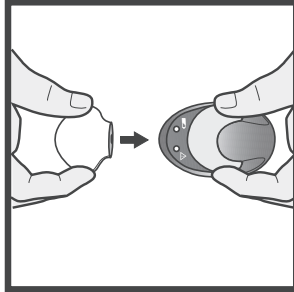

2. Within 10 seconds after the transmitter is connected, a green light on the charger will flash for one to two seconds as the charger powers on. For the rest of the charging time, the green light on the charger will continue to flash in a pattern of four flashes with a pause between the four flashes.
3. When charging is complete, the green light on the charger will stay on, without flashing, for 15 to 20 seconds and then turn off.

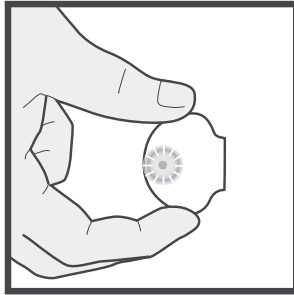

4. After the green charger light turns off, disconnect the transmitter from the charger. The green light on the transmitter starts to flash.

Pairing the transmitter

The transmitter must be paired to the system before a sensor can be used. Always refer to the system user guide for instructions on how to pair the transmitter to the system.

Inserting the sensor

Always refer to the Guardian 4 Sensor User Guide for instructions on how to insert the sensor.

Connecting the transmitter to the sensor

Before proceeding, have the system user guide available.

To connect the transmitter to the sensor:

1. After the sensor is inserted, consult the Guardian 4 Sensor User Guide for details on how to apply the required tape before connecting the transmitter.
2. Hold the rounded end of the inserted sensor to prevent it from moving during connection.

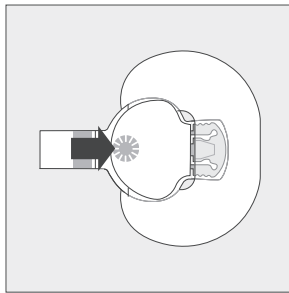

3. Hold the transmitter as shown. Line up the two notches on the transmitter with the side arms of the sensor. The flat side of the transmitter should face the skin.
4. Slide the transmitter onto the sensor connector until the sensor arms snap into the notches on the transmitter. If the transmitter is properly connected, and if the sensor has had enough time to become hydrated with the interstitial fluid, the green light on the transmitter will flash 6 times.

Note: If the transmitter does not flash, see *Troubleshooting, page 24*.

5. When the transmitter light flashes green after connecting to the sensor, use the system to start the sensor. For more instructions, see the system user guide.
6. Attach the adhesive tab of the sensor to the transmitter.
7. After the transmitter is connected, consult the Guardian 4 Sensor User Guide for instructions on how to apply a second tape.
8. Follow the instructions that appear on the display device or in the system user guide.

Disconnecting the transmitter from the sensor

To disconnect the transmitter from the sensor:

1. Carefully remove any tape from the transmitter and sensor.

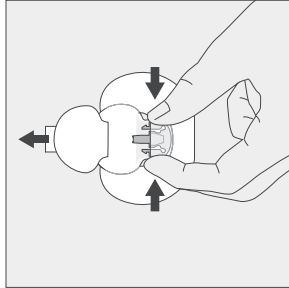

2. Remove the adhesive tab from the top of the transmitter.
3. Hold the transmitter as shown, and pinch the flexible side arms of the sensor between the thumb and forefinger.
4. Gently pull the transmitter away from the sensor.

Removing the sensor

Always refer to the Guardian 4 Sensor User Guide for instructions on how to remove the sensor.

Reconnecting the transmitter to a sensor that is already inserted

The transmitter can be reconnected to the sensor currently in use. Simply connect the transmitter to the sensor that is already inserted. Select **Reconnect Sensor** when the display device detects the transmitter. It may take a few seconds to establish a connection when reconnecting a sensor. Reattach the adhesive tab of the sensor to the transmitter and reapply any required tape. When reconnected, the sensor goes through another warm-up period.

Tester

The tester is used to test the transmitter to make sure it is working. The tester is also used as a required component to create a waterproof seal when cleaning the transmitter. Properly connecting the tester to the transmitter ensures that fluids do not come in contact with the connector pins inside the transmitter. Fluids can cause connector pins to corrode and affect the performance of the transmitter.

Do not twist the tester while attached to the transmitter. This will damage the transmitter.

The tester can be used for one year. If the tester is used for more than one year, the connector pins inside the transmitter can be damaged, because the tester cannot continue to provide a waterproof seal. For instructions on how to check the connector pins, see *Inspecting the transmitter connector pins*, page 18.

CAUTION: Only use the green colored tester (MMT-7736L) with the transmitter. Pockets on the transmitter are visible when connected to the tester. Do not use any other test plug. Other test plugs are not intended for use with the transmitter and will damage the transmitter and the tester.

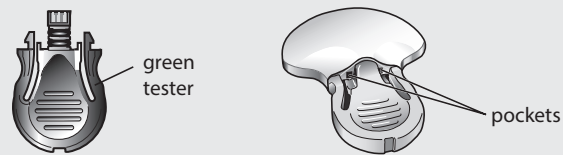

Inspecting the transmitter connector pins

This image is an example of how the connector pins should look for the transmitter.

Figure 4. Transmitter components

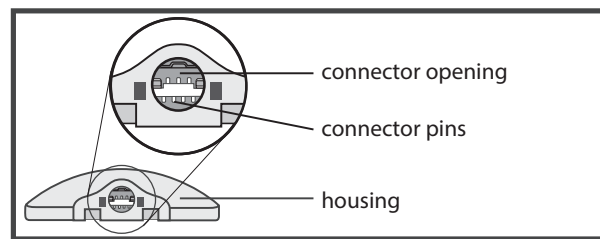

Look inside the connector opening of the transmitter to make sure that the connector pins are not damaged or corroded. If the connector pins are damaged or corroded, the transmitter cannot communicate with the charger or the display device. Contact 24-Hour Technical Support. It may be time to replace your transmitter.

Look for moisture inside the connector opening. If any moisture is present, allow the transmitter to dry for at least one hour. Moisture inside the connector opening could cause the transmitter to not work properly and could cause corrosion and damage over time.

Connecting the tester for testing or cleaning

Before proceeding, have your system user guide available.

To connect the tester:

1. Hold the transmitter and the tester as shown. Line up the flat side of the tester with the flat side of the transmitter.

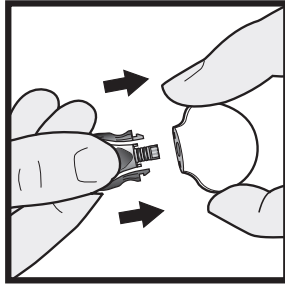

2. Push the tester into the transmitter until the flexible side arms of the tester click into the notches on both sides of the transmitter.
When properly connected, the green light on the transmitter flashes 6 times.
3. To test the transmitter, check the sensor icon in the display device to ensure that the transmitter is sending a signal (see your system user guide).
4. To clean the transmitter, see *Cleaning the transmitter*, page 20.
5. After testing or cleaning, disconnect the tester from the transmitter.

Disconnecting the tester

To disconnect the tester:

1. Hold the transmitter body as shown and pinch the side arms of the tester.

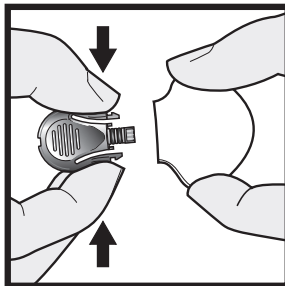

2. With the tester arms pinched, gently pull the transmitter away from the tester.

Note: To save transmitter battery life, do NOT leave the tester connected after cleaning or testing.

Cleaning the transmitter

When using the transmitter, always follow the cleaning procedure.

WARNING: Do not discard the transmitter in a medical waste container or expose it to extreme heat. The transmitter contains a battery that may ignite and result in serious injury.

Note: The tester is a required component for cleaning the transmitter. For details, see *Tester*, page 17.

CAUTION: Do not use an automated washer-disinfector to clean or disinfect the device. Using an automated washer-disinfector to clean or disinfect the device will cause damage to the transmitter.

To clean the transmitter, use these materials:

- mild liquid soap
- soft-bristled toddler toothbrush
- container
- clean, lint-free dry cloths

WARNING: Do not use the device if there is any cracking, flaking, or damage to the housing. Cracking, flaking, or damage to the housing are signs of deterioration. Deterioration of the housing can affect the ability to properly clean the transmitter and result in serious injury. Call 24-Hour Technical Support and discard the device according to local regulations for battery disposal (non-incineration), or contact your healthcare professional for disposal information.

To clean the transmitter:

1. Wash hands thoroughly.
2. Attach the tester to the transmitter to create a waterproof seal.

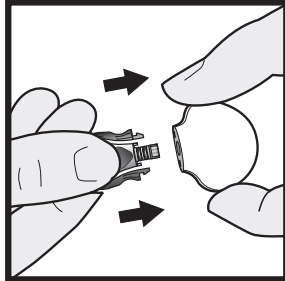

3. If there is adhesive residue on the transmitter, see *Removing adhesive residue*, page 23.
4. Rinse the transmitter under room temperature tap water for at least one minute, and until visibly clean. Make sure all hard-to-reach areas are rinsed completely.

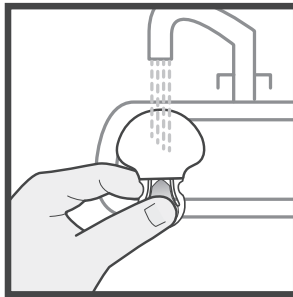

5. Prepare a mild liquid soap solution using 1 teaspoon (5 mL) of mild liquid dish soap per 1 gallon (3.8 L) of room temperature tap water.
6. With the tester still attached, submerge the transmitter in the mild liquid soap solution and soak for one minute.

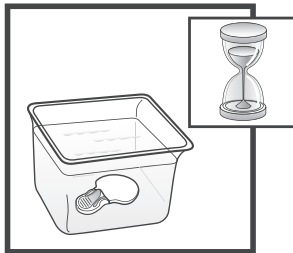

7. Holding the tester, brush the entire surface of the transmitter using a soft-bristled toddler toothbrush. Make sure to brush all hard-to-reach areas until visibly clean.

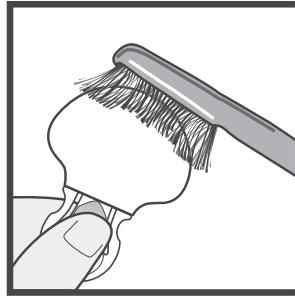

8. Rinse the transmitter under running room temperature tap water for at least one minute, and until all visible liquid soap is gone.

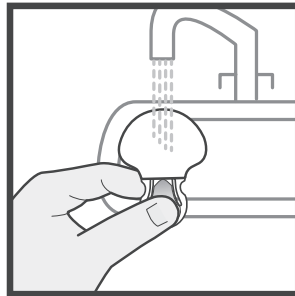

9. Dry the transmitter and tester with a clean, dry cloth.

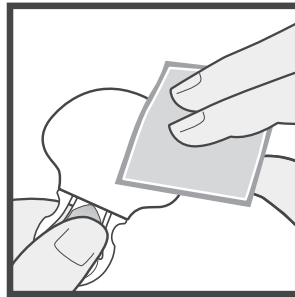

10. Place the transmitter and tester on a clean, dry cloth and air dry them completely.

11. Disconnect the tester from the transmitter by gently squeezing the arms of the tester.

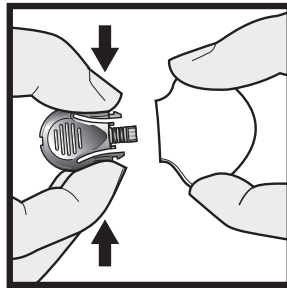

Removing adhesive residue

Follow these instructions if there is adhesive residue present on the transmitter.

Use cotton swabs and a medical adhesive remover such as Detachol™*, a mineral spirit, to remove adhesive residue.

Note: During testing, Detachol™* was used to remove the adhesive residue from the transmitter. Detachol™* is recommended for use but may not be available in all countries.

To remove adhesive residue:

1. Make sure the tester is attached to the transmitter.
2. Soak a cotton swab in the medical adhesive remover.
3. Hold the tester and gently rub the adhesive remover on the transmitter until the residue is removed.

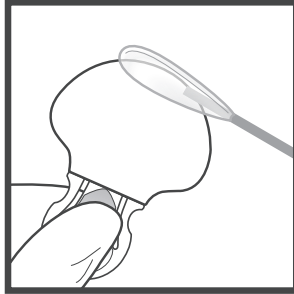

4. Continue with the cleaning procedure. See *Cleaning the transmitter*, page 20 for details.

Cleaning the charger

This procedure is for general cleaning as required, based on physical appearance.

CAUTION: Do not immerse the charger in water or any other cleaning agent. The charger is not waterproof. Water can damage the charger and cause the device to malfunction.

To clean the charger:

1. Wash hands thoroughly.
2. Use a damp cloth with mild cleaning solution, such as a dishwashing detergent, to clean any dirt or foreign material from the outside of the charger. Never use organic solvents, such as paint thinner or acetone, to clean the charger.
3. Place the charger on a clean, dry cloth and air dry for two to three minutes.

Bathing and swimming

After the transmitter and sensor are connected, they form a waterproof seal to a depth of 8 feet (2.4 m) for up to 30 minutes. Shower and swim without removing them.

Troubleshooting

The table shown contains troubleshooting information for the transmitter, charger, and tester. For more information about troubleshooting, see the system user guide.

Table 1. Troubleshooting issues

Problem	Likely Cause(s)	Resolution
The transmitter is connected to the charger and no lights come on.	The transmitter connector pins are damaged or corroded. The charger battery has no power or no battery is inserted.	<ol style="list-style-type: none"> 1. Check the transmitter connector pins for damage or corrosion. For more information about the connector pins, see <i>Inspecting the transmitter connector pins, page 18</i>. If the pins are damaged or corroded, contact 24-Hour Technical Support. It may be time to replace the transmitter. 2. If there is no damage to the connector pins, replace the battery in the charger. For instructions on replacing the charger battery, see <i>Installing a battery in the charger, page 14</i>.
During charging, the flashing green light on the charger turns off and a longer flashing red light appears on the charger.	The charger battery is low on power.	Replace the battery in the charger. For instructions on replacing the charger battery, see <i>Installing a battery in the charger, page 14</i> .
During charging, the flashing green light on the charger turns off and there is a series of quick flashing red lights on the charger for two seconds at a time.	The transmitter is low on power.	<ol style="list-style-type: none"> 1. Charge the transmitter continuously for one hour. If flashing does not stop, proceed to step 2. 2. Charge the transmitter continuously for eight hours. If flashing does not stop, call 24-Hour Technical Support. It may be time to replace the transmitter.
During charging, a mix of quick and long flashing red lights appear on the charger.	The charger and the transmitter are low on power.	<ol style="list-style-type: none"> 1. Replace the battery in the charger. For instructions on replacing the charger battery, see <i>Installing a battery in the charger, page 14</i>. 2. Charge the transmitter continuously for one hour. If the quick flashing red lights do not stop, proceed to step 3. 3. Charge the transmitter continuously for eight hours. If flashing does not stop,

Table 1. Troubleshooting issues (continued)

Problem	Likely Cause(s)	Resolution
		call 24-Hour Technical Support. It may be time to replace the transmitter.
When connected to the sensor, the green light on the transmitter does not flash.	The transmitter is not fully connected. The transmitter is low on power. The sensor is not properly inserted into the body.	<ol style="list-style-type: none"> 1. Disconnect the transmitter from the sensor. 2. Wait for five seconds and reconnect them. If the green light still does not flash, proceed to step 3. 3. Fully charge the transmitter and connect it to the tester. If the green light still does not flash, see troubleshooting on "When connected to the tester, the green light on the transmitter does not flash." If the green light flashes, proceed to step 4. 4. Disconnect the transmitter from the tester, wait at least five seconds, and connect the transmitter to the sensor. If the green light still does not flash, proceed to step 5. 5. The sensor may not be properly inserted into the body. Remove the sensor from the body and insert a new sensor.
When connected to the tester, the green light on the transmitter does not flash.	The transmitter is not fully connected. The transmitter is low on power.	<ol style="list-style-type: none"> 1. Check the connection between the transmitter and the tester. If the green light still does not flash, proceed to step 2. 2. Fully charge the transmitter. 3. Test the transmitter with the tester again. If you still do not see the green light flash, call 24-Hour Technical Support. It may be time to replace the transmitter.
The transmitter battery does not last for seven days.	The transmitter is not fully charged when connected to the sensor. The transmitter and display device frequent-	<ol style="list-style-type: none"> 1. Fully charge the transmitter before connecting it to the sensor. If the transmitter battery still does not last for the duration of one sensor use, proceed to step 2. 2. Move away from any equipment that can cause RF interference. For more informa-

Table 1. Troubleshooting issues (continued)

Problem	Likely Cause(s)	Resolution
	ly lose wireless connection.	<p>tion on RF interference, see the Radio Compliance Information sheet included with the display device.</p> <p>3. Make sure the display device and the transmitter are located on the same side of the body to minimize any RF interference. If your fully charged transmitter battery continues to lose power before a full seven days, call 24-Hour Technical Support. It may be time to replace the transmitter.</p>
The transmitter loses connection with the display device.	The display device is out of range. There is RF interference from other devices.	<p>1. Move away from any equipment that can cause RF interference. For more information on RF interference, see the Radio Compliance information sheet included with the transmitter. If the transmitter is still not communicating with the display device, proceed to step 2.</p> <p>2. Make sure the display device and the transmitter are located on the same side of the body to minimize any RF interference. If your transmitter is still not communicating with your display device, call 24-Hour Technical Support for assistance.</p>
<p>Note: An alarm or alert occurs and a message appears when the transmitter has lost connection with the display device for 30 minutes.</p>		

Storage

Store the transmitter, charger, and tester in a clean, dry location at room temperature. If the transmitter is not in use, you must charge the transmitter at least once every 60 days.

CAUTION: Do not store the transmitter on the charger. If the transmitter is left on the charger for more than 60 days, the battery will be permanently damaged.

Disposal

Do not dispose of the transmitter, charger, and tester in unsorted municipal waste stream. Dispose of the transmitter, charger, and tester according to local regulations for electronic waste disposal.

Technical Specifications

Table 2. Product specifications

Biocompatibility	Transmitter: Complies with EN ISO 10993-1
Applied parts	Transmitter Sensor
Operating conditions	<p>Transmitter temperature: 32 °F to 113 °F (0 °C to 45 °C) 0 °C to 45 °C (32 °F to 113 °F)</p> <p>CAUTION: When operating the transmitter on a tester in air temperatures greater than 106 °F (41 °C), the temperature of the transmitter may exceed 109 °F (43 °C).</p> <p>Transmitter relative humidity: 10% to 95% with no condensation Transmitter pressure: 8.4 psi to 15.4 psi (57.60 kPa to 106.17 kPa) Charger temperature: 50 °F to 104 °F (10 °C to 40 °C) Charger relative humidity: 30% to 75% with no condensation</p>
Storage conditions	<p>Transmitter temperature: -4 °F to 131 °F (-20 °C to 55 °C) Transmitter relative humidity: up to 95% with no condensation Transmitter pressure: 8.4 psi to 15.4 psi (57.6 kPa to 106.17 kPa) Charger temperature: 14 °F to 122 °F (-10 °C to 50 °C) Charger relative humidity: 10% to 95% with no condensation</p>
Battery life	<p>Transmitter: Seven days of CGM immediately following a full charge. Charger: The charger uses one new AAA battery to charge the transmitter.</p>
Transmitter frequency	2.4 GHz band, Bluetooth® wireless technology (version 4.0)
Effective radiated power (ERP)	0.06 mW (-12.05 dBm)
Effective isotropic radiated power (EIRP)	0.1 mW (-9.9 dBm)
Operating range	Up to 6 feet (1.8 meters) in free-air
Transmitter expected service life	The transmitter expected service life is one year depending on patient usage.

Transmitter wireless communication

Quality of service

The transmitter and display device connect via a Bluetooth® low-energy technology network. The transmitter sends glucose data and system-related alerts to the display device, which verifies the integrity of received data after wireless transmission. Quality of the connection is in accordance with the Bluetooth® Specification v4.0.

Data security

The transmitter is designed to only accept radio frequency (RF) communications from recognized and linked devices. The transmitter must be paired before the display device will accept information from the transmitter.

Display devices and system components (meters and transmitters) ensure data security via proprietary means and data integrity using error checking processes, such as cyclic redundancy checks.

Traveling by air

The transmitter is safe for use on commercial airlines. Because travel rules are subject to change, it is advisable to check with the Transportation Safety Administration (TSA) before traveling.

Guidance and manufacturer's declaration

Guidance and Manufacturer's Declaration - Electromagnetic Emissions		
Emissions Test	Compliance	Electromagnetic Environment - Guidance
RF emissions CISPR 11	CISPR 11 Group 1, Class B	The transmitter uses RF energy only for system communications. Therefore, its RF emissions are very low and are not likely to cause any interference in nearby electronic equipment. Note: The preceding statement is required by IEC 60601-1-2 for Group 1, Class B devices. Since the transmitter is battery powered, its emissions will not be affected by the establishment power supply and there is no evidence of any issues associated with the use of the system in domestic establishments.
Harmonic emissions IEC 61000-3-2	Not applicable	
Voltage fluctuations/flicker emissions IEC 61000-3-3	Not applicable	

Guidance and Manufacturer's Declaration - Electromagnetic Immunity			
Immunity Test	IEC 60601-1-2 Test Level	Max foreseeable use condition per IEC 60601-1-2	Electromagnetic Environment Guidance
Electrostatic discharge (ESD) IEC 61000-4-2	±8 kV contact ±2 kV, ±4 kV, ±8 kV, ±15 kV air	±8 kV contact ±2 kV, ±4 kV, ±8 kV, ±15 kV air	For use in a typical domestic, commercial, or hospital environment.
Conducted disturbances induced by RF fields	3 V _{RMS} 150 kHz to 80 MHz 6 V _{RMS} ISM bands between 150 kHz to 80 MHz	Not applicable	Requirement does not apply to this battery powered device.
Electrical fast transient/burst IEC 61000-4-4	±2 kV 100 kHz repetition frequency	Not applicable	Requirement does not apply to this battery powered device.
Surge IEC 61000-4-5	Line to Line: ±0.5 kV, ±1 kV Line to Ground: ±0.5 kV, ±1 kV, ±2 kV	Not applicable	Requirement does not apply to this battery powered device.
Note: U _T is the a.c. mains voltage prior to application of the test level.			
Voltage dips, short interruptions, and voltage variations on power supply lines IEC 61000-4-11	0% U _T ; 0.5 cycles (at 0°, 45°, 90°, 135°, 180°, 225°, 270°, and 315°) 0% U _T ; 1 cycle (at 0°) 70% for 25/30 cycles (at 0°) 0% for 250/300 cycles	Not applicable	Requirement does not apply to this battery powered device.
Power frequency (50/60 Hz) magnetic field IEC 61000-4-8	30 A/m	30 A/m	For use in a typical domestic, commercial, or hospital environment.
Proximity fields from RF wireless communications equipment IEC 61000-4-3	IEC 60601-1-2	IEC 60601-1-2	For use in a typical domestic, commercial, or hospital environment.
Note: U _T is the a.c. mains voltage prior to application of the test level.			
Radiated RF IEC 61000-4-3	10 V/m 80 MHz to 2.7 GHz	10 V/m 80 MHz to 6 GHz	Portable and mobile RF communications equipment

Guidance and Manufacturer's Declaration - Electromagnetic Immunity			
Immunity Test	IEC 60601-1-2 Test Level	Max foreseeable use condition per IEC 60601-1-2	Electromagnetic Environment Guidance
	80% AM at 1 kHz	80% AM at 1 kHz	<p>should be used no closer to any part of the transmitter than the recommended separation distance of 30 cm (12 in). Field strengths from fixed RF transmitters, as determined by an electromagnetic site survey, should be less than the compliance level in each frequency range. Interference may occur in the vicinity of equipment marked with the following symbol:</p> 
<p>Note: These guidelines may not apply in all situations. Electromagnetic propagation is affected by absorption, and reflection from structures, objects and people.</p>			

Warranty

Medtronic MiniMed, Inc. (or such other legal entity as may be referred to as manufacturer on the labeling of this device "Medtronic MiniMed") warrants the Medtronic transmitter to the purchaser of the product against defects in material and workmanship for a period of one (1) year and the charger for up to one (1) year from the date of purchase.

During the warranty period, Medtronic MiniMed will replace or repair, at its discretion, any defective transmitter or charger, subject to the conditions and exclusions stated herein. This warranty applies only to new devices. In the event a transmitter or charger is replaced, the warranty period will not be extended past its original expiration date.

This warranty is valid only if the Medtronic transmitter or charger is used in accordance with the manufacturer's instructions. Without limitation, this warranty will not apply:

- If damage results from changes or modifications made to the transmitter or charger by the user, or third persons, after the date of purchase.
- If damage results from service or repairs performed by any person or entity other than the manufacturer.
- If damage results from a *Force Majeure* or other event beyond the control of the manufacturer.
- If damage results from negligence or improper use, including but not limited to: improper storage, submersion in water, physical abuse, (such as dropping).
- If damage results from use of the device in a manner other than according to the manufacturer's product labeling, instructions for use, or regulatory notifications.

This warranty shall be personal to the original purchaser. Any sale, rental or other transfer or use of the product covered by this warranty to or by a user other than the original purchaser shall cause this warranty to immediately terminate. This warranty does not apply to glucose sensors and other accessories.

The remedies provided for in this warranty are the exclusive remedies available for any breach hereof. Neither Medtronic MiniMed nor its suppliers or distributors shall be liable for any incidental, consequential, or special damage of any nature or kind caused by or arising out of a defect in the product.

All other conditions and warranties, other than mandatory statutory warranties, expressed or implied, are excluded, including the warranties of merchantability and fitness for a particular purpose.

This warranty gives the purchaser specific legal rights, and the purchaser may also have other rights that vary under local law. This warranty does not affect the purchaser's statutory rights.

Open Source Software (OSS) Disclosure

This document identifies the Open Source Software that may be separately called, executed, linked, affiliated, or otherwise utilized by this product.

Such Open Source Software is licensed to users subject to the terms and conditions of the separate software license agreement for such Open Source Software.

Use of the Open Source Software by you shall be governed entirely by the terms and conditions of such license.

The source/object code and applicable license for the Open Source Software can be obtained at the following site: <http://www.ouah.org/ogay/hmac/>.

Icon glossary

For definitions of the symbols on the device and package labels, see www.medtronicdiabetes.com/symbols-glossary.

Medtronic



Medtronic MiniMed

18000 Devonshire Street

Northridge, CA 91325

USA

1 800 646 4633

+1 818 576 5555

www.medtronicdiabetes.com



MMT-7841, MMT-7840, MMT-7920

R_x Only

© 2023 Medtronic
M021373C001_2
2023-02-15



M021373C001

ONE-PRESS SERTER

User Guide



Medtronic

Introduction

The one-press serter (MMT-7512) is used as an aid to insert Medtronic glucose sensors.

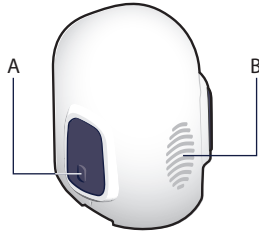

- A. Bump (on both buttons)
- B. Thumbprint marking

Indications for use

The serter is indicated for single-patient use. It is not intended for use by multiple patients. Refer to the system user guide for additional information, such as the intended age group.

Contraindications

No contraindications are associated with serter use. For contraindications related to continuous glucose monitoring, see the system user guide.

Clinical benefits

Not applicable. The serter is an accessory that helps to insert compatible Medtronic sensors.

User Safety

Warnings

Read this entire user guide prior to sensor insertion. The serter does not work the same way as other Medtronic insertion devices. Failure to follow directions may result in improper insertion, pain, or injury.

For additional warnings related to sensor use, see the sensor user guide.

Keep the serter out of reach of children. The serter contains small parts and may pose a choking hazard that can result in serious injury or death.

Healthcare professionals and caregivers:

- A retractable needle is attached to the sensor. Minimal bleeding may occur. Always wear gloves to insert the sensor
- Cover the sensor with sterile gauze to remove the needle housing from the sensor

Place the needle housing directly into a sharps container after sensor insertion to prevent accidental needle stick injury.

Always inspect the sensor packaging for damage before use. Sensors are sterile and non-pyrogenic unless the package has been opened or damaged. If the sensor packaging is open or damaged, discard the sensor directly into a medical waste container. Use of a non-sterile sensor can result in infection at the insertion site.

For questions or concerns related to serter use, contact 24-Hour Technical Support for assistance.
For medical questions or concerns, contact a healthcare provider.

Assistance

Department	Telephone Number
24-Hour Technical Support (calls within the United States)	+1 800 646 4633
24-Hour Technical Support (calls outside the United States)	+ 1 818 576 5555
Website	www.medtronicdiabetes.com

Precautions

Wash hands with soap and water prior to sensor insertion to reduce the risk of infection.

Inspect the insertion site for bleeding under, around, or on top of the sensor. If bleeding occurs, use a sterile gauze pad to apply steady pressure to the sensor for three minutes.

WARNING: Do not use non-sterile gauze to apply pressure to the sensor. Use of non-sterile gauze can cause infection at the insertion site.

If bleeding stops after three minutes of steady pressure, connect the transmitter to the sensor.

CAUTION: Do not connect the transmitter to the sensor if bleeding at the insertion site does not stop. Active bleeding can damage the transmitter and result in a loss of communication between the transmitter and the receiving device.

If bleeding does not stop after three minutes of steady pressure, remove the sensor, and continue to apply pressure until bleeding stops. Discard the used sensor directly in a sharps container after removal. Insert a new sensor at a different insertion site.

Note: Always use a new insertion site to insert a new sensor. Reuse of the same insertion site can cause redness, irritation, pain, bleeding, tenderness, and inflammation.

Do not clean, resterilize, or attempt to remove the needle from the needle housing. Needle stick injury may occur.

Do not reuse the sensor. Reuse of the sensor can cause damage to the sensor surface and lead to inaccurate sensor glucose values, irritation, and infection at the insertion site.

Rotate the sensor insertion site so that sites do not become overused.

Confirm that the sensor is firmly attached to the skin to prevent it from coming out of the insertion site. Factors that increase the likelihood of the sensor coming out include increased physical activity (particularly in younger patients) and improper taping technique.

Risks and side effects

The serter contains small parts and may pose a choking hazard that can result in serious injury or death.

Side effects include discomfort and skin irritation at the insertion site.

Hazardous substances

None.

Allergens

None known.

Where to insert the sensor

Choose an insertion site with an adequate amount of subcutaneous fat.

For optimal sensor performance, and to prevent accidental sensor removal:

- Do not insert the sensor into muscle, tough skin, or scar tissue
- Avoid areas that are constrained by clothing or accessories
- Avoid areas subjected to vigorous movement during exercise

For a diagram of recommended sensor insertion areas, see the sensor user guide.

Inserting the sensor

For instructions on how to insert the sensor, see the sensor user guide.

Maintenance

Cleaning

Clean the serter after every use or whenever debris, blood, or other contaminants are visible.

To clean the serter:

Note: Press and release the mechanism on the underside of the serter to fully rinse the device.

1. Rinse the serter under running tap water.
2. Submerge the serter in a solution of mild soap and warm water.
3. Use a soft-bristled brush to clean the serter until it is free of visible dirt.
4. Rinse the serter under running tap water until all visible soap is gone. Make sure to fully rinse all hard-to-reach areas.
5. Shake off any excess water. Place the serter upright on a clean cloth to air dry.

Storage

Store the serter in the released position at room temperature.











Disposal

Dispose of the serter according to local regulations.

Technical specifications

Approximate Dimensions	Approximate Weight
3.09 x 2.72 x 2.27 inches (7.85 x 6.91 x 5.77 centimeters)	3.97 ounces (112.5 grams)

Icon table

	Consult instructions for use
	Caution
	Batch code
	Catalogue number
	One per container/package
	Storage humidity limit
	Storage temperature limit
	Manufacturer
	Date of manufacture
	Requires prescription in the USA

©2023 Medtronic. Medtronic, Medtronic logo, and Engineering the extraordinary are trademarks of Medtronic. All other brands are trademark of a Medtronic company.

Medtronic



Medtronic MiniMed
18000 Devonshire Street
Northridge, CA 91325
USA
1 800 646 4633
+1 818 576 5555
www.medtronicdiabetes.com

M025051C001_2

R_x Only

REF MMT-7512

2023-02-22

