



# Edwards

## Edwards EVOQUE Tricuspid Valve Replacement System

### Instructions for Use

## Rx only

**Caution: Implantation of the transcatheter tricuspid valve should only be performed by physicians who have received training for the Edwards EVOQUE tricuspid valve replacement system.**

- Do not attempt to use the Edwards EVOQUE valve (herein referred to as the EVOQUE valve), delivery system, or associated accessories before completely reading and understanding the information contained in this booklet.
- Failure to follow these instructions, warnings, and precautions may lead to device damage or patient injury. Use of the EVOQUE system should be restricted to those physicians trained to perform invasive endovascular procedures and to those physicians trained in the proper use of the system.
- Consult with authorized Edwards personnel for appropriate selection of EVOQUE valve size.
- The EVOQUE valve, delivery system, dilator kit, loading system, and stabilizer are supplied STERILE. The base and plate are supplied NON-STERILE.
- All devices are supplied for single use only. After use, dispose in accordance with hospital administrative and/or government policy. Do not re-sterilize.

### 1.0 Device Description

The Edwards EVOQUE tricuspid valve replacement system (herein referred to as the EVOQUE system) is designed to replace the native tricuspid valve in patients with tricuspid valve regurgitation without the need for conventional open-heart surgery. The EVOQUE system consists of four (4) elements and includes three (3) optional accessories, as outlined below:

Product Name	44 mm	48 mm	52 mm
Edwards EVOQUE Valve (EVOQUE Valve)	9850EV44	9850EV48	9850EV52
Edwards EVOQUE Tricuspid Delivery System	9850TDS		
Edwards EVOQUE Dilator Kit	9850DK		
Edwards EVOQUE Loading System	9850LS		

Optional Accessories	Model Number
Edwards EVOQUE Stabilizer	9850SB
Edwards EVOQUE Stabilizer Base	9850BA
Edwards EVOQUE Stabilizer Plate	9850PT

#### · Edwards EVOQUE Valve (Figure 1)

The EVOQUE valve consists of a trileaflet bovine pericardial tissue valve, nitinol frame, and fabric skirt, and is packaged and terminally sterilized in glutaraldehyde.

Valve size recommendations are based on native valve annulus size, as measured by computed tomography (CT). Patient anatomical factors and imaging modalities should be considered during valve size selection.

Device Diameter (Recommended Valve Size)	Systole		Diastole	
	Recommended Treatable Perimeter - Derived Diameter Range (mm)	Maximum Treatable Annulus Length (mm)	Recommended Treatable Perimeter - Derived Diameter Range (mm)	Maximum Treatable Annulus Length (mm)
44	36.5 - 43	45.5	39.6 - 45.5	50
48	40 - 47	49.5	43.2 - 49.5	54
52	45 - 51	53.5	46.8 - 53.5	58

• **Edwards EVOQUE Tricuspid Delivery System (Figure 2)**

The delivery system has an outer diameter of 28 F and is intended to deliver the EVOQUE valve in the crimped position via the transfemoral venous approach. The delivery system handle contains a primary flex knob, secondary flex knob, and depth knob to facilitate EVOQUE valve alignment and positioning in the native valve, and a capsule knob and release knob to control the expansion and release of the EVOQUE valve.

• **Edwards EVOQUE Dilator Kit (Figure 3)**

The 24 F, 28 F, and 33 F diameter hydrophilic-coated dilators are intended to dilate the access site, facilitating delivery system insertion. All dilators accommodate a 0.035 inch (0.89 mm) guidewire and are tapered to minimize access site trauma.

• **Edwards EVOQUE Loading System (Figure 4)**

The loading system, which consists of multiple components, is intended to facilitate loading and attachment of the EVOQUE valve onto the delivery system. The loading system assists in crimping the EVOQUE valve to the appropriate diameter, which allows the outer capsule to advance over the EVOQUE valve.

• **Edwards EVOQUE Optional Accessories: Stabilizer, Base, and Plate (Figure 5)**

The stabilizer, base, and plate are intended to secure the delivery system at an angle appropriate for the transfemoral venous approach and to enable fine adjustments of the position of the delivery system during the implantation procedure. The base is height-adjustable to accommodate patient lower extremities and is intended to provide a stable platform for the stabilizer. The plate is intended to provide a stable, flat surface for the base on the operating table.

## 2.0 Facilities and Training Requirement

Facilities that intend to perform an implantation procedure utilizing the EVOQUE system must have access to cine fluoroscopy and transesophageal echocardiography (TEE) throughout the procedure. In addition, the implanting physicians must have prompt access to facilities with the necessary equipment, instruments, supplies, and personnel to perform emergency tricuspid valve surgery, if required.

A comprehensive training program is provided by Edwards Lifesciences and must be completed by the implanting physicians before use of the EVOQUE system. The implanting physicians should have advanced technical knowledge and experience in related catheter-based procedures.

## 3.0 Indications for Use

### 3.1 Intended Use

The EVOQUE tricuspid valve replacement system is indicated for the improvement of health status in patients with symptomatic severe tricuspid regurgitation despite being treated optimally with medical therapy for whom tricuspid valve replacement is deemed appropriate by a Heart Team.

---

## 4.0 Contraindications

The EVOQUE valve is contraindicated in patients who cannot tolerate an anticoagulation/antiplatelet regimen, who have active bacterial endocarditis or other active infections, or who have untreatable hypersensitivity to nitinol alloys (nickel and titanium).

## 5.0 Warnings

- The EVOQUE valve, delivery system, loading system, dilator kit, and stabilizer are designed, intended, and distributed for STERILE single use only. The base and plate are provided nonsterile for single use only. Do not resterilize or reuse any of the devices. There are no data to support the sterility, nonpyrogenicity, or functionality of the devices after reprocessing.
- Ensure proper sterile techniques are utilized during the preparation, transfer, and use of the devices.
- Do not use the valve if the tamper evident seal is broken, the storage solution does not completely cover the valve, the temperature indicator has been activated, the valve is damaged, or the expiration date has elapsed. The EVOQUE valve must remain hydrated at all times. The valve cannot be exposed to solutions, antibiotics, or chemicals other than its shipping storage solution and sterile physiologic saline solution. This will help prevent leaflet damage that may impact valve functionality. Keep the EVOQUE valve hydrated with normal saline until ready for implantation.
- Ensure the correct valve size is selected. Implantation of the improper size (i.e., undersizing or oversizing) may lead to paravalvular leak (PVL), migration, embolization, and/or annular damage.
- Patients with previously-implanted devices (e.g., IVC filter) should be carefully assessed prior to insertion of the delivery system to avoid potential damage to vasculature or a previously-implanted device.
- Patients with pre-existing cardiac leads should be carefully assessed prior to implantation to avoid potential adverse interaction between devices.
- Care should be taken when implanting cardiac leads after EVOQUE valve implantation to avoid potential adverse interaction between the devices.
- Patients implanted with the EVOQUE valve should be maintained on anticoagulant/antiplatelet therapy as determined by their physicians in accordance with current guidelines, to minimize the risk of valve thrombosis or thromboembolic events.
- There are no data to support device safety or effectiveness if the patient has:
  - Echocardiographic evidence of severe right ventricular dysfunction;
  - Pulmonary arterial systolic pressure (PASP) > 70 mmHg by echo Doppler;
  - A trans-tricuspid pacemaker or defibrillator lead that has been implanted in the RV within the last 3 months;
  - Dependency on a trans-tricuspid pacemaker without alternative pacing options.

## 6.0 Precautions

### 6.1 Precautions Prior to Use

- The patient's eligibility depends on the anatomic conditions based on CT scan.
- It is advised that a multi-disciplinary heart team be of the opinion that EVOQUE valve implantation is preferable to alternative percutaneous device solutions, including minimally-invasive open heart surgery.
- It is advised that a multi-disciplinary heart team takes into consideration the severity of disease and the chances of reversibility of right heart failure based on a complete hemodynamic assessment.

### 6.2 Precautions

- The EVOQUE valve is to be used only with the 9850TDS delivery system and 9850LS loading system.
- The procedure should be conducted under appropriate imaging modalities, such as transesophageal echocardiography (TEE), fluoroscopy, and/or intracardiac echocardiography (ICE).
- Glutaraldehyde may cause irritation of the skin, eyes, nose, and throat. Avoid prolonged or repeated exposure to, or breathing of, the solution. Use only with adequate ventilation. If skin contact occurs, immediately flush the affected area with water; in the event of contact with eyes, seek immediate medical attention. For more information about glutaraldehyde exposure, refer to the Safety Data Sheet available from Edwards Lifesciences.
- Conduction disturbances may occur before, during, or following implantation of the EVOQUE valve, which may require continuous ECG monitoring before hospital discharge. If a patient has confirmed or suspected conduction

- 
- disturbances, consider patient monitoring and/or electrophysiology evaluation.
  - Appropriate antibiotic prophylaxis is recommended post-procedure in patients at risk for prosthetic valve infection and endocarditis.
  - Long-term durability has not been established for the EVOQUE valve. Regular medical follow-up is advised to evaluate EVOQUE valve performance.
  - Implantation of the EVOQUE valve should be postponed in patients with (1) a history of myocardial infarction within one month (30 days) of planned intervention, (2) pulmonary emboli within 3 months (90 days) of planned intervention, (3) cerebrovascular accident (stroke or TIA) within 3 months (90 days) of planned intervention, (4) active upper GI bleeding within 3 months (90 days) prior to procedure requiring transfusion.

## 7.0 Potential Adverse Events

Potential adverse events related to standard cardiac catheterization, use of anesthesia, the EVOQUE valve, and the implantation procedure include:

- Death
- Abnormal lab values
- Allergic reaction to anesthesia, contrast media, anti-coagulation medication, or device materials
- Anaphylactic shock
- Anemia or decreased hemoglobin (Hgb), may require transfusion
- Aneurysm or pseudoaneurysm
- Angina or chest pain
- Arrhythmia – atrial (i.e., atrial fibrillation, supraventricular tachycardia)
- Arrhythmias – ventricular (i.e., ventricular tachycardia, ventricular fibrillation)
- Arterio-venous fistula
- Bleeding
- Cardiac arrest
- Cardiac (heart) failure
- Cardiac injury, including perforation
- Cardiac tamponade / pericardial effusion
- Cardiogenic shock
- Chordal entanglement or rupture that may require intervention
- Coagulopathy, coagulation disorder, bleeding diathesis
- Conduction system injury, which may require implantation of a pacemaker (temporary or permanent)
- Conversion to open heart surgery
- Coronary artery occlusion
- Damage to or interference with function of pacemaker or implantable cardioverter defibrillator (ICD)
- Edema
- Electrolyte imbalance
- Embolization including air, particulate, calcific material, or thrombus
- Emergent cardiac surgery
- Endocarditis
- Esophageal irritation
- Esophageal perforation or stricture
- EVOQUE system component(s) embolization
- Failure to retrieve any EVOQUE system components
- Fever
- Gastrointestinal bleeding
- Hematoma
- Hemodynamic compromise
- Hemolysis / hemolytic anemia
- Hemorrhage requiring transfusion/surgery
- Hypertension

- 
- . Hypotension
  - . Inflammation
  - . Injury to the tricuspid apparatus including chordal damage, rupture, papillary muscle damage
  - . Local and systemic infection
  - . Mesenteric ischemia or bowel infarction
  - . Multi-system organ failure
  - . Myocardial infarction
  - . Nausea and/or vomiting
  - . Nerve injury
  - . Neurological symptoms, including dyskinesia, without diagnosis of TIA or stroke
  - . Non-emergent reoperation
  - . Pain
  - . Pannus formation
  - . Paralysis
  - . Percutaneous valve intervention
  - . Peripheral ischemia
  - . Permanent disability
  - . Pleural effusion
  - . Pneumonia
  - . Pulmonary edema
  - . Pulmonary embolism
  - . Reaction to anti-platelet or anticoagulation agents
  - . Rehospitalization
  - . Renal failure
  - . Respiratory failure, atelectasis – may require prolonged intubation
  - . Retroperitoneal bleed
  - . Right ventricular outflow tract (RVOT) obstruction
  - . Septicemia, sepsis
  - . Skin burn, injury, or tissue changes due to exposure to ionizing radiation
  - . Stroke
  - . Structural deterioration (wear, fracture, calcification, leaflet tear, leaflet thickening, stenosis of implanted device, or new leaflet motion disorder)
  - . Thromboembolism
  - . Transient ischemic attack (TIA)
  - . Valve dislodgement/embolization
  - . Valve endocarditis
  - . Valve explant
  - . Valve leaflet entrapment
  - . Valve malposition
  - . Valve migration
  - . Valve paravalvular leak (PVL)
  - . Valve regurgitation (new or worsening tricuspid, aortic, mitral, pulmonary)
  - . Valve thrombosis
  - . Vascular injury or trauma, including dissection or occlusion
  - . Vessel spasm
  - . Wound dehiscence, delayed or incomplete healing

## **8.0 Additional Equipment**

The implantation procedure requires additional equipment that is not supplied with the EVOQUE system. The additional equipment is provided below.

---

## 8.1 Equipment for EVOQUE Valve Loading

**Note: Volumes reflect adequate amount for preparing 1 implant.**

- 3500 ml (minimum) sterile physiological saline solution at ambient temperature (~ 23 °C)
- 500 ml (minimum) heparinized saline solution (2 units/ml) at ambient temperature (~ 23 °C)
- 4 sterile bowls (≥ 500 ml, ≥ 7 cm depth, plastic)
- 1 large sterile bowl (≥ 2 L, ≥ 10 cm depth, plastic)
- 1 scalpel, no. 11 scalpel blade
- 1 luer locking syringe (≥ 20 cc)
- Gauze pads
- Blunt tip forceps
- Blunt tip scissors
- Sterile towels

## 8.2 Equipment for Access, Procedure, and Monitoring

- Standard cardiac catheterization lab equipment
- Femoral vessel introducer sheath
- Fluoroscopy (fixed, mobile, or semi-mobile fluoroscopy systems appropriate for use in percutaneous coronary interventions)
- Transesophageal echocardiography capabilities
- Steerable introducer sheath
- Exchange length 0.035 inch (0.89 mm) max guidewire
- Extra small curve 0.035 inch (0.89 mm) max guidewire
- Right coronary arterial catheter and guidewire
- Sterile table for EVOQUE valve and device preparation

## 8.3 Standby Equipment

- Arterial bypass cannula (~18 F)
- Cardiopulmonary bypass machine
- Compliant balloon (> 20 mm diameter, 9 cc contrast volume)
- Diluted radiopaque contrast medium (15:85 medium to saline dilution)
- High pressure contrast injector
- Intra-aortic balloon pump and appropriately sized balloon
- Pigtail angiographic catheter
- Venous return bypass cannula (~18 F)
- Transthoracic echocardiographic (TTE) equipment
- Vascular access lubricant
- Temporary pacing equipment

## 9.0 Directions for Use

### 9.1 Prior to Use Inspection

Before using the EVOQUE system, visually examine each element and accessory for evidence of gross damage (e.g., a cracked jar or lid, leakage, broken or missing seals) that may have compromised the packaging sterility (if applicable) or functionality of the components.

**WARNING: Do not mishandle the delivery system or use the delivery system and accessory devices if the packaging and/or sterile barriers and any components have been opened or damaged, or the expiration date has elapsed, as sterility and/or function may be compromised.**

**WARNING: Do not mishandle the EVOQUE valve or use device/container if found to be damaged, leaking, or without adequate sterilant (not fully submerged in glutaraldehyde, or missing intact seals). The EVOQUE valve must not be used for implantation, as sterility may be compromised.**

**WARNING: Do not use the EVOQUE valve if the expiration date has elapsed, as either sterility or valve function may be compromised.**

**WARNING: Do not use the EVOQUE valve if the temperature indicator has been activated, as valve function may**

be compromised.

**WARNING: Do not use the EVOQUE valve if the tamper evident seal is broken, as sterility may be compromised.**

## 9.2 Base & Plate Set Up

If desired, the plate is placed on the operating table beneath the patient's leg to support the base during the procedure.

After the patient has been positioned on the operating table, the base is placed over the patient's leg, on top of the plate, at the desired distance from the mid-sternum.

Establish sterile barrier.

The base adapter is then placed in-line with the access site and attached to the front of the base using a clamp. The base adapter and clamp are both supplied with the stabilizer.

## 9.3 Device Preparation

All device preparations will be performed by authorized Edwards personnel.

**WARNING: Do not mishandle the EVOQUE valve. EVOQUE valve leaflets mishandled or damaged during any part of the loading process will require replacement of the EVOQUE valve.**

**WARNING: The EVOQUE valve should not remain fully crimped for a period of time longer than 120 minutes, as it may impair valve functionality.**

**CAUTION: Do not place the jar or the pouch of the delivery system into the sterile field. The outside of the jar and the pouch are not sterile, and the contents within the jar and pouch should be handled using standard aseptic techniques to prevent contamination.**

**CAUTION: To reduce the risk of contamination, do not open the EVOQUE valve jar until implantation is certain.**

**CAUTION: Ensure that the entire suture is removed when removing the serial number tag from the EVOQUE valve, as it may lead to emboli.**

**CAUTION: Do not allow the EVOQUE valve to come in contact with any sharp instrument, as it may impair valve function.**

**WARNING: Adequate rinsing with normal saline must be performed before implantation to reduce glutaraldehyde concentration, as it may result in glutaraldehyde toxicity.**

**CAUTION: Avoid contact of the leaflet tissue or the rinse solution with towels, linens, or other sources of lint or particulate matter that could be transferred to the leaflet tissue, as it may lead to emboli.**

## 9.4 EVOQUE Valve Implant

### 9.4.1 Guidewire Placement

Prepare femoral venous access using standard interventional techniques.

**WARNING: Do not use excessive force and/or manipulation during advancement and positioning of the guidewire, as it may result in perforation/dissection of arteries, veins, and/or other cardiac structures. This may also result in cardiac arrhythmias and conduction disturbances.**

Step	Procedure
1	Advance steerable sheath into the right atrium at the exit of the IVC.
2	Insert a guidewire through the steerable sheath.
3	Advance the guidewire across the tricuspid valve. <b>Note: Other interventional devices and techniques (e.g., guide catheters) may be used to assist the guidewire in crossing the tricuspid valve.</b>
4	Establish proper guidewire path and confirm no entanglement with cardiac structures.

### 9.4.2 EVOQUE Valve Delivery

**WARNING: Avoid excessive movement of the delivery system while executing the procedure in order to protect vasculature or cardiac structures. Avoid excessive rotation of the delivery system to maintain functionality of the delivery system.**

**Note: Flush the delivery system with heparinized saline as needed throughout the procedure.**

Step	Procedure
------	-----------



1	Ensure the hydrophilic coating on dilators and delivery system is activated prior to use. Dilate access site. An Edwards EVOQUE dilator should be used as needed.
2	Insert the delivery system over the guidewire.
3	Advance the delivery system until the distal end of the tapered tip is positioned at the junction between IVC and right atrium.
4	Using fluoroscopy, ensure the delivery system is oriented in the proper orientation. <b>WARNING: The primary flex on the delivery system flexes in the direction of the flush ports; care should be taken to ensure that the delivery system is orientated correctly at this point.</b>
5	Retract the sheath.
6	Flex and orient the delivery system towards the tricuspid valve.
7	Advance the delivery system to cross the tricuspid valve. <b>Note: Delivery system flex, delivery system rotation, and guidewire position may be adjusted during valve crossing to optimize crossing position.</b>
8	Using echocardiography and fluoroscopic guidance, verify that the delivery system has crossed through the tricuspid valve into the right ventricle.
9	Dock the stabilizer onto the base adapter and secure it to the base, if applicable.
10	Attach the delivery system and sheath to the stabilizer, if applicable.
11	Adjust the delivery system as needed to ensure hemodynamic stability.
12	Using pre-operative CT data (if available), position the C-arm at the optimal viewing projection.
13	Position the delivery system to be coaxial to the tricuspid annulus while minimizing contact with the native anatomy.
14	Using echocardiography and fluoroscopic guidance, confirm that the EVOQUE valve is positioned at the appropriate depth and coaxiality with relation to the native valve. <b>CAUTION: Once the capsule is retracted to expose the EVOQUE valve anchors, the valve is unable to be retrieved or recaptured into the delivery system.</b> <b>WARNING: Maintain central position of the delivery system within the native valve during deployment to ensure proper positioning of the valve.</b>
15	Retract the outer capsule until the anchors are exposed.
16	Adjust the position of the EVOQUE valve so that the anchors are positioned within native leaflets as dictated by patient anatomy.
17	Retract the outer capsule until the desired EVOQUE valve diameter is achieved.
18	Capture the leaflets.
19	Confirm positioning of the EVOQUE valve by using echo imaging to assess engagement of the leaflets. Adjust the EVOQUE valve positioning as needed.
20	Using echo imaging, observe the motion of the native leaflets and adjust the position of the EVOQUE valve as required to fully engage native tricuspid valve leaflets.
21	Once full engagement has been confirmed, ensure that the EVOQUE valve is perpendicular to the tricuspid annular plane.
22	Retract the tapered tip until it is positioned within the EVOQUE valve.
23	Rotate the release knob to withdraw the inner capsule until the EVOQUE valve is released from the delivery system. <b>CAUTION: Care should be taken during final release of the EVOQUE valve using the release knob, as premature release may impact performance of the EVOQUE valve.</b>
24	Using echo and fluoroscopic imaging, assess final position and functionality of the EVOQUE valve.

#### 9.4.3 Delivery System Removal

**WARNING: Take care to maintain position of delivery system central within the EVOQUE valve during delivery**



system removal, as failure to do so may impact valve functionality or lead to dislodgement of the valve.

**Note:** Delivery system can be removed from the stabilizer at any point during removal if applicable.

Step	Procedure
1	Fully retract the tapered tip.
2	Unflex and retract delivery system as needed until the tapered tip is above the locking tabs of the EVOQUE valve. Adjust the guidewire as needed to maintain a central position relative to the EVOQUE valve.  Ensure that the locking ring is free from the EVOQUE valve.
3	Rotate the release knob so that the inner capsule is in contact with the tapered tip.
4	Unflex and retract the delivery system as needed.
5	Rotate the capsule retraction knob until the outer capsule is in contact with the inner capsule.
6	Ensure the delivery system is fully unflexed and remove the delivery system from the access site.  <b>Note: A sheath may be used to seal the femoral vein following system removal.</b>
7	Perform femoral closure as applicable using standard interventional techniques.
8	Perform a ventriculogram if needed to assess final position of the EVOQUE valve.

---

## 10.0 How Supplied

### 10.1 Sterilization and Packaging

The EVOQUE valve is provided sterile by terminal liquid sterilization and is non-pyrogenic. It is packaged and sterilized in a glutaraldehyde solution inside a jar to which a seal has been applied. The outer surface of the jar is not sterile and must not be placed in the sterile field. The EVOQUE valve is supplied with a temperature indicator and should not be used if the indicator has been activated.

The delivery system, dilator kit, and loading system are supplied sterilized by ethylene oxide and provided non-pyrogenic. The components are secured on a card and packaged in a pouch and shelf box.

The stabilizer is provided ethylene oxide sterilized. The components are secured on a card and packaged in a pouch and shelf box.

The base and plate are provided non-sterile. The components are packaged in individual shipper boxes.

### 10.2 Storage

The EVOQUE valve should be stored between 10 °C and 25 °C (50 °F and 77 °F). Stock inspection and rotation at regular intervals are recommended so that the EVOQUE valve with an earlier expiration date is used first.

The delivery system, dilator kit, loading system, stabilizer, base, and plate should be stored in a cool, dry place that is contamination free.

## 11.0 Magnetic Resonance (MR) Safety Information



Non-clinical testing has demonstrated that the Edwards EVOQUE valve is MR Conditional. A patient with the valve can be safely scanned in an MR system meeting the following conditions:

- Static magnetic field of 1.5 and 3 T only
- Maximum spatial gradient magnetic field of 3000 gauss/cm (30.0 T/m) or less
- Maximum MR system-reported, whole body averaged specific absorption rate (SAR) of 2.0 W/kg
- Normal operating mode of the MR system for both gradients and SAR

Under the scan conditions defined above, the EVOQUE valve is expected to produce a maximum temperature rise of 4 °C after 15 minutes of continuous scanning.

In non-clinical testing, the image artifact caused by the EVOQUE valve extends approximately 0.8 cm from the device when imaged with a gradient echo or spin echo pulse sequence and a 3 T MRI system.

## 12.0 Patient Information

Patient education brochures are provided to each site and should be given to the patient to inform them of the risks and benefits of the procedure and alternatives in adequate time before the procedure to be read and discussed with their physician. A copy of this brochure may also be obtained from Edwards Lifesciences by calling 1.888.713.1564.

A patient implant card request form is provided with each transcatheter heart valve. After implantation, all requested information should be completed on this form. The serial number may be found on the package and on the identification tag attached to the transcatheter heart valve. The original form should be returned to the Edwards Lifesciences address indicated on the form and upon receipt, Edwards Lifesciences will provide an identification card to the patient.

## 13.0 Recovered Implant and Device Disposal

Edwards Lifesciences is interested in obtaining recovered clinical specimens of the EVOQUE valve for analysis. A written report summarizing our findings will be provided upon completion of our evaluation. Please contact Edwards for return of the recovered valve.

If you do decide to return any of the devices, please follow the following instructions:

- **Unopened Package with Sterile Barrier Intact:**

---

If the pouches have not been opened, return the device in its original packaging.

• **Package Opened but Not Implanted:**

If a pouch is opened, the device is no longer sterile. Please return the device in its original packaging.

• **Explanted Implant:**

The explanted implant should be placed into a suitable histological fixative such as 10% formalin or 2% glutaraldehyde. Refrigeration is not necessary under these circumstances. Contact Edwards Lifesciences to request an Explant Kit for return to Edwards.

### 13.1 Disposal

Use universal precautions for biohazards and sharps to avoid user injury. Used devices (includes all devices that come in contact with patients) should be handled and disposed of in accordance with institutional guidelines on biohazardous materials and hospital waste to avoid possible cross- contamination.

## 14.0 Clinical Data

The EVOQUE system was studied in a clinical trial entitled “TRISCEND II trial”.

### A. Study Design

The main cohort of the TRISCEND II trial was a prospective, multicenter, randomized study. Eligible patients were randomized 2:1 into two groups: EVOQUE system plus OMT vs OMT alone. The trial was designed to have two primary analysis phases: health status evaluation of 150 patients at 6 months (“Breakthrough Pathway Cohort”) and an assessment of morbidity/mortality on the full 400 enrolled patients at 1 year (“Full Cohort”). In addition to the Randomized Cohort, the trial also included a Single-Arm Cohort for patients deemed ineligible for randomization.

The TRISCEND II trial employed a Central Screening Committee (CSC) that ensured patient appropriateness for enrollment, an independent Data Safety Monitoring Board (DSMB) that was instructed to notify the applicant of any safety or compliance issues, a Clinical Events Committee (CEC) that was responsible for adjudicating endpoint related events reported during the trial, and an echocardiographic core laboratory for independently analyzing all echocardiograms.

#### I. Clinical Inclusion and Exclusion Criteria

Enrollment in the TRISCEND II trial was limited to patients who met the following inclusion criteria:

- Age  $\geq 18$  years old.
- Despite OMT per the local heart team, patient has signs of TR, symptoms from TR, or prior heart failure (HF) hospitalization from TR. Patient must be on OMT per the local heart team at the time of TR assessment (transthoracic echocardiogram; TTE) for trial eligibility. OMT includes stable oral diuretic medications, unless patient has a documented history of intolerance.
- Functional and/or degenerative TR graded as at least severe on a TTE (assessed by the ECL using a 5-grade classification proposed by Hahn et al. [2017]).
- The local heart team determines that the patient is appropriate for transcatheter tricuspid valve replacement.
- Patient is willing and able to comply with all study evaluations and provides written informed consent.

Patients were not permitted to be enrolled in the TRISCEND II trial if they met any of the following exclusion criteria:

- Anatomy precluding proper device delivery, deployment, and/or function.
- Left ventricular ejection fraction (LVEF)  $< 25\%$ .
- Evidence of severe right ventricular dysfunction.
- Any of the following pulmonary pressure parameters:
  - Pulmonary arterial systolic pressure (PASP)  $>60$  mmHg by Doppler echocardiogram (unless right heart catheterization [RHC] demonstrates PASP  $\leq 70$  mmHg)
  - PASP  $>70$  mmHg by RHC
  - Pulmonary Vascular Resistance (PVR)  $>5$  Wood units by RHC (unless PVR  $\leq 5$  Wood units and systolic blood pressure  $>85$  mmHg after vasodilator challenge)
- Previous tricuspid surgery or intervention.
- Presence of trans-tricuspid pacemaker or defibrillator lead with any of the following:
  - Implanted in the right ventricle within the last 90 days
  - Patient is pacemaker dependent on trans-tricuspid lead without alternative pacing option
  - Has delivered appropriate implantable cardioverter defibrillator (ICD) therapy

- 
- Severe aortic, mitral, and/or pulmonic valve stenosis and/or regurgitation.
  - Active endocarditis within the last 90 days or infection requiring antibiotic therapy (oral or intravenous) within the last 14 days.
  - Hemodynamically significant pericardial effusion.
  - Significant intra-cardiac mass, thrombus, or vegetation.
  - Clinically significant, untreated coronary artery disease requiring revascularization, evidence of acute coronary syndrome, recent myocardial infarction within the last 30 days.
  - Any of the following cardiovascular procedures:
    - Percutaneous coronary, intracardiac or endovascular intervention within the last 30 days
    - Carotid surgery within the last 30 days
    - Direct current cardioversion within the last 30 days
    - Leadless right ventricular pacemaker implant within the last 30 days
    - Cardiac surgery within the last 90 days
  - Known history of untreated severe symptomatic carotid stenosis (>50% by ultrasound) or asymptomatic carotid stenosis (>70% by ultrasound).
  - Need for emergent or urgent surgery for any reason, any planned cardiac surgery within the next 12 months (365 days), or any planned percutaneous cardiac procedure within the next 90 days.
  - Hypotension (systolic pressure <90 mmHg) or requirement for inotropic support or hemodynamic support within the last 30 days.
  - Patient with refractory HF that requires or required advanced intervention (i.e., left ventricular assist device or transplantation) (American College of Cardiology/American Heart Association/ European Society of Cardiology/ European Association for Cardio-Thoracic Surgery Stage D HF).
  - Deep vein thrombosis or pulmonary embolism in the last 6 months (180 days)
  - Stroke within the last 90 days.
  - Modified Rankin Scale  $\geq 4$  disability.
  - Severe renal insufficiency with estimated glomerular filtration rate (eGFR)  $\leq 25$  mL/min/1.73m<sup>2</sup>, calculated using the Modification of Diet in Renal Disease (MDRD) equation, or requiring chronic renal replacement therapy.
  - Patients with hepatic insufficiency, or cirrhosis with Child-Pugh score class C.
  - Patient is oxygen-dependent or requires continuous home oxygen.
  - Chronic anemia with transfusion dependency or Hgb <9 g/dL not corrected by transfusion.
  - Unable to walk at least 100 meters in a 6-minute walk test (6MWT).
  - Thrombocytopenia (platelet count <75,000/mm<sup>3</sup>) or thrombocytosis (platelet count >750,000/mm<sup>3</sup>).
  - Known bleeding or clotting disorders or patient refuses blood transfusion.
  - Active gastrointestinal bleeding within the last 90 days.
  - Pregnant, breastfeeding, or planning pregnancy within the next 12 months (365 days).
  - Patients in whom (any of the following):
    - transesophageal echocardiography (TEE) is contraindicated or cannot be completed.
    - tricuspid valve anatomy is not evaluable by TTE or TEE
  - In the opinion of the investigator, access to and through the femoral vein/inferior vena cava with a guide sheath and delivery catheter is deemed not feasible (e.g., occluded femoral veins, occluded or thrombosed inferior vena cava filter).
  - Untreatable hypersensitivity or contraindication to any of the following: all antiplatelets, all anticoagulants, nitinol alloys (nickel and titanium), bovine tissue, glutaraldehyde, or contrast media.
  - Currently participating in another investigational biologic, drug or device study
  - Co-morbid condition(s) that, in the opinion of the investigator, limit life expectancy to <12 months (365 days).
  - Presence of infiltrative cardiomyopathy or valvulopathy, including carcinoid, amyloidosis, sarcoidosis, hemochromatosis, or significant uncorrected congenital heart disease, including but not limited to hemodynamically significant atrial septal defect, right ventricular dysplasia, and arrhythmogenic right ventricle.
  - Any condition, in the opinion of the investigator, making it unlikely the patient will be able to complete all protocol procedures and follow-ups.
  - Other medical, social, or psychological conditions that preclude appropriate consent and follow-up, including patients under guardianship.
  - Any patient considered to be vulnerable.

---

## 2. Follow-up Schedule

The follow-up time points included day of implantation, discharge, 30 days, 3 months (select health status questionnaires only) 6 months, 1 year, and annually thereafter to 5 years post procedure. Preoperative and post-operative assessments included physical assessments and medical history, laboratory measurements, imaging tests, and health surveys. Adverse events and complications were recorded at all visits.

## 3. Clinical Endpoints

### *Primary Safety Endpoint – Breakthrough Pathway Cohort*

The primary safety endpoint for the Breakthrough Pathway Cohort was a composite of major adverse events (MAEs) at 30 days consisting of the following components:

- Cardiovascular mortality
- Myocardial infarction
- Stroke
- New need for renal replacement therapy
- Severe bleeding (fatal, life-threatening, extensive, or major bleeding, as defined in the Mitral Valve Academic Research Consortium (MVARC) consensus document)
- Non-elective tricuspid valve re-intervention, percutaneous or surgical
- Major access site and vascular complications
- Major cardiac structural complications due to access-related issues
- Device-related pulmonary embolism
- Arrhythmia and conduction disorder requiring permanent pacing

The hypothesis for the primary safety endpoint was as follows:

$$H_0: P(\text{MAE}) \geq 70\%$$

$$H_1: P(\text{MAE}) < 70\%$$

where  $P(\text{MAE})$  was the proportion of patients with an MAE at 30 days and 70% was a performance goal derived from reported safety outcomes after isolated tricuspid valve replacement surgery. The null hypothesis would be rejected if the one-sided 97.5% confidence interval was less than 70%.

### *Primary Effectiveness Endpoint – Breakthrough Pathway Cohort*

There were two co-primary effectiveness endpoints for the Breakthrough Pathway Cohort, as listed below:

- Co-primary effectiveness endpoint #1: TR grade reduction to moderate or less at 6 months
- Co-primary effectiveness endpoint #2: A hierarchical composite endpoint at 6 months of the following components:
  - Health status improvement assessed by KCCQ overall summary score (KCCQ score, hereafter) of  $\geq 10$  points
  - New York Heart Association (NYHA) functional class improvement of  $\geq 1$  class
  - 6-minute walk distance (6MWD) improvement of  $\geq 30$  meters

The hypothesis for co-primary effectiveness endpoint #1 was as follows:

$$H_0: P_D(\text{TR}) - P_C(\text{TR}) \leq 0$$

$$H_1: P_D(\text{TR}) - P_C(\text{TR}) > 0$$

where  $P_D(\text{TR})$  and  $P_C(\text{TR})$  were the proportions of patients with TR grade reduction to moderate or less at 6 months in the device and control groups, respectively. The alternative hypothesis that  $P_D(\text{TR})$  was superior to  $P_C(\text{TR})$  was tested at a one-sided significance level of 0.025.

---

The hypothesis for co-primary effectiveness endpoint #2 was as follows:

H0: None of the components is improved by the device

H1: At least one component is improved by the device

The alternative hypothesis that the device group was superior to the control group in at least one component of co-primary effectiveness endpoint #2 was tested using the Finkelstein-Schoenfeld method at a one-sided significance level of 0.025. As a supplementary analysis, the unmatched win-ratio approach was also used to evaluate the composite endpoint. In the analysis, each pair of patients from the device group and the control group were compared in the order of the defined hierarchy; and the win ratio was defined as the number of winners divided by the number of losers in the device group.

#### *Primary Safety and Effectiveness Endpoint – Full Cohort*

The primary safety and effectiveness endpoint for the Full Cohort was a hierarchical composite at 1 year of the following components:

- All-cause mortality
- Right ventricular assist device (RVAD) implantation or heart transplant
- Tricuspid valve surgical or percutaneous intervention
- Annualized rate of heart failure hospitalizations
- KCCQ score improvement of  $\geq 10$  points
- NYHA functional class improvement of  $\geq 1$  class
- 6MWD improvement of  $\geq 30$  meters

#### *Additional Outcomes – Breakthrough Pathway Cohort*

Additional outcomes assessed for the Breakthrough Pathway Cohort included the following:

- Echocardiographic parameters by echocardiogram core laboratory assessment
- Clinical and functional parameters

It was determined that a sample size of 150 patients (100 in the device group and 50 in the control group) would provide adequate power to test the hypotheses for the primary safety and effectiveness endpoints of the Breakthrough Pathway Cohort. Study success of the Breakthrough Pathway Cohort was defined as meeting the primary safety endpoint and meeting both the co-primary effectiveness endpoints. It was also prespecified that at the time of the initial PMA application based on the Breakthrough Pathway Cohort data, the primary endpoint for the Full Cohort and its individual components would be examined descriptively for trending based on available data.

## B. Accountability of the PMA Cohort

The enrollment in the Breakthrough Pathway Cohort of the TRISCEND II trial took place between May 2021 and April 2022. A total of 153 patients were randomized at 30 investigational sites in the U.S. and Germany.

The dispositions of patients in the Breakthrough Pathway Cohort are detailed in Figure 6.

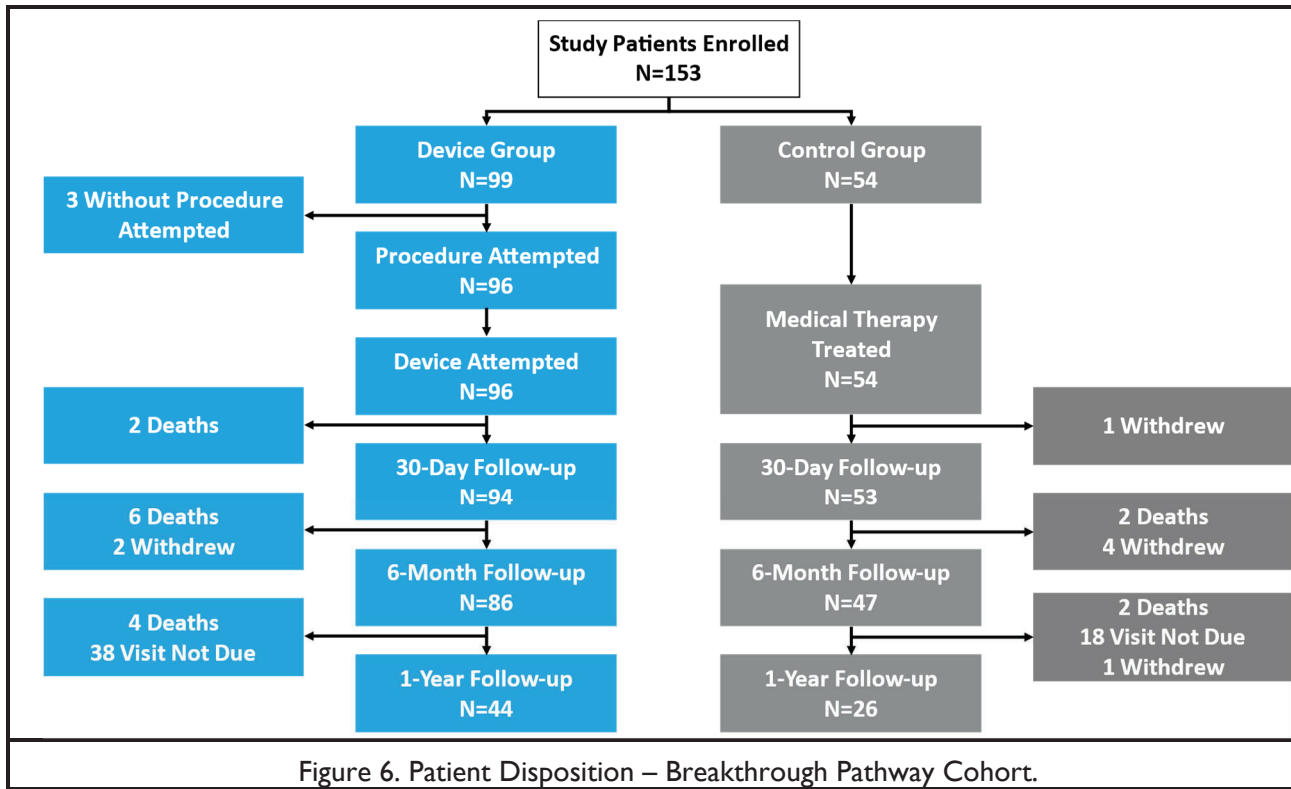

The analysis populations for the Breakthrough Pathway Cohort are defined in Table I. The primary safety and effectiveness analyses were performed on the mITT Safety and mITT Effectiveness Populations, respectively.

**Table I. Analysis Populations - Breakthrough Pathway Cohort.**

Analysis Population	Definition	Number of Patients	
		Device Group	Control Group
Intent-to-Treat (ITT)	All patients randomized to each treatment group.	99	54
Modified ITT (mITT) Safety	All ITT patients who had the study procedure attempted (initiation of skin incision to access the femoral vein) in the device group or who were randomized to the control group.	96	54
mITT Effectiveness	All patients in the mITT Safety Population who had a study device attempted (insertion of guide sheath into femoral vein) in the device group or who were randomized to the control group.	96	54
As-Treated (AT)	All patients in the mITT Effectiveness Population who had a study device implanted at exit from procedure room in the device group or who were randomized to the control group and treated with medical therapy.	92*	54

\*Four (4) patients had aborted procedures due to challenging anatomy or imaging.



At the time of database lock, of the randomized patients eligible for the 6-month visit, 96.5% in the device group and 95.7% in the control group completed the visit, as shown in Table 2.

Visit Status	30 Days		6 Months	
	Device Group (N=96)	Control Group (N=54)	Device Group (N=96)	Control Group (N=54)
Ineligible for visit	2	1	10	7
Eligible for visit*	94	53	86	47
Follow-up visit completed†	95.7% (90/94)	90.6% (48/53)	96.5% (83/86)	95.7% (45/47)

\*Patients were considered eligible if they completed the visit, or their visit windows were open, they were alive, and had not exited the study prior to the window opening.

†Categorical variables: % (no./total no.)

### C. Study Population Demographics and Baseline Characteristics

The demographics and baseline characteristics of the study population in the Breakthrough Pathway Cohort are summarized in Table 3, which are typical for a TR study performed in the U.S. A majority of the study patients were female. Overall, the two treatment groups were well-balanced except that there were more patients in the device group than in the control group that were in NYHA functional class III/IV (79.2% vs. 70.4%) or had a prior stroke (19.8% vs. 5.6%) and there were fewer patients in the device group than in the control group that had myocardial infarction (5.2% vs. 14.8%) or had ≥1 prior open-heart surgeries (31.2% vs. 42.6%).

Demographics and Baseline Characteristics	Summary Statistics* (N=150)	
	Device Group (N=96)	Control Group (N=54)
Age (years)	79.4 ± 7.71 (96)	78.2 ± 8.32 (54)
Female	82.3% (79/96)	75.9% (41/54)
Race		
American Indian or Alaskan Native	1.0% (1/96)	0.0% (0/54)
Asian	7.3% (7/96)	9.3% (5/54)
Black or African American	6.3% (6/96)	1.9% (1/54)
White	65.6% (63/96)	68.5% (37/54)
Not available	11.5% (11/96)	11.1% (6/54)
Other	8.3% (8/96)	9.3% (5/54)
Body mass index (BMI, kg/m <sup>2</sup> )	26.4 ± 5.93 (96)	26.6 ± 5.68 (54)
New York Heart Association (NYHA) functional class		
Class I	1.0% (1/96)	0.0% (0/54)
Class II	19.8% (19/96)	29.6% (16/54)
Class III	75.0% (72/96)	68.5% (37/54)
Class IV	4.2% (4/96)	1.9% (1/54)

**Table 3. Patient Demographics and Baseline Characteristics - mITT (Safety) Population**

Demographics and Baseline Characteristics	Summary Statistics* (N=150)	
	Device Group (N=96)	Control Group (N=54)
Left ventricular ejection fraction (LVEF, %)	55.1 ± 8.60 (96)	52.4 ± 11.57 (54)
Society of Thoracic Surgeons (STS) Mortality Score - mitral valve replacement (%)	10.2 ± 5.66 (96)	9.4 ± 4.49 (54)
STS Mortality Score - mitral valve repair (%)	7.0 ± 4.58 (96)	6.7 ± 4.17 (54)
European System for Cardiac Operative Risk Evaluation (EuroSCORE) II (%)	5.3 ± 3.28 (96)	5.4 ± 3.33 (54)
Katz Activities of Daily Living Score	5.8 ± 0.44 (96)	5.9 ± 0.39 (54)
Canadian Study of Health and Aging (CSHA) Clinical Frailty Score		
Non-frail to mildly frail (1-5)	85.3% (81/95)	90.7% (49/54)
Moderate-to-severely frail (6-9)	14.7% (14/95)	9.3% (5/54)
Cardiomyopathy	13.5% (13/96)	16.7% (9/54)
Dilated	9.4% (9/96)	16.7% (9/54)
Restrictive	1% (1/96)	0% (0/54)
Hypertrophic	2.1% (2/96)	0% (0/54)
Coronary artery disease (≥50% stenosis)	26.0% (25/96)	29.6% (16/54)
Hypertension	91.7% (88/96)	87.0% (47/54)
Pulmonary Hypertension	70.8% (68/96)	74.1% (40/54)
Myocardial infarction	5.2% (5/96)	14.8% (8/54)
Stroke	19.8% (19/96)	5.6% (3/54)
Atrial fibrillation	97.9% (94/96)	96.3% (52/54)
Pacemaker/implantable cardioverter defibrillator	36.5% (35/96)	42.6% (23/54)
Percutaneous coronary intervention (PCI)/stent	12.5% (12/96)	11.1% (6/54)
Total number of prior open-heart surgeries (valve or coronary artery bypass grafting)		
0	65.6% (63/96)	57.4% (31/54)
1	22.9% (22/96)	38.9% (21/54)
≥2	8.3% (8/96)	3.7% (2/54)
Number of hospitalizations for heart failure in the last 12 months prior to consent	1.7 ± 0.96 (30)	1.7 ± 0.92 (17)
Total number of days hospitalized for heart failure in the last 12 months (for those who had heart failure hospitalization)	9.3 ± 7.48 (28)	11.8 ± 9.31 (17)
Diabetes	19.8% (19/96)	27.8% (15/54)
Chronic obstructive pulmonary disease (COPD)	19.8% (19/96)	16.7% (9/54)
Renal insufficiency or failure	48/96 (50.0%)	57.4% (31/54)
Stage I (eGFR ≥90)	0.0% (0/96)	0.0% (0/54)
Stage II (eGFR 60-89)	7.3% (7/96)	5.6% (3/54)
Stage III (eGFR 30-59)	38.5% (37/96)	44.4% (24/54)
Stage IV (eGFR 15-29)	4.2% (4/96)	7.4% (4/54)
Stage V (eGFR <15)	0.0% (0/96)	0.0% (0/54)

**Table 3. Patient Demographics and Baseline Characteristics - mITT (Safety) Population**

Demographics and Baseline Characteristics	Summary Statistics* (N=150)	
	Device Group (N=96)	Control Group (N=54)
History of renal replacement therapy (e.g., dialysis)	0.0% (0/96)	1.9% (1/54)
Baseline KCCQ Overall Score	49.1 ± 21.47 (95)	49.7 ± 22.30 (54)
Baseline 6MWD (meter)	232.2 ± 89.61 (96)	244.0 ± 91.02 (54)
TR severity greater than severe†		
Severe	43.8% (42/96)	40.7% (22/54)
Massive	21.9% (21/96)	27.8% (15/54)
Torrential	34.4% (33/96)	31.5% (17/54)
Pulmonary arterial systolic pressure (PASP; mmHg)	37.5 ± 9.57 (93)	38.0 ± 11.53 (54)
TAPSE (mm)	15.9 ± 4.25 (80)	16.0 ± 4.00 (45)

eGFR: estimated glomerular filtration rate; KCCQ: Kansas City Cardiomyopathy Questionnaire; 6MWD: 6-minute walk distance; TR: tricuspid regurgitation; TAPSE: tricuspid annular plane systolic excursion.

\*Categorical variables: % (no./total no.); continuous variables: mean ± standard deviation (no.)

†TR severity was evaluated on the 5-grade scale by Hahn et al. (2017).

#### D. Safety and Effectiveness Results

This section summarizes the results of the Breakthrough Pathway Cohort, unless otherwise noted.

##### Primary Safety Endpoint

The primary safety endpoint results are presented in Table 4. The proportion of patients with MAEs at 30 days was 27.4% in the device group, with a one-sided 97.5% upper confidence bound of 36.9%, which was less than the pre-specified performance goal of 70%. Thus, the primary safety endpoint was met.

**Table 4. MAEs at 30 Days – Breakthrough Pathway Cohort mITT (Safety) Population.**

Endpoint	No. Events	Event Rate*	One-sided 97.5% Upper Confidence Bound†	Endpoint Result
Composite MAEs	36	27.4% (26/95)	36.9% < 70%	Endpoint met
Cardiovascular mortality	3	3.2% (3/95)	-	-
Myocardial infarction	1	1.1% (1/95)	-	-
Stroke	0	0.0% (0/95)	-	-
New need for renal replacement therapy	1	1.1% (1/95)	-	-
Severe bleeding‡	10	10.5% (10/95)	-	-
Non-elective tricuspid valve re-intervention, percutaneous or surgical	0	0.0% (0/95)	-	-
Major access site and vascular complications	3	3.2% (3/95)	-	-
Major cardiac structural complications due to access-related issues	2	2.1% (2/95)	-	-

Device-related pulmonary embolism	1	1.1% (1/95)	-	-
Arrhythmia and conduction disorder requiring permanent pacing	14	14.7% (14/95)	-	-

MAEs: major adverse events

\*% (no./total no.). Denominator included patients who had been in the trial for  $\geq 30$  days or had an MAE prior to 30 days. One patient had an aborted procedure and withdrew from the trial on post operative day (POD) 22 without experiencing an MAE and thus was not included in the denominator.

†Based on the normal approximation method with continuity correction for the proportion of patients with the MAEs and compared to the pre-specified performance goal of 70%.

‡Fatal, life-threatening, extensive, or major bleeding, as defined by Mitral Valve Academic Research Consortium (MVARC; Stone et al. 2015).

### Primary Effectiveness Endpoints

#### Co-primary Effectiveness Endpoint #1:

The primary analysis result of co-primary effectiveness endpoint #1 is shown in Table 5. The proportions of patients with TR reduction to moderate or less at 6 months were 98.8% (80/81) in the device group and 21.6% (8/37) in the control group, a difference of 77.1% between the two groups, with one-sided p-value of  $<0.001$ , which was less than the pre-specified one-sided significance level of 0.025. Thus, co-primary effectiveness endpoint #1 was met, indicating superiority of the device group to the control group.

	Summary Statistics*		Difference	p-Value†	Endpoint Result
	Device Group (N=96)	Control Group (N=54)			
TR grade reduction to moderate or less at 6 months	98.8% (80/81)	21.6% (8/37)	77.1%	$<0.001$	Endpoint met

\*% (no./total no.). The total number of patients included patients with available data only. Fifteen (15) device patients did not have a 6-month TR grade available: 3 had aborted procedures; 8 died prior to the visit; and 4 missed the visit or did not have transthoracic cardiogram (TTE) collected. Seventeen (17) control patients did not have a 6-month TR grade available: 2 died; 1 missed the visit; 4 were pending records from outside hospitals; 4 had TTE with unmeasurable TR grade; and 6 withdrew consent prior to the visit.

†Pooled Z-test with continuity correction. Compared with one-sided significance level of 0.025.

#### Co-primary Endpoint #2:

The primary analysis result of co-primary effectiveness endpoint #2 is shown in Table 6. The Finkelstein-Schoenfeld test statistic result was 5.299 with a one-sided p-value of  $<0.001$ , which is less than the pre-specified one-sided significance level of 0.025. Thus, co-primary effectiveness endpoint #2 was met indicating the device group was superior to the control group.

Primary Endpoint	Test Statistic	p-Value*	Result
Finkelstein-Schoenfeld analysis	5.299	$<0.001$	Endpoint met

\*One-sided p-value calculated using the Finkelstein-Schoenfeld method. Compared with one-sided significance level of 0.025.

The supplementary win ratio analysis of co-primary effectiveness endpoint #2 is shown in Figure 7. The win ratio of the device group vs. the control group was 4.6 (95% confidence interval: [2.6, 8.0]).

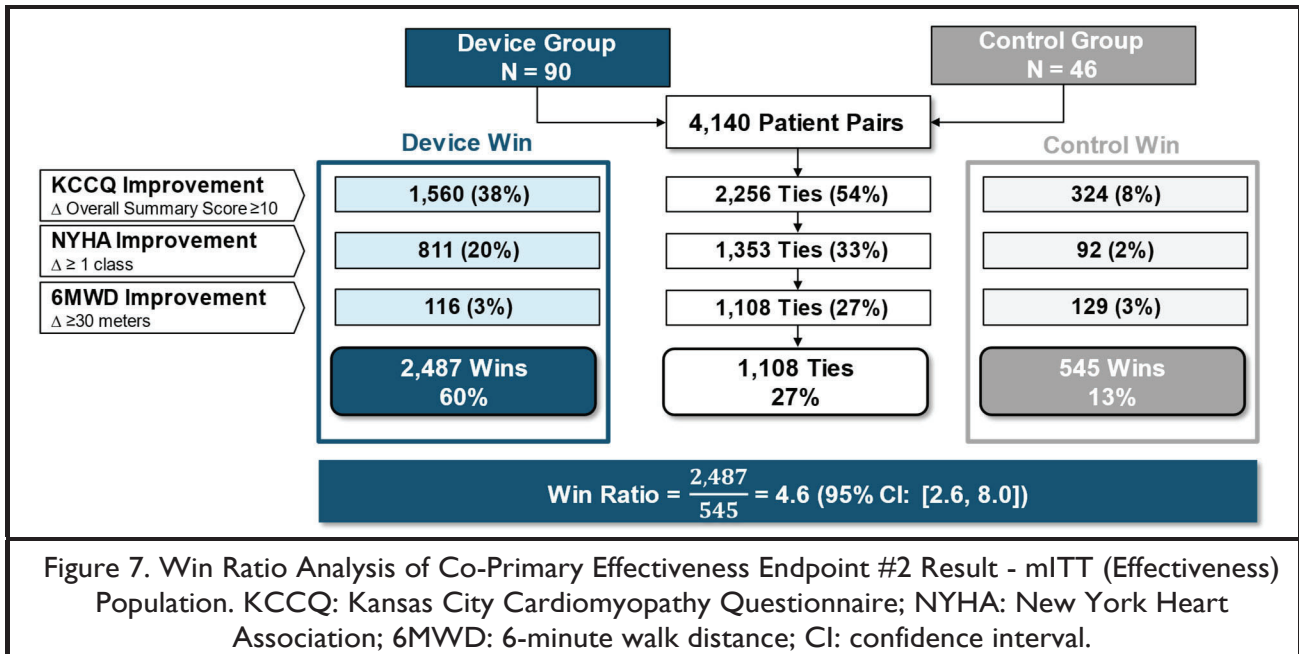

Other Study Observations

*TR Severity Grade:*

The TR severity grades by visit are presented in Figure 8. The proportion of patients with severe or greater TR decreased from 100% at baseline in both groups to 1.2% in the device group compared to 78.4% in the control group at 6 months.

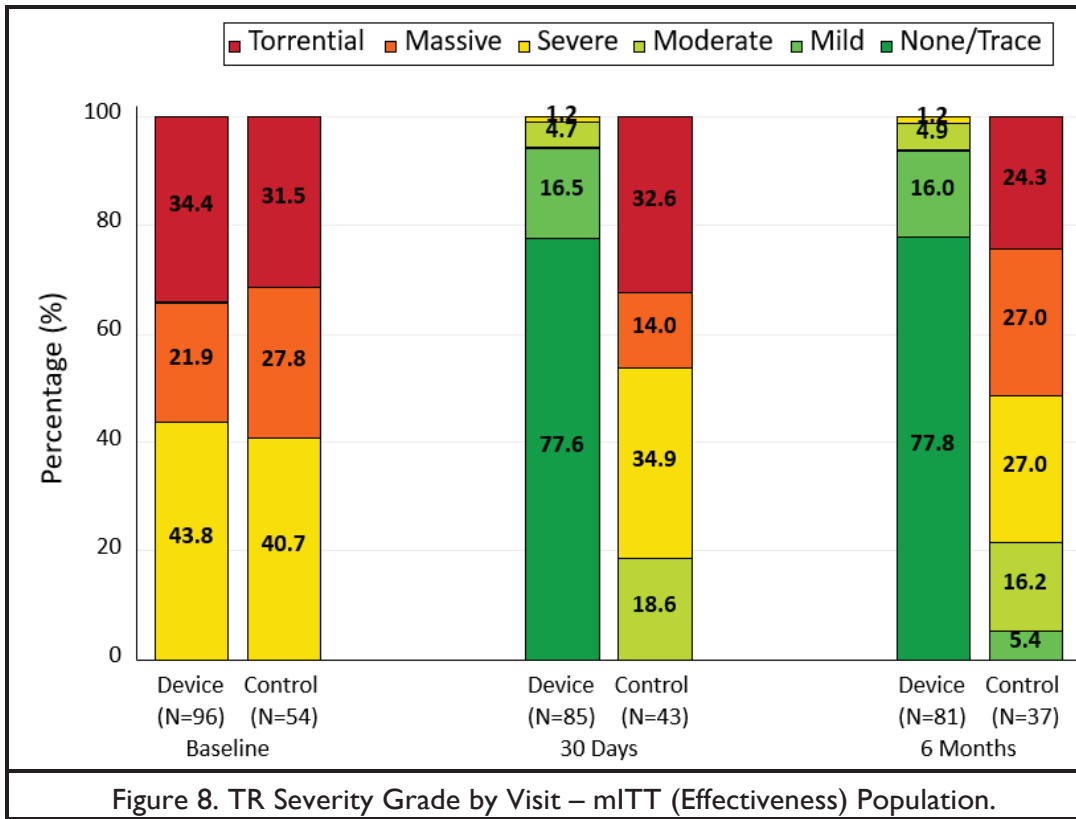

KCCQ Score:

The results for the KCCQ score are presented in Figure 9. The mean score increased from 49.1 at baseline to 67.4 at 30 days and 72.2 at 6 months in the device group, while it remained mostly unchanged from baseline (49.7) to 30 days (49.2) and increased slightly at 6 months (54.9) in the control group.

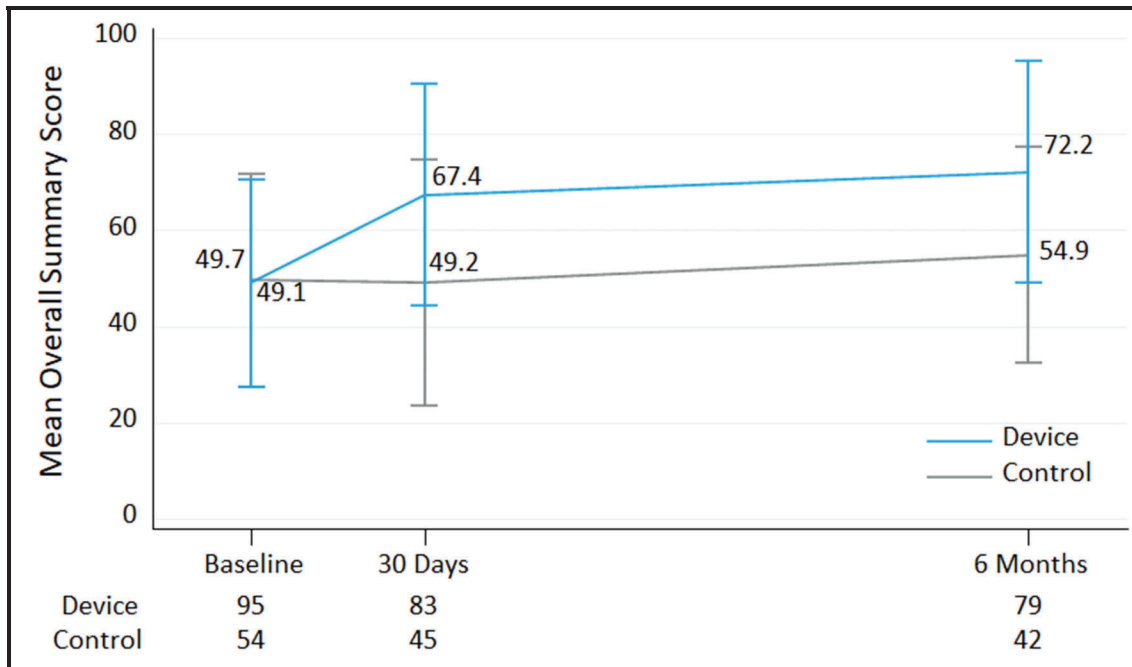
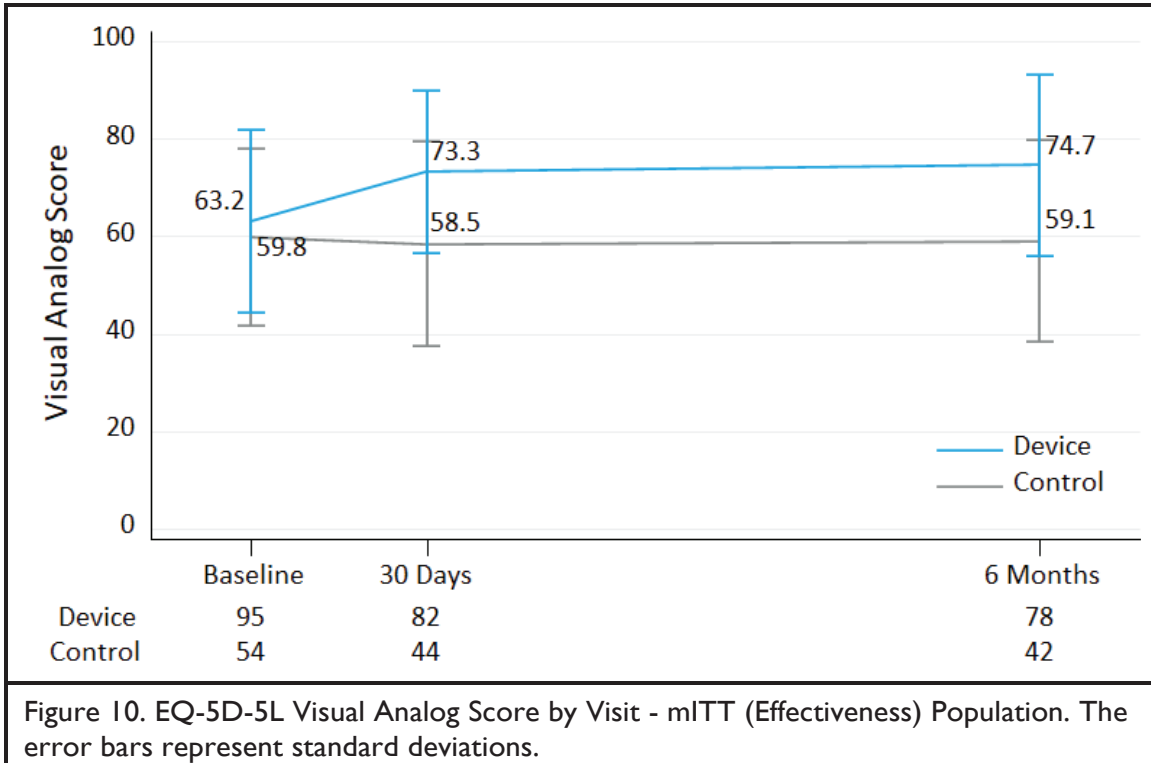

Figure 9. KCCQ Overall Summary Score by Visit – mITT (Effectiveness) Population. The error bars represent standard deviations.



*EQ-5D-5L Score:*

The results for the EQ-5D-5L visual analog score (VAS) are presented in Figure 10. The mean score in the device group increased from 63.2 at baseline to 73.3 at 30 days and mostly sustained at 6 months (74.7). In contrast, the mean score in the control group remained largely unchanged from baseline (59.8) to 30 days (58.5) and to 6 months (59.1).



SF-36 Score:

The results for the SF-36 physical component summary score and mental component summary score are presented in Figure 11. In the device group, the mean SF-36 physical component score increased from baseline by 4.4 points at 30 days and 6.7 points at 6 months, while in the control group, it remained mostly unchanged from baseline to 30 days and increased slightly by 2.2 points from baseline to 6 months. The mean SF-36 mental component score increased from baseline by 2.1 points at 30 days and 4.2 points at 6 months, while it decreased slightly from baseline to 30 days and 6 months in the control group.

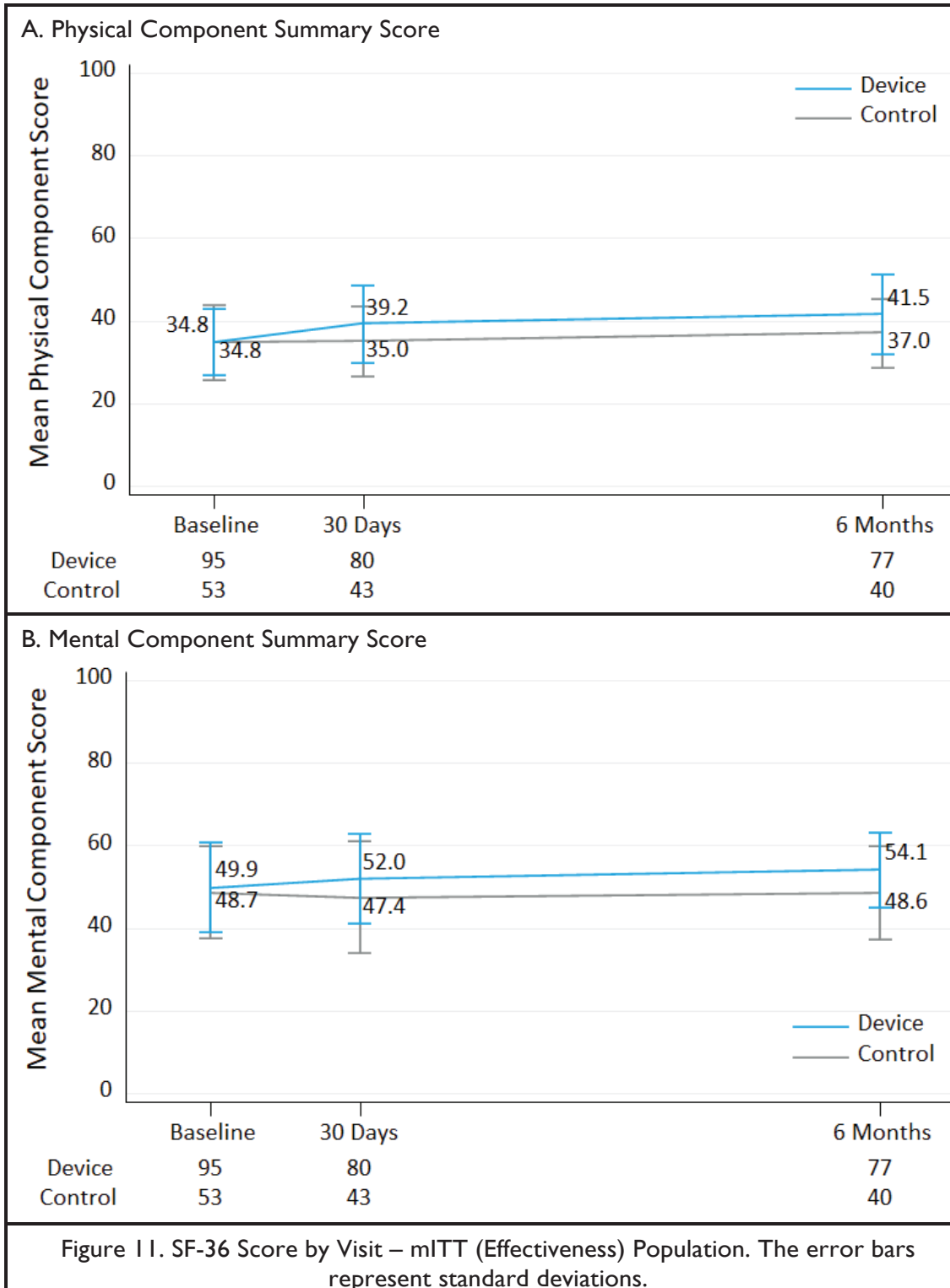

*NYHA Functional Class:*

The NYHA functional class by visit are presented in Figure 12. At baseline, 79.2% of device patients and 70.4% of control patients were in NYHA class III/IV. The proportion of patients in NYHA class III/IV decreased to 10.1% in the device group compared to 65.9% in the control group at 6 months.

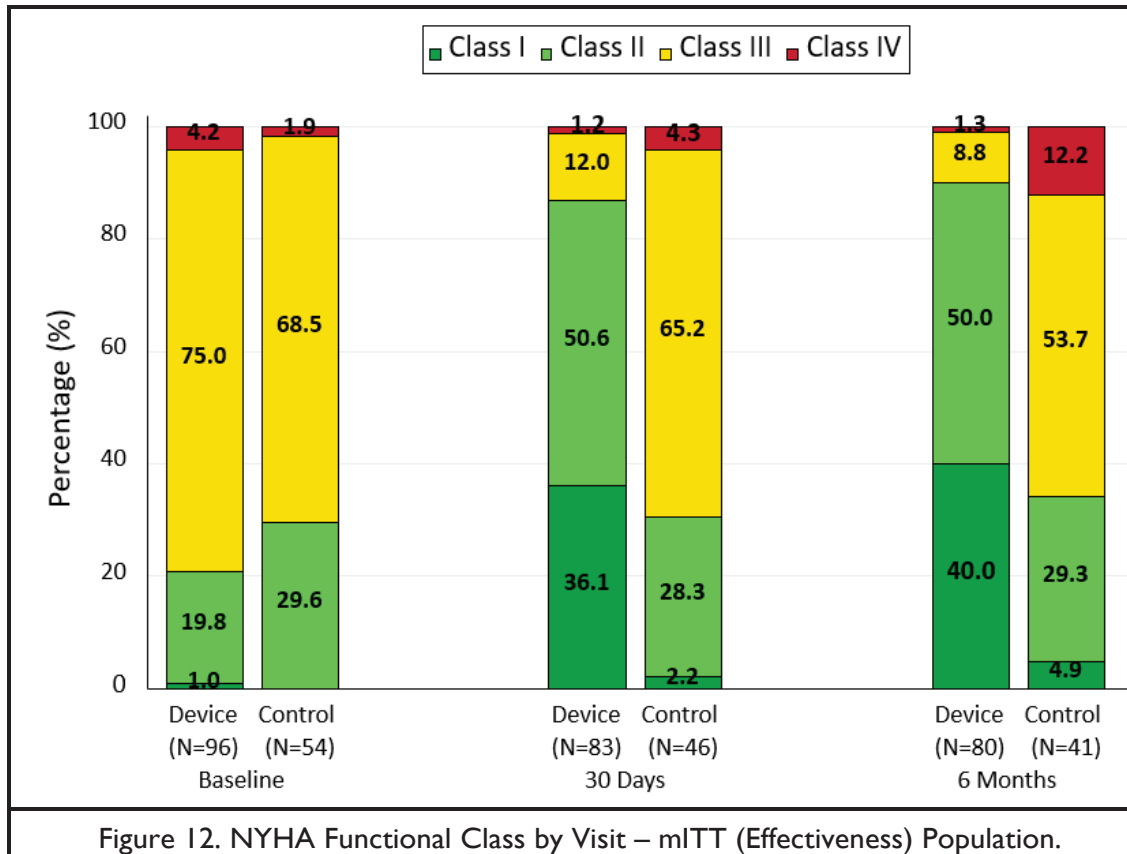

6MWD:

The 6MWD results are presented in Figure 13. The mean 6MWD increased by about 25 meters from baseline to 6 months in the device group compared to about 1.1 meters in the control group.

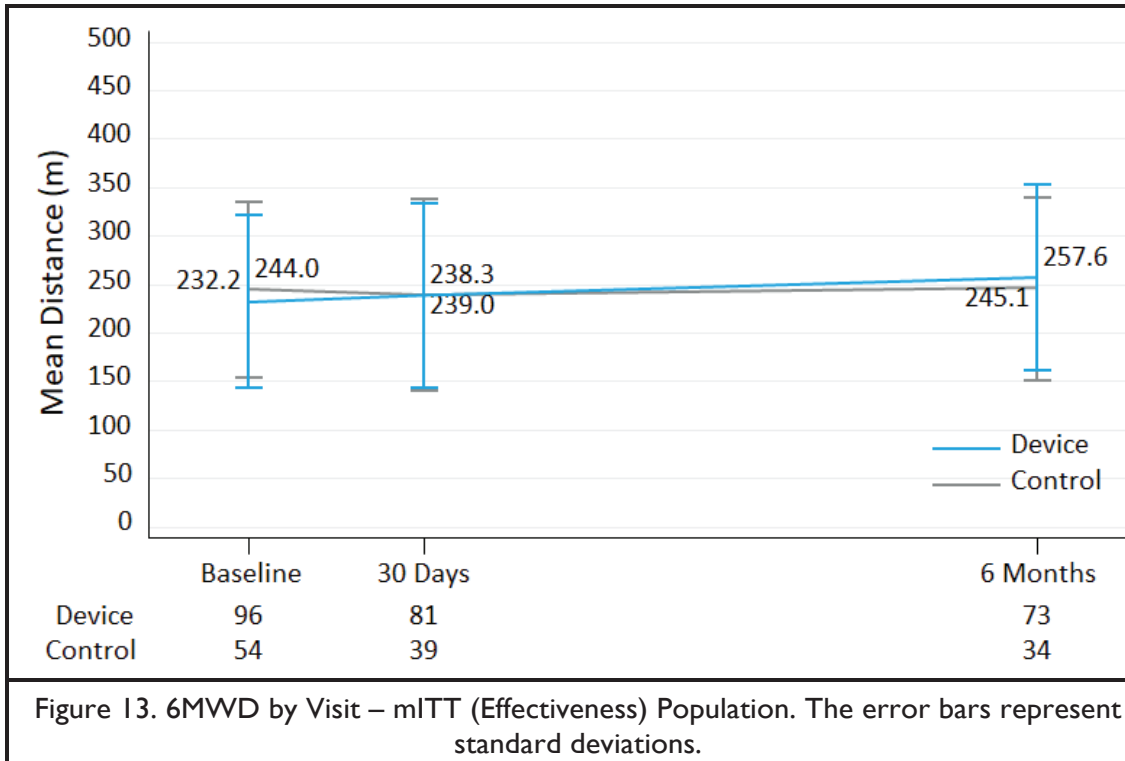

Echocardiographic Parameters:

Key echocardiographic (TTE) parameters for the mITT Effectiveness population at baseline, 30 days, and 6 months are presented in Table 7.

<b>Table 7. Echocardiographic Parameters – mITT Effectiveness Population (Unpaired)</b>						
<b>Variable</b>	<b>Summary Statistics*</b>					
	<b>Baseline</b>		<b>30 Days</b>		<b>6 Months</b>	
	<b>Device Group (N=96)</b>	<b>Control Group (N=54)</b>	<b>Device Group (N=88)</b>	<b>Control Group (N=45)</b>	<b>Device Group (N=81)</b>	<b>Control Group (N=41)</b>
Cardiac output (LVOT; L/min)	3.9 ± 1.97 (92)	3.7 ± 1.64 (54)	4.3 ± 1.34 (80)	4.3 ± 2.38 (44)	4.4 ± 1.58 (73)	4.3 ± 1.95 (40)
CW TV mean gradient (mmHg)	1.8 ± 0.98 (94)	1.7 ± 1.16 (51)	4.3 ± 1.83 (87)	2.0 ± 1.70 (44)	3.3 ± 1.33 (80)	1.5 ± 0.89 (41)
RV fractional area change (%)	40.2 ± 8.36 (85)	39.4 ± 10.00 (50)	25.7 ± 9.90 (68)	36.5 ± 9.63 (36)	27.5 ± 12.54 (67)	36.0 ± 8.46 (39)
RV end diastolic mid diameter (mm)	39.0 ± 8.51 (94)	39.2 ± 6.30 (52)	34.2 ± 7.65 (76)	38.9 ± 7.35 (39)	33.1 ± 7.61 (69)	38.0 ± 7.64 (39)
RVOT VTI (cm)	11.1 ± 3.54 (90)	10.8 ± 4.19 (48)	13.0 ± 4.11 (84)	10.8 ± 3.66 (44)	13.0 ± 4.35 (73)	10.8 ± 3.37 (38)
RVOT stroke volume (mL)	52.0 ± 22.20 (80)	53.2 ± 27.13 (45)	71.5 ± 41.57 (72)	60.7 ± 24.53 (33)	68.6 ± 29.32 (54)	58.3 ± 23.38 (30)
RV free wall longitudinal strain (3D only; %)	-20.7 ± 7.38 (28)	-20.0 ± 8.17 (20)	-13.4 ± 5.23 (29)	-22.0 ± 8.06 (21)	-11.3 ± 4.49 (33)	-21.1 ± 5.95 (23)
IVC diameter (expiration; mm)	25.0 ± 5.78 (94)	24.2 ± 7.10 (54)	22.1 ± 5.33 (82)	23.9 ± 8.14 (39)	20.5 ± 5.18 (79)	23.9 ± 7.91 (39)
<b>Hepatic vein flow</b>						
S-dominant	8.5% (7/82)	11.1% (5/45)	31.6% (18/57)	5.3% (2/38)	25.0% (15/60)	8.8% (3/34)
D-dominant	6.1% (5/82)	15.6% (7/45)	40.4% (23/57)	21.1% (8/38)	56.7% (34/60)	23.5% (8/34)
S-reversal	85.4% (70/82)	73.3% (33/45)	28.1% (16/57)	73.7% (28/38)	18.3% (11/60)	67.6% (23/34)
PASP (mmHg)	37.5 ± 9.57 (93)	38.0 ± 11.53 (54)	35.8 ± 10.45 (31)	36.9 ± 11.74 (38)	34.3 ± 10.25 (33)	37.5 ± 11.37 (38)
TAPSE (mm)	15.9 ± 4.25 (80)	16.0 ± 4.00 (45)	11.8 ± 4.42 (64)	15.6 ± 3.83 (39)	11.3 ± 3.28 (61)	15.4 ± 4.41 (36)

LVOT: left ventricular outflow tract; CW: continuous wave; TV: tricuspid valve; RV: right ventricular; RVOT: right ventricular outflow tract; VTI: velocity time integral; 3D: 3-three dimensional; IVC: inferior vena cava; PASP: pulmonary artery systolic pressure; TAPSE: tricuspid annular plane systolic excursion.

\*Continuous variables: mean ± standard deviation (no.); categorical variables: % (no./total no.)

Procedural Data:

The general procedural data for the randomized cohort are summarized in Table 8.

<b>Variable</b>	<b>Result* (N=92)</b>
General anesthesia	100.0% (92/92)
Implant rate†	100.0% (92/92)
Total procedure time (min)‡	115.7 ± 48.93 (92) 101.0 (53.0, 351.0)
Device time (min)§	65.7 ± 28.42 (91) 60.0 (31.0, 167.0)
Fluoroscopy duration (min)	30.6 ± 14.03 (92) 27.5 (10.0, 72.0)
Total length of stay in days for the index hospitalization (from procedure date)	5.9 ± 6.09 (92) 4.0 (1.0, 46.0)

\*Continuous variables: Mean ± standard deviation (n); median (min, max); categorical variables: % (no/total no).  
 †Implant rate: % of patients who had study device implanted, deployed as intended, and delivery system retrieved successfully.  
 ‡Total procedure time: from procedure start time (femoral vein puncture/skin incision) to femoral vein access closure.  
 §Device time: from implant system insertion to removal.

Adverse Events

The site-reported device-or procedure-related serious adverse events that occurred through 6 months in the Breakthrough Pathway Cohort are presented in Table 9.

<b>Event</b>	<b>Device Group (N=96)</b>			
	<b>30 Days</b>		<b>6 Months</b>	
	<b>No. Events</b>	<b>Event Rate*</b>	<b>No. Events</b>	<b>Event Rate*</b>
Acute kidney injury	4	4.2% (4/96)	4	4.2% (4/96)
Acute left ventricular failure	0	0.0% (0/96)	1	1.0% (1/96)
Acute respiratory distress syndrome	1	1.0% (1/96)	1	1.0% (1/96)
Acute respiratory failure	1	1.0% (1/96)	1	1.0% (1/96)
Altered mental status	1	1.0% (1/96)	1	1.0% (1/96)
Anemia	2	2.1% (2/96)	2	2.1% (2/96)
Arrhythmia	2	2.1% (2/96)	2	2.1% (2/96)
Arterial repair	1	1.0% (1/96)	1	1.0% (1/96)
Atrial fibrillation	2	2.1% (2/96)	3	3.1% (3/96)
Atrioventricular block complete	11	11.5% (11/96)	11	11.5% (11/96)
Bradycardia	4	4.2% (4/96)	5	5.2% (5/96)
Cardiac arrest	1	1.0% (1/96)	1	1.0% (1/96)
Cardiac failure	7	7.3% (7/96)	9	9.4% (9/96)

**Table 9. Site-Reported Device- or Procedure-Related Serious Adverse Events - mITT (Safety) Population.**

Event	Device Group (N=96)			
	30 Days		6 Months	
	No. Events	Event Rate*	No. Events	Event Rate*
Cardiac perforation	2	2.1% (2/96)	2	2.1% (2/96)
Cardiogenic shock	3	3.1% (3/96)	3	3.1% (3/96)
Cellulitis	1	1.0% (1/96)	1	1.0% (1/96)
Chest pain	1	1.0% (1/96)	1	1.0% (1/96)
Decubitus ulcer	1	1.0% (1/96)	1	1.0% (1/96)
Deep vein thrombosis	1	1.0% (1/96)	1	1.0% (1/96)
Fall	1	1.0% (1/96)	1	1.0% (1/96)
Hemorrhagic shock	1	1.0% (1/96)	1	1.0% (1/96)
Heparin-induced thrombocytopenia	1	1.0% (1/96)	1	1.0% (1/96)
Hepatic congestion	1	1.0% (1/96)	1	1.0% (1/96)
Hypotension	2	2.1% (2/96)	2	2.1% (2/96)
Hypovolemic shock	1	1.0% (1/96)	1	1.0% (1/96)
Ileus paralytic	1	1.0% (1/96)	1	1.0% (1/96)
Intracardiac thrombus	1	1.0% (1/96)	2	2.1% (2/96)
Jailed pacing lead	1	1.0% (1/96)	1	1.0% (1/96)
Junctional rhythm	1	1.0% (1/96)	1	1.0% (1/96)
Leukocytosis	2	2.1% (2/96)	2	2.1% (2/96)
Low cardiac output syndrome	1	1.0% (1/96)	1	1.0% (1/96)
Mallory-Weiss tear	1	1.0% (1/96)	1	1.0% (1/96)
Pleural effusion	3	3.1% (3/96)	3	3.1% (3/96)
Prosthetic cardiac valve malfunction	0	0.0% (0/96)	1	1.0% (1/96)
Prosthetic cardiac valve thrombosis	0	0.0% (0/96)	2	2.1% (2/96)
Prosthetic valve endocarditis	0	0.0% (0/96)	1	1.0% (1/96)
Pulmonary edema	5	5.2% (5/96)	5	5.2% (5/96)
Pulmonary embolism	1	1.0% (1/96)	1	1.0% (1/96)
Respiratory failure	1	1.0% (1/96)	1	1.0% (1/96)
Respiratory insufficiency	1	1.0% (1/96)	1	1.0% (1/96)
Retroperitoneal hematoma	1	1.0% (1/96)	1	1.0% (1/96)
Right bundle branch block	1	1.0% (1/96)	1	1.0% (1/96)
Right ventricular dysfunction	4	4.2% (4/96)	4	4.2% (4/96)
Right ventricular failure	2	2.1% (2/96)	2	2.1% (2/96)
Septic shock	1	1.0% (1/96)	1	1.0% (1/96)
Thrombocytopenia	1	1.0% (1/96)	1	1.0% (1/96)
Thrombosis	1	1.0% (1/96)	1	1.0% (1/96)
Uremia	1	1.0% (1/96)	1	1.0% (1/96)
Vascular access site bleeding	2	2.1% (2/96)	2	2.1% (2/96)
Vascular access site hematoma	1	1.0% (1/96)	1	1.0% (1/96)



<b>Table 9. Site-Reported Device- or Procedure-Related Serious Adverse Events - mITT (Safety) Population.</b>				
<b>Event</b>	<b>Device Group (N=96)</b>			
	<b>30 Days</b>		<b>6 Months</b>	
	<b>No. Events</b>	<b>Event Rate*</b>	<b>No. Events</b>	<b>Event Rate*</b>
Vascular access site infection	0	0.0% (0/96)	1	1.0% (1/96)
Ventricular extrasystoles	1	1.0% (1/96)	1	1.0% (1/96)

\*% (no./total no.)

*1-Year Outcomes for Available Full Cohort Patients*

During FDA’s PMA review, a total of 259 patients were randomized to the device group and had an attempted procedure, and 133 patients were randomized to the control group (Full Cohort mITT Safety Population), of which 220 (84.9%) device patients and 98 (73.7%) control patients completed the 1-year visit as of December 15, 2023 (Table 10).

<b>Table 10. Available Full Cohort Patients - mITT Safety Population.</b>		
	<b>Device Group</b>	<b>Control Group</b>
Total number of patients	259	133
30-day visit complete	245 (94.6%)	124 (93.2%)
6-month visit complete	231 (89.2%)	112 (84.2%)
1-year visit complete	220 (84.9%)	98 (73.7%)
Total withdrawals	10 (3.9%)	18 (13.5%)

Available descriptive 1-year results of the Full Cohort primary endpoint and its components are shown in Figure 14 through Figure 18. There was no RVAD implantation or heart transplantation in either group. The results showed favorable trends in the device group compared to the control group in the win ratio result of the primary endpoint and in the descriptive results of all the primary endpoint components with observed events.

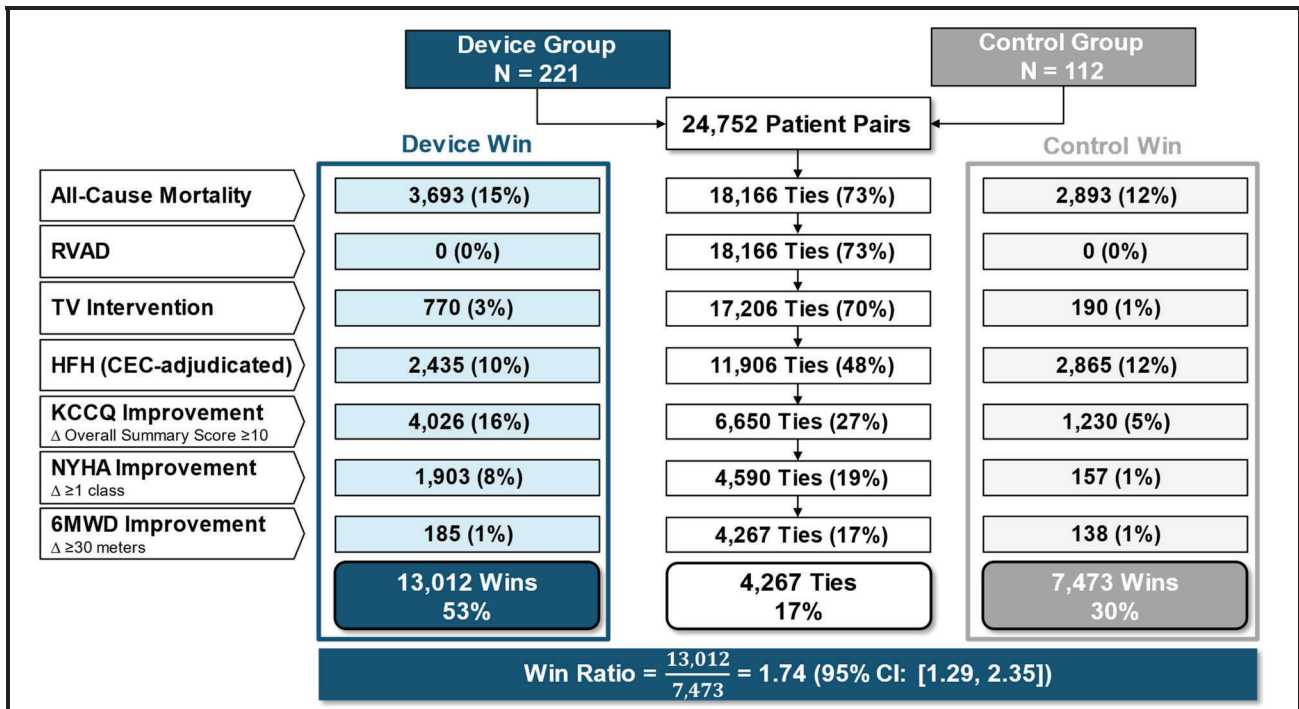
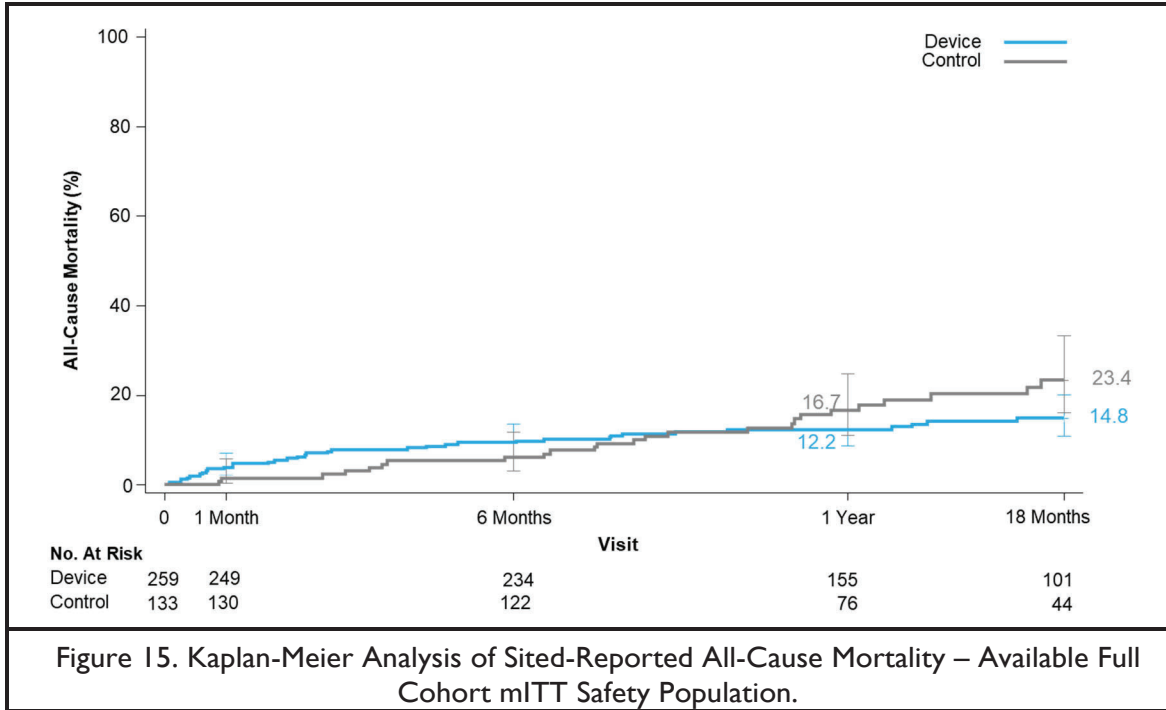

Figure 14. Win Ratio Analysis of Primary Safety and Effectiveness Endpoint - Available Full Cohort mITT Effectiveness Population. RVAD: right ventricular assist device; TV: tricuspid valve; HFH: heart failure hospitalization; CEC: Clinical Events Committee; KCCQ: Kansas City Cardiomyopathy Questionnaire; NYHA: New York Heart Association; 6MWD: 6-minute walk distance; CI: confidence interval.

All-Cause Mortality

The Kaplan-Meier curves for All-Cause Mortality are shown in Figure 15 for the Available Full Cohort.



*Tricuspid Valve Surgical or Percutaneous Intervention*

The Kaplan-Meier curves for Tricuspid Valve Surgical or Percutaneous Intervention are shown in Figure 16 for the Available Full Cohort.

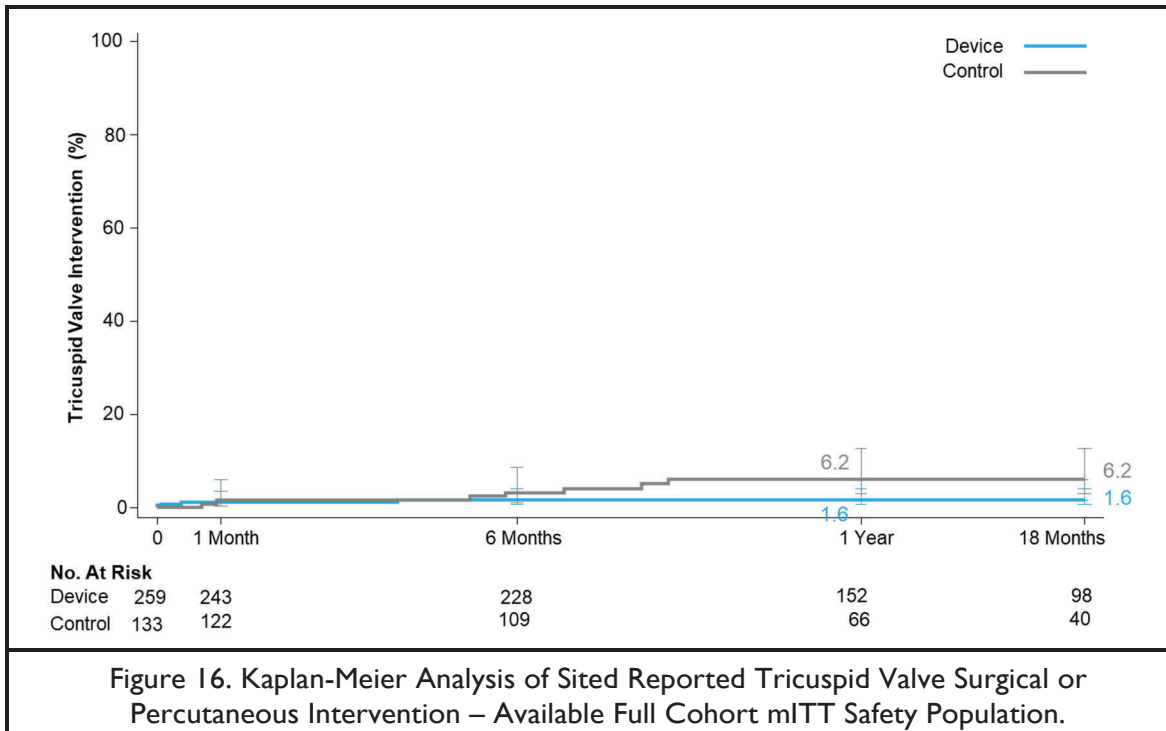

*Annualized Heart Failure Rehospitalization Rate*

The Annualized Heart Failure Hospitalization Rate (events/patient/year) are shown in Figure 17 for the Available Full Cohort.

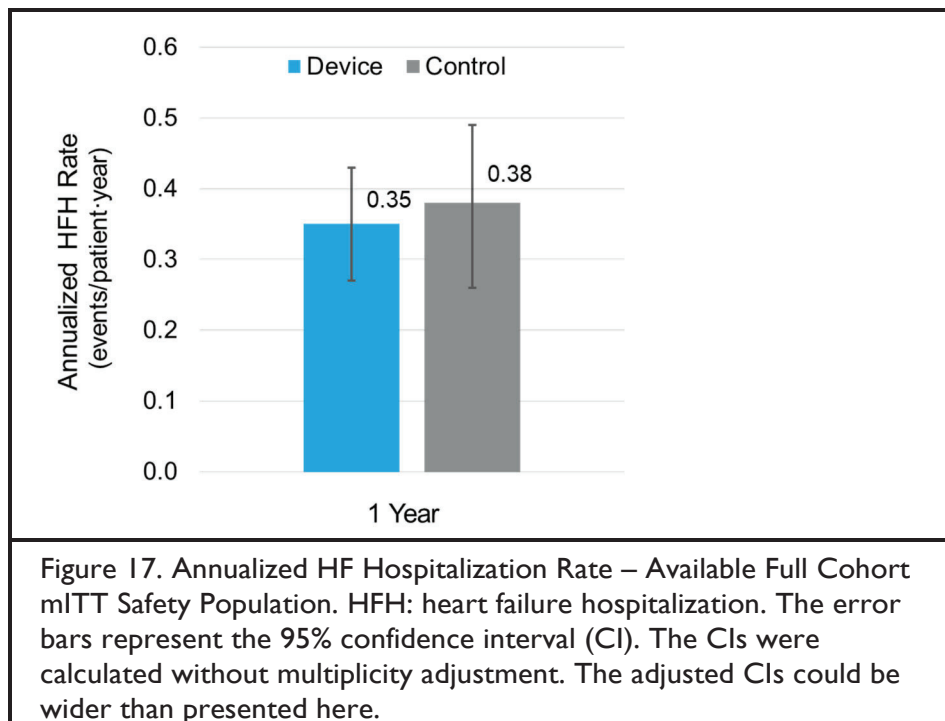

KCCQ, NYHA, and 6MWD

The improvements in KCCQ, NYHA, and 6MWD are shown in Figure 18 for the Available Full Cohort.

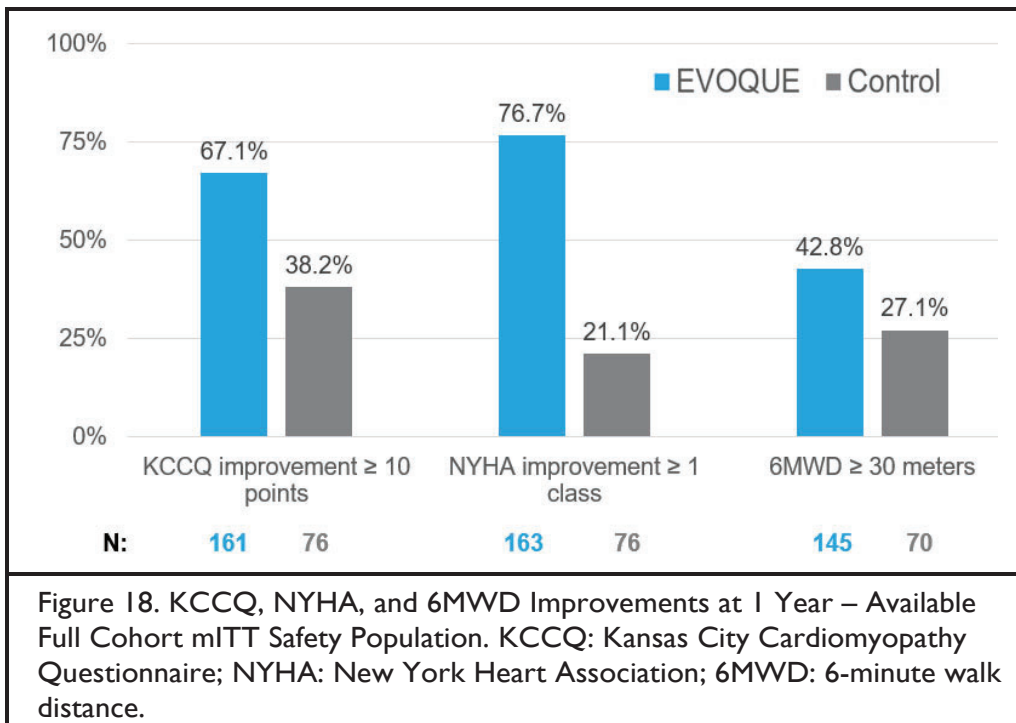

Figures

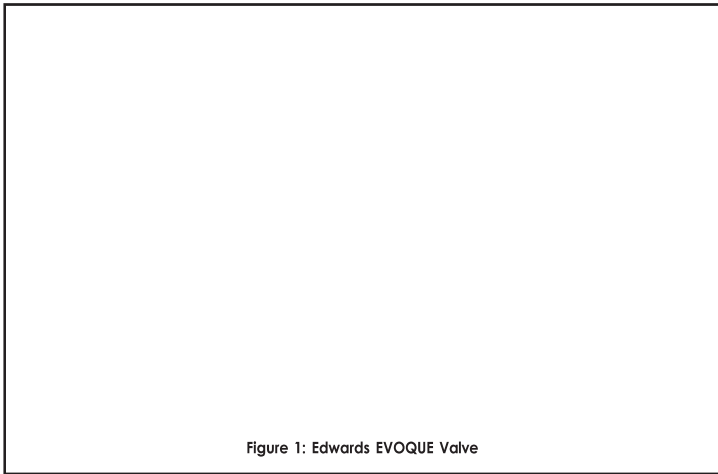

Figure 1: Edwards EVOQUE Valve

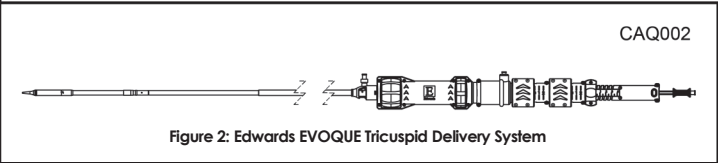
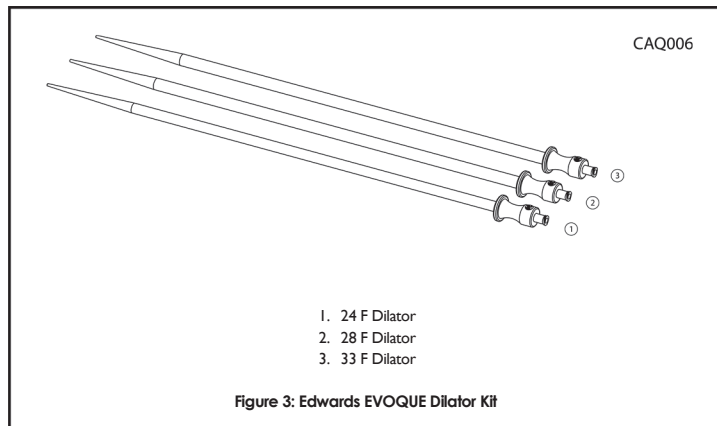

Figure 2: Edwards EVOQUE Tricuspid Delivery System



- 1. 24 F Dilator
- 2. 28 F Dilator
- 3. 33 F Dilator

Figure 3: Edwards EVOQUE Dilator Kit

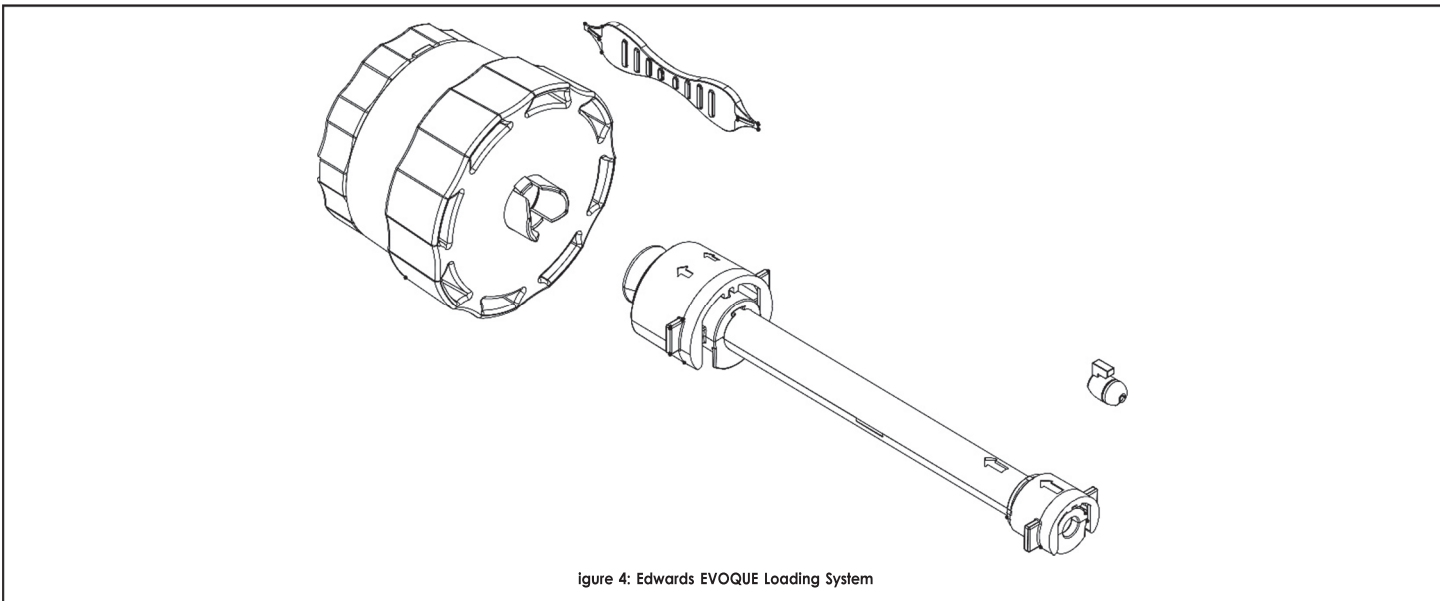

Figure 4: Edwards EVOQUE Loading System

CAQ004

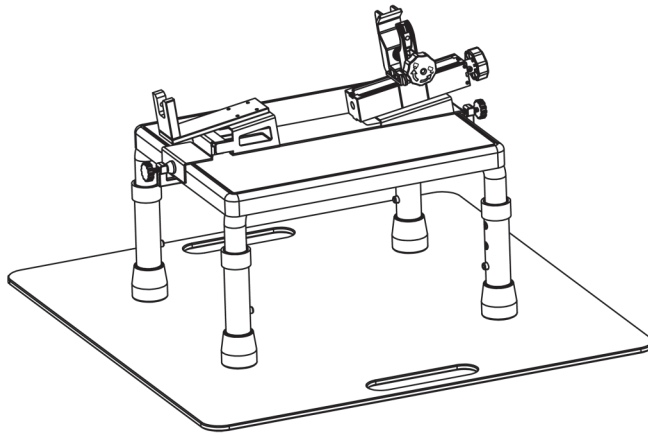

Figure 5: Edwards EVOQUE Stabilizer, Base, and Plate



### Symbol Legend

	English
	Model Number
	Catalogue Number
	Lot Number
	Quantity
	Contents
	Usable length
	Do not re-use
	Caution
	Consult instructions for use or consult electronic instructions for use
	Do not use if package is damaged and consult instructions for use
	Do not use product if indication is shown
	Use product if indication is shown
	Store in a cool, dry place
	Keep away from sunlight
	Keep dry
	Consult instructions for use on the website
<b>Rx only</b>	Caution: Federal (USA) law restricts this device to sale by or on the order of a physician.

	English
	Sterilized using ethylene oxide
	Sterilized using irradiation
	Sterilized using liquid chemical
	Do not re-sterilize
	Non-sterile
	Non-pyrogenic
	Non-DEHP
	Use-by date
	Serial Number
	Authorized representative in the European Community/European Union
	Manufacturer
	Date of manufacture
<b>44 mm</b>	For use with size 44 mm Edwards transcatheter heart valve
<b>48 mm</b>	For use with size 48 mm Edwards transcatheter heart valve
<b>52 mm</b>	For use with size 52 mm Edwards transcatheter heart valve
	Temperature limit
	Medical device

	English
	Exterior diameter
	Inner diameter
	Recommended guidewire length
	Recommended guidewire size
	Guidewire compatibility
	Size
	Catheter shaft size
	Balloon diameter
	Balloon working length
	MR Conditional
	MR Unsafe
	Unique device identifier
	Contains hazardous substances
	Single sterile barrier system
	Contains biological material of animal origin

**Note:** The labeling of this product may not contain every symbol depicted in this legend.



Edwards

03/2023  
10055365001 A

© Copyright 2023, Edwards Lifesciences LLC  
All rights reserved.



**Edwards Lifesciences LLC**  
One Edwards Way  
Irvine, CA 92614 USA

Telephone +1.949.250.2500  
+1.800.424.3278  
FAX +1.949.250.2525

Web IFU

**For Internal Edwards Lifesciences Use Only.  
For proofreading documentation only.**

 <b>Edwards</b>	Title: eIFU, EVOQUE PMA, EO	Page: 9 of 9
	Label Item/Revision:	I0055365001/A
	Visual Representation/Revision:	DOC-0211944/A
	Drawing/Specification:	N/A
	English Master/Revision:	N/A
	eIFU Visual Representation/Revision:	N/A
	Refer to supporting material for signatures.	