



EN **Zilver[®] Vena[™] Venous Self-Expanding Stent**
7 Instructions for Use

ZILVER® VENA™ VENOUS STENT (Fig. 1)

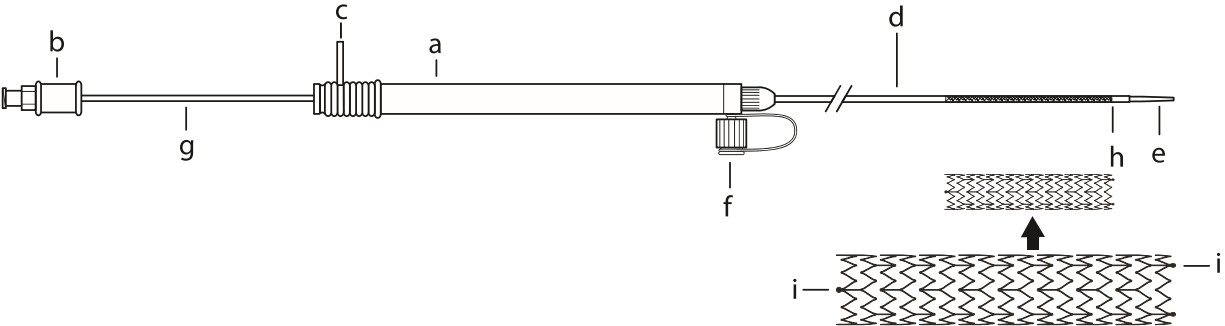

Fig. 1

- a. Handle
- b. Hub
- c. Safety Lock
- d. Delivery System: Outer Sheath
- e. Tip of Delivery System Inner Catheter
- f. Side-arm Flushing Port
- g. Metal Cannula
- h. Radiopaque Marker on the Delivery System
- i. Gold Radiopaque Markers

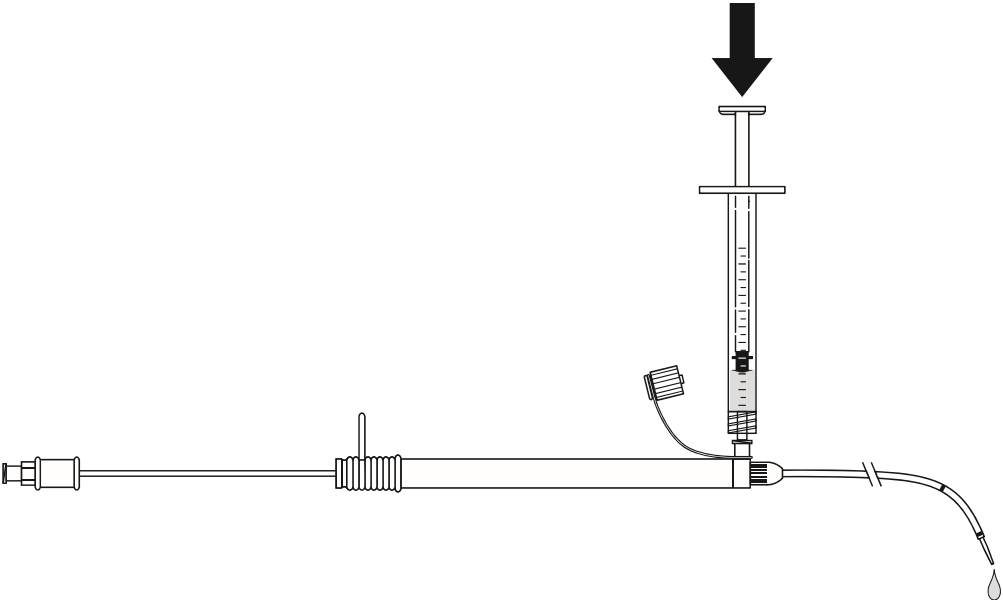

Fig. 2

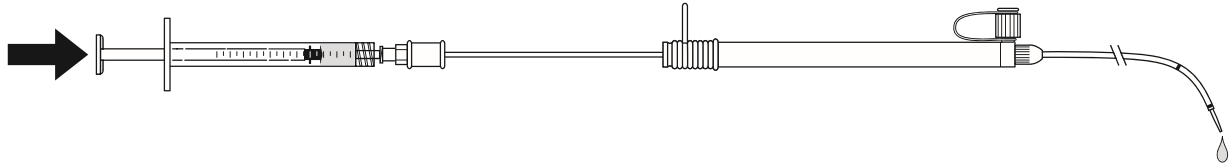

Fig. 3

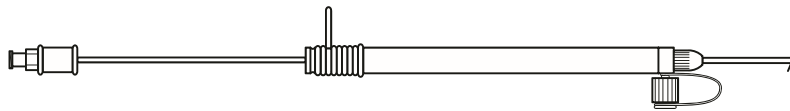
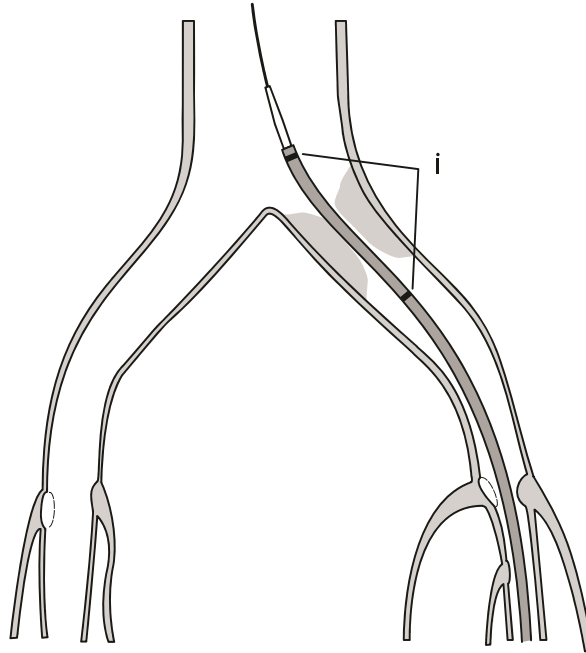

Fig. 4

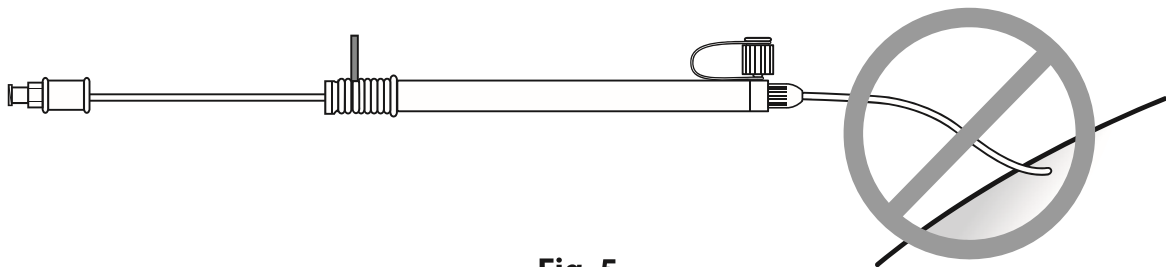

Fig. 5

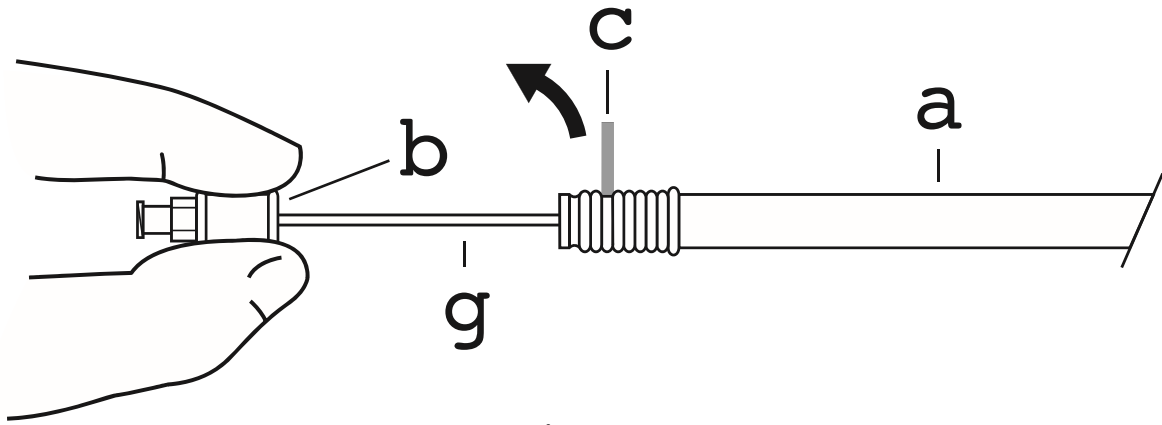

Fig. 6

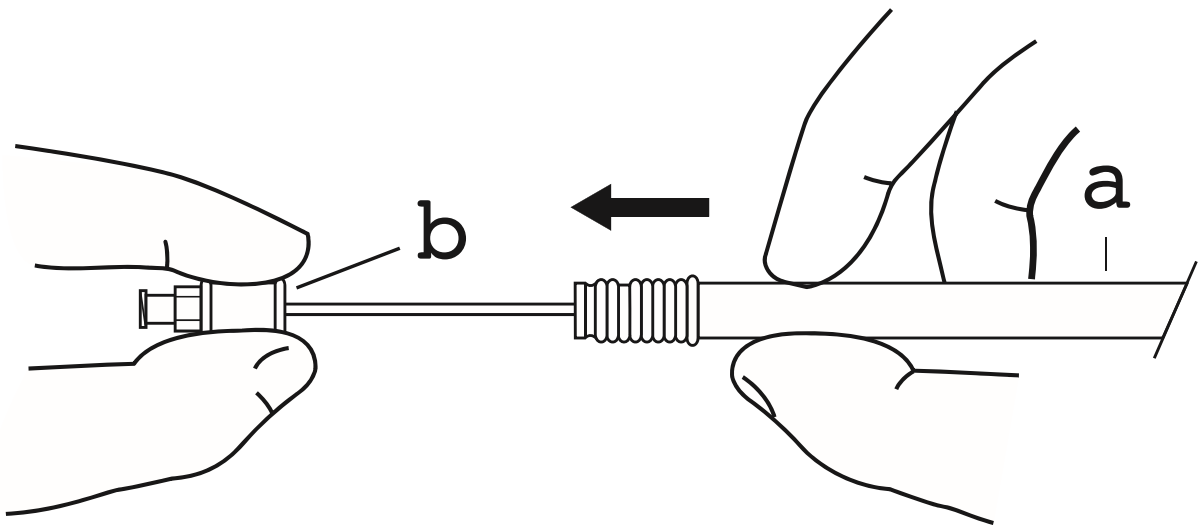

Fig. 7

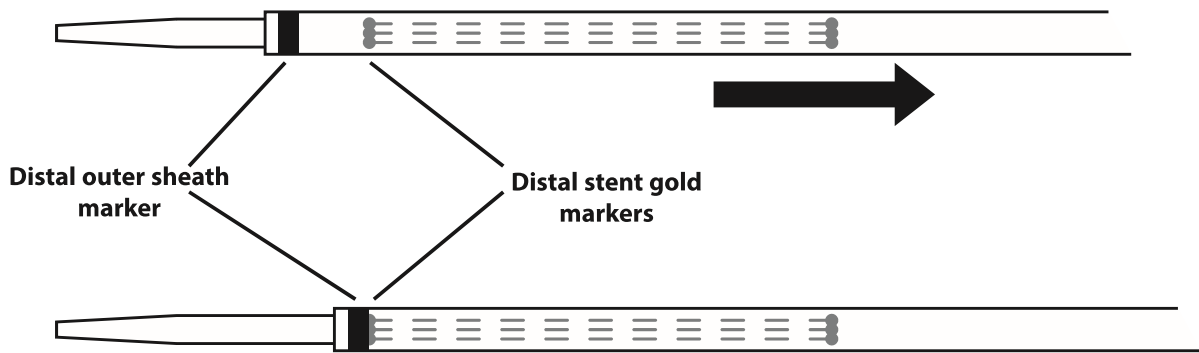

Fig. 8

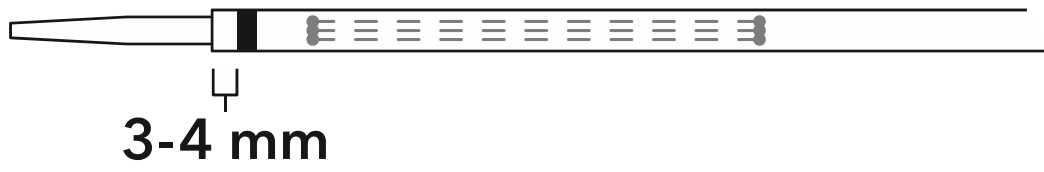

Fig. 9



Fig. 10

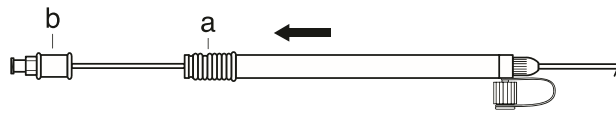
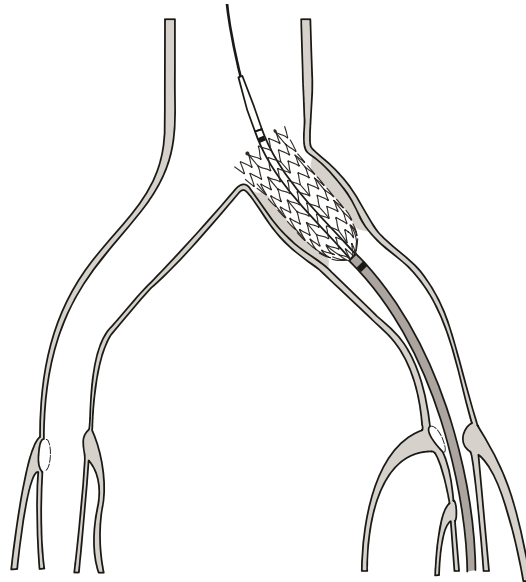

Fig. 11

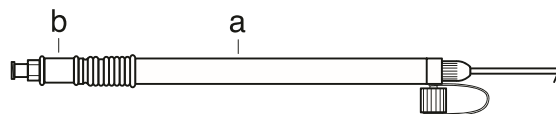
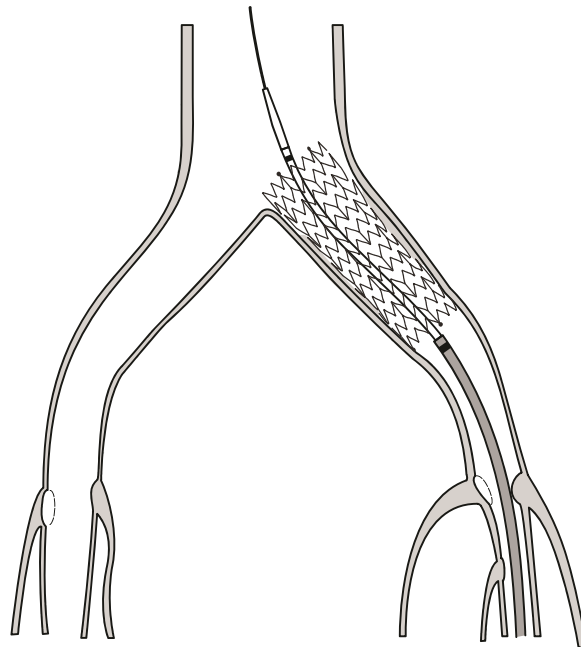

Fig. 12

ZILVER® VENA™ VENOUS SELF-EXPANDING STENT

CAUTION: U.S. federal law restricts this device to sale by or on the order of a physician (or properly licensed practitioner).

Do not re-sterilize. Carefully read all instructions prior to use.

DEVICE DESCRIPTION

The Zilver Vena Venous Stent is a self-expanding, flexible, slotted-tube nitinol stent. Post-deployment, the stent is designed to impart an outward radial force upon the inner lumen of the vessel, establishing patency in the stented region.

Upon deployment, the stent provides support, while maintaining flexibility in the vessel.

The Zilver Vena Venous Stent is available in the following sizes:

2.3 mm (7.0 French) Delivery System									
Stent Length (mm)		40		60		100		140	
Delivery System (cm)		80	120	80	120	80	120	80	120
Stent Inner Diameter (mm)	10	x	x	x	x	x	x	x	x
	12	x	x	x	x	x	x	x	x
	14	NA	NA	x	x	x	x	x	x
	16	NA	NA	x	x	x	x	x	x

The stent comes preloaded in a 2.3 mm (7.0 French) delivery catheter. A radiopaque marker (h) (**Fig.1**) on the distal tip of the outer sheath is used to visualize deployment of the stent. Hand-loading of the stent is not possible. Stent deployment is controlled by means of a hand-held device and by retraction of the handle while holding the metal cannula stationary.

INDICATIONS FOR USE

The Zilver® Vena™ Venous Stent is indicated for improving luminal diameter in the iliofemoral veins for the treatment of symptomatic iliofemoral venous outflow obstruction.

CONTRAINDICATIONS

The Zilver Vena Venous Self-Expanding Stent System is contraindicated for use in:

- Patients who are judged to have a lesion that prevents complete inflation of a balloon dilatation catheter or proper placement of the stent or the stent delivery system.
- Patients who cannot receive intraprocedural anti-coagulation therapy.

WARNINGS

- Nitinol (nickel-titanium) may cause allergic reactions in some patients.
- The device is designed for single use only. Attempts to reprocess, re-sterilize, and/or reuse may lead to device failure and/or transmission of disease. This may also increase the risk of contamination.
- Sterile if package is unopened or undamaged. Do not use the product if there is doubt as to whether the product is sterile. Inspect the product to ensure no damage has occurred.
- This device is a permanent implant.

PRECAUTIONS

- This product should only be used by physicians trained and experienced in diagnostic and interventional vascular techniques. Standard techniques for interventional vascular procedures should be employed.
- Manipulation of the Zilver Vena Venous Stent requires high-resolution fluoroscopic control.
- Do not use power injection systems with the delivery system.
- Prior to the procedure, the patient's underlying condition should be assessed for compatibility with anticipated procedural and post-procedural antiplatelet/anticoagulation therapy.
- Use in patients with a history of contrast sensitivity is not recommended unless the patient can be adequately premedicated.
- Safety and effectiveness of the Zilver Vena Venous Stent for use in the arterial system has not been established.
- When more than one stent is required, resulting in stent-to-stent contact, stent materials should be of similar composition to avoid the possibility of dissimilar metal corrosion.
- The potential effects of phthalates on pregnant/nursing women or children have not been fully characterized and there may be concern for reproductive and developmental effects.

Stent Handling

- Do not attempt to remove the stent from the delivery system before use.
- Do not expose any part of the delivery system to organic solvents (e.g., alcohol).
- Use the stent system prior to the expiration date specified on the package.

Stent Placement

- Ensure that the safety lock is not inadvertently removed prior to stent release.
- Do not rotate any part of the system during deployment.
- Repositioning of the device once deployment has begun (i.e., the stent markers begin to flower) is not possible because the outer sheath cannot be re-advanced over the stent.
- Repositioning of the delivery system to the intended deployment location can be carried out up until the stent markers begin to flower.
- If excessive resistance is felt when beginning deployment, do not force deployment. Remove the delivery system without deploying the stent and replace with a new device.
- Ensure the handle remains in a stabilized position while deploying the stent. Tension to remove the slack outside the patient's body should be applied; however, do not apply excessive tension on the system as stretching of the stent may occur.
- Once stent deployment has begun, the stent must be fully deployed.

Stent/System Removal

- Do not advance outer sheath after stent has been deployed. Delivery system can be removed without the need to recapture tip.

Post Implant

- Antiplatelet/anticoagulant therapy should be administered during and after procedure according to institutional standard of care.
- Use caution when re-crossing a stent to avoid stent damage or migration (i.e., the use of a balloon has the potential to get caught).

MRI SAFETY INFORMATION



This symbol means the device is MR Conditional.

Non-clinical testing has demonstrated that the Zilver Vena Venous Self-Expanding Stent in single and overlapped configuration is **MR Conditional**.

A patient with this device may be scanned safely after placement under the following conditions:

- Static magnetic field of 1.5 Tesla or 3.0 Tesla only
- Maximum magnetic field spatial gradient of 2000 Gauss/cm (20.0 T/m) or less
- Maximum MR system reported, whole-body-averaged specific absorption rate (SAR) of ≤ 2.0 W/kg (Normal Operating Mode) for 15 minutes of continuous scanning.

Under the scan conditions defined above the Zilver Vena Venous Self-Expanding Stent (single or overlapped) is expected to produce a maximum in vivo temperature rise of less than 3.2°C after 15 minutes of continuous scanning.

The image artifact extends approximately 8 mm from the Zilver Vena Venous Self-Expanding Stent as found during non-clinical testing when imaged with a gradient echo pulse sequence and a 3.0 Tesla MR system. The image artifact obscures the device lumen.

For U.S. Patients Only

Cook recommends that patients register the conditions under which the implant can safely be scanned with the MedicAlert Foundation (www.medicalert.org) or equivalent organization.

POTENTIAL ADVERSE EVENTS

Potential adverse events that may occur include, but are not limited to, the following:

- Abdominal or back pain
- Abrupt stent closure
- Allergic reaction to anticoagulant and/or antithrombotic therapy or contrast medium
- Allergic reaction to nitinol (nickel-titanium)
- Amputation
- Aneurysm
- Arrhythmia
- Arteriovenous fistula
- Bleeding associated with anticoagulation
- Death
- Embolism
- Fever
- Hematoma/hemorrhage at access site
- Hypersensitivity reactions
- Hypertension

- Hypotension, nausea or symptoms of a vasovagal response
- Infection/abscess formation at access site
- Intimal injury/dissection
- Myocardial infarction (MI)
- Pseudoaneurysm formation
- Pulmonary embolism
- Renal failure
- Restenosis, occlusion, or thrombosis of the stented vein
- Septicemia/bacteremia
- Stent malapposition
- Stent migration or embolization
- Stent strut fracture
- Stroke
- Tissue necrosis
- Vasospasm
- Vessel perforation/rupture
- Worsened pain

PRODUCT RECOMMENDATIONS

Venous Access

For venous access, the use of an access set that accepts a 2.3 mm (7.0 French) introducer catheter is recommended.

Wire Guide Selection

The use of a .035 inch (0.89 mm) wire guide is recommended. If hydrophilic wire guides are used, they must be kept fully activated.

PTA Balloon Selection

For pre- and post-dilatation, an appropriately sized balloon catheter is recommended.

Stent Selection

The chosen stent diameter should be oversized 1-4 mm with respect to the estimated vessel diameter as determined by the best available assessment (in preferential order):

1. Diameter of the most normal looking segment of the common iliac, external iliac, or common femoral vein;
2. Expanded balloon diameter used for predilatation; or
3. Standard diameter of the vein to be stented.

HOW SUPPLIED

The Zilver Vena Venous Stent is supplied sterilized by ethylene oxide gas in peel-open packages. Intended for one-time use. Sterile if package is unopened or undamaged. Do not use the product if there is doubt as to whether the product is sterile. Do not store outside the temperature range of 2°C-40°C (36°F-104°F). Store in a dark, dry, cool place. Avoid extended exposure to light. Upon removal from package, inspect the product to ensure no damage has occurred.

Multiple Stent Placement

If placement of more than one stent is required, the following recommendations should be considered:

- When more than one stent is required, resulting in stent-to-stent contact, stent materials should be of similar composition to avoid the possibility of dissimilar metal corrosion.
- In relation to the operator, the distal area of narrowing should be stented first, followed by the proximal locations (i.e., a second stent should be placed proximally to the previously placed stent).
- Stents placed in tandem must overlap by at least 1cm to allow for complete coverage of the lesion.

INSTRUCTIONS FOR USE

Illustrations

Stent Sizing

Determine the proper stent size after complete diagnostic evaluation.

NOTE: Please refer to the Stent Selection section of these instructions for use for recommendations on stent sizing.

NOTE: Please refer to the Multiple Stent Placement section of these instructions for use for recommendations on placing multiple stents, should more than one stent be required to cover the length of the lesion.

Stent Length Change

Vessel Lumen Diameter (mm)	Labeled Stent Diameter (inner diameter) (mm)	% Length Change*		
		Average**	Maximum Shortening	Maximum Lengthening
6-9	10	3	-5	4
8-11	12	2	-3	3
10-13	14	-1	-3	3
12-15	16	-1	-3	1

* %Length Change = ((post-deployment stent length – pre-deployment stent length)/pre-deployment stent length)*100. Positive number indicates lengthening.

** Values are based on average measurements from nonclinical bench testing.

Introduction of the Stent

1. Gain access at the appropriate site utilizing a 2.3 mm (7.0 French) introducer sheath.
2. Introduce a .035 inch (0.89 mm) wire guide through the introducer sheath across the distal segment of the target lesion.
3. Predilatation is at the discretion of the physician. Remove the balloon catheter, leaving the wire guide in place.
4. Immediately before placing the delivery system into the body, use a 1 ml syringe to flush the delivery system with saline through the side-arm flushing port. Flushing the device with contrast media is not recommended. Flush until a few drops of saline exit the distal tip, between the delivery system outer sheath (d) and inner catheter (e) (**Fig. 2**).
5. Use the 1 ml syringe to flush the wire guide lumen of the stent delivery system with saline through the hub (**Fig. 3**).
6. Insert the delivery system over the wire guide.
7. Under fluoroscopy, advance the delivery system over a .035 inch wire guide through the introducer sheath until the distal gold radiopaque markers on the stent are beyond the target lesion site.

NOTE: If resistance is met during advancement of the delivery system over the wire guide, remove the delivery system and replace with a new device.

8. Pull back on the stent delivery system under fluoroscopy until the radiopaque markers on the stent (i) are at the desired position. The stent is now ready to be deployed (**Fig. 4**).

Deployment of the Stent

1. Before initiating deployment, it is important to straighten the proximal part of the delivery system as much as possible, remove any slack in the delivery system and to keep the handle in a stable position, while maintaining stent marker alignment with the intended deployment location (**Fig. 5**).

2. Stent deployment must be performed under fluoroscopic control.

3. Hold the hub (b) on the metal cannula (g) steady. To initiate deployment of the stent, remove the red safety lock (c) (**Fig. 6**).

NOTE: While holding the pin and pull delivery system in your hands, anchoring your elbow to your torso or resting your hands on the leg of the patient will provide stability to the delivery system in order to facilitate precise deployment.

4. Hold the hub end stationary and slowly pull the handle (a) toward the hub (b) (**Fig. 7**). As deployment begins, be prepared for some resistance.

NOTE: If excessive resistance is felt when beginning deployment, do not force deployment. Remove the delivery system without deploying the stent and replace with a new device.

NOTE: Ensure the handle remains in a stabilized position while deploying the stent. Tension to remove the slack outside the patient's body should be applied; however, do not apply excessive tension on the system as stretching of the stent may occur.

5. Slowly pull the handle (a) towards the hub (b) until the distal outer sheath marker overlaps the distal stent gold markers (**Fig. 8**).

NOTE: The movement of the distal stent gold markers to the distal outer sheath marker on the delivery system indicates the progress of the deployment. Reposition the delivery system to the intended deployment location if required. Ensure the distal stent radiopaque markers remain at the intended target, beyond the lesion.

6. Continue to slowly pull the handle (a) towards the hub (b) until just before the stent starts to flower. Allow several seconds for the stent to stabilize and to verify the intended deployment location, then reposition the delivery system to the intended deployment location if necessary.

NOTE: Stent flowering begins approximately 3-4 mm from distal end of outer sheath marker (**Fig. 9**). Repositioning of the delivery system to the intended deployment location can be carried out up until the stent markers begin to flower (**Fig. 10**).

7. Continue deployment of the stent by sliding the handle (a) toward the hub (b) in a slow, smooth and consistent fashion (**Fig. 11**).

NOTE: Once stent deployment has begun, the stent must be fully deployed. Repositioning of the Zilver Vena Venous Stent is not possible once the stent has flowered since the delivery system's outer sheath cannot be re-advanced over the stent once deployment begins.

8. The stent is fully deployed when the handle (a) reaches the hub (b) (**Fig. 12**).

NOTE: If the lesion is not fully covered after stent deployment, refer to the Multiple Stent Placement section of these instructions for use for recommendations on placing multiple stents.

Post Stent Deployment

1. Delivery System Removal - Do not advance outer sheath after the stent has been deployed. Delivery system can be removed without the need to recapture tip. Check for delivery system integrity after removal from the patient.

NOTE: If resistance is encountered while removing the delivery system over the wire guide, carefully remove the delivery system and wire guide together. If resistance continues to be experienced, remove the delivery system, wire guide, and introducer sheath together.

2. Perform a venogram to ensure full deployment of the device.

NOTE: If incomplete expansion exists within the stent at any point along the lesion, post-deployment balloon dilatation can be performed at the discretion of the physician. Select an appropriate size balloon catheter and dilate the lesion with conventional technique. The inflation diameter of the balloon used for post dilatation should approximate the diameter of the reference vessel. Remove the balloon from the patient.

3. Introducer sheath and wire guide may be removed at this point.

4. Close the entry wound as appropriate.

5. Dispose in accordance with institutional guidelines.

Summary of Clinical Studies

The Zilver Vena Venous Self-Expanding Stent (the Zilver Vena Venous Stent) was evaluated through an Investigational Device Exemption (IDE #G110228) study, the Evaluation of the Zilver Vena Venous Stent in the Treatment of Symptomatic Iliofemoral Venous Outflow Obstruction (VIVO) Clinical Study. The VIVO Clinical Study was a prospective, global, multicenter, nonrandomized, single-arm clinical study intended to assess the safety and effectiveness of the Zilver Vena Venous Stent for the treatment of patients with symptomatic iliofemoral venous outflow obstruction. As described below, results from the IDE study support the safety and effectiveness of the Zilver Vena Venous Stent. Specifically, the 30-day freedom from MAE rate and the 12-month primary quantitative patency rate met the performance goals derived from published clinical literature, and clinical outcome measures improved following stent placement. The stent was also evaluated in the VIVO-EU study, a post-market, prospective, nonrandomized, multicenter study which provides supporting evidence regarding the safety and performance of the Zilver Vena Venous Stent.

VIVO Clinical Study

VIVO Clinical Study Design and Endpoints

The VIVO Clinical Study was intended to demonstrate the safety and effectiveness of the Zilver Vena Venous Stent for the treatment of patients with symptomatic iliofemoral venous outflow obstruction. The VIVO Clinical Study was a prospective, global, multicenter, nonrandomized, single-arm clinical study that enrolled 243 patients in the United States and Taiwan with symptomatic venous outflow obstruction in one iliofemoral venous segment.

The study was overseen by an independent Data Safety Monitoring Board (DSMB) in accordance with an established DSMB charter. An independent Clinical Events Committee (CEC) adjudicated predefined clinical events reported during the study in accordance with the CEC charter. An independent core laboratory provided uniformly defined imaging analysis.

The study protocol prespecified enrollment by disease status, i.e., acute (initial onset of symptoms within 30 days of the procedure) or chronic (initial onset of

symptoms greater than 30 days prior to the procedure). The study population was prespecified to include 30% patients (73 patients) with acute disease and 70% patients (170 patients) with chronic disease.

The primary safety endpoint was 30-day freedom from major adverse events (MAEs). MAEs were defined as procedural bleeding requiring transfusion, procedure- or device-related death, clinically driven target lesion reintervention, clinical migration, new symptomatic pulmonary embolism, or procedure-related perforation requiring open surgical repair or flow-limiting dissection of the target vessel. Clinically driven reinterventions were reinterventions performed in patients with recurrent symptoms of venous outflow obstruction of the target lesion and with venography showing a treated venous segment minimum lumen diameter (MLD) $\leq 50\%$ of the immediate post-procedure stented MLD. Clinical migration was defined as proximal or distal movement of the stent requiring surgical or endovascular intervention. The primary safety endpoint was evaluated against a single performance goal of 87%. The performance goal was a weighted average of 85% (computed based on safety data for patients with acute disease, defined as initial symptom onset within 30 days of the procedure) and 88% (computed based on safety data for patients with chronic disease, defined as initial symptom onset greater than 30 days prior to the procedure), with the weight prespecified as 30% acute patients and 70% chronic patients. The weighted averages were based on published clinical literature and included a 10% margin. The study device was considered to have met the safety endpoint if the one-sided p -value from hypothesis testing was less than 0.025.

The primary effectiveness endpoint was primary quantitative patency at 12 months. Primary quantitative patency was defined as a treated venous segment (including the region within ± 1 cm proximal and/or distal of the treated venous segment) that retained (uninterrupted; intervention-free) an MLD $> 50\%$ of the immediate post-procedure stented MLD as demonstrated by venography as determined by the core laboratory. The primary effectiveness endpoint was evaluated against a literature-derived performance goal of 76%; the performance goal was derived based on 12-month patency data available in published literature and included a 10% margin. The study device was considered to have met the effectiveness endpoint if the one-sided p -value from hypothesis testing was less than 0.025.

The secondary endpoint was the change in VCSS from baseline to 1 month and 12 months. The study device was considered to have met the secondary endpoint if p -values (adjusted for multiplicity using the Holm procedure) from hypothesis testing using paired t-test were less than 0.05.

Additional measures without prespecified hypothesis testing were collected through 3 years and included the following:

- Technical success, defined as successful delivery and deployment of the Zilver Vena Venous Stent in the intended location
- Procedural success, defined as improved flow through the target vessel demonstrated by diminished flow through collateral veins and/or reduced filling defect in the target vessel and no MAEs before discharge
- Adverse events
- Type, rate, and interval of clinically driven reintervention within the treated venous segment following treatment
- Type, rate, and interval of reintervention within the treated venous segment following treatment
- Rate of primary quantitative patency, assisted primary quantitative patency, and secondary quantitative patency
- Rate of patency by ultrasound
- Rate of clinical patency, defined as lack of occlusion of the treated venous segment determined by evidence of blood flow proximal and distal to the study lesion assessed via ultrasound and/or venography and no worsening of pain or edema from baseline (according to Venous Clinical Severity Score; VCSS) as related to the target lesion
- Rate of modified clinical patency, defined as lack of occlusion of the treated venous segment determined by evidence of blood flow proximal and distal to the study lesion assessed via ultrasound and/or venography and no worsening of pain or edema from baseline (according to VCSS) as related to the target lesion in two or more consecutive visits
- Device integrity (X-ray assessment for stent fracture)
- Device migration (X-ray assessment for migration)
- Change in VCSS from baseline
- Change in Venous Disability Score (VDS) from baseline
- Change in Clinical Etiological Anatomical Pathophysiological (CEAP) "C" classification from baseline
- Change in Chronic Venous Insufficiency Quality of Life Questionnaire (CIVIQ) score from baseline

Study Eligibility

Patients eligible to be enrolled in the study had symptomatic venous outflow obstruction in one iliofemoral venous segment (i.e., one limb), demonstrated by CEAP "C" ≥ 3 or VCSS pain score ≥ 2 and planned stent placement in the study lesion with only the Zilver Vena Venous Stent. Key exclusion criteria included: < 18 years; pregnant or planning to become pregnant in the 12 months after the study procedure; known hypersensitivity or contraindication to antiplatelet and/or anticoagulant therapy, nitinol, or contrast medium that could not be adequately premedicated; lesions with intended treatment lengths extending into the inferior vena cava or below the level of the lesser trochanter; significant

obstruction (i.e., > 20%) or occlusion of the inflow or outflow tract; lesion with malignant obstruction; presence of symptomatic pulmonary embolism within 30 days prior to the study procedure; and iliofemoral venous segment unsuitable for treatment with the available sizes of study sizes.

Study Follow-up

All treated patients underwent evaluation (clinical assessment and imaging evaluation) prior to the study procedure. Patient follow-up was scheduled at pre-discharge through 36 months. Follow-up included venography at 12 months, and ultrasound and X-ray at 6, 12, 24, and 36 months. In addition, clinical assessments occurred at 1, 6, 12, 24, and 36 months. Clinical assessments included medical history and documentation of the symptom(s) indicative of venous outflow obstruction, using VCSS, VDS, CEAP "C" Classification, and CIVIQ scores, and assessment of adverse events and medications. Telephone contact was scheduled at 3 months.

Results

Demographics, Medical History, and Baseline Characteristics

The mean age of enrolled patients was 53.0 ± 15.3 years (range: 18-89 years). The majority of patients were female (70.0%; 170/243) and white (81.5%; 198/243), and more than half of the study patients had past or current DVT (67.5%; 164/243).

Table 1 provides a summary of the demographics and baseline characteristics for the patients in the VIVO Clinical Study. Table 2 provides a summary of the VIVO patients' medical history and comorbid conditions at baseline.

Table 1. Demographics and baseline patient characteristics for the VIVO Clinical Study

Demographic	Percent Patients (number/total number) or Mean \pm SD (N, range)	
Gender	Male	30.0% (73/243)
	Female	70.0% (170/243)
Age (years)	All patients	53 \pm 15.3 (243, 18-89)
	Male	57.1 \pm 13.2 (73, 23-82)
	Female	51.2 \pm 15.8 (170, 18-89)
Ethnicity	White	81.5% (198/243)
	Black or African American	11.9% (29/243)
	Asian	3.3% (8/243)
	Hispanic or Latino	2.9% (7/243)
	First Nations/White	0.4% (1/243)
Height (in)	66.4 \pm 4.2 (243, 54-79)	
Weight (lbs)	197.0 \pm 57.5 (243, 99.0-415.8)	
Body mass index (BMI)	31.3 \pm 8.5 (243, 17.5-64.8)	

Table 2. Medical history and comorbid conditions for the VIVO Clinical Study

Condition	Percent Patients (number/total number)
Recent trauma (within 30 days)	1.2% (3/243)
Recent immobilization (within 30 days)	2.1% (5/243)
Cardiovascular	
Coronary artery disease	7.4% (18/243)
Previous myocardial infarction (MI)	4.1% (10/243)
Congestive heart failure	3.7% (9/243)
Vascular	
Bleeding diathesis/coagulopathy	7.0% (17/243)
Clotting disorder (family history)	7.9% (19/242)
Hypertension	43.2% (105/243)
Peripheral arterial disease	3.3% (8/243)
Presence of reflux (venous)	18.1% (44/243)
Existing tissue loss related to venous disease:	4.5% (11/243)
Gangrene	0% (0/11)
Stasis ulcers	100% (11/11)
Amputation	0% (0/11)
Past or current deep vein thrombosis (DVT):	67.5% (164/243)
Past DVT	27.4% (45/164)
Current and past DVT	15.9% (26/164)
Current DVT	56.7% (93/164)
Current DVT Status:	
Acute (within 30 days)	49.6% (59/119)
Acute DVT on chronic DVT/post-thrombotic syndrome	14.3% (17/119)
Chronic DVT/post-thrombotic syndrome	36.1% (43/119)
DVT (family history)	9.9% (24/242)

Condition	Percent Patients (number/total number)
Pulmonary Chronic obstructive pulmonary disease (COPD) Pulmonary embolism (PE): Past PE Current PE (within 30 days)	5.8% (14/243) 14.8% (36/243) 91.7% (33/36) 8.3% (3/36)
Renal Chronic renal failure	2.5% (6/243)
Endocrine Diabetes: Type I Type II Hypercholesterolemia Hypothyroidism	13.6% (33/243) 9.1% (3/33) 90.9% (30/33) 31.7% (77/243) 11.1% (27/243)
Gastrointestinal Gastrointestinal bleeding	1.2% (3/243)
Neoplasms History of cancer Current cancer Chemotherapy in the last 12 months Undergone radiation treatment to the pelvis	16.9% (41/243) 7.3% (3/41) 2.4% (1/41) 14.6% (6/41)
Neurologic Stroke Transient ischemic attack (TIA) History of intracranial hemorrhage	2.5% (6/243) 2.5% (6/243) 0% (0/243)
Smoking status Never Past Current	62.1% (151/243) 24.7% (60/243) 13.2% (32/243)

Condition	Percent Patients (number/total number)
Hormone-based contraceptives (females only)	11.8% (20/170)
Hormone replacement therapy	8.2% (20/243)
IVC filter present prior to study procedure	13.6% (33/243)

Baseline venous clinical assessments, lesion characteristics, and venographic measurements are reported in Tables 3 and 4. Most patients had a VCSS pain score of 2 or greater (75.7%; 184/243); similarly, most patients had a CEAP “C” Classification of 3 or greater (95.5%; 232/243). Study lesions were predominately located in the left leg (86.0%; 209/243) and most commonly affected the common iliac vein (CIV; 88.1%; 214/243) and the external iliac vein (EIV; 51.9%; 126/243). By core laboratory assessment, prior to stent placement, the mean lesion length was 98.6 ± 69.8 mm and the mean MLD was $6.0 \text{ mm} \pm 5.3$ mm. Among study lesions, 23.3% (52/233) were characterized as total occlusions pre-procedure.

Table 3. Baseline venous clinical assessments of study legs from the VIVO Clinical Study

Assessment	Mean \pm SD (N, range) or Percent Patients (number/total number)
VCSS	8.0 ± 4.2 (243, 1-24)
VDS	
0	5.3% (13/243)
1	28.0% (68/243)
2	41.6% (101/243)
3	25.1% (61/243)
CEAP “C” Classification	
C0	0.4% (1/243)
C1	0.8% (2/243)
C2	3.3% (8/243)
C3	66.7% (162/243)
C4a	16.9% (41/243)
C4b	3.7% (9/243)
C5	2.9% (7/243)
C6	5.3% (13/243)
CIVIQ score	44.6 ± 23.5 (236, 1.3-98.8)

Table 4. VIVO Clinical Study baseline lesion characteristics and venographic measurements as reported by the core laboratory

Characteristic	Percent Patients (number/total number) or Mean \pm SD (N, range)
Study lesion side	
Left	86.0% (209/243)
Right	14.0% (34/243)
Study lesion location ^a	
Common iliac vein (CIV)	88.1% (214/243)
External iliac vein (EIV)	51.9% (126/243)
Common femoral vein (CFV)	22.6% (55/243)
Femoral vein (FV)	2.1% (5/243)
Presence of collateral vessels	59.1% (143/242)
Presence of filling defect	50.4% (122/242)
Presence of thrombus	40.0% (96/240)
Lesion extending into the inferior vena cava	2.9% (7/243)
Lesion extending below the level of the lesser trochanter	4.6% (11/238)
Lesion length (mm)	98.6 \pm 69.8 (232, 3.5-319)
MLD (mm)	6.0 \pm 5.3 (233, 0-22.9)
Total occlusion (i.e., MLD of 0 mm)	22.3% (52/233)

^a Lesions may involve more than one location; therefore, the total number of lesion locations is more than the total number of patients enrolled.

Study Devices

A total of 365 Zilver Vena Venous Stents were placed to treat patients with 243 lesions. Most procedures were accomplished via ipsilateral access (95.9%; 233/243). Most lesions were treated with one (57.2%; 139/243) or two (35.4%; 86/243) stents.

Subject Accountability

Overall, 243 patients were treated with the study device and formed the intent-to-treat (ITT) population; 240 patients had safety data available at 30 days

for the primary safety analysis. At 12 months, 189 patients had venographic data available for the primary effectiveness analysis. One patient died prior to the 12-month follow-up. In addition, prior to 12-month follow-up, 3 patients withdrew from the study, 10 patients were lost-to-follow-up, and 1 patient exited the study after surgical removal of the study stent. By study completion, 20 additional patients were withdrawn, 14 additional patients were lost-to-follow-up, 2 additional patients exited before completing all elements of the final study visit, and 4 additional patients died.

Results

Safety

The analysis of the primary safety endpoint for this study was based on a composite endpoint of 30-day freedom from MAEs. Safety data through 30 days post-procedure were available for 240 of the 243 VIVO Clinical Study patients. The 3 patients with missing data included 2 patients who exited the study before 30 days without experiencing a MAE and 1 patient who was excluded from the analysis due to a technical failure (stent placement in an unintended vein). The 30-day freedom from MAE rate for the analyzable population was 96.7% (232/240; Table 5), and the lower limit of the 95% confidence interval (CI) was 93.5%, which is greater than the performance goal of 87% ($p < 0.0001$).

Table 5. VIVO Clinical Study primary safety endpoint (analyzable population)

30-day Freedom from MAE Rate (%; number/total number)	95% Exact CI	Performance Goal	P-value
96.7% (232/240)	93.5%-98.6%	87%	<0.0001

In total, 8 patients experienced an MAE through 30 days. Table 6 summarizes these events, as well as all MAEs reported through 3 years. In total, 26 MAEs have been reported through 3 years. Clinically driven reinterventions of the target lesion accounted for the majority (n=16) of MAEs. The clinical migration was a stent migration to a patient’s heart that required surgical removal; the CEC adjudicated this as technique-related (the stent was undersized). Although the stent migration was not identified until the 6-month imaging (x-ray and ultrasound), the migration was considered to have occurred on the day of the procedure. After an unsuccessful endovascular attempt to remove the migrated stent, the stent was removed from the pulmonary artery through sternotomy. The patient was reported to have developed atrial flutter 23 days after undergoing open surgery to remove the migrated stent.

Table 6. MAEs reported through 3 years in the VIVO Clinical Study

Major Adverse Event (MAE)	Number of MAEs				Total
	0-30 days	31-365 days	366-730 days	>730 days	
Clinically driven target lesion reintervention	7	3	5	1	16
New symptomatic pulmonary embolism	1	1	1	6	9
Clinical migration	0	1	0	0	1
Procedure- or device-related death	0	0	0	0	0
Procedural bleeding requiring transfusion	0	0	0	0	0
Procedure-related perforation requiring open surgical repair	0	0	0	0	0
Flow-limiting dissection of the target vessel	0	0	0	0	0
Total	8	5	6	7	26

Note: bleeding events occurring prior to study enrollment, and related to procedures such as thrombolysis or thrombectomy, are not considered procedural bleeding events.

Table 7 provides a summary of all VIVO Clinical Study adverse events reported through 3 years. There were no unanticipated adverse device effects observed during the study. Overall, 5 patient deaths through 3 years were reported; the CEC adjudicated all mortalities as not related to the study device or procedure.

Table 7. All adverse events reported through 3 years in the VIVO Clinical Study

Event Type	Percent Patients (number/total number)				Total Number of Events
	0-30 days	31-365 days	366-730 days	>730 days	
Access site/incision events	0.8% (2/243)	0.4% (1/241)	0% (0/220)	0% (0/207)	3
Infection requiring intervention	0.4% (1/243)	0% (0/241)	0% (0/220)	0% (0/207)	1
Hematoma requiring intervention	0.4% (1/243)	0.4% (1/241)	0% (0/220)	0% (0/207)	2
Abscess formation requiring intervention	0% (0/243)	0% (0/241)	0% (0/220)	0% (0/207)	0
Bleeding requiring transfusion	0% (0/243)	0% (0/241)	0% (0/220)	0% (0/207)	0
Cardiovascular	1.2% (3/243)	2.9% (7/241)	1.8% (4/220)	1.9% (4/207)	19
Cardiac arrhythmia requiring intervention	0.4% (1/243)	0.4% (1/241)	0.5% (1/220)	0.5% (1/207)	4
Chest pain	0.8% (2/243)	2.1% (5/241)	1.4% (3/220)	1.4% (3/207)	13
Myocardial infarction (MI)	0% (0/243)	0.8% (2/241)	0% (0/220)	0% (0/207)	2
Cerebrovascular/neurologic	0% (0/243)	0.4% (1/241)	0% (0/220)	0.5% (1/207)	2
Stroke	0% (0/243)	0.4% (1/241)	0% (0/220)	0.5% (1/207)	2
Pulmonary	1.6% (4/243)	2.1% (5/241)	2.3% (5/220)	4.3% (9/207)	24
Pulmonary embolism (PE)	0.4% (1/243)	0.4% (1/241)	0.5% (1/220)	2.9% (6/207)	9
Shortness of breath	1.6% (4/243)	1.7% (4/241)	1.8% (4/220)	1.4% (3/207)	15
Renal	0% (0/243)	0.4% (1/241)	0.5% (1/220)	0% (0/207)	2
Renal failure requiring intervention	0% (0/243)	0.4% (1/241)	0.5% (1/220)	0% (0/207)	2

Event Type	Percent Patients (number/total number)				Total Number of Events
	0-30 days	31-365 days	366-730 days	>730 days	
Vascular	5.3% (13/243)	8.3% (20/241)	8.6% (19/220)	2.9% (6/207)	72
Arteriovenous fistula	0% (0/243)	0% (0/241)	0% (0/220)	0% (0/207)	0
Embolism	0% (0/243)	0% (0/241)	0.5% (1/220)	0% (0/207)	3
Hypertension requiring intervention	0% (0/243)	0.4% (1/241)	0.5% (1/220)	0% (0/207)	3
Hypotension requiring intervention	0% (0/243)	0% (0/241)	0% (0/220)	0.5% (1/207)	1
Occlusion	4.9% (12/243)	4.1% (10/241)	3.6% (8/220)	1.0% (2/207)	34
Pseudoaneurysm	0% (0/243)	0.4% (1/241)	0.5% (1/220)	0% (0/207)	2
Restenosis	0% (0/243)	2.9% (7/241)	2.7% (6/220)	1.0% (2/207)	17
Stasis ulcer of the study leg	0% (0/243)	2.1% (5/241)	0.5% (1/220)	1.0% (2/207)	9
Tissue necrosis of the study leg	0% (0/243)	0% (0/241)	0% (0/220)	0% (0/207)	0
Vascular injury	0.4% (1/243)	0% (0/241)	0.9% (2/220)	0% (0/207)	3
Miscellaneous	31.7% (77/243)	49.8% (120/241)	40.9% (90/220)	39.1% (81/207)	674
Bleeding associated with anticoagulant/antiplatelet therapy	8.2% (20/243)	5.4% (13/241)	2.7% (6/220)	1.9% (4/207)	47
Fever requiring treatment	0.4% (1/243)	0% (0/241)	0.5% (1/220)	0.5% (1/207)	3
Hypersensitivity/allergic reaction	3.7% (9/243)	0% (0/241)	0% (0/220)	0% (0/207)	9
Nausea requiring treatment	0.8% (2/243)	0% (0/241)	0% (0/220)	0.5% (1/207)	3
Septicemia/bacteremia	0% (0/243)	0.8% (2/241)	1.8% (4/220)	0.5% (1/207)	9

Event Type	Percent Patients (number/total number)				Total Number of Events
	0-30 days	31-365 days	366-730 days	>730 days	
Worsened pain of study leg	1.6% (4/243)	3.3% (8/241)	2.7% (6/220)	1.9% (4/207)	23
Abdominal pain	0.4% (1/243)	2.1% (5/241)	0.9% (2/220)	1.9% (4/207)	13
Back pain	2.5% (6/243)	2.5% (6/241)	0.5% (1/220)	1.0% (2/207)	15
Other	18.9% (46/243)	43.6% (105/241)	39.1% (86/220)	35.7% (74/207)	552

Note: Values in bold indicate total numbers of patients and events under each event type.

Effectiveness

The primary effectiveness endpoint of primary quantitative patency (> 50% of the immediate post-procedure stented MLD by venography) was evaluated at 12 months against the literature-derived performance goal of 76%. The statistical analysis plan pre-specified that missing data be addressed using multiple imputation with best-available data, case deletion, or other analyses (i.e. tipping point). The analysis plan specified assessment of patients with reinterventions within the treated venous segment as follows in relation to the primary effectiveness endpoint: failures were patients presenting with an MLD \leq 50% of the immediate post-procedure stented MLD at reintervention occurring \leq 410 days post-procedure, successes were patients presenting with an MLD > 50% of the immediate post-procedure stented MLD at reintervention occurring \geq 320 days, and missing were patients presenting with an MLD > 50% of the immediate post-procedure stented MLD at reintervention < 320 days.

Table 8 presents the results of analysis. The analysis was based on 189 patients with venographic primary patency outcome data (181 patients with core laboratory assessed venogram results and 8 patients with site assessed venogram results) and 54 patients with imputed outcomes. The 12-month primary quantitative patency rate was 89.9%, and the lower limit of the 95% CI was 85.1%, which is greater than the performance goal of 76% ($p < 0.0001$).

Table 8. VIVO Clinical Study primary effectiveness endpoint (intent-to-treat population)

12-Month Quantitative Patency (%)	95% CI	Performance Goal	P-value
89.9%	85.1%-93.4%	76%	<0.0001

Similar results were obtained for patients with venographic primary patency outcome data, or the analyzable population (N=189 patients). As presented in Table 9, the 12-month primary quantitative patency rate for the analyzable population was 89.9% (170/189), and the lower limit of the 95% CI was 84.7%, which is greater than the performance goal of 76% ($p < 0.0001$).

Table 9. VIVO Clinical Study primary effectiveness endpoint (analyzable population)

12-month Quantitative Patency (%; number/ total number)	95% Exact CI	Performance Goal	P-value
89.9% (170/189)	84.7%-93.8%	76%	<0.0001

Secondary Endpoint

The secondary hypothesis was the change in VCSS from baseline to 1 month and 12 months. The results for the change in VCSS from baseline to 1 month, 12 months, 2 years, and 3 years are provided in Table 10 and in the box plot provided in Figure 13. The mean VCSS was significantly ($p < 0.0001$) improved at 1 month and 12 months as compared to baseline (i.e., prior to stent placement); therefore, the null hypothesis at both 1 month and 12 months is rejected. The improvement in VCSS was sustained through 2 years and 3 years post-treatment.

Table 10. VIVO Clinical Study secondary endpoint (change in VCSS from baseline)

VCSS Assessment Time Point	VCSS Mean \pm SD (N, range)	VCSS Change from Baseline Mean (N, 95% CI)	P-value ^a	Accept/Reject Null Hypothesis
Baseline	8.0 \pm 4.2 (243, 1-24)	NA	NA	NA
1 month	5.0 \pm 4 (233, 0-23)	-3.0 (233, -3.5 to -2.6)	<0.0001	Reject
12 months	3.8 \pm 4 (202, 0-27)	-4.2 (202, -4.7 to -3.7)	<0.0001	Reject
2 years	3.7 \pm 3.5 (190, 0-20)	-4.2 (190, -4.8 to -3.7)	NA	NA
3 years	3.7 \pm 3.6 (173, 0-21)	-4.1 (173, -4.6 to -3.5)	NA	NA

^a p-values adjusted for multiplicity using Holm’s procedure.

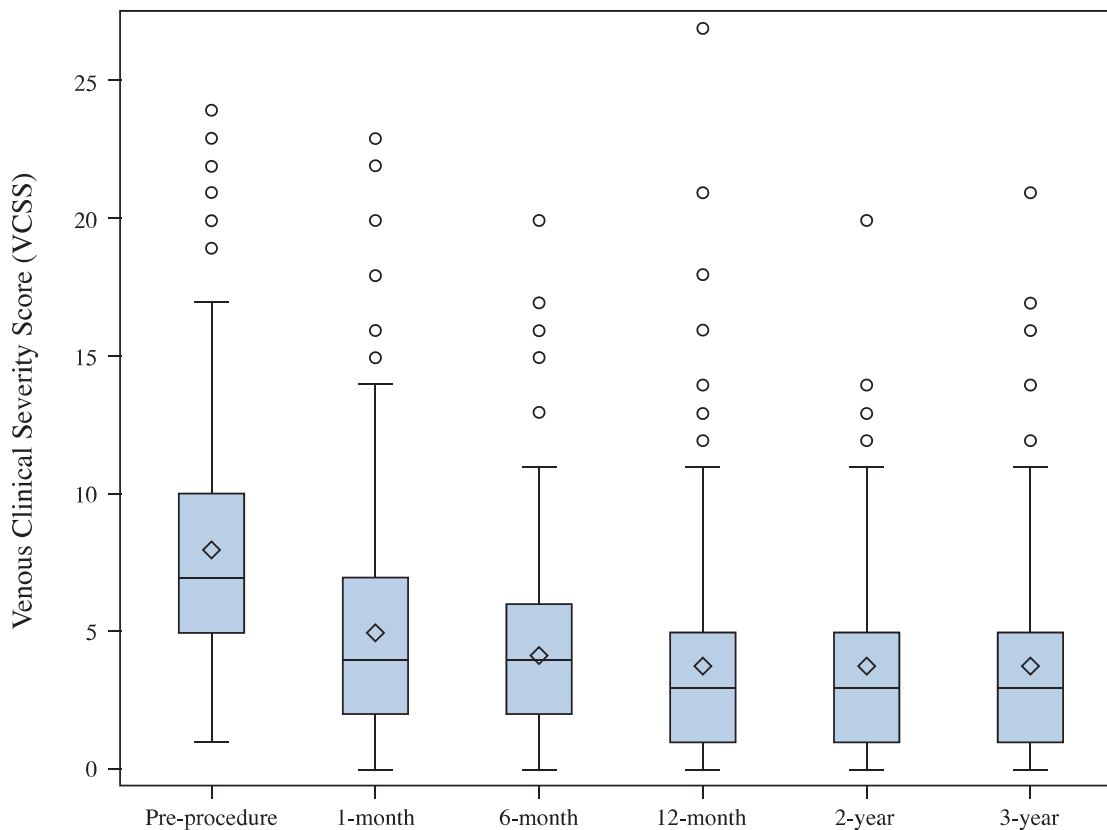

Figure 13. VIVO Clinical Study secondary endpoint (change in VCSS from baseline)

Additional Measures without Hypothesis Testing

The additional measures included many device-related effectiveness measures and clinical benefit measures including technical success, procedural success,

device integrity, device migration, rate of freedom from clinically driven reintervention, rate of freedom from reintervention, rate of primary quantitative patency, rate of patency by ultrasound, rate of assisted primary quantitative patency, rate of secondary quantitative patency, rate of clinical patency, rate of modified clinical patency, and change in VDS, CEAP “C” classification, and CIVIQ scores from baseline. Additional measures were not hypothesis driven; descriptive statistics are presented.

Procedural success measures included technical success (ability to deliver and deploy the study stent in the intended location) and procedural success (improved flow through the target vessel demonstrated by diminished flow through collateral vein and/or reduced filling defect in the target vessel and no MAE before discharge). Technical success was assessed for all study stents and was reported based on site assessment. The rate of technical success was 97.3% (355/365 stents). Procedural success was assessed for all patients with evidence of collateral veins or filling defect in the target vessel at the time of the procedure, and any patient with an MAE before discharge was considered a failure. Procedure success included core laboratory assessment of procedure imaging. The rate of procedural success was 96.7% (175/181 patients).

Table 11 summarizes the Kaplan-Meier estimates for freedom from stent fracture and stent migration through 3 years. The core laboratory reported no stent fractures through 3 years and 1 stent migration through 3 years. The stent migration was the clinical migration of the study stent to the patient’s heart, as described above in the Safety Results.

Table 11. Device Measures

X-Ray Assessment Time Point	Freedom from Stent Fracture Kaplan-Meier Estimate ± SD	Freedom from Stent Migration Kaplan-Meier Estimate ± SD
0 days	100%	100%
12 months	100%	99.7% ± 0.3%
2 years	100%	99.7% ± 0.3%
3 years	100%	99.7% ± 0.3%

The 12-month quantitative patency outcome measures are reported in Table 12, and the reintervention and patency outcome measures through 3 years are reported in Table 13. The results support the effectiveness of the stent.

Table 12. 12-month (through 410 days) Quantitative Patency Measures

Measure	Binary Rate	Kaplan-Meier Estimate \pm SD (n=243)
12-month rates of primary quantitative patency		
Overall study population	89.9% (170/189)	89.8% \pm 3.5%
Population classified as acute	86.3% (44/51)	88.7% \pm 5.2%
Population classified as chronic	91.3% (126/138)	90.4% \pm 4.0%
Population with past or current DVT at enrollment	85.3% (110/129)	85.0% \pm 5.3%
Population with no past or current DVT at enrollment	100% (60/60)	100%
12-month assisted primary quantitative patency	91.4% (170/186)	90.0% \pm 3.5%
12-month secondary quantitative patency	98.9% (185/187)	98.9% \pm 0.7%

Table 13. Reintervention and Patency Measures Through 3 Years

Measure	Binary Rate	Kaplan-Meier Estimate \pm SD (n=243)
12-month Outcomes (through 410 days)		
12-month rate of freedom from clinically driven reintervention ^a	94.8% (201/212)	95.3% \pm 1.5%
12-month rate of freedom from reintervention ^b	85.8% (188/219)	86.7% \pm 2.3%
12-month patency by ultrasound	91.2% (187/205)	92.0% \pm 2.0%
12-month clinical patency	79.4% (166/209)	80.7% \pm 2.8%
12-month modified clinical patency	87.5% (182/208)	88.3% \pm 2.3%
2-year Outcomes (through 730 days)		
2-year rate of freedom from clinically driven reintervention ^a	92.0% (173/188)	93.2% \pm 1.8%
2-year rate of freedom from reintervention ^b	81.9% (172/210)	83.4% \pm 2.5%
2-year patency by ultrasound	88.5% (161/182)	90.3% \pm 2.2%

Measure	Binary Rate	Kaplan-Meier Estimate ± SD (n=243)
2-year clinical patency	72.7% (133/183)	76.8% ± 3.0%
2-year modified clinical patency	82.4% (145/176)	85.6% ± 2.6%
3-year Outcomes (through 1,095 days)		
3-year rate of freedom from clinically driven reintervention ^a	90.2% (147/163)	92.6% ± 2.0%
3-year rate of freedom from reintervention ^b	78.9% (146/185)	82.9% ± 2.6%
3-year patency by ultrasound	85.9% (128/149)	90.3% ± 2.2%
3-year clinical patency	66.7% (108/162)	74.4% ± 3.3%
3-year modified clinical patency	75.8% (116/153)	81.5% ± 3.6%

^aClinically driven reinterventions were reinterventions performed in patients with recurrent symptoms of venous outflow obstruction of the target lesion and with venography showing a treated venous segment (including the region within ± 1 cm proximal and/or distal to the treated venous segment) minimum lumen diameter (MLD) ≤ 50% of the immediate post-procedure stented MLD. Most commonly, the clinical symptom in these patients was edema or pain.

^bReinterventions were any endovascular or surgical intervention performed in a treated venous segment (including the region within ± 1 cm proximal and/or distal to the treated venous segment). Reinterventions were those treatments in the treated venous segment when the MLD was >50% of the immediate post-procedure stented MLD or treatments reported outside the treated venous segment, in the presence or absence of clinical symptoms.

Table 14 presents the clinical outcome measures of VDS, CEAP “C,” and CIVIQ through 3 years. The outcomes reflect that observed for the change in VCSS; stent placement resulted in clinical improvement, as demonstrated by improvement in each clinical score following stent placement. Specifically, the number of patients with a VDS of 2 or 3 or a CEAP “C3” classification decreased dramatically from pre-procedure to 1 month, with continued or maintained improvement through 3 years. Likewise, an improvement in the mean CIVIQ score was observed at 1 month, with continued or maintained improvement through 3 years following stent placement.

Table 14. VIVO Clinical Study clinical outcome measures

Clinical Measure	Timepoint				
	Pre-procedure	1 Month	12 Months	2 Years	3 Years
VDS (percent patients [number/total number])					
0	5.3% (13/243)	40.8% (95/233)	55.0% (111/202)	53.2% (101/190)	57.2% (99/173)
1	28.0% (68/243)	34.3% (80/233)	27.7% (56/202)	31.6% (60/190)	28.3% (49/173)
2	41.6% (101/243)	21.5% (50/233)	14.4% (29/202)	13.7% (26/190)	11.6% (20/173)
3	25.1% (61/243)	3.4% (8/233)	3.0% (6/202)	1.6% (3/190)	2.9% (5/173)
CEAP "C" Classification (percent patients [number/total number])					
C0	0.4% (1/243)	25.3% (59/233)	36.1% (73/202)	30.0% (57/190)	27.7% (48/173)
C1	0.8% (2/243)	9.0% (21/233)	14.9% (30/202)	11.6% (22/190)	12.7% (22/173)
C2	3.3% (8/243)	7.3% (17/233)	9.9% (20/202)	11.6% (22/190)	12.1% (21/173)
C3	66.7% (162/243)	34.3% (80/233)	20.8% (42/202)	29.5% (56/190)	30.6% (53/173)
C4a	16.9% (41/243)	13.7% (32/233)	13.4% (27/202)	10.5% (20/190)	10.4% (18/173)
C4b	3.7% (9/243)	4.3% (10/233)	1.5% (3/202)	2.1% (4/190)	1.7% (3/173)
C5	2.9% (7/243)	3.4% (8/233)	1.5% (3/202)	2.6% (5/190)	2.3% (4/173)
C6	5.3% (13/243)	2.6% (6/233)	2.0% (4/202)	2.1% (4/190)	2.3% (4/173)
CIVIQ Score (mean [N; 95%CI])					
Mean change from baseline	NA	-20.5 (209; -23.6 to -17.3)	-22.6 (168; -26.2 to -19.0)	-22.1 (155; -26.0 to -18.2)	-20.8 (131; -24.8 to -16.8)

NA = not applicable

Conclusion

The Evaluation of the Zilver Vena Venous Stent in the Treatment of Symptomatic Iliofemoral Venous Outflow Obstruction (VIVO) Clinical Study was a prospective, global, multicenter, nonrandomized, single-arm clinical study that compared primary safety and effectiveness outcomes to performance goals derived from the published literature to demonstrate the safety and effectiveness of the Zilver Vena Venous Stent. The secondary endpoint evaluated the change in VCSS from baseline.

The primary safety and effectiveness endpoints were demonstrated to have statistical difference from the established performance goals. The change in VCSS from baseline to 1 month and baseline to 12 months was statistically significant, with continued or maintained improvement through 3 years. In addition, the Zilver Vena Venous Stent demonstrated high rates of technical and procedural success, with no core laboratory reported fractures through 3 years. Finally, the data for freedom from reintervention and change in clinical scores (VDS, CEAP "C", and CIVIQ) through 3 years demonstrates the sustained effect of the Zilver Vena Venous Stent.

The VIVO Clinical Study provides scientific evidence that the Zilver Vena Venous Stent is safe and effective for the treatment of patients with symptomatic iliofemoral venous outflow obstruction.

VIVO-EU Clinical Study

Study Design

The VIVO-EU Clinical Study was a prospective, nonrandomized, multicenter study in Europe that enrolled patients with symptomatic obstruction in up to two iliofemoral venous segments. The study was designed to assess the performance of the Zilver Vena Venous Stent in the treatment of patients with symptomatic iliofemoral venous outflow obstruction.

A total of 35 patients were enrolled at five European sites. The study entry criteria were similar to the VIVO Clinical Study with the exception that there was no limitation associated with significant obstruction or occlusion of the inflow or outflow tract, and inclusion of bilateral limbs with obstruction and malignant obstruction was allowed. Patient follow-up included clinical assessments at 1, 6, and 12 months and noninvasive ultrasound at 6 and 12 months. Study assessments included: 1) procedural success; 2) MAEs; 3) qualitative patency at 6 and 12 months post-procedure; 4) clinical symptoms of venous insufficiency at 1, 3, 6, 9, and 12 months post-procedure; and 5) reintervention within the treated venous segment. An independent core laboratory was used for image analysis. Study follow-up is complete.

Demographics

Most patients were female (77.1%; 27/35) and white/Caucasian (68.6%; 24/35), and more than half of the study population had acute or chronic DVT (62.9%; 22/35). Patients had a mean age of 45.1 ± 15.5 years. Lesions were predominantly left-sided (94.1%; 32/35) and most commonly affected the common iliac vein (94.1%; 32/35) and external iliac vein (38.2%; 13/35). The mean lesion length was $89.3 \text{ mm} \pm 58.6 \text{ mm}$ based on core laboratory assessment. In total, 45 Zilver Vena Venous Stents were implanted to treat study patients' iliofemoral venous lesions.

Results

MAEs were defined as procedural bleeding requiring transfusion, procedure- or device-related death, clinically driven target lesion reintervention for occlusion, stent migration requiring an intervention, procedure- or device-related symptomatic pulmonary embolism, or procedure-related uncorrectable perforation or flow-limiting dissection of the target vessel. In total, three MAEs were reported in the study including two clinically driven reinterventions for occlusion and one procedure- or device-related symptomatic pulmonary embolism.

Freedom from occlusion (lack of occlusion of the treated venous segment by evidence of blood flow proximal, within, and distal to the study lesion) was determined by Kaplan-Meier estimate. The 6-month and 12-month rate of freedom from occlusion was 88.2%

Qualitative patency (defined as a lack of occlusion of the treated venous segment determined by evidence of blood flow both proximal and distal to the study lesion assessed via ultrasound and/or venography and no worsening of pain or edema symptoms from baseline [according to VCSS]) was similarly determined by Kaplan-Meier estimate. The 6-month rate of qualitative patency was 88.2% and the 12-month rate of qualitative patency was 85.2%.

In total, seven reinterventions were reported in five patients; reinterventions occurred between 4 and 392 days after stent placement. Clinical measures included VCSS, VDS, CEAP "C" classification, and CIVIQ score. Stent placement resulted in clinical improvement, as demonstrated by improvement in each respective clinical score following stent placement, which was maintained through 12 months.

In conclusion, the results from the VIVO-EU Clinical Study provide supportive evidence confirming the safety and effectiveness of the Zilver Vena Venous Stent for the treatment of patients with symptomatic iliofemoral venous outflow obstruction.

REFERENCES

These instructions for use are based on experience from physicians and (or) their published literature. Refer to your local Cook sales representative for information on available literature.



This symbol on the label indicates that this device contains phthalates. Specific phthalates contained in the device are identified beside or below the symbol by the following acronyms:

- BBP: Benzyl butyl phthalate**
- DBP: Di-n-butyl phthalate**
- DEHP: Di(2-ethylhexyl) phthalate**
- DIDP: Diisodecyl phthalate**
- DINP: Diisononyl phthalate**
- DIPP: Diisopentyl phthalate**
- DMEP: Di(methoxyethyl) phthalate**
- DNOP: Di-n-octyl phthalate**
- DNPP: Di-n-pentyl phthalate**

The potential effects of phthalates on pregnant/ nursing women or children have not been fully characterized and there may be concern for reproductive and developmental effects.

Rx ONLY

STERILE	EO
---------	----



COOK IRELAND LTD.
O'Halloran Road
National Technology Park
Limerick, Ireland

www.cookmedical.com

© COPYRIGHT COOK 2020 ©

IFU0091-7

2020-10