

Integrating the Healthcare Enterprise



5

**IT Infrastructure
Technical Framework**

10

**Volume 2b
(ITI TF-2b)
Transactions Part B –
Sections 3.29 – 3.43**

15

**Revision 7.0 – Final Text
August 10, 2010**

20

Contents

	1	Introduction.....	4
25	1.1	Overview of the Technical Framework	4
	1.2	Overview of IT Infrastructure Technical Framework Volumes 2a, 2b, 2x, and 3	5
	1.3	Audience.....	5
	1.4	Relationship to Standards	6
	1.5	Relationship to Real-world Architectures	6
30	1.6	Comments.....	7
	1.7	Copyright Permission	7
	2	Conventions	8
	2.1	The Generic IHE Transaction Model	8
	2.2	HL7 Profiling Conventions	9
35	2.3	Use of Coded Entities and Coding Schemes	9
	3	IHE Transactions	10
	3.29	Intentionally Left Blank	10
	3.30	Patient Identity Management.....	10
	3.30.1	Scope.....	10
40	3.30.2	Use Case Roles	10
	3.30.3	Referenced Standards.....	11
	3.30.4	Message sets and options	11
	3.30.5	Common HL7 Message Segments.....	11
	3.30.6	Interactions.....	27
45	3.31	Patient Encounter Management.....	34
	3.31.1	Scope.....	34
	3.31.2	Use Case Roles	35
	3.31.3	Referenced Standards.....	35
	3.31.4	Definition of the concept “Movement”	35
50	3.31.5	Message sets and options	36
	3.31.6	Common HL7 Message Segments.....	42
	3.31.7	Interactions.....	43
	3.32	Distribute Document Set on Media	79
	3.32.1	Scope.....	79
55	3.32.2	Use Case Roles	80
	3.32.3	Referenced Standard	80
	3.32.4	Interaction Diagram.....	80
	3.33	Intentionally Left Blank	88
	3.34	Intentionally Left Blank	88
60	3.35	Intentionally Left Blank	88
	3.36	Intentionally Left Blank	88
	3.37	Intentionally Left Blank	88
	3.38	Intentionally Left Blank	88
	3.39	Intentionally Left Blank	88
65	3.40	Provide X-User Assertion.....	88
	3.40.1	Scope.....	88

	3.40.2 Use Case Roles	88
	3.40.3 Referenced Standards	89
	3.40.4 Interaction Diagram.....	90
70	3.41 Provide and Register Document Set-b	93
	3.41.1 Scope.....	94
	3.41.2 Use Case Roles	94
	3.41.3 Referenced Standards.....	95
	3.41.4 Interaction Diagrams	95
75	3.41.5 Protocol Requirements	99
	3.41.6 Actor Requirements.....	102
	3.41.7 Security Considerations.....	103
	3.42 Register Document Set-b.....	106
	3.42.1 Scope	107
80	3.42.2 Use Case Roles.....	107
	3.42.3 Referenced Standards	107
	3.42.4 Interaction Diagram.....	108
	3.42.5 Protocol Requirements	110
	3.42.6 Actor Requirements.....	112
85	3.42.7 Security Considerations.....	112
	3.43 Retrieve Document Set.....	115
	3.43.1 Scope	115
	3.43.2 Use Case Roles.....	116
	3.43.3 Referenced Standard	116
90	3.43.4 Interaction Diagram.....	116
	3.43.5 Protocol Requirements	119
	3.43.6 Security Considerations.....	123

1 Introduction

95 Integrating the Healthcare Enterprise (IHE) is an initiative designed to stimulate the integration
of the information systems that support modern healthcare institutions. Its fundamental objective
is to ensure that in the care of patients all required information for medical decisions is both
correct and available to healthcare professionals. The IHE initiative is both a process and a
forum for encouraging integration efforts. It defines a technical framework for the
100 implementation of established messaging standards to achieve specific clinical goals. It includes
a rigorous testing process for the implementation of this framework. And it organizes
educational sessions and exhibits at major meetings of medical professionals to demonstrate the
benefits of this framework and encourage its adoption by industry and users.

The approach employed in the IHE initiative is to support the use of existing standards, e.g HL7,
105 ASTM, DICOM, ISO, IETF, OASIS and others as appropriate, rather than to define new
standards. IHE profiles further constrain configuration choices where necessary in these
standards to ensure that they can be used in their respective domains in an integrated manner
between different actors. When clarifications or extensions to existing standards are necessary,
IHE refers recommendations to the relevant standards bodies.

110 This initiative has numerous sponsors and supporting organizations in different medical specialty
domains and geographical regions. In North America the primary sponsors are the Healthcare
Information and Management Systems Society (HIMSS) and the Radiological Society of North
America (RSNA). IHE Canada has also been formed. IHE Europe (IHE-EUR) is supported by a
large coalition of organizations including the European Association of Radiology (EAR) and
115 European Congress of Radiologists (ECR), the Coordination Committee of the Radiological and
Electromedical Industries (COCIR), Deutsche Röntgengesellschaft (DRG), the EuroPACS
Association, Groupement pour la Modernisation du Système d'Information Hospitalier
(GMSIH), Société Française de Radiologie (SFR), Società Italiana di Radiologia Medica
(SIRM), and the European Institute for health Records (EuroRec). In Japan IHE-J is sponsored
120 by the Ministry of Economy, Trade, and Industry (METI); the Ministry of Health, Labor, and
Welfare; and MEDIS-DC; cooperating organizations include the Japan Industries Association of
Radiological Systems (JIRA), the Japan Association of Healthcare Information Systems Industry
(JAHIS), Japan Radiological Society (JRS), Japan Society of Radiological Technology (JSRT),
and the Japan Association of Medical Informatics (JAMI). Other organizations representing
125 healthcare professionals are invited to join in the expansion of the IHE process across
disciplinary and geographic boundaries.

1.1 Overview of the Technical Framework

This document, the IHE IT Infrastructure Technical Framework (ITI TF), defines specific
implementations of established standards to achieve integration goals that promote appropriate
130 sharing of medical information to support optimal patient care. It is expanded annually, after a
period of public review, and maintained regularly through the identification and correction of
errata. The current version, Rev. 7.0 for Final Text, specifies the IHE transactions defined and
implemented as of August 2009. The latest version of the document is always available via the
Internet at http://www.ihe.net/Technical_Framework.

135 The IHE IT Infrastructure Technical Framework identifies a subset of the functional components of the healthcare enterprise, called IHE actors, and specifies their interactions in terms of a set of coordinated, standards-based transactions. It describes this body of transactions in progressively greater depth. Volume 1 (ITI TF-1) provides a high-level view of IHE functionality, showing the transactions organized into functional units called integration profiles that highlight their capacity to address specific IT Infrastructure requirements.

140 Volumes 2a, 2b, and 2x of the IT Infrastructure Technical Framework provides detailed technical descriptions of each IHE transaction used in the IT Infrastructure Integration Profiles. Volume 3 contains content specification and specifications used by multiple transactions. These volumes are consistent and can be used in conjunction with the Integration Profiles of other IHE domains.

145 The other domains within the IHE initiative also produce Technical Frameworks within their respective areas that together form the IHE Technical Framework. For example, the following IHE Technical Framework(s) are some of those which are available:

IHE IT Infrastructure Technical Framework

IHE Cardiology Technical Framework

150 IHE Laboratory Technical Framework

IHE Patient Care Coordination Technical Framework

IHE Radiology Technical Framework

Where applicable, references are made to other technical frameworks. For the conventions on referencing other frameworks, see ITI TF-2a: 1.6.3.

155 **1.2 Overview of IT Infrastructure Technical Framework Volumes 2a, 2b, 2x, and 3**

The remainder of Section 1 further describes the general nature, purpose and function of the Technical Framework. Section 2 presents the conventions used in this volume to define IHE transactions.

160 Section 3 defines transactions in detail, specifying the roles for each Actor, the standards employed, the information exchanged, and in some cases, implementation options for the transaction. Section 3 is divided into two parts:

- Volume 2a: Sections 3.1 - 3.28 corresponding to transactions [ITI-1] through [ITI-28].
- Volume 2b: Sections 3.29 - 3.57 corresponding to transactions [ITI-29] through [ITI-57].

165 Volume 2x contains all appendices providing technical details associated with the transactions.

Volume 3, Section 4 contains specifications that are used by multiple transactions.

Volume 3, Section 5 contains Content Specifications.

1.3 Audience

The intended audience of this document is:

170 IT departments of healthcare institutions

Technical staff of vendors planning to participate in the IHE initiative

Experts involved in standards development

Those interested in integrating healthcare information systems and workflows

1.4 Relationship to Standards

175 The IHE Technical Framework identifies functional components of a distributed healthcare
environment (referred to as IHE actors), solely from the point of view of their interactions in the
healthcare enterprise. At its current level of development, it defines a coordinated set of
transactions based on ASTM, DICOM, HL7, IETF, ISO, OASIS and W3C standards. As the
180 scope of the IHE initiative expands, transactions based on other standards may be included as
required.

In some cases, IHE recommends selection of specific options supported by these standards;
however, IHE does not introduce technical choices that contradict conformance to these
standards. If errors in or extensions to existing standards are identified, IHE's policy is to report
them to the appropriate standards bodies for resolution within their conformance and standards
185 evolution strategy.

IHE is therefore an implementation framework, not a standard. Conformance claims for products
must still be made in direct reference to specific standards. In addition, vendors who have
implemented IHE integration capabilities in their products may publish IHE Integration
Statements to communicate their products' capabilities. Vendors publishing IHE Integration
190 Statements accept full responsibility for their content. By comparing the IHE Integration
Statements from different products, a user familiar with the IHE concepts of actors and
integration profiles can determine the level of integration between them. See ITI TF-2x:
Appendix C for the format of IHE Integration Statements.

1.5 Relationship to Real-world Architectures

195 The IHE actors and transactions described in the IHE Technical Framework are abstractions of
the real-world healthcare information system environment. While some of the transactions are
traditionally performed by specific product categories (e.g., HIS, Clinical Data Repository,
Radiology Information Systems, Clinical Information Systems or Cardiology Information
Systems), the IHE Technical Framework intentionally avoids associating functions or actors with
200 such product categories. For each Actor, the IHE Technical Framework defines only those
functions associated with integrating information systems. The IHE definition of an Actor should
therefore not be taken as the complete definition of any product that might implement it, nor
should the framework itself be taken to comprehensively describe the architecture of a healthcare
information system.

205 The reason for defining actors and transactions is to provide a basis for defining the interactions
among functional components of the healthcare information system environment. In situations
where a single physical product implements multiple functions, only the interfaces between the
product and external functions in the environment are considered to be significant by the IHE
initiative. Therefore, the IHE initiative takes no position as to the relative merits of an integrated
210 environment based on a single, all-encompassing information system versus one based on
multiple systems that together achieve the same end. IHE demonstrations emphasize the
integration of multiple vendors' systems based on the IHE Technical Framework.

1.6 Comments

HIMSS and RSNA welcome comments on this document and IHE. Please direct to:

215 Lisa Spellman
Senior Director Informatics
230 East Ohio St., Suite 500, Chicago, IL USA 60611
Email: ihe@himss.org

1.7 Copyright Permission

220 Health Level Seven, Inc., has granted permission to the IHE to reproduce tables from the HL7 standard. The HL7 tables in this document are copyrighted by Health Level Seven, Inc. All rights reserved. Material drawn from these documents is credited where used.

2 Conventions

225 This document has adopted the following conventions for representing the framework concepts and specifying how the standards upon which the IHE IT Infrastructure Technical Framework is based should be applied.

2.1 The Generic IHE Transaction Model

Transaction descriptions are provided in Section 3. In each transaction description, the actors, the roles they play, and the transactions between them are presented as use cases.

230 The generic IHE transaction description includes the following components:

Scope: a brief description of the transaction.

Use case roles: textual definitions of the actors and their roles, with a simple diagram relating them, e.g.,:

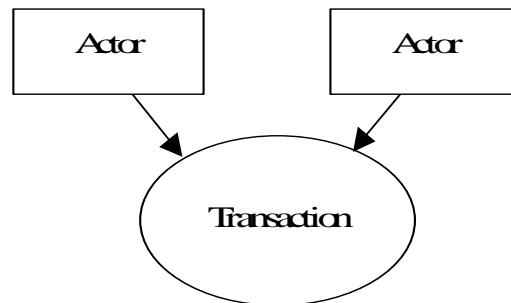

235 *Referenced Standards*: the standards (stating the specific parts, chapters or sections thereof) to be used for the transaction.

Interaction Diagram: a graphical depiction of the actors and messages that support the transaction, with related processing within an Actor shown as a rectangle and time progressing downward, similar to:

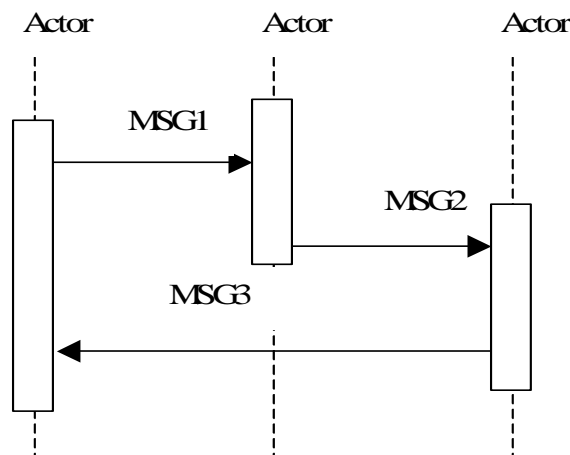

240

245 The interaction diagrams used in the IHE IT Infrastructure Technical Framework are modeled after those described in Grady Booch, James Rumbaugh, and Ivar Jacobson, *The Unified Modeling Language User Guide*, ISBN 0-201-57168-4. Simple acknowledgment messages are often omitted from the diagrams for brevity. One or more messages may be required to satisfy a transaction. Each message is represented as an arrow starting from the Actor initiating the message.

250 *Message definitions*: descriptions of each message involved in the transaction, the events that trigger the message, its semantics, and the actions that the message triggers in the receiver.

2.2 HL7 Profiling Conventions

See ITI TF-2x: Appendix C for the HL7 profiling conventions as well as the networking implementation guidelines.

2.3 Use of Coded Entities and Coding Schemes

255 IHE does not produce, maintain or otherwise specify a coding scheme or other resource for controlled terminology (coded entities). Where applicable, coding schemes required by the HL7 and DICOM standards take precedence. In the cases where such resources are not explicitly identified by standards, implementations may utilize any resource (including proprietary or local) provided any licensing/copyright requirements are satisfied.

260 **3 IHE Transactions**

This section defines each IHE transaction in detail, specifying the standards used, the information transferred, and the conditions under which the transaction is required or optional.

3.29 Intentionally Left Blank

265

3.30 Patient Identity Management

This section corresponds to Transaction ITI-30, “Patient Identity Management” of the IHE IT Infrastructure Technical Framework. Transaction ITI-30 is used by the actors Patient Demographics Supplier and Patient Demographics Consumer.

270 **3.30.1 Scope**

This transaction transmits patient demographics in a patient identification domain (i.e., patient identifiers assigned by the same assigning authority).

275 The term “patient demographics” is intended to convey the patient identification and full identity and also information on persons related to this patient, such as primary caregiver, family doctor, guarantor, next of kin.

The transaction contains events for creating, updating, merging, linking and unlinking patients.

It enables the sending system to qualify the reliability of a patient identity, and the type of identity used (official name, alias for VIP, unknown patient).

280 The transaction can be used in acute care settings for both inpatients (i.e., those who are assigned a bed at the facility) and outpatients (i.e., those who are not assigned a bed at the facility).

The transaction can also be used in a pure ambulatory environment.

3.30.2 Use Case Roles

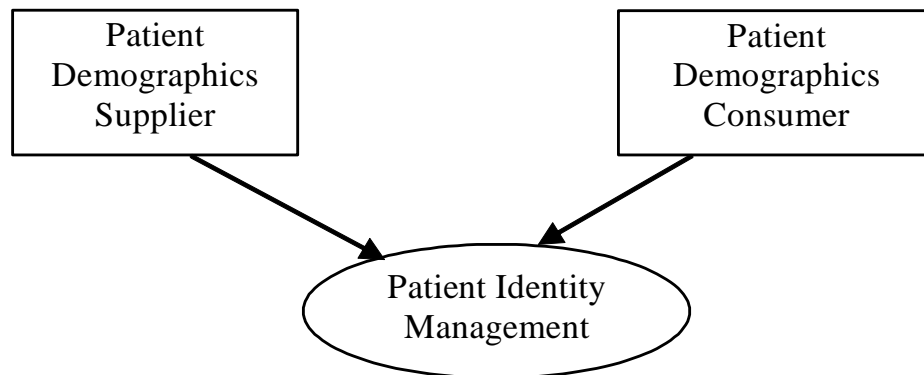

Actor: Patient Demographics Supplier

285 **Role:** Adds and modifies patient demographics.

Actor: Patient Demographics Consumer

Role: Receives patient demographics.

3.30.3 Referenced Standards

HL7 2.5 Chapters 2, 3, 6, 15

290 **3.30.4 Message sets and options**

Transaction ITI-30 supports two options, “Merge” and “Link/Unlink”, in order to accommodate the various methods used by healthcare organizations to reconcile duplicated identities.

Any Patient Demographics Supplier or Patient Demographics Consumer actor SHALL support at least one of the two options “Merge” and “Link/Unlink” or both, according to the IHE national extensions of this profile. Any implementation framework will mandate both actors to support the same option.

3.30.4.1 Required message subset with option “Merge”

Event	Trigger	Message Static definition
Create new patient	A28	ADT^A28^ADT_A05
Update patient information	A31	ADT^A31^ADT_A05
Change Patient Identifier List	A47	ADT^A47^ADT_A30
Merge two patients	A40	ADT^A40^ADT_A39

300 **3.30.4.2 Required message subset with option “Link/Unlink”**

Event	Trigger	Message Static definition
Create new patient	A28	ADT^A28^ADT_A05
Update patient information	A31	ADT^A31^ADT_A05
Change Patient Identifier List	A47	ADT^A47^ADT_A30
Link Patient Information	A24	ADT^A24^ADT_A24
Unlink Patient Information	A37	ADT^A37^ADT_A37

3.30.5 Common HL7 Message Segments

This section describes the common HL7 message segments used in Transaction 30.

Each table represents a segment. Fields for which a precise usage description is needed, particularly those having usage C (conditional), are commented on below the table. The optional fields are usually not commented on.

3.30.5.1 MSH - Message Header Segment

Standard Reference: HL7 Version 2.5, Chapter 2 (Section 2.15, “Message control”)

310 This segment defines the intent, supplier, destination, and some specifics of the syntax of the message. It also uniquely identifies the message itself and dates its production.

Table 3.30-1 MSH - Message Header

SEQ	LE N	DT	Usage	Card.	TBL #	ITEM#	Element name
1	1	SI	R	[1..1]		00001	Field Separator
2	4	ST	R	[1..1]		00002	Encoding Characters
3	227	HD	R	[1..1]		00003	Sending Application
4	227	HD	R	[1..1]		00004	Sending Facility
5	227	HD	R	[1..1]		00005	Receiving Application
6	227	HD	R	[1..1]		00006	Receiving Facility
7	26	TS	R	[1..1]		00007	Date/Time of Message
8	40	ST	X	[0..0]		00008	Security
9	15	MSG	R	[1..1]		00009	Message Type
10	20	ST	R	[1..1]		00010	Message Control Id
11	3	PT	R	[1..1]		00011	Processing Id
12	60	VID	R	[1..1]		00012	Version ID
13	15	NM	O	[0..1]		00013	Sequence Number
14	180	ST	X	[0..0]		00014	Continuation Pointer
15	2	ID	X	[0..0]	0155	00015	Accept Acknowledgement Type
16	2	ID	X	[0..0]	0155	00016	Application Acknowledgement Type
17	3	ID	RE	[1..1]	0399	00017	Country Code
18	16	ID	C	[0..1]	0211	00692	Character Set
19	250	CE	RE	[1..1]		00693	Principal Language of Message
20	20	ID	X	[0..0]	0356	01317	Alternate Character Set Handling Scheme
21	427	EI	RE	[0..*]		01598	Message Profile Identifier

315 **MSH-1 Field Separator**, required: This Integration Profile requires that applications support any ASCII value for field separator as specified in the HL7 standard. The value suggested by HL7 is | (ASCII 124).

320 **MSH-2 Encoding Characters**, required: This field contains the four characters in the following order: the component separator, repetition separator, escape character, and subcomponent separator. This Integration Profile requires that applications support any ASCII values for encoding characters as specified in the HL7 standard. The values suggested by HL7 are ^~\& (ASCII 94, 126, 92, and 38, respectively).

MSH-3 Sending Application (HD) and **MSH-5 Receiving Application (HD)**, required. See the constrainable profile definition of data type HD.

325 **MSH-4 Sending Facility (HD)** and **MSH-6 Receiving Facility (HD)**, required. See the constrainable profile definition of data type HD.

MSH-9 Message Type (MSG), required:

Components: <Message Code (ID)> ^ <Trigger Event (ID)> ^ <Message Structure (ID)>

Definition: This field contains the message type, trigger event, and the message structure ID for the message. All three components are required.

330 **MSH-10 Message Control Id (ST)**, required:

Definition: This field contains a number or other identifier that uniquely identifies the message in the context of exchange between trading partners. Each message should be given a unique identifier by the sending system. The receiving system will echo this ID back to the sending system in the Message Acknowledgment segment (MSA). The combination of this identifier and
335 the name of the sending application (MSH-3) should be unique across the healthcare enterprise.

MSH-12 Version ID (VID), required:

Components: <Version ID (ID)> ^ <Internationalization Code (CE)> ^ <International Version ID (CE)>

340 Definition: This field is matched by the receiving system to its own version to be sure the message will be interpreted correctly.

The first component SHALL be populated with the value "2.5" representing HL7 Version 2.5.

MSH-15 Accept Acknowledgment Type (ID), not supported.

MSH-16 Application Acknowledgment Type (ID), not supported.

MSH-17 Country Code (ID), required if available.

345 Definition: This field contains the country of origin for the message. The values to be used are those of ISO 3166, using the 3-character alphabetic form. Refer to *HL7 Table 0399 - Country code*.

Examples of valid values:

350 JPN = Japan, USA = United States, GBR = United Kingdom, ITA = Italy, FRA = France, NLD = Netherlands.

MSH-18 Character Set (ID), conditional.

Definition: This field contains the character set for the entire message. Refer to *HL7 table 0211 - Alternate character sets* for valid values.

Examples of valid values:

355 ASCII: The printable 7-bit ASCII character set.

8859/1: The printable characters from the ISO 8859/1 Character set used by Western Europe. This character set can still be used, but 8859/15 should be used by preference. This character set is the forward-compatible version of 8859/1 and includes new characters such as the Euro currency symbol.

360 ISO IR87: Code for the Japanese Graphic Character set for information interchange (JIS X 0208-1990).

UNICODE UTF-8: UCS Transformation Format, 8-bit form.

365 **Condition predicate:** This field shall only be valued if the message uses a character set other than the 7-bit ASCII character set. Though the field is repeatable in HL7, IHE authorizes only one occurrence (i.e., one character set). The character set specified in this field is used for the encoding of all of the characters within the message.

MSH-19 Principal Language of Message (CE), required if available. Coded from ISO 639.

Examples: DE = German, EN = English, ES=Spanish, JA = Japanese, FR = French, NL = Dutch, IT = Italian

370 **MSH-20 Alternate Character Set Handling Scheme (ID)**, not supported: Character set switching is not allowed here.

MSH-21 Message Profile Identifier (EI), required if available.

375 This field shall be valued in the messages for which a Message Profile has been officially registered with HL7. When multiple message profiles are listed in this field, they should be vendor specific and/or country specific message profiles constraining the official one.

3.30.5.2 EVN – Event Type Segment

Standard Reference: HL7 Version 2.5, Chapter 3, section 3.4.1

This segment is used to provide generic properties of the trigger event.

Table 3.30-2 EVN – Event Type segment

SEQ	LEN	DT	Usage	Card.	TBL#	ITEM#	Element name
1	3	ID	X	[0..0]	0003	00099	Event Type Code
2	26	TS	R	[1..1]		00100	Recorded Date Time
3	26	TS	C	[0..1]		00101	Date/Time Planned Event
4	3	IS	O	[0..1]	0062	00102	Event Reason Code
5	250	XCN	O	[0..*]	0188	00103	Operator ID
6	26	TS	C	[0..1]		01278	Event Occurred
7	241	HD	RE	[0..1]		01534	Event Facility

380 **EVN-1 Event Type Code (ID)**: Not supported (deprecated in HL7 2.5). The Event Type Code is given in MSH-9 of segment MSH.

EVN-2 Recorded Date Time (TS): Required. Date/time when the event was recorded.

EVN-3 Date/Time Planned Event (TS): Conditional. Date/time when the event was planned.

Condition predicate:

- 385
- This field shall be populated in events “Pending Transfer” (A15) and “Cancel Pending Transfer” (A26), which are supported by transaction ITI-31.
 - The update of a pending transfer uses message A08 and leaves this field empty. The update of the planned date/time of the transfer is only possible through the ZBE segment in message Z99, when using the option “Historic Movement Management” of transaction ITI-31.
- 390
- Other planned events of transaction ITI-31, such as “Pending Admit”, “Pending Discharge” and the cancels thereof, use a specific field of segment PV2 to give the date/time of the planned event. For consistency of use, IHE recommends that the content of the specific field of PV2 be also copied to EVN-3.

395 National extensions of this profile may extend the condition above.

EVN-6 Event Occurred (TS): Conditional. This field contains the date/time that the event really occurred.

Condition predicate:

- 400 • This field shall not be populated in messages communicating pending events and their cancellations.
- In messages communicating effective events (inserts and updates), this field shall be populated with the real date/time of the notified event.
- In messages communicating cancellations, this field shall be populated with the date/time that was sent in the message that originally communicated the event being cancelled.

405 **EVN-7 Event Facility (HD):** Required if known to the sender. This field identifies the actual facility where the event occurred as distinct from the sending facility (MSH-4).

3.30.5.3 PID - Patient Identification segment

Standard Reference: HL7 Version 2.5, Chapter 3 (Section 3.4.2)

410 The PID segment is used by all applications as the primary means of communicating patient identification information. This segment contains permanent patient identifying and demographic information that, for the most part, is not likely to change frequently.

Table 3.30-3 PID - Patient Identification segment

SEQ	LEN	DT	Usage	Card.	TBL#	ITEM#	Element name
1	4	SI	O	[0..1]		00104	Set ID - PID
2	20	CX	X	[0..0]		00105	Patient ID
3	250	CX	R	[1..*]		00106	Patient Identifier List
4	20	CX	X	[0..0]		00107	Alternate Patient ID - PID
5	250	XPN	R	[1..*]		00108	Patient Name
6	250	XPN	O	[0..1]		00109	Mother's Maiden Name
7	26	TS	CE	[0..1]		00110	Date/Time of Birth
8	1	IS	CE	[1..1]	0001	00111	Administrative Sex
9	250	XPN	X	[0..1]		00112	Patient Alias
10	250	CE	O	[0..1]	0005	00113	Race
11	250	XAD	CE	[0..*]		00114	Patient Address
12	4	IS	X	[0..1]	0289	00115	County Code
13	250	XTN	O	[0..*]		00116	Phone Number - Home
14	250	XTN	O	[0..*]		00117	Phone Number - Business
15	250	CE	O	[0..1]	0296	00118	Primary Language
16	250	CE	O	[0..1]	0002	00119	Marital Status
17	250	CE	O	[0..1]	0006	00120	Religion
18	250	CX	O	[0..1]		00121	Patient Account Number
19	16	ST	X	[0..1]		00122	SSN Number - Patient
20	25	DLN	X	[0..1]		00123	Driver's License Number - Patient
21	250	CX	O	[0..*]		00124	Mother's Identifier
22	250	CE	O	[0..1]	0189	00125	Ethnic Group

SEQ	LEN	DT	Usage	Card.	TBL#	ITEM#	Element name
23	250	ST	O	[0..1]		00126	Birth Place
24	1	ID	O	[0..1]	0136	00127	Multiple Birth Indicator
25	2	NM	O	[0..1]		00128	Birth Order
26	250	CE	O	[0..1]	0171	00129	Citizenship
27	250	CE	O	[0..1]	0172	00130	Veterans Military Status
28	250	CE	X	[0..0]	0212	00739	Nationality
29	26	TS	C	[0..1]		00740	Patient Death Date and Time
30	1	ID	C	[0..1]	0136	00741	Patient Death Indicator
31	1	ID	CE	[0..1]	0136	01535	Identity Unknown Indicator
32	20	IS	CE	[0..*]	0445	01536	Identity Reliability Code
33	26	TS	CE	[0..1]		01537	Last Update Date/Time
34	241	HD	O	[0..1]		01538	Last Update Facility
35	250	CE	CE	[0..1]	0446	01539	Species Code
36	250	CE	C	[0..1]	0447	01540	Breed Code
37	80	ST	O	[0..1]		01541	Strain
38	250	CE	O	[0..2]		01542	Production Class Code
39	250	CWE	O	[0..*]		01840	Tribal Citizenship

In accord with the HL7 Version 2.5 usage of this segment, fields PID-2 (Patient ID), PID-4 (Alternate Patient ID), PID-19 (SSN patient number) and PID-20 (Driver's license number) are superseded by field PID-3, as shown below; field PID-28 (Nationality) is superseded by field PID-26 (Citizenship).

PID-3 – Patient Identifier List (CX), required. This field contains a list of identifiers (one or more) used by the healthcare facility to uniquely identify a patient.

As shown in the constrained profile definition of data type CX at the end of this supplement, subfields CX-1 "ID number", CX-4 "Assigning authority", and CX-5 "Identifier Type Code" are required for each identifier.

This field may be populated with various identifiers assigned to the patient by various assigning authorities.

The authorized values for subfield CX-5 "Identifier Type Code" are given in HL7 Table 0203 (HL7 Version 2.5, Chapter 2A, Section 2A.14.5).

Values commonly used for Identifier Type Code in the context of PID-3 are as follows:

BC	Bank card number. Assigning authority is the bank.
DL	Driver's licence number. Assigning authority is the state
NH	National Health Plan Identifier. Assigning authority at the national level.
PE	Living Subject Enterprise Number. Assigning authority is the enterprise.
PI	Patient Internal Identifier assigned by the healthcare organization.
PPN	Passport number.
PRC	Permanent Resident Card Number

SS Social Security Number.

435

PID-5 – Patient Name (XPN), required. This field contains one or more names for the patient. At least one name must be provided, with at least the first subfield “Family Name” valued. See the constrained profile definition of data type XPN.

PID-7 – Date/Time of Birth (TS), conditional.

440 Condition predicate:

- This field is required if available (i.e., known to the sender) in the following messages: Creation of a new patient (A28 in ITI-30), inpatient admitted (A01 in ITI-31), registration of an outpatient (A04 in ITI-31), update patient demographics (A31 in ITI-30), update patient demographics in the context of an encounter (A08 in ITI-31).

445

- In all other messages, it is optional.
- If the exact date of birth is not known, it can be truncated to the year of birth (e.g., 1954) or to the year and month of birth (e.g., 195411).

PID-8 – Administrative Sex (IS), conditional.

Condition predicate:

450

- This field is required if available in the following messages: Creation of a new patient (A28 in ITI-30), inpatient admitted (A01 in ITI-31), registration of an outpatient (A04 in ITI-31), update patient demographics (A31 in ITI-30).
- In all other messages, it is optional.
- The authorized values are these, taken from HL7 User-defined Table 0001:

455

User-defined Table 0001 - Administrative Sex

Value	Description	Comment
F	Female	
M	Male	
O	Other	
U	Unknown	
A	Ambiguous	
N	Not applicable	

PID-10 – Race (CE), optional: This field may be further constrained in national extensions of this PAM profile. For instance, it will be required if available (usage code RE) in the US extension, but will not be supported (usage code X) in the French extension.

PID-11 – Patient Address (XAD), conditional:

460 Condition predicate:

- This field is required if available (if known to the sender) in the following messages: Creation of a new patient (A28 in ITI-30), inpatient admitted (A01 in ITI-31), registration of an outpatient (A04 in ITI-31), update patient demographics (A31 in ITI-30).

- In all other messages, it is optional.

465 **PID-18 – Patient Account Number (CX):** Optional.

HL7 Definition: This field contains the patient account number assigned by accounting to which all charges, payments, etc., are recorded. It is used to identify the patient’s account.

470 Relationship to encounter: A patient account can span more than one enterprise encounter. At least one of the fields PID-18 “Patient Account Number” or PV1-19 “Visit Number” shall be valued in the messages of transaction ITI-31 that use the PV1 segment. Additional requirements for the presence of value in these fields may be documented in national extensions of this profile.

PID-29 – Patient Death Date and Time (TS), conditional:

Condition predicate:

- 475 • This field is required in the Patient Discharge message of transaction ITI-31, in the case when the encounter is terminated by the patient’s death. It provides the date/time of the patient’s death.
- In all other messages, it is optional.

PID-30 – Patient Death Indicator (ID), conditional:

Condition predicate:

- 480 • This field is required to be populated with value “Y” whenever PID-29 is populated.

PID-31 – Identity Unknown Indicator (ID), conditional:

Condition predicate:

- 485 • This field is required if available (i.e., known to the sender) in the following messages: Creation of a new patient (A28 in ITI-30), inpatient admitted (A01 in ITI-31), registration of an outpatient (A04 in ITI-31), update patient demographics (A31 in ITI-30) , update patient demographics in the context of an encounter (A08 in ITI-31).
- In all other messages, it is optional.

The possible values are “Y”, and “N” which is the default.

490 The value “Y” means that the patient identity is unknown. In this case the field PID-3 shall contain one single patient identifier, which is a temporary identifier, and the field PID-32 will contain the value “AL” indicating that the patient name is an alias.

PID-32 – Identity Reliability Code (IS), conditional:

Condition predicate:

- 495 • This field is required if available (i.e., known to the sender) in the following messages: Creation of a new patient (A28 in ITI-30), inpatient admitted (A01 in ITI-31), registration of an outpatient (A04 in ITI-31), update patient demographics (A31 in ITI-30) , update patient demographics in the context of an encounter (A08 in ITI-31).
- In all other messages, it is optional.

The field is repeatable. The possible values are taken from HL7 user-defined Table 0445:

500

User-defined Table 0445 - Identity Reliability Code

Value	Description	Comment (added by IHE for this profile)
US	Unknown/Default Social Security Number	
UD	Unknown/Default Date of Birth	
UA	Unknown/Default Address	
AL	Patient/Person Name is an Alias	Used in case of an unidentified patient (e.g., trauma case)

PID-33 – Last Update Date/Time (TS), conditional:

Condition predicate:

- This field is required if available (i.e., known to the sender) in the following messages: Creation of a new patient (A28 in ITI-30), inpatient admitted (A01 in ITI-31), registration of an outpatient (A04 in ITI-31), update patient demographics (A31 in ITI-30), update patient demographics in the context of an encounter (A08 in ITI-31).
- In the cases of messages A08 and A31, the content of this field is equal to the value in EVN-6-event occurred.

505

PID-35 – Species Code (CE) and **PID-36 – Breed Code (CE)**, conditional:

510 Condition predicate:

- Required if known to the sender, when the patient is a non-human living subject, in the following messages: Creation of a new patient (A28 in ITI-30), inpatient admitted (A01 in ITI-31), registration of an outpatient (A04 in ITI-31), update patient demographics (A31 in ITI-30), update patient demographics in the context of an encounter (A08 in ITI-31).

515

3.30.5.4 PV1 - Patient Visit segment

Standard Reference: HL7 Version 2.5, Chapter 3 (Section 3.4.3)

The PV1 segment is used by Registration/Patient Administration applications to communicate information on an account or visit-specific basis.

520

Table 3.30-4 PV1 - Patient Visit segment

SEQ	LEN	DT	Usage	Card.	TBL#	ITEM#	ELEMENT NAME
1	4	SI	O	[0..1]		00131	Set ID - PV1
2	1	IS	R	[1..1]	0004	00132	Patient Class
3	80	PL	C	[0..1]		00133	Assigned Patient Location
4	2	IS	O	[0..1]	0007	00134	Admission Type
5	250	CX	O	[0..1]		00135	Preadmit Number
6	80	PL	C	[0..1]		00136	Prior Patient Location
7	250	XCN	O	[0..*]	0010	00137	Attending Doctor
8	250	XCN	O	[0..*]	0010	00138	Referring Doctor
9	250	XCN	X	[0..0]	0010	00139	Consulting Doctor
10	3	IS	O	[0..1]	0069	00140	Hospital Service
11	80	PL	C	[0..1]		00141	Temporary Location
12	2	IS	O	[0..1]	0087	00142	Preadmit Test Indicator
13	2	IS	O	[0..1]	0092	00143	Re-admission Indicator
14	6	IS	O	[0..1]	0023	00144	Admit Supplier
15	2	IS	O	[0..*]	0009	00145	Ambulatory Status
16	2	IS	O	[0..1]	0099	00146	VIP Indicator
17	250	XCN	O	[0..*]	0010	00147	Admitting Doctor
18	2	IS	O	[0..1]	0018	00148	Patient Type
19	250	CX	O	[0..1]		00149	Visit Number
20	50	FC	O	[0..*]	0064	00150	Financial Class
21	2	IS	O	[0..1]	0032	00151	Charge Price Indicator
22	2	IS	O	[0..1]	0045	00152	Courtesy Code
23	2	IS	O	[0..1]	0046	00153	Credit Rating
24	2	IS	O	[0..*]	0044	00154	Contract Code
25	8	DT	O	[0..*]		00155	Contract Effective Date
26	12	NM	O	[0..*]		00156	Contract Amount
27	3	NM	O	[0..*]		00157	Contract Period
28	2	IS	O	[0..1]	0073	00158	Interest Code
29	4	IS	O	[0..1]	0110	00159	Transfer to Bad Debt Code
30	8	DT	O	[0..1]		00160	Transfer to Bad Debt Date
31	10	IS	O	[0..1]	0021	00161	Bad Debt Agency Code
32	12	NM	O	[0..1]		00162	Bad Debt Transfer Amount
33	12	NM	O	[0..1]		00163	Bad Debt Recovery Amount
34	1	IS	O	[0..1]	0111	00164	Delete Account Indicator
35	8	DT	O	[0..1]		00165	Delete Account Date
36	3	IS	O	[0..1]	0112	00166	Discharge Disposition
37	47	DLD	O	[0..1]	0113	00167	Discharged to Location
38	250	CE	O	[0..1]	0114	00168	Diet Type
39	2	IS	O	[0..1]	0115	00169	Servicing Facility

SEQ	LEN	DT	Usage	Card.	TBL#	ITEM#	ELEMENT NAME
40	1	IS	X	[0..1]	0116	00170	Bed Status
41	2	IS	O	[0..1]	0117	00171	Account Status
42	80	PL	C	[0..1]		00172	Pending Location
43	80	PL	O	[0..1]		00173	Prior Temporary Location
44	26	TS	RE	[0..1]		00174	Admit Date/Time
45	26	TS	RE	[0..1]		00175	Discharge Date/Time
46	12	NM	O	[0..1]		00176	Current Patient Balance
47	12	NM	O	[0..1]		00177	Total Charges
48	12	NM	O	[0..1]		00178	Total Adjustments
49	12	NM	O	[0..1]		00179	Total Payments
50	250	CX	O	[0..1]	0203	00180	Alternate Visit ID
51	1	IS	O	[0..1]	0326	01226	Visit Indicator
52	250	XCN	X	[0..*]	0010	01274	Other Healthcare Provider

General conditions of use:

- All messages of transaction ITI-30 that use this segment, actually use a pseudo-PV1, which is empty. The only field populated is PV1-2 “Patient Class” values “N” (Not Applicable).
- The condition predicates described below only apply to the use of this segment in the context of transaction ITI-31.

PV1-2 – Patient Class (IS), required:

530 Definition: This field is used by systems to categorize patients by site. It does not have a consistent industry-wide definition. It is subject to site-specific variations. Refer to *User-defined Table 0004 - Patient Class* for suggested values.

User-defined Table 0004 - Patient Class

Value	Description	Comment
E	Emergency	
I	Inpatient	
O	Outpatient	
P	Preadmit	
R	Recurring patient	
B	Obstetrics	
C	Commercial Account	
N	Not Applicable	
U	Unknown	

National extensions of this PAM profile may add further values to this table.

535 Messages of transaction ITI-31 may use any of the above values. The four first values (“E” Emergency, “I” Inpatient, “O” Outpatient, “P” Preadmit) are in common use in most countries.

Conditions of use:

- Transaction ITI-30 uses only the value “N” (Not Applicable) in all messages that contain the PV1 segment.

540

- In transaction ITI-31
 - Change to inpatient (A06) uses value I or another value representing an inpatient.
 - Change to outpatient (A07) uses value O or another value representing an outpatient (i.e., not assigned to an inpatient bed).

PV1-3 – Assigned Patient Location (PL), conditional:

545

Condition predicate:

- This field is required in the Transfer (A02) and Cancel Transfer (A12) messages.
- In all other messages of transaction ITI-31, it is required if known to the sender.

PV1-6 – Prior Patient Location (PL), conditional:

Condition predicate:

550

- This field is required in the Transfer (A02)
- In all other messages of transaction ITI-31, it is optional.

PV1-7 – Attending Doctor (XCN), optional. It is recommended that when this field is populated, the segment PV1/PV2 be followed by a ROL segment containing the details on the role assumed by the attending doctor.

555

PV1-8 – Referring Doctor (XCN), optional. It is recommended that when this field is populated, the segment PV1/PV2 be followed by a ROL segment containing the details on the role assumed by the referring doctor.

PV1-9 – Consulting Doctor (XCN), not supported (deprecated by HL7). The consulting doctor(s) are entirely described in the appropriate ROL segments following the PV1/PV2.

560

PV1-11 – Temporary Location (PL), conditional:

Condition predicate: This field is used by the option “Temporary Patient Transfers Tracking” of transaction ITI-31 (messages A09, A10, A32, A33).

565

PV1-19 – Visit Number (CX), Optional. This fields contains the unique identifier assigned to the encounter. At least one of the fields PID-18 “Patient Account Number” or PV1-19 “Visit Number” shall be valued in the messages of transaction ITI-31 that use the PV1 segment. Additional requirements for the presence of values in these fields may be documented in national extensions of this profile.

PV1-42 – Pending Location (PL), conditional.

Condition predicate:

570

- This field is required in the Pending Transfer (A15) and Cancel Pending Transfer (A26) messages.
- In all other messages of transaction ITI-31, it is optional.

PV1-44 – Admit Date / Time (TS), required if available. This field contains the date/time of the beginning of the encounter.

575 **PV1-45 – Discharge Date / Time (TS)**, required if available. This field contains the date/time of the discharge (end of the encounter).

3.30.5.5 MRG – Merge segment

Standard Reference: HL7 Version 2.5, Chapter 3 (Section 3.4.9)

This segment contains the supplier patient identifiers list to be merged.

580

Table 3.30-5 MRG - Merge segment

SEQ	LEN	DT	Usage	Card.	TBL#	ITEM#	Element name
1	250	CX	R	[1..*]		00211	Prior Patient Identifier List
2	250	CX	X	[0..0]		00212	Prior Alternate Patient ID
3	250	CX	O	[0..1]		00213	Prior Patient Account Number
4	250	CX	X	[0..0]		00214	Prior Patient ID
5	250	CX	X	[0..0]		01279	Prior Visit Number
6	250	CX	X	[0..0]		01280	Prior Alternate Visit ID
7	250	XPN	O	[0..*]		01281	Prior Patient Name

Each of the patient identifiers appearing in the MRG-1 is to be merged with a target patient identifier of the same type in the PID-3.

585 The type of identifier is a code given by the 5th component of the CX data type. See the commonly used identifier types in the description of the PID segment above. See also the definition of data type CX in the “Common Data Types” section.

3.30.5.6 ROL – Role segment

Standard Reference: HL7 Version 2.5, Chapter 15 (Section 15.4.7)

The ROL segment communicates information on persons related to the patient.

Table 3.30-6 ROL Segment

SEQ	LEN	DT	Usage	Card.	TBL#	ITEM #	ELEMENT NAME
1	60	EI	C	[0..1]		01206	Role Instance ID
2	2	ID	R	[1..1]	0287	00816	Action Code
3	250	CE	R	[1..1]	0443	01197	Role-ROL
4	250	XCN	R	[1..*]		01198	Role Person
5	26	TS	O	[0..1]		01199	Role Begin Date/Time
6	26	TS	O	[0..1]		01200	Role End Date/Time
7	250	CE	O	[0..1]		01201	Role Duration
8	250	CE	O	[0..1]		01205	Role Action Reason
9	250	CE	O	[0..*]		01510	Provider Type
10	250	CE	O	[0..1]	0406	01461	Organization Unit Type
11	250	XAD	O	[0..*]		00679	Office/Home Address/Birthplace
12	250	XTN	O	[0..*]		00678	Phone

590 **ROL-1 – Role Instance ID (EI)**, optional. This field is in fact optional in the context of ADT messages.

ROL-2 – Action Code (ID), required

ROL-3 – Role-ROL (CE), required. This field defines the functional involvement of the person. Values are given in *User-defined table 0443*:

595

User-defined Table 0443 - Provider role

Value	Description	Used with
AD	Admitting	PV1-17 Admitting doctor
AT	Attending	PV1-7 Attending doctor
CP	Consulting Provider	
FHCP	Family Health Care Professional	
PP	Primary Care Provider	
RP	Referring Provider	PV1-8 Referring doctor
RT	Referred to Provider	

ROL-4 – Role Person (XCN), required. Identification of the person playing the role.

3.30.5.7 OBX – Observation/Result segment

Standard Reference: HL7 Version 2.5, Chapter 7 (Section 7.4.2)

600 In transactions ITI-30 and ITI-31, the OBX segment is primarily used to convey patient height and patient weight. For this reason, this segment is described in this section, although it always appears as optional in transactions ITI-30 and ITI-31.

Table 3.30-7 OBX Segment

SEQ	LEN	DT	Usage	Card.	TBL#	ITEM#	Element name
1	4	SI	O	[0..1]		00569	Set ID – OBX
2	2	ID	R	[1..1]	0125	00570	Value Type
3	250	CE	R	[1..1]		00571	Observation Identifier
4	20	ST	O	[0..1]		00572	Observation Sub-ID
5	99999	Varies	R	[1..1]		00573	Observation Value
6	250	CE	O	[0..1]		00574	Units
7	60	ST	O	[0..1]		00575	References Range
8	5	IS	O	[0..1]	0078	00576	Abnormal Flags
9	5	NM	O	[0..1]		00577	Probability
10	2	ID	O	[0..1]	0080	00578	Nature of Abnormal Test
11	1	ID	R	[0..1]	0085	00579	Observation Result Status
12	26	TS	O	[0..1]		00580	Effective Date of Reference Range
13	20	ST	O	[0..1]		00581	User Defined Access Checks
14	26	TS	O	[0..1]		00582	Date/Time of the Observation
15	250	CE	O	[0..1]		00583	Producer's ID
16	250	XCN	O	[0..1]		00584	Responsible Observer
17	250	CE	O	[0..1]		00936	Observation Method
18	22	EI	O	[0..1]		01479	Equipment Instance Identifier

SEQ	LEN	DT	Usage	Card.	TBL#	ITEM#	Element name
19	26	TS	O	[0..1]		01480	Date/Time of the Analysis

OBX-2 Value Type (ID), required.

This field contains the type of observation.

605 Example: “NM” for a numeric observation such as patient weight or patient height.

OBX-3 Observation Identifier (CE), required

610 The usage of LOINC® vocabulary is strongly recommended. Details of this free vocabulary can be found at <http://www.loinc.org>. The first and third sub-fields, “Identifier” and “Name of Coding System” are required in all transactions. The value of the “Name of Coding System” in the case of LOINC is “LN”.

Example of the code used with the patient weight: 3142-7^BODY WEIGHT (STATED)^LN

OBX-5 Observation Value (Varies), required.

This field contains the value of the observation itself.

OBX-11 Observation Result Status (ID), required.

615 This field contains the status of the results. In messages of transactions ITI-30 and ITI-31, this status is most commonly “F” (Final).

Example of use of the OBX segment to carry the patient weight and height:

620

```
OBX|1|NM|3142-7^BODY WEIGHT (STATED)^LN||62|kg|||||F
OBX|2|NM|8303-0^BODY HEIGHT^LN||1.70|m|||||F
```

3.30.5.8 AL1 – Patient Allergy Information segment

Standard Reference: HL7 Version 2.5, Chapter 3, Section 3.4.6

625 In transactions ITI-30 and ITI-31, the AL1 segment is used to inform the receiver of patient allergies. For this reason, this segment is described in this section, although it always appears as optional in transactions ITI-30 and ITI-31.

Table 3.30-8 AL1 Segment

SEQ	LEN	DT	Usage	Card.	TBL#	ITEM#	Element name
1	4	SI	R	[1..1]		00203	Set ID – AL1
2	250	CE	O	[0..1]	0127	00204	Allergen Type Code
3	250	CE	R	[1..1]		00205	Allergen Code/Mnemonic/Description
4	250	CE	O	[0..1]	0128	00206	Allergen Severity Code
5	15	ST	O	[0..*]		00207	Allergen Reaction Code
6	8	DT	X	[0..0]		00208	Identification Date

One or more AL1 segments may appear in the messages of transactions ITI-30 and ITI-31 if any allergies have been identified for the patient at time of registration.

3.30.6 Interactions

630 All messages of this transaction shall be acknowledged by the ACK message as stated in ITI TF-2x: Appendix C. For better readability, the acknowledgement messages are not shown on the interaction diagrams of this transaction.

3.30.6.1 Interaction diagram

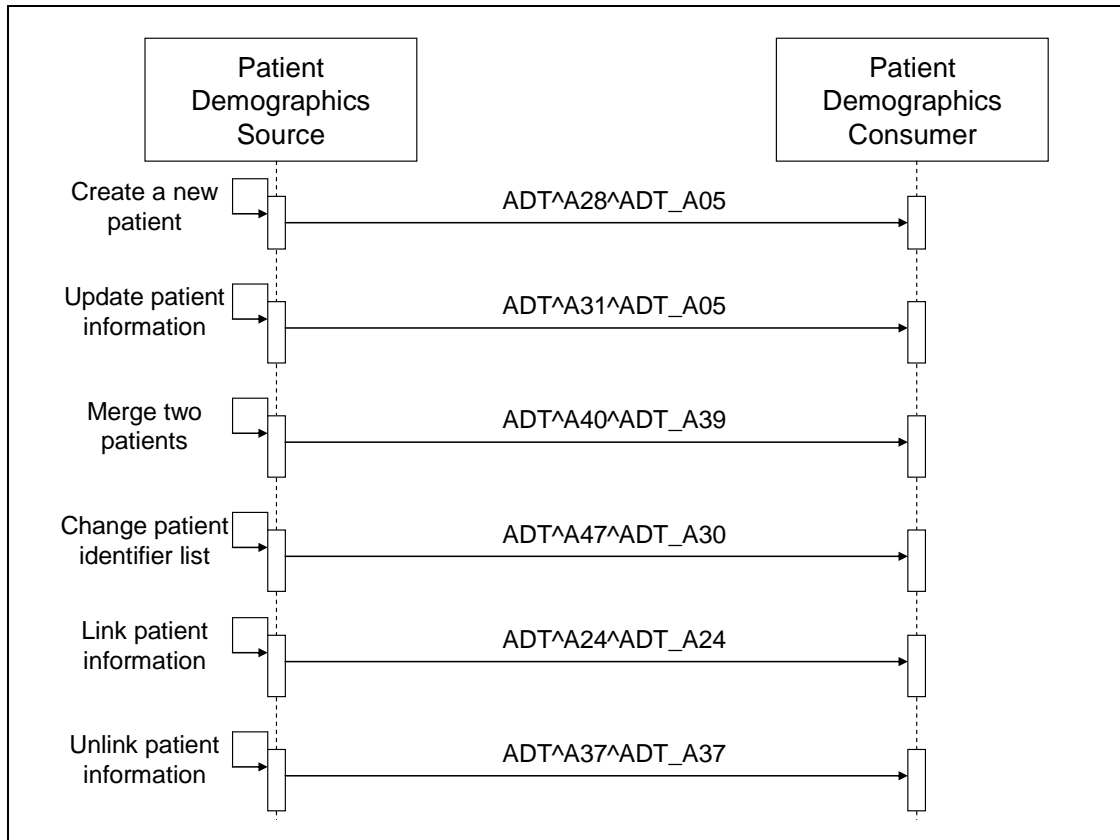

635

Figure 3.30-1: Interactions of transaction ITI-30

3.30.6.2 Create New Patient - ADT^A28^ADT_A05

3.30.6.2.1 Trigger Event

640 This message is sent by a Patient Demographics Supplier to a Patient Demographics Consumer to communicate the demographics of a new patient, as well as related information.

MSH-9 is valued ADT^A28^ADT_A05.

3.30.6.2.2 Message Static Definition

Table 3.30-9 Static definition of ADT^A28^ADT_A05

Segment	Meaning	Usage	Card.	HL7 chapter
MSH	Message Header	R	[1..1]	2

SFT	Software Segment	O	[0..*]	2
EVN	Event Type	R	[1..1]	2
PID	Patient Identification	R	[1..1]	3
PD1	Additional Demographics	O	[0..1]	3
ROL	Role	O	[0..*]	15
NK1	Next of Kin / Associated Parties	O	[0..*]	3
PV1	Patient Visit	R	[1..1]	3
PV2	Patient Visit – Additional Info	X	[0..0]	3
ROL	Role	X	[0..0]	15
DB1	Disability Information	O	[0..*]	3
OBX	Observation/Result	O	[0..*]	7
AL1	Allergy Information	O	[0..*]	3
DG1	Diagnosis Information	O	[0..*]	6
DRG	Diagnosis Related Group	O	[0..1]	6
---	--- PROCEDURE begin	O	[0..*]	
PR1	Procedures	R	[1..1]	6
ROL	Role	O	[0..*]	15
---	--- PROCEDURE end			
GT1	Guarantor	O	[0..*]	6
---	--- INSURANCE begin	O	[0..*]	
IN1	Insurance	R	[1..1]	6
IN2	Insurance Additional Info.	O	[0..1]	6
IN3	Insurance Additional Info - Cert.	O	[0..1]	6
ROL	Role	O	[0..*]	15
---	--- INSURANCE end			
ACC	Accident Information	O	[0..1]	6
UB1	Universal Bill Information	O	[0..1]	6
UB2	Universal Bill 92 Information	O	[0..1]	6

3.30.6.2.3 Comments on segment usage

645 The ROL segment following the PID/PD1 segments is used to communicate “person level” providers having an ongoing relationship with the patient, such as “family health care provider” and “primary care provider”.

650 The PV1 segment in this message is required in the HL7 message structure, but it is a pseudo PV1 carrying the only required field PV1-2 “Patient Class” with the value “N” meaning “Not applicable”. This message does not convey any visit information.

The PV2 segment is not supported here, for the same reason.

The ROL segment following the PV1/PV2 segments is not supported here, for the same reason.

One or more OBX segments may be present to carry “permanent observations” such as the patient weight or height.

655 The ROL segment following the IN1/IN2/IN3 segments serves to communicate providers related to a specific insurance carrier.

3.30.6.2.4 Expected actions

The receiver shall add this new patient to its database, and shall report the result of this operation (success / error) in an acknowledgment message returned to the sender.

660 **3.30.6.3 Update patient information - ADT^A31^ADT_A05**

3.30.6.3.1 Trigger Event

This message is sent by a Patient Demographics Supplier to a Patient Demographics Consumer to update the demographics of an existing patient.

MSH-9 is valued ADT^A31^ADT_A05.

665 **3.30.6.3.2 Message Static Definition**

Table 3.30-10 Static definition of ADT^A31^ADT_A05

Segment	Meaning	Usage	Card.	HL7 chapter
MSH	Message Header	R	[1..1]	2
SFT	Software Segment	O	[0..*]	2
EVN	Event Type	R	[1..1]	2
PID	Patient Identification	R	[1..1]	3
PD1	Additional Demographics	O	[0..1]	3
ROL	Role	O	[0..*]	15
NK1	Next of Kin / Associated Parties	O	[0..*]	3
PV1	Patient Visit	R	[1..1]	3
PV2	Patient Visit – Additional Info	X	[0..0]	3
ROL	Role	O	[0..*]	15
DB1	Disability Information	O	[0..*]	3
OBX	Observation/Result	O	[0..*]	7
AL1	Allergy Information	O	[0..*]	3
DG1	Diagnosis Information	O	[0..*]	6
DRG	Diagnosis Related Group	O	[0..1]	6
---	--- PROCEDURE begin	O	[0..*]	
PR1	Procedures	R	[1..1]	6
ROL	Role	O	[0..*]	15
---	--- PROCEDURE end			
GT1	Guarantor	O	[0..*]	6
---	--- INSURANCE begin	O	[0..*]	
IN1	Insurance	R	[1..1]	6
IN2	Insurance Additional Info.	O	[0..1]	6
IN3	Insurance Additional Info - Cert.	O	[0..1]	6
ROL	Role	O	[0..*]	15
---	--- INSURANCE end			

ACC	Accident Information	O	[0..1]	6
UB1	Universal Bill Information	O	[0..1]	6
UB2	Universal Bill 92 Information	O	[0..1]	6

3.30.6.3.3 Comments on segment usage

To accommodate the situation in which the receiver does not know the patient, this message is populated with complete up-to-date demographics for the patient.

670 The ROL segment following the PID/PD1 segments is used to communicate “person level” providers having an ongoing relationship with the patient, such as “family health care provider” and “primary care provider”.

675 The PV1 segment in this message is required in the HL7 message structure, but it is a pseudo PV1 carrying the only required field PV1-2 “Patient Class” with the value “N” meaning “Not applicable”. This message does not convey any visit information.

The PV2 segment is not supported here, for the same reason.

The ROL segment following the PV1/PV2 segments is not supported here, for the same reason.

One or more OBX segments may be present to carry “permanent observations” such as the patient weight or height.

680 The ROL segment following the IN1/IN2/IN3 segments serves to communicate providers related to a specific insurance carrier.

3.30.6.3.4 Expected actions

685 The receiver shall update the patient record in its database, and shall report the result of this operation (success / error) in an acknowledgment message returned to the sender. If the receiver did not previously have a record for this patient, it shall insert this patient into its database.

3.30.6.4 Merge two patients - ADT^A40^ADT_A39

This message is to be supported with the “Merge” option of Transaction ITI-30.

3.30.6.4.1 Trigger Event

690 The Patient Demographics Supplier notifies to a Patient Demographics Consumer, the merge of records for a patient that was incorrectly filed under two different identifiers. This message is only used to merge two patient identifiers of the same type, or two lists of patient identifiers. It is not used to update other patient demographics information. The A31 trigger event should be used for this purpose.

MSH-9 is valued ADT^A40^ADT_A39.

695 **3.30.6.4.2 Message Static Definition**

Table 3.30-11 Static definition of ADT^A40^ADT_A39

Segment	Meaning	Usage	Card.	HL7 chapter
MSH	Message Header	R	[1..1]	2

SFT	Software Segment	O	[0..*]	2
EVN	Event Type	R	[1..1]	2
---	--- PATIENT begin	R	[1..1]	
PID	Patient Identification	R	[1..1]	3
PD1	Additional Demographics	O	[0..1]	3
MRG	Merge Information	R	[1..1]	3
PV1	Patient Visit	X	[0..0]	3

3.30.6.4.3 Comments on segment usage

This profile makes unrepeatable the PATIENT segment group: The message can communicate only one merge operation for one patient.

700 The “incorrect supplier identifier” identified in the MRG segment (*MRG-1 - Prior Patient Identifier List*) is to be merged with the required “correct target identifier” of the same “identifier type code” component identified in the PID segment (*PID-3 - Patient Identifier List*). The “incorrect supplier identifier” would then logically never be referenced in future transactions.

The PV1 segment is not supported by IHE in this message.

705 3.30.6.4.4 Expected actions

The receiver shall merge the two patients in its database, and shall report the result of this operation (success / error) in an acknowledgment message returned to the sender.

If the receiver does not recognize the target patient identifiers, it shall perform a Change Patient Identifier List instead of a Merge. This situation is not an error.

710 If the receiver does not recognize the supplier patient identifiers to be merged, it shall take no action. This situation is not an error.

If the receiver does not support the Merge option of this transaction, it shall application-reject the message (see ITI TF-2x: C.2.3).

3.30.6.5 Change Patient Identifier List - ADT^A47^ADT_A30

715 3.30.6.5.1 Trigger Event

The Patient Demographics Supplier notifies the change of a patient identifier list for a patient. That is, a single *PID-3-patient identifier list value* has been found to be incorrect and has been changed.

720 This message is not used to update other patient demographics information. The A31 trigger event should be used for this purpose.

MSH-9 is valued **ADT^A47^ADT_A30**.

3.30.6.5.2 Message Static Definition**Table 3.30-12 Static definition of ADT^A47^ADT_A30**

Segment	Meaning	Usage	Card.	HL7 chapter
MSH	Message Header	R	[1..1]	2
SFT	Software Segment	O	[0..*]	2
EVN	Event Type	R	[1..1]	2
---	--- PATIENT begin	R	[1..1]	
PID	Patient Identification	R	[1..1]	3
PD1	Additional Demographics	O	[0..1]	3
MRG	Merge Information	R	[1..1]	3

3.30.6.5.3 Comments on segment usage

725 The “incorrect supplier identifier” value is stored in the MRG segment (*MRG-1-Prior Patient Identifier List*) and is to be changed to the “correct target patient ID” value stored in the PID segment (*PID-3-Patient Identifier List*).

3.30.6.5.4 Expected actions

730 The receiver shall correct the identifier in its database, and shall report the result of this operation (success / error) in an acknowledgment message returned to the sender.

If the receiver already associates the target patient identifiers with another patient in its database, this is an error condition: A merge (A40) should have been sent instead of a change.

If the receiver does not recognize the supplier patient identifiers to be merged, no further action is required and no error condition exists.

735 3.30.6.6 Link Patient Information List - ADT^A24^ADT_A24

This message is to be supported with the “Link/Unlink” option of Transaction ITI-30.

3.30.6.6.1 Trigger Event

740 The Patient Demographics Supplier notifies the link of one patient identifier list (the first PID segment) to another one (the second PID segment). Linking two or more patients does not require the actual merging of patient information; following a link event, the affected patient data records should remain distinct.

This message is not used to update other patient demographics information. The A31 trigger event should be used for that purpose.

MSH-9 is valued to **ADT^A24^ADT_A24**.

745 3.30.6.6.2 Message Static Definition**Table 3.30-13 Static definition of ADT^A24^ADT_A24**

Segment	Meaning	Usage	Card.	HL7 chapter
---------	---------	-------	-------	-------------

MSH	Message Header	R	[1..1]	2
SFT	Software Segment	O	[0..*]	2
EVN	Event Type	R	[1..1]	2
PID	Patient Identification	R	[1..1]	3
PD1	Additional Demographics	X	[0..1]	3
PV1	Patient Visit	X	[0..1]	3
DB1	Disability Information	X	[0..1]	3
PID	Patient Identification	R	[1..1]	3
PD1	Additional Demographics	X	[0..1]	3
PV1	Patient Visit	X	[0..1]	3
DB1	Disability Information	X	[0..1]	3

3.30.6.6.3 Comments on segment usage

750 The patient identifier list stored in the first PID segment (*PID-3–Patient Identifier List*) is to be linked with the patient identifier list stored in the second PID segment (*PID-3–Patient Identifier List*).

Transaction ITI-30 restricts the use of this message to only the purpose of linking two patient identifier lists. This is why segments PD1, PV1 and DB1 are not supported in this message.

3.30.6.6.4 Expected actions

755 The receiver links the identifier lists in its database, and reports the result of this operation (success / error) in an acknowledgment message returned to the sender. In case of success, each patient record persists with all its associated information (encounter, clinical, care, insurance, next of kin, etc.).

760 In case the receiver did not recognize one or both of the patient identifier lists, the linking is still performed (the receiver will record the link without creating any missing patient record) and no error condition exists.

If the receiver does not support the Link/Unlink option of this transaction, it shall application-reject the message (see ITI TF-2x: C.2.3).

3.30.6.7 Unlink Patient Information List - ADT^A37^ADT_A37

3.30.6.7.1 Trigger Event

765 The Patient Demographics Supplier notifies the receiving system of the unlinking of one patient identifier list (the first PID segment) from another one (the second PID segment).

MSH-9 is valued **ADT^A37^ADT_A37**.

3.30.6.7.2 Message Static Definition

Table 3.30-14 Static definition of ADT^A37^ADT_A37

Segment	Meaning	Usage	Card.	HL7 chapter
MSH	Message Header	R	[1..1]	2

SFT	Software Segment	O	[0..*]	2
EVN	Event Type	R	[1..1]	2
PID	Patient Identification	R	[1..1]	3
PD1	Additional Demographics	X	[0..1]	3
PV1	Patient Visit	X	[0..1]	3
DB1	Disability Information	X	[0..1]	3
PID	Patient Identification	R	[1..1]	3
PD1	Additional Demographics	X	[0..1]	3
PV1	Patient Visit	X	[0..1]	3
DB1	Disability Information	X	[0..1]	3

770 3.30.6.7.3 Comments on segment usage

The patient identifier lists stored in the two PID segments (*PID-3–Patient Identifier List*) are to be unlinked.

Transaction ITI-30 restricts the use of this message to only the purpose of unlinking two patient identifier lists. This is why segments PD1, PV1 and DB1 are not supported in this message.

775 3.30.6.7.4 Expected actions

The receiver unlinks the identifier lists in its database, and reports the result of this operation (success / error) in an acknowledgment message returned to the sender.

In case of success the two patient records are unlinked, each of them keeping its own related information (encounter, clinical, next of kin, insurance...).

780 In case the receiver did not recognize the link between these two patient identifier lists, no action is performed and no error condition exists.

If the receiver does not support the Link/Unlink option of this transaction, it shall application-reject the message (see ITI TF-2x: C.2.3).

3.31 Patient Encounter Management

785 This section corresponds to Transaction ITI-31 “Patient Encounter Management” of the IHE IT Infrastructure Technical Framework. Transaction ITI-31 is used by the actors Patient Encounter Supplier and Patient Encounter Consumer.

3.31.1 Scope

790 This transaction enables systems to share encounter information within acute care settings for both inpatients (i.e., those who are assigned an inpatient bed at the facility) and outpatients (i.e., those who are not assigned an inpatient bed at the facility).

The transaction carries events for creating, updating, and canceling patient encounters as well as the movements that take place within these encounters.

795 The capabilities of this transaction are organized into several optional subsets to address a wide range of needs from the simplest one that only shares the basic encounter information to the most sophisticated one that tracks all patient temporary moves in the healthcare facility.

3.31.2 Use Case Roles

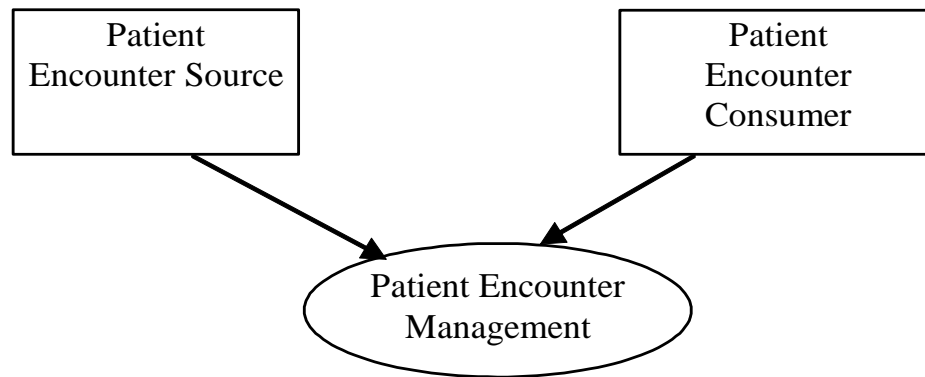

Actor: Patient Encounter Supplier

800 **Role:** Sends inserts, cancels and updates of patient encounters and movements.

Actor: Patient Encounter Consumer

Role: Receives patient encounters and movement messages, and takes the appropriate actions.

3.31.3 Referenced Standards

HL7 2.5 Chapters 2, 3, 6, 15

805 3.31.4 Definition of the concept “Movement”

As stated in Volume 1, a “Movement” is any change of the situation of the patient (location, patient class, attending doctor, etc.) in the context of the encounter.

810 The concept of “Movement” is a superset of the concept of “Transfer”. Like a transfer, a movement is an event that can be planned (pending) and executed (effective). Errors detected in the recording of these pending and effective events can later be corrected through cancellations or updates, which are distinct events. Three actions are associated with Movements:

- **Insert:** This action is the first recording of the Movement.
- **Update:** This action corrects some attributes of a Movement formerly inserted. This action is possible only with the option “Historic Movement Management” of transaction ITI-30.
- **Cancel:** This action cancels a Movement that was erroneously recorded, and requests the receiver to delete this Movement from its database. Only the current Movement can be cancelled.

820 In some acute care settings, both the billing process and care provision process require precise knowledge of the movements of the inpatient during his or her stay in the hospital. Applications acting as Patient Encounter Supplier or Patient Encounter Consumer, divide the period of the encounter into “sub-encounters” delimited by the Movements. Each of these “sub-encounters” provides a specific context to record and invoice the acts produced within this period. However, if applications on both ends manage sub-encounters, which are periods of time, the messages of

825 transaction ITI-31 communicate Movements as events. Hence, applications manage periods of
 time, but the messages carry the discrete events that delimit these periods of time.

Illustration:

- 830
1. Patient received at Emergency room by attending doctor U. (A04 / patient class E).
 2. Doctor U admits the patient (A06 / patient class = I), into location BB, referring him to attending Doctor X.
 3. The patient is moved to location GG (A02Transfer), keeping X for attending doctor.
 4. The patient is healed and leaves the hospital (A03: Discharge).

These 4 real world events are expressed with 5 trigger events / messages, two of which occur at the same time (step 2). Here the encounter will be divided into 3 sub-encounters:

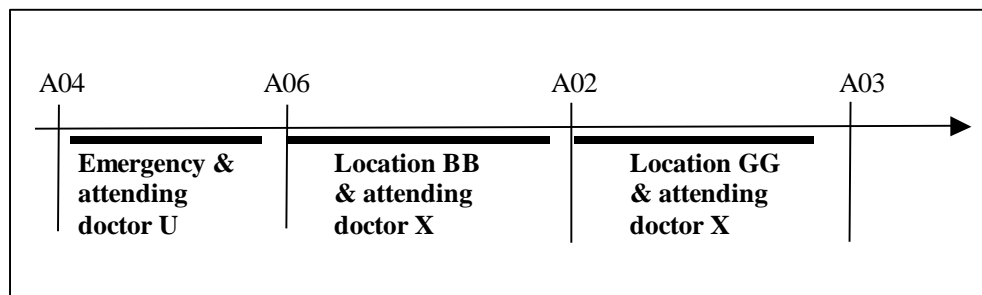

835

3.31.5 Message sets and options

All messages of this transaction shall be acknowledged by the ACK message as described in ITI TF-2x: Appendix C. For better readability, the acknowledgement messages are not shown on the interaction diagrams of this transaction.

840 **3.31.5.1 Basic subset**

Table 3.31-1 Message basic subset for transaction ITI-31

Category of event	Trigger / Action			
	insert		cancel	
Admit inpatient	A01	ADT^A01^ADT_A01	A11	ADT^A11^ADT_A09
Register outpatient	A04	ADT^A04^ADT_A01		
Discharge patient	A03	ADT^A03^ADT_A03	A13	ADT^A13^ADT_A01
Update patient information	A08	ADT^A08^ADT_A01		
Merge patient identifier list	A40	ADT^A40^ADT_A39		

The basic subset of transaction ITI-31 is composed of the above events and related messages. A system implementing either Patient Encounter Supplier or Patient Encounter Consumer, without any further option, shall support these 7 trigger events and messages.

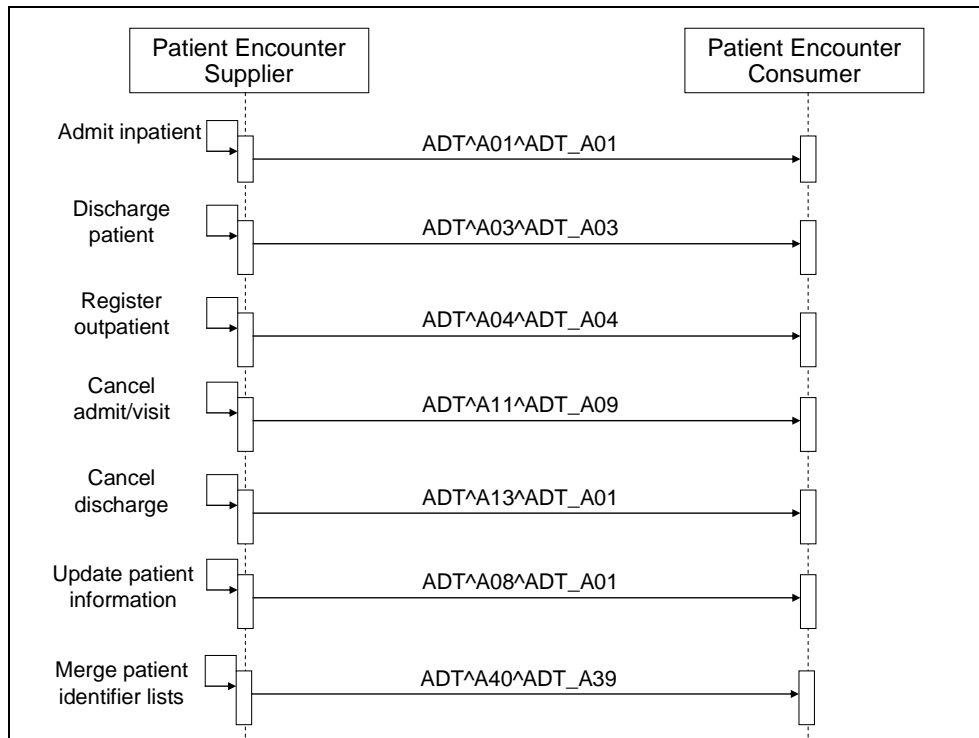

845

Figure 3.31-1 Interaction diagram for the basic subset

3.31.5.2 Inpatient/Outpatient Encounter Management Option

This option adds support for management of patient class (Outpatient, Emergency, Inpatient, Pre-admitted, etc.) and of patient location (point of care, room, bed, etc.).

850

The following is the required message set to support the “Inpatient/Outpatient Encounter Management” option:

Table 3.31-2 Message subset for inpatient/outpatient encounter management option

Category of event	Trigger / Action			
		insert		cancel
Admit inpatient	A01	ADT^A01^ADT_A01	A11	ADT^A11^ADT_A09
Register outpatient	A04	ADT^A04^ADT_A01		
Discharge patient	A03	ADT^A03^ADT_A03	A13	ADT^A13^ADT_A01
Update patient information	A08	ADT^A08^ADT_A01		
Merge patient identifier lists	A40	ADT^A40^ADT_A39		
Pre-admit patient	A05	ADT^A05^ADT_A05	A38	ADT^A38^ADT_A38
Change patient class to inpatient	A06	ADT^A06^ADT_A06		
Change patient class to outpatient	A07	ADT^A07^ADT_A06		
Transfer patient	A02	ADT^A02^ADT_A02	A12	ADT^A12^ADT_A12

A system implementing this option shall support these 13 trigger events and messages.

Figure 3.31-2 depicts the messages added by this option to the basic subset.

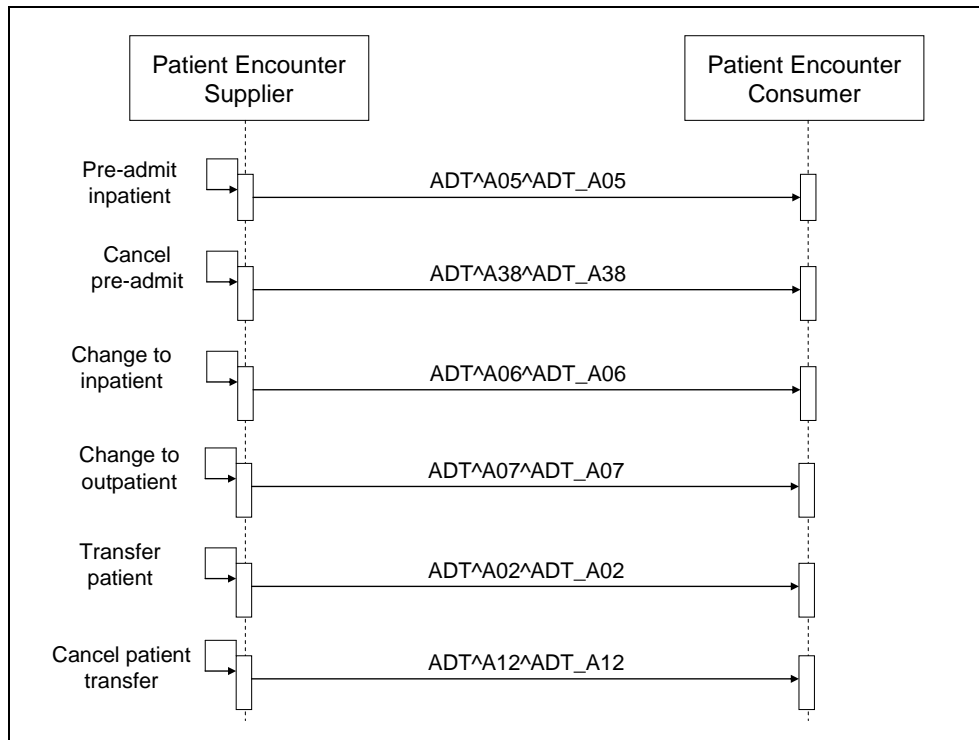

855

Figure 3.31-2 Additional interactions for “Inpatient/Outpatient Encounter Management” option

3.31.5.3 Pending Event Management Option

This option adds support for management of pending events. This option also requires the “Inpatient/Outpatient Encounter Management” option.

860

The following is the required message set to support the “Pending Event Management” option:

Table 3.31-3 Message subset for Pending Event Management option

Category of event	Trigger / Action			
		insert		cancel
Admit inpatient	A01	ADT^A01^ADT_A01	A11	ADT^A11^ADT_A09
Register outpatient	A04	ADT^A04^ADT_A01		
Discharge patient	A03	ADT^A03^ADT_A03	A13	ADT^A13^ADT_A01
Update patient information	A08	ADT^A08^ADT_A01		
Merge patient identifier lists	A40	ADT^A40^ADT_A39		
Pre-admit patient	A05	ADT^A05^ADT_A05	A38	ADT^A38^ADT_A38
Change patient class to inpatient	A06	ADT^A06^ADT_A06		
Change patient class to outpatient	A07	ADT^A07^ADT_A06		
Transfer patient	A02	ADT^A02^ADT_A02	A12	ADT^A12^ADT_A12
Pending admit	A14	ADT^A14^ADT_A05	A27	ADT^A27^ADT_A21
Pending transfer	A15	ADT^A15^ADT_A15	A26	ADT^A26^ADT_A21
Pending discharge	A16	ADT^A16^ADT_A16	A25	ADT^A25^ADT_A21

A system implementing this option shall support these 19 trigger events and messages.

865 Figure 3.31-3 below depicts the messages added by this option to the basic subset and the Inpatient/Outpatient Encounter Management option.

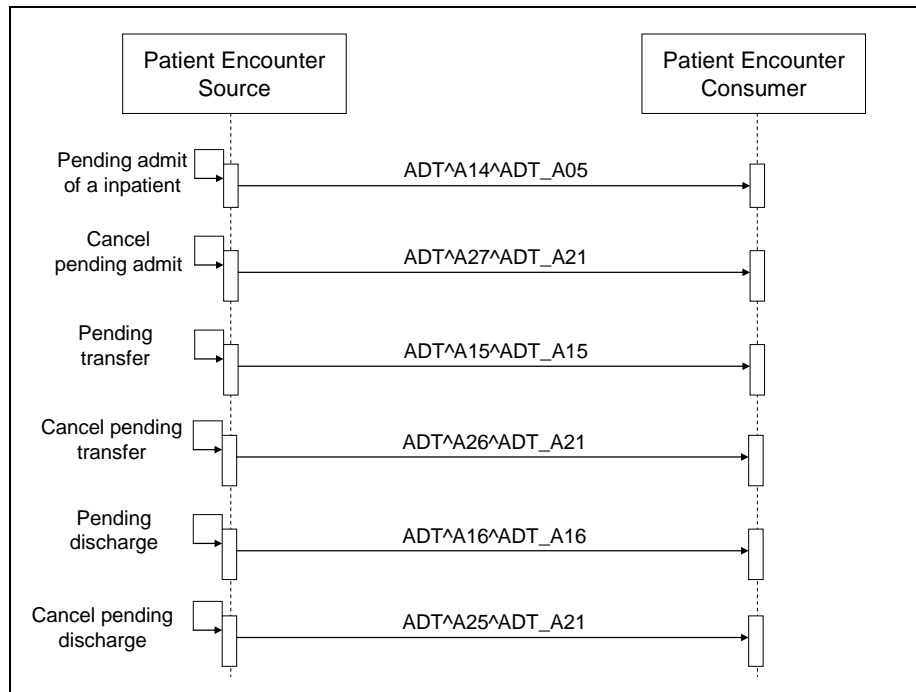

Figure 3.31-3 Additional interactions for “Pending Event Management” option

3.31.5.4 Advanced Encounter Management Option

870 This option provides support to manage changes of attending doctor, leaves of absence, and accounts.

The following is the required message set to support the “Advanced Encounter Management” option:

Table 3.31-4 Message subset for Advanced Encounter Management option

Category of event	Trigger / Action			
	insert		cancel	
Admit inpatient	A01	ADT^A01^ADT_A01	A11	ADT^A11^ADT_A09
Register outpatient	A04	ADT^A04^ADT_A01		
Discharge patient	A03	ADT^A03^ADT_A03	A13	ADT^A13^ADT_A01
Update patient information	A08	ADT^A08^ADT_A01		
Merge patient identifier lists	A40	ADT^A40^ADT_A39		
Change attending doctor	A54	ADT^A54^ADT_A54	A55	ADT^A55^ADT_A52
Leave of absence	A21	ADT^A21^ADT_A21	A52	ADT^A52^ADT_A52
Return from leave of absence	A22	ADT^A22^ADT_A21	A53	ADT^A53^ADT_A52
Move account information	A44	ADT^A44^ADT_A43		

A system implementing this option shall support these 15 trigger events and messages.

875 Figure 3.31-4 below depicts the messages added by this option to the basic subset.

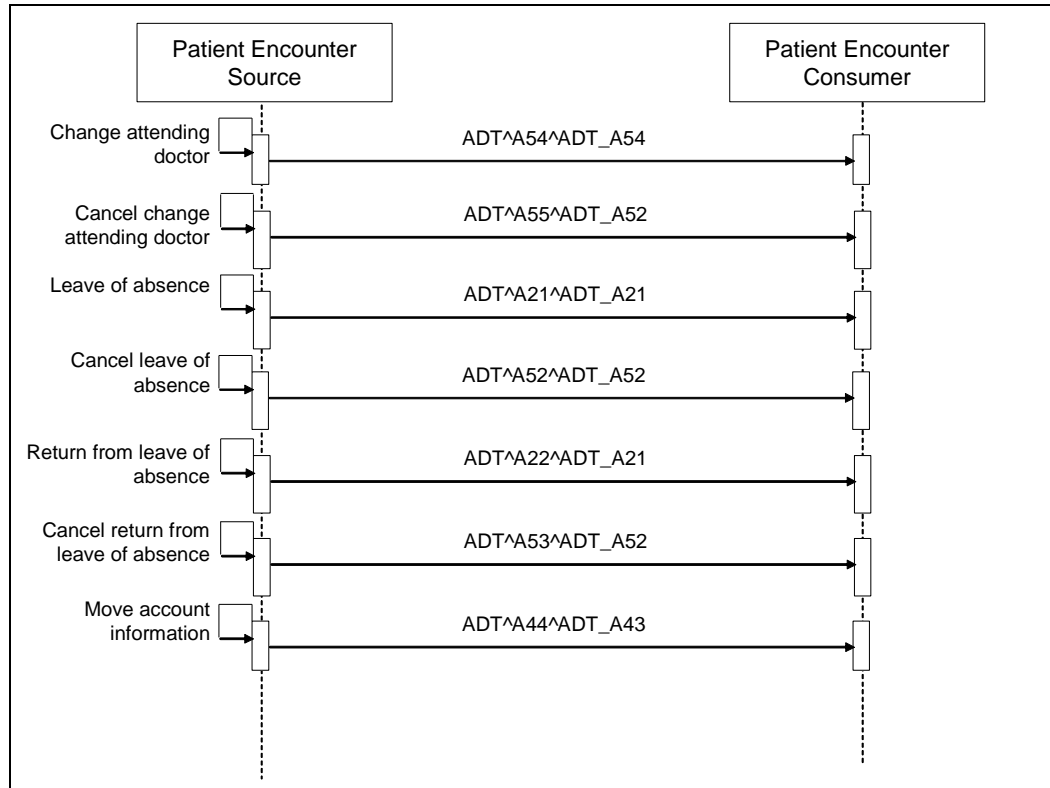

Figure 3.31-4 Additional interactions for “Advanced Encounter Management” option

3.31.5.5 Temporary Patient Transfers Tracking Option

880 This option tracks patient moves to and from temporary locations such as radiotherapy, scanner, EKG, and dialysis.

The following is the required message set to support the “Temporary Patient Transfers Tracking” option:

Table 3.31-5 Message subset for Temporary Patient Transfers Tracking option

Category of event	Trigger / Action			
		insert		cancel
Admit inpatient	A01	ADT^A01^ADT_A01	A11	ADT^A11^ADT_A09
Register outpatient	A04	ADT^A04^ADT_A01		
Discharge patient	A03	ADT^A03^ADT_A03	A13	ADT^A13^ADT_A01
Update patient information	A08	ADT^A08^ADT_A01		
Merge patient identifier lists	A40	ADT^A40^ADT_A39		
Patient departing - Tracking	A09	ADT^A09^ADT_A09	A33	ADT^A33^ADT_A21
Patient arriving - Tracking	A10	ADT^A10^ADT_A09	A32	ADT^A32^ADT_A21

885 A system implementing this option shall support these 10 trigger events and messages.

Figure 3.31-5 below depicts the messages added by this option to the basic subset.

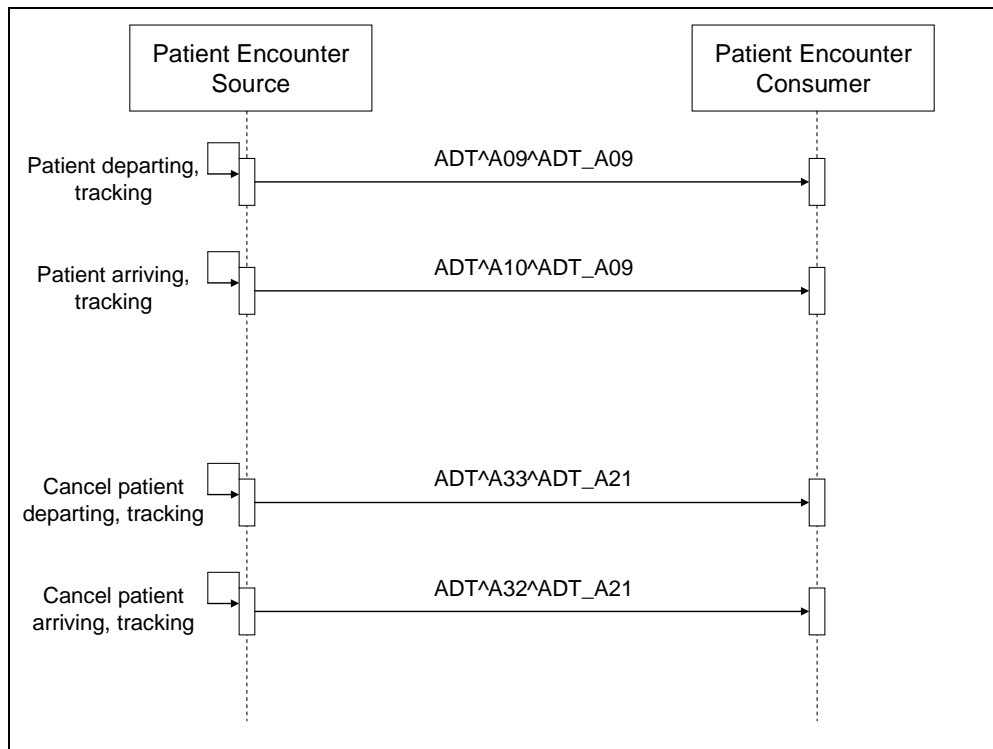

Figure 3.31-5 Additional interactions for “Temporary Patient Transfers Tracking” option

3.31.5.6 Historic Movement Management

890 This option adds the capability to cancel or update safely any Movement.

The Movement updated can be the current Movement (currently active or pending) or a Movement in the past (i.e., historic Movement).

The Movement canceled can only be the current Movement (currently active or pending).

895 This capability is supported by the addition of segment ZBE below PV1/PV2. With this option, this ZBE segment is required at this position in the messages associated with the following trigger events: A01, A02, A03, A04, A05, A06, A07, A11, A12, A13, A14, A15, A16, A21, A22, A25, A26, A27, A38, A52, A53, A54, A55, Z99. In the following sections the ZBE segment is only shown in the message associated with trigger Z99 which is dedicated to the Historic Movement Management option. In the other messages, this segment will appear
900 whenever this option is active.

This segment ZBE brings the following features:

- It enables unique identification of the Movement (including admission and discharge).
- It carries an action code that describes the action to be performed on this Movement: The three possible actions are:

905 ○ **INSERT**: The receiver must interpret the content of this message as a new Movement.

- **CANCEL:** This action code is always associated with a “cancel” trigger event. The receiver shall delete the corresponding Movement (matched with its unique identifier). Only the current Movement can be cancelled.
- 910 ○ **UPDATE:** This action code is associated with the dedicated trigger event Z99 described in ITI TF-2b: 3.31.7.30. The receiver shall update the corresponding Movement (matched with its unique identifier), which can be the current Movement or a historic Movement.
- 915 • In the case of UPDATE or CANCEL, the ZBE segment carries the code of the original trigger event that was associated with the action INSERT of the related Movement.
- It carries an indicator “Historic Movement” informing whether the action to perform is about the current Movement or a Historic one.
- It provides the starting date/time of the “sub-encounter” that this Movement initiates.
- It carries the ward to which this patient is assigned during this sub-encounter.
- 920 This option may apply to any combination of the previous subsets, except Temporary Patient Transfers Tracking (Temporary Patient Transfers do not need to be uniquely identified).

Implementation note: The Patient Encounter Consumer must support transaction log update to maintain integrity of the Movement records.

3.31.6 Common HL7 Message Segments

925 Messages in Transaction 31 use the same common HL7 message segments as those in Transaction 30; refer to ITI TF-2b: 3.30.5. In addition, messages in Transaction 31 use the ZBE segment, described below.

3.31.6.1 ZBE – Movement Action segment

930 The ZBE segment was introduced in the German extension of the IHE Radiology Technical Framework. It is extended here with three additional fields: ZBE-5, ZBE-6 and ZBE-7. This ZBE segment is required with the “Historic Movement” option of transaction ITI-31.

935 The purpose of this segment is to uniquely identify any movement at creation time (action INSERT), so that any further correction brought to this movement (action UPDATE) or cancellation of it (action CANCEL) can be achieved safely and consistently between the two actors Patient Encounter Supplier and Patient Encounter Consumer.

Another security feature offered by this segment is to clearly distinguish current events from events that address a historic (past) movement to avoid any misinterpretation on the part of the receiving application.

Table 3.31-6 ZBE segment description

SEQ	LEN	DT	Usage	Card.	ELEMENT NAME
1		EI	R	[1..*]	Movement ID
2		TS	R	[1..1]	Start Movement Date/Time
3		TS	O	[0..1]	End Movement Date/Time
4		ID	R	[1..1]	Movement Action (INSERT / UPDATE / CANCEL)

SEQ	LEN	DT	Usage	Card.	ELEMENT NAME
5		ID	R	[1..1]	Historical Movement Indicator (values: Y / N)
6		ID	C	[0..1]	Original trigger event code [in the case of an UPDATE of the movement (trigger A08), this field conveys the original trigger event that was sent with the INSERT]
7		XON	O	[0..1]	Responsible Ward (Medical or Nursing Ward, depending of the trigger event of the message)

940 **ZBE-1 – Movement ID (EI):** required and repeatable to support cooperative Movement Management. The Movement Identifier list is created with the action INSERT, and then recalled with further actions such as UPDATE or CANCEL.

945 **ZBE-2 – Start Movement Date/Time (TS):** Required. It is the date/time of the creation of the Movement, i.e., the effective date time of the event that used action INSERT with this Movement.

ZBE-3 – End Movement Date/Time (TS): Optional.

ZBE-4 – Action (ID): Required. Three possible values:

- INSERT: With any trigger event that inserts a movement.
- UPDATE: With trigger event Z99
- 950 • CANCEL: With any “cancel” trigger event.

ZBE-5 – Historic Indicator (ID): Required. Values:

- ‘Y’ when the message is related to a Historic Movement.
- ‘N’ when the message is related to the current (last or next) movement.

ZBE-6 – Original Trigger (ID): Conditional.

955 Condition predicate: This field shall be populated when ZBE-4 contains action UPDATE or CANCEL. In this case, this field is populated with the trigger event that inserted (action INSERT) the movement being currently updated or canceled.

960 **ZBE-7 – Responsible Ward (XON):** Optional. This field may be further constrained in national extensions of this profile. It will, for example, be associated with usage ‘RE’ in the French extension.

3.31.7 Interactions

The following sections contain the static definitions of the messages belonging to the various optional sets described above.

965 The Historic Movement Management option is not shown in these message tables. The reader is reminded that this option adds the ZBE segment below PV1/PV2.

3.31.7.1 Admit/Visit Notification (ADT^A01^ADT_A01)**3.31.7.1.1 Trigger Event**

970 This message is sent by a Patient Encounter Supplier to notify a Patient Encounter Consumer that a patient has arrived at a healthcare facility for an episode of care in which the patient is assigned to an inpatient bed. Such an episode is commonly referred to as “inpatient” care.

MSH-9 is valued ADT^A01^ADT_A01.

3.31.7.1.2 Message Static Definition**Table 3.31-7 Static definition of message ADT^A01^ADT_A01**

Segment	Meaning	Usage	Card.	HL7 chapter
MSH	Message Header	R	[1..1]	2
SFT	Software Segment	O	[0..*]	2
EVN	Event Type	R	[1..1]	2
PID	Patient Identification	R	[1..1]	3
PD1	Additional Demographics	O	[0..1]	3
ROL	Role	O	[0..*]	15
NK1	Next of Kin / Associated Parties	O	[0..*]	3
PV1	Patient Visit	R	[1..1]	3
PV2	Patient Visit – Additional Info	O	[0..1]	3
ROL	Role	O	[0..*]	15
DB1	Disability Information	O	[0..*]	3
OBX	Observation/Result	O	[0..*]	7
AL1	Allergy Information	O	[0..*]	3
DG1	Diagnosis Information	O	[0..*]	6
DRG	Diagnosis Related Group	O	[0..1]	6
---	--- PROCEDURE begin	O	[0..*]	
PR1	Procedures	R	[1..1]	6
ROL	Role	O	[0..*]	15
---	--- PROCEDURE end			
GT1	Guarantor	O	[0..*]	6
---	--- INSURANCE begin	O	[0..*]	
IN1	Insurance	R	[1..1]	6
IN2	Insurance Additional Info.	O	[0..1]	6
IN3	Insurance Additional Info - Cert.	O	[0..1]	6
ROL	Role	O	[0..*]	15
---	--- INSURANCE end			
ACC	Accident Information	O	[0..1]	6
UB1	Universal Bill Information	O	[0..1]	6
UB2	Universal Bill 92 Information	O	[0..1]	6
PDA	Patient Death and Autopsy	O	[0..1]	3

3.31.7.1.3 Comments on segment usage

975 Providers with an ongoing relationship with the patient may be communicated in ROL segments immediately following the PID/PD1 segments. Providers specific to an episode of care may be communicated in ROL segments immediately following the PV1/PV2 segments. Providers specific to a particular insurance carrier may be communicated in ROL segments immediately following the IN1/IN2/IN3 segments.

980 One or more OBX segments may be present to carry “permanent observations” such as the patient weight or height.

3.31.7.1.4 Expected actions

The receiver shall update the patient’s status to indicate that the patient has been admitted.

985 The receiver shall report the result of this operation (success / error) in an acknowledgment message returned to the sender.

In case this Movement (new admission) conflicts with an existing current movement for the patient (an admission is already opened for this patient) the message is discarded and an error condition is raised.

3.31.7.2 Cancel Admit/Visit Notification – ADT^A11^ADT_A09

990 **3.31.7.2.1 Trigger Event**

This message is sent by a Patient Encounter Supplier to cancel a previous notification to a Patient Encounter Consumer as a notification that a patient has been admitted for an inpatient stay (via trigger event A01) or registered for an outpatient visit (via trigger event A04). See ITI TF-2b: 3.31.5.8 for the message to be used to cancel a pre-admit notification, and ITI TF-2b: 3.31.5.14
995 for the message to be used to cancel a pending admit notification.

MSH-9 is valued **ADT^A11^ADT_A09**.

3.31.7.2.2 Message Static Definition

Table 3.31-8 Static definition of message ADT^A11^ADT_A09

Segment	Meaning	Usage	Card.	HL7 chapter
MSH	Message Header	R	[1..1]	2
SFT	Software Segment	O	[0..*]	2
EVN	Event Type	R	[1..1]	2
PID	Patient Identification	R	[1..1]	3
PD1	Additional Demographics	O	[0..1]	3
PV1	Patient Visit	R	[1..1]	3
PV2	Patient Visit – Additional Info	O	[0..1]	3
DB1	Disability Information	O	[0..*]	3
OBX	Observation/Result	O	[0..*]	7
DG1	Diagnosis Information	X	[0..0]	6

3.31.7.2.3 Comments on segment usage

1000 None.

3.31.7.2.4 Expected actions

The receiver shall reset the patient’s status in its system to the value existing immediately before the admit or visit notification was received.

1005 The receiver shall report the result of this operation (success / error) in an acknowledgment message returned to the sender.

In case this Movement conflicts with the current situation of the patient (i.e., no inpatient nor outpatient visit has been opened for this patient) the message is discarded but no error condition is raised.

3.31.7.3 Register a Patient (ADT^A04^ADT_A01)

1010 **3.31.7.3.1 Trigger Event**

This message is sent by a Patient Encounter Supplier to notify a Patient Encounter Consumer that a patient has arrived at a healthcare facility for an episode of care in which the patient is not assigned to a bed. Examples of such episodes include outpatient visits, ambulatory care encounters, and emergency room visits.

1015 MSH-9 is valued **ADT^A04^ADT_A01**.

3.31.7.3.2 Message Static Definition

Table 3.31-9 Static definition of message ADT^A04^ADT_A01

Segment	Meaning	Usage	Card.	HL7 chapter
MSH	Message Header	R	[1..1]	2
SFT	Software Segment	O	[0..*]	2
EVN	Event Type	R	[1..1]	2
PID	Patient Identification	R	[1..1]	3
PD1	Additional Demographics	O	[0..1]	3
ROL	Role	O	[0..*]	15
NK1	Next of Kin / Associated Parties	O	[0..*]	3
PV1	Patient Visit	R	[1..1]	3
PV2	Patient Visit – Additional Info	O	[0..1]	3
ROL	Role	O	[0..*]	15
DB1	Disability Information	O	[0..*]	3
OBX	Observation/Result	O	[0..*]	7
AL1	Allergy Information	O	[0..*]	3
DG1	Diagnosis Information	O	[0..*]	6
DRG	Diagnosis Related Group	O	[0..1]	6
---	--- PROCEDURE begin	O	[0..*]	
PR1	Procedures	R	[1..1]	6

Segment	Meaning	Usage	Card.	HL7 chapter
ROL	Role	O	[0..*]	15
---	--- PROCEDURE end			
GT1	Guarantor	O	[0..*]	6
---	--- INSURANCE begin	O	[0..*]	
IN1	Insurance	R	[1..1]	6
IN2	Insurance Additional Info.	O	[0..1]	6
IN3	Insurance Additional Info - Cert.	O	[0..1]	6
ROL	Role	O	[0..*]	15
---	--- INSURANCE end			
ACC	Accident Information	O	[0..1]	6
UB1	Universal Bill Information	O	[0..1]	6
UB2	Universal Bill 92 Information	O	[0..1]	6
PDA	Patient Death and Autopsy	O	[0..1]	3

3.31.7.3.3 Comments on segment usage

Field *PV1-44-admit date/time* is used to carry the date and time that the encounter started.

- 1020 Providers with an ongoing relationship with the patient may be communicated in ROL segments immediately following the PID/PD1 segments. Providers specific to an episode of care may be communicated in ROL segments immediately following the PV1/PV2 segments. Providers specific to a particular insurance carrier may be communicated in ROL segments immediately following the IN1/IN2/IN3 segments.
- 1025 One or more OBX segments may be present to carry “permanent observations” such as the patient weight or height.

3.31.7.3.4 Expected actions

The receiver shall update the patient’s status to indicate that the visit has started.

- 1030 The receiver shall report the result of this operation (success / error) in an acknowledgment message returned to the sender.

In case an inpatient encounter is already opened, the outpatient encounter is still recorded by the receiver. This is not a situation of conflict and no error condition is raised.

3.31.7.4 Discharge/End Visit (ADT^A03^ADT_A03)

3.31.7.4.1 Trigger Event

- 1035 This message is sent by a Patient Encounter Supplier to notify a Patient Encounter Consumer that a patient’s stay at a healthcare facility has ended. Inpatient encounters are generally closed by an A03. Outpatient encounters may or may not be closed by an A03, depending on the healthcare organization policies.

MSH-9 is valued **ADT^A03^ADT_A03**.

1040 **3.31.7.4.2 Message Static Definition****Table 3.31-10 Static definition of message ADT^A03^ADT_A03**

Segment	Meaning	Usage	Card.	HL7 chapter
MSH	Message Header	R	[1..1]	2
SFT	Software Segment	O	[0..*]	2
EVN	Event Type	R	[1..1]	2
PID	Patient Identification	R	[1..1]	3
PD1	Additional Demographics	O	[0..1]	3
ROL	Role	O	[0..*]	15
NK1	Next of Kin / Associated Parties	O	[0..*]	3
PV1	Patient Visit	R	[1..1]	3
PV2	Patient Visit – Additional Info	X	[0..0]	3
ROL	Role	O	[0..*]	15
DB1	Disability Information	O	[0..*]	3
AL1	Allergy Information	O	[0..*]	3
DG1	Diagnosis Information	O	[0..*]	6
DRG	Diagnosis Related Group	O	[0..1]	6
---	--- PROCEDURE begin	O	[0..*]	
PR1	Procedures	R	[1..1]	6
ROL	Role	O	[0..*]	15
---	--- PROCEDURE end			
OBX	Observation/Result	O	[0..*]	7
GT1	Guarantor	O	[0..*]	6
---	--- INSURANCE begin	O	[0..*]	
IN1	Insurance	R	[1..1]	6
IN2	Insurance Additional Info.	O	[0..1]	6
IN3	Insurance Additional Info - Cert.	O	[0..1]	6
ROL	Role	O	[0..*]	15
---	--- INSURANCE end			
ACC	Accident Information	O	[0..1]	6
PDA	Patient Death and Autopsy	O	[0..1]	3

3.31.7.4.3 Comments on segment usage

Field *PV1-3-assigned patient location* is used to indicate the patient's last location prior to discharge (or end of visit).

1045 Field *PV1-45-discharge date/time* is used to carry either the date and time of discharge (for an inpatient) or the date and time that the visit ended (for an outpatient).

1050 Providers with an ongoing relationship with the patient may be communicated in ROL segments immediately following the PID/PD1 segments. Providers specific to an episode of care may be communicated in ROL segments immediately following the PV1/PV2 segments. Providers specific to a particular insurance carrier may be communicated in ROL segments immediately following the IN1/IN2/IN3 segments.

If the patient is deceased, fields *PID-29-Patient Death Date and Time* and *PID-30-Patient Death Indicator* shall be populated.

3.31.7.4.4 Expected actions

1055 The receiver shall update the patient's status to "discharged" (or "visit ended").

The receiver shall report the result of this operation (success / error) in an acknowledgment message returned to the sender.

In case this Movement conflicts with the current situation of the patient (no inpatient nor outpatient visit opened for this patient) the message is discarded but no error condition is raised.

1060 3.31.7.5 Cancel Discharge/End Visit – ADT^A13^ADT_A01

3.31.7.5.1 Trigger Event

This message is sent by a Patient Encounter Supplier to a Patient Encounter Consumer to cancel a previous notification (via trigger event A03) that a patient's stay at a healthcare facility had ended.

1065 MSH-9 is valued ADT^A13^ADT_A01.

3.31.7.5.2 Message Static Definition

Table 3.31-11 Static definition of message ADT^A13^ADT_A01

Segment	Meaning	Usage	Card.	HL7 chapter
MSH	Message Header	R	[1..1]	2
SFT	Software Segment	O	[0..*]	2
EVN	Event Type	R	[1..1]	2
PID	Patient Identification	R	[1..1]	3
PD1	Additional Demographics	O	[0..1]	3
ROL	Role	O	[0..*]	15
NK1	Next of Kin / Associated Parties	O	[0..*]	3
PV1	Patient Visit	R	[1..1]	3
PV2	Patient Visit – Additional Info	O	[0..1]	3
ROL	Role	O	[0..*]	15
DB1	Disability Information	O	[0..*]	3
OBX	Observation/Result	O	[0..*]	7
AL1	Allergy Information	O	[0..*]	3
DG1	Diagnosis Information	O	[0..*]	6
DRG	Diagnosis Related Group	O	[0..1]	6
---	--- PROCEDURE begin	O	[0..*]	
PR1	Procedures	R	[1..1]	6
ROL	Role	O	[0..*]	15
---	--- PROCEDURE end			
GT1	Guarantor	O	[0..*]	6
---	--- INSURANCE begin	O	[0..*]	

Segment	Meaning	Usage	Card.	HL7 chapter
IN1	Insurance	R	[1..1]	6
IN2	Insurance Additional Info.	O	[0..1]	6
IN3	Insurance Additional Info - Cert.	O	[0..1]	6
ROL	Role	O	[0..*]	15
---	--- INSURANCE end			
ACC	Accident Information	O	[0..1]	6
UB1	Universal Bill Information	O	[0..1]	6
UB2	Universal Bill 92 Information	O	[0..1]	6
PDA	Patient Death and Autopsy	O	[0..1]	3

3.31.7.5.3 Comments on segment usage

1070 Field *PV1-3-patient location* shall contain the patient's location after the cancellation has been processed. This may be different from the patient's location prior to the discharge/end visit notification.

3.31.7.5.4 Expected actions

The receiver shall reset the patient's status to its value prior to the receipt of the discharge/end visit message, and shall update the patient's location to the value in field PV1-3-patient location.

1075 The receiver shall report the result of this operation (success / error) in an acknowledgment message returned to the sender.

In case this Movement conflicts with the current situation of the patient (no prior discharge received) the message is discarded but no error condition is raised.

3.31.7.6 Update Patient Information (ADT^A08^ADT_A01)

1080 3.31.7.6.1 Trigger Event

This message is sent by a Patient Encounter Supplier to notify a Patient Encounter Consumer that some non-movement-related information (such as address, date of birth, etc.) has changed for a patient. It is used when information about the patient has changed not related to any other trigger event.

1085 MSH-9 is valued **ADT^A08^ADT_A01**.

3.31.7.6.2 Message Static Definition

Table 3.31-12 Static definition of message ADT^A08^ADT_A01

Segment	Meaning	Usage	Card.	HL7 chapter
MSH	Message Header	R	[1..1]	2
SFT	Software Segment	O	[0..*]	2
EVN	Event Type	R	[1..1]	2
PID	Patient Identification	R	[1..1]	3
PD1	Additional Demographics	O	[0..1]	3

Segment	Meaning	Usage	Card.	HL7 chapter
ROL	Role	O	[0..*]	15
NK1	Next of Kin / Associated Parties	O	[0..*]	3
PV1	Patient Visit	R	[1..1]	3
PV2	Patient Visit – Additional Info	O	[0..1]	3
ROL	Role	O	[0..*]	15
DB1	Disability Information	O	[0..*]	3
OBX	Observation/Result	O	[0..*]	7
AL1	Allergy Information	O	[0..*]	3
DG1	Diagnosis Information	O	[0..*]	6
DRG	Diagnosis Related Group	O	[0..1]	6
---	--- PROCEDURE begin	O	[0..*]	
PR1	Procedures	R	[1..1]	6
ROL	Role	O	[0..*]	15
---	--- PROCEDURE end			
GT1	Guarantor	O	[0..*]	6
---	--- INSURANCE begin	O	[0..*]	
IN1	Insurance	R	[1..1]	6
IN2	Insurance Additional Info.	O	[0..1]	6
IN3	Insurance Additional Info - Cert.	O	[0..1]	6
ROL	Role	O	[0..*]	15
---	--- INSURANCE end			
ACC	Accident Information	O	[0..1]	6
UB1	Universal Bill Information	O	[0..1]	6
UB2	Universal Bill 92 Information	O	[0..1]	6
PDA	Patient Death and Autopsy	O	[0..1]	3

3.31.7.6.3 Comments on segment usage

1090 Providers with an ongoing relationship with the patient may be communicated in ROL segments immediately following the PID/PD1 segments. Providers specific to an episode of care may be communicated in ROL segments immediately following the PV1/PV2 segments. Providers specific to a particular insurance carrier may be communicated in ROL segments immediately following the IN1/IN2/IN3 segments.

1095 One or more OBX segments may be present to carry “permanent observations” such as the patient weight or height.

3.31.7.6.4 Expected actions

The receiver shall update the patient record in its database to contain the information in the message.

1100 The receiver shall report the result of this operation (success / error) in an acknowledgment message returned to the sender.

In case this Movement conflicts with the current situation of the patient (no active encounter for this patient, or the patient is unknown) the message is discarded but no error condition is raised.

3.31.7.7 Pre-Admit (ADT^A05^ADT_A05)

3.31.7.7.1 Trigger Event

1105 This message is sent by a Patient Encounter Supplier to a Patient Encounter Consumer to communicate information that has been collected about a patient to be admitted as an inpatient (or to be registered as an outpatient).

MSH-9 is valued ADT^A05^ADT_A05.

1110 3.31.7.7.2 Message Static Definition

Table 3.31-13 Static definition of message ADT^A05^ADT_A05

Segment	Meaning	Usage	Card.	HL7 chapter
MSH	Message Header	R	[1..1]	2
SFT	Software Segment	O	[0..*]	2
EVN	Event Type	R	[1..1]	2
PID	Patient Identification	R	[1..1]	3
PD1	Additional Demographics	O	[0..1]	3
ROL	Role	O	[0..*]	15
NK1	Next of Kin / Associated Parties	O	[0..*]	3
PV1	Patient Visit	R	[1..1]	3
PV2	Patient Visit – Additional Info	X	[0..0]	3
ROL	Role	O	[0..*]	15
DB1	Disability Information	O	[0..*]	3
OBX	Observation/Result	O	[0..*]	7
AL1	Allergy Information	O	[0..*]	3
DG1	Diagnosis Information	O	[0..*]	6
DRG	Diagnosis Related Group	O	[0..1]	6
---	--- PROCEDURE begin	O	[0..*]	
PR1	Procedures	R	[1..1]	6
ROL	Role	O	[0..*]	15
---	--- PROCEDURE end			
GT1	Guarantor	O	[0..*]	6
---	--- INSURANCE begin	O	[0..*]	
IN1	Insurance	R	[1..1]	6
IN2	Insurance Additional Info.	O	[0..1]	6
IN3	Insurance Additional Info - Cert.	O	[0..1]	6
ROL	Role	O	[0..*]	15
---	--- INSURANCE end			
ACC	Accident Information	O	[0..1]	6

UB1	Universal Bill Information	O	[0..1]	6
UB2	Universal Bill 92 Information	O	[0..1]	6
PDA	Patient Death and Autopsy	O	[0..1]	3

3.31.7.7.3 Comments on segment usage

Field *PV2-8-expected admit date/time* is used to carry the expected date and time when the patient is to be admitted (or registered).

- 1115 Providers with an ongoing relationship with the patient may be communicated in ROL segments immediately following the PID/PD1 segments. Providers specific to an episode of care may be communicated in ROL segments immediately following the PV1/PV2 segments. Providers specific to a particular insurance carrier may be communicated in ROL segments immediately following the IN1/IN2/IN3 segments.
- 1120 One or more OBX segments may be present to carry “permanent observations” such as the patient weight or height.

3.31.7.7.4 Expected actions

The receiver shall update the patient’s status to pre-admitted.

- 1125 The receiver shall report the result of this operation (success / error) in an acknowledgment message returned to the sender.

There is no particular potential conflict between this Movement and any previously received message related to the same patient.

If the receiver does not support the Inpatient/Outpatient Encounter Management option of this transaction, it shall application-reject the message (see ITI TF-2x: C.2.3).

1130 3.31.7.8 Cancel Pre-Admit – ADT^A38^ADT_A38

3.31.7.8.1 Trigger Event

This message is sent by a Patient Encounter Supplier to a Patient Encounter Consumer to cancel a previous notification (via trigger event A08) that a patient was to be updated to pre-admitted (or pre-registered) status.

- 1135 MSH-9 is valued **ADT^A38^ADT_A38**.

3.31.7.8.2 Message Static Definition

Table 3.31-14 Static definition of message ADT^A38^ADT_A38

Segment	Meaning	Usage	Card.	HL7 chapter
MSH	Message Header	R	[1..1]	2
SFT	Software Segment	O	[0..*]	2
EVN	Event Type	R	[1..1]	2
PID	Patient Identification	R	[1..1]	3
PD1	Additional Demographics	O	[0..1]	3
PV1	Patient Visit	R	[1..1]	3

Segment	Meaning	Usage	Card.	HL7 chapter
PV2	Patient Visit – Additional Info	O	[0..1]	3
DB1	Disability Information	O	[0..*]	3
OBX	Observation/Result	O	[0..*]	7
DG1	Diagnosis Information	O	[0..*]	6
DRG	Diagnosis Related Group	O	[0..*]	6

3.31.7.8.3 Comments on segment usage

None.

1140 3.31.7.8.4 Expected actions

The receiver shall reset the patient's status to its value prior to the receipt of the pre-admit message.

The receiver shall report the result of this operation (success / error) in an acknowledgment message returned to the sender.

1145 In case this Movement conflicts with the current situation of the patient (no pre-admit registered for this patient, or the patient is unknown) the message is discarded but no error condition is raised.

If the receiver does not support the Inpatient/Outpatient Encounter Management option of this transaction, it shall application-reject the message (see ITI TF-2x: C.2.3).

1150 3.31.7.9 Change Outpatient to Inpatient (ADT^A06^ADT_A06)

3.31.7.9.1 Trigger Event

This message is sent by a Patient Encounter Supplier to notify a Patient Encounter Consumer that it has been decided to admit a patient that was formerly in a non-admitted status, such as Emergency.

1155 MSH-9 is valued ADT^A06^ADT_A06.

3.31.7.9.2 Message Static Definition

Table 3.31-15 Static definition of message ADT^A06^ADT_A06

Segment	Meaning	Usage	Card.	HL7 chapter
MSH	Message Header	R	[1..1]	2
SFT	Software Segment	O	[0..*]	2
EVN	Event Type	R	[1..1]	2
PID	Patient Identification	R	[1..1]	3
PD1	Additional Demographics	O	[0..1]	3
ROL	Role	O	[0..*]	15
MRG	Merge Information	C	[0..1]	3
NK1	Next of Kin / Associated Parties	O	[0..*]	3
PV1	Patient Visit	R	[1..1]	3

PV2	Patient Visit – Additional Info	X	[0..0]	3
ROL	Role	O	[0..*]	15
DB1	Disability Information	O	[0..*]	3
OBX	Observation/Result	O	[0..*]	7
AL1	Allergy Information	O	[0..*]	3
DG1	Diagnosis Information	O	[0..*]	6
DRG	Diagnosis Related Group	O	[0..1]	6
---	--- PROCEDURE begin	O	[0..*]	
PR1	Procedures	R	[1..1]	6
ROL	Role	O	[0..*]	15
---	--- PROCEDURE end			
GT1	Guarantor	O	[0..*]	6
---	--- INSURANCE begin	O	[0..*]	
IN1	Insurance	R	[1..1]	6
IN2	Insurance Additional Info.	O	[0..1]	6
IN3	Insurance Additional Info - Cert.	O	[0..1]	6
ROL	Role	O	[0..*]	15
---	--- INSURANCE end			
ACC	Accident Information	O	[0..1]	6
UB1	Universal Bill Information	O	[0..1]	6
UB2	Universal Bill 92 Information	O	[0..1]	6

3.31.7.9.3 Comments on segment usage

1160 The new patient location should appear in *PV1-3 - Assigned Patient Location* while the old patient location (if different) should appear in *PV1-6 - Prior Patient Location*.

Condition predicate on use of the segment MRG:

1165 A change from outpatient to inpatient status may be accompanied by the closing of the outpatient account and the opening of an inpatient account. This may be expressed by populating the outpatient account number into *MRG-3-prior account number* and the inpatient account number into *PID-18-patient account number*. The use of the MRG segment in this case is strictly conventional and is not intended to communicate an actual merge.

1170 Providers with an ongoing relationship with the patient may be communicated in ROL segments immediately following the PID/PD1 segments. Providers specific to an episode of care may be communicated in ROL segments immediately following the PV1/PV2 segments. Providers specific to a particular insurance carrier may be communicated in ROL segments immediately following the IN1/IN2/IN3 segments.

One or more OBX segments may be present to carry “permanent observations” such as the patient weight or height.

1175 **3.31.7.9.4 Expected actions**

The receiver shall update the patient's class to "inpatient," and if necessary shall update the patient's location to the value in field *PVI-3-patient location*.

If the MRG segment is included, the receiver shall update the patient's account number from the value in *MRG-3-prior account number* to the value in *PID-18-patient account number*.

1180 The receiver shall report the result of this operation (success / error) in an acknowledgment message returned to the sender.

In case this Movement conflicts with the current situation of the patient (no active outpatient encounter is known for this patient, or the patient is unknown) the message is still processed and initiates a new inpatient encounter for a possibly new patient, and no error condition is raised.

1185 If the receiver does not support the Inpatient/Outpatient Encounter Management option of this transaction, it shall application-reject the message (see ITI TF-2x: C.2.3).

3.31.7.10 Change Inpatient to Outpatient (ADT^A07^ADT_A06)**3.31.7.10.1 Trigger Event**

1190 This message is sent by a Patient Encounter Supplier to notify a Patient Encounter Consumer that a patient is no longer in an "admitted" status, but is still being seen for an episode of care.

MSH-9 is valued **ADT^A07^ADT_A06**.

3.31.7.10.2 Message Static Definition**Table 3.31-16 Static definition of message ADT^A07^ADT_A06**

Segment	Meaning	Usage	Card.	HL7 chapter
MSH	Message Header	R	[1..1]	2
SFT	Software Segment	O	[0..*]	2
EVN	Event Type	R	[1..1]	2
PID	Patient Identification	R	[1..1]	3
PD1	Additional Demographics	O	[0..1]	3
ROL	Role	O	[0..*]	15
MRG	Merge Information	C	[0..1]	3
NK1	Next of Kin / Associated Parties	O	[0..*]	3
PV1	Patient Visit	R	[1..1]	3
PV2	Patient Visit – Additional Info	X	[0..0]	3
ROL	Role	O	[0..*]	15
DB1	Disability Information	O	[0..*]	3
OBX	Observation/Result	O	[0..*]	7
AL1	Allergy Information	O	[0..*]	3
DG1	Diagnosis Information	O	[0..*]	6
DRG	Diagnosis Related Group	O	[0..1]	6

---	--- PROCEDURE begin	O	[0..*]	
PR1	Procedures	R	[1..1]	6
ROL	Role	O	[0..*]	15
---	--- PROCEDURE end			
GT1	Guarantor	O	[0..*]	6
---	--- INSURANCE begin	O	[0..*]	
IN1	Insurance	R	[1..1]	6
IN2	Insurance Additional Info.	O	[0..1]	6
IN3	Insurance Additional Info - Cert.	O	[0..1]	6
ROL	Role	O	[0..*]	15
---	--- INSURANCE end			
ACC	Accident Information	O	[0..1]	6
UB1	Universal Bill Information	O	[0..1]	6
UB2	Universal Bill 92 Information	O	[0..1]	6

1195 3.31.7.10.3 Comments on segment usage

The new patient location should appear in *PV1-3 - Assigned Patient Location* while the old patient location (if different) should appear in *PV1-6 - Prior Patient Location*.

Condition predicate on use of the segment MRG:

- 1200 A change from inpatient to outpatient status may be accompanied by the closing of the inpatient account and the opening of an outpatient account. This may be expressed by populating the inpatient account number into *MRG-3-prior account number* and the outpatient account number into *PID-18-patient account number*. The use of the MRG segment in this case is strictly conventional and is not intended to communicate an actual merge.
- 1205 Providers with an ongoing relationship with the patient may be communicated in ROL segments immediately following the PID/PD1 segments. Providers specific to an episode of care may be communicated in ROL segments immediately following the PV1/PV2 segments. Providers specific to a particular insurance carrier may be communicated in ROL segments immediately following the IN1/IN2/IN3 segments.
- 1210 One or more OBX segments may be present to carry “permanent observations” such as the patient weight or height.

3.31.7.10.4 Expected actions

The receiver shall update the patient’s class to “outpatient,” and if necessary shall update the patient’s location to the value in field *PV1-3-patient location*.

- 1215 If the MRG segment is included, the receiver shall update the patient’s account number from the value in *MRG-3-prior account number* to the value in *PID-18-patient account number*.

The receiver shall report the result of this operation (success / error) in an acknowledgment message returned to the sender.

1220 In case this Movement conflicts with the current situation of the patient (no active inpatient encounter is known for this patient, or the patient is unknown) the message is still processed and initiates a new outpatient encounter for a possibly new patient, and no error condition is raised.

If the receiver does not support the Inpatient/Outpatient Encounter Management option of this transaction, it shall application-reject the message (see ITI TF-2x: C.2.3).

3.31.7.11 Transfer a Patient (ADT^A02^ADT_A02)

1225 3.31.7.11.1 Trigger Event

This message is sent by a Patient Encounter Supplier to notify a Patient Encounter Consumer that a patient is being transferred from one location to another. The new location will be reflected in the institution's bed census.

MSH-9 is valued ADT^A02^ADT_A02.

1230 3.31.7.11.2 Message Static Definition

Table 3.31-17 Static definition of message ADT^A02^ADT_A02

Segment	Meaning	Usage	Card.	HL7 chapter
MSH	Message Header	R	[1..1]	2
SFT	Software Segment	O	[0..*]	2
EVN	Event Type	R	[1..1]	2
PID	Patient Identification	R	[1..1]	3
PD1	Additional Demographics	O	[0..1]	3
ROL	Role	O	[0..*]	15
PV1	Patient Visit	R	[1..1]	3
PV2	Patient Visit – Additional Info	O	[0..1]	3
ROL	Role	O	[0..*]	15
DB1	Disability Information	O	[0..*]	3
OBX	Observation/Result	O	[0..*]	7
PDA	Patient Death and Autopsy	O	[0..1]	3

3.31.7.11.3 Comments on segment usage

The new patient location should appear in *PV1-3 - Assigned Patient Location* while the old patient location should appear in *PV1-6 - Prior Patient Location*.

1235 Providers with an ongoing relationship with the patient may be communicated in ROL segments immediately following the PID/PD1 segments. Providers specific to an episode of care may be communicated in ROL segments immediately following the PV1/PV2 segments.

One or more OBX segments may be present to carry “permanent observations” such as the patient weight or height.

1240 Segment DG1 should be used to communicate diagnosis information only if it is necessary to communicate with a receiver that is using a version of HL7 prior to V2.5.

3.31.7.11.4 Expected actions

The receiver shall update the patient’s location to the value in field *PV1-3-patient location*.

1245 The receiver shall report the result of this operation (success / error) in an acknowledgment message returned to the sender.

In case this Movement conflicts with the current situation of the patient (no active inpatient encounter is known for this patient, or the patient is unknown or the known patient location was not the one declared in PV1-6) the message is still processed, the new situation is registered (the encounter and the patient are created if needed) and no error condition is raised.

1250 If the receiver does not support the Inpatient/Outpatient Encounter Management option of this transaction, it shall application-reject the message (see ITI TF-2x: C.2.3).

3.31.7.12 Cancel Transfer – ADT^A12^ADT_A12

3.31.7.12.1 Trigger Event

1255 This message is sent by a Patient Encounter Supplier to a Patient Encounter Consumer to cancel a previous notification (via trigger event A02) that a patient was being moved from one location to another.

MSH-9 is valued **ADT^A12^ADT_A12**.

3.31.7.12.2 Message Static Definition

Table 3.31-18 Static definition of message ADT^A12^ADT_A12

Segment	Meaning	Usage	Card.	HL7 chapter
MSH	Message Header	R	[1..1]	2
SFT	Software Segment	O	[0..*]	2
EVN	Event Type	R	[1..1]	2
PID	Patient Identification	R	[1..1]	3
PD1	Additional Demographics	O	[0..1]	3
PV1	Patient Visit	R	[1..1]	3
PV2	Patient Visit – Additional Info	O	[0..1]	3
DB1	Disability Information	O	[0..*]	3
OBX	Observation/Result	O	[0..*]	7
DG1	Diagnosis Information	X	[0..0]	6

1260 **3.31.7.12.3 Comments on segment usage**

Field *PV1-3-patient location* shall contain the patient’s location prior to the transfer.

3.31.7.12.4 Expected actions

1265 The receiver shall reset the patient’s location to the value in field *PV1-11-temporary location* or to the value in field *PV1-3-patient location*, as appropriate.

The receiver shall report the result of this operation (success / error) in an acknowledgment message returned to the sender.

1270 In case this Movement conflicts with the current situation of the patient (no transfer previously notified, or encounter unknown, or patient unknown) the message is discarded, and no error condition is raised.

If the receiver does not support the Inpatient/Outpatient Encounter Management option of this transaction, it shall application-reject the message (see ITI TF-2x: C.2.3).

3.31.7.13 Pending Admit (ADT^A14^ADT_A05)

1275 3.31.7.13.1 Trigger Event

This message is sent by a Patient Encounter Supplier to notify a Patient Encounter Consumer that it is planned to admit a patient.

MSH-9 is valued ADT^A14^ADT_A05.

3.31.7.13.2 Message Static Definition

1280

Table 3.31-19 Static definition of message ADT^A14^ADT_A05

Segment	Meaning	Usage	Card.	HL7 chapter
MSH	Message Header	R	[1..1]	2
SFT	Software Segment	O	[0..*]	2
EVN	Event Type	R	[1..1]	2
PID	Patient Identification	R	[1..1]	3
PD1	Additional Demographics	O	[0..1]	3
ROL	Role	O	[0..*]	15
NK1	Next of Kin / Associated Parties	O	[0..*]	3
PV1	Patient Visit	R	[1..1]	3
PV2	Patient Visit – Additional Info	X	[0..0]	3
ROL	Role	O	[0..*]	15
DB1	Disability Information	O	[0..*]	3
OBX	Observation/Result	O	[0..*]	7
AL1	Allergy Information	O	[0..*]	3
DG1	Diagnosis Information	O	[0..*]	6
DRG	Diagnosis Related Group	O	[0..1]	6
---	--- PROCEDURE begin	O	[0..*]	
PR1	Procedures	R	[1..1]	6
ROL	Role	O	[0..*]	15
---	--- PROCEDURE end			
GT1	Guarantor	O	[0..*]	6
---	--- INSURANCE begin	O	[0..*]	
IN1	Insurance	R	[1..1]	6

IN2	Insurance Additional Info.	O	[0..1]	6
IN3	Insurance Additional Info - Cert.	O	[0..1]	6
ROL	Role	O	[0..*]	15
---	--- INSURANCE end			
ACC	Accident Information	O	[0..1]	6
UB1	Universal Bill Information	O	[0..1]	6
UB2	Universal Bill 92 Information	O	[0..1]	6
PDA	Patient Death and Autopsy	O	[0..1]	3

3.31.7.13.3 Comments on segment usage

Field *PV2-8-expected admit date/time* is used to carry the expected date and time when the patient is to be admitted.

1285 One or more OBX segments may be present to carry “permanent observations” such as the patient weight or height.

3.31.7.13.4 Expected actions

The receiver shall update the patient’s status to “pending admit”.

The receiver shall report the result of this operation (success / error) in an acknowledgment message returned to the sender.

1290 There is no particular potential conflict between this Movement and any previously received message related to the same patient.

If the receiver does not support the Pending Event Management option of this transaction, it shall application-reject the message (see ITI TF-2x: C.2.3).

3.31.7.14 Cancel Pending Admit – ADT^A27^ADT_A21

1295 **3.31.7.14.1 Trigger Event**

This message is sent by a Patient Encounter Supplier to a Patient Encounter Consumer to cancel a previous notification (via trigger event A14) that a patient was expected to be admitted.

MSH-9 is valued **ADT^A27^ADT_A21**.

3.31.7.14.2 Message Static Definition

1300 **Table 3.31-20 Static definition of message ADT^A27^ADT_A21**

Segment	Meaning	Usage	Card.	HL7 chapter
MSH	Message Header	R	[1..1]	2
SFT	Software Segment	O	[0..*]	2
EVN	Event Type	R	[1..1]	2
PID	Patient Identification	R	[1..1]	3
PD1	Additional Demographics	O	[0..1]	3
PV1	Patient Visit	R	[1..1]	3
PV2	Patient Visit – Additional Info	O	[0..1]	3

Segment	Meaning	Usage	Card.	HL7 chapter
DB1	Disability Information	O	[0..*]	3
OBX	Observation/Result	O	[0..*]	7

3.31.7.14.3 Comments on segment usage

One or more OBX segments may be present to carry “permanent observations” such as the patient weight or height.

3.31.7.14.4 Expected actions

1305 The receiver shall reset the patient’s status to its value prior to the receipt of the “pending admit” message.

The receiver shall report the result of this operation (success / error) in an acknowledgment message returned to the sender.

1310 In case this Movement conflicts with the current situation of the patient (no pending admit previously notified, or patient unknown) the message is discarded, and no error condition is raised.

If the receiver does not support the Pending Event Management option of this transaction, it shall application-reject the message (see ITI TF-2x: C.2.3).

3.31.7.15 Pending Transfer (ADT^A15^ADT_A15)

1315 3.31.7.15.1 Trigger Event

This message is sent by a Patient Encounter Supplier to notify a Patient Encounter Consumer that it is planned to transfer a patient.

MSH-9 is valued ADT^A15^ADT_A15.

3.31.7.15.2 Message Static Definition

1320

Table 3.31-21 Static definition of message ADT^A15^ADT_A15

Segment	Meaning	Usage	Card.	HL7 chapter
MSH	Message Header	R	[1..1]	2
SFT	Software Segment	O	[0..*]	2
EVN	Event Type	R	[1..1]	2
PID	Patient Identification	R	[1..1]	3
PD1	Additional Demographics	O	[0..1]	3
ROL	Role	O	[0..*]	15
PV1	Patient Visit	R	[1..1]	3
PV2	Patient Visit – Additional Info	O	[0..1]	3
ROL	Role	O	[0..*]	15
DB1	Disability Information	O	[0..*]	3
OBX	Observation/Result	O	[0..*]	7
DG1	Diagnosis Information	O	[0..*]	6

3.31.7.15.3 Comments on segment usage

Providers with an ongoing relationship may be communicated in ROL segments immediately following the PID/PD1 segments. Providers specific to an episode of care may be communicated in ROL segments immediately following the PV1/PV2 segments.

1325 One or more OBX segments may be present to carry “permanent observations” such as the patient weight or height.

Segment DG1 should be used to communicate diagnosis information only if it is necessary to communicate with a receiver that is using a version of HL7 prior to V2.5.

1330 The planned date for this pending transfer is given in field EVN-3 of segment EVN. See ITI TF-2b: 3.30.5.2.

3.31.7.15.4 Expected actions

The receiver shall record that a transfer is pending for this patient.

The receiver shall report the result of this operation (success / error) in an acknowledgment message returned to the sender.

1335 In case this Movement conflicts with the current situation of the patient (no active inpatient encounter, or patient unknown) the message is discarded, and no error condition is raised.

If the receiver does not support the Pending Event Management option of this transaction, it shall application-reject the message (see ITI TF-2x: C.2.3).

3.31.7.16 Cancel Pending Transfer – ADT^A26^ADT_A21

1340 **3.31.7.16.1 Trigger Event**

This message is sent by a Patient Encounter Supplier to a Patient Encounter Consumer to cancel a previous notification (via trigger event A25) that it was planned to transfer a patient.

MSH-9 is valued ADT^A26^ADT_A21.

3.31.7.16.2 Message Static Definition

1345 **Table 3.31-22 Static definition of message ADT^A26^ADT_A21**

Segment	Meaning	Usage	Card.	HL7 chapter
MSH	Message Header	R	[1..1]	2
SFT	Software Segment	O	[0..*]	2
EVN	Event Type	R	[1..1]	2
PID	Patient Identification	R	[1..1]	3
PD1	Additional Demographics	O	[0..1]	3
PV1	Patient Visit	R	[1..1]	3
PV2	Patient Visit – Additional Info	O	[0..1]	3
DB1	Disability Information	O	[0..*]	3
OBX	Observation/Result	O	[0..*]	7

3.31.7.16.3 Comments on segment usage

One or more OBX segments may be present to carry “permanent observations” such as the patient weight or height.

1350 The planned date for the pending transfer that is cancelled, is given in field EVN-3 of segment EVN. See ITI TF-2b: 3.30.5.2.

3.31.7.16.4 Expected actions

The receiver shall reset the patient’s status to the value immediately before the Pending Transfer message was received.

1355 The receiver shall report the result of this operation (success / error) in an acknowledgment message returned to the sender.

In case this Movement conflicts with the current situation of the patient (no pending transfer known, or no active inpatient encounter, or patient unknown) the message is discarded, and no error condition is raised.

1360 If the receiver does not support the Pending Event Management option of this transaction, it shall application-reject the message (see ITI TF-2x: C.2.3).

3.31.7.17 Pending Discharge (ADT^A16^ADT_A16)**3.31.7.17.1 Trigger Event**

This message is sent by a Patient Encounter Supplier to notify a Patient Encounter Consumer that it is planned to discharge a patient.

1365 MSH-9 is valued ADT^A16^ADT_A16.

3.31.7.17.2 Message Static Definition**Table 3.31-23 Static definition of message ADT^A16^ADT_A16**

Segment	Meaning	Usage	Card.	HL7 chapter
MSH	Message Header	R	[1..1]	2
SFT	Software Segment	O	[0..*]	2
EVN	Event Type	R	[1..1]	2
PID	Patient Identification	R	[1..1]	3
PD1	Additional Demographics	O	[0..1]	3
ROL	Role	O	[0..*]	15
NK1	Next of Kin / Associated Parties	O	[0..*]	3
PV1	Patient Visit	R	[1..1]	3
PV2	Patient Visit – Additional Info	RE	[0..1]	3
ROL	Role	O	[0..*]	15
DB1	Disability Information	O	[0..*]	3
OBX	Observation/Result	O	[0..*]	7
AL1	Allergy Information	O	[0..*]	3
DG1	Diagnosis Information	O	[0..*]	6

DRG	Diagnosis Related Group	O	[0..1]	6
---	--- PROCEDURE begin	O	[0..*]	
PR1	Procedures	R	[1..1]	6
ROL	Role	O	[0..*]	15
---	--- PROCEDURE end			
GT1	Guarantor	O	[0..*]	6
---	--- INSURANCE begin	O	[0..*]	
IN1	Insurance	R	[1..1]	6
IN2	Insurance Additional Info.	O	[0..1]	6
IN3	Insurance Additional Info - Cert.	O	[0..1]	6
ROL	Role	O	[0..*]	15
---	--- INSURANCE end			
ACC	Accident Information	O	[0..1]	6

3.31.7.17.3 Comments on segment usage

1370 Field *PV2-9-expected discharge date/time* is used to carry the expected date and time when the patient is to be discharged.

One or more OBX segments may be present to carry “permanent observations” such as the patient weight or height.

3.31.7.17.4 Expected actions

The receiver shall update the patient’s status to “pending discharge”.

1375 The receiver shall report the result of this operation (success / error) in an acknowledgment message returned to the sender.

In case this Movement conflicts with the current situation of the patient (no active inpatient encounter, or patient unknown) the message is discarded, and no error condition is raised.

1380 If the receiver does not support the Pending Event Management option of this transaction, it shall application-reject the message (see ITI TF-2x: C.2.3).

3.31.7.18 Cancel Pending Discharge – ADT^A25^ADT_A21

3.31.7.18.1 Trigger Event

This message is sent by a Patient Encounter Supplier to a Patient Encounter Consumer to cancel a previous notification (via trigger event A16) that a patient was expected to be discharged.

1385 MSH-9 is valued **ADT^A25^ADT_A21**.

3.31.7.18.2 Message Static Definition

Table 3.31-24 Static definition of message ADT^A25^ADT_A21

Segment	Meaning	Usage	Card.	HL7 chapter
MSH	Message Header	R	[1..1]	2
SFT	Software Segment	O	[0..*]	2

Segment	Meaning	Usage	Card.	HL7 chapter
EVN	Event Type	R	[1..1]	2
PID	Patient Identification	R	[1..1]	3
PD1	Additional Demographics	O	[0..1]	3
PV1	Patient Visit	R	[1..1]	3
PV2	Patient Visit – Additional Info	O	[0..1]	3
DB1	Disability Information	O	[0..*]	3
OBX	Observation/Result	O	[0..*]	7

3.31.7.18.3 Comments on segment usage

1390 One or more OBX segments may be present to carry “permanent observations” such as the patient weight or height.

3.31.7.18.4 Expected actions

The receiver shall reset the patient’s status to its value prior to the receipt of the “pending discharge” message.

1395 The receiver shall report the result of this operation (success / error) in an acknowledgment message returned to the sender.

In case this Movement conflicts with the current situation of the patient (no pending discharge known, or no active inpatient encounter, or patient unknown) the message is discarded, and no error condition is raised.

1400 If the receiver does not support the Pending Event Management option of this transaction, it shall application-reject the message (see ITI TF-2x: C.2.3).

3.31.7.19 Change Attending Doctor – ADT^A54^ADT_A54

3.31.7.19.1 Trigger Event

This message is sent by a Patient Encounter Supplier to notify a Patient Encounter Consumer that there has been a change in the doctor responsible for the patient’s treatment.

1405 MSH-9 is valued **ADT^A54^ADT_A54**.

3.31.7.19.2 Message Static Definition

Table 3.31-25 Static definition of message ADT^A54^ADT_A54

Segment	Meaning	Usage	Card.	HL7 chapter
MSH	Message Header	R	[1..1]	2
SFT	Software Segment	O	[0..*]	2
EVN	Event Type	R	[1..1]	2
PID	Patient Identification	R	[1..1]	3
PD1	Additional Demographics	O	[0..1]	3
ROL	Role	O	[0..*]	15
PV1	Patient Visit	R	[1..1]	3

Segment	Meaning	Usage	Card.	HL7 chapter
PV2	Patient Visit – Additional Info	O	[0..1]	3
ROL	Role	O	[0..*]	15

3.31.7.19.3 Comments on segment usage

Field *PV1-7-attending doctor* shall contain the new attending doctor.

1410 Providers with an ongoing relationship may be communicated in ROL segments immediately following the PID/PD1 segments. Providers specific to an episode of care may be communicated in ROL segments immediately following the PV1/PV2 segments.

1415 Field *ROL-4-role begin date/time* and *ROL-5-role end date/time* are used to communicate the begin and end date and time of the attending doctor (or of the admitting, consulting, and/or referring doctor, as appropriate and as designated in *ROL-7-role code*). When segment ROL is used to communicate this information, field *ROL-2-action code* should be valued UP.

3.31.7.19.4 Expected actions

The receiver shall record the patient's new attending doctor.

1420 The receiver shall report the result of this operation (success / error) in an acknowledgment message returned to the sender.

In case this Movement conflicts with the current situation of the patient (no active inpatient or outpatient encounter, or patient unknown) the message is discarded, but no error condition is raised. If the receiver does not support the Advanced Encounter Management option of this transaction, it shall application-reject the message (see ITI TF-2x: C.2.3).

1425 3.31.7.20 Cancel Change Attending Doctor – ADT^A55^ADT_A52

3.31.7.20.1 Trigger Event

This message is sent by a Patient Encounter Supplier to cancel a previous notification to a Patient Encounter Consumer of a change to the patient's attending doctor.

MSH-9 is valued **ADT^A55^ADT_A52**.

1430 3.31.7.20.2 Message Static Definition

Table 3.31-26 Static definition of message ADT^A55^ADT_A52

Segment	Meaning	Usage	Card.	HL7 chapter
MSH	Message Header	R	[1..1]	2
SFT	Software Segment	O	[0..*]	2
EVN	Event Type	R	[1..1]	2
PID	Patient Identification	R	[1..1]	3
PD1	Additional Demographics	O	[0..1]	3
PV1	Patient Visit	R	[1..1]	3
PV2	Patient Visit – Additional Info	O	[0..1]	3

3.31.7.20.3 Comments on segment usage

Field *PV1-7-attending doctor* shall contain the patient’s attending doctor prior to the notification of change.

1435 **3.31.7.20.4 Expected actions**

The receiver shall reset the patient’s attending doctor to the value in field *PV1-7-attending doctor*.

The receiver shall report the result of this operation (success / error) in an acknowledgment message returned to the sender.

1440 In case this Movement conflicts with the current situation of the patient (no active inpatient or outpatient encounter, or patient unknown) the message is discarded, but no error condition is raised.

If the receiver does not support the Advanced Encounter Management option of this transaction, it shall application-reject the message (see ITI TF-2x: C.2.3).

1445 **3.31.7.21 Patient Goes on a Leave of Absence – ADT^A21^ADT_A21**

3.31.7.21.1 Trigger Event

This message is sent by a Patient Encounter Supplier to notify a Patient Encounter Consumer that a patient has left the healthcare institution temporarily.

MSH-9 is valued **ADT^A21^ADT_A21**.

1450 **3.31.7.21.2 Message Static Definition**

Table 3.31-27 Static definition of message ADT^A21^ADT_A21

Segment	Meaning	Usage	Card.	HL7 chapter
MSH	Message Header	R	[1..1]	2
SFT	Software Segment	O	[0..*]	2
EVN	Event Type	R	[1..1]	2
PID	Patient Identification	R	[1..1]	3
PD1	Additional Demographics	O	[0..1]	3
PV1	Patient Visit	R	[1..1]	3
PV2	Patient Visit – Additional Info	O	[0..1]	3
DB1	Disability Information	O	[0..*]	3
OBX	Observation/Result	O	[0..*]	7

3.31.7.21.3 Comments on segment usage

Field *EVN-6-event occurred* shall contain the date and time that the patient actually left the institution. *PV2-47-expected LOA return* shall contain the date and time that the patient is expected to return from the leave of absence.

1455

One or more OBX segments may be present to carry “permanent observations” such as the patient weight or height.

3.31.7.21.4 Expected actions

The receiver shall record that the patient has left the institution on a leave of absence.

1460 The receiver shall report the result of this operation (success / error) in an acknowledgment message returned to the sender.

In case this Movement conflicts with the current situation of the patient (no active encounter, or patient unknown) the message is discarded, but no error condition is raised.

1465 If the receiver does not support the Advanced Encounter Management option of this transaction, it shall application-reject the message (see ITI TF-2x: C.2.3).

3.31.7.22 Cancel Leave of Absence for a Patient – ADT^A52^ADT_A52

3.31.7.22.1 Trigger Event

This message is sent by a Patient Encounter Supplier to cancel a previous notification to a Patient Encounter Consumer that a patient had left the healthcare institution temporarily.

1470 MSH-9 is valued **ADT^A52^ADT_A52**.

3.31.7.22.2 Message Static Definition

Table 3.31-28 Static definition of message ADT^A52^ADT_A52

Segment	Meaning	Usage	Card.	HL7 chapter
MSH	Message Header	R	[1..1]	2
SFT	Software Segment	O	[0..*]	2
EVN	Event Type	R	[1..1]	2
PID	Patient Identification	R	[1..1]	3
PD1	Additional Demographics	O	[0..1]	3
PV1	Patient Visit	R	[1..1]	3
PV2	Patient Visit – Additional Info	O	[0..1]	3

3.31.7.22.3 Comments on segment usage

1475 Field *EVN-6-event occurred* shall contain the date and time that the leave of absence was cancelled.

3.31.7.22.4 Expected actions

The receiver shall cancel the patient’s leave of absence.

The receiver shall report the result of this operation (success / error) in an acknowledgment message returned to the sender.

1480 In case this Movement conflicts with the current situation of the patient (no leave of absence previously notified, or no active encounter, or patient unknown) the message is discarded, but no error condition is raised.

If the receiver does not support the Advanced Encounter Management option of this transaction, it shall application-reject the message (see ITI TF-2x: C.2.3).

1485 **3.31.7.23 Patient Returns from a Leave of Absence – ADT^A22^ADT_A21**

3.31.7.23.1 Trigger Event

This message is sent by a Patient Encounter Supplier to notify a Patient Encounter Consumer that a patient has returned from a leave of absence.

MSH-9 is valued **ADT^A22^ADT_A21**.

1490 **3.31.7.23.2 Message Static Definition**

Table 3.31-29 Static definition of message ADT^A22^ADT_A21

Segment	Meaning	Usage	Card.	HL7 chapter
MSH	Message Header	R	[1..1]	2
SFT	Software Segment	O	[0..*]	2
EVN	Event Type	R	[1..1]	2
PID	Patient Identification	R	[1..1]	3
PD1	Additional Demographics	O	[0..1]	3
PV1	Patient Visit	R	[1..1]	3
PV2	Patient Visit – Additional Info	O	[0..1]	3
DB1	Disability Information	O	[0..*]	3
OBX	Observation/Result	O	[0..*]	7

3.31.7.23.3 Comments on segment usage

1495 Field *EVN-6-event occurred* shall contain the date and time that the patient actually returned from the leave of absence. *PV2-47-expected LOA return* shall contain the date and time that the patient was expected to return from the leave of absence.

One or more OBX segments may be present to carry “permanent observations” such as the patient weight or height.

3.31.7.23.4 Expected actions

The receiver shall record that the patient has returned from the leave of absence.

1500 The receiver shall report the result of this operation (success / error) in an acknowledgment message returned to the sender.

In case this Movement conflicts with the current situation of the patient (no leave of absence previously notified, or no active encounter, or patient unknown) the message is discarded, but no error condition is raised.

1505 If the receiver does not support the Advanced Encounter Management option of this transaction, it shall application-reject the message (see ITI TF-2x: C.2.3).

3.31.7.24 Cancel Patient Return from a Leave of Absence – ADT^A53^ADT_A52

3.31.7.24.1 Trigger Event

1510 This message is sent by a Patient Encounter Supplier to cancel a previous notification to a Patient Encounter Consumer that a patient had returned from a leave of absence.

MSH-9 is valued **ADT^A53^ADT_A52**.

3.31.7.24.2 Message Static Definition

1515 **Table 3.31-30 Static definition of message ADT^A53^ADT_A52**

Segment	Meaning	Usage	Card.	HL7 chapter
MSH	Message Header	R	[1..1]	2
SFT	Software Segment	O	[0..*]	2
EVN	Event Type	R	[1..1]	2
PID	Patient Identification	R	[1..1]	3
PD1	Additional Demographics	O	[0..1]	3
PV1	Patient Visit	R	[1..1]	3
PV2	Patient Visit – Additional Info	O	[0..1]	3

3.31.7.24.3 Comments on segment usage

Field *EVN-6-event occurred* shall contain the date and time that the return from leave of absence was cancelled. *PV2-47-expected LOA return* shall contain the date and time that the patient is expected to return from the leave of absence.

1520 **3.31.7.24.4 Expected actions**

The receiver shall cancel the patient’s return from leave of absence.

The receiver shall report the result of this operation (success / error) in an acknowledgment message returned to the sender.

1525 In case this Movement conflicts with the current situation of the patient (no return from leave of absence previously notified, or no active encounter, or patient unknown) the message is discarded, but no error condition is raised.

If the receiver does not support the Advanced Encounter Management option of this transaction, it shall application-reject the message (see ITI TF-2x: C.2.3).

3.31.7.25 Move account information – ADT^A44^ADT_A431530 **3.31.7.25.1 Trigger Event**

This message is sent by a Patient Encounter Supplier to notify a Patient Encounter Consumer that an account previously associated with one patient is now associated with another patient.

MSH-9 is valued **ADT^A44^ADT_A43**.

3.31.7.25.2 Message Static Definition

1535

Table 3.31-31 Static definition of message ADT^A44^ADT_A43

Segment	Meaning	Usage	Card.	HL7 chapter
MSH	Message Header	R	[1..1]	2
SFT	Software Segment	O	[0..*]	2
EVN	Event Type	R	[1..1]	2
---	--- PATIENT begin	R	[1..*]	
PID	Patient Identification	R	[1..1]	3
PD1	Additional Demographics	O	[0..1]	3
MRG	Merge Information	R	[1..1]	3
---	--- PATIENT end			

3.31.7.25.3 Comments on segment usage

None.

3.31.7.25.4 Expected actions

1540 The receiver shall associate the account in *MRG-3-prior patient account number* with the patient in *PID-3-patient identifier list*, and shall remove associations of that account with the patient in *MRG-1-prior patient identifier list*.

The receiver shall report the result of this operation (success / error) in an acknowledgment message returned to the sender.

1545 In case this message conflicts with the current situation (account unknown or supplier patient unknown) the message is discarded, but no error condition is raised.

If the receiver does not support the Advanced Encounter Management option of this transaction, it shall application-reject the message (see ITI TF-2x: C.2.3).

3.31.7.26 Patient Departing – Tracking (ADT^A09^ADT_A09)**3.31.7.26.1 Trigger Event**

1550 This message is only used within the context of the “Temporary Patient Transfers Tracking” option.

This message is sent by a Patient Encounter Supplier to notify a Patient Encounter Consumer that a patient has departed a location without the patient’s official bed census location having

1555 changed. The HL7 standard describes three situations that qualify as non-census location changes: (a) patient tracking (i.e., pre-notification before an official transfer), (b) the patient is in transit between locations for some time, (c) a notification of temporary location change. This IHE transaction only uses the latter: notification of temporary location change.

MSH-9 is valued **ADT^A09^ADT_A09**.

3.31.7.26.2 Message Static Definition

1560

Table 3.31-32 Static definition of message ADT^A09^ADT_A09

Segment	Meaning	Usage	Card.	HL7 chapter
MSH	Message Header	R	[1..1]	2
SFT	Software Segment	O	[0..*]	2
EVN	Event Type	R	[1..1]	2
PID	Patient Identification	R	[1..1]	3
PD1	Additional Demographics	O	[0..1]	3
PV1	Patient Visit	R	[1..1]	3
PV2	Patient Visit – Additional Info	O	[0..1]	3
DB1	Disability Information	O	[0..*]	3
OBX	Observation/Result	O	[0..*]	7
DG1	Diagnosis Information	O	[0..*]	6

3.31.7.26.3 Comments on segment usage

If the patient has left for a non-temporary location (tracking), then field *PV1-3-patient location* shall contain the patient’s new location and field *PV1-6-prior patient location* shall contain the patient’s old location.

1565 If the patient will be in transit for some time, then field *PV1-42-pending location* shall contain the new location and field *PV1-6-prior patient location* shall contain the patient’s old location.

If the patient is moving to a temporary location, then field *PV1-11-temporary location* shall contain the new temporary location. If the patient is moving from a temporary location, then field *PV1-43-prior temporary location* shall contain the old temporary location. If the patient is moving from a permanent location, then field *PV1-6-prior patient location* shall contain the old permanent location.

1570 One or more OBX segments may be present to carry “permanent observations” such as the patient weight or height.

1575 Segment DG1 should be used to communicate diagnosis information only if it is necessary to communicate with a receiver that is using a version of HL7 prior to V2.5.

3.31.7.26.4 Expected actions

The receiver shall reset the patient’s location to the value in field *PV1-11-temporary location*, field *PV1-42-pending location*, or field *PV1-3-patient location*, as appropriate.

1580 The receiver shall report the result of this operation (success / error) in an acknowledgment message returned to the sender.

In case this message conflicts with the current situation the message is discarded, but no error condition is raised.

If the receiver does not support the Temporary Patient Location Tracking option of this transaction, it shall application-reject the message (see ITI TF-2x: C.2.3).

1585 3.31.7.27 Cancel Patient Departing – Tracking – ADT^A33^ADT_A21

3.31.7.27.1 Trigger Event

1590 This message is only used within the context of the “Temporary Patient Transfers Tracking” option. This message is sent by a Patient Encounter Supplier to a Patient Encounter Consumer to cancel a previous notification (via trigger event A09) that a patient has departed a location without the patient’s official bed census location having changed.

MSH-9 is valued **ADT^A33^ADT_A21**.

3.31.7.27.2 Message Static Definition

Table 3.31-33 Static definition of message ADT^A33^ADT_A21

Segment	Meaning	Usage	Card.	HL7 chapter
MSH	Message Header	R	[1..1]	2
SFT	Software Segment	O	[0..*]	2
EVN	Event Type	R	[1..1]	2
PID	Patient Identification	R	[1..1]	3
PD1	Additional Demographics	O	[0..1]	3
PV1	Patient Visit	R	[1..1]	3
PV2	Patient Visit – Additional Info	O	[0..1]	3
DB1	Disability Information	O	[0..*]	3
OBX	Observation/Result	O	[0..*]	7

3.31.7.27.3 Comments on segment usage

1595 If the patient was in a non-temporary location, then field *PV1-3-patient location* shall contain the patient’s location prior to the erroneous A09 event. If the patient was in a temporary location, then field *PV1-11-temporary location* shall contain the patient’s location prior to the erroneous A09 event.

1600 One or more OBX segments may be present to carry “permanent observations” such as the patient weight or height.

3.31.7.27.4 Expected actions

The receiver shall reset the patient’s location to the value in field *PV1-11-temporary location* or to the value in field *PV1-3-patient location*, as appropriate.

1605 The receiver shall report the result of this operation (success / error) in an acknowledgment message returned to the sender.

In case this message conflicts with the current situation the message is discarded, but no error condition is raised.

If the receiver does not support the Temporary Patient Location Tracking option of this transaction, it shall application-reject the message (see ITI TF-2x: C.2.3).

1610 **3.31.7.28 Patient Arriving – Tracking – ADT^A10^ADT_A09**

3.31.7.28.1 Trigger Event

This message is only used within the context of the “Temporary Patient Transfers Tracking” option.

1615 This message is sent by a Patient Encounter Supplier to a Patient Encounter Consumer as a notification that a patient has arrived at a new location without the patient’s official bed census location having changed. The HL7 standard describes three varieties of these non-census location changes involving three different kinds of notification: (a) an unofficial notification of location change prior to the official notification of patient tracking, (b) the patient is in transit between locations for some time, (c) a notification of a temporary location change. This IHE
1620 transaction only uses the latter: notification of temporary location change.

MSH-9 is valued ADT^A10^ADT_A09.

3.31.7.28.2 Message Static Definition

Table 3.31-34 Static definition of message ADT^A10^ADT_A09

Segment	Meaning	Usage	Card.	HL7 chapter
MSH	Message Header	R	[1..1]	2
SFT	Software Segment	O	[0..*]	2
EVN	Event Type	R	[1..1]	2
PID	Patient Identification	R	[1..1]	3
PD1	Additional Demographics	O	[0..1]	3
PV1	Patient Visit	R	[1..1]	3
PV2	Patient Visit – Additional Info	O	[0..1]	3
DB1	Disability Information	O	[0..*]	3
OBX	Observation/Result	O	[0..*]	7
DG1	Diagnosis Information	X	[0..0]	6

3.31.7.28.3 Comments on segment usage

1625 If the patient is arriving at a temporary location, field *PV1-11-temporary location* shall indicate this temporary location. If the patient is moving from one temporary location to another, then field *PV1-43-prior temporary location* may also be used.

1630 If the patient is arriving at a permanent location from a temporary location, field *PV1-3-patient location* shall be used for the new location and field *PV1-43-prior temporary location* shall be used for the old location.

One or more OBX segments may be present to carry “permanent observations” such as the patient weight or height.

3.31.7.28.4 Expected actions

1635 The receiver shall update the patient’s location to the value in field *PVI-11-temporary location* or to the value in field *PVI-3-patient location*, as appropriate.

The receiver shall report the result of this operation (success / error) in an acknowledgment message returned to the sender.

In case this message conflicts with the current situation the message is discarded, but no error condition is raised.

1640 If the receiver does not support the Temporary Patient Location Tracking option of this transaction, it shall application-reject the message (see ITI TF-2x: C.2.3).

3.31.7.29 Cancel Patient Arriving – Tracking – ADT^A32^ADT_A21

3.31.7.29.1 Trigger Event

1645 This message is sent by a Patient Encounter Supplier to a Patient Encounter Consumer to cancel a previous notification (via trigger event A10) that a patient arrived at a location without the patient’s official bed census location having changed, as for example when the patient arrives at a diagnostic or treatment service.

MSH-9 is valued **ADT^A32^ADT_A21**.

3.31.7.29.2 Message Static Definition

1650 **Table 3.31-35 Static definition of message ADT^A32^ADT_A21**

Segment	Meaning	Usage	Card.	HL7 chapter
MSH	Message Header	R	[1..1]	2
SFT	Software Segment	O	[0..*]	2
EVN	Event Type	R	[1..1]	2
PID	Patient Identification	R	[1..1]	3
PD1	Additional Demographics	O	[0..1]	3
PV1	Patient Visit	R	[1..1]	3
PV2	Patient Visit – Additional Info	O	[0..1]	3
DB1	Disability Information	O	[0..*]	3
OBX	Observation/Result	O	[0..*]	7

3.31.7.29.3 Comments on segment usage

1655 If the patient was in a non-temporary location, then field *PVI-3 - Assigned Patient Location* may contain (if known) the original patient location prior to the erroneous A10 (patient arriving-tracking) event. If the patient was in a temporary location, then field *PVI-11 - Temporary Location* may contain (if known) the original patient location prior to the erroneous A10 (patient arriving-tracking) event.

One or more OBX segments may be present to carry “permanent observations” such as the patient weight or height.

3.31.7.29.4 Expected actions

1660 If field *PVI-3 - Assigned Patient Location* is populated, the receiver shall reset the patient’s permanent location to the value contained in that field. If field *PVI-11 - Temporary Location* is populated, the receiver shall reset the patient’s permanent location to the value contained in that field.

1665 The receiver shall report the result of this operation (success / error) in an acknowledgment message returned to the sender.

In case this message conflicts with the current situation the message is discarded, but no error condition is raised.

If the receiver does not support the Temporary Patient Location Tracking option of this transaction, it shall application-reject the message (see ITI TF-2x: C.2.3).

1670 **3.31.7.30 Update Patient Movement Information – ADT^Z99^ADT_A01**

3.31.7.30.1 Trigger Event

This message is only used within the context of the “Historic Movement Management” option.

It is sent by a Patient Encounter Supplier to a Patient Encounter Consumer to communicate an update of a Movement, which can be the current Movement or a historic one.

1675 MSH-9 is valued **ADT^Z99^ADT_A01**.

3.31.7.30.2 Message Static Definition

Table 3.31-36 Static definition of message ADT^Z99^ADT_A01

Segment	Meaning	Usage	Card.	HL7 chapter
MSH	Message Header	R	[1..1]	2
SFT	Software Segment	O	[0..*]	2
EVN	Event Type	R	[1..1]	2
PID	Patient Identification	R	[1..1]	3
PD1	Additional Demographics	O	[0..1]	3
ROL	Role	O	[0..*]	15
NK1	Next of Kin / Associated Parties	O	[0..*]	3
PV1	Patient Visit	R	[1..1]	3
PV2	Patient Visit – Additional Info	O	[0..1]	3
ZBE	Movement segment	R	[1..1]	
ROL	Role	O	[0..*]	15
DB1	Disability Information	O	[0..*]	3
OBX	Observation/Result	O	[0..*]	7
AL1	Allergy Information	O	[0..*]	3
DG1	Diagnosis Information	O	[0..*]	6

Segment	Meaning	Usage	Card.	HL7 chapter
DRG	Diagnosis Related Group	O	[0..1]	6
---	--- PROCEDURE begin	O	[0..*]	
PR1	Procedures	R	[1..1]	6
ROL	Role	O	[0..*]	15
---	--- PROCEDURE end			
GT1	Guarantor	O	[0..*]	6
---	--- INSURANCE begin	O	[0..*]	
IN1	Insurance	R	[1..1]	6
IN2	Insurance Additional Info.	O	[0..1]	6
IN3	Insurance Additional Info - Cert.	O	[0..1]	6
ROL	Role	O	[0..*]	15
---	--- INSURANCE end			
ACC	Accident Information	O	[0..1]	6
UB1	Universal Bill Information	O	[0..1]	6
UB2	Universal Bill 92 Information	O	[0..1]	6
PDA	Patient Death and Autopsy	O	[0..1]	3

3.31.7.30.3 Comments on segment usage

1680 The ZBE segment is mandatory in this message. See the description of this segment in ITI TF-2b: 3.31.6.1.

3.31.7.30.4 Expected actions

Otherwise, the receiver shall update the Movement in its database, and shall report the result of this operation (success / error) in an acknowledgment message returned to the sender.

1685 If the receiver does not know the Movement to be updated (identified by ZBE-3 in the ZBE segment), it discards the message and raises an error condition.

A receiver not supporting the Historic Movement Management option shall application-reject the message (see ITI TF-2x: C.2.3).

3.31.7.31 Merge two patients - ADT^A40^ADT_A39

3.31.7.31.1 Trigger Event

1690 The Patient Encounter Supplier notifies the merge of records for a patient that was incorrectly filed under two different identifiers. This message is only used to merge two patient identifiers of the same type, or two lists of patient identifiers, it is not supposed to update other patient demographics information. The A08 trigger event should be used for this purpose.

MSH-9 is valued **ADT^A40^ADT_A39**.

1695 **3.31.7.31.2 Message Static Definition****Table 3.31-37 Static definition of message ADT^Z40^ADT_A39**

Segment	Meaning	Usage	Card.	HL7 chapter
MSH	Message Header	R	[1..1]	2
SFT	Software Segment	O	[0..*]	2
EVN	Event Type	R	[1..1]	2
---	--- PATIENT begin	R	[1..1]	
PID	Patient Identification	R	[1..1]	3
PD1	Additional Demographics	O	[0..1]	3
MRG	Merge Information	R	[1..1]	3
PV1	Patient Visit	X	[0..0]	3

3.31.7.31.3 Comments on segment usage

This profile makes unrepeatable the PATIENT segment group: The message can communicate only one merge operation for one patient.

1700 The “incorrect supplier identifier” identified in the MRG segment (*MRG-1-Prior Patient Identifier List*) is to be merged with the required “correct target identifier” of the same “identifier type code” component identified in the PID segment (*PID-3-Patient Identifier List*). The “incorrect supplier identifier” would then logically never be referenced in future transactions.

The PV1 segment is not supported by IHE in this message.

1705 **3.31.7.31.4 Expected actions**

The receiver shall merge the two patients in its data base, and shall report the result of this operation (success / error) in an acknowledgment message returned to the sender.

If the receiver does not recognize the target patient identifiers, it shall perform a Change Patient Identifier List instead of a Merge.

1710 If the receiver does not recognize the supplier patient identifiers to be merged, it shall take no action. This situation is not an error.

3.32 Distribute Document Set on Media

1715 This section corresponds to Transaction ITI-32 of the IHE IT Infrastructure Technical Framework. Transaction ITI-32 is used by the Portable Media Creator to create the media content and by Portable Media Importer to read the media content.

3.32.1 Scope

In the Distribute Document Set on Media transaction the Portable Media Creator sends information to media reading actors by means of Interchange Media where it stores the information.

1720

3.32.2 Use Case Roles

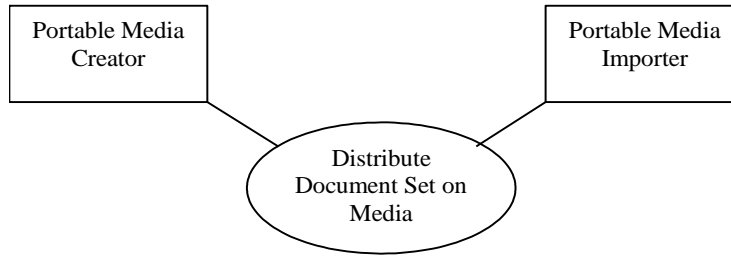

Actor: Portable Media Creator

Role: Assemble the media content and store it on the media to be distributed.

Actor: Portable Media Importer

1725

Role: Read the Document Submission Set content of distributed media in order to access the document(s) and the relevant metadata and perform import of the documents on the media.

3.32.3 Referenced Standard

DICOM PS 3.10 Media Storage and File Format for Data Interchange (DICOM file format). <http://dicom.nema.org/>

1730

DICOM PS 3.12 Media Formats and Physical Media for Data Interchange, Annex F - 120mm CD-R media, Annex R - USB Connected Removable Devices, Annex V - ZIP File Over Media, and Annex W - Email Media. <http://dicom.nema.org/>

XHTML™ 1.0 The Extensible HyperText Markup Language (Second Edition). A Reformulation of HTML 4 in XML 1.0. W3C Recommendation 26 January 2000, revised 1 August 2002.

1735

<http://www.w3.org/TR/xhtml1>.

XHTML™ Basic. W3C Recommendation 19 December 2000. <http://www.w3.org/TR/xhtml-basic>.

MDN: RFC 3798 Message Disposition Notification. <http://www.rfc-editor.org/rfc/rfc3798.txt>

3.32.4 Interaction Diagram

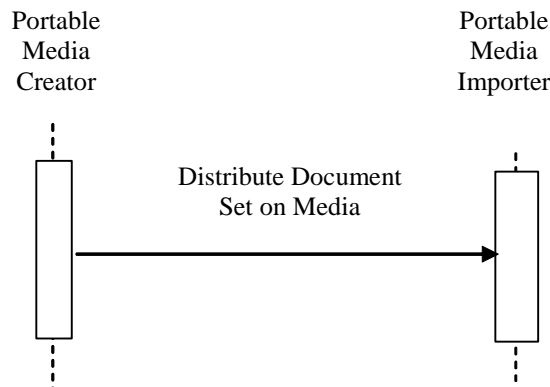

1740

3.32.4.1 Distribute Document Set on Media

This transaction defines the interchange of XDS document submission sets on media. It specifies the requirements for a directory structure, and the physical media where stored.

1745 The file directory structure restrictions and file organization are specified below. These are based on industry standard file systems with restrictions chosen based on experience with demonstrated interoperability in the field of reliable exchange. These are defined in Part 10 of the DICOM standard and summarized below.

The media that are supported are:

- 1750 • CD-R media. The physical media specification used for the storage on CD-R is a restricted subset of the widely used CD-R media. The restrictions were chosen to ensure interoperability and media reliability. The standard directory and file structure can be recorded to the CD-R media by widely available software, but this software must be set to comply with the interoperability restrictions on recording format. This media specification relies on the healthcare experience gained by CD-R media widely used in radiology and
- 1755 cardiology. It is defined by Annex F in Part 12 of the DICOM standard and is also used in the IHE Radiology PDI profile for the interchange of images,
- 1760 • USB Removable Devices. This media specification encompasses a wide range of USB connected flash media, removable storage devices, etc. The standard directory and file structure can be recorded onto any of these media by any system that supports the USB Removable Device type defined by the USB Implementers Forum. This specification is defined in Annex R in Part 12 of the DICOM standard.
- 1765 • Email transport of ZIP files. This media specification defines the encoding of the directory and file structure as an ordinary ZIP file (maintaining the directory structure) and attaches that ZIP file to an email message. Some additional constraints are added to the email message header to facilitate recognizing the message. This specification is defined in the annexes to part 12 of the DICOM standard called: ZIP File Media and Email media. The ZIP over Email Response option enables the Portable Media Importer to send an acknowledgment message to the Portable Media Importer.

1770 3.32.4.1.1 Trigger Events

The user at the Portable Media Creator wishes to transport information by the creation and transport of interchange media. The Portable Media Creator assembles the Interchange Media content and stores it on the media.

1775 If the ZIP over Email Response option is supported, the Portable Media Importer shall detect whether the Import was successful or not.

3.32.4.1.2 Message Semantics

The message semantics of this transaction are described in terms of content specifications for the media.

1780 The Portable Media Creator shall be able to include one or multiple Submission Set(s), including document(s) and associated metadata. Additionally it shall include a *README.TXT* file and an

INDEX.HTM and associated files for use to display the media content using a simple browser. It may include other files and directories that the Portable Media Importer will ignore.

3.32.4.1.2.1 Media File system and File Naming Restrictions

The following restrictions are needed to ensure broad interoperability:

- 1785 • Strict ISO 9660 Level 1 compliance for filenames and directories, even on non-CDR media.
- Strict ISO 9660 Level 1 compliance for recording methods on CDR media. This means no packet writing.
- Filenames should not be in lower case, nor have lower case equivalent file names encoded as Joliet or Rock Ridge extensions to the ISO 9660 file system.
- 1790 • Only file and folder names referenced by the DICOMDIR file are restricted to 8 characters with no extension. Specifically, it is not permitted to name DICOM files based on their SOP Instance UID, since that would exceed the 8 character limit and use the illegal period character, and it is not permitted to add a “.dcm” extension or similar.

1795 Note: Refer to RAD TF-3: Appendix E of the IHE Radiology Technical Framework for a reference to common implementation misinterpretations and/or errors that are detrimental to interoperability.

3.32.4.1.2.2 Content Organization Overview

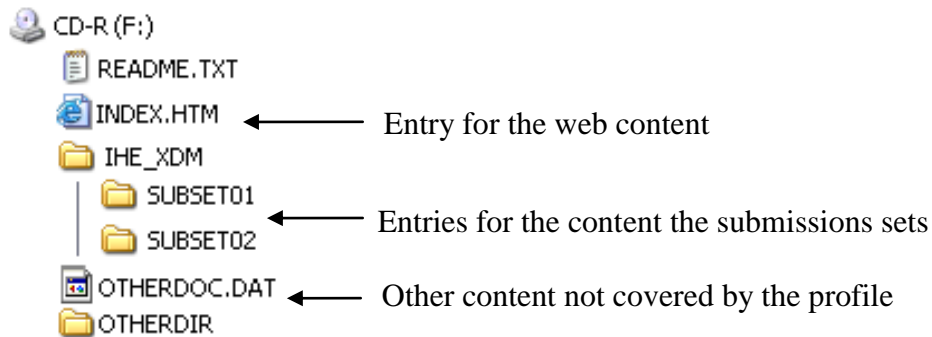

Figure 3.32.4.1-1 General structure of the media

The media shall contain at the “root” directory level, as shown in the figure above:

- 1800 • An IHE_XDM directory.
- Two files for helping to access the content of the media: *README.TXT* and *INDEX.HTM*
- An Autorun file or equivalent shall not be present in the root directory. Executable files may be present, but shall not be configured to start automatically.

1805 As shown in the figure above, the *IHE_XDM* directory shall contain one sub-directory per submission set included on the media.

There may be other files present on the media for other purposes, (e.g., use in compliance with the IHE Radiology PDI profile). The presence or absence of these files shall not affect performance of this transaction.

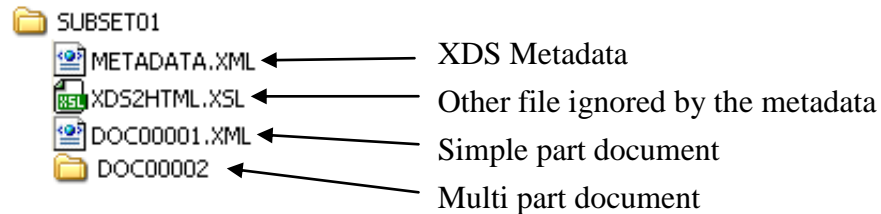

1810 **Figure 3.32.4.1-2 Structure of a submission set directory on the media**

As shown on the figure above, each submission set directory shall contain:

- 1815 • A *METADATA.XML* file containing the XDS Registry metadata, as described in ITI TF-3: 4.1.7 Document Definition Metadata. This shall include all of the metadata that is specified for a Register Document Set-b [ITI-42]. This may include XDSFolder objects, associations, and other metadata contents. There is no relationship between an XDSFolder and a media directory, although some people do call media directories “folders”. The metadata for the submission set shall include unique and different submissionTime.
- 1820 • One file for each “simple part” document referenced in the metadata as an XSDSDocumentEntry
- One sub-directory for each “multipart” document referenced in the metadata as an XSDSDocumentEntry (see table 4.1-5, attribute mimeType set to “multipart/related”)
- Potentially other files and directories that are ignored by the Portable Media Importer

1825 The “multipart” document shall be structured as one sub-directory containing all the parts as file, including the “start” part corresponding to the main file to be open by the “multipart” document viewer. An example of “multipart” document is shown in Figure 3.32.4.1-3.

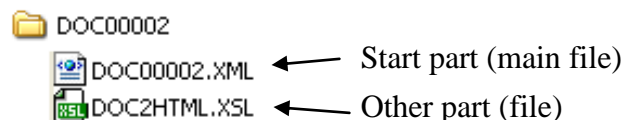

Figure 3.32.4.1-3 Structure on the media of a directory which is functionally equivalent to a “XDS multipart document”

1830 The URI element of the metadata describing a file that is present on this media shall point to the file containing the document, through a relative URL which corresponds to the file name for simple part document and to the concatenation of the sub-directory and the main file name for “multipart” document (e.g., DOC00002/DOC00002.XML). Note that in cases where the files are not located within this media directory for the Submission Set, it is possible that the relative

1835 URL may begin with “../” so that a single copy the document can be present for multiple purposes.

In Figure 3.32.4.1-2, the METADATA.XML file of the Submission Set stored in the SUBSET01 directory will contain many XSDSDocumentEntry objects having their elements set as follows (see Table 4.1-5, URI attribute for details):

1840 `<ExtrinsicObject id="Document1" mimeType="text/xml"... (with URI set to "DOC00001.XML")`
`<ExtrinsicObject id="Document2" mimeType="text/xml"... (with URI set to "DOC00002/DOC00002.XML")`

1845 The file named *INDEX.HTM* in the root directory shall be encoded in compliance with the XHTML Basic recommendation from W3C. It may contain a description of the submission sets, including especially:

- Patient ID and demographics
- Source Facility information

1850 Note: XDM Distribute Document Set on Media Transaction does not require that all the submission sets included in the media are relative to the same patient.

It may also describe other content which is on the media, including the means to launch any executable that may be present on the media.

There shall also be a *README.TXT* file located in the root directory, that shall contain:

- Contact information regarding the Institution that created the media.
- 1855 • Information regarding the Application that created the media.
 - Name of the product application and software version
 - Contact information of the vendor of the application that created the media
- General information about the overall organization of the interchange media. This is not intended to be specific to the content stored on this instance of interchange media, which if necessary should be placed in the *INDEX.HTM* file.
- 1860 • Information regarding the Media Viewer application (if a Media Viewer is contained)
 - Operating system(s) supported
 - Name of the product application and software version
 - Contact information of vendor that provided the Media Viewer application
 - 1865 - Disclaimer statement about the intended usage of the application
 - List of minimum requirements
 - Additional information regarding the usage of the application

1870 Note that generally the *README.TXT* file is independent of the clinical content of the media, i.e., the same *README.TXT* may be included on all media created by that application at that institution. Experience has shown that this kind of *README.TXT* file is very valuable for resolving problems.

In addition, if the Portable Media Creator implements support for the Web Content Option of the PDI Profile then the *INDEX.HTM* file must meet the requirements of the PDI Profile Web Content Option.

1875 The *INDEX.HTM* file located in the root directory shall contain:

- An informative header containing:
- Identification of the institution that created the interchange media
- Optionally, a disclaimer statement about privacy/security from the institution that created the interchange media

- 1880
- a link to an entry point for accessing the web content of the IHE_PDI directory
 - a link to the *README.TXT* file
 - a link to additional non-constrained data (if it exists)
 - a manifest which lists the data that can be imported by a Portable Media Importer Actor. (i.e., all DICOM content on the media)
- 1885
- a manifest which lists any patient-related data contained on the CD that cannot be imported (i.e., additional non-constrained content that doesn't have an importable DICOM equivalent on the media).
 - a link to a launch point for a DICOM viewer, if present on the interchange media

1890 **3.32.4.1.2.3 Response message**

If the ZIP over Email Response option is supported and a response was requested, the Portable Media Importer shall send a response, based on the [MDN] mechanism, depending of the success of the Import operation:

- 1895
- Success: the MDN “disposition-type” field is set to “displayed”
 - Error: the MDN “disposition-type” field is set to “deleted” and the MDN “disposition-modifier” is set to “Error: xxxx” where “xxxx” is the text detailing the error.

1900 Note 1: Older implementations of MDN might use “processed” instead of “display”. The current RFC has removed this option but Portable Media Creator should be prepared to receive it. If they receive it, they have to look in the error field to see whether there is an error.

Note 2: The general mechanism for use of eMail is described in ITI TF-2x: Appendix T (Informative)

3.32.4.1.3 Media Identification

1905 The Portable Media Creator actor may add a human-readable identification on the outside of the physical medium, reflecting the originating institution, the time of the creation and content of the media. The method of media marking is outside the scope of this integration profile.

If the ZIP over Email Response option is supported, Portable Media Creator shall be configurable to include in its message header the request for a response:

- “Disposition-Notification-To:”, followed by the email address to which Portable Media Importer shall send the response

1910 Then, the Portable Media Importer shall acknowledge this operation by sending a MDN response to the email address included in the message.

And finally, the Portable Media Creator shall consider that the import is successful unless:

- the disposition-modifier contains the word “error” or “failure”, case insensitive.

1915 Note: This profile does not specify how errors should be processed because the variety of appropriate responses is too great.

In the case the media used is the ZIP file over Email, the subject line shall contain the phrase:

- XDM/1.0/DDM

Note: In case the same Email complies also with the DICOM Email, it is recommended that the subject contains the phrase: XDM/1.0/DDM+DICOM-ZIP

1920 **3.32.4.1.4 Expected Actions**

The Portable Media Importer shall verify the integrity of the media by comparing their size and hash with the value of the corresponding entries in the METADATA.XML file of the relevant submission set directory. Mismatching documents shall be indicated to the user. Media faults shall be indicated to the user.

1925 Because the XDM Portable Media Importer is grouped with a Content Consumer of one or more IHE Content Profiles, that actor is able to perform its processing on the documents it is designed to support.

Note: This awkward phrasing means that ability to process data on portable media is described by saying that the processing actor is grouped with a Portable Media Importer actor.

1930 **3.32.4.1.4.1 Basic Patient Privacy Enforcement Option**

If the Basic Patient Privacy Enforcement Option is implemented:

- 1935 1. The Portable Media Creator actor shall populate the confidentialityCode in the document metadata with the list of values that identify the sensitivity classifications that apply to the associated document. All documents submitted shall have confidentiality codes. The confidentiality codes for different documents in the same submission may be different.
- 1940 2. The Portable Media Creator actor shall be able to be configured with the Patient Privacy Policies, Patient Privacy Policy Identifiers (OIDs) and associated information necessary to understand and enforce the policies. The details of this are product specific and not specified by IHE.
- 1945 3. The Portable Media Creator actor may have user interface or business rule capabilities to determine the appropriate confidentiality codes for each document. The details of this are product specific and not specified by IHE.
- 1950 4. The Portable Media Importer actor shall be able to be configured with the Patient Privacy Policies, Patient Privacy Policy Identifiers (OIDs) and associated information necessary to understand and enforce the policies. The meanings of the codes on the media must be provided out of band, e.g., by telephone, fax, or email. The detail of how this is done is product specific and not specified by IHE. If the documents are transferred internally within the organization or to other members of the recipient's affinity domain, appropriate internal confidentiality codes shall be applied.
- 1955 5. The Portable Media Creator actor shall be able to publish the consent documents and any applicable digital signatures that apply to the collection of content that it has created on portable media.
6. The Portable Media Importer actor shall have the ability to coerce the confidentiality code in the metadata associated with the document from the codes used by the Exporter to the codes used by the Importer.

1960 The Portable Media Importer actor shall abide by the XDS Affinity Domain Policies represented by the confidentialityCode in the metadata associated with the document. The Portable Media Creator actor likely will have user access controls or business rule capabilities to determine the details of how confidentiality codes apply to query results. The details of this are product specific and not specified by IHE. These rules shall reduce the query results to only those that are appropriate to the current situation for that actor and user.

3.32.4.1.5 Security considerations

In the case of physical media, encryption of the CD-R or USB shall not be used.

1965 In the case the media used is the ZIP file over Email, the transaction shall be secured by S/MIME (see IHE ATNA) and comply with the security process as defined in the DICOM Part 15 Appendix (Secure Use of ZIP File Media over Email). The security process requires the use of S/MIME to both encrypt and sign the message. The encryption is used to maintain confidentiality during the transport. The signature is used to maintain integrity during transport and indicates that the sender is authorized to send the message.

1970 Portable Media Creators that create media shall generate one or more ATNA “Export” events into the audit trail to describe the media creation event. These events shall describe each submission set and/or study that is exported.

1975 Portable Media Importers that import media shall generate one or more ATNA “Import” events into the audit trail to describe the media import event. These events shall describe each submission set and/or study that is imported.

Note: It is easy to build a partial implementation of actors in the XDM profile that lack the auditing capability. For example, a person can manually create media that comply with the requirements of the XDM media. It is possible that the manual process omits the generation of audit records for their activity. This would not be a compliant or complete implementation of the actors, but it is easy to make this kind of mistake.

1980 The Portable Media Importer shall check the hash value and size as found in the XDS metadata to detect corruption within the metadata or media. The Portable Media Importer shall notify the user if any errors are detected.

3.33 Intentionally Left Blank

3.34 Intentionally Left Blank

1985 **3.35 Intentionally Left Blank**

3.36 Intentionally Left Blank

3.37 Intentionally Left Blank

3.38 Intentionally Left Blank

3.39 Intentionally Left Blank

1990 **3.40 Provide X-User Assertion**

This section corresponds to Transaction ITI-40 of the IHE IT Infrastructure Technical Framework.

3.40.1 Scope

1995 Transaction ITI-40 is used by the **X-Service User** to pass a claimed identity assertion to the **X-Service Provider**. The **X-Service User** and **X-Service Provider** use the '**X-Assertion Provider**' as the third party issuer of the claimed identity assertion.

3.40.2 Use Case Roles

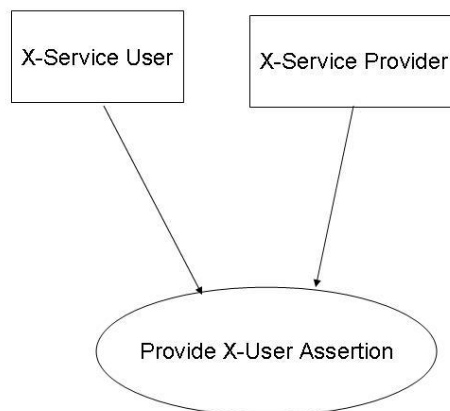

2000 **Actor:** X-Service User

Role: User of a transaction that requires a Cross-Enterprise User Assertion

Actor: X-Service Provider

Role: Service provider on a transaction that requires a Cross-Enterprise User Assertion

3.40.3 Referenced Standards

2005 3.40.3.1 Normative -- required to use this profile

- OASIS <http://www.oasis-open.org/committees/security/>.
 - [SAMLCore](#) SAML V2.0 Core standard
 - [WSS10](#) OASIS Standard, "OASIS Web Services Security: SOAP Message Security 1.0 (WS-Security 2004)", March 2004.
 - 2010 • [WSS11](#) OASIS Standard, "OASIS Web Services Security: SOAP Message Security 1.1 (WS-Security 2004)", February 2006.
 - [WSS:SAMLTokenProfile1.0](#) OASIS Standard, "Web Services Security: SAML Token Profile", December 2004
 - 2015 • [WSS:SAMLTokenProfile1.1](#) OASIS Standard, "Web Services Security: SAML Token Profile 1.1", February 2006

3.40.3.2 Informative -- assist with understanding or implementing this profile

- [IHE](#) Profiles
 - [Personnel White Pages](#) Profile
 - [Enterprise User Authentication](#) Profile
 - 2020 ○ [Basic Patient Privacy Consents](#) Profile
- [OASIS-OPEN](#)
 - SAML V2.0 Standards <http://www.oasis-open.org/committees/security/>.
 - SAML V2.0 Technical Overview
 - SAML Executive Overview
 - 2025 ○ SAML Tutorial presentation by Eve Maler of Sun Microsystems
 - SAML Specifications
 - WS-Trust - OASIS Web Services Secure Exchange (WS-SX) TC

3.40.4 Interaction Diagram

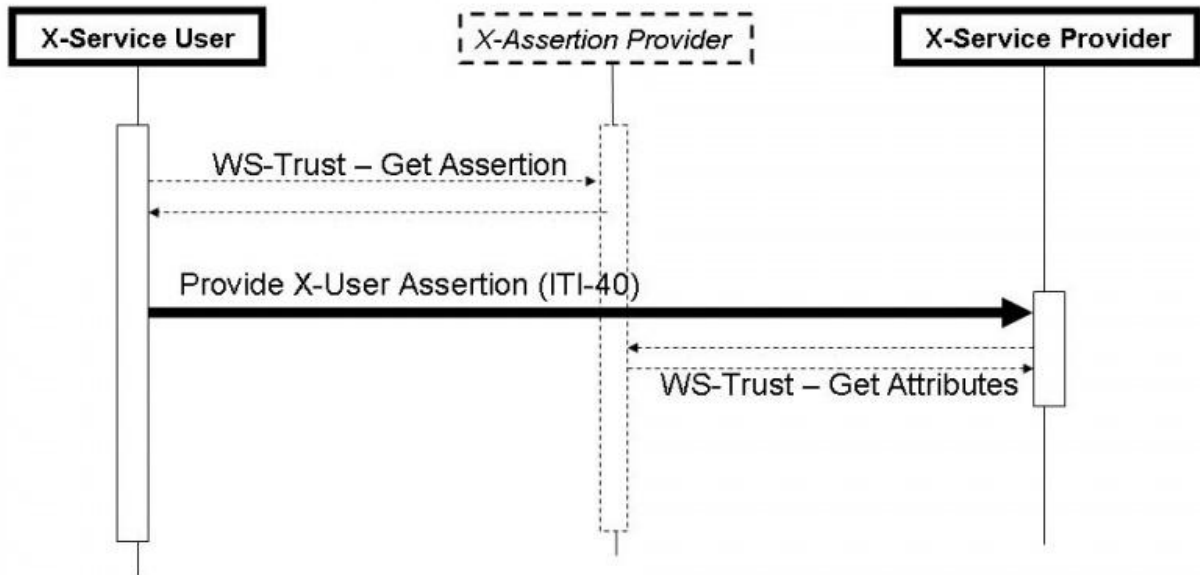

2030

Figure 40.1-1 X-User Assertion Messages

3.40.4.1 Provide X-User Assertion

2035 The Provide X-User Assertion is profiled to assure interoperability between an X-Service User and an X-Service Provider that need an Assertion about the entity requesting the service. There are many ways to provide an Assertion that are all acceptable and may be used by parties that have agreed to their use.

The Provide X-User Assertion transaction sets some minimal interoperability profiling for this use-case. The Provide X-User Assertion transaction shall be used when there is no other agreed upon policy that would assure User Assertion interoperability (e.g., WS-SecurityPolicy).

2040 3.40.4.1.1 Trigger

Configuration of the X-Service Provider and X-Service User indicates when the X-User Assertion transaction is necessary.

3.40.4.1.2 Message Semantics

2045 The X-User Assertion must be protected at all times against confidentiality exposure, malicious modification, and trust relationship between those communicating it. The IHE Actors that are grouped with XUA may already require IHE-ATNA and thus TLS Mutual-Authentication, Integrity, and Confidentiality.

The X-Service User shall include the OASIS Web Services Security (WSS) Header, and shall include a SAML 2.0 Assertion as the security token.

2050 Any ATNA Audit Messages that the X-Service User records in relationship to a transaction protected by the XUA (e.g., XDS.b Registry Stored Query, and XDS.b Retrieve Document Set), shall have the user identity recorded according to the XUA specific ATNA encoding rules (See 3.40.4.2 ATNA Audit encoding). This assures that the X-Service User and X-Service Provider ATNA Audit messages can be correlated at the ATNA Audit Repository.

2055 Any ATNA Audit Messages recorded by Actor grouped with the X-Service User Actor, shall have the user identity recorded according to the XUA specific ATNA encoding rules (See 3.40.4.2 ATNA Audit encoding). For example: The XDS.b Document Consumer Actor records the Query event, this event record will include the identity provided in the XUA Identity Assertion. This assures that the X-Service User and X-Service Provider ATNA Audit messages
2060 can be correlated at the ATNA Audit Repository.

The SAML 2.0 **Assertion** is profiled as follows (**bold** is used when SAML 2.0 terms are used):

- The Assertion shall contain a **Subject**. The Subject contains the logical identifier of the principal performing the original service request (person, application, etc.) and remains unchanged through operations acting on the assertion (e.g., proxying the Assertion).
 - 2065 • The **Subject** shall contain a **SubjectConfirmation** element. The bearer confirmation method shall be supported; the holder-of-key method may be supported. These methods are defined in the SAML 2.0 Profile specification, section 3.
- The SAML Assertion **Conditions** are profiled as:
 - 2070 • **NotBefore** shall be populated with the issue instant of the Assertion
 - **NotOnOrAfter** is not specified by XUA because reasonable time limits are not clear at the IHE Profile level. The Expiration is provided by the X-Assertion Provider and would be variable on an Affinity Domain and/or System level.
 - 2075 • The assertion shall contain an **AudienceRestriction** containing an **Audience** whose value is a URI identifying the X-Service Provider (e.g., XDS Registry, XDS Repository). It may contain an Audience whose value is a URI identifying the Affinity Domain.
 - The Assertion may contain **ProxyRestriction** and **OneTimeUser** conditions but XUA actors may ignore these conditions.
- 2080 • The Assertion shall contain an AuthnStatement specify the AuthnContextClassRef or AuthnContextDeclRef
- The Assertion may contain other statements (e.g., Attributes)
- The Assertion shall be signed by the X-Assertion Provider as defined in SAML Core.

2085 The interface between the X-Service User and the X-Assertion Provider is not specified by XUA. This interface needs to be protected against risks (e.g., exposure of the SAML Token to interception for malicious use). Assertions need to be carefully managed in the X-Service User to ensure they are not exposed in the application code or any subsequent use of the Assertion.

3.40.4.1.3 Expected Actions

2090 The X-Service Provider shall validate the Identity Assertion by processing the Web-Services Security header in accordance with the Web-Services Security Standard, and SAML 2.0 Standard processing rules (e.g., check the digital signature is valid and chains to an X-Identity Provider that is configured as trusted). If this validation fails, then the grouped Actor's associated transaction shall return with an error code as described in WS-Security core specification section 12 (Error Handling, using the SOAP Fault mechanism), and the ATNA Audit event for
2095 Authentication Failure shall be recorded according to ATNA rules.

Any ATNA Audit Messages recorded by Actor grouped with the X-Service Provider Actor, shall have the user identity recorded according to the XUA specific ATNA encoding rules (See ITI TF-2b: 3.40.4.2 ATNA Audit encoding). For example: The XDS.b Registry Stored Query Actor records the Query event, this event record will include the identity provided in the XUA Identity
2100 Assertion. This assures that the X-Service User and X-Service Provider ATNA Audit messages can be correlated at the ATNA Audit Repository.

The X-Service Provider may use standards transactions to communicate with the X-Assertion Provider (e.g., WS-Trust, SAML 2.0 Protocol) to obtain information not included in the assertion provided (e.g., Attributes that might be related to structural roles).

2105 The X-Service Provider may utilize the identity in access control decisions. Appropriate error messages, not defined here, shall be returned. The X-Service Provider may ignore any other statements (e.g., Attributes).

2110 The X-Service Provider may use the authentication class references to determine the method that was used to authenticate the user. For example the X-Service Provider may have a configurable list of authentication class references that it is willing to recognize as authentication methods that are acceptable, thus treating other authentication class references as not authorized.

Assertions need to be carefully managed inside the X-Service Provider to ensure they are not exposed in the application code or any subsequent use of the Assertion.

3.40.4.2 ATNA Audit encoding

2115 When an ATNA Audit message needs to be generated and the user is authenticated by way of an X-User Assertion, the ATNA Audit message **UserName** element shall record the X-User Assertion using the following encoding:

alias"<"**user**"@"**issuer**">"

where:

- 2120
- **alias** is the optional string within the SAML Assertion's Subject element SPProvidedID attribute
 - **user** is the required content of the SAML Assertion's Subject element

- **issuer** is the X-Assertion Provider entity ID contained with the content of SAML Assertion's Issuer element

2125 **3.40.4.3 Informative Material on WS-Trust**

If the X-Service Provider uses WS-Trust in order to obtain a SAML assertion from an X-Identity Provider, it is suggested to use the version 1.3 of the WS-Trust specification, as described in [WS-Trust].

3.41 Provide and Register Document Set-b

2130 This section corresponds to Transaction [ITI-41] of the IHE Technical Framework. Provide and Register Document Set-b is used by the Document Source to provide a set of documents to the Document Repository, and to request that the Document Repository store these documents and then register them with the Document Registry. The Document Source may also provide a set of documents to a Document Recipient.

2135

Integration Profiles using this Transaction
Cross-Enterprise Document Sharing-b (XDS.b)
Cross-Enterprise Document Reliable Interchange (XDR)

The Provide and Register Document Set-b transaction describes the interaction between the Document Source and the Document Recipient actors, and the Document Source and Document Repository actors. The interaction between the Document Repository and the XDS Document Registry is described separately in the Register Document Set-b Transaction [ITI-42].

2140 This transaction aligns with the Registry Services standard (ebRS) for the format of the document metadata as defined in ITI TF-3: 4.1. The ebRS standard covers the interaction with a service that includes a registry with integrated repository. From the point of view of the Document Source, the separate nature of the XDS Document Registry and Document Repository actors is not relevant.

2145 By specifying separate Document Registry and Document Repository actors, XDS offers additional flexibility of having a single Document Registry index content for multiple Document Repositories. The ebRIM portion of the registry standard supports this possibility though the ExternalLink object type.

2150 In XDS, the documents and metadata go to the Document Repository actor and then the metadata is forwarded on to the Document Registry actor. They move in this direction for several reasons:

- Allows best reuse of ebXML Registry specified metadata and web services protocols
- Document Source only needs to know the identity of the Document Repository. Document Repository knows the identity of the Document Registry. If Provide and Register Document Set-b transaction were sent to the Document Registry then routing decisions for documents would be more complex.
- Resulting protocols are simpler

2155

- Simplifies the common case where the Document Source and the Document Repository are grouped.

3.41.1 Scope

2160 The Provide and Register Document Set-b transaction passes a Repository Submission Request (see ITI TF-3: 4.1.3.1) from a Document Source to a Document Repository or Document Recipient.

A Provide and Register Document Set-b transaction shall carry:

- Metadata describing zero or more documents
- 2165 • Within metadata, one XDSDocumentEntry object per document
- XDS Submission Set definition along with the linkage to new documents and references to existing documents
- Zero or more XDS Folder definitions along with linkage to new or existing documents
- Zero or more documents

2170

3.41.2 Use Case Roles

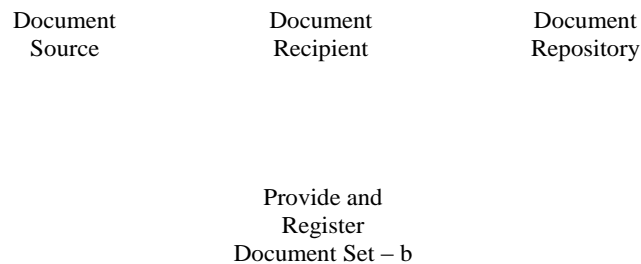

Actor: Document Source

2175 **Role:** A system that submits documents and associated metadata to a Document Repository. Detailed requirements for this actor are discussed in ITI TF-2b: 3.41.6.1.

Actor: Document Recipient

2180 **Role:** A system that receives a set of documents. Typically this document set will be made available to the intended recipient who will chose to either view it or integrate it into the Electronic Healthcare Record (EHR).

Detailed requirements for this actor are discussed in ITI TF-2b: 3.41.6.2.

Actor: Document Repository

Role: A document storage system that receives documents and associated metadata and:

- Stores the documents

- 2185
- Enhances submitted metadata with repository information to enable later retrieval of documents
 - Forwards the enhanced metadata to the Document Registry.

Detailed requirements for this actor are discussed in ITI TF-2b: 3.41.6.2.

3.41.3 Referenced Standards

- 2190 Implementors of this transaction shall comply with all requirements described in: ITI TF-2x: Appendix V: Web Services for IHE Transactions.

ebRIM	OASIS/ebXML Registry Information Model v3.0
ebRS	OASIS/ebXML Registry Services Specifications v3.0
Appendix V	ITI TF-2x:Appendix V Web Services for IHE Transactions Contains references to all Web Services standards and requirements of use
MTOM	SOAP Message Transmission Optimization Mechanism http://www.w3.org/TR/soap12-mtom/
XOP	XML-binary Optimized Packaging http://www.w3.org/TR/2005/REC-xop10-20050125/

3.41.4 Interaction Diagrams

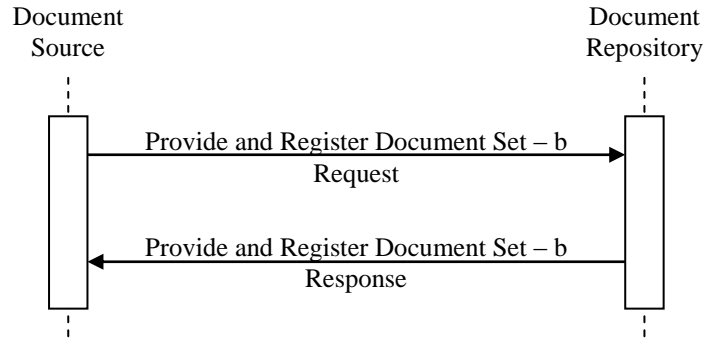

2195

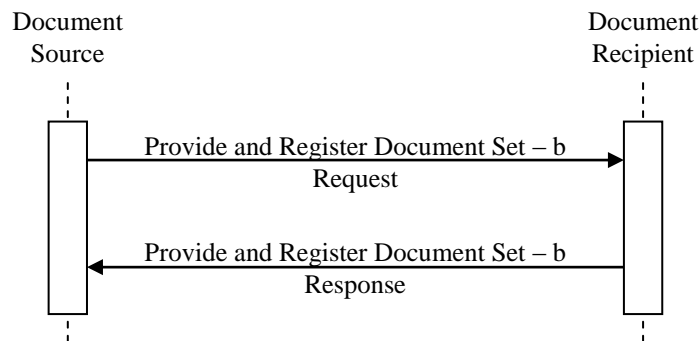

3.41.4.1 Provide and Register Document Set-b Request

2200 A Document Source sends documents and associated metadata to a Document Recipient, or a Document Repository that has an associated Document Registry.

The Document Repository shall, upon receipt of a Provide and Register Document Set-b [ITI-41] transaction send a corresponding Register Document Set-b [ITI-42] transaction to the Document Registry actor.

- 2205 • The Document Repository actor shall create and insert the XSDDocumentEntry.repositoryUniqueId, XSDDocumentEntry.size, and XSDDocumentEntry.hash attributes for each document received from the Provide and Register Document Set-b [ITI-41] transaction into the resulting Register Document Set-b [ITI-42] transaction metadata. The combination of
- 2210 XSDDocumentEntry.uniqueId and XSDDocumentEntry.repositoryUniqueId attributes value shall later be accepted in a Retrieve Document Set transaction [ITI-43] for that document and the document shall be returned.

3.41.4.1.1 Trigger Events

The Document Source, based on a human decision or the application of a certain rule of automatic operation, wants to submit

- 2215 • A set of zero or more documents to the Document Repository and the associated metadata to the Document Registry.
or
- A set of one or more documents to a Document Recipient.

2220 3.41.4.1.2 Message Semantics

The sections in ITI TF-3: 4.1 specify the mapping of XDS concepts to ebRS and ebRIM semantics and document metadata. A full example of document metadata submission can be found in ITI TF-2x: Appendix W.

3.41.4.1.3 Expected Actions

2225 The Provide and Register Document Set-b message shall include the metadata attributes (as defined in ITI TF-3: 4.1.7 Document Definition Metadata)

A Document Recipient receives the metadata and the associated document(s). It shall be able to interpret the submission without any context (eg. a prior submission).

2230 The Document Source may include Folders in metadata. If the Document Recipient is not able to process the Folder specific content it shall return a PartialFolderContentNotProcessed warning which includes a textual description identifying that Folder Content was not processed. In this case the Document Recipient is expected to have processed the rest of the submission successfully.

2235 In the case where the Document Source submits a replacement of documents, if the Document Recipient is not able to process the replacement semantics in the submission it shall return a

PartialReplaceContentNotProcessed warning which includes a textual description identifying that the replacement semantics were not processed. In this case the Document Recipient is expected to have processed the rest of the submission successfully.

2240 A Document Repository shall forward the metadata to the Document Registry using the Register Document Set-b transaction [ITI-42].

The Document Repository receives this message. Each document within the message shall be stored into the Document Repository as an octet stream with an associated MIME type.

2245 The Document Source shall supply all necessary document metadata attributes with the exception of the ones below. The Document Repository shall modify the received document metadata before initiating the Register Document Set-b transaction to the Document Registry by adding/replacing:

- The repositoryUniqueId for this Document Repository to allow for the Document Consumer to correctly identify the proper Document Repository for each document (XDSDocumentEntry.repositoryUniqueId).
- 2250 • A hash value (XDSDocumentEntry.hash)
- A size (XDSDocumentEntry.size).

A Register Document Set-b transaction with this modified metadata shall be issued to the Document Registry.

2255 The Document Repository shall ensure that when any Retrieve Document Set transaction is received requesting a specific document(s), it shall be provided to the Document Consumer unchanged from the octet stream that was submitted (full fidelity repository) and shall match the size and hash attributes of the XDSDocumentEntry object.

2260 If the Document Repository or Document Recipient detects a failure it shall return an error message to the Document Source thus terminating this transaction. The conditions of failure and possible error messages are given in the ebRS standard and detailed in ITI TF-3: 4.1.13 Error Reporting.

3.41.4.1.3.1 Basic Patient Privacy Enforcement Option

If the Basic Patient Privacy Enforcement Option is implemented:

- 2265 1. The Document Source actor shall populate the confidentialityCode in the document metadata with the list of values that identify the sensitivity classifications that apply to the associated document. The confidentiality codes for different documents in the same submission may be different.
- 2270 2. The Document Source actor shall be able to be configured with the Patient Privacy Policies, Patient Privacy Policy Identifiers (OIDs) and associated information necessary to understand and enforce the XDS Affinity Domain Policy. The details of this are product specific and not specified by IHE.
- 2275 3. The Document Source actor may have user interface or business rule capabilities to determine the appropriate confidentiality codes for each document. The details of this are product specific and not specified by IHE. However, the information about how confidentiality codes are assigned must be part of the published policy for the XDS

Affinity Domain. Note: For example, when publishing a document, the Document Source, might show a list of checkboxes where a user can select which of the available consents a document is to be published.

- 2280
- 2285
- 2290
- 2295
4. The Document Recipient actor shall be able to be configured with the Patient Privacy Policies, Patient Privacy Policy Identifiers (OIDs) and associated information necessary to understand and enforce the policies. The meanings of the codes on the media must be provided out of band, e.g., by telephone, fax, or email. The detail of how this is done is product specific and not specified by IHE. If the documents are transferred internally within the organization or to other members of the recipient's affinity domain, appropriate internal confidentiality codes shall be applied.
 5. The Document Recipient actor shall have the ability to coerce the confidentiality code in the metadata associated with the document from the codes used by the Document Source to the codes used by the Document Recipient.
 6. The Document Recipient actor shall abide by the XDS Affinity Domain Policies represented by the confidentialityCode in the metadata associated with the document. The Document Recipient actor likely will have user access controls or business rule capabilities to determine the details of how confidentiality codes apply to query results. The details of this are product specific and not specified by IHE. These rules shall reduce the query results to only those that are appropriate to the current situation for that actor and user.

3.41.4.2 Provide and Register Document Set-b Response

The Document Repository or Document Recipient shall send a Provide and Register Document Set-b Response when the processing of a Provide and Register Document Set-b Request is complete.

- 2300
- The Provide and Register Document Set-b Response message shall carry the status of the requested operation and an error message if the requested operation failed. The conditions of failure and possible error messages are given in the ebRS standard and detailed in ITI TF-3: 4.1.13 Error Reporting.

3.41.4.2.1 Trigger Events

- 2305
- The following events can trigger this message:
- Documents successfully received and processed by the Document Recipient
 - Documents were not successfully received by the Document Recipients
 - Documents stored to the Document Repository successfully and metadata stored to the Document Registry successfully (The registry part is carried out as part of a Register Document Set-b transaction)
 - Documents stored to the Document Repository successfully but an error occurred in storing the metadata to the Document Registry
 - Documents were not successfully stored to the Document Repository
- 2310

3.41.4.2.2 Message Semantics

2315 The Provide and Register Document Set-b Response message shall carry the status of the requested operation and an error message if the requested operation failed. The conditions of failure and possible error messages are given in the ebRS standard and detailed in ITI TF-3: 4.1.13 Error Reporting.

3.41.4.2.3 Expected Actions

2320 The Document Source now knows that the transaction succeeded/failed and can continue. The document(s) received by the Document Recipient shall be available for further processing according to the capabilities of the system. These capabilities are not specified by IHE, but may include viewing the document or storing them to an Electronic Healthcare Record (EHR).

2325 The document(s) added to the Document Repository are now available for retrieval. The metadata added to the registry shall be available for discovery via Registry Stored Query transactions.

3.41.5 Protocol Requirements

Implementors of this transaction shall comply with all requirements described in ITI TF-2x :Appendix V: Web Services for IHE Transactions.

2330 The Provide and Register Document Set-b transaction shall use SOAP12 and MTOM with XOP encoding (labeled MTOM/XOP in this specification). See ITI TF-2x: Appendix V for details.

WSDL Namespace Definitions

ihe	urn:ihe:iti:xds-b:2007
rs	urn:oasis:names:tc:ebxml-regrep:xsd:rs:3.0
lcm	urn:oasis:names:tc:ebxml-regrep:xsd:lcm:3.0
query	urn:oasis:names:tc:ebxml-regrep:xsd:query:3.0

These are the requirements for the Provide and Register Document Set-b transaction presented in the order in which they would appear in the WSDL definition:

- 2335
- The following types shall be imported (xsd:import) in the /definitions/types section:
 - namespace="urn:oasis:names:tc:ebxml-regrep:xsd:rs:3.0", schema="rs.xsd"
 - namespace="urn:ihe:iti:xds-b:2007", schemaLocation="IHEXDS.xsd"
 - The /definitions/message/part/@element attribute of the Provide and Register Document Set-b Request message shall be defined as
- 2340
- “ihe:ProvideAndRegisterDocumentSetRequest”
 - The /definitions/message/part/@element attribute of the Provide and Register Document Set-b Response message shall be defined as “rs:RegistryResponse”
 - The /definitions/portType/operation/input/@wsaw:Action attribute for the Provide and Register Document Set-b Request message shall be defined as
- 2345
- “urn:ihe:iti:2007:ProvideAndRegisterDocumentSet-b”

- The /definitions/portType/operation/output/@wsaw:Action attribute for the Provide and Register Document Set-b Response message shall be defined as “urn:ihe:iti:2007:ProvideAndRegisterDocumentSet-bResponse”
- The /definitions/binding/operation/soap12:operation/@soapAction attribute shall be defined as “urn:ihe:iti:2007:ProvideAndRegisterDocumentSet-b”

2350

These are the requirements that affect the wire format of the SOAP message. The other WSDL properties are only used within the WSDL definition and do not affect interoperability. Full sample request and response messages are in ITI TF-2b: 3.41.5.1 Sample SOAP Messages.

For informative WSDL for the Document Repository actor see ITI TF-2x: Appendix W.

2355 The <ihe:ProvideAndRegisterDocumentSetRequest/> element is defined as:

- One <lcm:SubmitObjectsRequest/> element that contains the submission set metadata
- Zero or more <ihe:Document/> elements that contain the base64encoded data for the documents being submitted to the Document Repository or Document Recipient. The <ihe:Document/> element also includes the document id attribute (ihe:Document/@id) of type xsd:anyURI to match the document ExtrinsicObject id in the metadata and providing the necessary linkage

2360

The use of MTOM/XOP is governed by the following rules:

- The Document Repository or Document Recipient shall accept documents in a Provide and Register Document Set-b transaction in MTOM/XOP format. The response message shall use MTOM/XOP format.
- The Document Source shall generate Provide and Registry Document Set-b transactions in MTOM/XOP format. It shall accept the response message in MTOM/XOP format.

2365

2370 A full XML Schema Document for the XDS.b types is available online on the IHE FTP site, see ITI TF-2x: Appendix W.

3.41.5.1 Sample SOAP Messages

2375 The samples in the following two sections show a typical SOAP request and its relative SOAP response. The sample messages also show the WS-Addressing headers <Action/>, <MessageID/>, <ReplyTo/>...; these WS-Addressing headers are populated according to the ITI TF-2x: Appendix V: Web Services for IHE Transactions. The body of the SOAP message is omitted for brevity; in a real scenario the empty element will be populated with the appropriate metadata.

Samples presented in this section are also available online on the IHE FTP site, see ITI TF-2x: Appendix W.

2380 3.41.5.1.1 Sample Provide and Register Document Set-b SOAP Request

```
2385 POST /axis2/services/repository HTTP/1.1
Content-Type: multipart/related; boundary=MIMEBoundaryurn_uuid_76A2C3D9BCD3AECFF31217932910180;
type="application/xop+xml"; start="<0.urn:uuid76A2C3D9BCD3AECFF31217932910181@apache.org>";
start-info="application/soap+xml"; action="urn:ihe:iti:2007:ProvideAndRegisterDocumentSet-b"
User-Agent: Axis2
Host: localhost:4040
```

Content-Length: 4567

```

2390 --MIMEBoundaryurn_uuid_76A2C3D9BCD3AECFF31217932910180
Content-Type: application/xop+xml; charset=UTF-8; type="application/soap+xml"
Content-Transfer-Encoding: binary
Content-ID: <0.urn:uuid:76A2C3D9BCD3AECFF31217932910181@apache.org>

2395 <?xml version='1.0' encoding='UTF-8'?>
<soapenv:Envelope xmlns:soapenv="http://www.w3.org/2003/05/soap-envelope"
xmlns:wsa="http://www.w3.org/2005/08/addressing">
  <soapenv:Header>
    <wsa:To>http://localhost:4040/axis2/services/test11966a</wsa:To>
    <wsa:MessageID>urn:uuid:76A2C3D9BCD3AECFF31217932910053</wsa:MessageID>
    <wsa:Action soapenv:mustUnderstand="1">urn:ihe:iti:2007:ProvideAndRegisterDocumentSet-
2400 b</wsa:Action>
  </soapenv:Header>
  <soapenv:Body>
2405    <xdsb:ProvideAndRegisterDocumentSetRequest xmlns:xdsb="urn:ihe:iti:xds-b:2007">
      <lcm:SubmitObjectsRequest xmlns:lcm="urn:oasis:names:tc:ebxml-regrep:xsd:lcm:3.0">
        <rim:RegistryObjectList xmlns:rim="urn:oasis:names:tc:ebxml-regrep:xsd:rim:3.0">
2410           <!-- Registry Metadata goes here -->
          </rim:RegistryObjectList>
        </lcm:SubmitObjectsRequest>
        <xdsb:Document id="Document01">
2415           <xop:Include href="cid:1.urn:uuid:76A2C3D9BCD3AECFF3121793290229@apache.org"
            xmlns:xop="http://www.w3.org/2004/08/xop/include"/>
          </xdsb:Document>
        </xdsb:ProvideAndRegisterDocumentSetRequest>
      </soapenv:Body>
2420 </soapenv:Envelope>

--MIMEBoundaryurn_uuid_76A2C3D9BCD3AECFF31217932910180
Content-Type: text/plain
Content-Transfer-Encoding: binary
Content-ID: <1.urn:uuid:76A2C3D9BCD3AECFF31217932910229@apache.org>
2425 This is my document.

It is great!
2430 --MIMEBoundaryurn_uuid_76A2C3D9BCD3AECFF31217932910180--

```

2435 3.41.5.1.2 Sample Provide and Register Document Set-b SOAP Response

```
2440 <s:Envelope
      xmlns:s="http://www.w3.org/2003/05/soap-envelope"
      xmlns:a="http://www.w3.org/2005/08/addressing">
  <s:Header>
    <a:Action s:mustUnderstand="1">
      urn:ihe:iti:2007:ProvideAndRegisterDocumentSet-bResponse
    </a:Action>
    <a:RelatesTo>urn:uuid:6d296e90-e5dc-43d0-b455-7c1f3eb35d83</a:RelatesTo>
  </s:Header>
  <s:Body>
    <rs:RegistryResponse
      status="urn:oasis:names:tc:ebxml-regrep:ResponseStatusType:Success"
      xmlns:rs="urn:oasis:names:tc:ebxml-regrep:xsd:rs:3.0" />
  </s:Body>
</s:Envelope>
```

3.41.6 Actor Requirements

This section summarizes the responsibilities of the actors relevant to this transaction.

3.41.6.1 Document Source

2455 An implementation of the Document Source actor shall be capable of the following operations:

- Submit one or more documents. Whether a submission contains a single or multiple documents depends on workflows, policies, and other external factors which are outside of the scope of this transaction.

2460 An implementation of the XDS Document Source actor may support one or more of the following XDS.b options:

- **Document Replace Option:** In this option the Document Source offers the ability to submit a document as a replacement for another document already in the registry/repository.
- **Document Addendum Option** In this option the Document Source shall offer the ability to submit a document as an addendum to another document already in the registry/repository.
- **Document Transformation Option** In this option the Document Source shall offer the ability to submit a document as a transformation of another document already in the registry/repository.

2470

Note: In order to support document replacement/addendum/transformation grouping with the Document Consumer may be necessary in order to Query the registry (e.g., for UUIDs of existing document entries)

- **Folder Management Option.** In this option the Document Source offers the ability to perform the following operation:
 - Create a folder
 - Add one or more documents to a folder

2475

Note: In order to support document addition to an existing folder, grouping with the Document Consumer may be necessary in order to Query the registry (e.g., for UUIDs of existing folder).

These operations are discussed in ITI TF-3: 4.1.3.4 Other Properties of Submission Requests.

2480 **3.41.6.2 Document Repository or Document Recipient**

A Document Repository or Document Recipient shall be capable of accepting submissions containing multiple documents.

Note: The Document Source may submit single documents or multiple documents depending on its needs.

2485 A Document Repository shall validate the following metadata element received as part of a Provide and Register transaction:

- **XDSDocumentEntry.uniqueId** – a submission shall be rejected if not unique within the repository and the hashes of the two documents do not match. If the hashes of the documents match, the Document Repository shall accept the duplicate document.

2490 A Document Repository or Document Recipient shall validate the following metadata element received as part of a Provide and Register transaction:

- **XDSSubmissionSet.sourceId** – a Document Repository or Document Recipient may choose to accept submissions only from certain sources and use this field to perform the filtering.
- **XDSDocumentEntry.hash** – a submission shall be rejected if the hash is included in the submission and its value does not match the hash for the received document (ignoring case), as calculated by the Document Repository or Document Recipient; an XDSRepositoryMetadataError shall be returned on mismatch.
- **XDSDocumentEntry.size** – a submission shall be rejected if the size is included in the submission and its value does not match the size of the received document, as computed by the Document Repository or Document Recipient; an XDSRepositoryMetadataError shall be returned on mismatch.

2500 **3.41.7 Security Considerations**

Relevant XDS Affinity Domain security considerations are discussed in the XDS Security Considerations Section (see ITI TF-1: 10.7).

2505 **3.41.7.1 Audit Record Considerations**

The Provide and Register Document Set-b Transaction is PHI-Export event, as defined in ITI TF-2a: Table 3.20.6-1. The Actors involved in the transaction shall create audit data in conformance with DICOM (Supp 95) “Data Export”/”Data Import”, with the following exceptions.

2510

3.41.7.1.1 Document Source audit message:

	Field Name	Opt	Value Constraints
Event AuditMessage/ EventIdentification	EventID	M	EV(110106, DCM, "Export")
	EventActionCode	M	"R" (Read)
	EventDateTime	M	not specialized
	EventOutcomeIndicator	M	not specialized
	EventTypeCode	M	EV("ITI-41", "IHE Transactions", "Provide and Register Document Set-b")
Source (Document Source) (1)			
Human Requestor (0..n)			
Destination (Document Repository) (1)			
Audit Source (Document Source) (1)			
Patient (1)			
SubmissionSet (1)			

Where:

Source AuditMessage/ ActiveParticipant	UserID	M	The content of the <wsa:ReplyTo/> element.
	AlternativeUserID	M	the process ID as used within the local operating system in the local system logs.
	UserName	U	not specialized
	UserIsRequestor	M	"true"
	RoleIDCode	M	EV(110153, DCM, "Source")
	NetworkAccessPointTypeCode	M	"1" for machine (DNS) name, "2" for IP address
	NetworkAccessPointID	M	The machine name or IP address, as specified in RFC 3881.
Human Requestor (if known) AuditMessage/ ActiveParticipant	UserID	M	Identity of the human that initiated the transaction.
	AlternativeUserID	U	not specialized
	UserName	U	not specialized
	UserIsRequestor	M	"true"
	RoleIDCode	U	Access Control role(s) the user holds that allows this transaction.
	NetworkAccessPointTypeCode	NA	
	NetworkAccessPointID	NA	

Destination AuditMessage/ ActiveParticipant	UserID	M	SOAP endpoint URI.
	AlternativeUserID	U	not specialized
	UserName	U	not specialized
	UserIsRequestor	M	"false"
	RoleIDCode	M	EV(110152, DCM, "Destination")
	NetworkAccessPointTypeCode	M	"1" for machine (DNS) name, "2" for IP address
	NetworkAccessPointID	M	The machine name or IP address, as specified in RFC 3881.

Audit Source AuditMessage/ AuditSourceIdentification	AuditSourceID	U	Not specialized.
	AuditEnterpriseSiteID	U	not specialized
	AuditSourceTypeCode	U	not specialized

Patient (AuditMessage/ ParticipantObjectIdentifi- cation)	ParticipantObjectTypeCode	M	“1” (Person)
	ParticipantObjectTypeCodeRole	M	“1” (Patient)
	<i>ParticipantObjectDataLifeCycle</i>	<i>U</i>	<i>not specialized</i>
	ParticipantObjectIDTypeCode	M	EV(2, RFC-3881, “Patient Number”)
	<i>ParticipantObjectSensitivity</i>	<i>U</i>	<i>not specialized</i>
	ParticipantObjectID	M	The patient ID in HL7 CX format.
	<i>ParticipantObjectName</i>	<i>U</i>	<i>not specialized</i>
	<i>ParticipantObjectQuery</i>	<i>U</i>	<i>not specialized</i>
<i>ParticipantObjectDetail</i>	<i>U</i>	<i>not specialized</i>	
Submission Set (AuditMessage/ ParticipantObjectIdentifi- cation)	ParticipantObjectTypeCode	M	“2” (System)
	ParticipantObjectTypeCodeRole	M	“20” (job)
	<i>ParticipantObjectDataLifeCycle</i>	<i>U</i>	<i>not specialized</i>
	ParticipantObjectIDTypeCode	M	EV(“urn:uuid:a54d6aa5-d40d-43f9-88c5-b4633d873bdd”, “IHE XDS Metadata”, “submission set classificationNode”)
	<i>ParticipantObjectSensitivity</i>	<i>U</i>	<i>not specialized</i>
	ParticipantObjectID	M	The submissionSet unique ID
	<i>ParticipantObjectName</i>	<i>U</i>	<i>not specialized</i>
	<i>ParticipantObjectQuery</i>	<i>U</i>	<i>not specialized</i>
<i>ParticipantObjectDetail</i>	<i>U</i>	<i>not specialized</i>	

3.41.7.1.2 Document Repository or Document Recipient audit message:

	Field Name	Opt	Value Constraints
Event AuditMessage/ EventIdentification	EventID	M	EV(110107, DCM, “Import”)
	EventActionCode	M	“C” (Create)
	<i>EventDateTime</i>	<i>M</i>	<i>not specialized</i>
	<i>EventOutcomeIndicator</i>	<i>M</i>	<i>not specialized</i>
	EventTypeCode	M	EV(“ITI-41”, “IHE Transactions”, “Provide and Register Document Set-b”)
Source (Document Source) (1)			
Destination (Document Repository or Document Recipient) (1)			
Audit Source (Document Repository or Document Recipient) (1)			
Patient (1)			
SubmissionSet (1)			

Where:

Source AuditMessage/ ActiveParticipant	UserID	M	The content of the <wsa:ReplyTo/> element.
	AlternativeUserID	<i>U</i>	<i>not specialized</i>
	<i>UserName</i>	<i>U</i>	<i>not specialized</i>
	UserIsRequestor	M	“true”
	RoleIDCode	M	EV(110153, DCM, “Source”)
	NetworkAccessPointTypeCode	M	“1” for machine (DNS) name, “2” for IP address
	NetworkAccessPointID	M	The machine name or IP address, as specified in RFC 3881.

Destination (AuditMessage/ ActiveParticipant)	UserID	M	SOAP endpoint URI
	AlternativeUserID	M	the process ID as used within the local operating system in the local system logs.
	UserName	U	not specialized
	UserIsRequestor	M	“false”
	RoleIDCode	M	EV(110152, DCM, “Destination”)
	NetworkAccessPointTypeCode	M	“1” for machine (DNS) name, “2” for IP address
	NetworkAccessPointID	M	The machine name or IP address, as specified in RFC 3881.

Audit Source (AuditMessage/ AuditSourceIdentification)	AuditSourceID	U	Not specialized.
	AuditEnterpriseSiteID	U	not specialized
	AuditSourceTypeCode	U	not specialized

2520

Patient (AuditMessage/ ParticipantObjectIdentifi- cation)	ParticipantObjectTypeCode	M	“1” (Person)
	ParticipantObjectTypeCodeRole	M	“1” (Patient)
	ParticipantObjectDataLifeCycle	U	not specialized
	ParticipantObjectTypeCode	M	EV(2, RFC-3881, “Patient Number”)
	ParticipantObjectSensitivity	U	not specialized
	ParticipantObjectID	M	The patient ID in HL7 CX format.
	ParticipantObjectName	U	not specialized
	ParticipantObjectQuery	U	not specialized
ParticipantObjectDetail	U	not specialized	
Submission Set (AuditMessage/ ParticipantObjectIdentifi- cation)	ParticipantObjectTypeCode	M	“2” (System)
	ParticipantObjectTypeCodeRole	M	“20” (job)
	ParticipantObjectDataLifeCycle	U	not specialized
	ParticipantObjectTypeCode	M	EV(“urn:uuid:a54d6aa5-d40d-43f9-88c5-b4633d873bdd”, “IHE XDS Metadata”, “submission set classificationNode”)
	ParticipantObjectSensitivity	U	not specialized
	ParticipantObjectID	M	The submissionSet unique ID
	ParticipantObjectName	U	not specialized
	ParticipantObjectQuery	U	not specialized
ParticipantObjectDetail	U	not specialized	

3.42 Register Document Set-b

This section corresponds to transaction [ITI-42] of the IHE IT Infrastructure Technical Framework. Transaction [ITI-42] is used by the Document Repository Actor to register a set of documents with the Document Registry in XDS.b.

2525

Integration Profiles using this Transaction
Cross-Enterprise Document Sharing-b (XDS.b)

3.42.1 Scope

The Register Document Set-b transaction passes a Submission Request from a Document Repository actor to a Document Registry actor.

2530 A Register Document Set-b transaction shall carry:

- Metadata describing zero or more documents
- XDS Submission Set definition along with the linkage to new documents and references to existing documents
- An optional XDS Folder definitions along with linkage to new or existing documents

2535

3.42.2 Use Case Roles

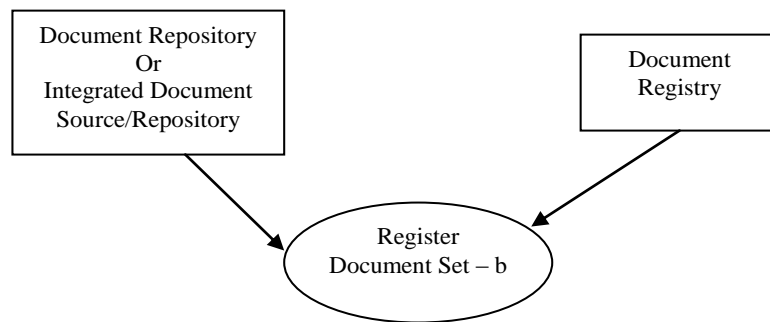

2540 **Actor:** Document Repository or Integrated Document Source/Repository

Role: A document storage system that submits document metadata to a Document Registry.

Actor: Document Registry

Role: A document indexing system that receives and stores document metadata.

Note: Within this transaction, the Document Repository and Integrated Document Source/Repository actors can be used interchangeably

2545

3.42.3 Referenced Standards

Implementors of this transaction shall comply with all requirements described in ITI TF-2x: Appendix V: Web Services for IHE Transactions.

ebRIM	OASIS/ebXML Registry Information Model v3.0
ebRS	OASIS/ebXML Registry Services Specifications v3.0
HL7V2	HL7 Version 2.5
Appendix V	ITI TF-2x:Appendix V Web Services for IHE Transactions Contains references to all Web Services standards and requirements of use

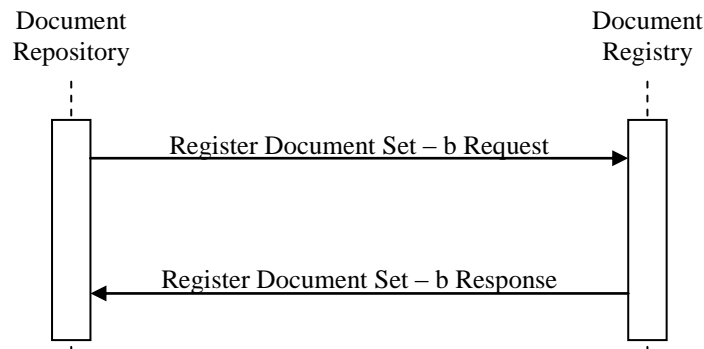
2550 **3.42.4 Interaction Diagram****3.42.4.1 Register Document Set-b Request**

2555 The Document Repository sends metadata for a set of documents to the Document Registry.

3.42.4.1.1 Trigger Events

The Register Document Set-b Request message is triggered when:

- A Document Repository wants to register metadata for a set of documents it holds. These documents may have been stored in the Document Repository by a Document Consumer (using the Provide and Register Document Set-b transaction [ITI-41]) or generated internally by an Integrated Document Source/Repository.
- 2560

3.42.4.1.2 Message Semantics

The sections in ITI TF-3: 4.1 specify the mapping of XDS concepts to ebRS and eBRIM semantics and document metadata. A full example of document metadata submission can be found in ITI TF-2x: Appendix W.

2565

The Registry actor shall store and later include in metadata returned in a query response the XSDocumentEntry.repositoryUniqueId attribute along with other metadata attributes received in the Register Document Set-b [ITI-42] transaction as determined by profile and transaction requirements.

2570 **3.42.4.1.4 Expected Actions**

Upon receipt of a Register Document Set-b Request message, the Document Registry with the aid of the Registry Adaptor shall do the following:

- Accept all valid SubmitObjectsRequests.
 - Perform metadata validations
 - Update the registry with the contained metadata
 - Return a RegistryResponse message given the status of the operation.
- 2575

If the registry rejects the metadata, then, the following shall occur:

- An error is returned
- The error status includes an error message
- 2580 • The request is rolled back

3.42.4.1.4.1 Basic Patient Privacy Enforcement Option

If the Basic Patient Privacy Enforcement Option is implemented:

- 2585 1. The Integrated Document Source / Repository actor shall populate the confidentialityCode in the document metadata with the list of values that identify the sensitivity classifications that apply to the associated document. The confidentiality codes for different documents in the same submission may be different.
- 2590 2. The Integrated Document Source / Repository actor shall be able to be configured with the Patient Privacy Policies, Patient Privacy Policy Identifiers (OIDs) and associated information necessary to understand and enforce the XDS Affinity Domain Policy. The details of this are product specific and not specified by IHE.
- 2595 3. The Integrated Document Source / Repository actor may have a user interface or business rule capabilities to determine the appropriate confidentiality codes for each document. The details of this are product specific and not specified by IHE. However, the information about how confidentiality codes are assigned must be part of the published policy for the XDS Affinity Domain. For example, when publishing a document, the Integrated Document Source / Repository might show a list of checkboxes where a user can select which of the available consents a document is to be published.

3.42.4.1.5 Protocol Requirements

The Register Document Set-b transaction shall use SOAP12. Furthermore:

- 2600 • The Document Registry actor shall accept the Register Document Set-b Request formatted as a SIMPLE SOAP message and respond with the Register Document Set-b Response formatted as a SIMPLE SOAP message.
- 2605 • The Document Repository actor shall generate the Register Document Set-b Request formatted as a SIMPLE SOAP message and accept the Register Document Set-b Response formatted as a SIMPLE SOAP message.

See ITI TF-2x: Appendix V for details.

3.42.4.2 Register Document Set-b Response

3.42.4.2.1 Trigger Events

2610 The Document Registry finishes processing a Register Document Set-b Request Message and shall respond with:

- Register Document Set-b Response

3.42.4.2.2 Message Semantics

2615 The Register Document Set-b Response message shall carry the status of the requested operation and an error message if the requested operation failed. The conditions of failure and possible error messages are given in the ebRS standard and detailed in ITI TF-3: 4.1.13 Error Reporting.

3.42.4.2.3 Expected Actions

The Document Repository now knows that the transaction succeeded/failed and can continue. The metadata added to the registry as a result of this transaction is now available for discovery.

3.42.5 Protocol Requirements

2620 Implementors of this transaction shall comply with all requirements described in ITI TF-2x: Appendix V: Web Services for IHE Transactions.

WSDL Namespace Definitions

ihe	urn:ihe:iti:xds-b:2007
rs	urn:oasis:names:tc:ebxml-regrep:xsd:rs:3.0
lcm	urn:oasis:names:tc:ebxml-regrep:xsd:lcm:3.0
query	urn:oasis:names:tc:ebxml-regrep:xsd:query:3.0

2625 These are the requirements for the Register Document Set-b transaction presented in the order in which they would appear in the WSDL definition:

- The following types shall be imported (xsd:import) in the /definitions/types section:
 - namespace="urn:oasis:names:tc:ebxml-regrep:xsd:rs:3.0", schema=" rs.xsd"
 - namespace="urn:oasis:names:tc:ebxml-regrep:xsd:lcm:3.0", schema=" lcm.xsd"
- 2630 • The /definitions/message/part/@element attribute of the Register Document Set-b Request message shall be defined as “lcm:SubmitObjectsRequest”
- The /definitions/message/part/@element attribute of the Register Document Set-b Response message shall be defined as “rs:RegistryResponse”
- 2635 • The /definitions/portType/operation/input/@wsaw:Action attribute for the Register Document Set-b Request message shall be defined as “urn:ihe:iti:2007:RegisterDocumentSet-b”
- The /definitions/portType/operation/output/@wsaw:Action attribute for the Register Document Set-b Response message shall be defined as “urn:ihe:iti:2007:RegisterDocumentSet-bResponse”
- 2640 • The /definitions/binding/operation/soap12:operation/@soapAction attribute shall be defined as “urn:ihe:iti:2007:RegisterDocumentSet-b”

These are the requirements that affect the wire format of the SOAP message. The other WSDL properties are only used within the WSDL definition and do not affect interoperability. Full sample request and response messages are in ITI TF-2b: 3.42.5.1 Sample SOAP Messages.

2645 For informative WSDL for the Document Registry actor see ITI TF-2x: Appendix W.

3.42.5.1 Sample SOAP Messages

The samples in the following two sections show a typical SOAP request and its relative SOAP response. The sample messages also show the WS-Addressing headers <Action/>, <MessageID/>, <ReplyTo/>...; these WS-Addressing headers are populated according to ITI TF-2x: Appendix V: Web Services for IHE Transactions. The body of the SOAP message is omitted for brevity; in a real scenario the empty element will be populated with the appropriate metadata.

2650 Samples presented in this section are also available online on the IHE FTP site, see ITI TF-2x: Appendix W.

3.42.5.1.1 Sample Register Document Set-b SOAP Request

```
<s:Envelope xmlns:s="http://www.w3.org/2003/05/soap-envelope"
xmlns:a="http://www.w3.org/2005/08/addressing">
```

```

2660 <s:Header>
    <a:Action s:mustUnderstand="1">urn:ihe:iti:2007:RegisterDocumentSet-b</a:Action>
    <a:MessageID>urn:uuid:1ec52e14-4aad-4ba1-b7d3-fc9812a21340</a:MessageID>
    <a:ReplyTo>
      <a:Address>http://www.w3.org/2005/08/addressing/anonymous</a:Address>
    </a:ReplyTo s:mustUnderstand="1">
2665 <a:To >http://localhost:2647/XdsService/IHEXDSRegistry.svc</a:To>
    </s:Header>
    <s:Body>
      <lcm:SubmitObjectsRequest
2670       xmlns:lcm="urn:oasis:names:tc:ebxml-regrep:xsd:lcm:3.0"
       xmlns:rims="urn:oasis:names:tc:ebxml-regrep:xsd:rims:3.0"
       xmlns:rs="urn:oasis:names:tc:ebxml-regrep:xsd:rs:3.0">

        <!--Rest of SubmitObjectsRequest message goes here -->

2675      </lcm:SubmitObjectsRequest>
    </s:Body>
  </s:Envelope>

```

3.42.5.1.2 Sample Register Document Set-b SOAP Response

```

2680 <s:Envelope
  xmlns:s="http://www.w3.org/2003/05/soap-envelope"
  xmlns:a="http://www.w3.org/2005/08/addressing">
  <s:Header>
2685    <a:Action s:mustUnderstand="1">urn:ihe:iti:2007:RegisterDocumentSet-bResponse</a:Action>
    <a:RelatesTo>urn:uuid:1ec52e14-4aad-4ba1-b7d3-fc9812a21340</a:RelatesTo>
  </s:Header>
  <s:Body>
2690    <rs:RegistryResponse
      status="urn:oasis:names:tc:ebxml-regrep:ResponseStatusType:Success"
      xmlns:rs="urn:oasis:names:tc:ebxml-regrep:xsd:rs:3.0"/>
    </s:Body>
  </s:Envelope>

```

3.42.6 Actor Requirements

2695 The Document Repository actor shall:

- Make (all) the new document(s) included in the XDS Submission Set available for retrieval via the Retrieve Document Set transaction before it initiates the Register Document Set-b Request message with the Registry actor.

This is necessary because:

- 2700
- The Document Registry actor may choose to validate the successful storage of the document(s) before acknowledging the Register Document Set-b Request transaction.
 - The Document Consumer actor may retrieve the document(s) before the Register Document Set-b Response is received by the Document Repository actor.

3.42.7 Security Considerations

2705 Relevant XDS Affinity Domain Security background is discussed in the XDS Security Considerations Section (see ITI TF-1: 10.7).

3.42.7.1 Audit Record Considerations

2710 The Register Document Set-b Transaction is PHI-Export event, as defined in ITI TF-2a: Table 3.20.6-1. The Actors involved in the transaction shall create audit data in conformance with DICOM (Supp 95) “Data Export”, with the following exceptions.

3.42.7.1.1 Document Repository or Integrated Document Source/Repository audit message:

	Field Name	Opt	Value Constraints
Event AuditMessage/ EventIdentification	EventID	M	EV(110106, DCM, “Export”)
	EventActionCode	M	“R” (Read)
	EventDateTime	M	not specialized
	EventOutcomeIndicator	M	not specialized
	EventTypeCode	M	EV(“ITI-42”, “IHE Transactions”, “Register Document Set-b”)
Source (Document Repository or Integrated Document Source/Repository) (1)			
Human Requestor (0..n)			
Destination (Document Registry) (1)			
Audit Source (Document Repository or Integrated Document Source/Repository) (1)			
Patient (1)			
SubmissionSet (1)			

Where:

Source AuditMessage/ ActiveParticipant	UserID	U	When WS-Addressing is used: <ReplyTo/>
	AlternativeUserID	M	the process ID as used within the local operating system in the local system logs.
	UserName	U	not specialized
	UserIsRequestor	M	“true”
	RoleIDCode	M	EV(110153, DCM, “Source”)
	NetworkAccessPointTypeCode	M	“1” for machine (DNS) name, “2” for IP address
	NetworkAccessPointID	M	The machine name or IP address, as specified in RFC 3881.
Human Requestor (if known) AuditMessage/ ActiveParticipant	UserID	M	Identity of the human that initiated the transaction.
	AlternativeUserID	U	not specialized
	UserName	U	not specialized
	UserIsRequestor	M	“true”
	RoleIDCode	U	Access Control role(s) the user holds that allows this transaction.
	NetworkAccessPointTypeCode	NA	
	NetworkAccessPointID	NA	

Destination AuditMessage/ ActiveParticipant	UserID	M	SOAP endpoint URI.
	AlternativeUserID	U	not specialized
	UserName	U	not specialized
	UserIsRequestor	M	“false”
	RoleIDCode	M	EV(110152, DCM, “Destination”)
	NetworkAccessPointTypeCode	M	“1” for machine (DNS) name, “2” for IP address
	NetworkAccessPointID	M	The machine name or IP address, as specified in RFC 3881.

2715

IHE IT Infrastructure Technical Framework, Volume 2b (ITI TF-2b): Transactions Part B

Audit Source <small>AuditMessage/ AuditSourceIdentification</small>	<i>AuditSourceID</i>	<i>U</i>	<i>Not specialized.</i>
	<i>AuditEnterpriseSiteID</i>	<i>U</i>	<i>not specialized</i>
	<i>AuditSourceTypeCode</i>	<i>U</i>	<i>not specialized</i>

Patient <small>(AuditMessage/ ParticipantObjectIdentifi- fication)</small>	<i>ParticipantObjectTypeCode</i>	<i>M</i>	<i>“1” (person)</i>
	<i>ParticipantObjectTypeCodeRole</i>	<i>M</i>	<i>“1” (patient)</i>
	<i>ParticipantObjectDataLifeCycle</i>	<i>U</i>	<i>not specialized</i>
	<i>ParticipantObjectTypeCode</i>	<i>M</i>	<i>EV(2, RFC-3881, “Patient Number”)</i>
	<i>ParticipantObjectSensitivity</i>	<i>U</i>	<i>not specialized</i>
	<i>ParticipantObjectID</i>	<i>M</i>	<i>the patient ID in HL7 CX format.</i>
	<i>ParticipantObjectName</i>	<i>U</i>	<i>not specialized</i>
	<i>ParticipantObjectQuery</i>	<i>U</i>	<i>not specialized</i>
	<i>ParticipantObjectDetail</i>	<i>U</i>	<i>not specialized</i>
Submission Set <small>(AuditMessage/ ParticipantObjectIdentifi- fication)</small>	<i>ParticipantObjectTypeCode</i>	<i>M</i>	<i>“2” (System)</i>
	<i>ParticipantObjectTypeCodeRole</i>	<i>M</i>	<i>“20” (job)</i>
	<i>ParticipantObjectDataLifeCycle</i>	<i>U</i>	<i>not specialized</i>
	<i>ParticipantObjectTypeCode</i>	<i>M</i>	<i>EV(“urn:uuid:a54d6aa5-d40d-43f9-88c5-b4633d873bdd”, “IHE XDS Metadata”, “submission set classificationNode”)</i>
	<i>ParticipantObjectSensitivity</i>	<i>U</i>	<i>not specialized</i>
	<i>ParticipantObjectID</i>	<i>M</i>	<i>The submissionSet unique ID</i>
	<i>ParticipantObjectName</i>	<i>U</i>	<i>not specialized</i>
	<i>ParticipantObjectQuery</i>	<i>U</i>	<i>not specialized</i>
	<i>ParticipantObjectDetail</i>	<i>U</i>	<i>not specialized</i>

3.42.7.1.2 Document Registry audit message:

	Field Name	Opt	Value Constraints
Event <small>AuditMessage/ EventIdentification</small>	<i>EventID</i>	<i>M</i>	<i>EV(110107, DCM, “Import”)</i>
	<i>EventActionCode</i>	<i>M</i>	<i>“C” (Create)</i>
	<i>EventDateTime</i>	<i>M</i>	<i>not specialized</i>
	<i>EventOutcomeIndicator</i>	<i>M</i>	<i>not specialized</i>
	<i>EventTypeCode</i>	<i>M</i>	<i>EV(“ITI-42”, “IHE Transactions”, “Register Document Set-b”)</i>
Source (Document Repository or Integrated Document Source/Repository) (1)			
Destination (Document Registry) (1)			
Audit Source (Document Registry) (1)			
Patient (1)			
SubmissionSet (1)			

Where:

Source <small>AuditMessage/ ActiveParticipant</small>	<i>UserID</i>	<i>U</i>	<i>When WS-Addressing is used this should be the value of the <ReplyTo/> element.</i>
	<i>AlternativeUserID</i>	<i>U</i>	<i>not specialized</i>
	<i>UserName</i>	<i>U</i>	<i>not specialized</i>
	<i>UserIsRequestor</i>	<i>M</i>	<i>“true”</i>
	<i>RoleIDCode</i>	<i>M</i>	<i>EV(110153, DCM, “Source”)</i>
	<i>NetworkAccessPointTypeCode</i>	<i>M</i>	<i>“1” for machine (DNS) name, “2” for IP address</i>
	<i>NetworkAccessPointID</i>	<i>M</i>	<i>The machine name or IP address, as specified in RFC 3881.</i>

2720

Destination (AuditMessage/ ActiveParticipant)	UserID	M	SOAP endpoint URI
	AlternativeUserID	M	the process ID as used within the local operating system in the local system logs.
	UserName	U	not specialized
	UserIsRequestor	M	“false”
	RoleIDCode	M	EV(110152, DCM, “Destination”)
	NetworkAccessPointTypeCode	M	“1” for machine (DNS) name, “2” for IP address
	NetworkAccessPointID	M	The machine name or IP address, as specified in RFC 3881.

Audit Source (AuditMessage/ AuditSourceIdentification)	AuditSourceID	U	Not specialized.
	AuditEnterpriseSiteID	U	not specialized
	AuditSourceTypeCode	U	not specialized

Patient (AuditMessage/ ParticipantObjectIdentifi- cation)	ParticipantObjectTypeCode	M	“1” (person)
	ParticipantObjectTypeCodeRole	M	“1” (patient)
	ParticipantObjectDataLifeCycle	U	not specialized
	ParticipantObjectTypeCode	M	EV(2, RFC-3881, “Patient Number”)
	ParticipantObjectSensitivity	U	not specialized
	ParticipantObjectID	M	the patient ID in HL7 CX format.
	ParticipantObjectName	U	not specialized
	ParticipantObjectQuery	U	not specialized
	ParticipantObjectDetail	U	not specialized
Submission Set (AuditMessage/ ParticipantObjectIdentifi- cation)	ParticipantObjectTypeCode	M	“2” (System)
	ParticipantObjectTypeCodeRole	M	“20” (job)
	ParticipantObjectDataLifeCycle	U	not specialized
	ParticipantObjectTypeCode	M	EV(“urn:uuid:a54d6aa5-d40d-43f9-88c5-b4633d873bdd”, “IHE XDS Metadata”, “submission set classificationNode”)
	ParticipantObjectSensitivity	U	not specialized
	ParticipantObjectID	M	The submissionSet unique ID
	ParticipantObjectName	U	not specialized
	ParticipantObjectQuery	U	not specialized
	ParticipantObjectDetail	U	not specialized

3.43 Retrieve Document Set

This section corresponds to Transaction ITI-43 of the IHE Technical Framework. The Document Consumer, Document Repository actors use transaction ITI-43.

2725

Integration Profiles using this Transaction
Cross-Enterprise Document Sharing-b (XDS.b)

3.43.1 Scope

This transaction is used by the Document Consumer to retrieve a set of documents from the Document Repository. The Document Consumer has already obtained the XDSDocumentEntry

2730 uniqueId and the Document Repository repositoryUniqueId from the Document Registry by means of the Registry Stored Query transaction.

3.43.2 Use Case Roles

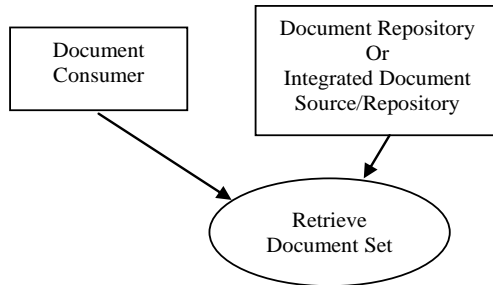

2735

XDS Actors:

Actor: Document Consumer

Role: Obtains document.

Actor: Document Repository or Integrated Document Source/Repository

Role: Provides documents.

2740

Note: Within this transaction, the Document Repository and Integrated Document Source/Repository actors can be used interchangeably.

3.43.3 Referenced Standard

2745 Implementors of this transaction shall comply with all requirements described in ITI TF-2x: Appendix V: Web Services for IHE Transactions.

ebRIM	OASIS/ebXML Registry Information Model v3.0
ebRS	OASIS/ebXML Registry Services Specifications v3.0
Appendix V	ITI TF-2x:Appendix V Web Services for IHE Transactions Contains references to all Web Services standards and requirements of use
MTOM	SOAP Message Transmission Optimization Mechanism http://www.w3.org/TR/soap12-mtom/
XOP	XML-binary Optimized Packaging http://www.w3.org/TR/2005/REC-xop10-20050125/

3.43.4 Interaction Diagram

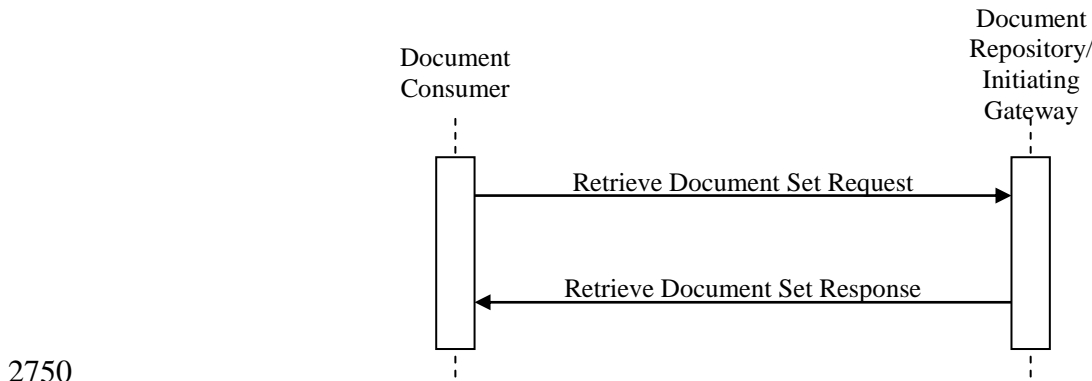

3.43.4.1 Retrieve Document Set Request

3.43.4.1.1 Trigger Events

2755 The Document Consumer obtains document(s) uniqueId via the Registry Stored Query transaction. If the Registry Stored Query was sent to the Initiating Gateway the Document Consumer shall address the Retrieve Document Set to the Initiating Gateway. In this case no resolution of repositoryUniqueId is needed by the Document Consumer. The Document Consumer shall specify the homeCommunityId element in the Retrieve Document Set transaction if it was found in the entry containing the uniqueId of the document being retrieved.

2760 For more information regarding the homeCommunityId see XCA supplement section 3.38.4.1.2. Once the document(s) uniqueId have been obtained, the Document Consumer will start the Retrieve Document Set Request with the Document Repository.

3.43.4.1.2 Message Semantics

2765 The Retrieve Document Set Request shall carry the following information:

- A required repositoryUniqueId that identifies the repository from which the document is to be retrieved. This value corresponds to XSDSDocumentEntry.repositoryUniqueId.
- A required documentUniqueId that identifies the document within the repository. This value corresponds to the XSDSDocumentEntry.uniqueId.
- If available, the homeCommunityId element that identifies the community holding the document. The homeCommunityId element shall be specified if the XSDSDocumentEntry containing the uniqueId of the document contains the homeCommunityId attribute. See ITI TF-2a: 3.18.4.1.2 for details.

2770

2775 The repositoryUniqueId associated to each document requested can be different therefore allowing a single request to identify multiple repositories.

3.43.4.1.3 Expected Actions

When receiving a Retrieve Document Set Request, a Document Repository or an Initiating Gateway shall generate a Retrieve Document Set Response containing the requested documents or error codes if the documents could not be retrieved.

2780 3.43.4.1.3.1 Basic Patient Privacy Enforcement Option

If the Basic Patient Privacy Enforcement Option is implemented:

- 2785 1. The Document Consumer actor shall abide by the XDS Affinity Domain Policies represented by the confidentialityCode in the metadata associated with the document. The Document Consumer actor likely will have user access controls or business rule capabilities to determine the details of how confidentiality codes apply to query results. The details of this are product specific and not specified by IHE. These rules shall reduce the query results to only those that are appropriate to the current situation for that actor and user.
- 2790 2. The Document Consumer actor shall be able to be configured with Patient Privacy Policies, Patient Privacy Policy Identifiers (OIDs) and associated information necessary to understand and enforce the XDS Affinity Domain Policy. The details of this are product specific and not specified by IHE.

3.43.4.2 Retrieve Document Set Response

3.43.4.2.1 Trigger Events

2795 This message will be triggered by a Retrieve Document Set Request Message

3.43.4.2.2 Message Semantics

The Retrieve Document Set Response Message shall carry the following information, for each of the returned documents:

- 2800 • A homeCommunityId. This value shall be the same as the homeCommunityId value in the Retrieve Document Set Request Message. If the homeCommunityId value is not present in the Retrieve Document Set Request Message, this shall not be present.
- 2805 • A required repositoryUniqueId that identifies the repository from which the document is to be retrieved. This value shall be the same as the value of the repositoryUniqueId in the original Retrieve Document Set Request Message. This value corresponds to XSDSDocumentEntry.repositoryUniqueId.
- A required documentUniqueId that identifies the document within the repository. This value shall be the same as the documentUniqueId in the original Retrieve Document Set Request Message. This value corresponds to the XSDSDocumentEntry.uniqueId.
- 2810 • The retrieved document as a XOP Infoset
- The MIME type of the retrieved document
- Errors or warnings in case the document(s) could not be retrieved successfully

3.43.4.2.3 Expected Actions

A Document Repository shall retrieve the document(s) indicated in the request.

- 2815 The Document Repository shall return the document or an error code in case the document could not be retrieved. The conditions of failure and possible error messages are given in the ebRS standard and detailed in ITI TF-3: 4.1.13 Error Reporting.

3.43.5 Protocol Requirements

- 2820 Implementors of this transaction shall comply with all requirements described in ITI TF-2x: Appendix V: Web Services for IHE Transactions.

The Retrieve Document Set transaction shall use SOAP12 and MTOM with XOP encoding (labeled MTOM/XOP in this specification). See ITI TF-2x: Appendix V for details. The Document Repository shall:

- Accept the Retrieve Document Set Request message in MTOM/XOP format.
- 2825 • Generate the Retrieve Document Set Response message in MTOM/XOP format

The Document Consumer shall:

- Generate the Retrieve Document Set Request message in MTOM/XOP format.
- Accept the Retrieve Document Set Response message in MTOM/XOP format.

2830

WSDL Namespace Definitions

ihe	urn:ihe:iti:xds-b:2007
rs	urn:oasis:names:tc:ebxml-regrep:xsd:rs:3.0
lcm	urn:oasis:names:tc:ebxml-regrep:xsd:lcm:3.0
query	urn:oasis:names:tc:ebxml-regrep:xsd:query:3.0

These are the requirements for the Retrieve Document Set transaction presented in the order in which they would appear in the WSDL definition:

- The following types shall be imported (xsd:import) in the /definitions/types section:
 - namespace="urn:ihe:iti:xds-b:2007", schema="IHEXDS.xsd"
- 2835 • The /definitions/message/part/@element attribute of the Retrieve Document Set Request message shall be defined as "ihe:RetrieveDocumentSetRequest"
- The /definitions/message/part/@element attribute of the Retrieve Document Set Response message shall be defined as "ihe:RetrieveDocumentSetResponse"
- 2840 • The /definitions/portType/operation/input/@wsaw:Action attribute for the Retrieve Document Set Request message shall be defined as "urn:ihe:iti:2007:RetrieveDocumentSet"
- The /definitions/portType/operation/output/@wsaw:Action attribute for the Retrieve Document Set Response message shall be defined as "urn:ihe:iti:2007:RetrieveDocumentSetResponse"
- 2845 • The /definitions/binding/operation/soap12:operation/@soapAction attribute shall be defined as "urn:ihe:iti:2007:RetrieveDocumentSet"

These are the requirements that affect the wire format of the SOAP message. The other WSDL properties are only used within the WSDL definition and do not affect interoperability. Full sample request and response messages are in ITI TF-2b: 3.43.5.1 Sample SOAP Messages.

2850 For informative WSDL for the Document Repository actor see in Appendix W.

The <ihe:RetrieveDocumentSetRequest/> element is defined as:

- One or more <ihe:DocumentRequest/> elements, each one representing an individual document that the Document Consumer wants to retrieve from the Document Repository. Each <ihe:DocumentRequest/> element contains:
 - 2855 • A required <ihe:RepositoryUniqueId/> element that identifies the repository from which the document is to be retrieved. This value corresponds to XSDDocumentEntry.repositoryUniqueId.
 - A required <ihe:DocumentUniqueId/> that identifies the document within the repository. This value corresponds to the XSDDocumentEntry.uniqueId.
 - 2860 • An optional <ihe:HomeCommunityId/> element that corresponds to the home attribute of the Identifiable class in ebRIM.

This allows the Document Consumer to specify one or more documents to retrieve from the Document Repository.

The <ihe:RetrieveDocumentResponse/> element is defined as:

- 2865 • A required /ihe:RetrieveDocumentSetResponse/rs:RegistryResponse element
- An optional sequence of <ihe:DocumentResponse/> elements containing
 - A <ihe:HomeCommunityId/> element. The value of this element shall be the same as the value of the /RetrieveDocumentSetRequest/DocumentRequest/HomeCommunityId element in the Retrieve Document Set Request Message. If the <ihe:HomeCommunityId/> element is not present in the Retrieve Document Set Request Message, this value shall not be present.
 - 2870 • A required <ihe:RepositoryUniqueId/> that identifies the repository from which the document is to be retrieved. The value of this element shall be the same as the value of the /RetrieveDocumentSetRequest/DocumentRequest/RepositoryUniqueId element in the original Retrieve Document Set Request Message. This value corresponds to XSDDocumentEntry.repositoryUniqueId.
 - 2875 • A required <ihe:DocumentUniqueId/> that identifies the document within the repository. The value of this element shall be the same as the value of the /RetrieveDocumentSetRequest/DocumentRequest/DocumentUniqueId element in the original Retrieve Document Set Request Message. This value corresponds to XSDDocumentEntry.uniqueId.
 - 2880 • A required <ihe:Document/> element that contains the retrieved document in base64binary encoded format
 - 2885 • A required <ihe:mimeType/> element that indicates the MIME type of the retrieved document

The `/RetrieveDocumentSetResponse/rs:RegistryResponse/@status` attributes provides the overall status of the request: It shall contain one of the following values:

- 2890 `urn:oasis:names:tc:ebxml-regrep:ResponseStatusType:Success`
 `urn:ihe:iti:2007:ResponseStatusType:PartialSuccess`
 `urn:oasis:names:tc:ebxml-regrep:ResponseStatusType:Failure`

See ITI TF-3: 4.1.13 Error Reporting for the interpretation of these values.

For each document requested in a `/RetrieveDocumentSetRequest/DocumentRequest` element:

- 2895 • If a warning is reported when retrieving the document, then a `/RetrieveDocumentSetResponse/rs:RegistryResponse/rs:RegistryErrorList/rs:RegistryError` element shall be returned with:
- `@severity` is `urn:oasis:names:tc:ebxml-regrep:ErrorSeverityType:Warning`
 - `@errorCode` is specified
- 2900 • `@codeContext` contains the warning message
- `@location` contains the `DocumentUniqueId` of the document requested
- The document shall be returned in an instance of `/RetrieveDocumentSetResponse/DocumentResponse/Document` as a XOP Infoset. The returned document and warning are correlated via the `DocumentUniqueId`.
- 2905 • If an error is reported when retrieving a document, then a `/RetrieveDocumentSetResponse/rs:RegistryResponse/rs:RegistryErrorList/rs:RegistryError` element shall be returned with:
- `@severity` is `urn:oasis:names:tc:ebxml-regrep:ErrorSeverityType:Error`
 - `@errorCode` is specified
- 2910 • `@codeContext` contains the error message
- `@location` contains the `DocumentUniqueId` of the document requested
- No corresponding `RetrieveDocumentSetResponse/DocumentResponse` element shall be returned
- 2915 • If the document is successfully retrieved (without warning) then no `/RetrieveDocumentSetResponse/rs:RegistryResponse/rs:RegistryErrorList/rs:RegistryError` element shall be present and a `/RetrieveDocumentSetResponse/DocumentResponse/Document` element shall be returned containing the document as a XOP Infoset.

2920 The `/RetrieveDocumentSetResponse/rs:RegistryResponse/rs:ResponseSlotList` element is not used in this transaction.

The `/RetrieveDocumentSetResponse/rs:RegistryResponse/@requestId` attribute is not used in this transaction.

A full XML Schema Document for the XDS.b types is available online on the IHE FTP site, see ITI TF-2x: Appendix W.

2925 **3.43.5.1 Sample SOAP Messages**

The samples in the following two sections show a typical SOAP request and its relative SOAP response. The sample messages also show the WS-Addressing headers <Action/>, <MessageID/>, <ReplyTo/>...; these WS-Addressing headers are populated according to ITI TF-2x: Appendix V: Web Services for IHE Transactions. The body of the SOAP message is omitted for brevity; in a real scenario the empty element will be populated with the appropriate metadata.

2930

Samples presented in this section are also available online on the IHE FTP site, see ITI TF-2x: Appendix W.

2935 **3.43.5.1.1 Sample Retrieve Document Set SOAP Request**

2935

```
POST /tf6/services/xdsrepositoryb HTTP/1.1
Content-Type: multipart/related; boundary=MIMEBoundaryurn_uuid_DCD262C64C22DB97351256303951323;
type="application/xop+xml"; start="<0.urn:uuid:DCD262C64C22DB97351256303951324@apache.org>";
start-info="application/soap+xml"; action="urn:ihe:iti:2007:RetrieveDocumentSet"
User-Agent: Axis2
Host: localhost:5000
```

2940

```
--MIMEBoundaryurn_uuid_DCD262C64C22DB97351256303951323
Content-Type: application/xop+xml; charset=UTF-8; type="application/soap+xml"
Content-Transfer-Encoding: binary
Content-ID: <0.urn:uuid:DCD262C64C22DB97351256303951324@apache.org>
```

2945

```
<?xml version='1.0' encoding='UTF-8'?>
<soapenv:Envelope xmlns:soapenv="http://www.w3.org/2003/05/soap-envelope"
  xmlns:wsa="http://www.w3.org/2005/08/addressing">
  <soapenv:Header>
    <wsa:To>http://localhost:5000/tf6/services/xdsrepositoryb</wsa:To>
    <wsa:MessageID>urn:uuid:DCD262C64C22DB97351256303951276</wsa:MessageID>
    <wsa:Action>urn:ihe:iti:2007:RetrieveDocumentSet</wsa:Action>
  </soapenv:Header>
  <soapenv:Body>
    <RetrieveDocumentSetRequest xmlns="urn:ihe:iti:xds-b:2007"
      xmlns:xsi="http://www.w3.org/2001/XMLSchema-instance">
      <DocumentRequest>
        <RepositoryUniqueId>1.19.6.24.109.42.1.5</RepositoryUniqueId>
        <DocumentUniqueId>2009.9.1.1573</DocumentUniqueId>
      </DocumentRequest>
    </RetrieveDocumentSetRequest>
  </soapenv:Body>
</soapenv:Envelope>
```

2950

2955

2960

2965

```
--MIMEBoundaryurn_uuid_DCD262C64C22DB97351256303951323--
```

2970 **3.43.5.1.2 Sample Retrieve Document Set SOAP Response**

2970

```
HTTP/1.1 200 OK
Server: Apache-Coyote/1.1
Content-Type: multipart/related; boundary=MIMEBoundaryurn_uuid_F862C3E04D9E35266C1256303956115;
type="application/xop+xml"; start="0.urn:uuid:F862C3E04D9E35266C1256303956116@apache.org"; start-
info="application/soap+xml"; action="urn:ihe:iti:2007:RetrieveDocumentSetResponse"
Date: Fri, 23 Oct 2009 13:19:11 GMT
```

2975

```
--MIMEBoundaryurn_uuid_F862C3E04D9E35266C1256303956115
Content-Type: application/xop+xml; charset=UTF-8; type="application/soap+xml"
Content-Transfer-Encoding: binary
Content-ID: <0.urn:uuid:F862C3E04D9E35266C1256303956116@apache.org>
```

2980

```
<?xml version='1.0' encoding='UTF-8'?>
<soapenv:Envelope xmlns:soapenv="http://www.w3.org/2003/05/soap-envelope"
  xmlns:wsa="http://www.w3.org/2005/08/addressing">
```

```

2985 <soapenv:Header>
      <wsa:Action>urn:ihe:iti:2007:RetrieveDocumentSetResponse</wsa:Action>
      <wsa:RelatesTo>urn:uuid:DCD262C64C22DB97351256303951276</wsa:RelatesTo>
    </soapenv:Header>
2990 <soapenv:Body>
      <xdsb:RetrieveDocumentSetResponse xmlns:xdsb="urn:ihe:iti:xds-b:2007">
        <rs:RegistryResponse xmlns:rs="urn:oasis:names:tc:ebxml-regrep:xsd:rs:3.0"
          status="urn:oasis:names:tc:ebxml-regrep:ResponseStatusType:Success"/>
        <xdsb:DocumentResponse>
          <xdsb:RepositoryUniqueId>1.19.6.24.109.42.1.5</xdsb:RepositoryUniqueId>
          <xdsb:DocumentUniqueId>2009.9.1.1573</xdsb:DocumentUniqueId>
          <xdsb:mimeType>application/pdf</xdsb:mimeType>
          <xdsb:Document>
            <xop:Include href="cid:1.urn:uuid:F862C3E04D9E35266C1256303956117@apache.org"
              xmlns:xop="http://www.w3.org/2004/08/xop/include"/>
3000 </xdsb:Document>
          </xdsb:DocumentResponse>
        </xdsb:RetrieveDocumentSetResponse>
      </soapenv:Body>
    </soapenv:Envelope>
3005
--MIMEBoundaryurn_uuid_F862C3E04D9E35266C1256303956115
Content-Type: application/octet-stream
Content-Transfer-Encoding: binary
Content-ID: <1.urn:uuid:F862C3E04D9E35266C1256303956117@apache.org>
3010
This is the content of the document.
--MIMEBoundaryurn_uuid_F862C3E04D9E35266C1256303956115--

```

3.43.6 Security Considerations

3015 Relevant XDS Affinity Domain Security background is discussed in the XDS Security Considerations Section (see ITI TF-1: 10.7).

3.43.6.1 Audit Record Considerations

3020 The Retrieve Document Set Transaction is PHI-Export event, as defined in ITI TF-2a: Table 3.20.6-1. The Actors involved in the transaction shall create audit data in conformance with DICOM (Supp 95) “Data Export”/“Data Import”, with the following exceptions.

3025 The Repository Actor shall generate an “Export” event. This may be an event for each Retrieve Document Transaction, or multiple transactions for the same patient may be heuristically combined. The heuristics for this combination are not specified by IHE. It is intended to reduce the volume of audit records. Combination is permitted when the active participants and patient are the same, and the time difference is considered insignificant.

The Document Consumer Actor shall generate an “Import” event. This may be one event per transaction, or multiple transactions may be reported as a single event using a heuristic for combining transactions. Combination is permitted when the active participants and patient are the same, and the time difference is considered insignificant.

3030 3.43.6.1.1 Document Consumer audit message:

	Field Name	Opt	Value Constraints
Event	EventID	M	EV(110107, DCM, “Import”)

IHE IT Infrastructure Technical Framework, Volume 2b (ITI TF-2b): Transactions Part B

	EventActionCode	M	“C” (Create)
	EventDateTime	M	not specialized
	EventOutcomeIndicator	M	not specialized
	EventTypeCode	M	EV(“ITI-43”, “IHE Transactions”, “Retrieve Document Set”)
Source (Document Repository) (1)			
Destination (Document Consumer) (1)			
Human Requestor (0..n)			
Audit Source (Document Consumer) (1)			
Patient (0..1)			
Document (1..n) (<i>see combining rules above</i>)			

Where:

Source AuditMessage/ ActiveParticipant	UserID	M	SOAP endpoint URI
	AlternativeUserID	U	not specialized
	UserName	U	not specialized
	UserIsRequestor	M	“false”
	RoleIDCode	M	EV(110153, DCM, “Source”)
	NetworkAccessPointTypeCode	M	“1” for machine (DNS) name, “2” for IP address
	NetworkAccessPointID	M	The machine name or IP address, as specified in RFC 3881.

Destination AuditMessage/ ActiveParticipant	UserID	M	The content of the <wsa:ReplyTo/> element.
	AlternativeUserID	M	the process ID as used within the local operating system in the local system logs.
	UserName	U	not specialized
	UserIsRequestor	M	“true”
	RoleIDCode	M	EV(110152, DCM, “Destination”)
	NetworkAccessPointTypeCode	M	“1” for machine (DNS) name, “2” for IP address
	NetworkAccessPointID	M	The machine name or IP address, as specified in RFC 3881.
Human Requestor (if known) AuditMessage/ ActiveParticipant	UserID	M	Identity of the human that initiated the transaction.
	AlternativeUserID	U	not specialized
	UserName	U	not specialized
	UserIsRequestor	M	“true”
	RoleIDCode	U	Access Control role(s) the user holds that allows this transaction.
	NetworkAccessPointTypeCode	NA	
	NetworkAccessPointID	NA	

Audit Source AuditMessage/ AuditSourceIdentification	AuditSourceID	U	Not specialized.
	AuditEnterpriseSiteID	U	not specialized
	AuditSourceTypeCode	U	not specialized

3035

Patient	ParticipantObjectTypeCode	M	“1” (Person)
----------------	---------------------------	---	--------------

	ParticipantObjectTypeCodeRole	M	“1” (Patient)
	<i>ParticipantObjectDataLifeCycle</i>	<i>U</i>	<i>not specialized</i>
	ParticipantObjectIDTypeCode	M	EV(2, RFC-3881, “Patient Number”)
	<i>ParticipantObjectSensitivity</i>	<i>U</i>	<i>not specialized</i>
	ParticipantObjectID	M	The patient ID in HL7 CX format.
	<i>ParticipantObjectName</i>	<i>U</i>	<i>not specialized</i>
	<i>ParticipantObjectQuery</i>	<i>U</i>	<i>not specialized</i>
	<i>ParticipantObjectDetail</i>	<i>U</i>	<i>not specialized</i>
Document (AuditMessage/ ParticipantObjectIdentification)	ParticipantObjectTypeCode	M	“2” (System)
	ParticipantObjectTypeCodeRole	M	“3” (report)
	<i>ParticipantObjectDataLifeCycle</i>	<i>U</i>	<i>not specialized</i>
	ParticipantObjectIDTypeCode	M	EV(9, RFC-3881, “Report Number”)
	<i>ParticipantObjectSensitivity</i>	<i>U</i>	<i>not specialized</i>
	ParticipantObjectID	M	The value of <ihe:DocumentUniqueId/>
	<i>ParticipantObjectName</i>	<i>C</i>	<i>not specialized</i>
	<i>ParticipantObjectQuery</i>	<i>U</i>	<i>not specialized</i>
	<i>ParticipantObjectDetail</i>	<i>M</i>	The ParticipantObjectDetail element may occur more than once. In one element, the value of <ihe:RepositoryUniqueId/> in value attribute, “Repository Unique Id” in type attribute In another element, the value of “ihe:homeCommunityID” as the value of the attribute <i>type</i> and the value of the homeCommunityID as the value of the attribute <i>value</i>

3.43.6.1.2 Document Repository audit message:

	Field Name	Opt	Value Constraints
Event AuditMessage/ EventIdentification	EventID	M	EV(110106, DCM, “Export”)
	EventActionCode	M	“R” (Read)
	<i>EventDateTime</i>	<i>M</i>	<i>not specialized</i>
	<i>EventOutcomeIndicator</i>	<i>M</i>	<i>not specialized</i>
	EventTypeCode	M	EV(“ITI-43”, “IHE Transactions”, “Retrieve Document Set”)
Source (Document Repository) (1)			
Destination (Document Consumer) (1)			
Audit Source (Document Repository) (1)			
Document (1..n) (<i>see combining rules above</i>)			

Where:

Source AuditMessage/ ActiveParticipant	UserID	M	SOAP endpoint URI
	AlternativeUserID	M	the process ID as used within the local operating system in the local system logs.
	<i>UserName</i>	<i>U</i>	<i>not specialized</i>
	UserIsRequestor	M	“false”
	RoleIDCode	M	EV(110153, DCM, “Source”)
	NetworkAccessPointTypeCode	M	“1” for machine (DNS) name, “2” for IP address
	NetworkAccessPointID	M	The machine name or IP address, as specified in RFC 3881.

Destination	UserID	M	The content of the <wsa:ReplyTo/> element.
--------------------	--------	---	--

IHE IT Infrastructure Technical Framework, Volume 2b (ITI TF-2b): Transactions Part B

	<i>AlternativeUserID</i>	<i>U</i>	<i>not specialized</i>
	<i>UserName</i>	<i>U</i>	<i>not specialized</i>
	UserIsRequestor	<i>M</i>	"true"
	RoleIDCode	<i>M</i>	EV(110152, DCM, "Destination")
	NetworkAccessPointTypeCode	<i>M</i>	"1" for machine (DNS) name, "2" for IP address
	NetworkAccessPointID	<i>M</i>	The machine name or IP address, as specified in RFC 3881.

Audit Source <i>AuditMessage/</i> <i>AuditSourceIdentification</i>	<i>AuditSourceID</i>	<i>U</i>	<i>Not specialized.</i>
	<i>AuditEnterpriseSiteID</i>	<i>U</i>	<i>not specialized</i>
	<i>AuditSourceTypeCode</i>	<i>U</i>	<i>not specialized</i>

3040

Document URI <i>(AuditMessage/</i> <i>ParticipantObjectIdentification)</i>	ParticipantObjectTypeCode	<i>M</i>	"2" (System)
	ParticipantObjectTypeCodeRole	<i>M</i>	"3" (report)
	<i>ParticipantObjectDataLifeCycle</i>	<i>U</i>	<i>not specialized</i>
	ParticipantObjectIDTypeCode	<i>M</i>	EV(9, RFC-3881, "Report Number")
	<i>ParticipantObjectSensitivity</i>	<i>U</i>	<i>not specialized</i>
	ParticipantObjectID	<i>M</i>	The value of <ihe:DocumentUniqueId/>
	<i>ParticipantObjectName</i>	<i>C</i>	<i>not specialized</i>
	<i>ParticipantObjectQuery</i>	<i>U</i>	<i>not specialized</i>
	<i>ParticipantObjectDetail</i>	<i>M</i>	The ParticipantObjectDetail element may occur more than once. In one element, the value of <ihe:RepositoryUniqueId/> in value attribute, "Repository Unique Id" in type attribute In another element, the value of "ihe:homeCommunityID" as the value of the attribute <i>type</i> and the value of the homeCommunityID as the value of the attribute <i>value</i>